

INSTRUCTION MANUAL

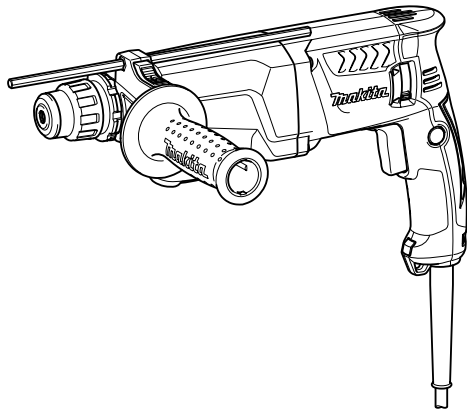

# Rotary Hammer / Combination Hammer

HR2300  
HR2310T  
HR2600  
HR2601  
HR2610  
HR2610T  
HR2611F  
HR2611FT



010712

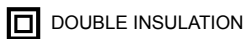

DOUBLE INSULATION

**IMPORTANT:** Read Before Using.

## ENGLISH (Original instructions)

# SPECIFICATIONS

Model		HR2300	HR2310T	HR2600	HR2601	HR2610	HR2610T	HR2611F	HR2611FT
Capacities	Concrete	23 mm			26 mm				
	Core bit	68 mm			68 mm		68 mm		
	Diamond core bit (dry type)	70 mm			80 mm		80 mm		
	Steel	13 mm			13 mm		13 mm		
	Wood	32 mm			32 mm		32 mm		
No load speed (min <sup>-1</sup> )		0 - 1,200							
Blows per minute		0 - 4,600							
Overall length		356 mm	380 mm	361 mm			385 mm	361 mm	385 mm
Net weight		2.7 kg	2.9 kg	2.8 kg	2.9 kg	2.8 kg	2.9 kg	2.9 kg	3.0 kg
Safety class		II/III							

- Due to our continuing programme of research and development, the specifications herein are subject to change without notice.
- Specifications may differ from country to country.
- Weight according to EPTA-Procedure 01/2003

END201-5

GEA005-3

## Symbols

The following show the symbols used for the equipment. Be sure that you understand their meaning before use.



- Read instruction manual.



- DOUBLE INSULATION



- Only for EU countries  
Do not dispose of electric equipment together with household waste material! In observance of European Directive 2002/96/EC on waste electric and electronic equipment and its implementation in accordance with national law, electric equipment that have reached the end of their life must be collected separately and returned to an environmentally compatible recycling facility.

ENE042-1

## Intended use

The tool is intended for hammer drilling and drilling in brick, concrete and stone.

It is also suitable for drilling without impact in wood, metal, ceramic and plastic.

ENF002-2

## Power supply

The tool should be connected only to a power supply of the same voltage as indicated on the nameplate, and can only be operated on single-phase AC supply. They are double-insulated and can, therefore, also be used from sockets without earth wire.

## General Power Tool Safety

### Warnings

**⚠ WARNING Read all safety warnings and all instructions.** Failure to follow the warnings and instructions may result in electric shock, fire and/or serious injury.

### Save all warnings and instructions for future reference.

The term "power tool" in the warnings refers to your mains-operated (corded) power tool or battery-operated (cordless) power tool.

#### Work area safety

1. **Keep work area clean and well lit.** Cluttered or dark areas invite accidents.
2. **Do not operate power tools in explosive atmospheres, such as in the presence of flammable liquids, gases or dust.** Power tools create sparks which may ignite the dust or fumes.
3. **Keep children and bystanders away while operating a power tool.** Distractions can cause you to lose control.

#### Electrical safety

4. **Power tool plugs must match the outlet. Never modify the plug in any way. Do not use any adapter plugs with earthed (grounded) power tools.** Unmodified plugs and matching outlets will reduce risk of electric shock.
5. **Avoid body contact with earthed or grounded surfaces such as pipes, radiators, ranges and refrigerators.** There is an increased risk of electric shock if your body is earthed or grounded.

6. **Do not expose power tools to rain or wet conditions.** Water entering a power tool will increase the risk of electric shock.
7. **Do not abuse the cord. Never use the cord for carrying, pulling or unplugging the power tool. Keep cord away from heat, oil, sharp edges or moving parts.** Damaged or entangled cords increase the risk of electric shock.
8. **When operating a power tool outdoors, use an extension cord suitable for outdoor use.** Use of a cord suitable for outdoor use reduces the risk of electric shock.
9. **If operating a power tool in a damp location is unavoidable, use a residual current device (RCD) protected supply.** Use of an RCD reduces the risk of electric shock.
10. **Use of power supply via a RCD with a rated residual current of 30mA or less is always recommended.**

#### Personal safety

11. **Stay alert, watch what you are doing and use common sense when operating a power tool. Do not use a power tool while you are tired or under the influence of drugs, alcohol or medication.** A moment of inattention while operating power tools may result in serious personal injury.
12. **Use personal protective equipment. Always wear eye protection.** Protective equipment such as dust mask, non-skid safety shoes, hard hat, or hearing protection used for appropriate conditions will reduce personal injuries.
13. **Prevent unintentional starting. Ensure the switch is in the off-position before connecting to power source and/or battery pack, picking up or carrying the tool.** Carrying power tools with your finger on the switch or energising power tools that have the switch on invites accidents.
14. **Remove any adjusting key or wrench before turning the power tool on.** A wrench or a key left attached to a rotating part of the power tool may result in personal injury.
15. **Do not overreach. Keep proper footing and balance at all times.** This enables better control of the power tool in unexpected situations.
16. **Dress properly. Do not wear loose clothing or jewellery. Keep your hair, clothing, and gloves away from moving parts.** Loose clothes, jewellery or long hair can be caught in moving parts.
17. **If devices are provided for the connection of dust extraction and collection facilities, ensure these are connected and properly used.** Use of dust collection can reduce dust-related hazards.

#### Power tool use and care

18. **Do not force the power tool. Use the correct power tool for your application.** The correct power tool will do the job better and safer at the rate for which it was designed.
19. **Do not use the power tool if the switch does not turn it on and off.** Any power tool that cannot be controlled with the switch is dangerous and must be repaired.
20. **Disconnect the plug from the power source and/or the battery pack from the power tool before making any adjustments, changing accessories, or storing power tools.** Such preventive safety measures reduce the risk of starting the power tool accidentally.
21. **Store idle power tools out of the reach of children and do not allow persons unfamiliar with the power tool or these instructions to operate the power tool.** Power tools are dangerous in the hands of untrained users.
22. **Maintain power tools. Check for misalignment or binding of moving parts, breakage of parts and any other condition that may affect the power tool's operation. If damaged, have the power tool repaired before use.** Many accidents are caused by poorly maintained power tools.
23. **Keep cutting tools sharp and clean.** Properly maintained cutting tools with sharp cutting edges are less likely to bind and are easier to control.
24. **Use the power tool, accessories and tool bits etc. in accordance with these instructions, taking into account the working conditions and the work to be performed.** Use of the power tool for operations different from those intended could result in a hazardous situation.

#### Service

25. **Have your power tool serviced by a qualified repair person using only identical replacement parts.** This will ensure that the safety of the power tool is maintained.
26. **Follow instruction for lubricating and changing accessories.**
27. **Keep handles dry, clean and free from oil and grease.**

GEB007-7

## ROTARY HAMMER SAFETY WARNINGS

1. **Wear ear protectors.** Exposure to noise can cause hearing loss.
2. **Use auxiliary handle(s), if supplied with the tool.** Loss of control can cause personal injury.
3. **Hold power tool by insulated gripping surfaces, when performing an operation where the cutting accessory may contact hidden**

wiring or its own cord. Cutting accessory contacting a "live" wire may make exposed metal parts of the power tool "live" and could give the operator an electric shock.

4. **Wear a hard hat (safety helmet), safety glasses and/or face shield. Ordinary eye or sun glasses are NOT safety glasses. It is also highly recommended that you wear a dust mask and thickly padded gloves.**
5. **Be sure the bit is secured in place before operation.**
6. **Under normal operation, the tool is designed to produce vibration. The screws can come loose easily, causing a breakdown or accident. Check tightness of screws carefully before operation.**
7. **In cold weather or when the tool has not been used for a long time, let the tool warm up for a while by operating it under no load. This will loosen up the lubrication. Without proper warm-up, hammering operation is difficult.**
8. **Always be sure you have a firm footing. Be sure no one is below when using the tool in high locations.**
9. **Hold the tool firmly with both hands.**
10. **Keep hands away from moving parts.**
11. **Do not leave the tool running. Operate the tool only when hand-held.**
12. **Do not point the tool at any one in the area when operating. The bit could fly out and injure someone seriously.**
13. **Do not touch the bit or parts close to the bit immediately after operation; they may be extremely hot and could burn your skin.**
14. **Some material contains chemicals which may be toxic. Take caution to prevent dust inhalation and skin contact. Follow material supplier safety data.**

## SAVE THESE INSTRUCTIONS.

### **⚠WARNING:**

**DO NOT** let comfort or familiarity with product (gained from repeated use) replace strict adherence to safety rules for the subject product. **MISUSE** or failure to follow the safety rules stated in this instruction manual may cause serious personal injury.

## FUNCTIONAL DESCRIPTION

### **⚠CAUTION:**

- Always be sure that the tool is switched off and unplugged before adjusting or checking function on the tool.

### Switch action

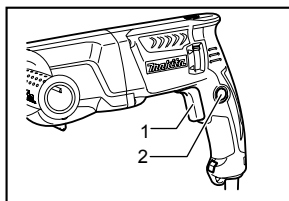

1. Switch trigger
2. Lock button

010720

### **⚠CAUTION:**

- Before plugging in the tool, always check to see that the switch trigger actuates properly and returns to the "OFF" position when released.

To start the tool, simply pull the switch trigger. Tool speed is increased by increasing pressure on the switch trigger. Release the switch trigger to stop. For continuous operation, pull the switch trigger, push in the lock button and then release the switch trigger. To stop the tool from the locked position, pull the switch trigger fully, then release it.

### Lighting up the lamps

#### For Models HR2611F, HR2611FT

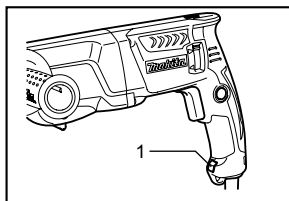

1. Lamp

010721

### **⚠CAUTION:**

- Do not look in the light or see the source of light directly.

To turn on the lamp, pull the trigger. Release the trigger to turn it off.

### NOTE:

- Use a dry cloth to wipe the dirt off the lens of lamp. Be careful not to scratch the lens of lamp, or it may lower the illumination.
- Do not use thinner or gasoline to clean the lamp. Such solvents may damage it.

## Reversing switch action

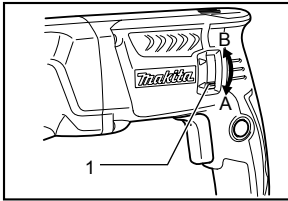

010722

1. Reversing switch lever

### ⚠CAUTION:

- Always check the direction of rotation before operation.
- Use the reversing switch only after the tool comes to a complete stop. Changing the direction of rotation before the tool stops may damage the tool.
- If the switch trigger can not be depressed, check to see that the reversing switch is fully set to position ◀ (A side) or ▶ (B side).

This tool has a reversing switch to change the direction of rotation. Move the reversing switch lever to the ◀ position (A side) for clockwise rotation or the ▶ position (B side) for counterclockwise rotation.

## Changing the quick change chuck for SDS-plus

For Models HR2310T, HR2610T, HR2611FT

The quick change chuck for SDS-plus can be easily exchanged for the quick change drill chuck.

### Removing the quick change chuck for SDS-plus

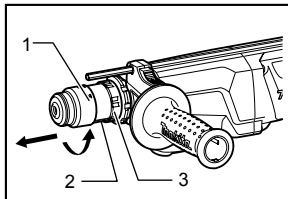

011561

1. Quick change chuck for SDS-plus
2. Change cover line
3. Change cover

### ⚠CAUTION:

- Before removing the quick change chuck for SDS-plus, always remove the bit.

Grasp the change cover of the quick change chuck for SDS-plus and turn in the direction of the arrow until the change cover line moves from the ⚙ symbol to the ⚙ symbol. Pull forcefully in the direction of the arrow.

## Attaching the quick change drill chuck

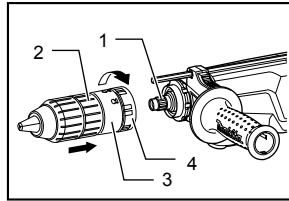

011562

1. Spindle
2. Quick change drill chuck
3. Change cover line
4. Change cover

Check the line of the quick change drill chuck shows the ⚙ symbol. Grasp the change cover of the quick change drill chuck and set the line to the ⚙ symbol.

Place the quick change drill chuck on the spindle of the tool.

Grasp the change cover of the quick change drill chuck and turn the change cover line to the ⚙ symbol until a click can clearly be heard.

## Selecting the action mode

For Models HR2300, HR2600, HR2601

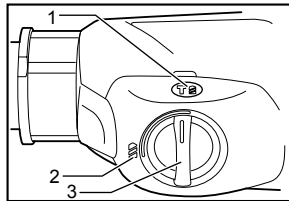

1. Rotation with hammering
2. Rotation only
3. Action mode changing knob

010723

This tool employs an action mode changing knob. Select one of the two modes suitable for your work needs by using this knob.

For rotation only, turn the knob so that the arrow on the knob points toward the ⚙ symbol on the tool body.

For rotation with hammering, turn the knob so that the arrow on the knob points toward the ⚙ symbol on the tool body.

### ⚠CAUTION:

- Always set the knob fully to your desired mode symbol. If you operate the tool with the knob positioned halfway between the mode symbols, the tool may be damaged.
- Use the knob after the tool comes to a complete stop.

**For Models HR2310T, HR2610, HR2610T, HR2611F, HR2611FT**

**Rotation with hammering**

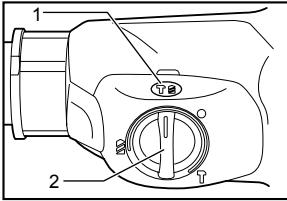

1. Rotation with hammering
2. Action mode changing knob

010724

For drilling in concrete, masonry, etc., rotate the action mode changing knob to the symbol. Use a tungsten-carbide tipped bit.

**Rotation only**

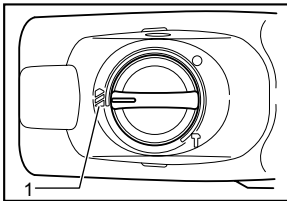

1. Rotation only

010726

For drilling in wood, metal or plastic materials, rotate the action mode changing knob to the symbol. Use a twist drill bit or wood bit.

**Hammering only**

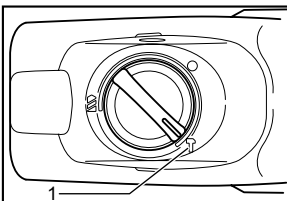

1. Hammering only

010725

For chipping, scaling or demolition operations, rotate the action mode changing knob to the symbol. Use a ball point, cold chisel, scaling chisel, etc.

**CAUTION:**

- Do not rotate the action mode changing knob when the tool is running under load. The tool will be damaged.
- To avoid rapid wear on the mode change mechanism, be sure that the action mode changing knob is always positively located in one of the three action mode positions.
- When changing from the symbol mode to the symbol mode, the action mode changing knob

may no longer move in the symbol position. At this time, turn the tool on or turn the chuck by hand in the symbol position and then rotate the action mode changing knob. Forcing the action mode changing knob may cause tool damage.

**Torque limiter**

The torque limiter will actuate when a certain torque level is reached. The motor will disengage from the output shaft. When this happens, the bit will stop turning.

**CAUTION:**

- As soon as the torque limiter actuates, switch off the tool immediately. This will help prevent premature wear of the tool.
- Bits such as hole saw, which tend to pinch or catch easily in the hole, are not appropriate for this tool. This is because they will cause the torque limiter to actuate too frequently.

**ASSEMBLY**

**CAUTION:**

- Always be sure that the tool is switched off and unplugged before carrying out any work on the tool.

**Side grip (auxiliary handle)**

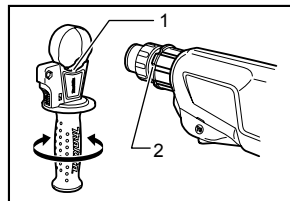

1. Protrusions
2. Grooves

010713

**CAUTION:**

- Always use the side grip to ensure operating safety. Install the side grip so that the protrusions on the grip fit in between the grooves on the tool barrel. Then tighten the grip by turning clockwise at the desired position. It may be swung 360° so as to be secured at any position.

**Bit grease**

Coat the bit shank head beforehand with a small amount of bit grease (about 0.5 - 1 g).

This chuck lubrication assures smooth action and longer service life.

## Installing or removing the bit

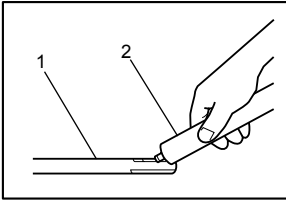

1. Bit shank
2. Bit grease

003150

Clean the bit shank and apply bit grease before installing the bit.

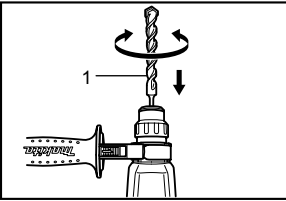

1. Bit

010714

Insert the bit into the tool. Turn the bit and push it in until it engages.

After installing, always make sure that the bit is securely held in place by trying to pull it out.

To remove the bit, pull the chuck cover down all the way and pull the bit out.

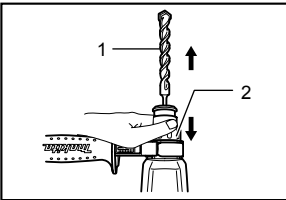

1. Bit
2. Chuck cover

010715

## Bit angle (when chipping, scaling or demolishing)

For Models HR2310T, HR2610, HR2610T, HR2611F, HR2611FT

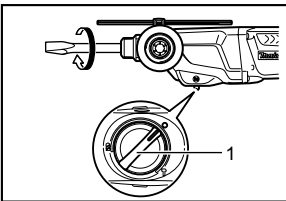

1. Action mode changing knob

010727

The bit can be secured at the desired angle. To change the bit angle, rotate the action mode changing knob to the **O** symbol. Turn the bit to the desired angle.

Rotate the action mode changing knob to the **T** symbol. Then make sure that the bit is securely held in place by turning it slightly.

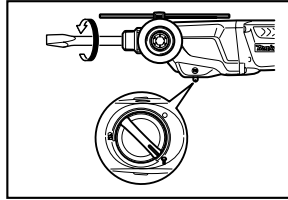

010728

## Depth gauge

The depth gauge is convenient for drilling holes of uniform depth.

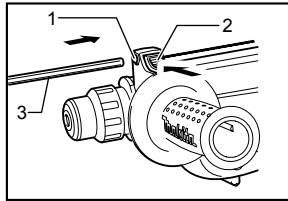

1. Grip base
2. Lock button
3. Depth gauge

010716

Press the lock button on the grip base in the direction of arrow shown in the figure and with the lock button being pressed insert the depth gauge into the hex. hole in the grip base

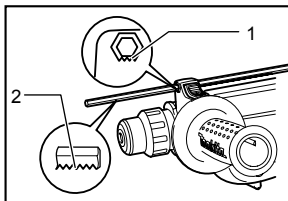

1. Toothed side of hex hole marking on the grip base
2. Toothed side of the depth gauge

010717

At this time, the depth gauge needs to be inserted so that its toothed side is directed to the toothed side of hex hole marking on the grip base as shown in the figure.

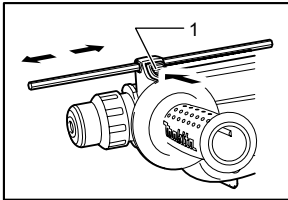

1. Lock button

010718

Adjust the depth gauge to the desired depth by moving it back and forth while pressing the lock button. After the adjustment, release the lock button to lock the depth gauge.

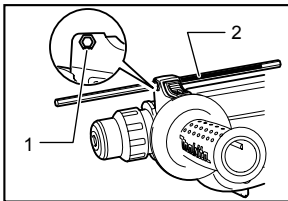

1. Toothed side of hex hole marking on the grip base  
2. Toothed side of the depth gauge

010719

**NOTE:**

- Inserting the depth gauge with its toothed side not directed to the toothed side of hex hole marking on the grip base as shown in the figure does not allow the depth gauge to be locked.

**Dust cup**

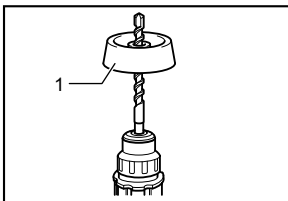

1. Dust cup

010731

Use the dust cup to prevent dust from falling over the tool and on yourself when performing overhead drilling operations. Attach the dust cup to the bit as shown in the figure. The size of bits which the dust cup can be attached to is as follows.

	Bit diameter
Dust cup 5	6 mm - 14.5 mm
Dust cup 9	12 mm - 16 mm

006406

There is another type of dust cup (accessory) which helps you prevent dust from falling over the tool and on yourself when performing overhead drilling operations.

**Installing or removing the dust cup**

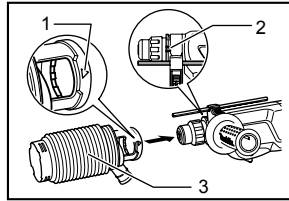

1.  $\Delta$  symbol  
2. Grooves  
3. Dust cup

011506

Before installing the dust cup, remove the bit from the tool if installed on the tool. Install the dust cup (accessory) on the tool so that the  $\Delta$  symbol on the dust cup is aligned with the grooves in the tool.

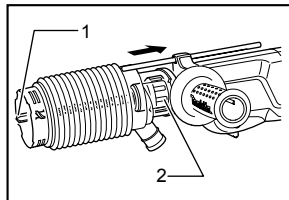

1. Bit  
2. Chuck cover

010733

To remove the dust cup, pull the chuck cover in the direction as shown in the figure and with the chuck cover pulled take the bit out of the tool.

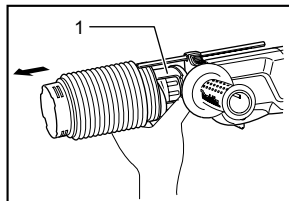

1. Attachment at the foot of dust cup

010734

And then grab the attachment at the foot of dust cup and take it out.

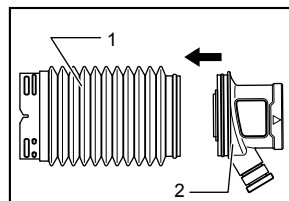

1. Bellows  
2. Attachment

011507



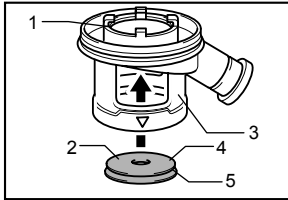

1. Inside periphery
2. Carved side
3. Attachment
4. Cap
5. Groove

012895

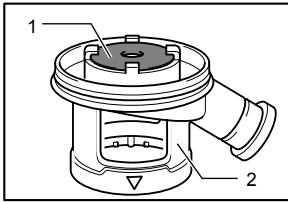

1. Cap
2. Attachment

012896

**NOTE:**

- When installing or removing the dust cup, the cap may come off the dust cup. At that time, proceed as follows. Remove the bellows from the attachment and fit the cap from the side shown in the figure with its carved side facing upward so that the groove in the cap fits in the inside periphery of the attachment. Finally, mount the bellows that has been removed.

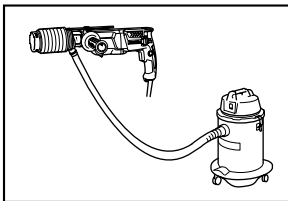

011505

**NOTE:**

- If you connect a vacuum cleaner to your hammer, cleaner operations can be performed. Dust cap needs to be removed from the dust cup before the connection.

## OPERATION

Always use the side grip (auxiliary handle) and firmly hold the tool by both side grip and switch handle during operations.

### Hammer drilling operation

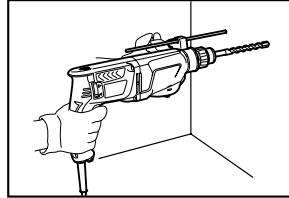

010729

Set the action mode changing knob to the  symbol. Position the bit at the desired location for the hole, then pull the switch trigger. Do not force the tool. Light pressure gives best results. Keep the tool in position and prevent it from slipping away from the hole.

Do not apply more pressure when the hole becomes clogged with chips or particles. Instead, run the tool at an idle, then remove the bit partially from the hole. By repeating this several times, the hole will be cleaned out and normal drilling may be resumed.

Set the action mode changing knob to the  symbol.

### CAUTION:

- There is a tremendous and sudden twisting force exerted on the tool/bit at the time of hole break-through, when the hole becomes clogged with chips and particles, or when striking reinforcing rods embedded in the concrete. Always use the side grip (auxiliary handle) and firmly hold the tool by both side grip and switch handle during operations. Failure to do so may result in the loss of control of the tool and potentially severe injury.

### NOTE:

Eccentricity in the bit rotation may occur while operating the tool with no load. The tool automatically centers itself during operation. This does not affect the drilling precision.

### Blow-out bulb (optional accessory)

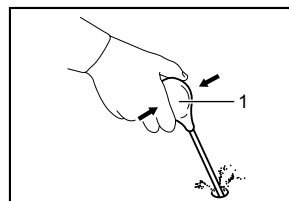

1. Blow-out bulb

002449

After drilling the hole, use the blow-out bulb to clean the dust out of the hole.

### Chipping/Scaling/Demolition

For Models HR2310T, HR2610, HR2610T, HR2611F, HR2611FT

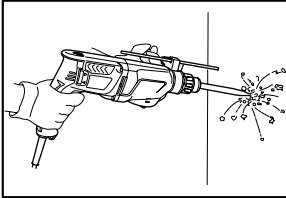

011564

Set the action mode changing knob to the  symbol. Hold the tool firmly with both hands. Turn the tool on and apply slight pressure on the tool so that the tool will not bounce around, uncontrolled. Pressing very hard on the tool will not increase the efficiency.

### Drilling in wood or metal

For Models HR2300, HR2600, HR2601, HR2610, HR2611F

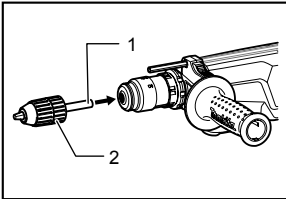

011560

Use the optional drill chuck assembly. When installing it, refer to "Installing or removing the bit" described on the previous page.

For Models HR2310T, HR2610T, HR2611FT

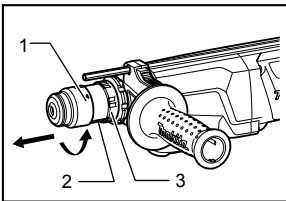

011561

1. Chuck adapter
2. Keyless drill chuck

1. Quick change chuck for SDS-plus
2. Change cover line
3. Change cover

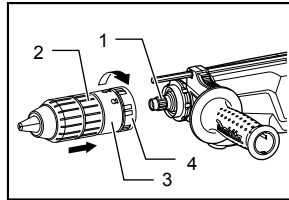

011562

Use the quick change drill chuck as standard equipment. When installing it, refer to "changing the quick change chuck for SDS-plus" described on the previous page.

1. Spindle
2. Quick change drill chuck
3. Change cover line
4. Change cover

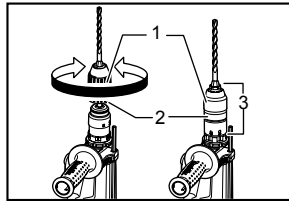

011563

Hold the ring and turn the sleeve counterclockwise to open the chuck jaws. Place the bit in the chuck as far as it will go. Hold the ring firmly and turn the sleeve clockwise to tighten the chuck. To remove the bit, hold the ring and turn the sleeve counterclockwise.

1. Sleeve
2. Ring
3. Quick change drill chuck

Set the action mode changing knob to the  symbol. You can drill up to 13 mm diameter in metal and up to 32 mm diameter in wood.

### ⚠CAUTION:

- Never use "rotation with hammering" when the quick change drill chuck is installed on the tool. The quick change drill chuck may be damaged. Also, the drill chuck will come off when reversing the tool.
- Pressing excessively on the tool will not speed up the drilling. In fact, this excessive pressure will only serve to damage the tip of your bit, decrease the tool performance and shorten the service life of the tool.
- There is a tremendous twisting force exerted on the tool/bit at the time of hole breakthrough. Hold the tool firmly and exert care when the bit begins to break through the workpiece.
- A stuck bit can be removed simply by setting the reversing switch to reverse rotation in order to back out. However, the tool may back out abruptly if you do not hold it firmly.
- Always secure small workpieces in a vise or similar hold-down device.

## Diamond core drilling

When performing diamond core drilling operations, always set the change lever to the  position to use "rotation only" action.

### ⚠CAUTION:

- If performing diamond core drilling operations using "rotation with hammering" action, the diamond core bit may be damaged.

## Operation when using the dust cup (accessory)

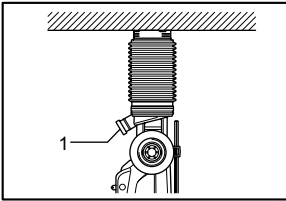

1. Dust cup

010736

Operate the tool with the dust cup against the ceiling surface.

### NOTE:

- The dust cup (accessory) is intended only for drilling in the ceramic workpiece such as concrete and mortar. Do not use the tool with the dust cup when drilling in metal or similar. Using the dust cup for drilling in the metal may damage the dust cup due to the heat produced by small metal dust or similar.
- Empty the dust cup before removing a drill bit.
- When using the dust cup, make sure that the dust cap is mounted on it securely.

## MAINTENANCE

### ⚠CAUTION:

- Always be sure that the tool is switched off and unplugged before attempting to perform inspection or maintenance.
- Never use gasoline, benzine, thinner, alcohol or the like. Discoloration, deformation or cracks may result.

To maintain product SAFETY and RELIABILITY, repairs, carbon brush inspection and replacement, any other maintenance or adjustment should be performed by Makita Authorized Service Centers, always using Makita replacement parts.

## OPTIONAL ACCESSORIES

### ⚠CAUTION:

- These accessories or attachments are recommended for use with your Makita tool specified in this manual. The use of any other accessories or attachments might present a risk of injury to persons. Only use accessory or attachment for its stated purpose.

If you need any assistance for more details regarding these accessories, ask your local Makita Service Center.

- SDS-Plus Carbide-tipped bits
- Core bit
- Bull point
- Diamond core bit
- Cold chisel
- Scaling chisel
- Grooving chisel
- Drill chuck assembly
- Drill chuck S13
- Chuck adapter
- Chuck key S13
- Bit grease
- Side grip
- Depth gauge
- Blow-out bulb
- Dust cup
- Dust extractor attachment
- Safety goggles
- Plastic carrying case
- Keyless drill chuck

### NOTE:

- Some items in the list may be included in the tool package as standard accessories. They may differ from country to country.

**Makita Corporation**

884939A3

[www.makita.com](http://www.makita.com)

Download from [Www.Somanuals.com](http://Www.Somanuals.com). All Manuals Search And Download.

## Free Manuals Download Website

<http://myh66.com>

<http://usermanuals.us>

<http://www.somanuals.com>

<http://www.4manuals.cc>

<http://www.manual-lib.com>

<http://www.404manual.com>

<http://www.luxmanual.com>

<http://aubethermostatmanual.com>

Golf course search by state

<http://golfingnear.com>

Email search by domain

<http://emailbydomain.com>

Auto manuals search

<http://auto.somanuals.com>

TV manuals search

<http://tv.somanuals.com>