

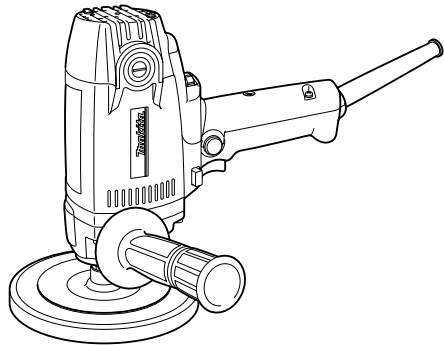

Electronic Polisher

180 mm (7")

MODEL PV7001C



003431

I N S T R U C T I O N M A N U A L

⚠ WARNING:

For your personal safety, READ and UNDERSTAND before using.
SAVE THESE INSTRUCTIONS FOR FUTURE REFERENCE.

www.makitatools.com

SPECIFICATIONS

Model	PV7001C
No load speed (RPM)	600 - 2,000/min.
Overall length	210 mm (8-1/4")
Net weight	2.0 kg (4.4 lbs)
Spindle thread	5/8"

- Manufacturer reserves the right to change specifications without notice.
- Specifications may differ from country to country.

GENERAL SAFETY RULES

USA001-2

(For All Tools)

⚠ WARNING:

Read and understand all instructions. Failure to follow all instructions listed below, may result in electric shock, fire and/or serious personal injury.

SAVE THESE INSTRUCTIONS

Work Area

1. **Keep your work area clean and well lit.** Cluttered benches and dark areas invite accidents.
2. **Do not operate power tools in explosive atmospheres, such as in the presence of flammable liquids, gases, or dust.** Power tools create sparks which may ignite the dust or fumes.
3. **Keep bystanders, children, and visitors away while operating a power tool.** Distractions can cause you to lose control.

Electrical Safety

4. **Grounded tools must be plugged into an outlet properly installed and grounded in accordance with all codes and ordinances. Never remove the grounding prong or modify the plug in any way. Do not use any adaptor plugs. Check with a qualified electrician if you are in doubt as to whether the outlet is properly grounded.** If the tools should electrically malfunction or break down, grounding provides a low resistance path to carry electricity away from the user.

5. **Avoid body contact with grounded surfaces such as pipes, radiators, ranges and refrigerators.** There is an increased risk of electric shock if your body is grounded.
6. **Do not expose power tools to rain or wet conditions.** Water entering a power tool will increase the risk of electric shock.
7. **Do not abuse the cord. Never use the cord to carry the tools or pull the plug from an outlet. Keep cord away from heat, oil, sharp edges or moving parts. Replace damaged cords immediately.** Damaged cords increase the risk of electric shock.
8. **When operating a power tool outside, use an outdoor extension cord marked "W-A" or "W".** These cords are rated for outdoor use and reduce the risk of electric shock.

Personal Safety

9. **Stay alert, watch what you are doing and use common sense when operating a power tool. Do not use tool while tired or under the influence of drugs, alcohol, or medication.** A moment of inattention while operating power tools may result in serious personal injury.
10. **Dress properly. Do not wear loose clothing or jewelry. Contain long hair. Keep your hair, clothing, and gloves away from moving parts.** Loose clothes, jewelry, or long hair can be caught in moving parts.
11. **Avoid accidental starting. Be sure switch is off before plugging in.** Carrying tools with your finger on the switch or plugging in tools that have the switch on invites accidents.
12. **Remove adjusting keys or wrenches before turning the tool on.** A wrench or a key that is left attached to a rotating part of the tool may result in personal injury.
13. **Do not overreach. Keep proper footing and balance at all times.** Proper footing and balance enables better control of the tool in unexpected situations.
14. **Use safety equipment. Always wear eye protection.** Dust mask, non-skid safety shoes, hard hat, or hearing protection must be used for appropriate conditions. Ordinary eye or sun glasses are NOT eye protection.

Tool Use and Care

15. **Use clamps or other practical way to secure and support the workpiece to a stable platform.** Holding the work by hand or against your body is unstable and may lead to loss of control.
16. **Do not force tool. Use the correct tool for your application.** The correct tool will do the job better and safer at the rate for which it is designed.
17. **Do not use tool if switch does not turn it on or off.** Any tool that cannot be controlled with the switch is dangerous and must be repaired.
18. **Disconnect the plug from the power source before making any adjustments, changing accessories, or storing the tool.** Such preventive safety measures reduce the risk of starting the tool accidentally.
19. **Store idle tools out of reach of children and other untrained persons.** Tools are dangerous in the hands of untrained users.
20. **Maintain tools with care. Keep cutting tools sharp and clean.** Properly maintained tools with sharp cutting edges are less likely to bind and are easier to control.
21. **Check for misalignment or binding of moving parts, breakage of parts, and any other condition that may affect the tools operation. If damaged, have the tool serviced before using.** Many accidents are caused by poorly maintained tools.
22. **Use only accessories that are recommended by the manufacturer for your model.** Accessories that may be suitable for one tool, may become hazardous when used on another tool.

SERVICE

23. Tool service must be performed only by qualified repair personnel. Service or maintenance performed by unqualified personnel could result in a risk of injury.

24. When servicing a tool, use only identical replacement parts. Follow instructions in the Maintenance section of this manual. Use of unauthorized parts or failure to follow Maintenance instructions may create a risk of electric shock or injury.

USE PROPER EXTENSION CORD: Use only three-wire extension cords that have three-prong grounding-type plugs and three-pole receptacles that accept the tool's plug. Make sure your extension cord is in good condition. Replace or repair damaged or worn cord immediately. When using an extension cord, be sure to use one heavy enough to carry the current your product will draw. An undersized cord will cause a drop in line voltage resulting in loss of power and overheating. Table 1 shows the correct size to use depending on cord length and nameplate ampere rating. If in doubt, use the next heavier gage. The smaller the gage number, the heavier the cord.

Table 1: Minimum gage for cord

Ampere Rating		Volts	Total length of cord in feet			
		120 V	25 ft.	50 ft.	100 ft.	150 ft.
More Than	Not More Than	AWG				
0	6		18	16	16	14
6	10		18	16	14	12
10	12		16	16	14	12
12	16		14	12	Not Recommended	

GROUNDING INSTRUCTIONS

This tool should be grounded while in use to protect the operator from electric shock. The tool is equipped with a three-conductor cord and three-prong grounding type plug to fit the proper grounding type receptacle. The green (or green and yellow) conductor in the cord is the grounding wire. Never connect the green (or green and yellow) wire to a live terminal. Your unit is for use on 120 volts and has a plug that looks like Fig. "A".

An adapter Fig. "B" and "C" is available for connecting Fig. "A" type plugs to two-prong receptacles. The green-colored rigid ear, lug, etc., extending from the adapter must be connected to a permanent ground, such as a properly grounded outlet box.

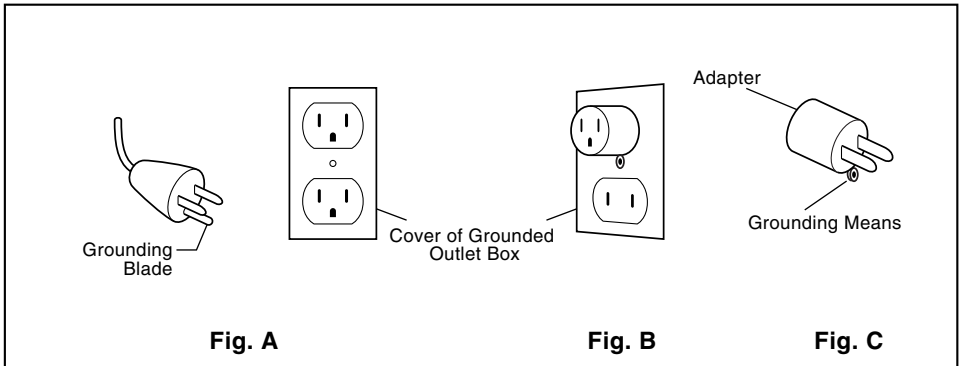

SPECIFIC SAFETY RULES

USB047-3

DO NOT let comfort or familiarity with product (gained from repeated use) replace strict adherence to polisher safety rules. If you use this tool unsafely or incorrectly, you can suffer serious personal injury.

1. **Accessories must be rated for at least the speed recommended on the tool warning label.** Wheels and other accessories running over rated speed can fly apart and cause injury.
2. **Hold tool by insulated gripping surfaces when performing an operation where the cutting tool may contact hidden wiring or its own cord.** Contact with a "live" wire will make exposed metal parts of the tool "live" and shock the operator.
3. **Check the backing pad carefully for cracks, damage or deformity before operation. Replace cracked, damaged or deformed pad immediately.**
4. **NEVER use tool with wood cutting blades or other sawblades. Such blades when used on a polisher frequently kick and cause loss of control leading to personal injury.**
5. **Hold the tool firmly.**
6. **Keep hands away from rotating parts.**
7. **Make sure the abrasive disc or wool bonnet is not contacting the workpiece before the switch is turned on.**
8. **When sanding metal surfaces, watch out for flying sparks. Hold the tool so that sparks fly away from you and other persons or flammable materials.**

-
- 9. Do not leave the tool running. Operate the tool only when hand-held.
 - 10. Do not touch the workpiece immediately after operation; it may be extremely hot and could burn your skin.
 - 11. Check that the workpiece is properly supported.
 - 12. Pay attention that the wheel continues to rotate after the tool is switched off.
 - 13. This tool has not been waterproofed, so do not use water on the workpiece surface.
 - 14. Ventilate your work area adequately when you perform sanding operations.
 - 15. Use of this tool to sand some products, paints and wood could expose user to dust containing hazardous substances. Use appropriate respiratory protection.
-

SAVE THESE INSTRUCTIONS

⚠ WARNING:
MISUSE or failure to follow the safety rules stated in this instruction manual may cause serious personal injury.

SYMBOLS

USD101-2

The followings show the symbols used for tool.

V volts

 alternating current

A amperes

n₀ no load speed

Hz hertz

.../min..... revolutions or reciprocation per minute

FUNCTIONAL DESCRIPTION

⚠ CAUTION:

- Always be sure that the tool is switched off and unplugged before adjusting or checking function on the tool.

Switch action

⚠ CAUTION:

- Before plugging in the tool, always check to see that the switch trigger actuates properly and returns to the “OFF” position when released.
- Switch can be locked in “ON” position for ease of operator comfort during extended use. Apply caution when locking tool in “ON” position and maintain firm grasp on tool.

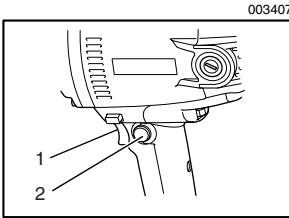

1. Switch trigger
2. Lock button

To start the tool, simply pull the switch trigger. Release the switch trigger to stop.

For continuous operation, pull the switch trigger and then push in the lock button.

To stop the tool from the locked position, pull the switch trigger fully, then release it.

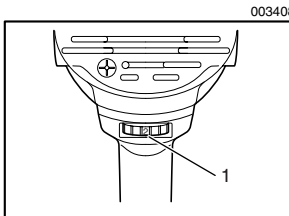

1. Speed adjusting dial

Speed adjusting dial

The tool speed can be changed by turning the speed adjusting dial to a given number setting from 1 to 5.

Higher speed is obtained when the dial is turned in the direction of number 5. And lower speed is obtained when it is turned in the direction of number 1.

Number	RPM (/min)
1	600
2	800
3	1,300
4	1,800
5	2,000

Refer to the table for the relationship between the number settings on the dial and the approximate tool speed.

⚠ CAUTION:

- If the tool is operated continuously at low speeds for a long time, the motor will get overloaded, resulting in tool malfunction.
- The speed adjusting dial can be turned only as far as 5 and back to 1. Do not force it past 5 or 1, or the speed adjusting function may no longer work.

The tools equipped with electronic function are easy to operate because of the following features.

- **Electronic constant speed control**

Possible to get fine finish, because the rotating speed is kept constantly even under the loaded condition.

- **Soft start feature**

Soft start because of suppressed starting shock.

003444

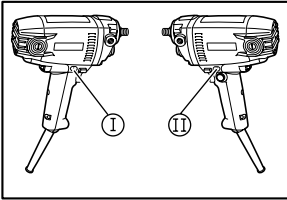

High-Low speed setting button

The tool speed can be changed instantly while the tool is running. Depress the “I” position for lowest speed and depress “II” position for a given number setting.

The tool speed cannot be changed when the button is in “I” position, even if you turn the speed adjusting dial. When you turn the speed adjusting dial, always be sure that the button is depressed in “II” position.

ASSEMBLY

⚠ CAUTION:

- Always be sure that the tool is switched off and unplugged before carrying out any work on the tool.

003412

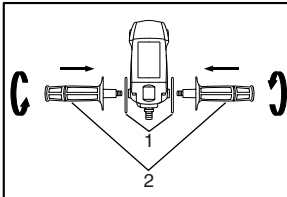

1. Cover
2. Side grip

Installing side grip (auxiliary handle) & cover

⚠ CAUTION:

- Always be sure that the side grip is installed securely before operation.

Install the cover, then screw the side grip on the tool securely. The side grip and the cover can be installed on either side of the tool.

003413

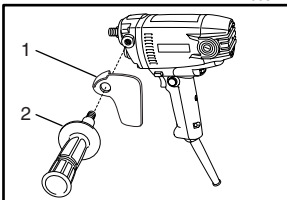

1. Cover
2. Side grip

003453

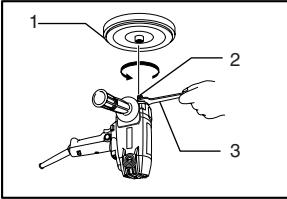

1. Backing pad
2. Spindle
3. Wrench

Installing or removing backing pad

Hold the spindle with the wrench so that it cannot revolve. Then screw the pad onto the spindle all the way. (The pad can be used to install the optional sponge pad.)

To remove the pad, follow the installation procedure in reverse.

003454

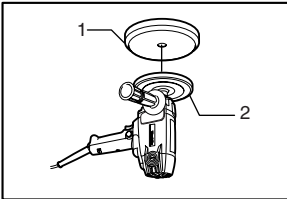

1. Sponge pad
2. Pad

Installing or removing sponge pad (optional accessory)

To install the sponge pad, first remove all dirt or foreign matter from the pad. Install the sponge pad to the pad.

To remove the pad, pull it off from the pad slowly.

003468

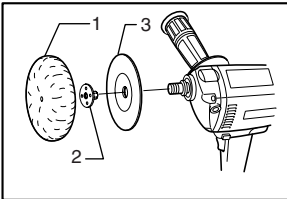

1. Wool bonnet
2. Lock nut
3. Rubber pad

Installing or removing the wool bonnet (optional accessory)

Mount the rubber pad onto the spindle. Screw the lock nut onto the spindle.

003469

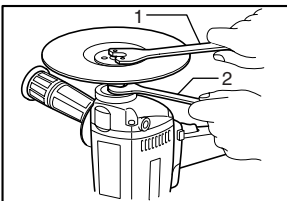

1. Lock nut wrench
2. Wrench

To tighten the lock nut, hold the spindle with the wrench so that it cannot revolve, then use the lock nut wrench and securely tighten clockwise.

003470

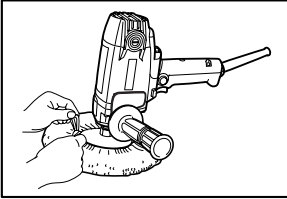

Fit the wool bonnet completely over the rubber pad and pull the string tight. Tie a bow knot and tuck the knot and any loose strings between the wool bonnet and the rubber pad.

To remove the wool bonnet, follow the installation procedure in reverse.

003414

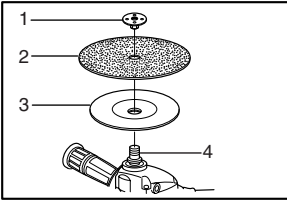

Installing or removing abrasive disc (optional accessory)

NOTE:

- Use sander accessories specified in this manual. These must be purchased separately.

Mount the rubber pad onto the spindle. Fit the abrasive disc on the rubber pad and screw the lock nut onto the spindle.

1. Lock nut
2. Abrasive disc
3. Rubber pad
4. Spindle

003418

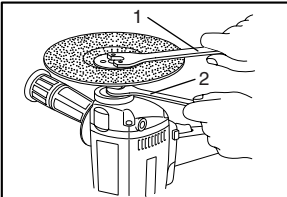

To tighten the lock nut, hold the spindle with the wrench so that it cannot revolve, then use the lock nut wrench and securely tighten clockwise.

To remove the disc, follow the installation procedure in reverse.

1. Lock nut wrench
2. Wrench

OPERATION

003479

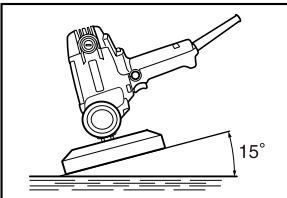

Polishing operation by sponge pad

⚠ CAUTION:

- Always wear safety glasses or a face shield during operation.

In general, keep the sponge pad at an angle of about 15 degrees to the workpiece surface.

003480

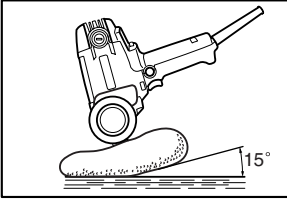

Polishing operation by wool bonnet

⚠ CAUTION:

- Always wear safety glasses or a face shield during operation.

Hold the tool firmly. Turn the tool on and then apply the wool bonnet to the workpiece.

In general, keep the wool bonnet at an angle of about 15 degrees to the workpiece surface.

Apply slight pressure only. Excessive pressure will result in poor performance and premature wear to wool bonnet.

003421

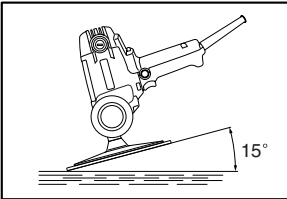

Sanding operation

⚠ CAUTION:

- Always wear safety goggles or a face shield during operation.
- Never switch on the tool when it is in contact with the workpiece, it may cause an injury to operator.
- Never run the tool without the abrasive disc. You may seriously damage the pad.

Hold the tool firmly. Turn the tool on and then apply the abrasive disc to the workpiece.

In general, keep the abrasive disc at an angle of about 15 degrees to the workpiece surface.

Apply slight pressure only. Excessive pressure will result in poor performance and premature wear to abrasive disc.

MAINTENANCE

⚠ CAUTION:

- Always be sure that the tool is switched off and unplugged before attempting to perform inspection or maintenance.

001145

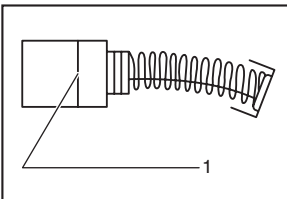

Replacing carbon brushes

Remove and check the carbon brushes regularly. Replace when they wear down to the limit mark. Keep the carbon brushes clean and free to slip in the holders. Both carbon brushes should be replaced at the same time. Use only identical carbon brushes.

1. Limit mark

003423

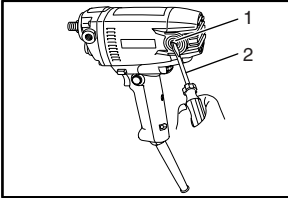

1. Brush holder cap
2. Screwdriver

Use a screwdriver to remove the brush holder caps. Take out the worn carbon brushes, insert the new ones and secure the brush holder caps.

To maintain product SAFETY and RELIABILITY, repairs, any other maintenance or adjustment should be performed by Makita Authorized or Factory Service Centers, always using Makita replacement parts.

ACCESSORIES

⚠ CAUTION:

- These accessories or attachments are recommended for use with your Makita tool specified in this manual. The use of any other accessories or attachments might present a risk of injury to persons. Only use accessory or attachment for its stated purpose.

If you need any assistance for more details regarding these accessories, ask your local Makita service center.

- Sponge pad (Hook & loop)
- Abrasive discs
- Wool bonnet 180
- Rubber pad 170
- Sanding lock nut 5/8 - 48
- Lock nut wrench 28
- Wrench 17

Cut



First-Class
Postage
Required

Post Office will
not deliver
without proper
postage.

Makita U.S.A., Inc.
14930 Northam Street
La Mirada, CA 90638-5753



Fold

MAIL THIS PORTION

Your answers to the following questions are appreciated.

1. This product was purchased from:

- Home Center Other ()
 Hardware/Lumber Store
 Tool Distributor
 Industrial Supply
 Construction Supply

3. How did you learn about this product:

- Magazine Radio
 From Dealer Exhibition
 Newspaper From Friend
 Store Display Previous Usage
 Catalog Other ()

2. Use of the product is intended for:

- Construction Trade
 Industrial Maintenance
 Home Maintenance
 Hobby
 Other ()

4. Most favored points are:

- Design Repair Service
 Features Durability
 Size Power
 Price Other ()
 Makita Brand

5. Any comments:

DATE PURCHASED			MODEL NO.																				
MONTH		DAY		YEAR		SERIAL NO.																	
INTL.										LAST NAME / COMPANY NAME										STATUS		SEX	
																				Married Single		M F	
STREET ADDRESS																							
CITY																							
STATE		ZIP CODE				PHONE				AREA CODE													
AGE:		<input type="checkbox"/> Under 19		<input type="checkbox"/> 20-29		<input type="checkbox"/> 30-39		<input type="checkbox"/> 40-49		<input type="checkbox"/> 50-60		<input type="checkbox"/> Over 60											

BE SURE TO COMPLETE THE CUSTOMER'S PORTION OF THIS FORM AND RETAIN FOR YOUR RECORDS.

Please return this portion by facsimile or mail.

Facsimile No: (714) 522-8133

FACTORY SERVICE CENTERS

1-800-4-MAKITA

RETAIN THIS PORTION FOR YOUR RECORDS

ALABAMA

2365 Pelham Parkway
Pelham, AL 35124
(205) 620-1791

ARIZONA

3707 E. Broadway Rd., Ste. 6
Phoenix, AZ 85040
(602) 482-8500

ARKANSAS

Shackelford Shopping Center
240 South Shackelford Rd.,
Ste. C
Little Rock, AR 72211
(501) 224-5733

CALIFORNIA

41850 Christy St.
Fremont, CA 94538-5107
(510) 657-9881

1421 N. Clovis Ave., Ste. 112
Fresno, CA 93727
(559) 252-5166

14930 Northam St.
La Mirada, CA 90638-5753
(714) 522-9089

1970 Fulton Avenue
Sacramento, CA 95825
(916) 482-5197

1440 South "E" Street
San Bernardino, CA 92408
(909) 885-1289

7674 Clairemont Mesa Blvd.
San Diego, CA 92111
(858) 278-4471

1714 E. McFadden Ave., Unit M
Santa Ana, CA 92705
(714) 667-5066

1565 Winchester B.
Campbell, CA 95008-0501
(408) 379-0377

16735 Satcoy St., Ste. 105
Van Nuys, CA 91406
(818) 782-2440

COLORADO

11839 E. 51st Ave.
Denver, CO 80239-2709
(303) 371-2850

CONNECTICUT

508 Spring St.
Windsor Locks, CT 06096
(860) 292-6405

FLORIDA

620 Douglas Ave. Suite 1302
Altamonte Springs, FL 32714
(407) 774-6000

750 East Sample Road
Pompano Beach, FL 33064
(954) 781-6333

Thompson Center Waters
5501 W. Waters Ave., Ste. 406
Tampa, FL 33634
(813) 886-8292

GEORGIA

4680 River Green Parkway
Duluth, GA 30096-2566
(770) 476-8911

HAWAII

4510 Salt Lake Blvd., Suite A7
Honolulu, HI 96818
(808) 847-0038

ILLINOIS

1450 Feehanville Dr.
Mt. Prospect, IL 60056-6011
(847) 297-3100

INDIANA

8403 Michigan Road, Unit 1
Indianapolis, IN 46268
(317) 334-9980

KANSAS

8819 W. 95th St.
Overland Park, KS 66212
(913) 642-1111

KENTUCKY

1215 S. Hurstbourne Parkway
Louisville, KY 40222
(502) 326-3740

LOUISIANA

5626 Jefferson Hwy.
Harahan, LA 70123
(504) 733-4138

MARYLAND

7541 - 45 Ritchie Highway
Glen Burnie, MD 21061
(410) 590-0160

MASSACHUSETTS

232 Providence Hwy.
Westwood, MA 02090
(617) 461-9754

MICHIGAN

37454 Ann Arbor Trail
Livonia, MI 48150
(313) 432-1012

MINNESOTA

6427 Penn Ave. South
Richfield, MN 55423
(612) 869-5199

MISSOURI

9876 Watson Road
St. Louis, MO 63126-2221
(314) 909-9889

NEBRASKA

4129 S. 84th St.
Omaha, NE 68127
(402) 597-2925

NEVADA

3375 S. Decatur Blvd.
SuiteS 22 - 24
Las Vegas, NV 89102
(702) 368-4277

NEW JERSEY

251 Herrod Blvd.
Dayton, NJ 08810-1539
(609) 655-1212

NEW MEXICO

5805 Menaul Blvd. NE
Albuquerque, NM 87110
(505) 881-4619

NEW YORK

4917 Genessee Street
Cheektowaga, NY 14225
(716) 685-9503

131-35 31st Ave.
Flushing, NY 11354
(718) 886-0971

NORTH CAROLINA

3501-G S. Tryon St.
Charlotte, NC 28217
(704) 527-0611

OHIO

6253 E. Main St.
Columbus, OH 43213
(614) 860-0222

6379 Pearl Road
Parma Heights, OH 44130
(440) 843-7555

1617 E. Kemper Rd.
Sharonville, OH 45246
(513) 771-0788

OKLAHOMA

552 E. Memorial Road
Oklahoma City, OK 73114
(405) 752-2655

OREGON

828 19th Avenue., N.W.
Portland, OR 97209
(503) 222-1823

PENNSYLVANIA

Springwater Plaza
364 Wilmington W. Chester
Pike
Glen Mills, PA 19342
(610) 459-4122

6200 Babcock Blvd
Pittsburgh, PA 15237
(412) 366-6363

PUERTO RICO

200 Guayama St.
Hato Rey, PR 00917
(787) 250-8776

TENNESSEE

4655 Nolensville Rd.
Nashville, TN 37211
(615) 331-9922

TEXAS

12601 Stemmons Fwy Ste. 809
Farmers Branch, TX 75234
(972) 243-1150

12701 Directors Dr.
Stafford, TX 77477-3701
(281) 955-8665

3453 IH-35 North, Ste. 101
San Antonio, TX 78219
(210) 228-0676

UTAH

145 E. 1300 S., Ste. 101
Salt Lake City, UT 84115
(801) 359-3410

VIRGINIA

5760 Northampton Blvd., Ste.
102
Virginia Beach, VA 23455
(757) 460-0280

WASHINGTON

22220 84th Ave. So., Bldg. A
Kent, WA 98032
(253) 395-8055

WISCONSIN

Lincoln Plaza Shopping Ctr.
2245 S. 108th St. West Allis, WI
53227
(414) 541-4776

CUSTOMER'S RECORD

<p>When you need service: Send complete tool (prepaid) to one of the Makita Factory Service Centers listed, or to an Authorized Makita Service Center. Be sure to attach a letter to the outside of the carton detailing the problem with your tool.</p>	Date Purchased
	Dealer's Name & Address
	Model No.
	Serial No.

WARNING

Some dust created by power sanding, sawing, grinding, drilling, and other construction activities contains chemicals known to the State of California to cause cancer, birth defects or other reproductive harm. Some examples of these chemicals are:

- lead from lead-based paints,
- crystalline silica from bricks and cement and other masonry products, and
- arsenic and chromium from chemically-treated lumber.

Your risk from these exposures varies, depending on how often you do this type of work. To reduce your exposure to these chemicals: work in a well ventilated area, and work with approved safety equipment, such as those dust masks that are specially designed to filter out microscopic particles.

MAKITA LIMITED ONE YEAR WARRANTY

Warranty Policy

Every Makita tool is thoroughly inspected and tested before leaving the factory. It is warranted to be free of defects from workmanship and materials for the period of ONE YEAR from the date of original purchase. Should any trouble develop during this one-year period, return the COMPLETE tool, freight prepaid, to one of Makita's Factory or Authorized Service Centers. If inspection shows the trouble is caused by defective workmanship or material, Makita will repair (or at our option, replace) without charge.

This Warranty does not apply where:

- repairs have been made or attempted by others:
- repairs are required because of normal wear and tear:
- the tool has been abused, misused or improperly maintained:
- alterations have been made to the tool.

IN NO EVENT SHALL MAKITA BE LIABLE FOR ANY INDIRECT, INCIDENTAL OR CONSEQUENTIAL DAMAGES FROM THE SALE OR USE OF THE PRODUCT. THIS DISCLAIMER APPLIES BOTH DURING AND AFTER THE TERM OF THIS WARRANTY.

MAKITA DISCLAIMS LIABILITY FOR ANY IMPLIED WARRANTIES, INCLUDING IMPLIED WARRANTIES OF "MERCHANTABILITY" AND "FITNESS FOR A SPECIFIC PURPOSE," AFTER THE ONE-YEAR TERM OF THIS WARRANTY.

This Warranty gives you specific legal rights, and you may also have other rights which vary from state to state. Some states do not allow the exclusion or limitation of incidental or consequential damages, so the above limitation or exclusion may not apply to you. Some states do not allow limitation on how long an implied warranty lasts, so the above limitation may not apply to you.

Makita Corporation
3-11-8, Sumiyoshi-cho,
Anjo, Aichi 446-8502 Japan

Free Manuals Download Website

<http://myh66.com>

<http://usermanuals.us>

<http://www.somanuals.com>

<http://www.4manuals.cc>

<http://www.manual-lib.com>

<http://www.404manual.com>

<http://www.luxmanual.com>

<http://aubethermostatmanual.com>

Golf course search by state

<http://golfingnear.com>

Email search by domain

<http://emailbydomain.com>

Auto manuals search

<http://auto.somanuals.com>

TV manuals search

<http://tv.somanuals.com>