



Makita Miter Saws

255 mm (10") MODEL 2401B
355 mm (14") MODEL LS1410

INSTRUCTION MANUAL

Miter Saw & Standard Equipment

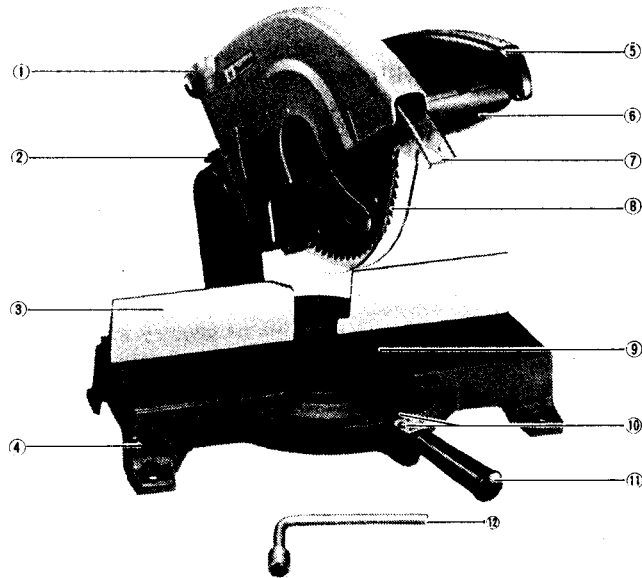

- | | | |
|----------------------|-----------------------------|-------------------------|
| ① Elbow (Dust Spout) | ⑤ Operating Handle (Switch) | ⑨ Turn Base |
| ② Locking Stopper | ⑥ Motor Housing | ⑩ Miter Scale & Pointer |
| ③ Fence | ⑦ Safety Cover | ⑪ Miter Clamp Grip |
| ④ Base | ⑧ Saw Blade | ⑫ Socket Wrench |



SPECIFICATIONS

MODEL NO.	Blade diameter	Hole diameter	Max. cutting capacities (H x W)		Continuous rating		No load speed	Dimensions (L x W x H)	Net weight	Power supply cord
			at 90°	at 45°	Input	Output				
2401B	255 mm (10")	25 mm (1")	72 mm x 122 mm (2-1/2" x 4-3/4")	72 mm x 90 mm (2-1/2" x 3-1/2")	1,380 W	750 W	4,100 R/min.	520 mm x 480 mm x 460 mm (20-1/2" x 18-7/8" x 18-1/8")	22.5 kg (49.6 lbs)	2.5 m (8.2 ft.)
LS1410	355 mm (14")	25 mm (1")	122 mm x 150 mm (4-3/4" x 15-7/8")	122 mm x 115 mm (4-3/4" x 14-1/2")			3,200 R/min.	600 mm x 520 mm x 615 mm (23-5/8" x 20-1/2" x 24-1/4")	30 kg (66.1 lbs)	2.5 m (8.2 ft.)

BEFORE CONNECTING YOUR TOOL TO A POWER SOURCE

Be sure you have read all GENERAL POWER TOOL SAFETY RULES

GENERAL SAFETY PRECAUTIONS

1. KEEP GUARDS IN PLACE and in working order.
2. REMOVE ADJUSTING KEYS AND WRENCHES. Form habit of checking to see that keys and adjusting wrenches are removed from tool before turning it on.
3. KEEP WORK AREA CLEAN. Cluttered areas and benches invite accidents.
4. AVOID DANGEROUS ENVIRONMENT. Don't use power tools in damp or wet locations. Keep work area well lit.
5. KEEP CHILDREN AWAY. All visitors should be kept safe distance from work area.
6. MAKE WORKSHOP KID PROOF with padlocks, master switches, or by removing starter keys.
7. DON'T FORCE TOOL. It will do the job better and safer at the rate for which it was designed.
8. USE RIGHT TOOL. Don't force tool or attachment to do a job it was not designed for.
9. WEAR PROPER APPAREL. No loose clothing or jewelry to get caught in moving parts. Rubber-soled footwear is recommended for best footing.
10. USE SAFETY GLASSES. Also use face or dust mask if cutting operation is dusty.
11. SECURE WORK. Use clamps or a vise to hold work when practical. It's safer than using your hand and it frees both hands to operate tool.
12. DON'T OVERREACH. Keep proper footing and balance at all times.
13. MAINTAIN TOOLS WITH CARE. Keep tools sharp and clean for best and safest performance. Follow instructions for lubricating and changing accessories.
14. DISCONNECT TOOLS before servicing; when changing accessories such as blades or adjusting guides.
15. AVOID ACCIDENTAL STARTING. Make sure switch is in off position before plugging in.
16. USE RECOMMENDED ACCESSORIES. Consult the owner's manual for recommended accessories. The use of improper accessories may cause hazards.
17. NEVER STAND ON TOOL. Serious injury could occur if the tool is tipped or if the cutting tool is accidentally contacted.
18. CHECK DAMAGED PARTS. Before further use of the tool, a guard or other part that is damaged should be carefully checked to ensure that it will operate properly and perform its intended function — check for alignment of moving parts, binding of moving parts, breakage of parts, mounting, and any other conditions that may affect its operation. A guard or other part that is damaged should be properly repaired or replaced.

PRELIMINARY INSTRUCTIONS

Your electric tool is precision built and manufactured to satisfy the highest standards. For maximum performance, long tool life, and your safety, follow these instructions carefully.

VOLTAGE WARNING : Before connecting the tool to a power source (receptacle, outlet, etc.) be sure the voltage supplied is the same as that specified on the nameplate of the tool. A power source with voltage greater than that specified for the tool can result in **SERIOUS INJURY** to the user — as well as damage to the tool. If in doubt, **DO NOT PLUG IN THE TOOL.** Using a power source with voltage less than the nameplate rating is harmful to the motor.

Precautions Before Use

A. Before plugging in the miter saw, use this checklist:

Check Item	Checkpoint
• Is the saw blade installed correctly?	(2)
• Is the saw blade tip contacting the turn base when the blade is fully lowered?	(3)
• Does the safety cover operate smoothly when you raise and lower the head with the operating handle?	(4)
• Is the miter clamp grip tightened firmly?	(5)

B. Set the miter saw on a level bench, sturdy stand or table. If you intend to use the tool in just one spot, fasten it securely by means of bolts in the four mounting feet. Always obtain a steady base for safe, sure cutting action.

C. These miter saws are equipped with a locking stopper which is used to keep the head in the lowered position. To release from the hold-down position, lower the operation handle slightly and turn the lever on the locking stopper to the release position. To lock the head in the hold-down position, lower the operation handle fully and turn the lever on the stopper to the hold position.

HOW TO USE YOUR MAKITA MITER SAW

1. Switch Type and Operation

Your tool has either an ordinary trigger switch (Fig. 1) or with a special lock-off switch button (Fig. 2).

A conventional switch starts the tool simply when you pull the trigger and stops it when the trigger is released. There are three steps in operating a lock-off switch:

1. To start the tool, first press in the lock-off button, then pull the trigger.
2. To stop the tool, simply release the trigger. (The lock-off button pops out.)
3. When the tool is not in use, take off the lock button. The tool cannot be switched on without it.

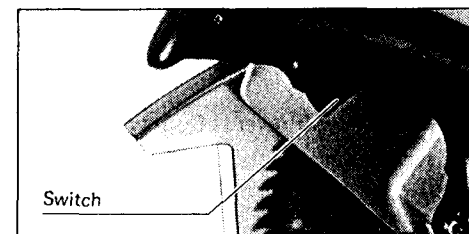

Fig. 1

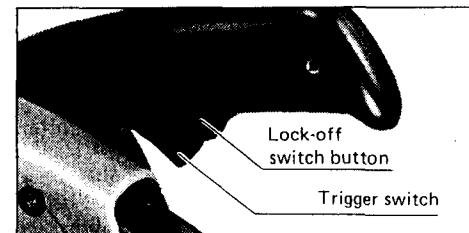

Fig. 2

2. Installing Saw Blade

Press the shaft lock and use the socket wrench provided to loosen the hex bolt which serves to hold the saw blade in place. Then remove the outer flange and install the saw blade on the arbor shaft inside the safety cover.

Model 2401B is equipped with an adaptor ring (16) for a 1" arbor hole. Use this ring to install a Makita blade. Without the ring, there is a 5/8" arbor hole.

3. Adjusting Vertical Position of Blade

The miter saw is factory-adjusted with a standard blade cutting depth for a 255mm (10") saw blade (355mm (14") saw blade for Model LS1410). Thus, IF YOU ARE NOT USING A STANDARD SAW BLADE, loosen the hex nut on the end of the gear housing and use a minus \ominus screwdriver to turn the cutting depth adjustment bolt to the right. Adjust so that when the operating handle is in the fully lowered position there will be a distance of about 122mm (4-13/16") (about 160mm (6-5/16") for Model LS1410) from the front face of the guide fence (guide rule) to the point where the front edge of the blade enters the kerf. (See diagram at right.) This will produce the correct depth adjustment. Then tighten the hex nut.

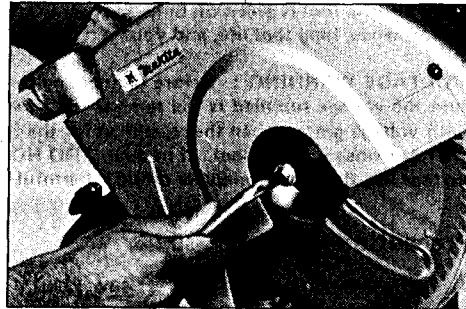

Fig. 3



Fig. 4

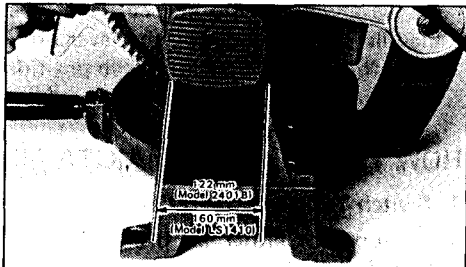

Fig. 5

4. Safety Cover (Prevents Contact with Blade)

The see-through safety cover (lower blade guard) raises as the work is contacted and cutting begins, and it returns to its original position when cutting is completed. Never lock the guard at a fixed position. Always use the guard in the freely telescoping condition for your personal safety. Any irregular operation of the safety guard should be corrected promptly. Never use the miter saw with a faulty guard.

* If the see-through guard becomes dirty or sawdust adheres in such a way that the blade and/or work may not be easily visible, clean it off carefully with a damp cloth. ALWAYS UNPLUG THE TOOL before you perform any cleaning.



Fig. 6

5. Miter Angle Setting

The saw blade should be in the fully raised position before you change the miter angle. Release the miter clamp grip by turning one-half a turn to the left (counterclockwise), then push the grip in the direction of the desired miter angle. Set the pointer to the desired graduation on the calibrated scale, then tighten the grip to the right (clockwise).

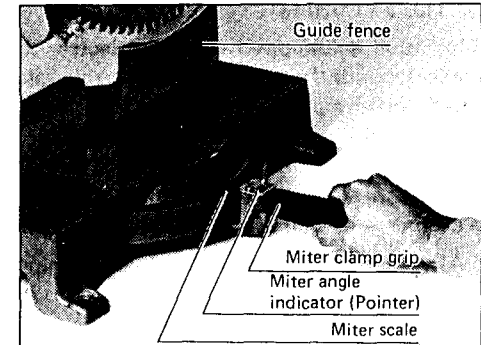

Fig. 7

6. When Cutting 2 by 4 (1-5/8" x 3-1/2"):

For Model 2401B

Cuts of 45 degrees can be done as usual as long as the material is not positioned vertically. To cut vertically positioned material, insert a piece of stock in between as shown right.

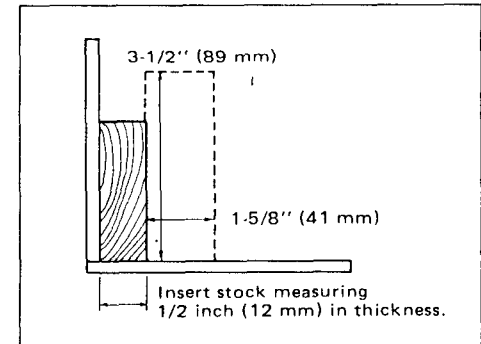

Fig. 8

7. Alignment

This Makita miter saw was carefully adjusted and aligned at the factory, but rough handling during shipment may have affected the alignment. If your miter saw is not aligned properly, perform the following.

* When Slightly Misaligned (Adjusting Pointer)

Loosen the miter clamp grip and place a square or triangular rule against the side of the guide fence and saw blade so as to square the blade to the fence. When this is done and you notice that the pointer on the miter angle indicator is not at zero on the miter scale, gently tighten the miter clamp grip and then loosen the two pan head screws holding the miter angle indicator plate. Adjust so that the pointer will be at zero; then retighten the two screws to fasten the plate in place.

* When Seriously Misaligned (Adjusting Fence)

After zeroing the miter pointer (as shown above) and carefully tightening the miter clamp grip, loosen the four hex bolts holding the guide fence and reposition the fence so that it will be square in relation to the saw blade. This can be done by placing a square or triangular rule against the saw blade and adjusting the fence so that the side contacting the work is absolutely flush with the square or rule. Then, carefully replace the hex bolts and fasten the fence securely. Failure to fasten securely will cause the guide fence to move when a workpiece is pressed up against it by powerful vise action, and thus accuracy will be compromised.

8. Tips on Cutting

This tool is equipped with an electric safety brake which stops the saw blade within three seconds from the moment you release the switch in the operating handle. This safety feature can also be used to advantage, for example, in cutting certain materials like light aluminum or plastics where special shapes are required, or in edge cuts in wood where only a little stock is cut off. In this case, the saw blade is retracted after the blade stops, and the cut end will not be contacted by a spinning blade as in a regular saw. Thus, a cleaner — as well as safer — cut is possible.

* Always keep the table top clear of chips, small pieces and so on in order to maintain a safe, clean surface.

9. Removing Saw Blade

Depressed shaft lock as shown in ① to lock shaft/blade. Next, as seen in ②, use the socket wrench provided to loosen (clockwise) the hex bolt holding the blade in place. The remove the bolt and outer flange. The blade can thus be taken out from the safety cover.

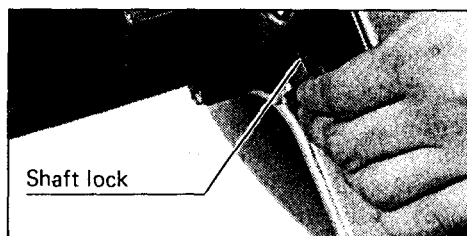

Fig. 9

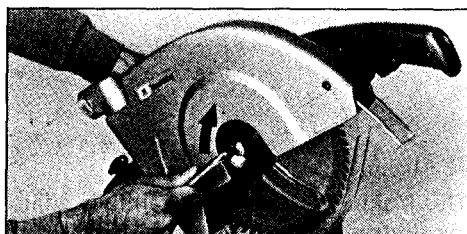

Fig. 10

10. Factory-Adjusted Lock Nut

The hex lock nut holding together the gear housing and arm has been factory-adjusted to assure smooth arm action up and down and to guarantee precise cutting. Do not temper with it.

Should looseness develop at the housing and arm connection, perform the following adjustment. Work the arm vertically while tightening the hex lock nut: the best position to fasten the nut is just before the motor body weight is obvious.

If the nut is too loose, the cutting accuracy will be affected; if it is too tight, it will be hard to work the arm up and down easily. Note that this is a self locking nut; it is a special type that does not remove in the usual manner, and so it should not be over-tightened or replaced with other types.

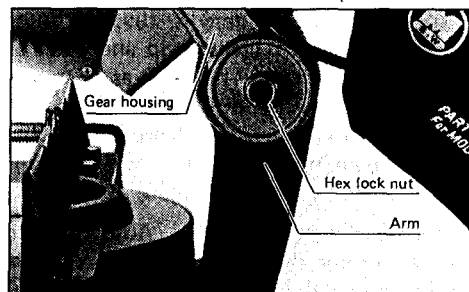

Fig. 11

11. Saw Blade for Aluminum Applications (For Model 2401B only)

Apply oil to the miter saw blade (No. 255-4A) for aluminum cutting, since without it chips will adhere and the cutting edges will deteriorate. Apply oil near the arbor at the center of the blade; centrifugal force will distribute it out to the tips. No oil is required with carbide-tipped blades.

12. Maintenance

• Carbon Brushes

Replace carbon brushes when they wear down to about 6 mm (1/4") or sparking will occur. Both brushes should be changed at the same time.

• Oiling

Clean the tool thoroughly after use.

Apply oil to all sliding surfaces, the base and saw blade as a rust inhibitor.

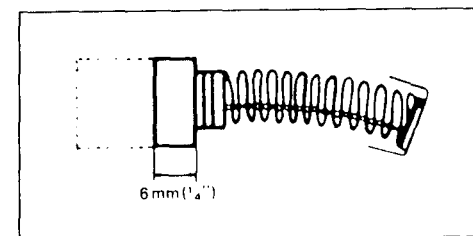

Fig. 12

13. Attaching Optional Dust Bag

Although sawdust ejection can be directed at will by means of the elbow, the use of the dust bag provided makes collection complete and cutting operations.

To attach the dust bag, fit it onto the elbow and turn to the left to lock in place; it releases to the right.



Fig. 13

When the bag is about half full, just unzip the fastener below and empty it, slapping it lightly so as to remove particles adhering to the insides which might hamper collection.

ACCESSORIES

- Dust Bag Part No. 166004-3



• Saw Blades

- Chisel tooth combination saw blade



For rip and cross-cut work.
Most frequently used for general carpentry.

NO.	Dia. (mm)	Hole dia. (mm)	No. teeth	Part No.	For Model
255 - 7	255 (10")	25 (1")	36	721407-4	2401B
260 - 7	260 (10-1/4")			721411-3	

- Miter saw blade



No. 255 - 4 For smooth cutting of wood.
No. 255 - 4A For smooth cutting of aluminum.

NO.	Dia. (mm)	Hole dia. (mm)	No. teeth	Part No.	For Model
255 - 4	255 (10")	25 (1")	100	721404-0	2401B
255 - 4A				721405-8	

- Carbide-tipped saw blade



Faster, smoother, longer sawing
without blade sharpening cuts wood, dry wall,
plastics, hard wood, etc.

NO.	Dia. (mm)	Hole dia. (mm)	No. teeth	Part No.	For Model
* 255 - 11	255 (10")	25 (1")	70	721406-6	2401B
255 - 11A			72	721412-1	
* 355 - 11	355 (14")		100	721611-5	LS1410

- Combination saw blade

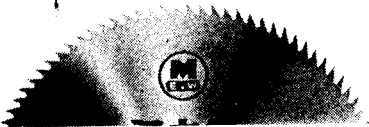

* . . . For aluminum cutting.
For rip and cross-cut work.
Has fewer teeth than cross-cut for faster cutting.

NO.	Dia. (mm)	Hole dia. (mm)	No. teeth	Part No.	For Model
255 - 1.	255 (10")	25 (1")	52	721401-6	2401B
260 - 1	260 (10-1/4")			721409-0	

- Cross-cut saw blade



For smoother cross-grain cuts.
Makes smoother cuts than combination blade.

NO.	Dia. (mm)	Hole dia. (mm)	No. teeth	Part No.	For Model
260 - 2	260 (10-1/4")	25 (1")	80	721410-5	2401B

- Combination saw blade

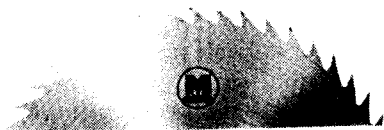

For rip and cross-cut work.
Has fewer teeth than cross-cut for faster cutting.

NO.	Dia. (mm)	Hole dia. (mm)	No. teeth	Part No.	For Model
355 - 1	355 (14")	25 (1")	80	721610-7	LS1410



Makita Electric Works, Ltd.

Anjo, Aichi, Japan

PRINTED IN JAPAN
1979-5-2,000 N

Free Manuals Download Website

<http://myh66.com>

<http://usermanuals.us>

<http://www.somanuals.com>

<http://www.4manuals.cc>

<http://www.manual-lib.com>

<http://www.404manual.com>

<http://www.luxmanual.com>

<http://aubethermostatmanual.com>

Golf course search by state

<http://golfingnear.com>

Email search by domain

<http://emailbydomain.com>

Auto manuals search

<http://auto.somanuals.com>

TV manuals search

<http://tv.somanuals.com>