

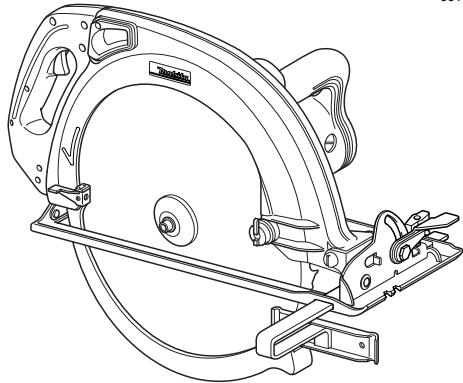

Circular Saw

Equipped with Electric Blade Brake
415 mm (16 - 5/16")
MODEL 5402NA

001963



I N S T R U C T I O N M A N U A L

⚠ WARNING:

For your personal safety, READ and UNDERSTAND before using.
SAVE THESE INSTRUCTIONS FOR FUTURE REFERENCE.

www.makitatools.com

SPECIFICATIONS

| | | |
|-------------------------|--------|--------------------|
| Model | | 5402NA |
| Blade diameter | | 415 mm (16-5/16") |
| Max. cutting capacities | at 90° | 158 mm (6-3/16") |
| | at 45° | 106 mm (4-3/16") |
| No load speed (RPM) | | 2,200/min. |
| Overall length | | 616 mm (24-1/4") |
| Net weight | | 13.0 kg (28.7 lbs) |

- Manufacturer reserves the right to change specifications without notice.
- Specifications may differ from country to country.

GENERAL SAFETY RULES

USA001-2

(For All Tools)

⚠ WARNING:
Read and understand all instructions. Failure to follow all instructions listed below, may result in electric shock, fire and/or serious personal injury.

SAVE THESE INSTRUCTIONS

Work Area

1. **Keep your work area clean and well lit.** Cluttered benches and dark areas invite accidents.
2. **Do not operate power tools in explosive atmospheres, such as in the presence of flammable liquids, gases, or dust.** Power tools create sparks which may ignite the dust or fumes.
3. **Keep bystanders, children, and visitors away while operating a power tool.** Distractions can cause you to lose control.

Electrical Safety

4. **Grounded tools must be plugged into an outlet properly installed and grounded in accordance with all codes and ordinances. Never remove the grounding prong or modify the plug in any way. Do not use any adaptor plugs. Check with a qualified electrician if you are in doubt as to whether the outlet is properly grounded.** If the tools should electrically malfunction or break down, grounding provides a low resistance path to carry electricity away from the user.

5. **Avoid body contact with grounded surfaces such as pipes, radiators, ranges and refrigerators.** There is an increased risk of electric shock if your body is grounded.
6. **Do not expose power tools to rain or wet conditions.** Water entering a power tool will increase the risk of electric shock.
7. **Do not abuse the cord. Never use the cord to carry the tools or pull the plug from an outlet. Keep cord away from heat, oil, sharp edges or moving parts. Replace damaged cords immediately.** Damaged cords increase the risk of electric shock.
8. **When operating a power tool outside, use an outdoor extension cord marked "W-A" or "W".** These cords are rated for outdoor use and reduce the risk of electric shock.

Personal Safety

9. **Stay alert, watch what you are doing and use common sense when operating a power tool. Do not use tool while tired or under the influence of drugs, alcohol, or medication.** A moment of inattention while operating power tools may result in serious personal injury.
10. **Dress properly. Do not wear loose clothing or jewelry. Contain long hair. Keep your hair, clothing, and gloves away from moving parts.** Loose clothes, jewelry, or long hair can be caught in moving parts.
11. **Avoid accidental starting. Be sure switch is off before plugging in.** Carrying tools with your finger on the switch or plugging in tools that have the switch on invites accidents.
12. **Remove adjusting keys or wrenches before turning the tool on.** A wrench or a key that is left attached to a rotating part of the tool may result in personal injury.
13. **Do not overreach. Keep proper footing and balance at all times.** Proper footing and balance enables better control of the tool in unexpected situations.
14. **Use safety equipment. Always wear eye protection.** Dust mask, non-skid safety shoes, hard hat, or hearing protection must

be used for appropriate conditions. Ordinary eye or sun glasses are NOT eye protection.

Tool Use and Care

15. **Use clamps or other practical way to secure and support the workpiece to a stable platform.** Holding the work by hand or against your body is unstable and may lead to loss of control.
16. **Do not force tool. Use the correct tool for your application.** The correct tool will do the job better and safer at the rate for which it is designed.
17. **Do not use tool if switch does not turn it on or off.** Any tool that cannot be controlled with the switch is dangerous and must be repaired.
18. **Disconnect the plug from the power source before making any adjustments, changing accessories, or storing the tool.** Such preventive safety measures reduce the risk of starting the tool accidentally.
19. **Store idle tools out of reach of children and other untrained persons.** Tools are dangerous in the hands of untrained users.
20. **Maintain tools with care. Keep cutting tools sharp and clean.** Properly maintained tools with sharp cutting edges are less likely to bind and are easier to control.
21. **Check for misalignment or binding of moving parts, breakage of parts, and any other condition that may affect the tools operation. If damaged, have the tool serviced before using.** Many accidents are caused by poorly maintained tools.
22. **Use only accessories that are recommended by the manufacturer for your model.** Accessories that may be suitable for one tool, may become hazardous when used on another tool.

SERVICE

23. **Tool service must be performed only by qualified repair personnel.** Service or maintenance performed by unqualified personnel could result in a risk of injury.

24. When servicing a tool, use only identical replacement parts. Follow instructions in the Maintenance section of this manual.

Use of unauthorized parts or failure to follow Maintenance instructions may create a risk of electric shock or injury.

USE PROPER EXTENSION CORD: Use only three-wire extension cords that have three-prong grounding-type plugs and three-pole receptacles that accept the tool's plug. Make sure your extension cord is in good condition. Replace or repair damaged or worn cord immediately. When using an extension cord, be sure to use one heavy enough to carry the current your product will draw. An undersized cord will cause a drop in line voltage resulting in loss of power and overheating. Table 1 shows the correct size to use depending on cord length and nameplate ampere rating. If in doubt, use the next heavier gage. The smaller the gage number, the heavier the cord.

Table 1: Minimum gage for cord

| Ampere Rating | | Volts | Total length of cord in feet | | | |
|---------------|---------------|-------|------------------------------|--------|-----------------|---------|
| | | 120 V | 25 ft. | 50 ft. | 100 ft. | 150 ft. |
| More Than | Not More Than | AWG | | | | |
| 0 | 6 | | 18 | 16 | 16 | 14 |
| 6 | 10 | | 18 | 16 | 14 | 12 |
| 10 | 12 | | 16 | 16 | 14 | 12 |
| 12 | 16 | | 14 | 12 | Not Recommended | |

GROUNDING INSTRUCTIONS

This tool should be grounded while in use to protect the operator from electric shock. The tool is equipped with a three-conductor cord and three-prong grounding type plug to fit the proper grounding type receptacle. The green (or green and yellow) conductor in the cord is the grounding wire. Never connect the green (or green and yellow) wire to a live terminal. Your unit is for use on 120 volts and has a plug that looks like Fig. "A".

An adapter Fig. "B" and "C" is available for connecting Fig. "A" type plugs to two-prong receptacles. The green-colored rigid ear, lug, etc., extending from the adapter must be connected to a permanent ground, such as a properly grounded outlet box.

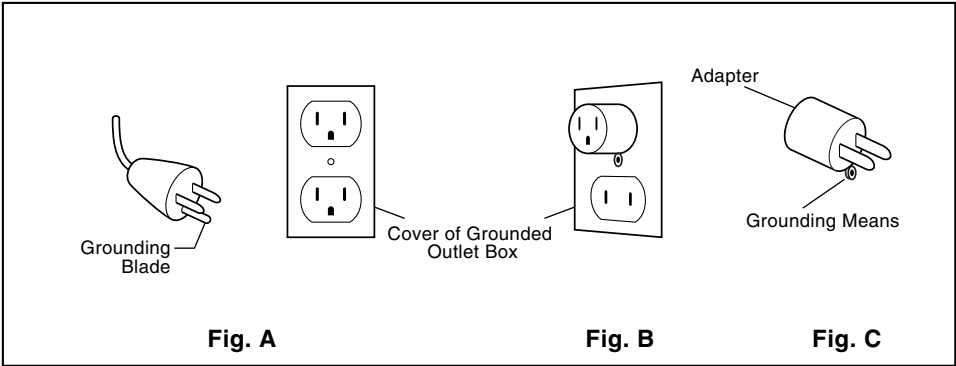

SPECIFIC SAFETY RULES

USB008-5

DO NOT let comfort or familiarity with product (gained from repeated use) replace strict adherence to circular saw safety rules. If you use this tool unsafely or incorrectly, you can suffer serious personal injury.

1. **DANGER! Keep hands away from cutting area and blade. Keep your second hand on auxiliary handle, or motor housing.** If both hands are holding the saw, they cannot be cut by the blade.
Keep your body positioned to either side of the saw blade, but not in line with the saw blade. KICKBACK could cause the saw to jump backwards. (See "Causes and Operator Prevention of Kickback")
Do not reach underneath the work. The guard can not protect you from the blade below the work. Do not attempt to remove cut material when blade is moving.
CAUTION: Blades coast after turn off. Wait until blade stops before grasping cut material.
2. **Check lower guard for proper closing before each use. Do not operate saw if lower guard does not move freely and close instantly. Never clamp or tie the lower guard into the open position.** If saw is accidentally dropped, lower guard may be bent. Raise the lower guard with the Retracting Lever and make sure it moves freely and does not touch the blade or any other part, in all angles and depths of cut.
To check lower guard, open lower guard by hand, then release and watch guard closure. Also check to see that Retracting Lever does not touch tool housing. Leaving blade exposed is VERY DANGEROUS and can lead to serious personal injury.
3. **Check the operation and condition of the lower guard spring. If the guard and the spring are not operating properly, they must be serviced before use.** Lower guard may operate sluggishly due to damaged parts, gummy deposits, or a buildup of debris.
4. **Lower guard should be retracted manually only for special cuts such as "Pocket Cuts" and "Compound Cuts." Raise lower guard by Retracting Lever. As soon as blade enters the material, lower guard must be released.** For all other sawing, the lower guard should operate automatically.
5. **Always observe that the lower guard is covering the blade before placing saw down on bench or floor.** An unprotected, coasting blade will cause the saw to walk backwards, cutting whatever is in its path. Be aware of the time it takes for the blade to stop after switch is released.
6. **NEVER hold piece being cut in your hands or across your leg.** It is important to support the work properly to minimize body exposure, blade binding, or loss of control.
7. **Hold tool by insulated gripping surfaces when performing an operation where the cutting tool may contact hidden wiring or its own cord.** Contact with a "live" wire will also make exposed metal parts of the tool "live" and shock the operator.
8. **When ripping always use a rip fence or straight edge guide.** This improves the accuracy of cut and reduces the chance for blade binding.
9. **Always use blades with correct size and shape (diamond vs. round) arbor holes.** Blades that do not match the mounting hardware of the saw will run eccentrically, causing loss of control.
10. **Never use damaged or incorrect blade washers or bolts.** The blade washers and bolt were specially designed for your saw, for optimum performance and safety of operation.

11. Causes and Operator Prevention of Kickback:

Kickback is a sudden reaction to a pinched, bound or misaligned saw blade, causing an uncontrolled saw to lift up and out of the workpiece toward the operator.

When the blade is pinched or bound tightly by the kerf closing down, the blade stalls and the motor reaction drives the unit rapidly back toward the operator.

If the blade becomes twisted or misaligned in the cut, the teeth at the back edge of the blade can dig into the top surface of the wood causing the blade to climb out of the kerf and jump back toward operator.

Kickback is the result of tool misuse and/or incorrect operating procedures or conditions and can be avoided by taking proper precautions as given below:

Maintain a firm grip with both hands on the saw and position your body and arm to allow you to resist KICKBACK forces. KICKBACK forces can be controlled by the operator, if proper precautions are taken.

When blade is binding, or when interrupting a cut for any reason, release the trigger and hold the saw motionless in the material until the blade comes to a complete stop. Never attempt to remove the saw from the work or pull the saw backward while the blade is in motion or KICKBACK may occur. Investigate and take corrective actions to eliminate the cause of blade binding.

When restarting a saw in the workpiece, center the saw blade in the kerf and check that saw teeth are not engaged into the material. If saw blade is binding, it may walk up or KICKBACK from the workpiece as the saw is restarted.

Support large panels to minimize the risk of blade pinching and KICKBACK. Large panels tend to sag under their own weight. Supports must be placed under the panel on both sides, near the line of cut and near the edge of the panel as shown in **Fig. 1**.

To minimize the risk of blade pinching and kickback. When cutting operation requires

the resting of the saw on the workpiece, the saw should be rested on the larger portion and the smaller piece cut off.

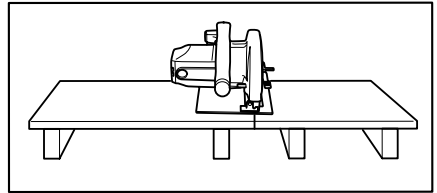

Fig. 1 To avoid kickback, do support board or panel near the cut.

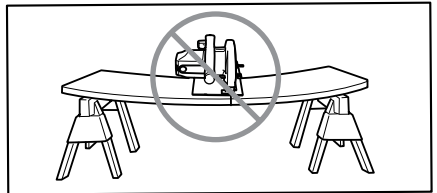

Fig. 2 Do not support board or panel away from the cut.

Do not use dull or damaged blade.

Unsharpened or improperly set blades produce narrow kerf causing excessive friction, blade binding and KICKBACK. Keep blade sharp and clean. Gum and wood pitch hardened on blades slows saw and increases potential for kickback. Keep blade clean by first removing it from tool, then cleaning it with gum and pitch remover, hot water or kerosene. Never use gasoline.

Blade depth and bevel adjusting locking levers must be tight and secure before making cut. If blade adjustment shifts while cutting, it may cause binding and KICKBACK.

Use extra caution when making a "Pocket Cut" into existing walls or other blind areas. The protruding blade may cut objects that can cause KICKBACK. For pocket cuts, retract lower guard using Retracting Lever.

ALWAYS hold the tool firmly with both hands. NEVER place your hand or fingers behind the saw. If kickback occurs, the saw

could easily jump backwards over your hand, leading to serious personal injury.

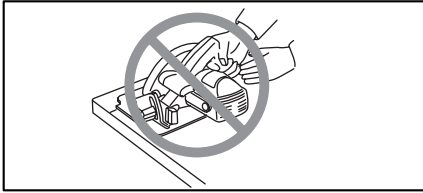

Fig. 3

Never force the saw. Forcing the saw can cause uneven cuts, loss of accuracy, and possible kickback. Push the saw forward at a speed so that the blade cuts without slowing.

12. **Use extra caution when cutting damp wood, pressure treated lumber, or wood containing knots.** Adjust speed of cut to maintain smooth advancement of tool without decrease in blade speed.
13. **Adjustments.** Before cutting be sure depth and bevel adjustments are tight.
14. **Avoid Cutting Nails.** Inspect for and remove all nails from lumber before cutting.
15. **When operating the saw, keep the cord away from the cutting area and position it so that it will not be caught on the workpiece during the cutting operation.** The tool is provided with a front grip and rear handle for two hand operation. Operate with proper hand support, proper workpiece support, and supply cord routing away from the work area.
WARNING: It is important to support the workpiece properly and to hold the saw firmly to prevent loss of control which

could cause personal injury. Fig. 4 illustrates typical hand support of the saw.

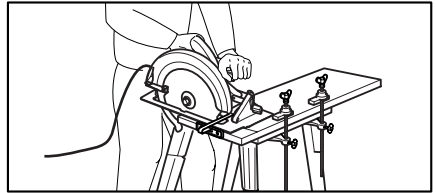

Fig. 4 A typical illustration of proper hand support, workpiece support, and supply cord routing.

16. **Place the wider portion of the saw base on that part of the workpiece which is solidly supported, not on the section that will fall off when the cut is made.** As examples, Fig. 5 illustrates the **RIGHT** way to cut off the end of a board, and Fig. 6 the **WRONG** way. If the workpiece is short or small, clamp it down. **DO NOT TRY TO HOLD SHORT PIECES BY HAND!**

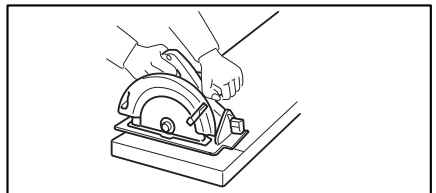

Fig. 5

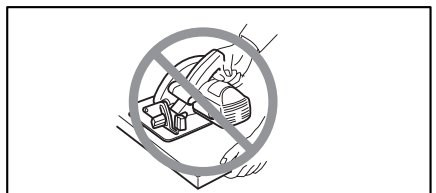

Fig. 6

17. **Never attempt to saw with the circular saw held upside down in a vise.** This is

extremely dangerous and can lead to serious accidents.

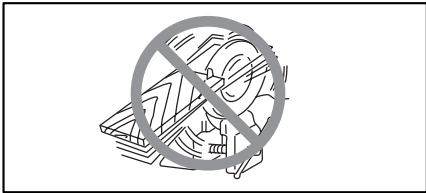

Fig. 7

18. **WARNING:** Blade coasts to stop after switch is released. Contact with coasting blade can cause serious injury. Before setting the tool down after completing a cut, be sure that the lower (telescoping) guard has closed and the blade has come to a complete stop.
19. Some material contains chemicals which may be toxic. Take caution to prevent dust inhalation and skin contact. Follow material supplier safety data.



SAVE THESE INSTRUCTIONS

⚠ WARNING:
MISUSE or failure to follow the safety rules stated in this instruction manual may cause serious personal injury.

SYMBOLS

USD101-2

The followings show the symbols used for tool.

- | | | | |
|-----------------|---------|---|---|
| V | volts |  | alternating current |
| A | amperes |  | no load speed |
| Hz | hertz | .../min | revolutions or reciprocation per minute |

FUNCTIONAL DESCRIPTION

CAUTION:

- Always be sure that the tool is switched off and unplugged before adjusting or checking function on the tool.

Adjusting depth of cut

CAUTION:

- After adjusting the depth of cut, always tighten the lever securely.

Loosen the lever on the depth guide and move the base up or down. At the desired depth of cut, secure the base by tightening the lever.

For cleaner, safer cuts, set cut depth so that no more than one blade tooth projects below workpiece. Using proper cut depth helps to reduce potential for dangerous KICKBACKS which can cause personal injury.

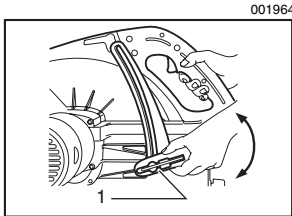

1. Lever

Bevel cutting

Loosen the lever on the bevel scale plate on the front of the base and the clamping screw on the back.

Set for the desired angle (0° - 45°) by tilting accordingly, then tighten the lever and the clamping screw securely.

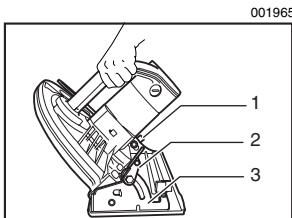

1. Clamp screw

2. Lever

3. Bevel scale plate

Blade steady device

In general way, use the lock lever by setting it in locked position.

To lock the lock lever, push it down and turn it 90° counter-clockwise. To release the lock lever, turn it 90° clockwise. When you replace a saw blade, release the lock lever.

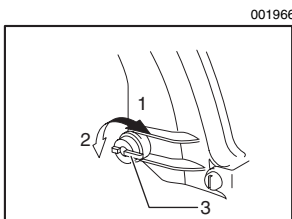

1. Release

2. Lock

3. Lock lever

001967

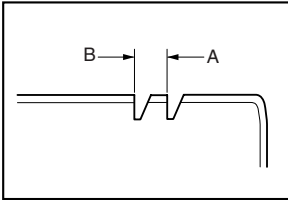

Sighting

For straight cuts, align the A position on the front of the base with your cutting line. For 45° bevel cuts, align the B position with it.

001968

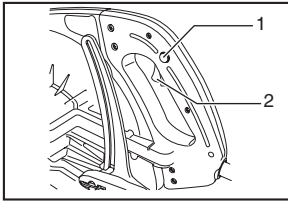

1. Lock-off button
2. Switch trigger

Switch action

⚠ CAUTION:

- Before plugging in the tool, always check to see that the switch trigger actuates properly and returns to the “OFF” position when released.

To prevent the switch trigger from being accidentally pulled, a lock-off button is provided.

To start the tool, push in the lock-off button and pull the switch trigger. Release the switch trigger to stop.

Electric brake

This tool is equipped with an electric blade brake. If the tool consistently fails to quickly stop blade after switch trigger release, have tool serviced at a Makita service center.

The blade brake system is not a substitute for lower guard. **NEVER USE TOOL WITHOUT A FUNCTIONING LOWER GUARD. SERIOUS PERSONAL INJURY CAN RESULT.**

ASSEMBLY

001969

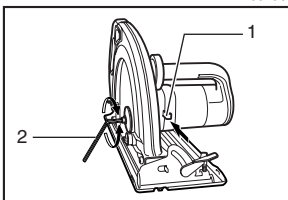

1. Shaft lock
2. Hex wrench

⚠ CAUTION:

- Always be sure that the tool is switched off and unplugged before carrying out any work on the tool.

Removing or installing saw blade

⚠ CAUTION:

- Be sure the blade is installed with teeth pointing up at the front of the tool.
- Use only the Makita wrench to install or remove the blade.

Release the lock lever of blade steady device.

001970

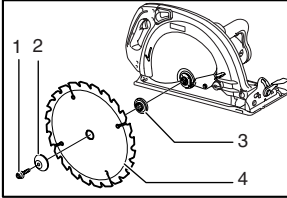

1. Hex bolt
2. Outer flange
3. Inner flange
4. Saw blade

To remove the blade, press the shaft lock so that the blade cannot revolve and use the wrench to loosen the hex bolt counterclockwise. Then remove the hex bolt, outer flange and blade.

To install the blade, follow the removal procedure in reverse. **BE SURE TO TIGHTEN THE HEX BOLT CLOCKWISE SECURELY.**

After installing the blade, lock the lock lever.

When changing blade, make sure to also clean upper and lower blade guards of accumulated sawdust. Such efforts do not, however, replace the need to check lower guard operation before each use.

⚠ CAUTION:

- The inner flange has a 25 mm (63/64") diameter on one side and a 25.4 mm (1") diameter on the other. The side with 25.4 mm (1") diameter is marked by "25.4". Use the correct side for the hole diameter of the blade you intend to use. Mounting the blade on the wrong side can result in dangerous vibration.

001971

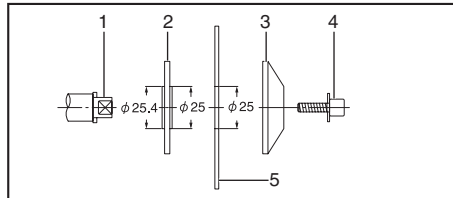

1. Mounting shaft
2. Inner flange
3. Outer flange
4. Hex bolt
5. Blade

001972

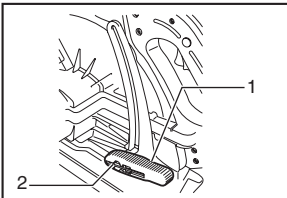

1. Lever
2. Hex wrench

Hex wrench storage

When not in use, store the hex wrench as shown in the figure to keep it from being lost.

001973

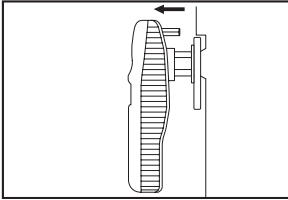

To remove the hex wrench, push the shorter side of it out with your finger. Then remove the hex wrench.

001974

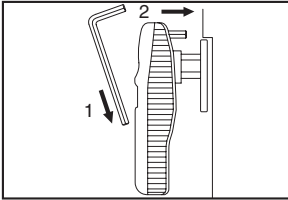

To store the hex wrench, insert the longer side of it into the lever. Then push the shorter side of it down.

OPERATION

⚠ CAUTION:

- Be sure to move the tool forward in a straight line gently. Forcing or twisting the tool will result in overheating the motor and dangerous kickback, possibly causing severe injury.
- Grasp the rear handle and the front grip firmly when starting or stopping the tool, since there is an initial and final reaction.

001975

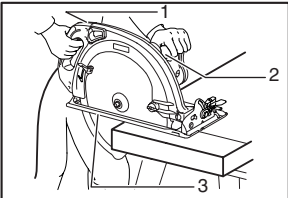

1. Rear handle
2. Front grip
3. Base

Hold the tool firmly. The tool is provided with both a front grip and rear handle. Use both to best grasp the tool. If both hands are holding saw, they cannot be cut by the blade. Set the base on the workpiece to be cut without the blade making any contact. Then turn the tool on and wait until the blade attains full speed. Now simply move the tool forward over the workpiece surface, keeping it flat and advancing smoothly until the sawing is completed.

To get clean cuts, keep your sawing line straight and your speed of advance uniform. If the cut fails to properly follow your intended cut line, do not attempt to turn or force the tool back to the cut line. Doing so may bind the blade and lead to dangerous kickback and possible serious injury. Release switch, wait for blade to stop and then withdraw tool. Realign tool on new cut line, and start cut again. Attempt to avoid positioning which exposes operator to chips and wood dust being ejected from saw. Use eye protection to help avoid injury.

001976

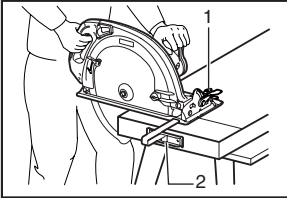

1. Clamp screw
2. Rip fence (Guide rule)

Rip fence (Guide rule)

The handy rip fence allows you to do extra-accurate straight cuts. Simply slide the rip fence up snugly against the side of the workpiece and secure it in position with the screw on the front of the base. It also makes repeated cuts of uniform width possible.

MAINTENANCE

⚠ CAUTION:

- Always be sure that the tool is switched off and unplugged before attempting to perform inspection or maintenance.

001977

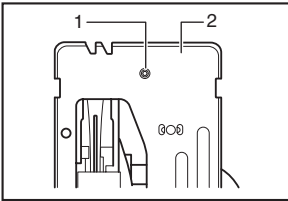

1. Adjusting screw
2. Base

Adjusting for accuracy of 90° cut (vertical cut)

This adjustment has been made at the factory. But if it is off, adjust the adjusting screw with the hex wrench while squaring the blade with the base using a triangular rule, try square, etc.

001978

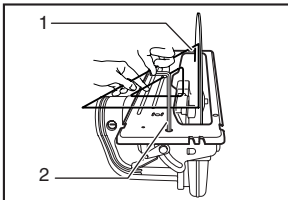

1. Triangular rule
2. Hex wrench

001145

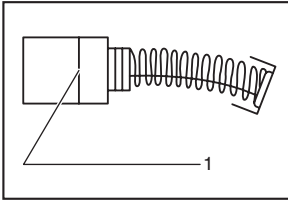

1. Limit mark

Replacing carbon brushes

Remove and check the carbon brushes regularly. Replace when they wear down to the limit mark. Keep the carbon brushes clean and free to slip in the holders. Both carbon brushes should be replaced at the same time. Use only identical carbon brushes.

001979

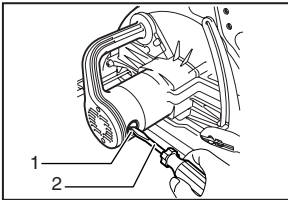

1. Brush holder cap
2. Screwdriver

Use a screwdriver to remove the brush holder caps. Take out the worn carbon brushes, insert the new ones and secure the brush holder caps.

After replacing brushes, plug in the tool and break in brushes by running tool with no load for about 10 minutes. Then check the tool while running and electric brake operation when releasing the switch trigger. If electric brake is not working well, ask your local Makita service center for repair.

To maintain product SAFETY and RELIABILITY, repairs, any other maintenance or adjustment should be performed by Makita Authorized or Factory Service Centers, always using Makita replacement parts.

ACCESSORIES

⚠ CAUTION:

- These accessories or attachments are recommended for use with your Makita tool specified in this manual. The use of any other accessories or attachments might present a risk of injury to persons. Only use accessory or attachment for its stated purpose.

If you need any assistance for more details regarding these accessories, ask your local Makita service center.

- Steel & Carbide-tipped saw blades

| | |
|--------------|--|
| Combination | General purpose blade for fast and smooth rip, crosscuts and miters. |
| Crosscutting | For smoother cross grain cuts. Slices cleanly against grain. |
| Rip-cutting | Fast cuts with the grain. Large teeth for better chip clearance and minimal binding. |

- Rip fence (Guide rule)
- Hex wrench 6

Memo

[illegible]

Cut



First-Class
Postage
Required

Post Office will
not deliver
without proper
postage.

Makita U.S.A., Inc.
14930 Northam Street
La Mirada, CA 90638-5753



Fold

MAIL THIS PORTION

Your answers to the following questions are appreciated.

1. This product was purchased from:

- ☐ Home Center
- ☐ Hardware/Lumber Store
- ☐ Tool Distributor
- ☐ Industrial Supply
- ☐ Construction Supply
- ☐ Other ()

3. How did you learn about this product:

- ☐ Magazine
- ☐ From Dealer
- ☐ Newspaper
- ☐ Store Display
- ☐ Catalog
- ☐ Radio
- ☐ Exhibition
- ☐ From Friend
- ☐ Previous Usage
- ☐ Other ()

2. Use of the product is intended for:

- ☐ Construction Trade
- ☐ Industrial Maintenance
- ☐ Home Maintenance
- ☐ Hobby
- ☐ Other ()

4. Most favored points are:

- ☐ Design
- ☐ Features
- ☐ Size
- ☐ Price
- ☐ Makita Brand
- ☐ Repair Service
- ☐ Durability
- ☐ Power
- ☐ Other ()

5. Any comments:

| | | | | | | | | | | | | | | | | | | | | | | | | | | | | | | | |
|----------------|--|--|--|----------------------|--|--|--|-------------------|--|--|--|--------------------------|--|--|--|-------------------|--|-------------|--|-------------------|--|-------------|--|---------------------|--|--|--|-------------|--|--|--|
| DATE PURCHASED | | | | | | | | | | | | MODEL NO. | | | | | | | | | | | | | | | | | | | |
| MONTH | | | | DAY | | | | YEAR | | | | SERIAL NO. | | | | | | | | | | | | | | | | | | | |
| <div></div> | | | | <div></div> | | | | <div></div> | | | | | | | | | | | | | | | | | | | | | | | |
| INTL. | | | | | | | | | | | | LAST NAME / COMPANY NAME | | | | | | | | | | | | STATUS | | | | SEX | | | |
| | | | | | | | | | | | | | | | | | | | | | | | | Married Single | | | | M F | | | |
| <div></div> | | | | | | | | | | | | <div></div> | | | | | | | | | | | | <div></div> | | | | <div></div> | | | |
| STREET ADDRESS | | | | | | | | | | | | | | | | | | | | | | | | | | | | | | | |
| CITY | | | | | | | | | | | | | | | | | | | | | | | | | | | | | | | |
| STATE | | | | ZIP CODE | | | | | | | | PHONE | | | | AREA CODE | | | | | | | | | | | | | | | |
| <div></div> | | | | <div></div> | | | | | | | | <div></div> | | | | <div></div> | | <div></div> | | <div></div> | | <div></div> | | | | | | | | | |
| AGE: | | | | <div></div> Under 19 | | | | <div></div> 20-29 | | | | <div></div> 30-39 | | | | <div></div> 40-49 | | | | <div></div> 50-60 | | | | <div></div> Over 60 | | | | | | | |

BE SURE TO COMPLETE THE CUSTOMER'S PORTION OF THIS FORM AND RETAIN FOR YOUR RECORDS.

Please return this portion by facsimile or mail.

Facsimile No: (714) 522-8133

FACTORY SERVICE CENTERS

1-800-4-MAKITA

RETAIN THIS PORTION FOR YOUR RECORDS

| | | | |
|---|---|--|--|
| ARIZONA 3707 E. Broadway Rd., Ste. 6 Phoenix, AZ 85040 (602) 437-2850 | FLORIDA 750 East Sample Road Pompano Beach, FL 33064 (954) 476-6333 | MISSOURI 9876 Watson Road St. Louis, MO 63126-2221 (314) 909-9889 | PENNSYLVANIA 1704 Babcock Blvd. Pittsburgh, PA 15209 (412) 822-7370 |
| CALIFORNIA 41850 Christy St. Fremont, CA 94538-5107 (510) 657-9881 | GEORGIA 4680 River Green Parkway NW Duluth, GA 30096 (770) 476-8911 | NEBRASKA 4129 S. 84th St. Omaha, NE 68127 (402) 597-2925 | PUERTO RICO 200 Guayama St. Hato Rey, PR 00917 (787) 250-8776 |
| 14930 Northam St. La Mirada, CA 90638-5753 (714) 522-8088 | ILLINOIS 1450 Feehanville Dr. Mt. Prospect, IL 60056-6011 (847) 297-3100 | NEVADA 3375 S. Decatur Blvd. Suites. 22 - 24 Las Vegas, NV 89102 (702) 368-4277 | TENNESSEE 1120 Elm Hill P. Suile 170 Nashville, TN 372 (615) 248-3321 |
| 1970 Fulton Avenue Sacramento, CA 95825 (916) 482-5197 | MARYLAND 7397 Washington Boulevard, Suite 104 Elkridge, MD 21075 (410) 796-4401 | NEW JERSEY 251 Herrod Blvd. Dayton, NJ 08810-1539 (609) 655-1212 | TEXAS 12801 Stemmons Fwy Ste. 809 Farmers Branch, TX 75234 (972) 243-1150 |
| 16735 Satcoy St., Ste. 105 Van Nuys, CA 91406 (818) 782-2440 | MASSACHUSETTS 232 Providence Hwy. Westwood, MA 02090 (781) 461-9754 | NEW YORK 4917 Genessee Street Cheektowaga, NY 14225 (716) 685-9503 | 12701 Directors Dr. Stafford, TX 77477-3701 (281) 565-8665 |
| COLORADO 11839 E. 51st Ave. Denver, CO 80239-2709 (303) 371-2850 | MINNESOTA 6427 Penn Ave. South Richfield, MN 55423 (612) 869-5199 | OREGON 828 19th Avenue, N.W. Portland, OR 97209 (503) 222-1823 | 3453 IH-35 North, Ste. 101 San Antonio, TX 78219 (210) 228-0676 |
| | | | WISCONSIN Lincoln Plaza Shopping Ctr. 2245 S. 108th St. West Allis, WI 53227 (414) 541-4776 |

CUSTOMER'S RECORD

| | |
|--|-------------------------|
| When you need service: Send complete tool (prepaid) to one of the Makita Factory Service Centers listed, or to an Authorized Makita Service Center. Be sure to attach a letter to the outside of the carton detailing the problem with your tool. | Date Purchased |
| | Dealer's Name & Address |
| | |
| | Model No. |
| | Serial No. |

WARNING

Some dust created by power sanding, sawing, grinding, drilling, and other construction activities contains chemicals known to the State of California to cause cancer, birth defects or other reproductive harm. Some examples of these chemicals are:

- lead from lead-based paints,
- crystalline silica from bricks and cement and other masonry products, and
- arsenic and chromium from chemically-treated lumber.

Your risk from these exposures varies, depending on how often you do this type of work. To reduce your exposure to these chemicals: work in a well ventilated area, and work with approved safety equipment, such as those dust masks that are specially designed to filter out microscopic particles.

MAKITA LIMITED ONE YEAR WARRANTY

Warranty Policy

Every Makita tool is thoroughly inspected and tested before leaving the factory. It is warranted to be free of defects from workmanship and materials for the period of ONE YEAR from the date of original purchase. Should any trouble develop during this one year period, return the COMPLETE tool, freight prepaid, to one of Makita's Factory or Authorized Service Centers. If inspection shows the trouble is caused by defective workmanship or material, Makita will repair (or at our option, replace) without charge.

This Warranty does not apply where:

- repairs have been made or attempted by others:
- repairs are required because of normal wear and tear:
- the tool has been abused, misused or improperly maintained:
- alterations have been made to the tool.

IN NO EVENT SHALL MAKITA BE LIABLE FOR ANY INDIRECT, INCIDENTAL OR CONSEQUENTIAL DAMAGES FROM THE SALE OR USE OF THE PRODUCT. THIS DISCLAIMER APPLIES BOTH DURING AND AFTER THE TERM OF THIS WARRANTY.

MAKITA DISCLAIMS LIABILITY FOR ANY IMPLIED WARRANTIES, INCLUDING IMPLIED WARRANTIES OF "MERCHANTABILITY" AND "FITNESS FOR A SPECIFIC PURPOSE," AFTER THE ONE YEAR TERM OF THIS WARRANTY.

This Warranty gives you specific legal rights, and you may also have other rights which vary from state to state. Some states do not allow the exclusion or limitation of incidental or consequential damages, so the above limitation or exclusion may not apply to you. Some states do not allow limitation on how long an implied warranty lasts, so the above limitation may not apply to you.

Makita Corporation
3-11-8, Sumiyoshi-cho,
Anjo, Aichi 446-8502 Japan

Free Manuals Download Website

<http://myh66.com>

<http://usermanuals.us>

<http://www.somanuals.com>

<http://www.4manuals.cc>

<http://www.manual-lib.com>

<http://www.404manual.com>

<http://www.luxmanual.com>

<http://aubethermostatmanual.com>

Golf course search by state

<http://golfingnear.com>

Email search by domain

<http://emailbydomain.com>

Auto manuals search

<http://auto.somanuals.com>

TV manuals search

<http://tv.somanuals.com>