

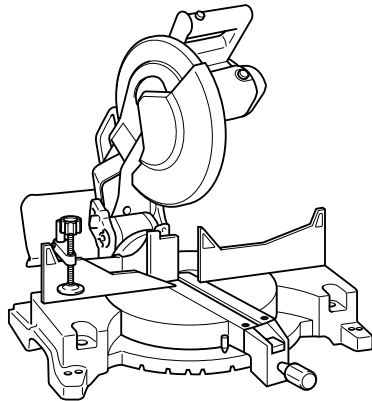

Compound Miter Saw

Equipped with Electric Blade Brake
305 mm (12")
MODEL LS1221



I N S T R U C T I O N M A N U A L

⚠ WARNING:

For your personal safety, READ and UNDERSTAND before using.
SAVE THESE INSTRUCTIONS FOR FUTURE REFERENCE.

www.makitatools.com

SPECIFICATIONS

Blade diameter : 305 mm (12")

Hole diameter : 25.4 mm (1")

Max. Miter angle : Left 48°, Right 48°

Max. Bevel angle : Left 45°

Max. Cutting capacities (H x W)

Bevel angle	Miter angle	
	0°	45° (left and right)
0°	98 mm x 153 mm (3-7/8" x 6") 63.5 mm x 203 mm (2-1/2" x 8")	98 mm x 107 mm (3-7/8" x 4-1/4") 63.5 mm x 143 mm (2-1/2" x 5-5/8")
45° (left)	70 mm x 149 mm (2-3/4" x 5-7/8") 44.5 mm x 200 mm (1-3/4" x 7-7/8")	44.5 mm x 130 mm (*Left) (1-3/4" x 5-1/8") 44.5 mm x 140 mm (*Right) (1-3/4" x 5-1/2")

No load speed (RPM) : 4,000/min.

Dimensions (L x W x H) :674 mm x 610 mm x 607 mm (26-1/2" x 24" x 23-7/8")

Net weight : 16.5 kg (36.4 lbs)

- Manufacturer reserves the right to change specifications without notice.
- Specifications may differ from country to country.

For Your Own Safety Read Instruction Manual Before Operating Tool Save it for future reference GENERAL SAFETY PRECAUTIONS

USA007-1

(For All Tools)

1. **KNOW YOUR POWER TOOL.** Read the owner's manual carefully. Learn the tool's applications and limitations, as well as the specific potential hazards peculiar to it.
2. **KEEP GUARDS IN PLACE** and in working order.
3. **REMOVE ADJUSTING KEYS AND WRENCHES.** Form habit of checking to see that keys and adjusting wrenches are removed from tool before turning it on.
4. **KEEP WORK AREA CLEAN.** Cluttered areas and benches invite accidents.

-
5. **DON'T USE IN DANGEROUS ENVIRONMENT.** Don't use power tools in damp or wet locations, or expose them to rain. Keep work area well lighted. Don't use tool in presence of flammable liquids or gases.
 6. **KEEP CHILDREN AWAY.** All visitors should be kept safe distance from work area.
 7. **MAKE WORKSHOP KID PROOF** with padlocks, master switches, or by removing starter keys.
 8. **DON'T FORCE TOOL.** It will do the job better and safer at the rate for which it was designed.
 9. **USE RIGHT TOOL.** Don't force tool or attachment to do a job for which it was not designed.
 10. **WEAR PROPER APPAREL.** Do not wear loose clothing, gloves, neckties, rings, bracelets, or other jewelry which may get caught in moving parts. Nonslip footwear is recommended. Wear protective hair covering to contain long hair.
 11. **ALWAYS USE SAFETY GLASSES.** Also use face or dust mask if cutting operation is dusty. Everyday eyeglasses only have impact resistant lenses, they are NOT safety glasses.
 12. **SECURE WORK.** Use clamps or a vise to hold work when practical. It's safer than using your hand and it frees both hands to operate tool.
 13. **DON'T OVERREACH.** Keep proper footing and balance at all times.
 14. **MAINTAIN TOOLS WITH CARE.** Keep tools sharp and clean for best and safest performance. Follow instructions for lubricating and changing accessories.
 15. **DISCONNECT TOOLS** before servicing; when changing accessories such as blades, bits, cutters, and the like.
 16. **REDUCE THE RISK OF UNINTENTIONAL STARTING.** Make sure switch is in off position before plugging in.
 17. **USE RECOMMENDED ACCESSORIES.** Consult the owner's manual for recommended accessories. The use of improper accessories may cause risk of injury to persons.
 18. **NEVER STAND ON TOOL.** Serious injury could occur if the tool is tipped or if the cutting tool is unintentionally contacted.
 19. **CHECK DAMAGED PARTS.** Before further use of the tool, a guard or other part that is damaged should be carefully checked to determine that it will operate properly and perform its intended function - check for alignment of moving parts, binding of moving parts, breakage of parts, mounting, and any other conditions that may affect its operation. A guard or other part that is damaged should be properly repaired or replaced.
 20. **DIRECTION OF FEED.** Feed work into a blade or cutter against the direction of rotation of the blade or cutter only.
 21. **NEVER LEAVE TOOL RUNNING UNATTENDED. TURN POWER OFF.** Don't leave tool until it comes to a complete stop.
 22. **REPLACEMENT PARTS.** When servicing use only identical replacement parts.
 23. **POLARIZED PLUGS.** To reduce the risk of electric shock, this equipment has a polarized plug (one blade is wider than the other). This plug will fit in a polarized outlet only one way. If the plug does not fit fully in the outlet, reverse the plug. If it still does not fit, contact a qualified electrician to install the proper outlet. Do not change the plug in any way.

VOLTAGE WARNING: Before connecting the tool to a power source (receptacle, outlet, etc.) be sure the voltage supplied is the same as that specified on the nameplate of the tool. A power source with voltage greater than that specified for the tool can result in **SERIOUS INJURY** to the user - as well as damage to the tool. If in doubt, **DO NOT PLUG IN THE TOOL**. Using a power source with voltage less than the nameplate rating is harmful to the motor.

USE PROPER EXTENSION CORD. Make sure your extension cord is in good condition. When using an extension cord, be sure to use one heavy enough to carry the current your product will draw. An undersized cord will cause a drop in line voltage resulting in loss of power and overheating. Table 1 shows the correct size to use depending on cord length and nameplate ampere rating. If in doubt, use the next heavier gage. The smaller the gage number, the heavier the cord.

Table 1: Minimum gage for cord

Ampere Rating		Volts	Total length of cord in feet			
		120 V	25 ft.	50 ft.	100 ft.	150 ft.
More Than	Not More Than	AWG				
0	6		18	16	16	14
6	10		18	16	14	12
10	12		16	16	14	12
12	16		14	12	Not Recommended	

ADDITIONAL SAFETY RULES

USB037-2

DO NOT let comfort or familiarity with product (gained from repeated use) replace strict adherence to miter saw safety rules. If you use this tool unsafely or incorrectly, you can suffer serious personal injury.

1. Wear eye protection.
2. Keep hands out of path of saw blade. Avoid contact with any coasting blade. It can still cause severe injury.
3. Do not operate saw without guards in place. Check blade guard for proper closing before each use. Do not operate saw if blade guard does not move freely and close instantly. Never clamp or tie the blade guard into the open position.
4. Do not perform any operation freehand. The workpiece must be secured firmly against the turn base and guide fence with a vise during all operations. Never use your hand to secure the workpiece.
5. Never reach around saw blade.
6. Turn off tool and wait for saw blade to stop before moving workpiece or changing settings.
7. Unplug tool before changing blade or servicing.
8. Always secure all moving portions before carrying the tool.

9. Do not use the tool in the presence of flammable liquids or gases.
10. Check the blade carefully for cracks or damage before operation. Replace cracked or damaged blade immediately. Gum and wood pitch hardened on blades slows saw and increases potential for kickback. Keep blade clean by first removing it from tool, then cleaning it with gum and pitch remover, hot water or kerosene. Never use gasoline to clean blade.
11. Use only flanges specified for this tool.
12. Be careful not to damage the arbor, flanges (especially the installing surface) or bolt. Damage to these parts could result in blade breakage.
13. Make sure that the turn base is properly secured so it will not move during operation. Use the holes in the base to fasten the saw to a stable work platform or bench. NEVER use tool where operator positioning would be awkward.
14. For your safety, remove the chips, small pieces, etc. from the table top before operation.
15. Avoid cutting nails. Inspect for and remove all nails from the workpiece before operation.
16. Make sure the shaft lock is released before the switch is turned on.
17. Be sure that the blade does not contact the turn base in the lowest position.
18. Hold the handle firmly. Be aware that the saw moves up or down slightly during start-up and stopping.
19. Make sure the blade is not contacting the workpiece before the switch is turned on.
20. Before using the tool on an actual workpiece, let it run for a while. Watch for vibration or wobbling that could indicate poor installation or a poorly balanced blade.
21. Wait until the blade attains full speed before cutting.
22. Stop operation immediately if you notice anything abnormal.
23. Do not attempt to lock the trigger in the on position.
24. Be alert at all times, especially during repetitive, monotonous operations. Do not be lulled into a false sense of security. Blades are extremely unforgiving.
25. Always use accessories recommended in this manual. Use of improper accessories such as abrasive wheels may cause an injury.
26. NEVER hold workpiece on right side of blade with left hand or vice versa. This is called cross-armed cutting and exposes user to risk of **SERIOUS PERSONAL INJURY** as shown in the figure. ALWAYS use vise to secure workpiece.

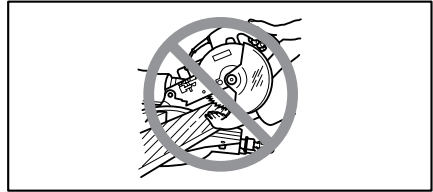

27. Do not abuse cord. Never yank cord to disconnect it from the receptacle. Keep cord away from heat, oil, water and sharp objects.
28. NEVER stack workpieces on the table top to speed cutting operations. Cut only one piece at a time.
29. Some material contains chemicals which may be toxic. Take caution to prevent dust inhalation and skin contact. Follow material supplier safety data.

SAVE THESE INSTRUCTIONS

⚠ WARNING:
MISUSE or failure to follow the safety rules stated in this instruction manual may cause serious personal injury.

INSTALLATION

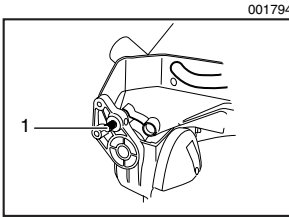

1. Stopper pin

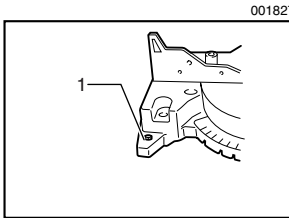

1. Bolt

Bench mounting

When the tool is shipped, the handle is locked in the lowered position by the stopper pin. Release the stopper pin by lowering the handle slightly and pulling the stopper pin.

This tool should be bolted with four bolts to a level and stable surface using the bolt holes provided in the tool's base. This will help prevent tipping and possible injury.

FUNCTIONAL DESCRIPTION

⚠ CAUTION:

- Always be sure that the tool is switched off and unplugged before adjusting or checking function on the tool.

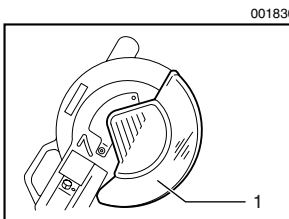

1. Blade guard

Blade guard

When lowering the handle, the blade guard rises automatically. The guard is spring loaded so it returns to its original position when the cut is completed and the handle is raised. **NEVER DEFEAT OR REMOVE THE BLADE GUARD OR THE SPRING WHICH ATTACHES TO THE GUARD.**

In the interest of your personal safety, always maintain the blade guard in good condition. Any irregular operation of the blade guard should be corrected immediately. Check to assure spring loaded return action of guard. **NEVER USE THE TOOL IF THE BLADE GUARD OR SPRING ARE DAMAGED, FAULTY OR REMOVED. DOING SO IS HIGHLY DANGEROUS AND CAN CAUSE SERIOUS PERSONAL INJURY.**

If the see-through blade guard becomes dirty, or sawdust adheres to it in such a way that the blade is no longer easily visible, unplug the saw and clean the guard carefully with a damp cloth. Do not use solvents or any petroleum-based cleaners on the plastic guard.

001782

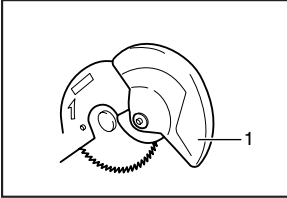

1. Blade guard

If the blade guard is especially dirty and vision through the guard is impaired, use the supplied socket wrench to loosen the hex bolt holding the center cover. Loosen the hex bolt by turning it counterclockwise and raise the blade guard and center cover. With the blade guard so positioned, cleaning can be more completely and efficiently accomplished. When cleaning is complete, reverse procedure above and secure bolt. Do not remove spring holding blade guard. If guard becomes discolored through age or UV light exposure, contact a Makita service center for a new guard. **DO NOT DEFEAT OR REMOVE GUARD.**

001834

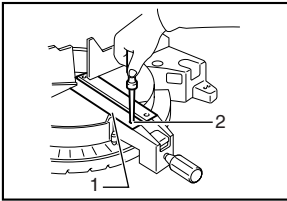

1. Kerf board
2. Screw

Positioning kerf board

This tool is provided with the kerf boards in the turn base to minimize tearing on the exit side of a cut. The kerf boards are factory adjusted so that the saw blade does not contact the kerf boards. Before use, adjust the kerf boards as follows:

First, unplug the tool. Loosen all the screws (2 each on left and right) securing the kerf boards. Re-tighten them only to the extent that the kerf boards can still be easily moved by hand. Lower the handle fully and push in the stopper pin to lock the handle in the lowered position. Adjust the kerf boards so that the kerf boards just contact the sides of the blade teeth. Tighten all the screws (do not tighten firmly). After adjusting the kerf boards, release the stopper pin and raise the handle. Then tighten all the screws securely.

001800

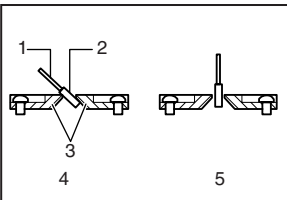

1. Saw blade
2. Blade teeth
3. Kerf board
4. Left bevel cut
5. Straight cut

⚠ CAUTION:

- Before and after changing the bevel angle, always adjust the kerf boards as described above.

001835

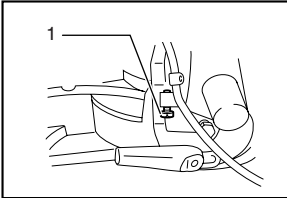

1. Adjusting bolt

Maintaining maximum cutting capacity

This tool is factory adjusted to provide the maximum cutting capacity for a 305 mm (12") saw blade.

When installing a new blade, always check the lower limit position of the blade and if necessary, adjust it as follows:

First, unplug the tool. Lower the handle completely. Use the socket wrench to turn the adjusting bolt until the periphery of the blade extends slightly below the top surface of the turn base at the point where the front face of the guide fence meets the top surface of the turn base.

With the tool unplugged, rotate the blade by hand while holding the handle all the way down to be sure that the blade does not contact any part of the lower base. Re-adjust slightly, if necessary.

001540

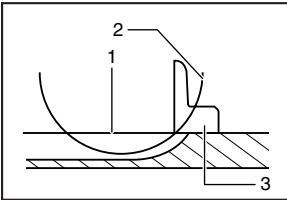

1. Top surface of turn base
2. Periphery of blade
3. Guide fence

⚠ CAUTION:

- After installing a new blade, always be sure that the blade does not contact any part of the lower base when the handle is lowered completely. Always do this with the tool unplugged.

001836

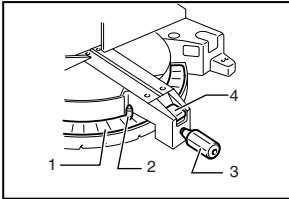

1. Miter scale
2. Pointer
3. Grip
4. Lock lever

Adjusting the miter angle

Loosen the grip by turning counterclockwise. Turn the turn base while pressing down the lock lever. When you have moved the grip to the position where the pointer points to the desired angle on the miter scale, securely tighten the grip clockwise.

⚠ CAUTION:

- When turning the turn base, be sure to raise the handle fully.
- After changing the miter angle, always secure the turn base by tightening the grip firmly.

001837

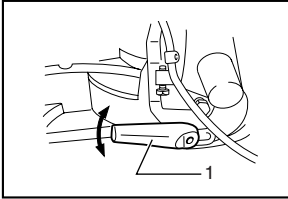

1. Lever

Adjusting the bevel angle

To adjust the bevel angle, loosen the lever at the rear of the tool counterclockwise.

Push the handle to the left to tilt the saw blade until the pointer points to the desired angle on the bevel scale. Then tighten the lever clockwise firmly to secure the arm.

⚠ CAUTION:

- When tilting the saw blade, be sure to raise the handle fully.
- After changing the bevel angle, always secure the arm by tightening the lever clockwise.
- When changing bevel angles, be sure to position the kerf boards appropriately as explained in the “Positioning kerf boards” section.

001838

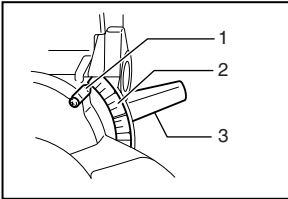

1. Pointer
2. Bevel scale
3. Lever

001833

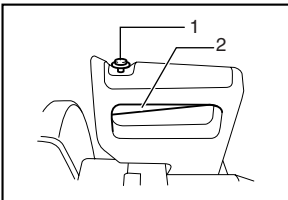

1. Lock-off button
2. Switch trigger

Switch action

⚠ CAUTION:

- Before plugging in the tool, always check to see that the switch trigger actuates properly and returns to the “OFF” position when released.
- When not using the tool, remove the lock-off button and store it in a secure place. This prevents unauthorized operation.
- Do not pull the switch trigger hard without pressing in the lock-off button. This can cause switch breakage.

To prevent the switch trigger from being accidentally pulled, a lock-off button is provided. To start the tool, press in the lock-off button and pull the switch trigger. Release the switch trigger to stop.

⚠ WARNING:

- NEVER use tool without a fully operative switch trigger. Any tool with an inoperative switch is HIGHLY DANGEROUS and must be repaired before further usage.

- For your safety, this tool is equipped with a lock-off button which prevents the tool from unintended starting. NEVER use the tool if it runs when you simply pull the switch trigger without pressing the lock-off button. Return tool to a Makita service center for proper repairs BEFORE further usage.
- NEVER tape down or defeat purpose and function of lock-off button.

Electric brake

This tool is equipped with an electric blade brake. If the tool consistently fails to quickly stop blade after switch trigger release, have tool serviced at a Makita service center.

The blade brake system is not a substitute for blade guard. NEVER USE TOOL WITHOUT A FUNCTIONING BLADE GUARD. SERIOUS PERSONAL INJURY CAN RESULT.

ASSEMBLY

⚠ CAUTION:

- Always be sure that the tool is switched off and unplugged before carrying out any work on the tool.

Socket wrench storage

The socket wrench is stored as shown in the figure. When using the socket wrench, pull it out of the wrench holder. After using the socket wrench, return it to the wrench holder.

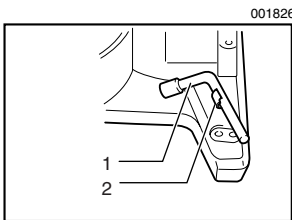

1. Socket wrench
2. Wrench holder

Installing or removing saw blade

⚠ CAUTION:

- Always be sure that the tool is switched off and unplugged before installing or removing the blade.
- Use only the Makita socket wrench provided to install or remove the blade. Failure to do so may result in overtightening or insufficient tightening of the hex bolt. This could cause an injury.

Lock the handle in the raised position by pushing in the stopper pin.

To remove the blade, use the socket wrench to loosen the hex bolt holding the center cover by turning it counterclockwise. Raise the blade guard and center cover.

001828

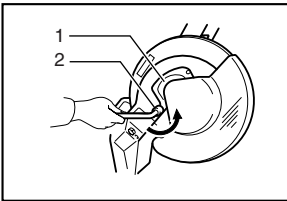

1. Center cover
2. Socket wrench

Press the shaft lock to lock the spindle and use the socket wrench to loosen the hex bolt clockwise. Then remove the hex bolt, outer flange and blade.

001829

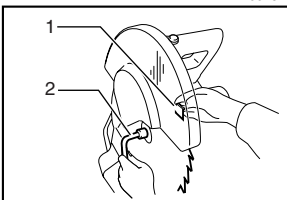

1. Shaft lock
2. Socket wrench

To install the blade, mount it carefully onto the spindle, making sure that the direction of the arrow on the surface of the blade matches the direction of the arrow on the blade case. Install the outer flange and hex bolt, and then use the socket wrench to tighten the hex bolt (left-handed) securely counterclockwise while pressing the shaft lock.

001791

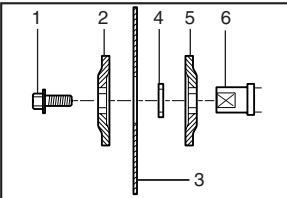

1. Hex bolt
2. Outer flange
3. Saw blade
4. Ring
5. Inner flange
6. Spindle

001785

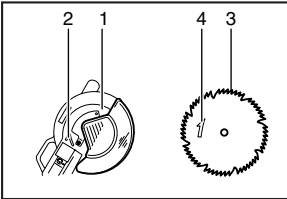

1. Blade case
2. Arrow
3. Saw blade
4. Arrow

Return the blade guard and center cover to its original position. Then tighten the hex bolt clockwise to secure the center cover. Release the handle from the raised position by pulling the stopper pin. Lower the handle to make sure that the blade guard moves properly. Make sure shaft lock has released spindle before making cut.

001831

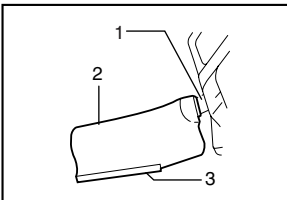

1. Dust nozzle
2. Dust bag
3. Fastener

Dust bag

The use of the dust bag makes cutting operations clean and dust collection easy. To attach the dust bag, fit it onto the dust nozzle.

When the dust bag is about half full, remove the dust bag from the tool and pull the fastener out. Empty the dust bag of its contents, tapping it lightly so as to remove particles adhering to the insides which might hamper further collection.

NOTE:

If you connect a Makita vacuum cleaner to your saw, more efficient and cleaner operations can be performed.

Securing workpiece

⚠ WARNING:

- It is extremely important to always secure the workpiece properly and tightly with the vise. Failure to do so can cause the tool to be damaged and/or the workpiece to be destroyed. PERSONAL INJURY MAY ALSO RESULT. Also, after a cutting operation, DO NOT raise the blade until the blade has come to a complete stop.

001549

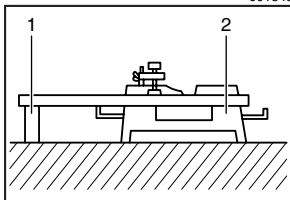

1. Support
2. Turn base

⚠ CAUTION:

- When cutting long workpieces, use supports that are as high as the top surface level of the turn base. Do not rely solely on the vertical vise and/or horizontal vise to secure the workpiece. Thin material tends to sag. Support workpiece over its entire length to avoid blade pinch and possible KICKBACK.

001842

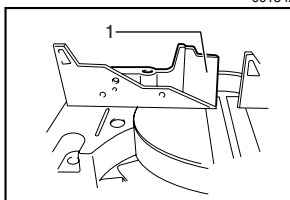

1. Sub-fence

Sub-fence

This tool is equipped with the sub-fence. It should be positioned as shown in the figure.

001843

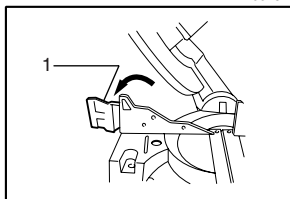

1. Sub-fence

⚠ CAUTION:

- When performing left bevel cuts, flip the fence over to the left position as shown in the figure. Otherwise, it will contact the blade or a part of the tool, causing possible serious injury to the operator.

001796

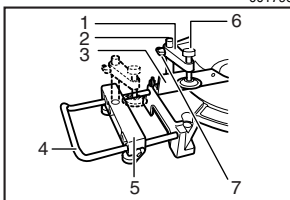

1. Vise arm
2. Vise rod
3. Guide fence
4. Holder
5. Holder assembly
6. Vise knob
7. Screw

Vertical vise

The vertical vise can be installed in two positions on either the left or right side of the guide fence or the holder assembly (optional accessory). Insert the vise rod into the hole in the guide fence or the holder assembly and tighten the screw to secure the vise rod.

Position the vise arm according to the thickness and shape of the workpiece and secure the vise arm by tightening the screw. If the screw to secure the vise arm contacts the guide fence, install the screw on the opposite side of vise arm. Make sure that no part of the tool contacts the vise when lowering the handle all the way. If some part contacts the vise, re-position the vise.

Press the workpiece flat against the guide fence and the turn base. Position the workpiece at the desired cutting position and secure it firmly by tightening the vise knob.

⚠ CAUTION:

- The workpiece must be secured firmly against the turn base and guide fence with the vise during all operations.

001839

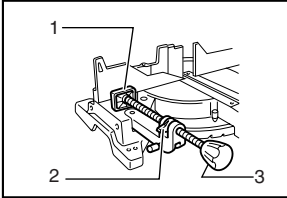

1. Vise plate
2. Vise nut
3. Vise knob

Horizontal vise (optional accessory)

The horizontal vise can be installed in two positions on either the left or right side of the base. When performing 15° or greater miter cuts, install the horizontal vise on the side opposite the direction in which the turn base is to be turned. By flipping the vise nut to the left, the vise is released, and rapidly moves in and out. To grip the workpiece, push the vise knob forward until the vise plate contacts the workpiece and flip the vise nut to the right. Then turn the vise knob clockwise to secure the workpiece.

The maximum width of workpiece which can be secured by the horizontal vise is 200 mm (7 - 7/8").

⚠ CAUTION:

- Always rotate the vise nut to the right fully when securing the workpiece. Failure to do so may result in insufficient securing of the workpiece. This could cause the workpiece to be thrown, cause damage to the blade or cause the loss of control, which can result in PERSONAL INJURY.

001809

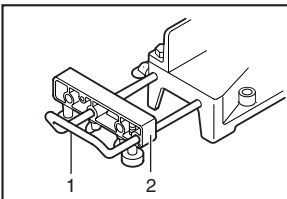

1. Holder
2. Holder assembly

Holders and holder assembly (optional accessories)

The holders and the holder assembly can be installed on either side as a convenient means of supporting workpieces horizontally. Install them as shown in the figure. Then tighten the screws firmly to secure the holders and the holder assembly.

001810

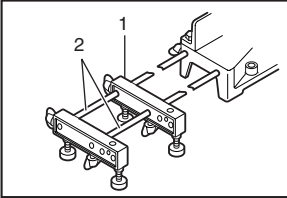

1. Holder assembly
2. Rod 12

When cutting long workpieces, use the holder-rod assembly (optional accessory). It consists of two holder assemblies and two rods 12.

⚠ CAUTION:

- Always support long workpieces level with the top surface of the turn base for accurate cuts and to prevent dangerous loss of control of the tool.

OPERATION

⚠ CAUTION:

- Before use, be sure to release the handle from the lowered position by pulling the stopper pin.
- Make sure the blade is not contacting the workpiece, etc. before the switch is turned on.
- Do not apply excessive pressure on the handle when cutting. Too much force may result in overload of the motor and/or decreased cutting efficiency. Push down handle with only as much force as is necessary for smooth cutting and without significant decrease in blade speed.
- Gently press down the handle to perform the cut. If the handle is pressed down with force or if lateral force is applied, the blade will vibrate and leave a mark (saw mark) in the workpiece and the precision of the cut will be impaired.

001793

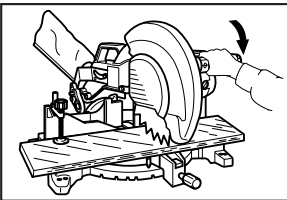

1. Press cutting

Secure the workpiece with the vise. Switch on the tool without the blade making any contact and wait until the blade attains full speed before lowering. Then gently lower the handle to the fully lowered position to cut the workpiece. When the cut is completed, switch off the tool and **WAIT UNTIL THE BLADE HAS COME TO A COMPLETE STOP** before returning the blade to its fully elevated position.

2. Miter cutting

Refer to the previously covered "Adjusting the miter angle".

001841

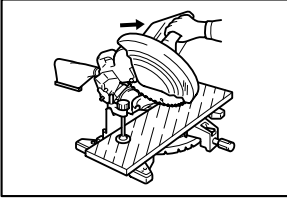

3. Bevel cut

Loosen the lever and tilt the saw blade to set the bevel angle (Refer to the previously covered “Adjusting the bevel angle”). Be sure to retighten the lever firmly to secure the selected bevel angle safely. Secure the workpiece with a vise. Switch on the tool without the blade making any contact and wait until the blade attains full speed. Then gently lower the handle to the fully lowered position while applying pressure in parallel with the blade. When the cut is completed, switch off the tool and **WAIT UNTIL THE BLADE HAS COME TO A COMPLETE STOP** before returning the blade to its fully elevated position.

⚠ CAUTION:

- Always be sure that the blade will move down to bevel direction during a bevel cut. Keep hands out of path of saw blade.
- During a bevel cut, it may create a condition whereby the piece cut off will come to rest against the side of the blade. If the blade is raised while the blade is still rotating, this piece may be caught by the blade, causing fragments to be scattered which is dangerous. The blade should be raised **ONLY** after the blade has come to a complete stop.
- When pressing the handle down, apply pressure parallel to the blade. If the pressure is not parallel to the blade during a cut, the angle of the blade might be shifted and the precision of the cut will be impaired.
- Always set the sub-fence to the left position when performing left bevel cuts.

4. Compound cutting

Compound cutting is the process in which a bevel angle is made at the same time in which a miter angle is being cut on a workpiece. Compound cutting can be performed at angle shown in the table.

Bevel angle	Miter angle
45°	Left and Right 0 - 45°

When performing compound cutting, refer to “Press cutting”, “Miter cutting” and “Bevel cut” explanations.

5. Cutting crown and cove moldings

Crown and cove moldings can be cut on a compound miter saw with the moldings laid flat on the turn base.

There are two common types of crown moldings and one type of cove moldings; 52/38° wall angle crown molding, 45° wall angle crown molding and 45° wall angle cove molding. See illustrations.

001555

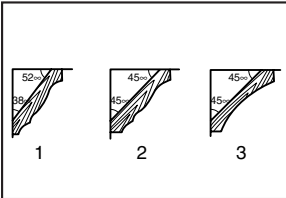

1. 52/38° type crown molding
2. 45° type crown molding
3. 45° type cove molding

001556

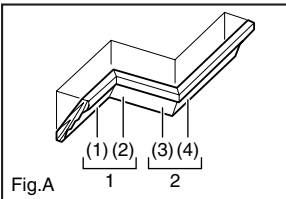
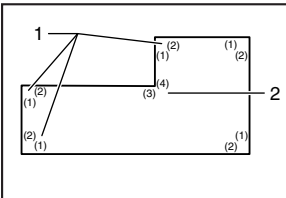

Fig.A

1. Inside corner
2. Outside corner

001557



1. Inside corner
2. Outside corner

There are crown and cove molding joints which are made to fit "Inside" 90° corners ((1) and (2) in Fig. A) and "Outside" 90° corners ((3) and (4) in Fig. A).

Measuring

Measure the wall length and adjust workpiece on table to cut wall contact edge to desired length. Always make sure that cut workpiece length **at the back of the workpiece** is the same as wall length. Adjust cut length for angle of cut. Always use several pieces for test cuts to check the saw angles.

When cutting crown and cove moldings, set the bevel angle and miter angle as indicated in the table (A) and position the moldings on the top surface of the saw base as indicated in the table (B).

Table (A)

	Molding position in Fig. A	Bevel angle		Miter angle	
		52/38° type	45° type	52/38° type	45° type
For inside corner	(1)	Left 33.9°	Left 30°	Right 31.6°	Right 35.3°
	(2)			Left 31.6°	Left 35.3°
For outside corner	(3)	Left 33.9°	Left 30°	Right 31.6°	Right 35.3°
	(4)			Right 31.6°	Right 35.3°

Table (B)

	Molding position in Fig. A	Molding edge against guide fence	Finished piece
For inside corner	(1)	Ceiling contact edge should be against guide fence.	Finished piece will be on the Left side of blade.
	(2)	Wall contact edge should be against guide fence.	
For outside corner	(3)	Ceiling contact edge should be against guide fence.	Finished piece will be on the Right side of blade.
	(4)	Wall contact edge should be against guide fence.	

Example:

In the case of cutting 52/38° type crown molding for position (1) in Fig. A:

- Tilt and secure bevel angle setting to 33.9° LEFT.
- Adjust and secure miter angle setting to 31.6° RIGHT.
- Lay crown molding with its broad back (hidden) surface down on the turn base with its CEILING CONTACT EDGE against the guide fence on the saw.
- The finished piece to be used will always be on the LEFT side of the blade after the cut has been made.

000031

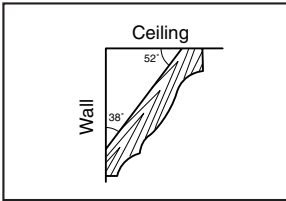

Compound Miter Saw Miter and Bevel Angle Settings

Wall to Crown Molding Angle: 52/38 degrees

Wall Angle (deg.)	Bevel Angle (deg.)	Miter Angle (deg.)
△ 60	43.0	46.8
61	42.8	46.3
62	42.5	45.7
63	42.2	45.1
64	41.9	44.6
65	41.7	44.0
66	41.4	43.5
67	41.1	42.9
68	40.8	42.4
69	40.5	41.9
70	40.2	41.3
71	39.9	40.8
72	39.6	40.3
73	39.3	39.8
74	39.0	39.2
75	38.7	38.7
76	38.4	38.2
77	38.1	37.7
78	37.8	37.2
79	37.4	36.8
80	37.1	36.3
81	36.8	35.8
82	36.5	35.3
83	36.2	34.8
84	35.8	34.4
85	35.5	33.9
86	35.2	33.4
87	34.9	33.0
88	34.5	32.5
89	34.2	32.1
∠ 90	33.9	31.6
91	33.5	31.2
92	33.2	30.7
93	32.8	30.3
94	32.5	29.9
95	32.2	29.4
96	31.8	29.0
97	31.5	28.6
98	31.1	28.2
99	30.8	27.7
100	30.4	27.3

Wall Angle (deg.)	Bevel Angle (deg.)	Miter Angle (deg.)
101	30.1	26.9
102	29.7	26.5
103	29.4	26.1
104	29.0	25.7
105	28.7	25.3
106	28.3	24.9
107	28.0	24.5
108	27.6	24.1
109	27.2	23.7
110	26.9	23.3
111	26.5	22.9
112	26.1	22.6
113	25.8	22.2
114	25.4	21.8
115	25.0	21.4
116	24.7	21.0
117	24.3	20.7
118	23.9	20.3
119	23.6	19.9
∠ 120	23.2	19.6
121	22.8	19.2
122	22.5	18.8
123	22.1	18.5
124	21.7	18.1
125	21.3	17.8
126	21.0	17.4
127	20.6	17.1
128	20.2	16.7
129	19.8	16.4
130	19.5	16.0
131	19.1	15.7
132	18.7	15.3
133	18.3	15.0
134	17.9	14.6
135	17.6	14.3
136	17.2	14.0
137	16.8	13.6
138	16.4	13.3
139	16.0	13.0
140	15.8	12.8

Wall Angle (deg.)	Bevel Angle (deg.)	Miter Angle (deg.)
141	15.3	12.3
142	14.9	12.0
143	14.5	11.6
144	14.1	11.3
145	13.7	11.0
146	13.3	10.7
147	12.9	10.3
148	12.5	10.0
149	12.2	9.7
∠ 150	11.8	9.4
151	11.4	9.0
152	11.0	8.7
153	10.8	8.4
154	10.2	8.1
155	9.8	7.8
156	9.4	7.5
157	9.0	7.1
158	8.6	6.8
159	8.3	6.5
160	7.9	6.2
161	7.5	5.9
162	7.1	5.6
163	6.7	5.3
164	6.3	4.9
165	5.9	4.6
166	5.5	4.3
167	5.1	4.0
168	4.7	3.7
169	4.3	3.4
170	3.9	3.1
171	3.5	2.8
172	3.2	2.5
173	2.8	2.2
174	2.4	1.8
175	2.0	1.5
176	1.6	1.2
177	1.2	0.9
178	0.8	0.6
179	0.4	0.3
∠ 180	0.0	0.0

000032

Compound Miter Saw Miter and Bevel Angle Settings

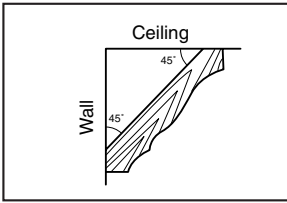

Wall to Crown Molding Angle: 45 degrees

Wall Angle (deg.)	Bevel Angle (deg.)	Miter Angle (deg.)
△ 60	37.8	50.8
61	37.5	50.2
62	37.3	49.6
63	37.1	49.1
64	36.8	48.5
65	36.6	48.0
66	36.4	47.4
67	36.1	46.9
68	35.9	46.4
69	35.6	45.8
70	35.4	45.3
71	35.1	44.8
72	34.9	44.2
73	34.6	43.7
74	34.4	43.2
75	34.1	42.7
76	33.9	42.1
77	33.6	41.6
78	33.3	41.1
79	33.1	40.6
80	32.8	40.1
81	32.5	39.6
82	32.3	39.1
83	32.0	38.6
84	31.7	38.1
85	31.4	37.7
86	31.1	37.2
87	30.9	36.7
88	30.6	36.2
89	30.3	35.7
∠ 90	30.0	35.3
91	29.7	34.8
92	29.4	34.3
93	29.1	33.9
94	28.8	33.4
95	28.5	32.9
96	28.2	32.5
97	27.9	32.0
98	27.6	31.6
99	27.3	31.1
100	27.0	30.7

Wall Angle (deg.)	Bevel Angle (deg.)	Miter Angle (deg.)
101	26.7	30.2
102	26.4	29.8
103	26.1	29.4
104	25.8	28.9
105	25.5	28.5
106	25.2	28.1
107	24.9	27.6
108	24.6	27.2
109	24.2	26.8
110	23.9	26.3
111	23.6	25.9
112	23.3	25.5
113	23.0	25.1
114	22.7	24.7
115	22.3	24.3
116	22.0	23.8
117	21.7	23.4
118	21.4	23.0
119	21.0	22.6
∠ 120	20.7	22.2
121	20.4	21.8
122	20.0	21.4
123	19.7	21.0
124	19.4	20.6
125	19.1	20.2
126	18.7	19.8
127	18.4	19.4
128	18.1	19.0
129	17.7	18.6
130	17.4	18.2
131	17.1	17.9
132	16.7	17.5
133	16.4	17.1
134	16.0	16.7
135	15.7	16.3
136	15.4	15.9
137	15.0	15.6
138	14.7	15.2
139	14.3	14.8
140	14.0	14.4

Wall Angle (deg.)	Bevel Angle (deg.)	Miter Angle (deg.)
141	13.7	14.1
142	13.3	13.7
143	13.0	13.3
144	12.6	12.9
145	12.3	12.6
146	11.9	12.2
147	11.6	11.8
148	11.2	11.5
149	10.9	11.1
∠ 150	10.5	10.7
151	10.2	10.4
152	9.8	10.0
153	9.5	9.6
154	9.2	9.3
155	8.8	8.9
156	8.5	8.5
157	8.1	8.2
158	7.8	7.8
159	7.4	7.5
160	7.1	7.1
161	6.7	6.7
162	6.4	6.4
163	6.0	6.0
164	5.6	5.7
165	5.3	5.3
166	4.9	5.0
167	4.6	4.6
168	4.2	4.3
169	3.9	3.9
170	3.5	3.5
171	3.2	3.2
172	2.8	2.8
173	2.5	2.5
174	2.1	2.1
175	1.8	1.8
176	1.4	1.4
177	1.1	1.1
178	0.7	0.7
179	0.4	0.4
∠ 180	0.0	0.0

001797

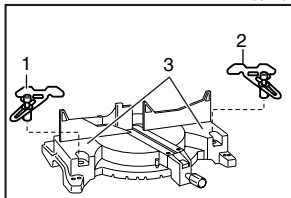

1. Crown molding stopper L
2. Crown molding stopper R
3. Base

001560

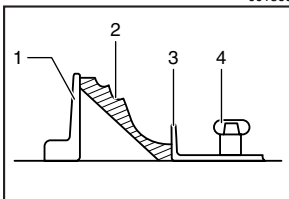

1. Guide fence
2. Crown molding
3. Crown molding stopper
4. Screw

Crown molding stoppers (optional accessories) allow easier cuts of crown molding without tilting the saw blade. Install them on the base as shown in the figures.

Position crown molding with its WALL CONTACT EDGE against the guide fence and its CEILING CONTACT EDGE against the crown molding stoppers as shown in the figure. Adjust the crown molding stoppers according to the size of the crown molding. Tighten the screws to secure the crown molding stoppers. Refer to the table (C) for the miter angle.

Table (C)

	Position in Fig. A	Miter angle	Finished piece
For inside corner	(1)	Right 45°	Save the right side of blade
	(2)	Left 45°	Save the left side of blade
For outside corner	(3)	Left 45°	Save the right side of blade
	(4)	Right 45°	Save the left side of blade

001844

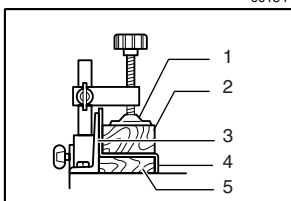

1. Vise
2. Spacer block
3. Guide fence
4. Aluminum extrusion
5. Spacer block

6. Cutting aluminum extrusion

When securing aluminum extrusions, use spacer blocks or pieces of scrap as shown in the figure to prevent deformation of the aluminum. Use a cutting lubricant when cutting the aluminum extrusion to prevent build-up of the aluminum material on the blade.

⚠ CAUTION:

- Never attempt to cut thick or round aluminum extrusions. Thick aluminum extrusions may come loose during operation and round aluminum extrusions cannot be secured firmly with this tool.

7. Wood facing

Use of wood facing helps to assure splinter-free cuts in workpieces. Attach a wood facing to the guide fence using the holes in the guide fence.

See the figure concerning the dimensions for a suggested wood facing.

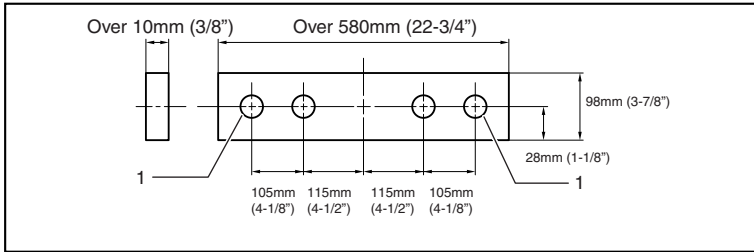

1. Hole

⚠ CAUTION:

- Use straight wood of even thickness as the wood facing.
- Use screws to attach the wood facing to the guide fence. The screws should be installed so that the screw heads are below the surface of the wood facing.
- When the wood facing is attached, do not turn the turn base with the handle lowered. The blade and/or the wood facing will be damaged.

001846

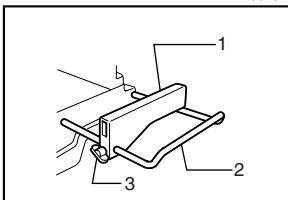

1. Set plate
2. Holder
3. Screw

8. Cutting repetitive lengths

When cutting several pieces of stock to the same length, ranging from 295 mm (11 - 5/8") to 440 mm (17 x 1/4"), use of the set plate (optional accessory) will facilitate more efficient operation. Install the set plate on the holder as shown in the figure.

Align the cutting line on your workpiece with either the left or right side of the groove in the kerf board, and while holding the workpiece from moving, move the set plate flush against the end of the workpiece. Then secure the set plate with the screw. When the set plate is not used, loosen the screw and turn the set plate out of the way.

NOTE:

- Use of the holder-rod assembly (optional accessory) allows cutting repetitive lengths up to 2,200 mm (7.2 ft.) approximately.

001794

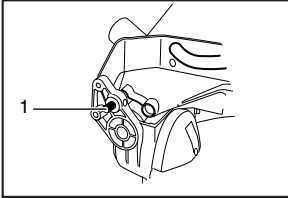

1. Stopper pin

Carrying tool

Make sure that the tool is unplugged. Secure the blade at 0° bevel angle and the turn base at right miter angle fully. Lower the handle fully and lock it in the lowered position by pushing in the stopper pin.

001825

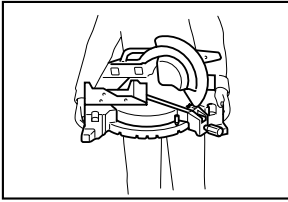

Carry the tool by holding both sides of the tool base as shown in the figure. If you remove the holders, dust bag, etc., you can carry the tool more easily.

⚠ CAUTION:

- Always secure all moving portions before carrying the tool.
- Stopper pin is for carrying and storage purposes only and not for any cutting operations.

MAINTENANCE

⚠ CAUTION:

- Always be sure that the tool is switched off and unplugged before attempting to perform inspection or maintenance.

⚠ WARNING:

- Always be sure that the blade is sharp and clean for the best and safest performance.

Adjusting the cutting angle

This tool is carefully adjusted and aligned at the factory, but rough handling may have affected the alignment. If your tool is not aligned properly, perform the following:

1. Miter angle

Loosen the grip which secures the turn base. Turn the turn base so that the pointer points to 0° on the miter scale. Then turn the turn base slightly clockwise and counterclockwise to seat the turn base in the 0° miter notch. (Leave as it is if the pointer does not point to 0°.) Loosen the hex bolts securing the guide fence using the socket wrench.

001849

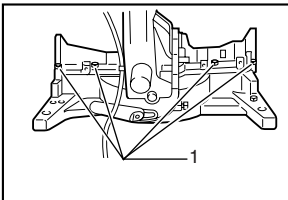

1. Hex bolt

001848

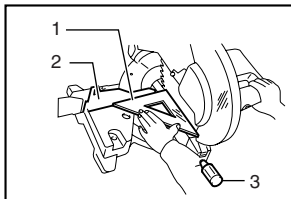

1. Triangular rule
2. Guide fence
3. Grip

Lower the handle fully and lock it in the lowered position by pushing in the stopper pin. Square the side of the blade with the face of the guide fence using a triangular rule, try-square, etc. Then securely tighten the hex bolts on the guide fence in the order from the right side.

001836

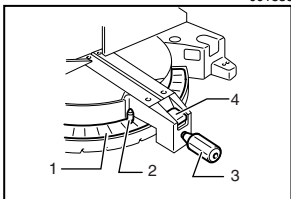

1. Miter scale
2. Pointer
3. Grip
4. Lock lever

Make sure that the pointer points to 0° on the miter scale. If the pointer does not point to 0°, loosen the screw which secures the pointer and adjust the pointer so that it will point to 0°.

2. Bevel angle

(1) 0° bevel angle

Lower the handle fully and lock it in the lowered position by pushing in the stopper pin. Loosen the lever at the rear of the tool.

Turn the 0° bevel angle adjusting bolt on the left side of the turn base two or three revolutions counterclockwise to tilt the blade to the right.

001850

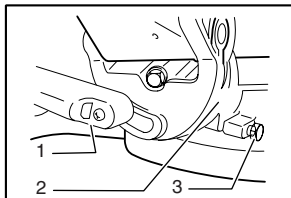

1. Lever
2. Turn base
3. 0° bevel angle adjusting bolt

Carefully square the side of the blade with the top surface of the turn base using the triangular rule, try-square, etc. by turning the 0° bevel angle adjusting bolt clockwise. Then tighten the lever securely.

001819

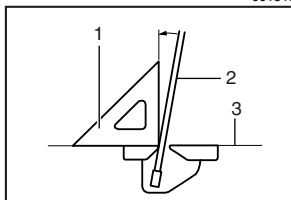

1. Triangular rule
2. Saw blade
3. Top surface of turn base

001851

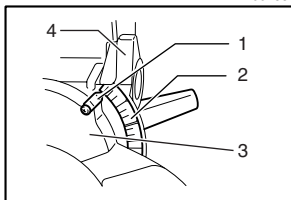

1. Pointer
2. Bevel scale
3. Turn base
4. Arm

Make sure that the pointer on the turn base point to 0° on the bevel scale on the arm. If it does not point to 0°, loosen the screw which secures the pointer and adjust the pointer so that it will point to 0°.

001852

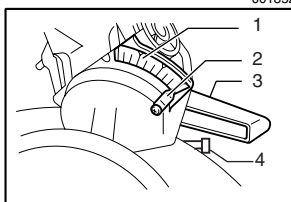

1. Bevel scale
2. Pointer
3. Lever
4. 45° bevel angle adjusting bolt

(2) 45° bevel angle

Adjust the 45° bevel angle only after performing 0° bevel angle adjustment. To adjust left 45° bevel angle, loosen the lever and tilt the blade to the left fully. Make sure that the pointer on the turn base points to 45° on the bevel scale on the arm. If the pointer does not point to 45°, turn the 45° bevel angle adjusting bolt on the right side of the arm until the pointer points to 45°.

001145

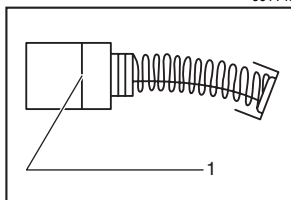

1. Limit mark

Replacing carbon brushes

Remove and check the carbon brushes regularly. Replace when they wear down to the limit mark. Keep the carbon brushes clean and free to slip in the holders. Both carbon brushes should be replaced at the same time. Use only identical carbon brushes.

001853

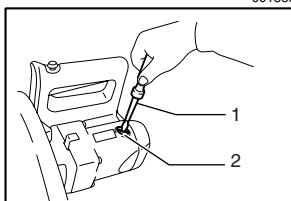

1. Screwdriver
2. Brush holder cap

Use a screwdriver to remove the brush holder caps. Take out the worn carbon brushes, insert the new ones and secure the brush holder caps.

After replacing brushes, plug in the tool and break in brushes by running tool with no load for about 10 minutes. Then check the tool while running and electric brake operation when releasing the switch trigger. If electric brake is not working well, ask your local Makita service center for repair.

After use

- After use, wipe off chips and dust adhering to the tool with a cloth or the like. Keep the blade guard clean according to the directions in the previously covered section titled “Blade guard”. Lubricate the sliding portions with machine oil to prevent rust.

To maintain product SAFETY and RELIABILITY, repairs, any other maintenance or adjustment should be performed by Makita Authorized or Factory Service Centers, always using Makita replacement parts.

ACCESSORIES

⚠ CAUTION:

- These accessories or attachments are recommended for use with your Makita tool specified in this manual. The use of any other accessories or attachments might present a risk of injury to persons. Only use accessory or attachment for its stated purpose.

If you need any assistance for more details regarding these accessories, ask your local Makita service center.

- Carbide-tipped saw blades

Miter saw blades	For smooth and precise cutting in various materials.
------------------	--

- Vise assembly (Horizontal vise)
- Vertical vise
- Socket wrench 13
- Holder set
- Holder assembly
- Holder rod assembly
- Set plate
- Dust bag
- Elbow
- Crown molding stopper set
- Triangular rule
- Lock-off button (2 pcs.)

Cut



First-Class
Postage
Required

Post Office will
not deliver
without proper
postage.

Makita U.S.A., Inc.
14930 Northam Street
La Mirada, CA 90638-5753



Fold

FACTORY SERVICE CENTERS

1-800-4-MAKITA

RETAIN THIS PORTION FOR YOUR RECORDS

ARIZONA

3707 E. Broadway Rd., Ste. 6
Phoenix, AZ 85040
(602) 437-2850

CALIFORNIA

41850 Christy St.
Fremont, CA 94538-5107
(510) 657-9881

14930 Northam St.
La Mirada, CA 90638-5753
(714) 522-8088

1970 Fulton Avenue
Sacramento, CA 95825
(916) 482-5197

7674 Clairemont Mesa Blvd.
San Diego, CA 92111
(858) 278-4471

16735 Saticoy St., Ste. 105
Van Nuys, CA 91406
(818) 782-2440

COLORADO

11839 E. 51st Ave.
Denver, CO 80239-2709
(303) 371-2850

FLORIDA

750 East Sample Road
Pompano Beach, FL 33064
(954) 781-6333

GEORGIA

4680 River Green Parkway NW
Duluth, GA 30096
(770) 476-8911

ILLINOIS

1450 Feehanville Dr.
Mt. Prospect, IL 60056-6011
(847) 297-3100

MARYLAND

7397 Washington Boulevard,
Suite 104 Elkridge, MD 21075
(410) 476-4401

MASSACHUSETTS

232 Providence Hwy.
Westwood, MA 02090
(781) 461-9754

MINNESOTA

6427 Penn Ave. South
Richfield, MN 55423
(612) 869-5199

MISSOURI

9876 Watson Road
St. Louis, MO 63126-2221
(314) 909-9889

NEBRASKA

4129 S. 84th St.
Omaha, NE 68127
(402) 597-2925

NEVADA

3375 S. Decatur Blvd.
Suites. 22 - 24
Las Vegas, NV 89102
(702) 368-4277

NEW JERSEY

251 Herrod Blvd.
Dayton, NJ 08810-1539
(609) 655-1212

NEW YORK

4917 Genessee Street
Cheektowaga, NY 14225
(716) 685-9503

OREGON

828 19th Avenue, N.W.
Portland, OR 97209
(503) 222-1823

PENNSYLVANIA

1704 Babcock Blvd.
Pittsburgh, PA 15209
(412) 822-7370

PUERTO RICO

200 Guayama St.
Hato Rey, PR 00917
(787) 250-8776

TENNESSEE

1120 Elm Hill P.
Suite 170 Nashville, TN 372
(615) 248-3321

TEXAS

12801 Stemmons Fwy Ste. 809
Farmers Branch, TX 75234
(972) 243-1150

12701 Directors Dr.
Stafford, TX 77477-3701
(281) 565-8665

3453 IH-35 North, Ste. 101
San Antonio, TX 78219
(210) 228-0676

WISCONSIN

Lincoln Plaza Shopping Ctr.
2245 S. 108th St. West Allis, WI
53227
(414) 541-4776

CUSTOMER'S RECORD

<p>When you need service: Send complete tool (prepaid) to one of the Makita Factory Service Centers listed, or to an Authorized Makita Service Center. Be sure to attach a letter to the outside of the carton detailing the problem with your tool.</p>	Date Purchased
	Dealer's Name & Address
	Model No.
	Serial No.

WARNING

Some dust created by power sanding, sawing, grinding, drilling, and other construction activities contains chemicals known to the State of California to cause cancer, birth defects or other reproductive harm. Some examples of these chemicals are:

- lead from lead-based paints,
- crystalline silica from bricks and cement and other masonry products, and
- arsenic and chromium from chemically-treated lumber.

Your risk from these exposures varies, depending on how often you do this type of work. To reduce your exposure to these chemicals: work in a well ventilated area, and work with approved safety equipment, such as those dust masks that are specially designed to filter out microscopic particles.

MAKITA LIMITED ONE YEAR WARRANTY

Warranty Policy

Every Makita tool is thoroughly inspected and tested before leaving the factory. It is warranted to be free of defects from workmanship and materials for the period of ONE YEAR from the date of original purchase. Should any trouble develop during this one year period, return the COMPLETE tool, freight prepaid, to one of Makita's Factory or Authorized Service Centers. If inspection shows the trouble is caused by defective workmanship or material, Makita will repair (or at our option, replace) without charge.

This Warranty does not apply where:

- repairs have been made or attempted by others:
- repairs are required because of normal wear and tear:
- the tool has been abused, misused or improperly maintained:
- alterations have been made to the tool.

IN NO EVENT SHALL MAKITA BE LIABLE FOR ANY INDIRECT, INCIDENTAL OR CONSEQUENTIAL DAMAGES FROM THE SALE OR USE OF THE PRODUCT. THIS DISCLAIMER APPLIES BOTH DURING AND AFTER THE TERM OF THIS WARRANTY.

MAKITA DISCLAIMS LIABILITY FOR ANY IMPLIED WARRANTIES, INCLUDING IMPLIED WARRANTIES OF "MERCHANTABILITY" AND "FITNESS FOR A SPECIFIC PURPOSE," AFTER THE ONE YEAR TERM OF THIS WARRANTY.

This Warranty gives you specific legal rights, and you may also have other rights which vary from state to state. Some states do not allow the exclusion or limitation of incidental or consequential damages, so the above limitation or exclusion may not apply to you. Some states do not allow limitation on how long an implied warranty lasts, so the above limitation may not apply to you.

Makita Corporation of America

2650 Buford Hwy., Buford, GA 30518

Free Manuals Download Website

<http://myh66.com>

<http://usermanuals.us>

<http://www.somanuals.com>

<http://www.4manuals.cc>

<http://www.manual-lib.com>

<http://www.404manual.com>

<http://www.luxmanual.com>

<http://aubethermostatmanual.com>

Golf course search by state

<http://golfingnear.com>

Email search by domain

<http://emailbydomain.com>

Auto manuals search

<http://auto.somanuals.com>

TV manuals search

<http://tv.somanuals.com>