

# Makita

アメリカ

## Cordless Stapler

**MODEL T221D**  
**MODEL T221DW**  
With Fast Charger

### INSTRUCTION MANUAL



#### SPECIFICATIONS

• Model T221D

| Applicable staples                                 | Staple capacity | Dimensions (L x W x H)                                | Net weight          |
|----------------------------------------------------|-----------------|-------------------------------------------------------|---------------------|
| Staple Nos.<br>1010, 1013, 1016,<br>◆ 1019, ◆ 1022 | 100             | 199 mm x 58 mm x 193 mm<br>(7-7/8" x 2-1/4" x 7-5/8") | 1.7 kg<br>(3.7 lbs) |

• Battery Cartridge 9100

• Model DC9700 Fast Charger

| Voltage | Charging time | Input                   | Output            |
|---------|---------------|-------------------------|-------------------|
| 9.6 V   | 1 Hr.         | A.C. only 50 Hz — 60 Hz | D.C. 7.2 V, 9.6 V |

\* Manufacturer reserves the right to change specifications without notice.

\* Note: 1. Specifications may differ from country to country.

2. Staples with ●mark are for soft material only.

Download from [www.Somanuals.com](http://www.Somanuals.com). All Manuals Search And Download.

# **IMPORTANT SAFETY INSTRUCTIONS**

## **(For All Tools)**

**WARNING: WHEN USING ELECTRIC TOOLS, BASIC SAFETY PRECAUTIONS SHOULD ALWAYS BE FOLLOWED TO REDUCE THE RISK OF FIRE, ELECTRIC SHOCK, AND PERSONAL INJURY, INCLUDING THE FOLLOWING:**

### **READ ALL INSTRUCTIONS.**

1. **KEEP WORK AREA CLEAN.** Cluttered areas and benches invite injuries.
2. **CONSIDER WORK AREA ENVIRONMENT.** Don't use power tools in damp or wet locations. Keep work area well lit. Don't expose power tools to rain. Don't use tool in presence of flammable liquids or gases.
3. **KEEP CHILDREN AWAY.** All visitors should be kept away from work area. Don't let visitors contact tool or extension cord.
4. **STORE IDLE TOOLS.** When not in use, tools should be stored in dry, and high or locked-up place — out of reach of children.
5. **DON'T FORCE TOOL.** It will do the job better and safer at the rate for which it was intended.
6. **USE RIGHT TOOL.** Don't force small tool or attachment to do the job of a heavy-duty tool. Don't use tool for purpose not intended.
7. **DRESS PROPERLY.** Don't wear loose clothing or jewelry. They can be caught in moving parts. Rubber gloves and non-skid footwear are recommended when working outdoors. Wear protective hair covering to contain long hair.
8. **USE SAFETY GLASSES.** Also use face or dust mask if cutting operation is dusty.
9. **DON'T ABUSE CORD.** Never carry tool by cord or yank it to disconnect from receptacle. Keep cord from heat, oil, and sharp edges.
10. **SECURE WORK.** Use clamps or a vise to hold work. It's safer than using your hand and it frees both hands to operate tool.
11. **DON'T OVERREACH.** Keep proper footing and balance at all times.
12. **MAINTAIN TOOLS WITH CARE.** Keep tools sharp and clean for better and safer performance. Follow instructions for lubricating and changing accessories. Inspect tool cords periodically and if damaged, have repaired by authorized service facility. Inspect extension cords periodically and replace if damaged. Keep handles dry, clean, and free from oil and grease.
13. **DISCONNECT TOOLS.** When not in use, before servicing, and when changing accessories, such as blades, bits, cutters.

14. **REMOVE ADJUSTING KEYS AND WRENCHES.** Form habit of checking to see that keys and adjusting wrenches are removed from tool before turning it on.
15. **AVOID UNINTENTIONAL STARTING.** Don't carry plugged-in tool with finger on switch. Be sure switch is OFF when plugging in.
16. **OUTDOOR USE EXTENSION CORDS.** When tool is used outdoors, use only extension cords intended for use outdoors and so marked.
17. **STAY ALERT.** Watch what you are doing, use common sense. Don't operate tool when you are tired.
18. **CHECK DAMAGED PARTS.** Before further use of the tool, a guard or other part that is damaged should be carefully checked to determine that it will operate properly and perform its intended function. Check for alignment of moving parts, binding of moving parts, breakage of parts, mounting, and any other conditions that may affect its operation. A guard or other part that is damaged should be properly repaired or replaced by an authorized service center unless otherwise indicated elsewhere in this instruction manual. Have defective switches replaced by authorized service center. Don't use tool if switch does not turn it on and off.
19. **GUARD AGAINST ELECTRIC SHOCK.** Prevent body contact with grounded surfaces. For example; pipes, radiators, ranges, refrigerator enclosures.
20. **REPLACEMENT PARTS.** When servicing, use only identical replacement parts.

**VOLTAGE WARNING:** Before connecting the tool to a power source (receptacle, outlet, etc.) be sure the voltage supplied is the same as that specified on the nameplate of the tool. A power source with voltage greater than that specified for the tool can result in **SERIOUS INJURY** to the user — as well as damage to the tool. If in doubt, **DO NOT PLUG IN THE TOOL.** Using a power source with voltage less than the nameplate rating is harmful to the motor.

# IMPORTANT SAFETY INSTRUCTIONS

1. **SAVE THESE INSTRUCTIONS** — This manual contains important safety and operating instructions for battery charger.
2. Before using battery charger, read all instructions and cautionary markings on (1) battery charger, (2) battery, and (3) product using battery.
3. **CAUTION** — To reduce risk of injury, charge only MAKITA Battery 7000, 9000 or 9100. Other types of batteries may burst causing personal injury and damage.
4. Do not expose charger to rain or snow.
5. Use of an attachment not recommended or sold by the battery charger manufacturer may result in a risk of fire, electric shock, or injury to persons.
6. To reduce risk of damage to electric plug and cord, pull by plug rather than cord when disconnecting charger.
7. Make sure cord is located so that it will not be stepped on, tripped over, or otherwise subjected to damage or stress.
8. An extension cord should not be used unless absolutely necessary. Use of improper extension cord could result in a risk of fire and electric shock. If extension cord must be used, make sure:
  - a. That pins on plug of extension cord are the same number, size, and shape as those of plug on charger;
  - b. That extension cord is properly wired and in good electrical condition; and
  - c. That wire size is at least as large as the one specified in the table below.

**TABLE 1**  
**RECOMMENDED MINIMUM AWG SIZE FOR**  
**EXTENSION CORDS FOR BATTERY CHARGERS**

|                       |    |    |     |     |
|-----------------------|----|----|-----|-----|
| Length of Cord (Feet) | 25 | 50 | 100 | 150 |
| AWG Size of Cord      | 18 | 18 | 18  | 16  |

9. Do not operate charger with damaged cord or plug — replace them immediately.
10. Do not operate charger if it has received a sharp blow, been dropped, or otherwise damaged in any way; take it to a qualified serviceman.
11. Do not disassemble charger or battery cartridge; take it to a qualified serviceman when service or repair is required. Incorrect reassembly may result in a risk of electric shock or fire.
12. To reduce risk of electric shock, unplug charger from outlet before attempting any maintenance or cleaning. Turning off controls will not reduce this risk.

## **ADDITIONAL SAFETY RULES FOR CHARGER & BATTERY CARTRIDGE**

1. Do not charge Battery Cartridge when temperature is **BELOW 10°C (50°F)** or **ABOVE 40°C (104°F)**.
2. Do not attempt to use a step-up transformer, an engine generator or DC power receptacle.
3. Do not allow anything to cover or clog the charger vents.
4. Always cover the battery terminals with the battery cover when the battery cartridge is not used.
5. Do not short the battery cartridge:
  - (1) Do not touch the terminals with any conductive material.
  - (2) Avoid storing battery cartridge in a container with other metal objects such as nails, coins, etc.
  - (3) Do not expose battery cartridge to water or rain.  
A battery short can cause a large current flow, overheating, possible burns and even a breakdown.
6. Do not store the tool and Battery Cartridge in locations where the temperature may reach or exceed **50°C (122°F)**.
7. Do not incinerate the Battery Cartridge even if it is severely damaged or is completely worn out. The battery cartridge can explode in a fire.

## **ADDITIONAL SAFETY RULES**

- 1. Always wear safety goggles or safety glasses with side shield, and a full face shield when needed.**
- 2. Do not point the ejection port at anyone in the vicinity (especially his face). Keep hands and feet away from the ejection port area.**
- 3. Always remove the battery cartridge before loading the staples, adjustment, inspection, maintenance or after operation is over.**
- 4. Make sure no one is nearby before operation. Never attempt to drive staples from both the inside and outside of wall at the same time. Staples may rip through and/or fly off, presenting a grave danger.**
- 5. Watch your footing and maintain your balance with the tool. Make sure there is no one below when working in high locations.**
- 6. Check walls, ceilings, floors, roofing and the like carefully to avoid possible electrical shock, gas leakage, explosions, etc. caused by stapling into live wires, conduits or gas pipes.**
- 7. Use only staples specified in this manual. The use of any other staples may cause malfunction of the tool.**
- 8. Do not tamper with the tool or attempt to use it for other than driving staples.**
- 9. Do not operate the tool without staples. It shortens the service life of the tool.**
- 10. Stop driving operations immediately if you notice something wrong or out of the ordinary with the tool.**
- 11. Never staple into any materials which may allow the staple to puncture and fly through as a projectile.**
- 12. Never actuate the trigger switch and safety lever at the same time until you are prepared to staple workpieces. Allow the workpiece to depress the safety lever. Never defeat its purpose by securing the safety lever back or by depressing it by hand.**
- 13. Never tamper with the safety lever. Check the safety lever frequently for proper operations.**

**SAVE THESE INSTRUCTIONS.**

## Installing or removing battery cartridge

- Always switch off the tool before insertion or removal of the battery cartridge.
- To remove the battery cartridge, pull out the set plate on the tool and grasp both sides of the cartridge while withdrawing it from the tool.
- To insert the battery cartridge, align the tongue on the battery cartridge with the groove in the housing and slip it into place. Snap the set plate back into place. Be sure to close the set plate fully before using the tool.

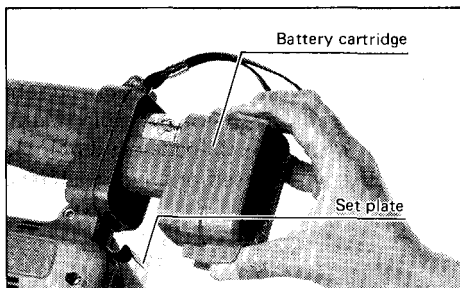

- Do not use force when inserting the battery cartridge. If the cartridge does not slide in easily, it is not being inserted correctly.

## Charging

Plug the fast charger into your power source. Insert the battery cartridge so that the plus and minus terminals on the battery cartridge are on the same sides as their respective markings on the fast charger. Insert the cartridge fully into the port so that it rests on the charger port floor.

Press the start button (red). The charging light will come on and charging will begin.

If the charging light does not come on, press the reset button (yellow) first, then the start button (red). If the charging light goes out within 10 seconds even after pressing the reset button and start button a couple of times, the battery cartridge is dead. (CAUTION: Wait for more than 5 seconds after the charging light goes out to press the reset button again.) Replace it with a new one. When the charging light goes out after about one hour, you may remove the fully charged battery cartridge.

After charging, unplug the charger from the power source.

### CAUTION:

- Your new battery cartridge is not charged. You will need to charge it before use.
- Do not keep the button pressed in with tape, etc. or the circuit will not function properly. Also, a malfunction of the charger may result possibly causing overheating, etc.
- If you try to charge a cartridge from a just-operated tool, sometimes the charging light will not come on. If this occurs, let the cartridge cool off for a while. Then re-insert it and try to charge it once more.
- When you charge a new battery cartridge or a battery cartridge which has not been used for a long period, it may not accept a full charge. This is a normal condition and does not indicate a problem. You can recharge the battery cartridge fully after discharging it almost completely a couple of times.
- If you wish to charge two battery cartridges, allow 15 minutes between chargings on the fast charger.

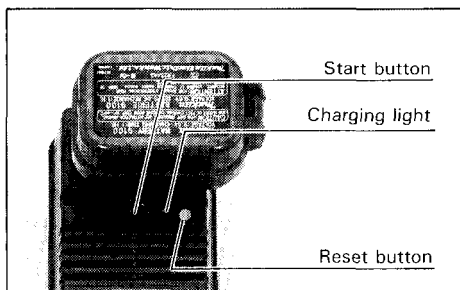

### Safety system

Make sure all safety systems are in working order before operation. The tool must not operate if only the trigger is pulled or if only the safety lever is pressed against the wood. It must work only when both actions are performed. Test for possible faulty operation with a tool unloaded and pointed well away from yourself or any bystanders.

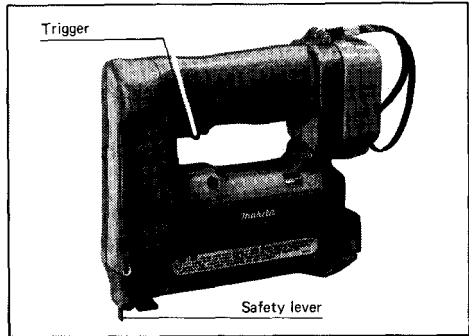

### NOTE:

There is a possibility that the tool may operate for an instant when only the trigger is pulled. This does not indicate a problem. If this occurs, point the tool well away from yourself or any bystanders. Release and pull the trigger again to make sure the safety systems are in working order.

### Loading staples

#### CAUTION:

Always remove the battery cartridge before loading the staples into the tool.

Press the plate spring on the rear of the sub-magazine and slide the sub-magazine backward.

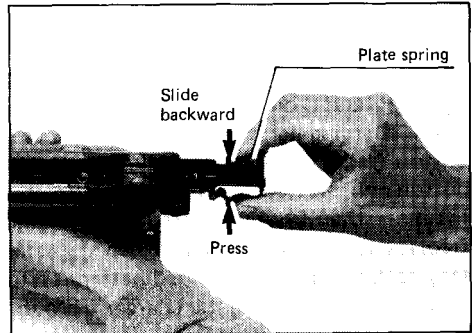

Load staples into the main magazine with staple ends facing up as illustrated at right. Slide the sub-magazine forward.

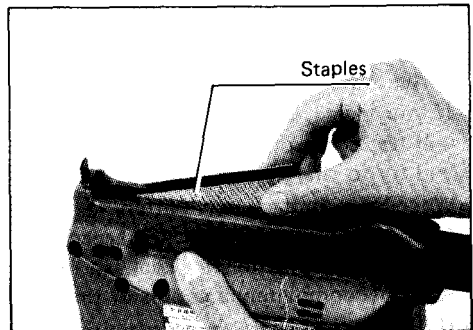



To secure the sub-magazine in place, push the sub-magazine while pressing the plate spring on the rear of the sub-magazine.

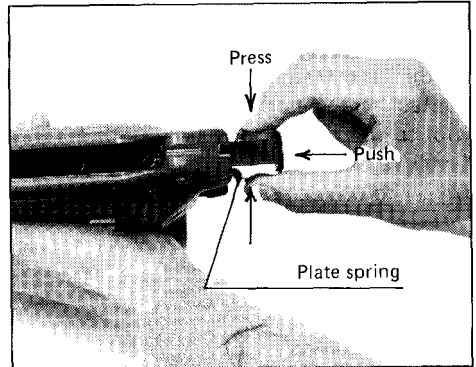

**CAUTION:**

- Always secure the sub-magazine in place, or the staples can drop out and cause problems.
- With the magazine loaded, if the tool is held downward and the sub-magazine is opened, the staples can fall out and present a danger to anyone or anything below. Keep this in mind especially when working in high locations.

**Depth adjustment**

If the staples are driven too deep or too shallow, adjust the driving depth by turning the nut on the bottom of the tool. For deeper driving of staples, turn the nut clockwise. For shallower driving, turn the nut counterclockwise. Please note the nut must be turned in increments of  $180^\circ$  (1/2 turn) so that the groove on the nut runs parallel to the magazine.

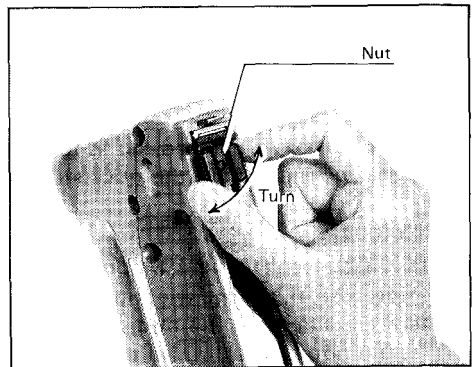

**NOTE:**

If the distance between the tool end (A) and the material to be fastened is more than 2 mm ( $5/64''$ ), the tool will not operate because the safety lever is not pressed enough to operate the tool.

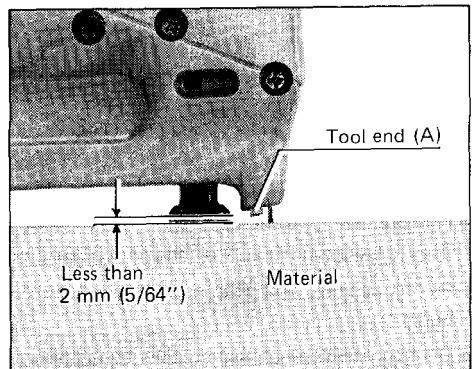

## Driving staples

Place the tool on the material to be fastened so that the front and the rear of the tool contact the material flat. Do not tip the tool to the right or left side. Hold the tool firmly against the material. Then pull the trigger to drive the staples.

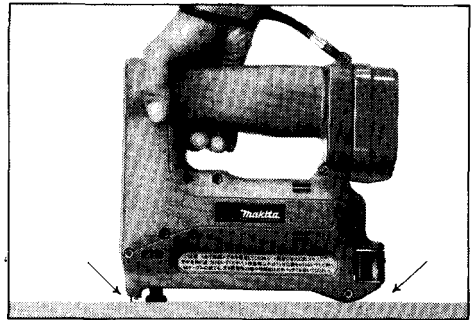

If the staples are driven too shallow, press the tool head as shown in the figure and drive the staples.

If the staples are still driven too shallow, adjust the driving depth by turning the nut clockwise. Refer to "Depth adjustment".

### CAUTION:

Do not operate the tool without staples. It shortens the service life of the tool.

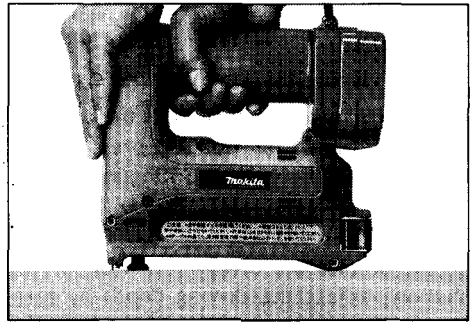

If the tool becomes jammed, do as follows. First, remove the battery cartridge. Open the sub-magazine and remove the stuck staple using a screwdriver or the like.

## Sight window

There is a convenient sight window on the tool side. Use this sight window to check if there are staples in the magazine. When staples are not visible through the window, load staples into the magazine.

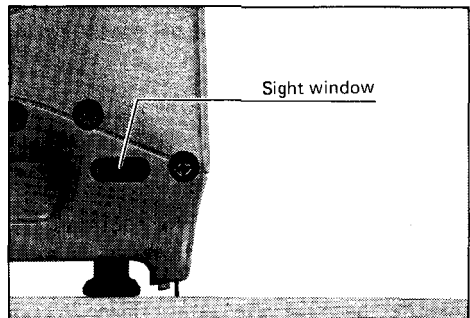

## Staples

- Handle the staples and their box carefully. If the staples have been handled roughly, they may be bent out of shape, causing poor staple feed or jamming.
- Avoid storing the staples in a very humid or hot place or place exposed to direct sunlight.
- Do not attempt to use staples that appear to be damaged, bent, rusty or corroded.

## **MAINTENANCE**

### **CAUTION:**

Always remove the battery cartridge before attempting to perform inspection or maintenance.

To maintain product **SAFETY** and **RELIABILITY**, repairs, maintenance or adjustment should be performed by Makita Authorized or Factory Service Centers, always using Makita replacement parts only.

# ACCESSORIES

**CAUTION:**

These accessories or attachments are recommended for use with your Makita tool specified in this manual. The use of any other accessories or attachments might present a risk of injury to persons. The accessories or attachments should be used only in the proper and intended manner.

● **Staples**

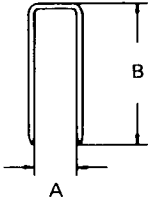

| Part No. | A (mm)      | B (mm)      | No. staples/case        |
|----------|-------------|-------------|-------------------------|
| 798373-0 | 10 (13/32") | 10 (13/32") | 5,000<br>(100 x 50 set) |
| 798374-8 | 10 (13/32") | 13 (1/2")   |                         |
| 798375-6 | 10 (13/32") | 16 (5/8")   |                         |
| 798376-4 | 10 (13/32") | 19 (3/4")   |                         |
| 798377-2 | 10 (13/32") | 22 (7/8")   |                         |

- **1 hour fast charger**  
Model DC9700  
Part No. 113103-2

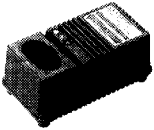

- **Battery cartridge 9100**  
Part No. 192019-4

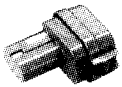

- **Battery cover**  
Part No. 414938-7



- **1 hour fast automotive charger**  
Model DC9112  
Part No. 113110-5



- **Plastic carrying case**  
Part No. 182403-1



- **15 minute fast charger**  
Model DC9015  
Part No. 113106-6

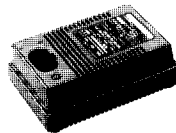

# CORDLESS STAPLER Model T221D

**Type 1**

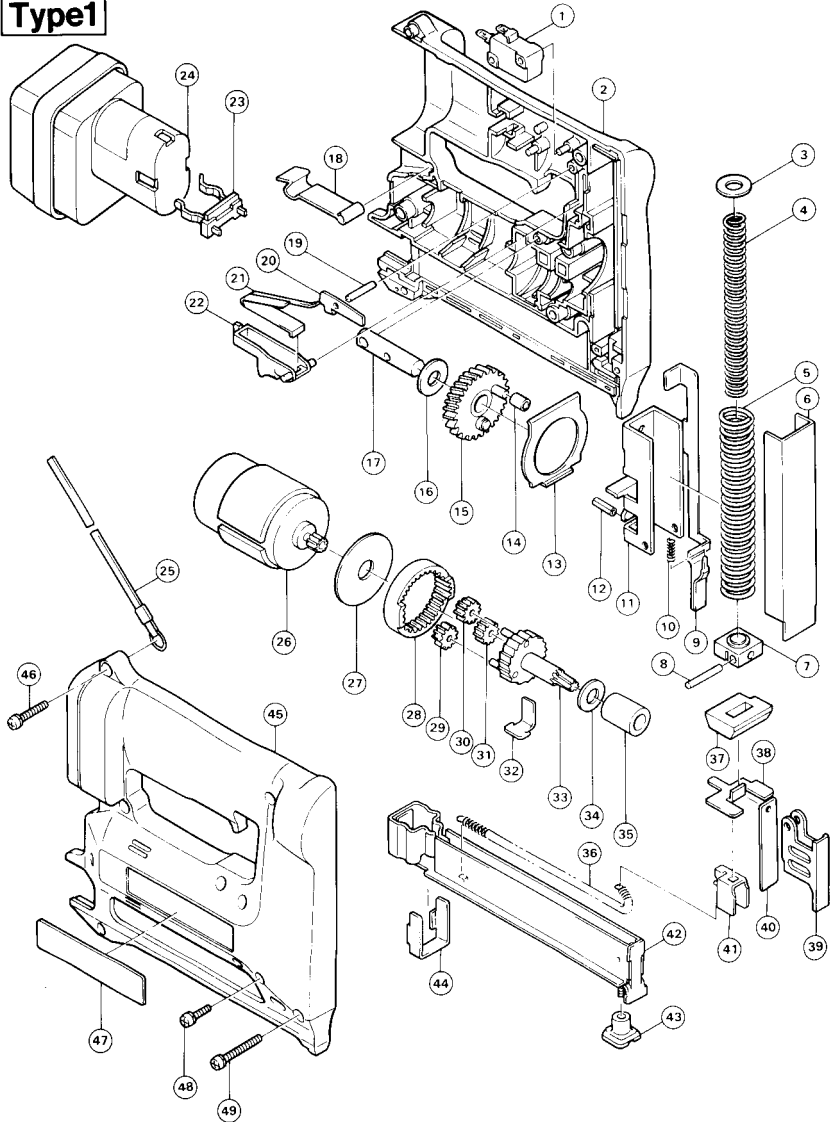

Note: The switch and other part configurations may differ from country to country.

| ITEM NO.       | NO. USED | DESCRIPTION                | ITEM NO.       | NO. USED | DESCRIPTION                        |
|----------------|----------|----------------------------|----------------|----------|------------------------------------|
| <u>MACHINE</u> |          |                            | <u>MACHINE</u> |          |                                    |
| 1              | 1        | Switch                     | 26             | 1        | D.C. Motor 9.6 V                   |
| 2              | 1        | Housing Set (With Item 45) | 27             | 1        | Flat Washer 12                     |
| 3              | 1        | Flat Washer 9              | 28             | 1        | Internal Gear 69                   |
| 4              | 1        | Compression Spring 9       | 29             | 1        | Spur Gear 27                       |
| 5              | 1        | Compression Spring 13      | 30             | 1        | Spur Gear 27                       |
| 6              | 1        | Guide Plate                | 31             | 1        | Spur Gear 27                       |
| 7              | 1        | Driver Lock                | 32             | 1        | Leaf Spring                        |
| 8              | 1        | Pin 4                      | 33             | 1        | Helical Gear 7                     |
| 9              | 1        | Safety Lever               | 34             | 1        | Flat Washer 10                     |
| 10             | 1        | Compression Spring 3       | 35             | 1        | Plane Bearing 10                   |
| 11             | 1        | Hammer                     | 36             | 1        | Tension Spring 4                   |
| 12             | 1        | Spring Pin 4—14            | 37             | 1        | Cushion                            |
| 13             | 1        | Plate                      | 38             | 1        | Pusher Guide                       |
| 14             | 1        | Sleeve 4                   | 39             | 1        | Driver Guide                       |
| 15             | 1        | Helical Gear 53            | 40             | 1        | Driver                             |
| 16             | 1        | Flat Washer 10             | 41             | 1        | Pusher                             |
| 17             | 1        | Pin 10                     | 42             | 1        | Sub Magazine                       |
| 18             | 1        | Set Plate                  | 43             | 1        | Nut M4                             |
| 19             | 1        | Pin 3                      | 44             | 1        | Magazine Lock                      |
| 20             | 1        | Release Plate              | 45             | 1        | Housing Set (With Item 2)          |
| 21             | 1        | Leaf Spring                | 46             | 6        | Pan Head Screw M4x22 (With Washer) |
| 22             | 1        | Switch Lever               | 47             | 1        | Name Plate                         |
| 23             | 1        | Battery Holder             | 48             | 3        | Pan Head Screw M4x14 (With Washer) |
| 24             | 1        | Battery 9100               | 49             | 2        | Pan Head Screw M4x30 (With Washer) |
| 25             | 1        | Hand Strap                 |                |          |                                    |

Note: The switch and other part specifications may differ from country to country.

## MAKITA LIMITED ONE YEAR WARRANTY

### Warranty Policy

Every Makita tool is thoroughly inspected and tested before leaving the factory. It is warranted to be free of defects from workmanship and materials for the period of ONE YEAR from the date of original purchase. Should any trouble develop during this one-year period, return the COMPLETE tool, freight prepaid, to one of Makita's Factory or Authorized Service Centers. If inspection shows the trouble is caused by defective workmanship or material, Makita will repair (or at our option, replace) without charge.

This Warranty does not apply where:

- repairs have been made or attempted by others;
- repairs are required because of normal wear and tear;
- The tool has been abused, misused or improperly maintained;
- alterations have been made to the tool.

IN NO EVENT SHALL MAKITA BE LIABLE FOR ANY INDIRECT, INCIDENTAL OR CONSEQUENTIAL DAMAGES FROM THE SALE OR USE OF THE PRODUCT. THIS DISCLAIMER APPLIES BOTH DURING AND AFTER THE TERM OF THIS WARRANTY.

MAKITA DISCLAIMS LIABILITY FOR ANY IMPLIED WARRANTIES, INCLUDING IMPLIED WARRANTIES OF "MERCHANTABILITY" AND "FITNESS FOR A SPECIFIC PURPOSE," AFTER THE ONE-YEAR TERM OF THIS WARRANTY.

This Warranty gives you specific legal rights, and you may also have other rights which vary from state to state. Some states do not allow the exclusion or limitation of incidental or consequential damages, so the above limitation or exclusion may not apply to you. Some states do not allow limitation on how long an implied warranty lasts, so the above limitation may not apply to you.

**Makita Corporation**

3-11-8, Sumiyoshi-cho,  
Anjo, Aichi 446 Japan

883849 - 063

PRINTED IN JAPAN

1993 - 4 - N

## Free Manuals Download Website

<http://myh66.com>

<http://usermanuals.us>

<http://www.somanuals.com>

<http://www.4manuals.cc>

<http://www.manual-lib.com>

<http://www.404manual.com>

<http://www.luxmanual.com>

<http://aubethermostatmanual.com>

Golf course search by state

<http://golfingnear.com>

Email search by domain

<http://emailbydomain.com>

Auto manuals search

<http://auto.somanuals.com>

TV manuals search

<http://tv.somanuals.com>