

INTRODUCTION

Designed for installation in new homes, the dmc1 is a whole-house music and communication system. It is designed to provide years of enjoyment and service to the homeowner. M&S Systems brand audio products are backed with more than 50 years of experience in the design and manufacture of precision acoustical equipment for the home. To ensure that the homeowner receives the high-quality music and voice reproduction that the system is designed to deliver, it is important that each step of the installation be carefully completed by the installer. In the event you need troubleshooting assistance, please call our technical support staff at 1-800-421-1587.

dmc1 MUSIC/COMMUNICATIONS SYSTEM FINISH-OUT INSTRUCTIONS



CAUTION !

The exclamation point within an equilateral triangle is intended to alert the user to the presence of important operating and maintenance (servicing) instructions in the literature accompanying the product.



SHOCK HAZARD !

The lightning flash with arrowhead symbol within an equilateral triangle is intended to alert the user to the presence of un-insulated "dangerous voltage" within the product's enclosure that may be of sufficient magnitude to constitute a risk of electric shock to persons.

IMPORTANT SAFETY INSTRUCTIONS

Read Instructions - All the safety and operating instructions should be read before installing or operating the dmc1.

Retain Instructions - The safety and operating instructions should be retained for future reference.

Heed Warnings - All warnings on the appliance and in the operating instructions should be adhered to.

Follow Instructions - All operating and use instructions should be followed.

Water and Moisture - The appliance should not be used near water - for example: near bathtub, washbowl, kitchen sink, laundry tub, in a wet basement, or near a swimming pool, and the like. Doing so can create a fire or shock hazards and impair the warranty.

Cleaning - Use only a dry cloth.

Attachments - Do not use attachments not recommended by the product manufacturer as they may cause hazards.

Ventilation - The appliance should be situated so that its location or position does not interfere with its proper ventilation. For example, the appliance should not be situated on a bed, sofa, rug, or similar surface that may block the ventilation openings; or, placed in a built in installation, such as a bookcase or cabinet that may impede the flow of air to the ventilation openings.

Heat - The appliance should be situated away from heat sources such as radiators, heat registers, stoves, or other appliances (including amplifiers) that produce heat.

Power Sources - The appliance should be connected to a power supply only of the type described in the rough-in instructions or as marked on the appliance.

Grounding or Polarization - Precautions should be taken so that the grounding or polarization means of an appliance is not defeated.

Power Lines - An outdoor antenna should be located away from power lines.

Outdoor Antenna Grounding - If an outside antenna is connected to the receiver, be sure the antenna system is grounded so as to provide some protection against voltage surges and built up static charges. Section 810 of the National Electrical Code, ANSI/NFPA No. 70 1984, provides information with respect to proper grounding of the mast and supporting structure, grounding of the lead in wire to an antenna discharge unit, size of grounding conductors, location of antenna discharge unit, connection to grounding electrodes, and requirements for the grounding electrode (see figure).

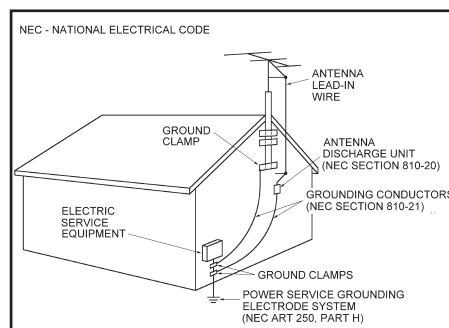

Object and Liquid Entry - Never push objects of any kind into this product through openings as they may touch dangerous voltage points or short out parts that could result in a fire or electric shock. Never spill liquid of any kind on the product.

Fuses - For continued protection against risk of fire, replace the fuses in the Master Station or CD Player unit only with the same type and rating 3 Amp Slo-blo fuses.

Servicing - The user should not attempt to service the appliance beyond that described in the operating instructions. All other servicing should be referred to qualified service personnel.

Damage Requiring Service - The appliance should be serviced by qualified service personnel when:

- The power supply cord or the plug has been damaged; or
- Objects have fallen, or liquid has been spilled into the appliance; or
- The appliance has been exposed to rain; or the appliance does not appear to operate normally or exhibits a marked change in performance; or
- The appliance has been dropped, or the enclosure damaged.
- When the product exhibits a distinct change in performance - this indicates a need for service.

Replacement Parts - When replacement parts are required, be sure the service technician has used replacement parts specified by the manufacturer or have the same characteristics as the original part. Unauthorized substitutions may result in fire, electric shock, or other hazards.

Safety Check - Upon completion of any service or repairs to this product, ask the service technician to perform safety checks to determine that the product is in proper operating condition.

Wall or Ceiling Mounting - The product should be mounted to a wall or ceiling only as recommended by the manufacturer.

Linear[®]
Building On Innovation.

USA & Canada (800) 421-1587 & (800) 392-0123
(760) 438-7000 - Toll Free FAX (800) 468-1340
www.linearcorp.com

TABLE OF CONTENTS

Tools Required	2	External Music Source	4
Room Station Installation	2	Intercom Master Station Installation	4
Patio Station installation	2	Powering Up the System	9
Door Station Installatoin	3	2-Year Limited Warranty	Back Cover
Satellite Volume Controls	3		

IMPORTANT DO'S & DON'TS

- ✓ **DO** ensure that all instructions have been followed before power is applied to system. The installation shall be carried out in accordance with all applicable installation rules.
- ✓ **DO** use only M&S systems brand cable (except for Cat-5 & RG-6) as called out in these instructions. The cable is designed and constructed with electrical specifications necessary for proper audio performance.
- ✓ **DO** use only a dry cloth to clean the exterior plastics on the dmc1 Master Station and Room Stations. **DO NOT** use liquid or aerosols.
- ✓ **DO** make gradual bends of the cable where necessary -- no sharper than 1" radius.
- ✓ **DO** dress the cables neatly with cable ties or Velcro™ wraps. Use loose or moderate pressure.
- ✓ **DO** use cable-pulling lubricant only for cable runs that may otherwise require great force to install. When cable lubricant is used, read the instructions to be sure it is compatible with the cable jacket material (PVC or FEP).
- ✓ **DO** avoid stressing cable conductors, limit pulling tension to 25 pounds or less as specified by EIA/TIA-568A standard. Pull cables gradually and with constant tension, taking care not to crush or pinch bundles.
- ✓ **DO** use grommets to protect the cable where passing through metal studs or anything that can possibly damage them.
- ✓ **DO** test every installed cable run with a cable tester. "Toning" alone is not acceptable.
- ✓ **DO** label every termination point. Use a unique identifier for each cable run. It will make moves, adds, changes, and troubleshooting easier.
- ✓ **DO** support horizontal cable bundles using board supports, J-hooks, or cable trays.
- ✓ **DO** have signal cables cross at right angles to power cables to minimize induced interference.
- ✓ **DO** always obey all local and national fire and building codes. Be sure to "firestop" all cables that penetrate a firewall. Use plenum-rated cable where mandated.
- ✓ **DO** follow the grounding and bonding requirements established by Electrical Code TIA standard 607, and equipment manufacturer's specifications.
- ✓ **DO NOT** locate the dmc1 Master Station or Room Stations in an exterior wall.
- ✓ **DO NOT** locate the dmc1 Master Station or Room Stations in any wall cavity with any other electrical wiring in the cavity.
- ✓ **DO NOT** locate Patio Stations in places with direct exposure to sun and weather or in locations that receive direct water spray.
- ✓ **DO NOT** attach non line-level audio devices or non M&S authorized equipment to the system.
- ✓ **DO NOT** power up Master Station until all speakers and stations are connected.
- ✓ **DO NOT** splice or repair cables damaged during wire pulling, install a new cable.
- ✓ **DO NOT** coil or bundle the cables. This can cause electronic feedback.
- ✓ **DO NOT** over-tighten the screws for the volume controls, speakers, or the intercom Master Station to prevent cracking.
- ✓ **DO NOT** install any station or speaker cables inside the 120 VAC transformer enclosure.
- ✓ **DO NOT** tie cables to electrical conduits or lay cables on electrical fixtures. Keep cables at least 16" away from fluorescent lights, HID light fixtures, or dimmers.
- ✓ **DO NOT** allow the cable to be sharply bent or kinked at any time.
- ✓ **DO NOT** install cables "taught" in the ceiling or elsewhere. A good installation should have cables loose, but never sagging.
- ✓ **DO NOT** run signal cables parallel to power cables without adequate separation to minimize induced interference.
- ✓ **DO NOT** exert more than 25 pounds of tension on 4-pair cables.
- ✓ **DO NOT** step on Cat-5 cable during installation.
- ✓ **DO NOT** overtighten the cable ties, apply cable ties loosely, with random spacing.
- ✓ **DO NOT** untwist the wire pairs in Cat-5 cable more than 1/2" to avoid crosstalk.

WIRING CAUTIONS

- A licensed electrician must run a 120 VAC line from **A DEDICATED 15-AMP BREAKER** to the dmc1 (and dmc1CD or dmc1MM, if equipped) transformer.
- Use Cat-5 wire for all dmc1 wire runs excluding Door Station wire runs. For Door Stations, use the M&S Systems brand MS4DCXSC wire that is included with the dmc1H or dmc1HC wall housing kits.
- Individual wire runs should not exceed 350 feet from any single room or Door Station to the dmc1 Master Station or 1000 feet total for the entire system.
- Label all wire runs. Connecting the wires to the dmc1 Master Station, Room Station, or Door Station incorrectly may result in system damage.
- Run a single cable from the Master Station unit location to each Room Station and Door Station in a "home run" fashion. Do not loop cable from one Room Station to another.
- **DO NOT STAPLE CABLES.** Staples cause shorts.
- **DO NOT SPLICE CABLES.** Splices are unreliable and defeat the signal isolation properties of the cable.
- **KEEP CABLES AT LEAST 18 INCHES FROM FLUORESCENT LIGHT FIXTURES, DIMER CONTROLS, AND ALL OTHER WIRING.** This includes AC wiring, security cable, and other control wires. These can cause a "hum" or "buzzing" sound.
- Keep cables away from objects such as heating and air conditioning ducts, metal construction plates, and anything else with sharp edges that can damage the cables.

ROOM STATION CAUTIONS

Careful consideration should be used when determining the location of the Room Stations. **DO NOT** install these devices in the following locations:

- ✓ **DO NOT** install Room Stations near air return ducts.
- ✓ **DO NOT** install Room Stations in exterior walls. Insulation materials will change speaker range and efficiency. Temperature changes in the wall will reduce speaker life.
- ✓ **DO NOT** install Room Stations in saunas. They will not withstand the extreme heat and moisture.
- ✓ **DO NOT** install Room Stations underneath cabinets or over counter tops.
- ✓ **DO NOT** install Room Stations in stud cavities with other wiring or appliances.
- ✓ **DO NOT** install Room Stations within 10 feet of other Room Stations or the dmc1 Master Station unit. This will cause acoustical feedback.
- ✓ **DO NOT** install Room Stations in stud cavities with other Room Stations or the dmc1 Master Station unit. This will cause acoustical feedback.
- ✓ **DO NOT** install Room Stations facing each other Room Stations or the dmc1 Master Station unit. This will cause acoustical feedback.

Be sure that all Room Station mounting rings are level and oriented as shown in these instructions.

Failure to adhere to these instructions can cause equipment malfunction and void any warranty covered by Linear LLC.

FINISH-OUT CAUTIONS

- ✓ **DO NOT** install the dmc1 system until after the application of any wall covering material.
- ✓ **DO NOT** install any satellite speakers that are rated other than 45-ohms impedance. Damage to the amplifier will occur.
- ✓ **DO NOT** power up the dmc1 Master Station unit until all remote stations and speakers are connected.
- ✓ **DO NOT** connect Cat-5 wire if you are unsure of its terminating point. Connecting a door speaker to a Room Station may result in system damage.
- ✓ **DO** ensure that all rough-in instructions have been followed before power is applied to the dmc1 system.
- ✓ **DO NOT** attach devices unauthorized for use with this system. Authorized devices include: (1) dmc1MM CD/MP3/iPod® Player; (2) dmc1CD 6-disc CD Player; (3) Audio components connected via the line level or docking inputs.
- ✓ **DO NOT** install Patio Stations in locations subject to direct sunlight or water spray. Patio stations **MUST** be installed in protected areas such as a covered patio or porch.

- ✓ **DO NOT** connect extra cables that may have been run for future speaker additions. Care must be taken to ensure these cables are not connected to the dmc1 Master Station unit. Un-terminated cables (no station) connected to the dmc1 Master Station may cause electronic feedback that will damage the Master Station unit.
- ✓ **DO NOT** over-tighten the screws for the remote stations or the Master Station as the plastic face panels may crack or strip out.
- ✓ **Use only** M&S Systems certified replacement parts and have them installed by a qualified dealer or installer. Unauthorized substitutions can result in fire, electric shock, or other hazards.
- ✓ **Upon completion** of any service or product repair, have the dealer or installer conduct a safety check to ensure the system is in proper operating condition.
- ✓ **Use only** a damp cloth to clean the dmc1 Master Station and Room Stations. Do not use liquid cleaners or aerosol cleaners.

Failure to adhere to these instructions can cause equipment malfunction and void any warranty covered by Linear LLC.

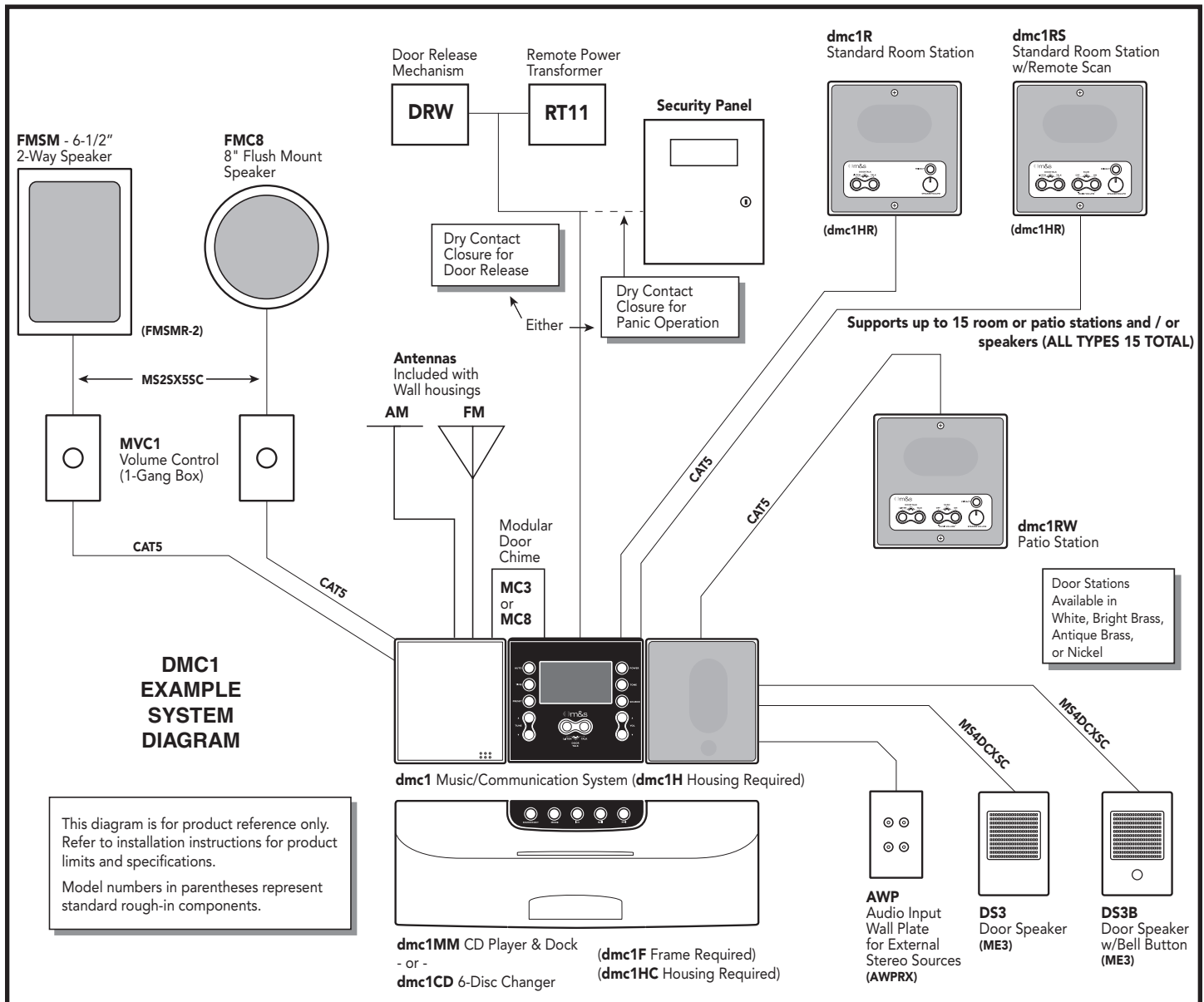

Figure 1. System Diagram

TOOLS REQUIRED

The finish-out installation should be made after the application of any wall covering material.

The tools required for the installation finish-out are:

- #2 Phillips screwdriver
- Standard flat head screwdriver
- Wire stripper/cutter
- Level

ROOM STATION INSTALLATION

1. Collect all the connectors included in the Room Station packages and place them in the wall housing for use later.
2. At each Room Station location, strip approximately 4 inches of jacket from the Cat-5 cable and separate the colored wires. Strip 1/2 inch of insulation from each wire as shown in Figure 2.
3. Connect each colored wire to its respective screw terminal in the Room Station. Note that some screw terminals have more than one wire connected to them.
4. Mount each Room Station to its mounting ring using the two screws provided with each dmc1 Room Station as shown in Figure 3.

PATIO STATION INSTALLATION

Use wire nuts for the following connections.

1. At each Patio Station location, strip approximately 4 inches of jacket from the Cat-5 cable and separate the colored wires. Strip 1/2 inch of insulation from each wire as shown in Figure 2.
2. Connect ORANGE wire to the ORANGE wire on the Patio Station.
3. Connect BLUE wire to the BLUE wire on the Patio Station.
4. Connect ORANGE/WHITE wire to the ORANGE/WIRE wire on the Patio Station.
5. Connect GREEN/WHITE wire to the GREEN/WIRE wire on the Patio Station.
6. Connect GREEN and BROWN/WHITE wires to the GREEN wire on the Patio Station.
7. Connect BROWN and BLUE/WHITE wires to the BROWN wire on the Patio Station.
8. Mount the Patio Station to the housing using the two screws provided with the Patio Station.

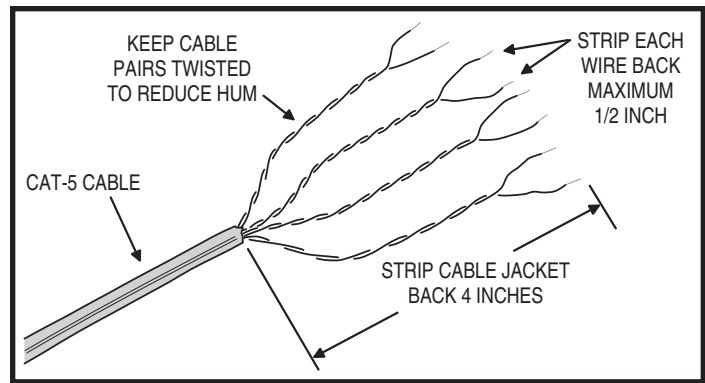

Figure 2. Cat-5 Wire Preparation

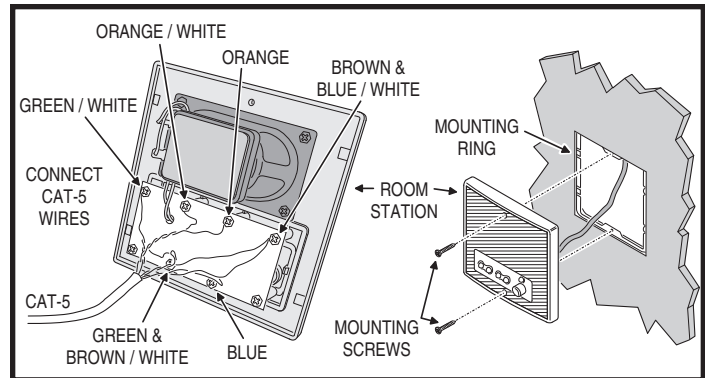

Figure 3. Attaching Room Station

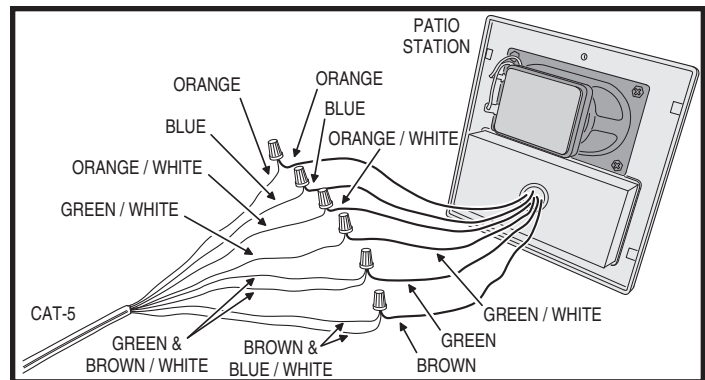

Figure 4. Patio Station Wiring Connections

DOOR STATION INSTALLATION

Door stations are an intercom speaker that mounts by a home entrance door. Models are available with and without a doorbell button.

1. At each Door Station location, strip approximately 4 inches of jacket from the cables and separate the colored wires. Strip 1/2 inch of insulation from each wire.
2. At the Door Station end of the cable, cut off the cable's drain wire (the shield wire) all the way back to the cable sheath to prevent it from shorting to any Door Station parts.
3. If the Door Station has a bell button, connect the YELLOW and ORANGE to the bell button's screw terminals (either wire to either terminal).
4. Use a wire nut to connect the RED wire to the RED Door Station speaker wire.
5. Use a wire nut to connect the BLACK wire to the BLACK Door Station speaker wire.
6. Tuck the wires into the enclosure and mount the Door Station using the two screws provided.

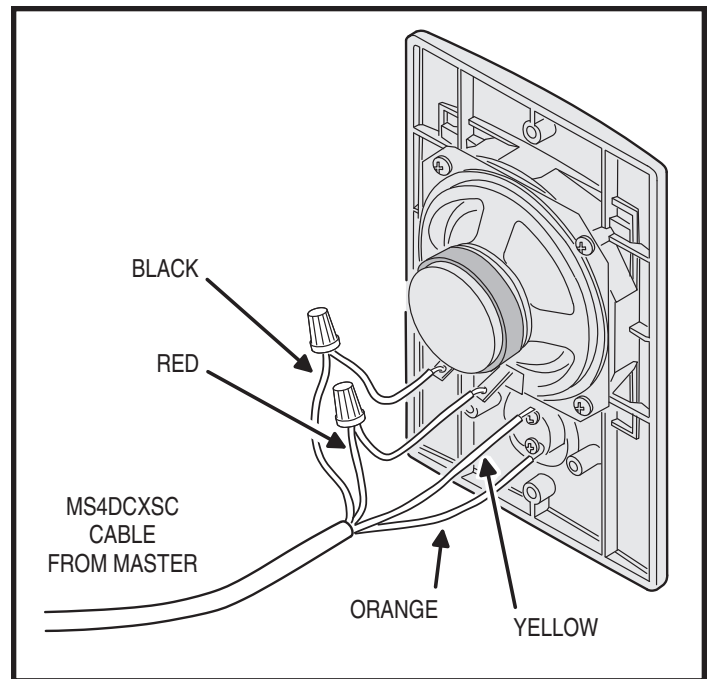

Figure 5. Door Station Installation

SATELLITE VOLUME CONTROLS

Monaural 45-ohm speakers can be connected to the dmc1 Master Station to distribute radio, CD, or portable music player sound throughout the installation. Each mono speaker is controlled by a single Model MVC1 (white) or MVC1A (almond) volume control that mounts in a single-gang J-box.

⚠ CAUTION ⚠

ANY SPEAKER CONNECTED TO THE DMC1 MUST BE 45 OHMS!
Do not connect any 8 ohm speakers or damage to the dmc1 Master Station will occur!

Use wire nuts for the following connections.

1. At each volume control location, strip approximately 4 inches of jacket from the cables and separate the colored wires. Strip 1/2 inch of insulation from each wire.
2. Connect the SHIELD wire from the MS2SX5SC cable that goes to the speaker location to the RED wire from the MVC1 volume control **and** to the BROWN and WHITE/BLUE wires from the Cat-5 cable that goes to the dmc1 Master Station. (Four wires in this wire nut, this is the ground connection.)
3. Connect the GREEN and WHITE/BROWN wires from the Cat-5 cable that goes to the dmc1 Master Station to the GREEN wire from the MVC1 volume control. (Three wires in this wire nut, this is the audio signal connection.)
4. Connect the BLUE wire from the MS2SX5SC cable that goes to the speaker location to the BLUE wire from the MVC1 volume control. (Two wires in this wire nut, this is the speaker – connection.)
5. Connect the VIOLET wire from the MS2SX5SC cable that goes to the speaker location to the VIOLET wire from the MVC1 volume control. (Two wires in this wire nut, this is the speaker + connection.)
6. Tuck the wires into the J-box and mount the MVC1 volume control to the J-box using the two screws provided.

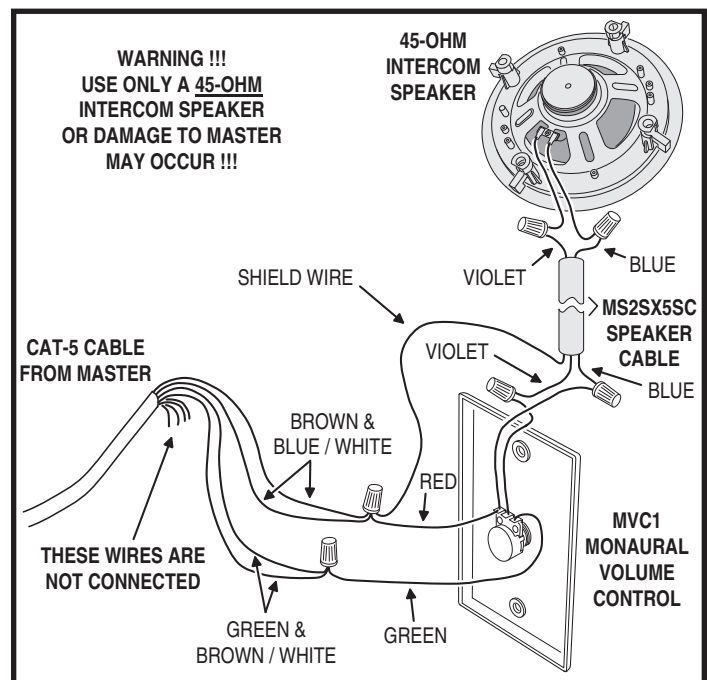

Figure 6. MVC-1 Volume Control Wiring

EXTERNAL MUSIC SOURCE

The dmc1 Master Station can play audio from an external source. The Model AWP (white) or Model AWPA (almond) Audio Input Wall Plate features two stereo pairs of RCA jacks that can be connected to a stereo receiver, television, DVD, or portable music player.

1. At the location for the audio input wall plate, access the left and right audio cables that were routed to the J-box during the system rough-in.
2. Connect the RCA plugs to each of the RCA jacks on the rear of the AWP wall plate. Two "Y" adapters (not supplied) can be used to combine the two left and two right line level input jacks on the AWP wall plate so the homeowner can use either pair of input jacks.
3. Tuck the cables into the J-box and mount the AWP audio input wall plate to the J-box using the two screws provided.

INTERCOM MASTER STATION INSTALLATION

The dmc1 Master Station connects to the room, patio, and Door Station wires at the wall housing location. All other connections to the Master Station are also made at the wall housing location.

To ensure good electrical and mechanical connections, and to avoid service call-backs, refer to the following steps and the associated figures when terminating wires. Stations are supplied with screw-down Cat-5 connectors, press-on type Cat-5 connectors may also be included.

Screw-down Connector Cable Termination

1. Gather all room, patio, and Door Station cables together and cut them to the same length leaving approximately 12 inches entering into the wall housing. **BE SURE THAT THE CABLES REMAIN LABELED.**
- ✓ **IMPORTANT:** Verify all cable run locations prior to connecting if they were not labeled at rough-in. Incorrectly connecting cables to the Master Station, Room Stations, or Door Stations may result in system damage.
2. Strip back the outer insulation jacket of the room and Patio Station Cat-5 cables 2 inches to expose the four color coded twisted wire pairs inside. Strip back each of the eight wires 1/4" maximum (see Figure 8).
3. Observing the color code label on the connector, insert a wire pair (solid color wire and wire with the same color stripe) completely into the connector terminal holes (see Figure 9). **TO PREVENT SHORTS, BE SURE THE WIRES ARE COMPLETELY INSERTED.**
4. Tighten the connector terminal screws to secure the wire pair. Repeat Steps 4 & 5 for the other three colored wire pairs.
5. Repeat Steps 2-4 for each of the Cat-5 cables.

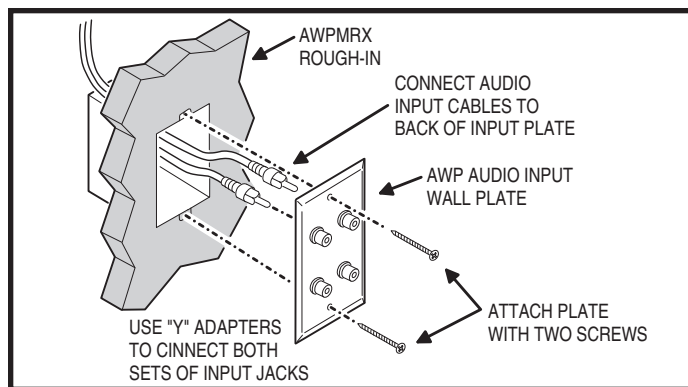

Figure 7. AWP Audio Wall Plate Wiring

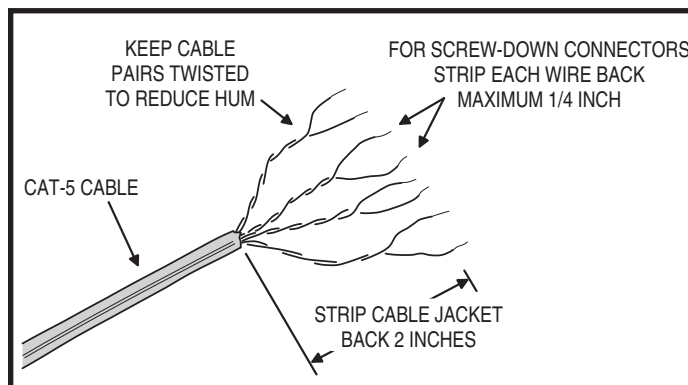

Figure 8. Cat-5 Cable Preparation for Screw-down Connectors

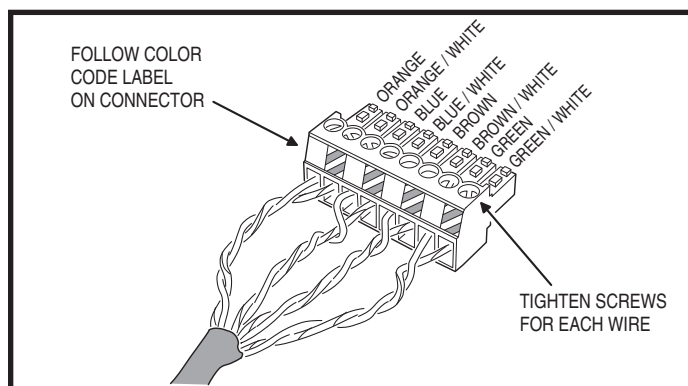

Figure 9. Completed Screw-down Connector Assembly

Press-on Connector Cable Termination

1. Gather all room, patio, and Door Station cables together and cut them to the same length leaving approximately 12 inches entering into the wall housing. BE SURE THAT THE CABLES REMAIN LABELED.

✓ **IMPORTANT:** Verify all cable run locations prior to connecting if they were not labeled at rough-in. Incorrectly connecting cables to the Master Station, Room Stations, or Door Stations may result in system damage.

2. Strip back the outer insulation jacket of the room and Patio Station Cat-5 cables 2 inches to expose the four color coded twisted wire pairs inside (see Figure 10). **DO NOT STRIP THE INDIVIDUAL TWISTED PAIRS OF WIRE.** The connectors have internal sharp edge insulation displacement wire guides that cut through the insulation on the copper wires when the connector's wire latches are snapped closed.

3. Open the four clear plastic wire latches on a connector (see Figure 11).

4. Observing the color code label on the connector, insert a wire pair (solid color wire and wire with the same color stripe) completely into the two wire holes in the clear plastic wire latch for that pair color (see Figure 11). **BE SURE THE WIRES ARE COMPLETELY INSERTED.**

5. Hold the wires completely inserted while pressing down firmly on the clear plastic wire latch. The latch will click twice as the wires are being seated into the internal insulation displacement wire guides. See Figure 11. **VERIFY THAT THE TAB ON THE CONNECTOR BODY IS INSIDE THE TAB SLOT ON THE CLEAR PLASTIC WIRE LATCH.**

6. Repeat Steps 4 & 5 for the other three wire pairs on the cable. Check each wire's connection by gently pulling on the wire. With a good connection, the wire will not pull out of the connector (see Figure 12).

7. Repeat Steps 2-6 for each of the Cat-5 cables.

✓ **NOTE:** If the connector is re-opened, and any wire is removed from the connector, cut the cable back and start over.

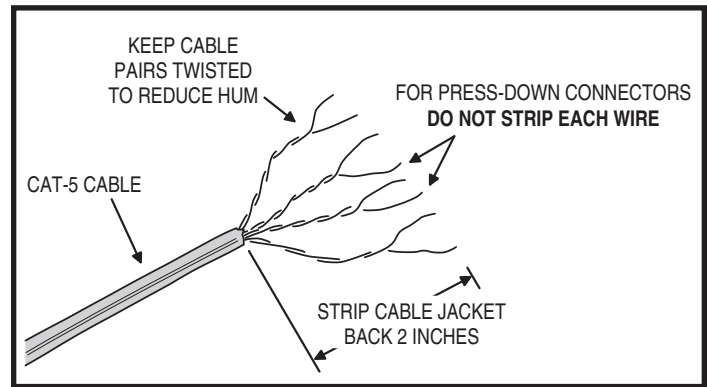

Figure 10. Cat-5 Cable Preparation for Press-on Connectors

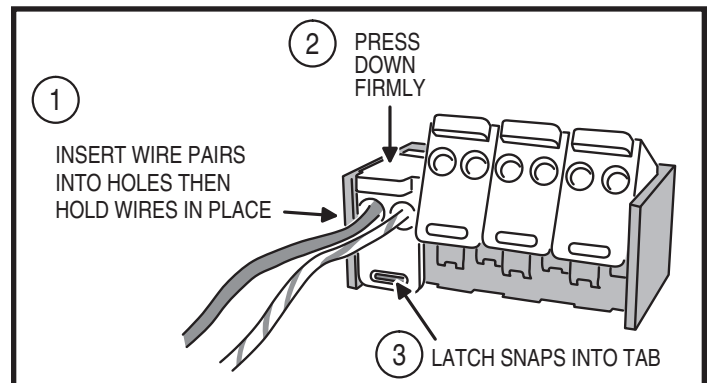

Figure 11. Latching Cat-5 Connector

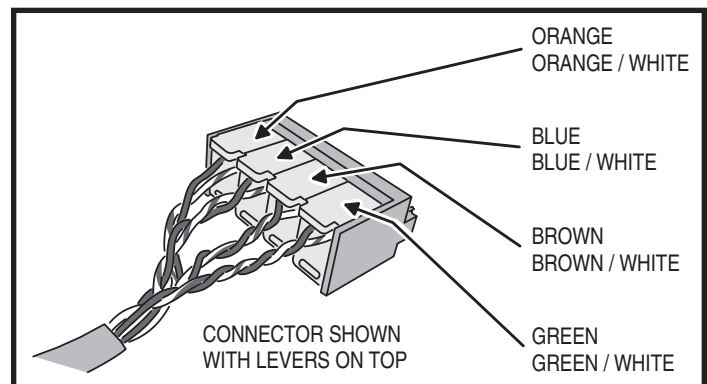

Figure 12. Completed Press-on Connector Assembly

Optional Chime Module Installation

The dmc1 supports the 3-note Model MC3 and 8-note Model MC8 chime modules. The chime module installs inside the wall housing and is activated by the Door Station pushbutton.

1. Install the chime module circuit board by snapping it onto the four plastic mounting standoffs in the wall housing. See Figure 13.

Master Station Pre-installation

To aid wiring of the Master Station unit to the cables from the wall housing, the Master Station unit contains a wire to hang the Master Station from the wall housing.

1. Suspend the Master Station unit from the wall housing by looping the third hand wire (the thick green wire) into the hook at the top of the wall housing (see Figure 14).
2. If a chime module was installed, plug the chime module's connector into the CHIME connector on the dmc1 circuit board (see Figure 15).

Room Station and Music Speaker Connection to Master Station

The dmc1 Master Station has 15 sockets for the Cat-5 quick connectors. If the system has more than nine Room Stations, **some Room Station pairs will share the same station selector switch.** Music speaker volume controls also connect to the quick connector sockets. **A MAXIMUM OF 15 SPEAKERS IN ANY COMBINATION (ROOM STATIONS, PATIO STATIONS, OR 45-OHM MUSIC SPEAKERS) CAN BE CONNECTED TO THE SYSTEM.**

1. Refer to the room number identification printed next to each connector socket on the circuit board (see Figure 16). The connector room number 1-9 identification matches the station selector switches 1-9. Stations 5, 6, 7, 8, and 9 each have two sockets for connection for two Room Stations that will share the same station selector switch.
2. Insert each Cat-5 Room Station and music speaker quick connector into the appropriate connector socket.
3. Write or label the names of the station locations in the numbered areas provided inside the dmc1 front access door.

Patio Station Connection to Master Station

One connector socket on the dmc1 Master Station is labeled for the Patio Station connection.

1. Plug the Patio Station quick connector into the PATIO socket.
-OR- If two Patio Stations are required for the installation, use the screw-type terminal connector provided with the dmc1RW Patio Station and wire both Patio Stations to the same connector and plug that connector into the PATIO socket.

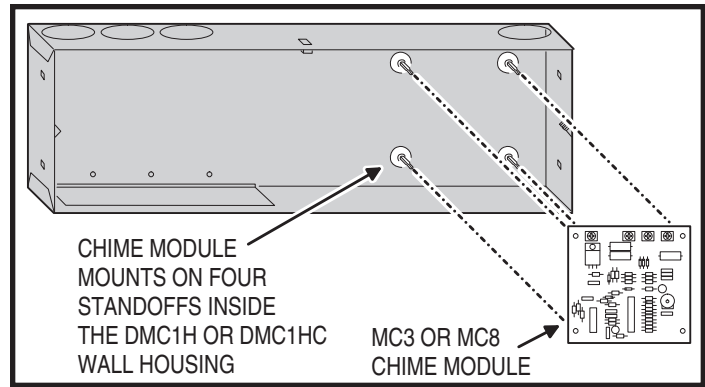

Figure 13. Optional Chime Module Installation

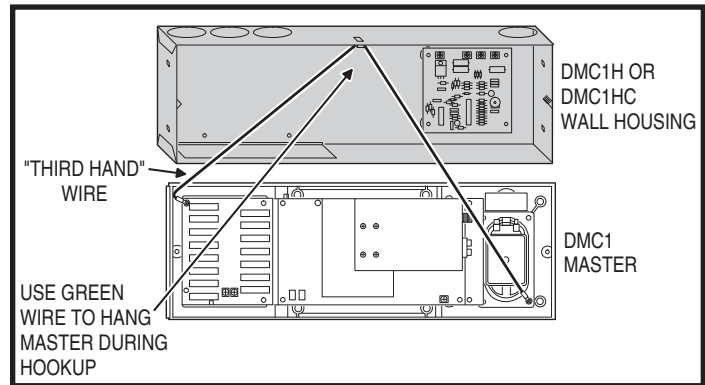

Figure 14. "Third Hand" Hanging Wire

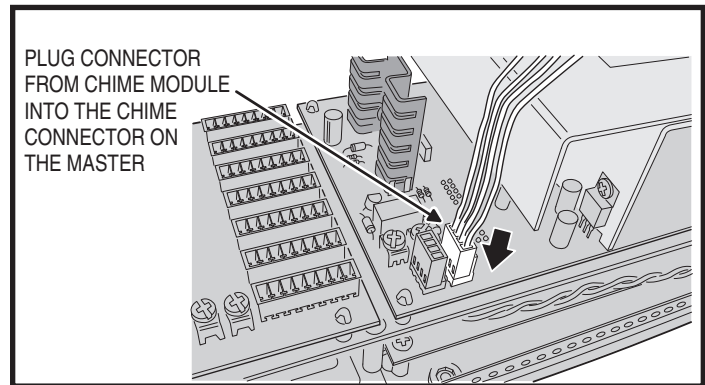

Figure 15. Chime Module Connection to Master Station

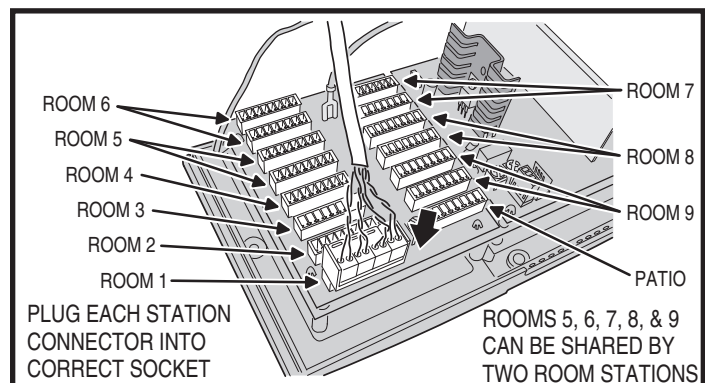

Figure 16. Station Connections on Master Station

Door Station Connection to Master Station

The Door Station connects to the two screw terminals between the quick connector sockets. If the Door Station has a bell button, it connects to the optional chime module.

1. Connect the BLACK wire from the Door Station to the screw terminal labeled DOOR BLACK on the dmc1 Master Station.
2. Connect the RED wire from the Door Station to the screw terminal labeled DOOR RED on the dmc1 Master Station.
3. Connect the ORANGE wire from the Door Station to the screw terminal labeled COMMON on the chime module (if chime is used)
4. Connect the YELLOW wire from the Door Station to one of the NOTE screw terminals on the chime module (if chime is used). DO NOT CONNECT THE YELLOW WIRE TO MORE THAN ONE NOTE TERMINAL.
5. Connect the shield wire from the Door Station to the terminal labeled SHIELDS on the dmc1 Master Station. NOTE: THE SHIELD WIRE MUST BE INSULATED TO PREVENT IT FROM TOUCHING ADJACENT COMPONENTS. SLIDE ON SOME INSULATION FROM A STRIPPED WIRE.

Antenna Connections

The dmc1 contains an AM/FM tuner. Radio reception requires installation of an AM wire lead antenna, and an FM dipole antenna. The antennas should have been installed during the rough-in and require connecting to the dmc1 Master Station.

1. The AM antenna is the single ORANGE wire lead that has the ferrite filter on it. Connect the ORANGE wire to the AM ANTENNA terminal on the side of the tuner module in the dmc1 Master Station. The GROUND terminal remains un-connected.
2. The FM antenna is the coax wire with the Type "F" connector. Connect the coax wire to the FM ANTENNA connector on the side of the tuner module in the dmc1 Master Station.

Door Release Connection

The dmc1 Master Station can be wired to a Model DRW electric door strike. The door release relay has normally open contacts that are rated at 2 Amps @ 24 Volts AC/DC. The relay can be activated from the dmc1 Master Station or remote scan Room Stations (Model dmc1RS) by pressing the volume up and volume down buttons together for four seconds. The relay will deactivate when the buttons are released.

1. Identify the two cables labeled "Door Release".
2. Use a wire nut to connect one wire from the transformer cable to one wire from the door strike.
3. Connect the remaining wires from each cable to the terminals marked DOOR RELEASE on the dmc1 Master Station.

External Music Source Connection

Audio from the optional AWP wall plate connects to the dmc1 auxiliary audio inputs.

Follow these steps if using the audio input wall plate

1. Identify the two RCA cables labeled "AUX INPUT".
2. Insert the left audio cable RCA plug into the AUX L jack on the dmc1 Master Station.
3. Insert the right audio cable RCA plug into the AUX R jack on the dmc1 Master Station.

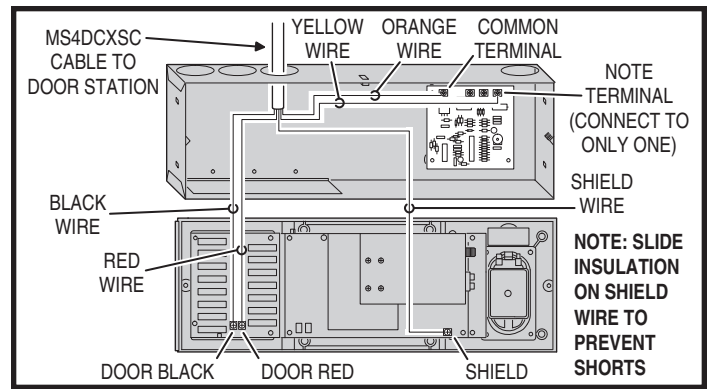

Figure 17. Door Station Master Station and Chime Connections

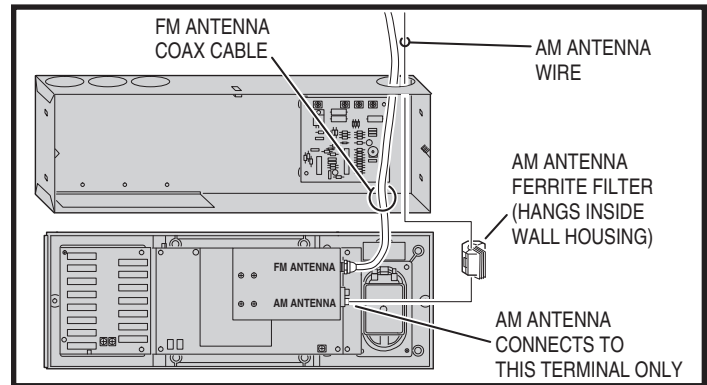

Figure 18. AM and FM Antenna Connections

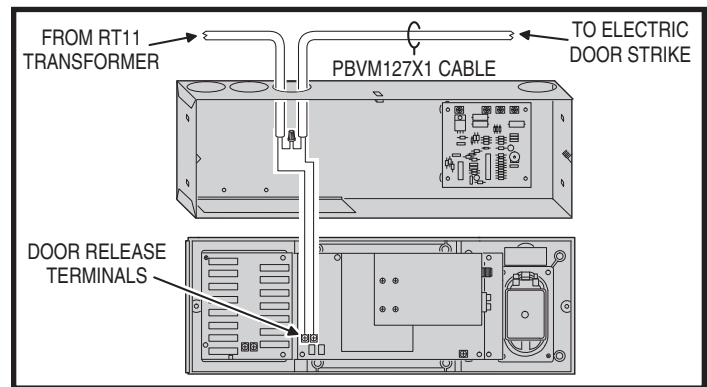

Figure 19. Door Release Wiring

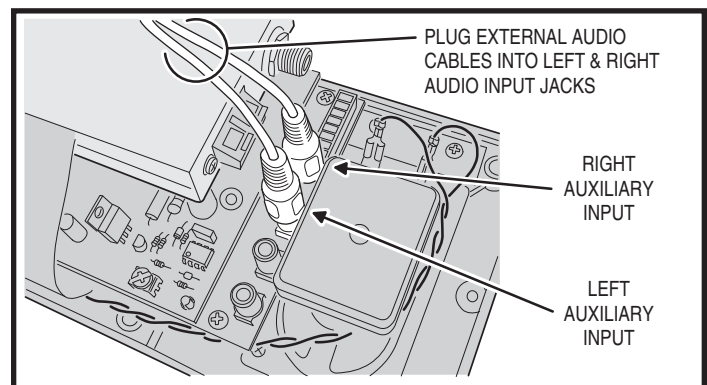

Figure 20. Auxiliary Input Jacks on Master Station

Mounting in a Master Station Only Installation

When the dmc1 Master Station is used without the optional CD Player, the dmc1 mounts inside the dmc1H wall housing. Follow these steps for mounting the Master Station.

1. Verify that the circuit breaker controlling the power to the wall housing transformer is OFF.
2. Plug the connector on the dmc1 Master Station's wiring harness into the connector on the TE5D power transformer.
3. Secure the dmc1 Master Station to the wall housing using the two long screws provided (see Figure 21).
4. Install the speaker grille onto the right side of the dmc1 Master Station. BE CAREFUL NOT TO PRESS IN THE CENTER OF THE GRILLE! Only press around the edges.

Mounting the Master Station with the Optional iPlay Dock and CD Player

When the optional CD Player is included, the dmc1 Master Station and the dmc1CD 6-disc CD Player or dmc1MM iPlay™ Dock for iPod® - MP3 & CD Player mounts inside the dmc1HC combination wall housing.

Follow these steps for mounting the Master Station and CD Player:

1. Verify that the circuit breaker controlling the power to the wall housing transformers is OFF.
2. Insert one end of the CD Player interface cable into the CD interface connector on the dmc1 Master Station. This connector is located in the center of the dmc1 Master Station's middle circuit board approximately behind the two TUNE buttons (see Figure 22).
3. Insert the CD audio cable's BLACK RCA plug into the CD L jack on the dmc1 Master Station, then insert the cable's RED RCA plug into the CD R jack on the dmc1 Master Station (see Figure 23).
4. Plug the connector on the dmc1 Master Station's wiring harness into the connector on the TE5D power transformer.
5. Position the dmc1F combination mounting frame over the dmc1HC wall housing with the larger opening toward the top.
6. Be sure to route the CD interface and audio cables in through the top opening of the dmc1F frame then down and out the lower opening in the dmc1F frame.
7. Secure the dmc1 Master Station to the wall housing using the two long screws provided (see Figure 24). DO NOT OVERTIGHTEN THE SCREWS THE FRAME MIGHT DISTORT OR CRACK!
8. Install the speaker grille onto the right side of the dmc1 Master Station. BE CAREFUL NOT TO PRESS IN THE CENTER OF THE GRILLE! Only press around the edges.

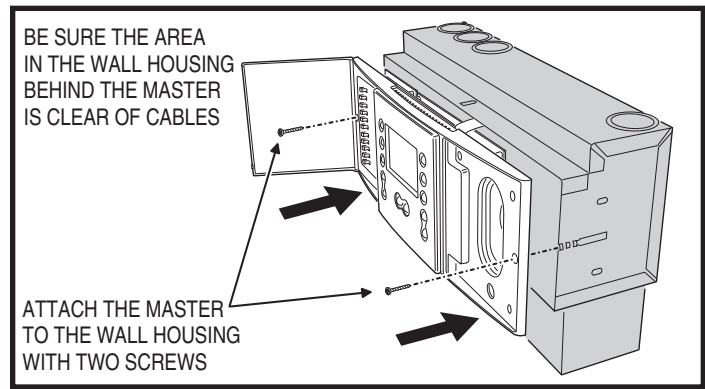

Figure 21. Master Station Only in dmc1H Wall Housing

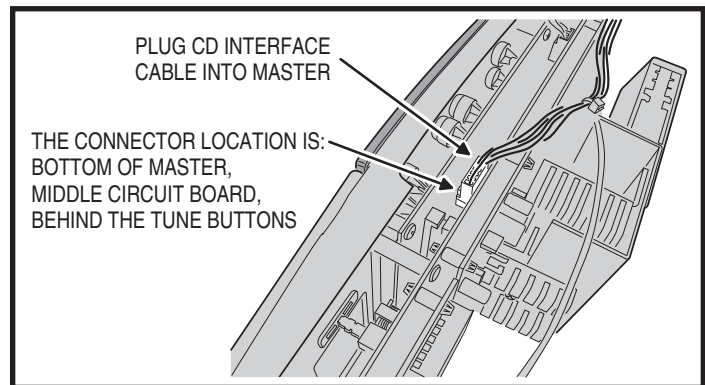

Figure 22. CD Player Interface Connection on Master Station

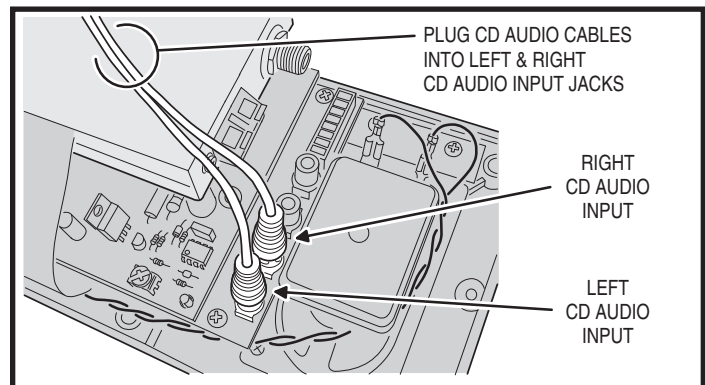

Figure 23. CD Input Jacks on Master Station

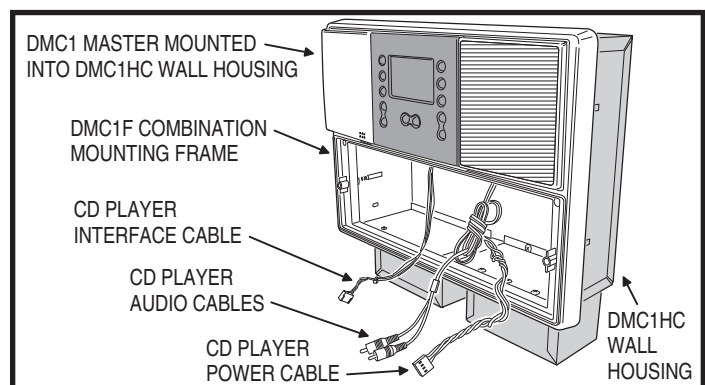

Figure 24. dmc1F Frame with Master Station, Ready for CD Player

Mounting the Master Station with the Optional CD Player (continued)

9. Insert the CD Player interface cable into the INTERFACE connector on the CD Player (see Figure 25 or 27).
10. Insert the CD audio cable's BLACK RCA plug into the AUDIO LEFT jack on the CD Player, then insert the cable's RED RCA plug into the AUDIO RIGHT jack on the CD Player (see Figure 25 or 27).
11. Plug the connector from the TE2D power transformer in the wall housing to the CD Player's POWER connector (see Figure 26 or 27).
12. Be sure that the area where the CD Player will slide into the wall housing is free of cables and connectors that might be in the way when the player is inserted.
13. Attach the CD Player to the wall housing using the two long screws provided as shown in Figure 28. DO NOT OVERTIGHTEN THE SCREWS THE FRAME MIGHT DISTORT OR CRACK!
14. If installing the dmc1CD 6-disc player, connect the EJECT button cable to the very small two-pin connector located under the lower right edge of the CD mechanism frame.
15. Install the CD Player faceplate by pressing it onto the player.

POWERING UP THE SYSTEM

After all connections have been made and the unit(s) are installed into the wall housing, follow these steps to power up the dmc1 system.

1. Turn the circuit breaker controlling the power to the wall housing transformer(s) ON.
2. Check all functions of the system. Refer to the Owner's Manual supplied with the dmc1 Master Station for operation details. If any difficulties are encountered, recheck all connections.

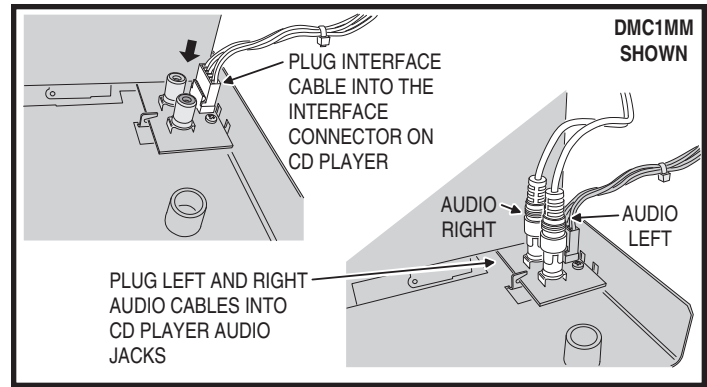

Figure 25. dmc1MM iPod® Dock MP3 & CD Player Interface and Audio Cable Connection

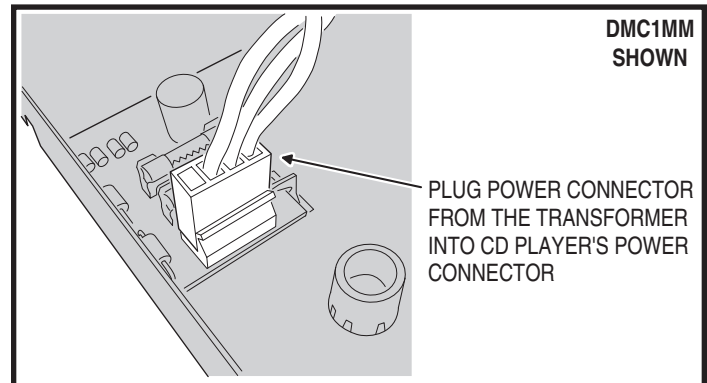

Figure 26. dmc1MM iPod® Dock MP3 & CD Player Power Connection

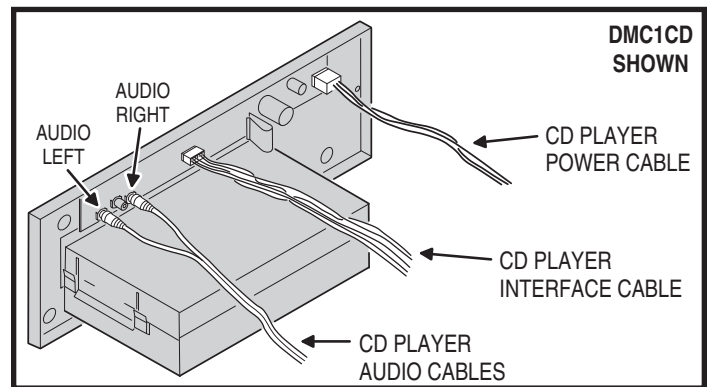

Figure 27. dmc1CD 6-Disc CD Player Connections

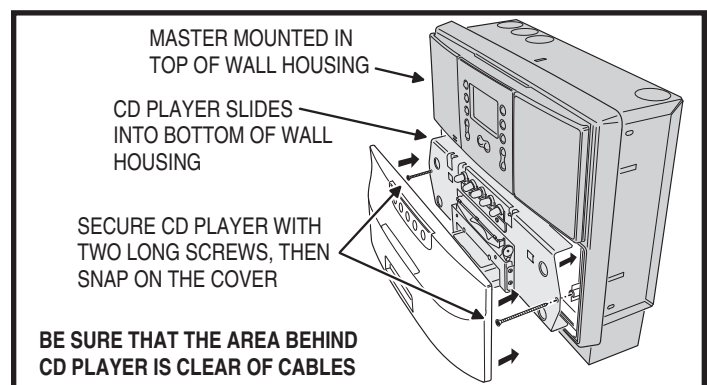

Figure 28. CD Player into Wall Housing

2-YEAR LIMITED WARRANTY

Linear LLC warrants its M&S Systems brand products to be free of defects for 2 years. The warranty period begins on either (a) the date of purchase or installation date of this product, or (b) the date of closing on a new residence in which this product was originally installed.

The warranty extends to the original user of the product and to each subsequent owner of the product during the term of the warranty. Linear will repair or replace, at its option, parts and materials at no charge. Parts supplied under this warranty may be new or rebuilt at the option of Linear.

If, during the warranty period, the product appears to have a defect, please call our toll free number (800-421-1587) prior to dismantling. Dismantling the product prior to calling our service number may void the warranty. Before returning any product to Linear, obtain a Return Product Authorization (RPA) number from our service department. Linear will return the repaired product freight prepaid within the continental United States. ANY PRODUCT RETURNED TO LINEAR WITHOUT AN RPA NUMBER WILL BE REFUSED.

This limited warranty is in lieu of any other warranties, express or implied, including any implied warranty of merchantability or fitness for a particular purpose or otherwise, and of any other obligations or liability on the seller's part. This limited warranty does not cover damage caused by improper installation, acts of God, criminal acts, the violation of applicable building or electrical codes or the use of non-M&S wire or cable (excluding CAT-5 and RG-6).

Under no circumstances shall Linear be liable for consequential, incidental or special damages arising in connection with use, or inability to use this product. In no event shall Linear's liability hereunder exceed the cost of the product covered hereby. No person is authorized to assume for us or obligate us for any other liability in connection with the sale of this product. Some states do not allow the exclusion or limitation of consequential, incidental or special damages, so the above limitation or exclusion may not apply to you. This limited warranty gives you specific legal rights, and you may also have other rights, which vary from state to state.



USA & Canada (800) 421-1587 & (800) 392-0123
(760) 438-7000 - Toll Free FAX (800) 468-1340
www.linearcorp.com

Free Manuals Download Website

<http://myh66.com>

<http://usermanuals.us>

<http://www.somanuals.com>

<http://www.4manuals.cc>

<http://www.manual-lib.com>

<http://www.404manual.com>

<http://www.luxmanual.com>

<http://aubethermostatmanual.com>

Golf course search by state

<http://golfingnear.com>

Email search by domain

<http://emailbydomain.com>

Auto manuals search

<http://auto.somanuals.com>

TV manuals search

<http://tv.somanuals.com>