

Manhattan[®]

freesat HD

User Guide

Plaza HD • S

freesat digital HD TV receiver



CONGRATULATIONS

on buying a Manhattan Plaza HD•S freesat receiver.

This high performance unit is designed to provide you with the best of digital TV and radio from freesat, with high definition digital pictures and digital sound via satellite.

You can only use the Plaza HD•S with a suitable satellite dish, and you must connect an HD-ready television to watch TV in high definition.

When installed and used correctly, this equipment should provide many years of trouble-free entertainment in your home.

Please take the time to read this user guide carefully before installing or using the unit, and keep it for future reference.

If you experience any difficulties connecting or using the Plaza HD•S, see the **Troubleshooting** section at the end of this guide before contacting us.

Some of the features of the Plaza HD•S are:

- Over 150 freesat TV and radio channels
- Subscription-free reception
- Stunning high definition pictures
- On-screen channel list and channel browsing
- 8-day electronic programme guide
- Automatic programme reminder
- 8 programmable favourite channel lists
- Digital text and interactive services
- BBC iPlayer and on-demand TV services
- Easy viewing of non-freesat channels
- Audio Description (AD)
- Subtitles
- HDMI connection
- SCART connection
- Remote control
- Automatic setup
- Auto-update for new channels
- Auto-standby for power saving

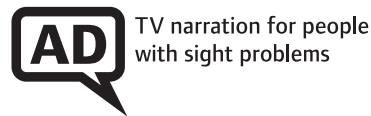

FURTHER INFORMATION

FREESAT

You can get more information and help from the freesat website at:

www.freesat.co.uk

MANHATTAN

You can get more information and help from our website at:

www.manhattan-tv.com

or you can phone us on: **020 8450 0005**



Manufactured under license from Dolby Laboratories.
Dolby and the double-D symbol are trademarks of Dolby Laboratories.

www.manhattan-tv.com

CONTENTS

1	In The Box	5	4	Advanced Use	22
	Your receiver	6		The lock PIN	22
	Remote control	8		Display mode	22
				TV/DTV	22
				Changing the channel list	23
				Using the favourite channel lists	23
				Using the setup menus	25
				General menu section	25
				Picture menu section	26
				Sound menu section	28
				Time menu section	29
				System menu section	30
2	Preparation	10	5	Online TV	32
	The satellite dish	10		Setting up for online TV	32
	Connecting your receiver	10		Watching online TV	33
	Switching on	11			
	Tuning in	12			
3	Everyday Use	15	6	Non-Freesat Channels	35
	Turning on the receiver	15		Tuning in non-freesat channels	35
	Changing channels	15		Watching non-freesat channels	36
	Changing the volume	16			
	Browsing bar	16		Appendix A Safety	38
	Subtitles and Audio Description (AD)	17		Appendix B Troubleshooting	40
	Using the channel list	18		Appendix C Specifications	42
	Searching for a channel	18		Notes	43
	Regional channels	18			
	Using the programme guide	19			
	Interactive TV services	21			
	Recording freesat programmes	21			

In The Box

In your Plaza HD•S freesat receiver pack you should find the following items:

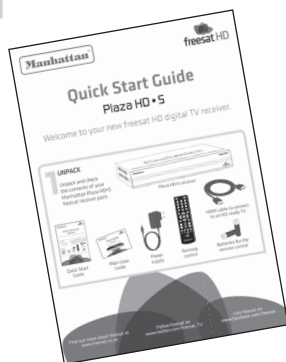

Quick Start Guide



Main User Guide

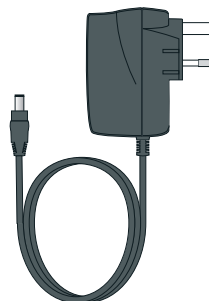

Power supply

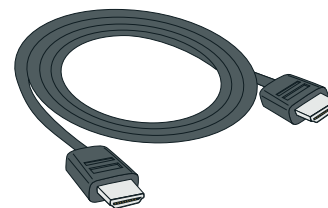

HDMI cable to connect to an HD-ready TV

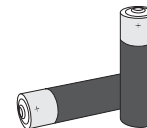

Batteries for the remote control



Remote control

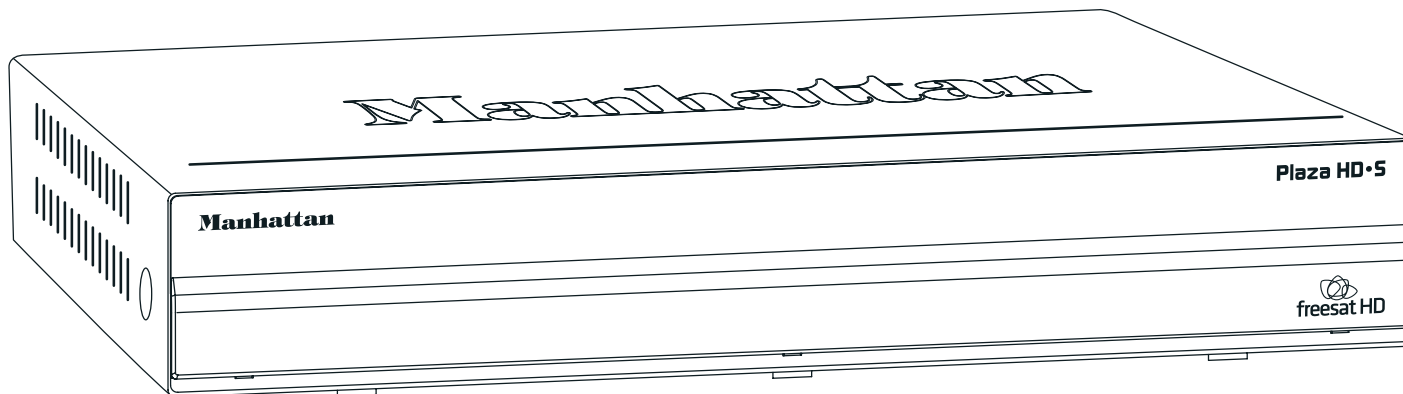

Plaza HD•S receiver

YOUR RECEIVER

Manhattan Plaza HD•S

Open the receiver's front cover by gently pulling forward at the sides.

Front

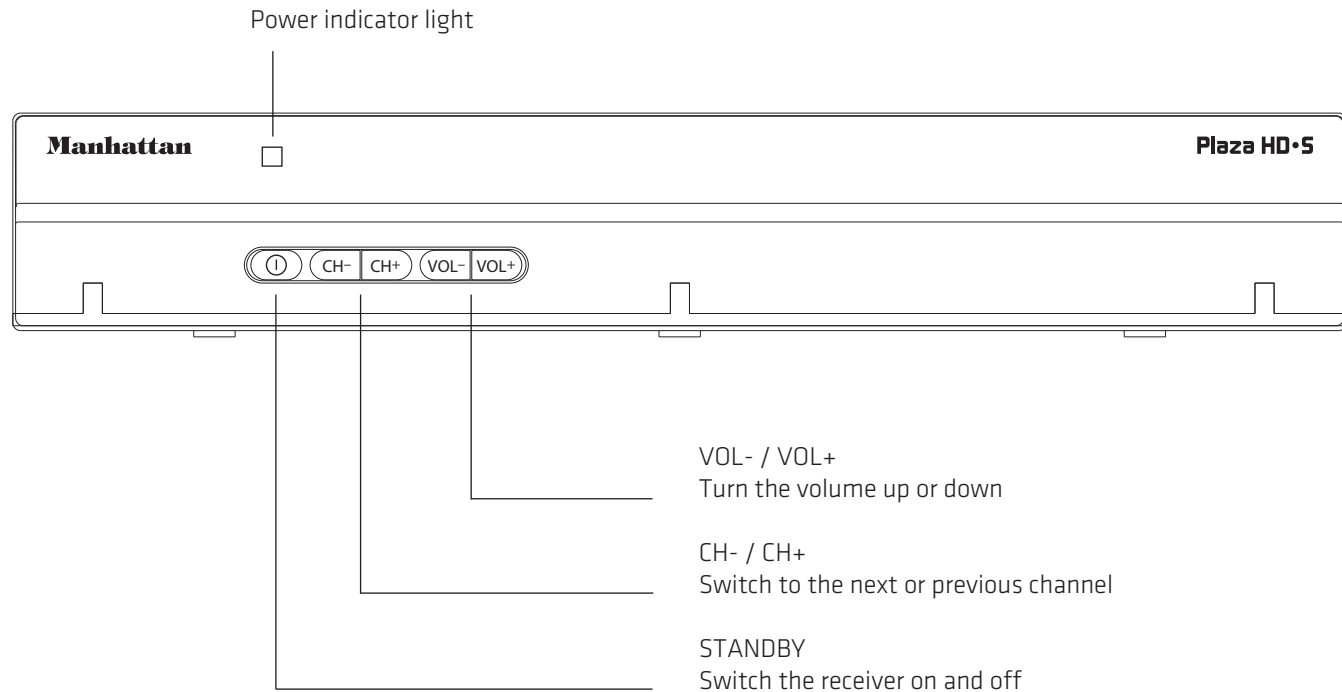

Manhattan Plaza HD•S

Rear

LNB IN
Input for connecting to
satellite dish

RJ-45
Network socket for
connecting to the Internet

POWER
Connection for the power
supply unit

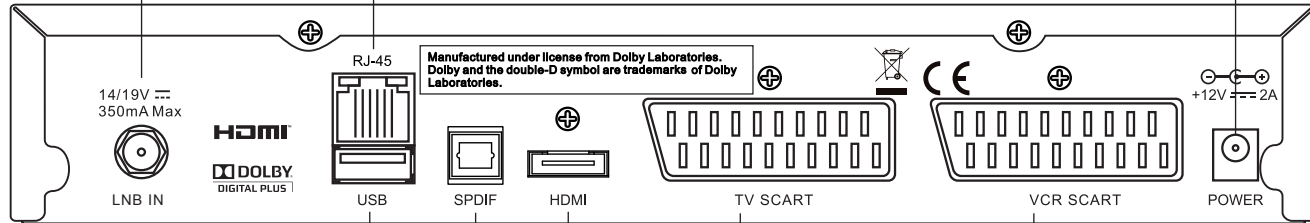

USB
Socket for upgrading the
receiver's software

S/PDIF
Optical audio output for
connecting to a digital audio
system

HDMI
Output for connection to a
HD-ready television

VCR SCART
Output/input for connecting to
video recorder or DVD recorder

TV SCART
Output for connection to a
non-HD television

REMOTE CONTROL Manhattan Plaza HD•S

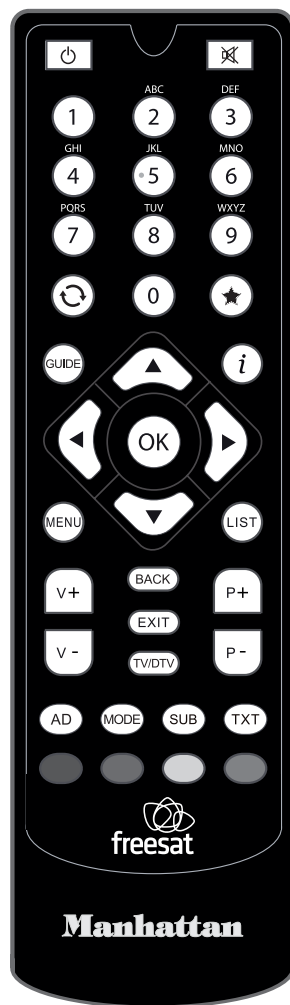

 Standby - switches the receiver on and off.

 Mute - silences the receiver's sound.

 0, 1 ... 9 - buttons to directly select channels, enter numeric value in the set-up menus and to enter your postcode.

 Switches back to the last channel watched.

 Displays your favourite channels lists and adds channels to them in the channel list.

 Displays the main menu screen.

 Displays channel and programme information.



Up, down, left, right - move the highlight bar in menus and in the programme guide, and allow you to browse the channels and programmes.

OK Selects the option in a menu.

LIST Displays the channel list.

GUIDE Displays the programme guide.

BACK Exits a menu and returns to the main menu.

EXIT Exits a menu and returns to normal TV viewing.

TV/DTV Switches the TV SCART output between freesat and the TV's tuner.



Turns the volume up and down.

Switches to the next or previous channel. Moves one page up or down in the channel list.

AD Displays the available audio menu to choose between normal sound and audio description.

MODE Switches between available screen display modes.

SUB Displays the subtitles menu to select a subtitle type.

TEXT Displays interactive and digital text services (where available).

 Red, green, yellow, blue -Chooses options within menus.

2

Preparation

This section explains how to set up your Plaza HD•S to receive freesat channels.

THE SATELLITE DISH

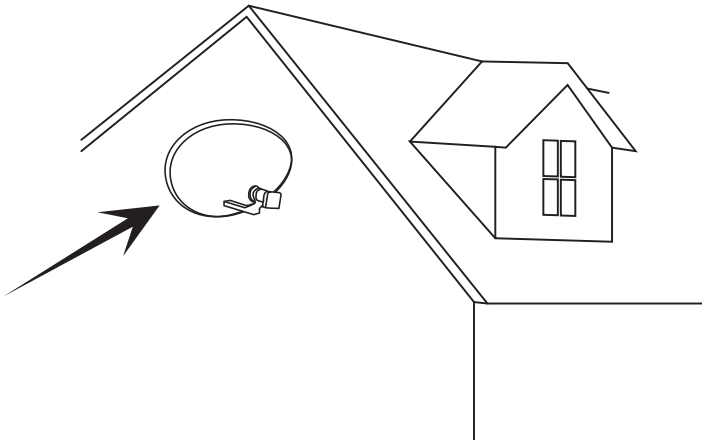

To receive freesat, you must connect your Plaza HD•S receiver to an appropriate satellite dish, fixed in position and accurately pointed at the 28.2° East satellite position.

For safety reasons and to provide reliable reception, we strongly recommend that you have your dish installed by a professional. You may be able to use a satellite dish already installed at your home. If you have any questions about the dish, please consult your installer.

10

CONNECTING YOUR RECEIVER

Place your Plaza HD•S receiver on a firm, level surface close to the television, a mains electricity socket, and the cable from the dish. (See Appendix A – Safety.)

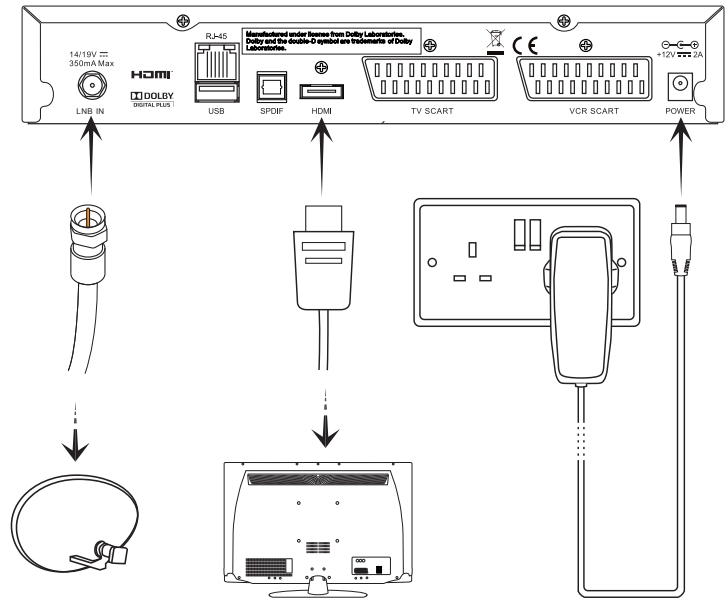

Connect the cable from your dish to the LNB IN socket at the back of the receiver (if the dish cable is fitted with a wall socket inside your home, you will need a connecting cable, which you can get from your installer).

HINT: The “F-connector” used for the satellite dish cable connection has a central wire that is inserted into the hole in the LNB IN socket while the collar is screwed onto the socket. When screwing on the collar, make sure that the central wire goes into the socket hole and is not bent to one side.

Turn off your television and connect the HDMI cable supplied between the HDMI socket at the back of your Plaza HD•S receiver and an HDMI socket on your television. There may be more than one HDMI socket on your television. If you are not sure which to use, check the television’s manual.

HINT: If your television has no HDMI socket, then it must be connected to the receiver by SCART cable, and you will not be able to watch freesat channels in high definition.

Plug the power supply lead into the POWER socket at the back of the receiver and then plug the power supply into an available mains socket that is turned off.

You may have other equipment, such as a DVD recorder or surround sound system, to connect to the receiver.

A video recorder or DVD recorder may be connected to your Plaza HD•S receiver to record freesat programmes and to play them back. You will need to connect a SCART cable between the VCR SCART

socket on the back of the receiver and a SCART socket on the video or DVD recorder. Check the recorder’s manual for guidance.

You can also connect the Plaza HD•S receiver to a stereo or surround sound system, so that you can listen to the TV sound through the sound system instead of (or as well as) the television’s speakers. You can connect a special lead between the receiver’s TV SCART or VCR SCART socket and the analogue inputs on the sound system, to listen to the sound in stereo.

If you connect an optical lead between the S/PDIF sockets on your receiver and digital sound system, you can listen to the TV sound in digital audio quality, or even in surround sound, depending on the sound system used and the broadcast you choose.

SWITCHING ON

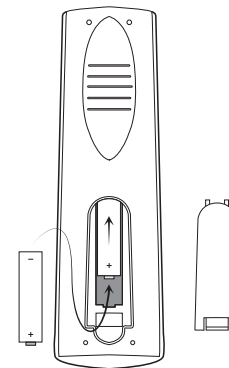

Take off the battery compartment cover from the back of the Plaza HD•S remote control by lifting it up while pushing the catch. Insert the two AAA batteries supplied, as shown on the inside of the compartment, and replace the compartment cover.

SWITCHING ON (continued)

Turn on your TV set and choose the HDMI input (see your television's manual for guidance).

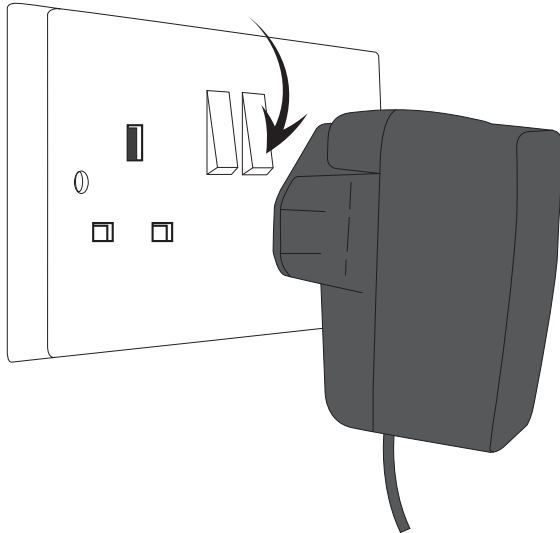





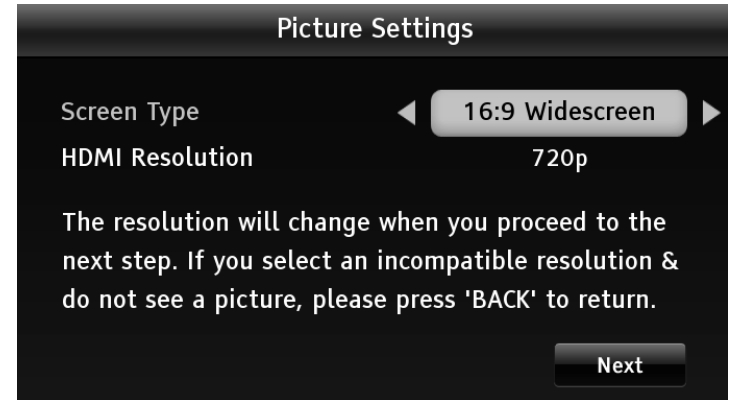

Switch on the mains socket the Plaza HD•S is connected to.

After a few seconds, the receiver's first freesat installation screen shown below will appear on the television screen:



HINT: If you do not see this screen on your television, see 'Troubleshooting' on page XX.

TUNING IN

When the first installation screen is displayed, use the  or  buttons to select the screen format of your television (16:9 Widescreen or the squarer 4:3 Traditional). Then press the  button to highlight the HDMI Resolution selection box, and use the  or  buttons to select the correct resolution for your television. Press the  button to display the next installation screen.

HINT: You should set the HDMI resolution to the highest that your television can display (see your television's manual). If in doubt, set the resolution to 720p.



Signal Check

If the signal lock fails please check your connections or contact your installer.

Signal Lock: Successful

Signal Quality:  96%

Signal Strength:  65%

Next

The signal check screen shows the strength and quality of the freesat signal received from your satellite dish. If the signal strength or quality is below 50%, you should check the satellite dish connection at the back of the receiver (switch the receiver off and reconnect the cable if necessary). If the connection is OK, consult your dealer or installer.

When the signal strength and signal quality shown are 50% or more, you can continue to tune in the receiver. Press  to proceed.



Regional Variations



In order to store the correct regional variations for certain channels, please enter your postcode using the number keys on your remote. You do not need to enter a space. Press left to delete.

Postcode:

NW27JA_

Next

Enter your postcode using the number buttons on the remote control, or press the red button to use the on-screen soft keyboard. You do not need to enter a space. Once you have entered your postcode, press the  button and then press  to proceed.

HINT: Enter your postcode with the number buttons by pressing the correct button on the remote a number of times to produce the relevant letter (printed above each button), or number, in the same way as 'texting' with a mobile phone. For example, for an 'S', you would press the  button four times. If you make a mistake, the  button deletes the last character entered.

With the on-screen soft keyboard, enter each letter and number of the postcode by highlighting it on the keyboard using the .

TUNING IN (continued)

◀ and ▶ buttons, then pressing **OK**. The red button deletes the last letter entered and the green button confirms the whole postcode.



Your Plaza HD•S receiver will take a couple of minutes to find and store the available freesat channels. The number of freesat TV and radio channels found is shown on the screen as the scan proceeds, along with an indication of how far the scan has to go. When the scan is complete, press the **OK** button to proceed.

To use the receiver's parental guidance function, hide adult channels, lock online content or lock channels of your choosing, you need to create a PIN. Enter your choice of PIN by pressing the required number button (0, 1... 9) for each of the four PIN digits, then press **OK** to proceed.

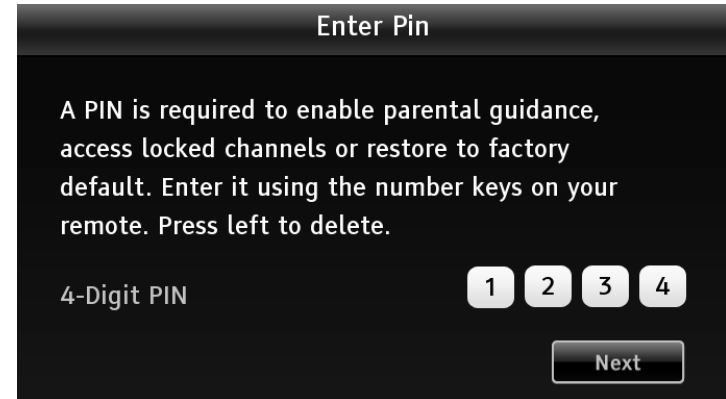



The setup completion screen confirms the lock PIN you have set. Press the **OK** button and your Plaza HD•S receiver is now ready for you to watch freesat digital TV.



HINT: When new freesat channels are introduced, you do not need to retune your Plaza HD•S receiver because it is automatically updated.



3 Everyday Use

This section describes the day-to-day use of your Plaza HD•S receiver – how to select the channels that you want to watch, view the programme schedules, and control the basic features.

TURNING ON THE RECEIVER









Press the  button on the remote control or the  button on the front of the receiver. The power light on the front panel changes from red to blue when the receiver is powered up.

You can turn off the Plaza HD•S, so it goes into standby, by pressing the  button on the remote control or the  button on the receiver. When the receiver is in standby, the power light on the front panel turns red. The Plaza HD•S uses less power when in standby.

HINT: You should leave the Plaza HD•S receiver plugged in with the socket switched on, at all times (except when there is lightening – see Appendix A). When you are not using the receiver, put it in standby by pressing the  button on the remote control or the  button on the front of the receiver.

HINT: The Plaza HD•S receiver will automatically switch to standby if it is not used for a long time. This feature can be disabled – see the Advanced Use section of this guide.

CHANGING CHANNELS

Step through the channels by pressing the  or  buttons on the remote control (or the  and  buttons behind the fold-down flap on the front of the Plaza HD•S receiver). Pressing the  or  button will select the next channel in the channel list. Pressing the  or  button will select the previous channel in the list.

If you know the channel's number, you can switch directly to the channel you want by using the number buttons on the remote control. As you enter a channel number, each digit appears at the top left of the screen to show the number button you have pressed. All the freesat channel numbers have three digits and the first channel is 101. The radio stations are stored from channel number 700.

Press the  button to switch from the channel you are currently watching to the channel you were watching before.

HINT: There are some channel numbers missing in the channel list because spaces are left for future channels to join freesat.







HINT: If you enter a number that does not exist, the channel will not change.

CHANGING CHANNELS (continued)

There are other ways to change channel:

- Use the browsing bar at the bottom of the screen (see below)
- Use the on-screen channel list (see page 18)
- Use the programme guide (see page 19)

CHANGING THE VOLUME

You can increase or decrease the volume by using the  and  buttons on the remote control (or the  and  buttons on the front of the receiver). The sound is silenced by pressing the  button and restored to its previous level by pressing the  button again.

HINT: The mute control also affects the sound supplied to the VCR SCART socket, and so using this control while a programme is being recorded will affect the recording.



BROWSING BAR

Whenever you change channel, the Plaza HD•S briefly displays a browsing bar at the bottom of the screen that contains information about the current channel and programme. You can press the  button at anytime to display the bar again.



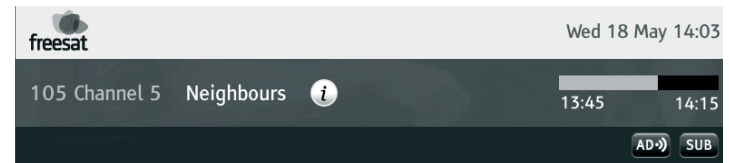





It shows:







- the name and number of the channel
- the name of the programme you are watching
- the start and finish time of the programme
- the progress through the programme
- the date and time





HINT: You can also display the browsing bar by pressing  or  on the remote control while you are watching TV.





The information bar may also display symbols to indicate:

-  The programme is in High Definition.
-  Subtitles are available.
-  Audio Description is available.
-  Dolby Digital audio is available.
-  Parental guidance is advised as the programme contains language or scenes that may not be suitable for children.
-  The channel is locked (see the Advanced Use section).
-  An HD version is available on another channel (press  for further details).

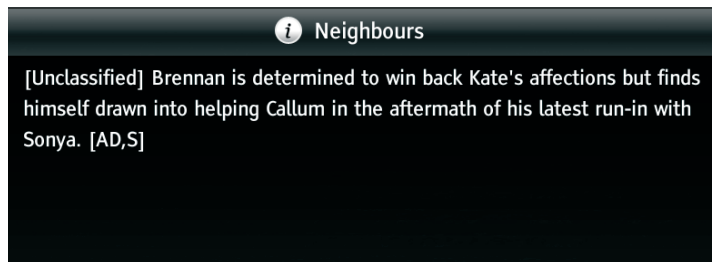
While the bar is displayed, press the  button to see details of the next programme, and the  button to go back again. To see what is on another channel, press the  or  buttons. To change to this channel, press  while the bar is still displayed. To remove the bar from the screen at anytime, press .





While the browsing bar is displayed, press  again to display more information about the selected programme, including a short summary. Pressing the  button once more removes the extra information from the screen.





HINT: When the extra programme information is displayed, you can still press  or  to see what is on now or next and  and  to see what is on other channels.

SUBTITLES AND AUDIO DESCRIPTION

Many freesat programmes are broadcast with subtitles for people who are deaf or hard of hearing. Channels with subtitles available show the  symbol in the information bar.

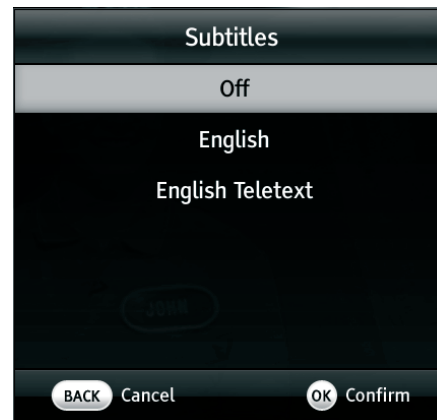
If you want to turn on subtitles, first display the subtitles menu by pressing the  button and then use the  and  buttons to highlight "English" (or "English Teletext" for larger subtitles), and press . To turn off subtitles, select "Off" from the subtitles menu and press .



Some programmes have an extra soundtrack to tell people who are blind or partially sighted what is happening on screen. Channels with this audio description available show the  symbol in the information bar.

To turn on audio description, press the  button to display the available audio menu and then select "English Audio Description (MPEG)".

USING THE CHANNEL LIST

Display the on-screen channel list by pressing the **LIST** button on the remote control. This lists the channels on the left-hand side of the screen, in number order, and displays a preview window of the currently selected channel on the right-hand side of the screen. You can return to watching TV at any time by pressing the **EXIT** button.

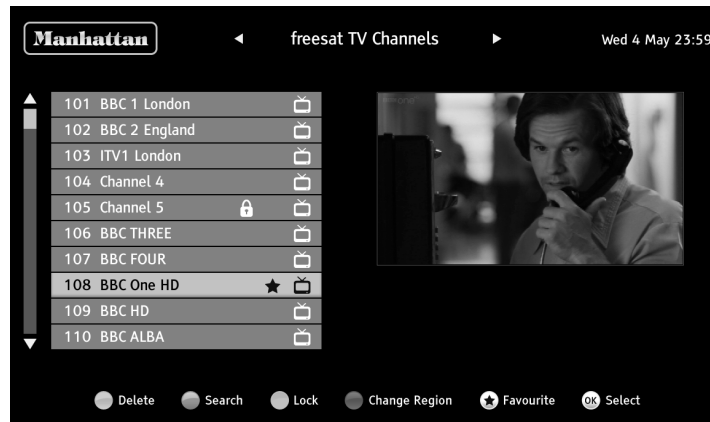

HINT: You can also display the channel list by pressing the **OK** button while watching TV.

Use the **▲** or **▼** buttons on the remote control to highlight a channel then press **OK** to view it in the preview window. Press **OK** again to exit the channel list and watch the channel full-screen.

HINT: Move a page at a time through the channel list by using the **P-** and **P+** buttons.

TV and radio channels are stored in separate lists. Switch between the TV and radio channel lists by pressing the **◀** or **▶** buttons. The name of the list is displayed at the top of the screen.

SEARCHING FOR A CHANNEL

You can search for a channel by name, or a part of its name. Press the green button while on the channel list screen and enter the word that you want to search for using the on-screen keyboard.

The receiver shows a list of all channels with the search word within their name, for you to choose from in the normal way. You can press **◀** or **▶** to see the search results for the different channel lists. Press **↻** to clear the search.

REGIONAL CHANNELS

With freesat, some channels, such as BBC1, broadcast regional variations of their channels. The initial regional variations are based on the postcode that you entered when you installed the Plaza HD•S.

You can replace the regional variation of a channel in the channel list by pressing the blue button while the channel is highlighted. The current list will change to show the regional variations of that channel (if available).



Choose the region that you want from the list by moving the highlight bar through the list with the and buttons and then pressing , or press to leave the region setting unchanged.

USING THE PROGRAMME GUIDE



The Plaza HD•S programme guide displays details of all programmes showing on freesat channels for the next week ahead.

To access the guide, press the button on the remote control. Choose the section of the guide you want to look at – either all channels or a specific channel genre – by pressing the , , or buttons to highlight the section, and then to select it.



HINT: You can skip the genre choice stage by pressing the button a second time, to jump straight to the programme guide for all of the channels.

The programme guide shows a table of the programmes, with each page showing eight channels over a two-hour period.

USING THE PROGRAMME GUIDE (continued)

Information on the highlighted programme is shown above the table and you can read a full summary by pressing the **(i)** button. Press **(i)** again to remove the summary box.

The current date and time is displayed at the top right of the screen and an orange line at the top of the table shows the present time in the schedule.

You look through the scheduled programmes using the **(▲)** and **(▼)** buttons to move through the channels and the **(◀)** and **(▶)** buttons to highlight programmes showing at different times.

HINT: You can jump through the list more quickly using the **(P+)** or **(P-)** buttons to move to the next or previous page. The green and red buttons move the highlight bar through the schedule two hours forward or back, and the blue and yellow buttons move a day forward or back.

As you move the highlight bar through the schedule, the programme summary shown above the list changes to reflect the programme highlighted.

Press **(OK)** to switch the receiver to the channel and programme highlighted. If the programme is on at the time, the receiver will switch to that channel immediately.

HINT: Programmes in standard definition that are also available on another channel in HD are labelled in the schedules with an **(HD)** symbol. You can see the time and channel that the HD version is broadcast by highlighting the programme and pressing **(i)**.

If the programme is scheduled for later on, a reminder is set so that when the programme is about to start, a message is displayed on-screen and, after a few seconds, the receiver automatically switches to the relevant channel. In the programme guide a clock symbol **(🕒)** is shown next to a programme with a reminder set.

18:30	19:00	19:30	▶
BBC London News	(HD) The One Show	(HD) EastEnders	
(🕒) Great British ...	The Great Estate: The Rise &...		
ITV News & Weather	Emmerdale	(HD) Human Rights ...	
Hollyoaks	Channel 4 News		...
OK! TV	5 News at 7	(🕒) How Do They ...	Fo

You can see a list of all the programmes with reminders set by pressing the **(🕒)** button, and you can cancel a reminder by highlighting it and pressing the red button. Pressing **(🕒)** again or **(BACK)** leaves the reminder list and returns to the programme guide. You can also cancel a reminder by highlighting the programme in the programme guide and pressing **(OK)** again.

You can set as many reminders as you want but if you try to set a reminder on one channel for the same time as one you have already set on another channel, a warning is displayed on the screen.



You leave the programme guide and return to watching TV by pressing **BACK** or **EXIT** button.

INTERACTIVE TV SERVICES

Several freesat channels broadcast a range of digital text and interactive services, such as news, weather, games, sports information and video, alongside normal TV. If interactive services are available, they will be indicated by an on-screen prompt – usually a red button in the top right-hand corner of the screen.

You can use the interactive options by pressing **TEXT** or the red button while watching the TV channel. This will display a menu of the services available.

When you have finished with the interactive services, return to watching normal TV by pressing **TEXT** again or the **EXIT** button.



RECORDING FREESAT PROGRAMMES

You can record a programme by connecting a VCR or DVD recorder to the VCR SCART socket on the back of the Plaza HD•S. You will need to choose the recorder's SCART input for recording (see your recorder's manual for guidance).

You can also record a programme even when you are not at home. Highlight the programme in the programme guide list, make a note of its scheduled date and times, and set a reminder with the **OK** button. Then set the recorder's event timer to record from its SCART input on the date and times noted.

HINT: Do not use the channel list, programme guide, interactive services or any other menu while a recording is in progress as these functions will also be recorded.

4 Advanced Use

This section explains how to get the most out of your Plaza HD•S receiver.

THE LOCK PIN

Some of the Plaza HD•S menu functions can be locked to avoid accidental changes to the receiver's setup, and you can lock particular channels to prevent some family members, such as children, from watching them.

To use a locked menu function or watch a locked channel, you need to enter the four-digit PIN that you set when you first installed the Plaza HD•S. You can change the lock PIN, without re-installing the receiver, as explained later in this section.

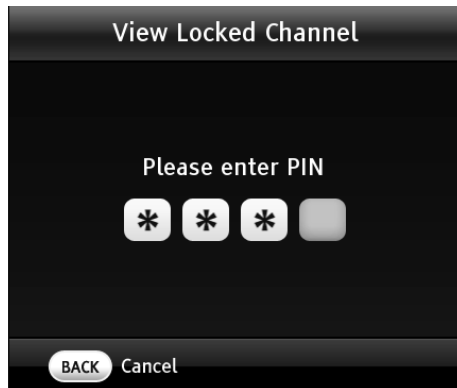

DISPLAY MODE

Most freesat programmes are broadcast using a widescreen 16:9 format, designed for a widescreen TV. If you watch a widescreen broadcast on a squarer 4:3 television, or a 4:3 broadcast on a widescreen TV, the Plaza HD•S provides a choice of how the image is displayed. Pressing the **MODE** button will take you through the three available options.

If you have set up your receiver for a 16:9 Widescreen TV, the options are:

- Auto - the broadcaster chooses the best display format.
- Widescreen - a 4:3 broadcast is stretched to fill the 16:9 screen.
- Pillarbox - a 4:3 broadcast is shown unaltered with black bars on each side.

If you have set up your receiver for a 4:3 Traditional TV, the options are:

- Auto - the broadcaster chooses the best display format.
- Centre Cut-out - a 16:9 broadcast is cropped to show only the centre of the image.
- Letterbox - a 16:9 broadcast is shown unaltered with black bars above and below it.

TV/DTV

If your TV is connected to the Plaza HD•S's TV SCART socket, pressing the **TV/DTV** button switches the channel displayed on the television between the signal from the aerial (TV) and digital television from freesat (DTV). This button has no effect if your TV is connected to the receiver's HDMI socket.

CHANGING THE CHANNEL LIST

The channel list contains all the freesat channels that the Plaza HD•S found when it was first installed, and may include some channels that you do not watch, do not want to include in the on-screen list, or do not want some members of your family to watch.

If you want to alter the channel list, first press the **(LIST)** button to display the channel list screen. To remove a channel, highlight it and press the red button to delete the channel. You need to confirm your choice to ensure you don't delete a channel accidentally.

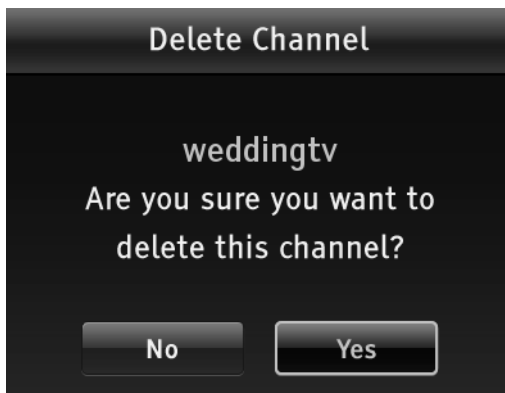

You can lock a channel to prevent it being selected for viewing without first entering the lock PIN. Highlight the channel and press the yellow button to lock it. A padlock symbol is shown next to all locked channels in the channel list.

HINT: If you want to unlock a channel that you have locked before, highlight it in the channel list and press the yellow button. You will need to enter the PIN to complete the process.

USING THE FAVOURITE CHANNELS LISTS

The favourite channel lists make it easier for you to choose the channel that you want to watch, by limiting the on-screen list to just a few channels, such as those of a particular type, or that one member of the family watches the most.

The Plaza HD•S provides eight favourite channel lists, and it only takes a short time to set up the lists before they can be used. First, display the channel list, by pressing the **(LIST)** button.



USING THE FAVOURITE CHANNELS LISTS (continued)

Highlight the channel that you want to include in a favourite channels list, and press the **★** button to show the eight lists available. Highlight the list that you want to include the channel in and press **★** to add the channel to that list (a star will appear next to it). You can add a channel to as many lists as you like. Press **OK** to store the changes to the lists, or press **BACK** to cancel.

You can rename the favourite channels lists to suit their contents (for example, the type of channels in the list, or the name of person who has chosen them). With the list highlighted, press the red button and enter the name that you want for that list using the on-screen keyboard.



HINT: You can remove a channel from a favourite channels list by following the same process - with the channel highlighted in the channel list, press **★** and highlight the favourite channels list you want to remove the channel from, press **★** again and then **OK**.



Choose a channel from a favourite channels list, during normal TV viewing, by pressing the **★** button to display the first favourite channels list. Use **◀** or **▶** to switch to the other lists, and highlight the channel you want to watch using the **▲** and **▼** buttons, then press **OK**.



HINT: The channels in a favourite channels list appear in the same order as in the normal channel list, regardless of the order you added them.





USING THE SETUP MENU

You display the Plaza HD•S's setup menu by pressing the  button on the remote control. This shows the five sections in a bar across the top of the screen with the first section highlighted in orange. The menu options for the highlighted section are listed below, along with a picture representing that section.

You can choose between the menu sections by pressing the  or  buttons to move the highlight along the section bar. You choose an option within the section shown by pressing the  button to move the highlight bar through the option list.



Some of the selections available from different menu sections are for advanced use of the Plaza HD•S. We recommended that you take the time to read this section carefully before you make any changes.

GENERAL MENU SECTION

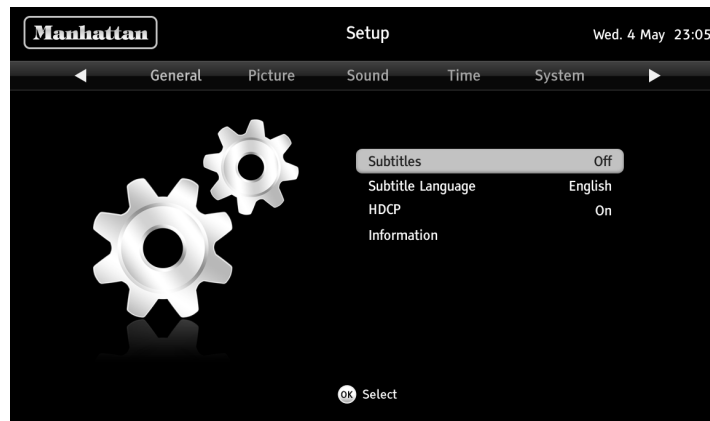
Highlight the option you want to alter using the  and  buttons. When you have finished making the changes you want, leave the menu system by pressing  or .





SUBTITLES

Press  to switch on subtitles for all channels that provide them. Switch subtitles off by pressing  again.

SUBTITLE LANGUAGE

The freesat channels can broadcast with subtitles available in a number of languages. The Plaza HD•S is set to English subtitles, but you can change this setting by pressing  to show the subtitle language menu.

Use  and  to highlight the language you want for subtitles (if available) and press .

(See screenshot on page 26)

SUBTITLE LANGUAGE (continued)

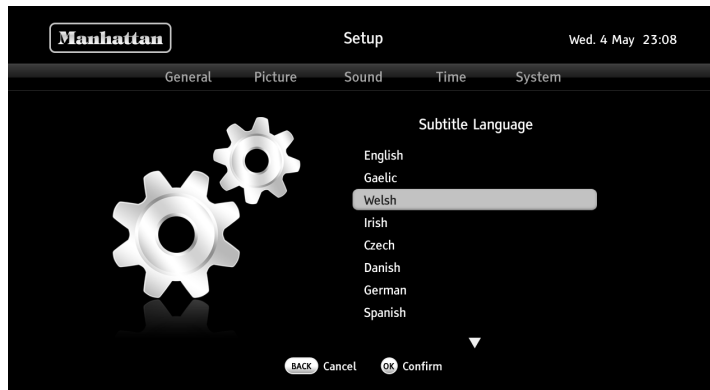

HDCP

Press **(OK)** to switch on or off the HDCP (High-bandwidth Digital Copy Protection) on the receiver's HDMI output. If the broadcaster has flagged that a programme must use HDCP, this has no effect.

INFORMATION

Press **(OK)** to show technical information about your receiver, including the Helpline phone number, signal strength and quality readings.

HINT: We recommend that you have this screen displayed on your TV if you need to phone the Plaza HD•S helpline.

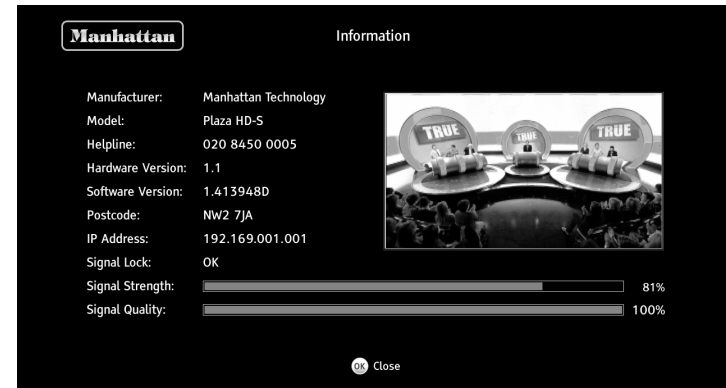



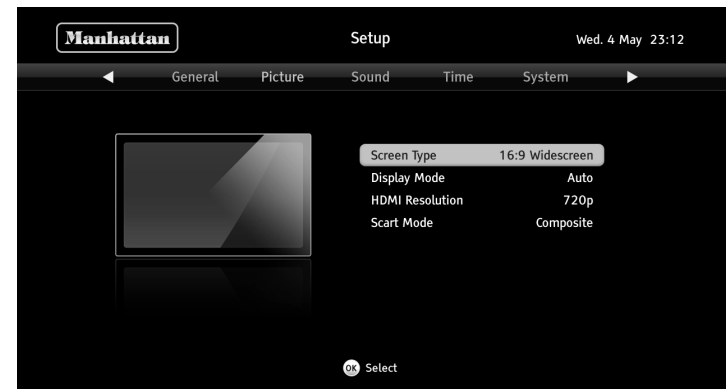

PICTURE MENU SECTION

Highlight the option you want to alter using the **(Up)** and **(Down)** buttons. When you have finished making the changes you want, leave the menu system by pressing **(BACK)** or **(EXIT)**.







SCREEN TYPE

Press  to show the screen type menu and use the  and  buttons to choose between 16:9 Widescreen and 4:3 Traditional. Press  to confirm your choice.





HINT: This setting overrides the screen type you selected when you first installed the receiver.

DISPLAY MODE

Press  to show the display mode menu and use the  and  buttons to choose between Auto, Centre Cut-Out, and Letterbox, if the screen type is set to 4:3 Traditional, or between Auto, Widescreen, and Pillarbox if the screen type is set to 16:9 Widescreen. Press  to confirm your choice. See Advanced Use - Display Mode (page 22) for more information.





HINT: This menu option has the same effect as the  button.

HDMI RESOLUTION

Press  to show the HDMI resolution menu and use the  and  buttons to choose the correct resolution for your TV. You should set the HDMI resolution to the highest that your television can display (see your television's manual). If in doubt, set the resolution to 720p. Press  to confirm your choice.





HINT: If you set an incompatible resolution or move your receiver to a different TV that doesn't support the active resolution, ensure the receiver is turned on and then press and hold the  button for 10 seconds. The resolution will be changed to 720p, which is supported by all HD televisions.

SCART MODE

Press  to show the SCART mode menu and use the  and  buttons to choose between Composite and RGB for the correct output for a television connected to the receiver's TV SCART output. Press  to confirm your choice.

HINT: The RGB setting will usually produce the best quality SCART picture but a few televisions cannot accept this signal (see your TV manual). This setting has no effect on the receiver's HDMI output.

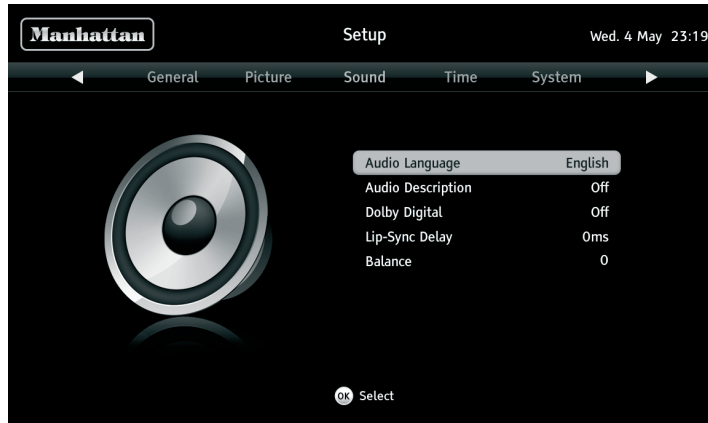

SOUND MENU SECTION

Highlight the option you want to alter using the  and  buttons. When you have finished making the changes you want, leave the menu system by pressing  or .





AUDIO LANGUAGE



The freesat channels can broadcast in a number of languages. The Plaza HD•S is set to the English, but you can change this setting by pressing  to show the audio language menu.

Use  and  to move the orange highlight bar to the language you want for the soundtrack and press .

AUDIO DESCRIPTION

Press  to switch on audio description for all channels that provide it. Switch audio description off by pressing  again.

DOLBY DIGITAL





Press  to switch on the Dolby Digital surround sound output from the S/PDIF and HDMI sockets, for all programmes that provide it (channels with Dolby Digital sound available show the  symbol in the information bar). Switch off Dolby Digital by pressing  again. Only turn this on if you have connected your Plaza HD•S to a product that supports Dolby Digital.

When Dolby Digital is set to off and you watch programmes with Dolby Digital sound the Plaza HD•S will decode the audio for you.

HINT: The volume level of Dolby Digital is fixed, therefore you cannot use the volume control buttons when you watch programming with Dolby Digital.

LIP-SYNC DELAY RESOLUTION

If you find the sound and picture falling out of sync, you can delay the sound output by a small amount to compensate.

Press  to show the lip-sync delay menu on top of the normal TV picture, and use the  and  buttons to alter the amount of audio delay in 10ms steps from 0-250ms. Press  to confirm your choice and return to the sound menu.

BALANCE

You can alter the volume balance between the left and right stereo sound outputs by pressing **OK** to show the balance menu and using the **◀** or **▶** buttons to alter the balance in favour of the right side (positive) or left side (negative). Press **OK** to confirm the setting.

TIME MENU SECTION

Highlight the option you want to alter using the **▲** and **▼** buttons. When you have finished making the changes you want, leave the menu system by pressing **BACK** or **EXIT**.



AUTO STANDBY

To conserve power, the Plaza HD•S will switch to standby after three hours if no buttons are pressed on the remote control or front panel. The Auto standby function is normally turned on, and can be turned off by pressing the **OK** button.

SLEEP TIMER

Press **OK** to show the sleep timer menu and use the **▲** and **▼** buttons to choose a time up to 90 minutes after which the receiver automatically switches itself to standby. Press **OK** to confirm your choice.

AUTO TURN ON

You can set the Plaza HD•S to switch on automatically at a particular time. Press **OK** to show the auto turn on menu and use the **◀** or **▶** buttons to set the timer to turn the receiver on once, every day, each week, on weekdays, weekends, or particular days of the week. Then use the **▲** and **▼** buttons, along with the **◀**, **▶** and the number buttons to set the switch-on time, the channel source (freesat TV or radio), the channel number and the sound volume. Press **OK** to confirm.

AUTO TURN OFF

You can set the receiver to switch off automatically at a particular time. Press **OK** to show the auto turn off menu and use the **◀** or **▶** buttons to set the timer to turn the receiver off once, every day, each week, on weekdays, weekends, or particular days of the week. Then use the **▲** and **▼** buttons, along with the **◀**, **▶** and number buttons to set the switch-off time. Press **OK** to confirm.

TIME ZONE

If the Plaza HD•S is used outside of the UK, you should set the time zone so the local time is correctly displayed. Press **OK** to show the time zone menu and use the **▲** and **▼** buttons to highlight the correct European time zone for your location. Press **OK** to confirm your choice.

SYSTEM MENU SECTION

Highlight the option you want to alter using the **▲** and **▼** buttons. When you have finished making the changes you want, leave the menu system by pressing **BACK** or **EXIT**.

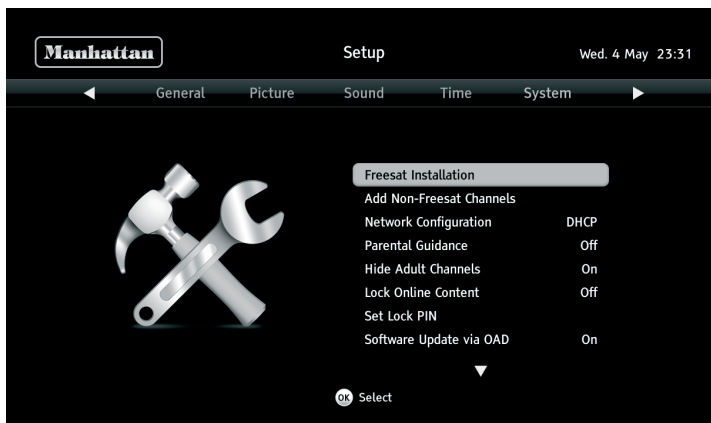

FREESAT INSTALLATION

Press **OK** to retune all the freesat channels. If you retune freesat, you will lose all channels from the favourite channels lists (but not the lists' names), remove any channel locks you have set, and restore channels deleted from the channel list.

ADD NON-FREESAT CHANNELS

See the Non-freesat Channels section of this guide (page 35) for full details of how you can add and watch non-freesat channels.

NETWORK CONFIGURATION

See the Online TV section of this guide (page 32) for full details of how you can connect to and watch online services.

PARENTAL GUIDANCE

Press **OK** to turn on or off the parental guidance lock. This prevents watching any programme broadcast with a **G** parental guidance warning, or displaying the system menu, without first entering the lock PIN.

HIDE ADULT CHANNELS

Press **OK** to hide or show the adult freesat channels. If you set the Plaza HD•S to hide adult channels, all adult genre channels are removed from the programme guide and the channel list, and they cannot be selected by putting in the channel number or by skipping through the channels with the **P+** and **P-** buttons.

HINT: To prevent other users resetting this function, to show the adult channels, we recommend that if you hide the adult channels, you also turn on the parental guidance lock.

LOCK ONLINE CONTENT

Press **OK** to turn on or off the online content lock that prevents any online services being viewed without first entering the lock PIN. See the Online TV section of this guide (page 32) for more details of how you can connect to and watch online services.

SET LOCK PIN

Press **OK** to show the set lock PIN menu. Change the PIN used by first entering the current PIN and then entering and confirming your choice of new PIN.

SOFTWARE UPDATE VIA OAD

Press **OK** to turn on or off the automatic software update.

OAD SOFTWARE MANUAL SCAN

Press **OK** to immediately search for new software to download.

SOFTWARE UPDATE VIA USB

Press **OK** to load new software for the receiver from a storage device connected to the USB socket on the back of the receiver. You can only load update software from the USB socket and it must be in the correct format to update successfully.

RESTORE FACTORY DEFAULT

Press **OK** to revert all the receiver settings to what they were when you first got your receiver and to start the installation procedure described in the Preparation section of this guide.

You must enter the lock PIN, and then confirm in another menu, to start the process because it will delete all channels, favourite channels, favourite channel list names, and the receiver configuration.

5 Online TV



This section explains how to set up the Plaza HD•S receiver to watch online TV services, such as the BBC iPlayer and ITV Player catch-up services. You must have a broadband Internet connection in your home to watch online TV.

HINT: You can read the latest information about freesat online TV services on the freesat information page on channel 999.

SETTING UP FOR ONLINE TV

Connect a network cable from the RJ-45 network socket on the back of the Plaza HD•S receiver to either your broadband modem/router or a network switch in your home network, as appropriate. Consult your modem/router manual for guidance.



HINT: If the receiver has made a connection with your modem or home network, one or both of the small green and orange lights immediately above the RJ-45 socket will light and/or flicker.

Press the  button on the remote control and then press  to display the System menu. You should check that the Network Configuration menu option shows "DHCP" to automatically

32

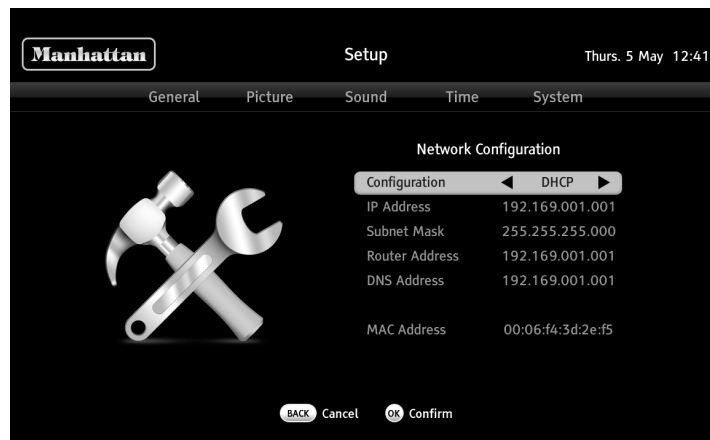
configure the network connection.



If your broadband modem/router is not compatible with DHCP (Dynamic Host Configuration Protocol), you will need to set the addresses manually. Use the  or  buttons to change the configuration to "Static" and for each of the addresses in turn (IP Address, Subnet Mask, Router Address, and DNS Address) press  to highlight the address and then the red button to edit the address.

HINT: Consult the manual or supplier for your modem/router or network for help choosing the correct addresses.

Highlight each of the four “octets” that is to be changed, enter the number required using the number buttons, and press **OK** to confirm that address. When all four addresses have been set correctly, press **OK** to set the configuration and return to the system menu page.

You can check that the receiver has successfully connected to the Internet from the technical information page. Press **OK** to display the General menu (or, if you are no longer on the System menu page, first press **MENU**) and use the **Down** button to highlight the “Information” option, then press **OK**.



If the IP address item shows a number in four sections separated by dots, then the receiver is connected to your local network. If online services still do not work, you should check your router’s connection to the internet. If “Not Connected” is shown, you should carefully check the broadband connection and the Network Configuration.

WATCHING ONLINE TV

You can switch to online TV either through the interactive services on a channel providing online TV, or through an online channel chosen by number or using the channel list or programme guide.

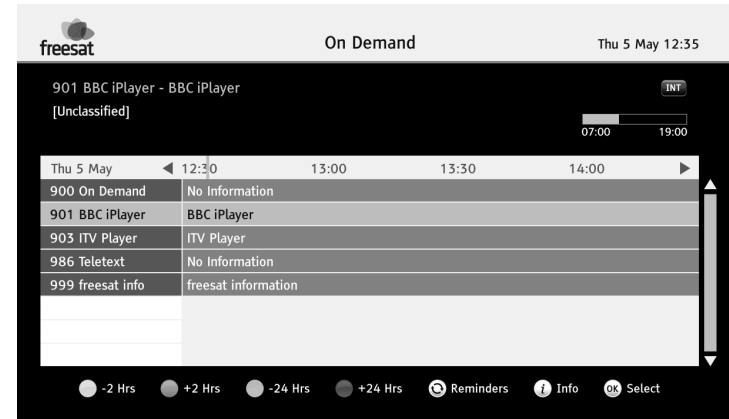

HINT: The online TV channels are numbered from 900 and are in the On Demand section of the programme guide

When you switch to an online TV channel, it may take a few seconds longer to show the picture than a freesat satellite channel. You will then need to progress through a series of menus, using the number buttons, the coloured buttons, **Up**, **Down**, **Left** and **Right**, and the **OK** button, to find and start the programme you want to watch. You go through these menus in a different way depending on the online broadcaster.

WATCHING ONLINE TV (continued)

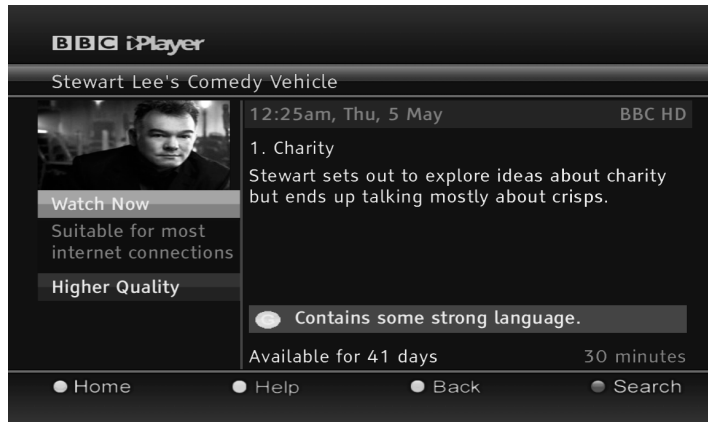

6 Non-Freesat Channels

This section explains how to set up your Plaza HD•S receiver to receive channels that are not included with freesat. As well as receiving the many freesat channels, the Plaza HD•S can also be used to watch other channels, as long as they are broadcast from the same satellites as freesat and are free.

TUNING IN NON-FREESAT CHANNELS

Go to the Add Non-Freesat Channels menu by pressing **MENU**, then **Left Arrow** to display the system menu, and **Down Arrow** to highlight the option to add non-freesat channels, then press **OK**.

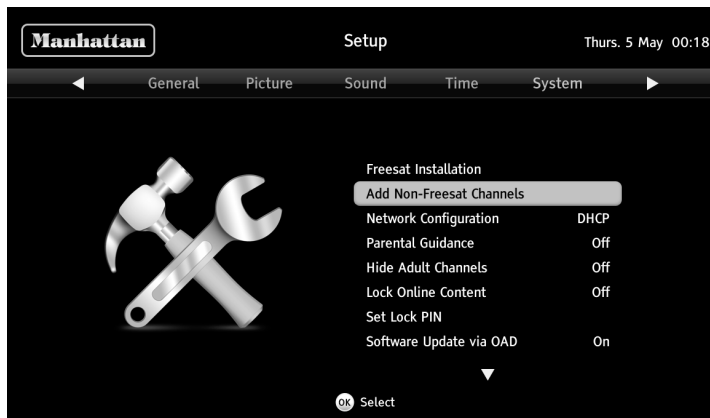

You can add non-freesat channels either by manually entering the tuning details for an individual transponder (a group of channels)

or by allowing the Plaza HD•S to scan all the transponders for non-freesat channels. Choose between a manual scan or an automatic scan by pressing the **Left Arrow** or **Right Arrow** buttons.

If you choose a manual scan, you should enter the frequency and symbol rate of the transponder to scan, using the number buttons, and its polarization by using the **Left Arrow** or **Right Arrow** buttons. You can move between the three items using the **Up Arrow** and **Down Arrow** buttons. When you have entered the tuning information, press **OK** to start the scan.

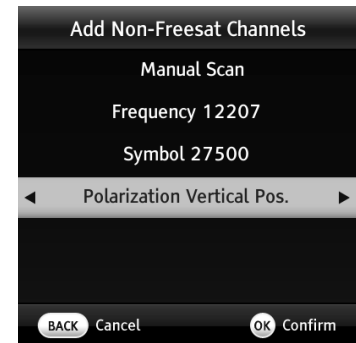
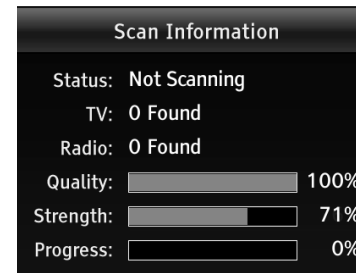

HINT: The tuning information for non-freesat channels may be printed in specialist magazines, or given on a specific channel's website.

If you choose an automatic scan, just press **OK** to start the scan.

TUNING IN NON-FREESAT CHANNELS (continued)

The Plaza HD•S will take a few seconds to complete a Manual Scan and about three minutes to finish an Auto Scan. While it is scanning, the receiver displays the number of TV and radio channels found so far. When it is finished, the receiver will display a list of all the channels found.



You can choose to watch a non-freesat channel from this list by moving the orange bar using the and buttons to highlight the channel you want and pressing , or return to watching TV by pressing or .

WATCHING NON-FREESAT CHANNELS

Non-freesat channels and freesat channels are stored separately in the receiver but you can switch between them quite easily. When you are watching a non-freesat channel, the information

36

bar displays the Manhattan logo instead of the freesat logo.



While watching a non-freesat channel, you can step through the other non-freesat channels by pressing the or .

You can also switch directly to the channel you want using the number buttons. All the non-freesat channel numbers have four digits. If you enter only the three digits of a freesat channel, the receiver will switch to that freesat channel.

HINT: Non-freesat TV channels are stored from channel number 3001 and non-freesat radio channels from 4001.

While watching a freesat channel you cannot enter a four-digit channel number to switch to a non-freesat channel, but you can press the button to switch to the channel you last watched,

whether it was a freesat or non-freesat channel.

You can browse through the non-freesat channels and programmes in the same way as you browse the freesat channels. Press **i** or **▲** or **▼** to display the information bar and then press the **▲** or **▼** buttons to see what is showing at the moment on any of the other non-freesat channels, and **▶** to see the programmes on next.

HINT: The programme guide does not display non-freesat channels.

When you have some non-freesat channels stored, the channel list displays both freesat and non-freesat channels. Go to the channel list by pressing the **(LIST)** button.

Now pressing **◀** or **▶** will take you through the four channel lists available:

- freesat TV Channels
- freesat Radio Channels
- non-freesat TV Channels
- non-freesat Radio Channels

You can use the same channel list functions for any of the lists, so you can search the non-freesat channels for a word, lock or delete a channel, or add it to your favourite channels lists.

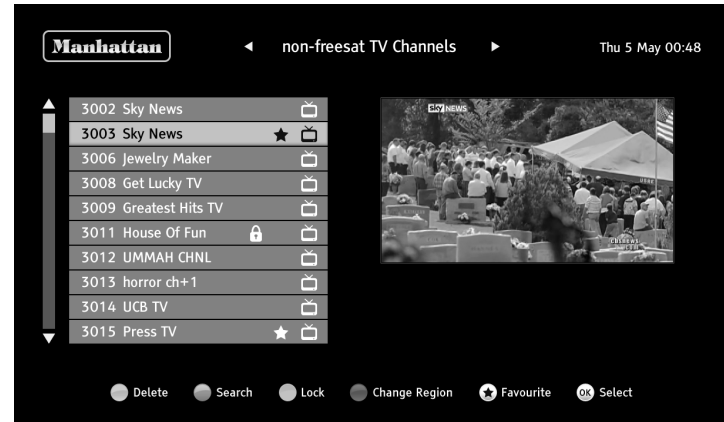

If you put your favourite freesat channels and your favourite non-freesat channels in the same favourite channels list, you can switch from one to the other freely and easily.



Appendix A - Safety

POWER

The receiver should be plugged into a 230V to 240V AC, 50Hz supply.

CABLES

Make sure all cables are positioned so they are not likely to be walked on, crushed or damaged by things placed on or against them. Pay particular attention to the power cable where it goes into the socket and where it comes out of the receiver. Do not connect or adjust cables to the receiver when it is plugged in.

TEMPERATURE AND MOISTURE

Do not use or leave the receiver in a hot, cold or humid (moist) environment. Do not allow the receiver to get wet – from drips or splashes – as this is dangerous. Do not place vases or other water-filled objects on top of the receiver.

VENTILATION

Slots and openings in the receiver's cover are for ventilation. Do not cover or block them as this could lead to the receiver overheating.

CLEANING

Unplug the receiver before you clean it with a lightly dampened cloth. Do not use liquid or aerosol cleaners.

HEAT AND FLAMES

Do not place the receiver near to naked flames or sources of intense heat, such as an electric fire. Make sure that no flames, such as lighted candles, are placed on top of the receiver.

LIGHTNING

If there is a storm or lightning, unplug the receiver.

SERVICING

Make sure that anyone who services your receiver is qualified to do so. Do not remove the cover yourself – you could get an electric shock.

REPLACEMENT PARTS

If your receiver needs repairing, make sure the person carrying out the repair uses parts which are specified by us or which have the same specifications as the original part. Other parts may cause a fire, electric shock or other dangers.

ELECTRICAL SAFETY

Your receiver is supplied with an external 100V - 240V AC, 50Hz power supply that connects by 12V DC plug to the receiver and by UK mains plug adapter to the mains. Always connect the 12V DC plug to the receiver before connecting the mains plug.

If the mains plug breaks or becomes damaged, do not use it. Do not cut or open the adapter, as this will expose you to dangerous high voltages present inside. The adapter is non-serviceable and does not have any replaceable parts inside. If the power supply is damaged, it must be replaced by the manufacturer, its service agent, or suitably qualified persons in order to avoid a hazard.

To reduce the risk of electric shock, do not remove screws from the receiver or open it as it contains no user- serviceable parts. Please leave all maintenance work to qualified personnel.

PROTECTING THE ENVIRONMENT



If you one day find that your receiver or remote control needs replacing, or are of no further use to you, do not throw them out with your household waste. Under the Waste Electrical and Electronic Equipment (WEEE) regulations, your local council must provide a suitable recycling centre.



Do not throw batteries in the bin or on a fire. Make sure that you dispose of batteries safely at a local recycling centre. You can also recycle batteries at many supermarkets.

Appendix B – Troubleshooting

PROBLEM	POSSIBLE CAUSE	WHAT TO DO
Power light off	Power supply cable disconnected	Check the power supply cable.
No set up screen	Receiver not switched on	Check the mains adapter is plugged in and mains socket is turned on. Turn on receiver.
	HDMI/SCART cable disconnected	Check HDMI/SCART cable connection to receiver and television.
	Television not switched to HDMI/SCART input	Select television's HDMI/SCART input.
Signal lock failed	Cable from the satellite dish disconnected	Check the cable connections at receiver and dish. Consult your installer if necessary.
	Dish in the wrong position	Reinstall the dish. Consult your installer if necessary.
Signal strength below 50%	Dish in the wrong position	Reinstall the dish. Consult your installer if necessary.
Not accepting postcode	Broadcast error	Postcode tables are not being transmitted. Use green Default Channels button to activate default tuning.
'No signal' message	Cable from the satellite dish disconnected	Check the cable connections at receiver and dish. Consult your installer if necessary.
	Dish damaged or in the wrong position	Check the dish. Consult your installer if necessary.
No picture or sound	HDMI/SCART cable disconnected	Check HDMI/SCART cable connections at receiver and television.
	Television not switched to HDMI/SCART input	Select television's HDMI/SCART input.
No picture via HDMI	Selected an incompatible HDMI resolution – many TVs don't support 1080p or 1080i, but only 720p	Whilst the receiver is on, press and hold the  button for 10 seconds and the resolution will be changed to 720p.
Full picture not visible	Mismatched screen format	Choose the correct screen size to suit your TV.

PROBLEM	POSSIBLE CAUSE	WHAT TO DO
TV picture not HD	Tuned to an SD channel	Tune to an HD channel.
	TV not capable of HD	Connect the receiver to an HD-Ready TV.
	TV connected by SCART	Connect the TV with the HDMI lead.
No response with remote control	Receiver in standby	Switch on the receiver.
	Remote control not aimed at the receiver correctly	Aim the remote control at the receiver.
	Remote sensor on the front of the receiver is obstructed	Check for obstructions in front of the receiver.
Receiver switches off after 3 Hrs	Auto Standby is on	Turn off the Auto Standby in the Time menu.
Cannot view a channel	Wrong channel number used	Choose the channel from Channel List.
	Channel locked	Enter the PIN. If you have forgotten the PIN, phone the helpline on 020 8450 0005.
No information for a channel in the programme guide	Information on the channel not downloaded	Wait for the download.
	You are on a non-freesat channel	Select a freesat channel.
No digital text or interactive services	Services not available on chosen channel	Switch to a channel broadcasting interactive services.
No BBC iPlayer	No connection to Internet	Check broadband connection and network configuration in system menu.
Can't record a channel	No connection to recorder	Install a SCART lead from the receiver to the recorder.
	Wrong recorder input selected	Select recorder's SCART input (see your recorder's manual for guidance).

Appendix C - Specifications

Tuner	Standard	DVB-S/S2
	Input frequency	950~2150MHz
	Input connector	F type, female 75 ohm
	LNB supply	14.0V / 19.0V (maximum.350mA), short-circuit protected
	Digital signal input level	-20 to -65 dBm
Video	HDMI output	Resolution 576i / 576p / 720p / 1080i /1080p
	SCART output	TV (CVBS/RGB) & VCR (CVBS)
	Aspect ratio	4:3, 16:9 & Letter Box
	Video output	Two SCART sockets; TV (CVBS/RGB) & VCR (CVBS)
Audio	TV & VCR SCART output	Audio left and right
	Optical S/PDIF output	Dolby Digital, Dolby Digital + & PCM
USB	Host	2.0 (5V@1A max) for software upgrade only
Internet Connectivity	Ethernet	RJ-45 10/100 Base-T (with green Link LED & yellow Data LED)
Power Requirements	Mains input voltage	100-240VAC~ 50Hz
	Power consumption	Max 10W (LNB with 200mA) & Standby less than 1W
Dimensions	Width, depth and height	Width: 258mm, x depth: 175mm, height: 44mm

Notes

HELPLINE

020 8450 0005



ONLINE

www.manhattan-tv.com

Find out more about freesat at
www.freesat.co.uk

Follow freesat on
www.twitter.com/freesat_TV

Like freesat on
www.facebook.com/freesat

v1.7

Free Manuals Download Website

<http://myh66.com>

<http://usermanuals.us>

<http://www.somanuals.com>

<http://www.4manuals.cc>

<http://www.manual-lib.com>

<http://www.404manual.com>

<http://www.luxmanual.com>

<http://aubethermostatmanual.com>

Golf course search by state

<http://golfingnear.com>

Email search by domain

<http://emailbydomain.com>

Auto manuals search

<http://auto.somanuals.com>

TV manuals search

<http://tv.somanuals.com>