

6 WATCH TV

Change the channel you are watching by entering the three-digit channel number using the number buttons on the remote control. Or, you can press the **P[^]** or **P^v** buttons to step through the channels in order.

Press the V[^] and V^v buttons to turn the volume up or down. You can turn off the sound altogether with the **Mute** button. The sound comes back on when you press **Mute** again.

When subtitles are available for a programme it is indicated by a SUB symbol in the browsing bar at the bottom of the screen when you switch channels (press 'i' at anytime whilst watching TV to display the bar). Press the **SUB** button to display the subtitles menu and use the **^** and **v** buttons to move the orange highlight bar to "English" if you want to turn on subtitles, or "Off" to turn off subtitles, and then press **OK**.

If audio description (a spoken description of the broadcast) is available for a programme it is indicated by an AD symbol in the browsing bar. To turn on audio description, press the **AD** button to display the available audio menu and then select "English Audio Description (MPEG)".

the scheduled programmes using the **^** and **v** buttons to move through the channels and the **←** and **→** buttons to move the orange highlight bar to show the programmes showing at different times.

Press OK to switch to the programme highlighted by the orange bar. If the programme is on at the time, the receiver will switch to that channel immediately. If the programme is scheduled for later on, a reminder is set. When the programme is about to start, a message is displayed on screen and, after a few seconds, the receiver automatically switches to the necessary channel.

When you have finished with the programme guide, return to normal TV viewing by pressing **EXIT**.



Digital text and interactive services are available from some Freesat channels, and you can use them by following the on-screen prompts and pressing **TEXT** or the **AD** button while watching the channel. This displays a menu of services available from that channel or broadcaster.

When you have finished with the interactive services, return to normal TV viewing by pressing **TEXT** or **EXIT**.

Switch off your receiver by pressing the Standby button, and press the button again to turn it on.

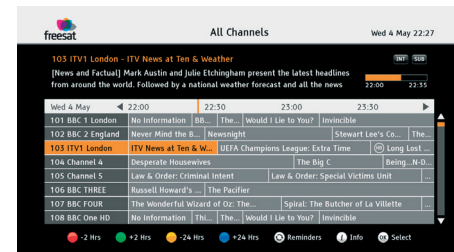

You can find out the programmes scheduled to be shown on all the Freesat channels up to eight days ahead using the **GUIDE** button. Press the button and then press **OK**. Browse

Manhattan

Plaza HD • S2 Remote Control

Standby - switches the receiver on and off.

Mute - silences the receiver's sound.

0, 1 ... 9 - buttons to directly select channels and enter numeric value in the set-up menus.

Channel Recall - Switches back to the last channel watched.

Favorites - Displays your favourites lists.

MENU - Displays the main menu screen.

Info - Displays channel and programme information.

Navigation - Up, down, left, right - move the highlight bar in menus and in the programme guide, and allow you to browse the channels and programmes.

OK - Selects the option in a menu.

LIST - Displays the channel list.

GUIDE - Displays the programme guide.

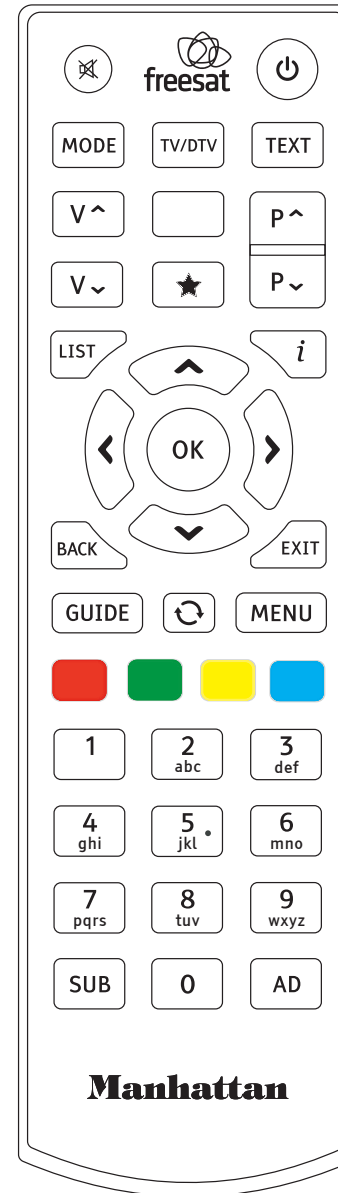

BACK - Exits a menu and returns to the main menu.

EXIT - Exits a menu and returns to normal TV viewing.

TV/DTV - Switches the TV SCART output between Freesat and the TV's tuner.

V[^] - Turns the volume up.

V^v - Turns the volume down.

P[^] P^v - Switches to the next or previous channel. Moves one page up or down in the channel list and programme guide.

AD - Displays the available audio menu to choose between normal sound and audio description.

MODE - Switches between available screen display modes.

SUB - Displays the subtitles menu to select a subtitle type.

TEXT - Displays interactive and digital text services (where available).

Color Buttons - Chooses options within menus.

FREE TV IN JUST A JIFFY

YOUR QUICK START GUIDE

Manhattan
Model: Plaza HD•S2

For assistance, please call the Manhattan helpline on **020 8450 0005** or visit our website at www.manhattan-tv.com

Find out more about Freesat at www.freesat.co.uk
Join in at community.freesat.co.uk
Follow Freesat on www.twitter.com/freesat_TV
Like Freesat on www.facebook.com/freesat

1 UNPACK

Unpack and check the contents of your Manhattan Plaza HD•S2 Freesat receiver pack:



Plaza HD•S2 receiver



Quick Start Guide

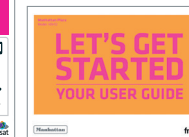

Main User Guide

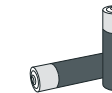

Batteries for the remote control



Remote control



HDMI cable to connect to an HD-ready TV

Manhattan

freesat

2 CONNECT TO A DISH

To receive Freesat you must connect your Plaza HD•S2 receiver to an appropriate satellite dish, fixed in position and accurately pointed at 28.2° East satellite position.

For safety reasons and to provide reliable reception, we strongly recommend that the dish is professionally installed. If you have any questions about the dish, please consult your installer.

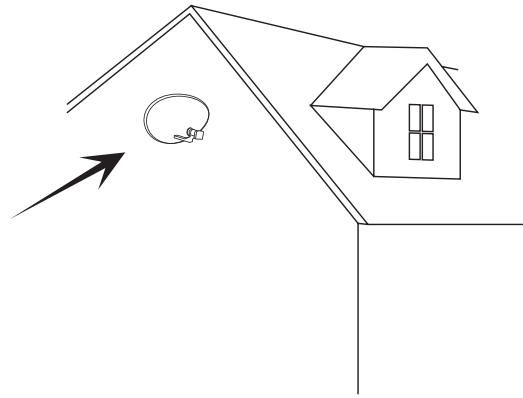

3 PLUG IN

Place your Plaza HD•S2 receiver on a firm, level surface close to your television, a mains electricity socket, and the cable from the dish.

Connect the cable from your dish to the LNB IN socket at the back of the receiver.

Make sure your television is turned off and connect the HDMI cable to the HDMI socket on the rear of the Plaza HD•S2 and to an HDMI socket on your television. If you need more guidance, check your television manual.

Plug the mains power lead from the back of the receiver into an available mains socket that is turned off.

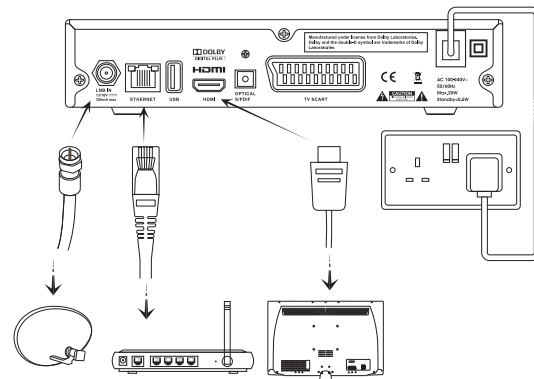

To watch On Demand TV services including BBC iPlayer and ITV Player, the Plaza HD•S2 must be connected to your internet router or hub using an ethernet cable (not supplied). Plug one end of the ethernet cable into the ETHERNET socket at the back of the Plaza HD•S2, and the other into your hub or router. Make sure the connections are fully pushed in - you'll hear a click as they lock into place. Consult your router or hub's documentation for further guidance.

4 SWITCH ON

Remove the battery compartment cover from the back of the Plaza HD•S2 remote control by lifting it up while pushing the catch. Insert the two AAA sized batteries as marked on the inside of the compartment. Replace the compartment cover.

Turn on your TV set and choose the HDMI input (see your television manual).

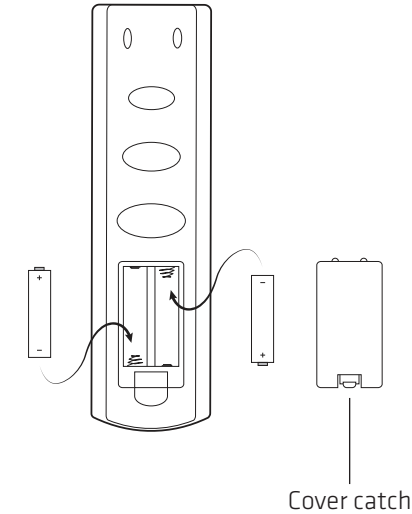

Switch on the mains socket the Plaza HD•S2 is connected to. The power indicator light on the front will illuminate blue to indicate the receiver has been turned on successfully. After a few seconds, step one of the Freesat installation process will be shown on the television screen.

If you do not see this screen (pictured opposite), please refer to the Troubleshooting section in the main user guide.

5 TUNE IN

When the first installation step is displayed, use the < and > buttons to select the screen type of your television (16:9 Widescreen or the squarer 4:3 Traditional). Press the v button to highlight the HDMI Resolution selection box, and then use the < and > buttons to select the correct resolution for your television (see your television's manual for guidance, or select 720p if unsure).

Press v to select "Next" and then press OK to display the next installation step.

When the signal lock is successful, press OK to proceed to the next step. If the signal lock fails, please see the Troubleshooting section in the main user guide.

Enter your postcode, pressing the number buttons an appropriate number of times to produce the letters (printed above each button) and numbers required, in the same way as 'texting' on a mobile phone. You do not need to enter a space. If you make a mistake, the < button deletes the previous character. Now press OK once to confirm the postcode and again to start the channel scan.

Your Plaza HD•S2 receiver will take a couple of minutes to find and store the Freesat channels available, displaying the total number of Freesat TV and radio channels found. Press the OK button to display the next installation step.

Enter your choice of PIN (used to unlock certain channels and functions) by pressing the required number button 0, 1 ... 9 for each of the four PIN digits. Press OK to proceed to the next step.

Setup is now complete. Your PIN number will be displayed on-screen along with a reminder to make a note of it. When ready, press OK and enjoy watching Freesat digital TV.

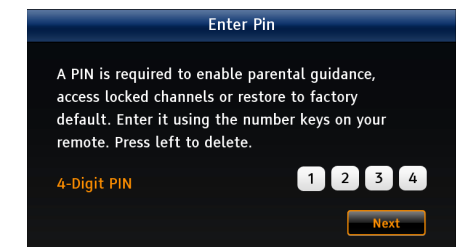
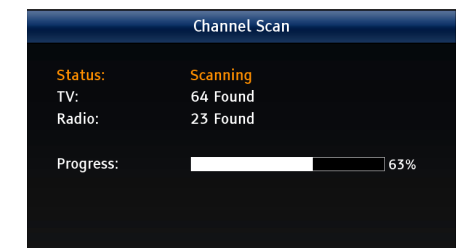
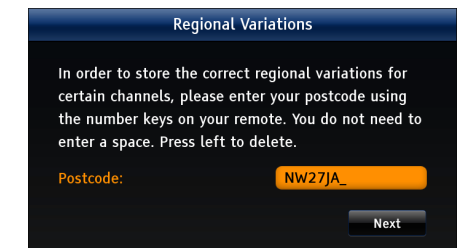
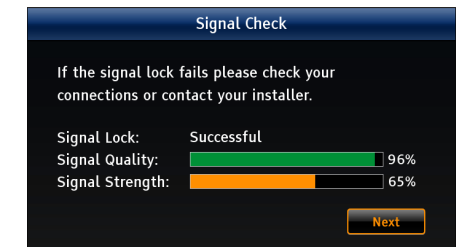
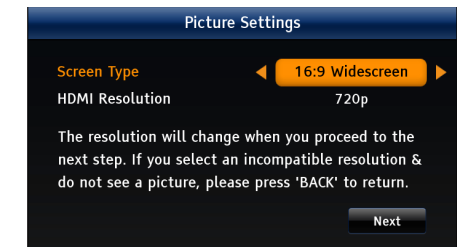

Free Manuals Download Website

<http://myh66.com>

<http://usermanuals.us>

<http://www.somanuals.com>

<http://www.4manuals.cc>

<http://www.manual-lib.com>

<http://www.404manual.com>

<http://www.luxmanual.com>

<http://aubethermostatmanual.com>

Golf course search by state

<http://golfingnear.com>

Email search by domain

<http://emailbydomain.com>

Auto manuals search

<http://auto.somanuals.com>

TV manuals search

<http://tv.somanuals.com>