

**Manhattan**<sup>®</sup>

  
**freesat SD**

# User Guide

**Plaza DS•100**

freesat digital TV receiver

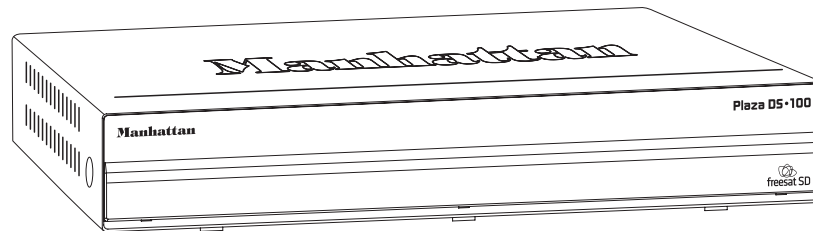

## CONGRATULATIONS

on buying a Manhattan Plaza DS•100 freesat receiver.

This high-performance unit is designed to provide you with the best of digital TV and radio from freesat, with high-quality digital pictures and sound.

You can only use the Plaza DS•100 with a suitable satellite dish.

We have tried to make the User Guide, Quick Start Guide and packaging easy to understand, and they have gained Plain English Campaign's Crystal Mark.



### Some of the features of the Plaza DS•100

- Over 140 freesat TV and radio channels
- Subscription-free channels
- On-screen channel list and channel browsing
- Eight-day programme guide
- Automatic programme reminder
- Digital text and interactive services
- Audio description
- Subtitles
- Receives non-freesat channels
- SCART connection
- Remote control
- Automatic set-up
- Auto-update for new channels
- Auto-standby for saving power

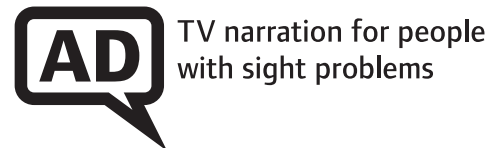

When installed and used correctly, this equipment should provide many years of trouble-free entertainment in your home.

Please take the time to read this user guide carefully before installing or using the unit, and keep it for future reference.

If you experience any difficulties connecting or using the Plaza DS•100, see the **Troubleshooting** section at the end of this guide before contacting us.



## FURTHER INFORMATION

### **FREESAT**

You can get more information and help from the freesat website at

**[www.freesat.co.uk](http://www.freesat.co.uk)**

### **MANHATTAN**

You can get more information on us from our website at

**[www.manhattan-tv.com](http://www.manhattan-tv.com)**

or you can phone us on **020 8450 0005**

**[www.manhattan-tv.com](http://www.manhattan-tv.com)**



# In The Box

In your Plaza DS•100 freesat receiver pack you should find the following items.

- Plaza DS•100 receiver
- Remote control
- Batteries for the remote control
- SCART lead to connect to the TV
- Quick-start guide
- User guide

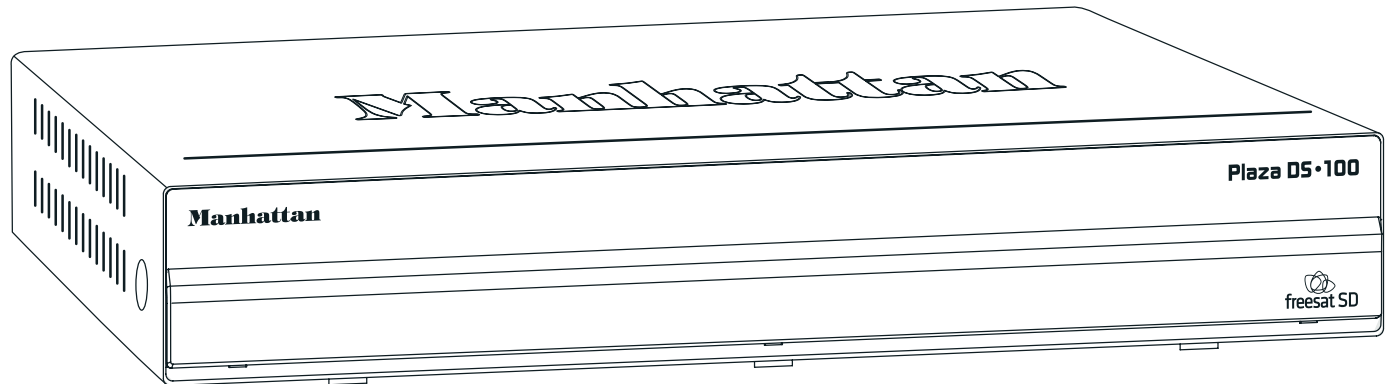

## YOUR RECEIVER

### Manhattan Plaza DS•100

Open the receiver's front cover by gently pulling forward at the sides.

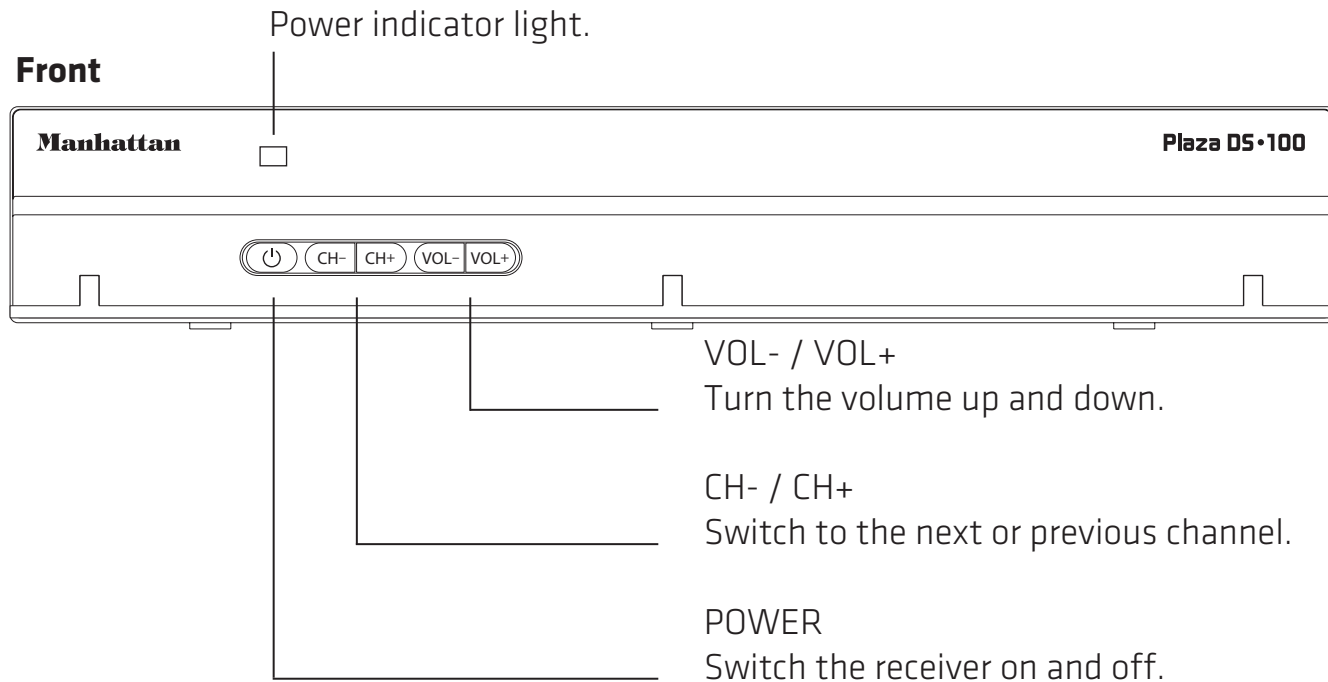

## Manhattan Plaza DS-100

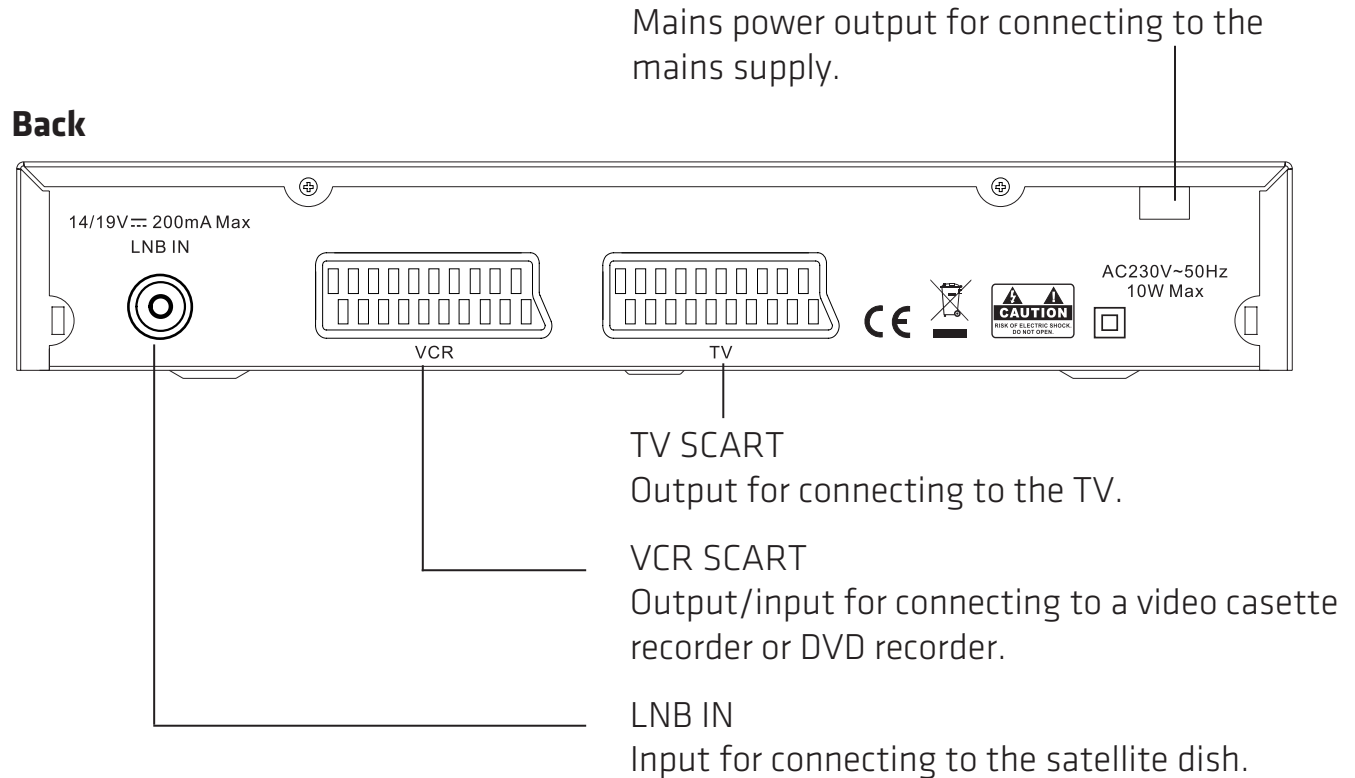

## REMOTE CONTROL

### Manhattan Plaza DS•100

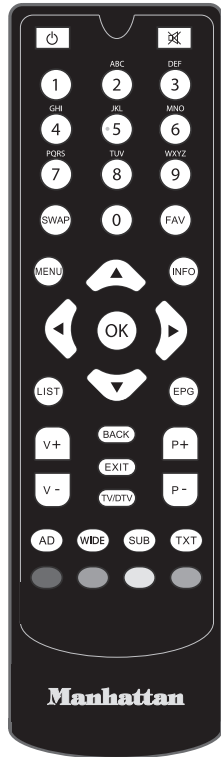



 Standby - switches the receiver on and off.

 Mute - silences the receiver's sound.

 0, 1 ... 9 - buttons to choose channels and so on, and to enter your postcode.

 Switches to the last channel watched, and switches between freesat and non-freesat channel lists.

 Switches to the next channel in the favourite channels list.

 Displays (and exit) the main menu screen.

 Displays channel and programme information.





Up, down, left, right - moves the highlight bar in menus and in the EPG. Allows you to browse the channels and programmes.



Chooses the option in the menu.



Displays the channel list.



Displays the electronic programme guide (EPG).



Exits a menu and returns to the main menu.



Exits a menu and returns to normal TV viewing.



Switches between freesat and the TV's tuner.



Turns the volume up and down.

Switches to the next or previous channel.

Moves one page up or down the channel list.



Switches audio description on and off.



Switches between widescreen display formats on a conventional TV.



Switches subtitles on and off.



Displays the interactive and digital text services (where available).



Red, green, yellow, blue - chooses options within menus.

## 2 PREPARATION

This section explains how to set up your Plaza DS•100 to receive freesat.

### THE SATELLITE DISH

To receive freesat you must connect your Plaza DS•100 receiver to an appropriate satellite dish, fixed in position and accurately pointed at 28.2° East.

For safety reasons and to provide reliable reception, we strongly recommend that you have your dish installed by a professional. You may be able to use a satellite dish already installed at your home. If you have any questions about the dish, please consult your installer.

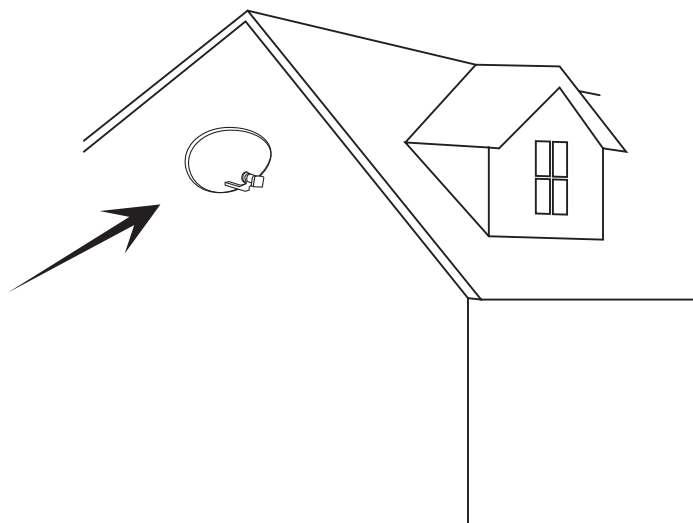

## CONNECTING YOUR RECEIVER

Place your Plaza DS•100 receiver on a firm, level surface close to the television, an electric socket, and the cable from the dish. (See Appendix A - Safety.)

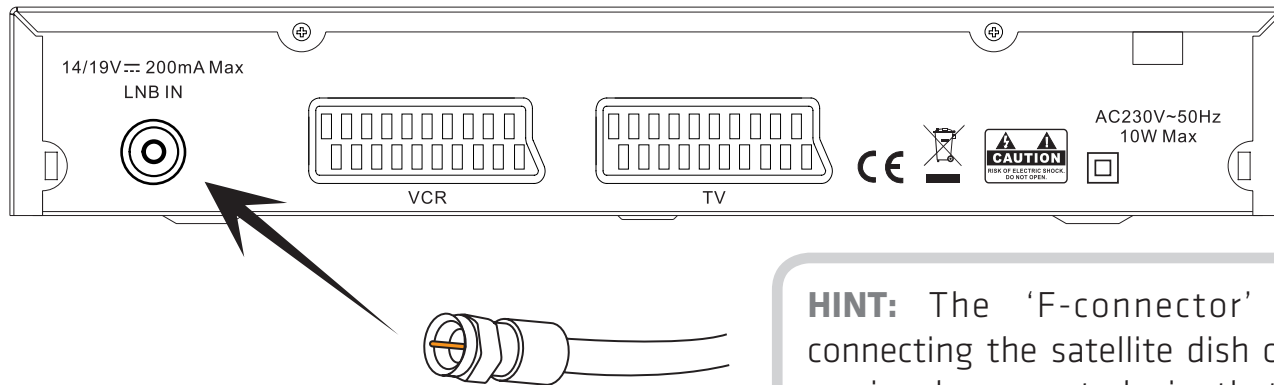

Connect the cable from your dish to the LNB IN socket at the back of the receiver (if the dish cable is fitted with a wall socket inside your home, you will need a connecting cable, which you can get from your installer).

**HINT:** The 'F-connector' used for connecting the satellite dish cable to the receiver has a central wire that is inserted into the hole in the LNB IN socket while the collar is screwed onto the socket. When screwing the collar on make sure the central wire goes into the socket hole and is not bent to one side.

## CONNECTING YOUR RECEIVER (continued)

Turn off your TV and connect the SCART lead between the TV SCART socket on the back of your Plaza DS•100 receiver and a SCART socket on your television (usually labelled AV). There may be more than one SCART socket on your television. If you are not sure which to use, check the manual for your TV.

**HINT:** If your TV has different connectors, you will need an adapter or special cable. Ask your dealer or check the manual for your TV.

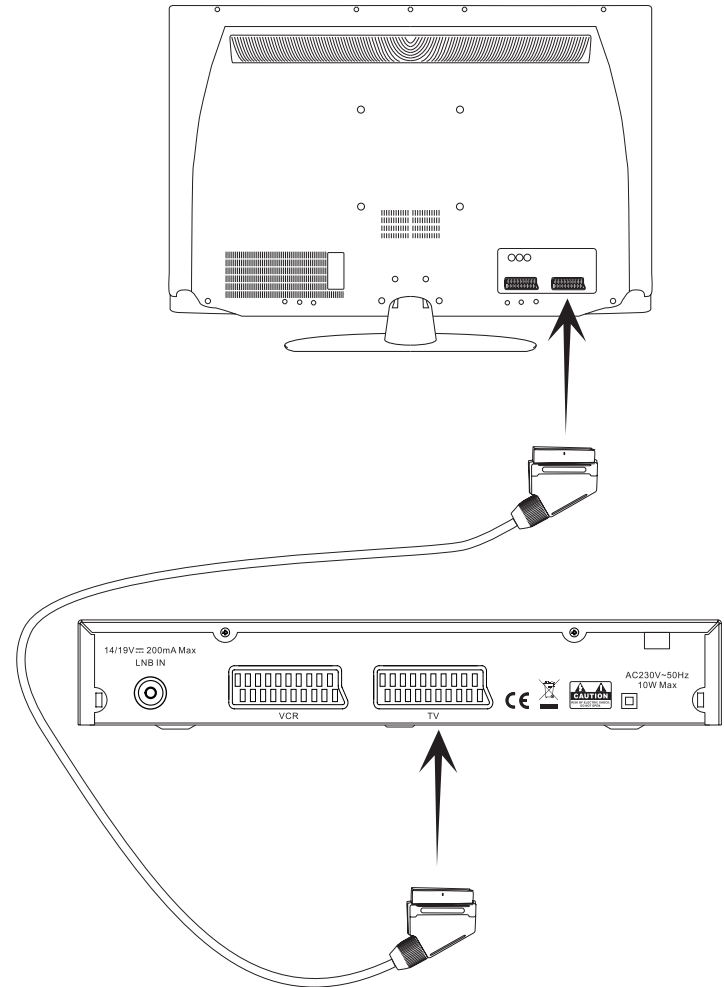

You may have other equipment, such as a DVD player, to connect to the receiver.

You can connect a VCR (video cassette recorder) or DVD recorder to your Plaza DS•100 receiver to record freesat programmes and play them back. You will need to connect a second SCART cable (not supplied) between the VCR SCART socket on the back of the receiver and a SCART socket on the VCR or DVD recorder. Check the VCR or DVD recorder's manual for guidance.

You could connect the Plaza DS•100 receiver to a stereo or surround sound system instead, so that you can listen to the sound through the sound system instead of (or as well as) the television's speakers. You could use the VCR Scart socket on the back of the receiver, but you will need an adapter or special cable to suit the connections of the sound system.

**HINT:** You cannot connect the receiver to a VCR or DVD recorder and a sound system at the same time.

## SWITCHING ON

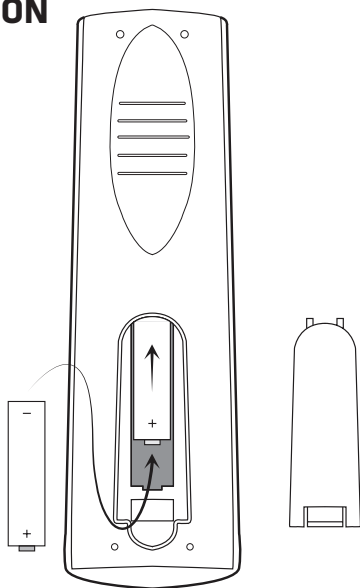

Take the battery compartment cover off the back of the Plaza DS•100 remote control by lifting it up while pushing the catch. Insert the two AAA batteries supplied, as shown on the inside of the compartment, and replace the compartment cover.

Turn your TV set on and choose the correct

channel for the receiver (you usually do this by pressing an 'AV' button on your TV remote control, but check your TV manual for guidance).

Plug the receiver in and switch it on. After a few seconds, the set-up screen shown below will appear on your TV.

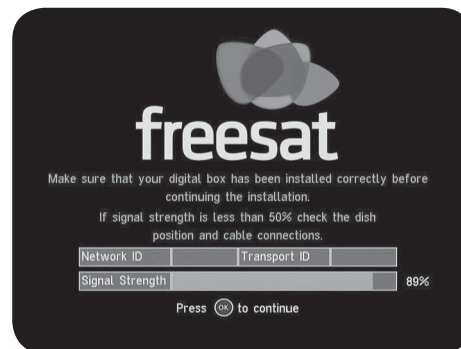

**HINT:** If you do not see this screen on your TV, see 'Troubleshooting' on page 46.

The set-up screen shows the strength of the freesat signal received from the satellite dish. If the signal strength is below 50%, you should check the satellite dish connection at the back of the receiver (switch the receiver off and reconnect the cable if necessary). If the connection is OK, consult your dealer or installer.

When the signal strength shown on the set-up screen is 50% or more, you can tune the receiver in.

## TUNING IN

Because this is the first time that the receiver has been used, there are no channels stored in it's memory. The receiver will automatically find and store channels.

Press the **OK** button on the remote control to search for the 'Network ID' and 'Transport ID'.



**HINT:** The Network ID and Transport ID are in the freesat signal and are used to allow the receiver to identify the satellite dish and freesat network, to make sure the dish is receiving the correct satellite signals.



When the Network ID and Transport ID have been found and displayed, press the **OK** button on the remote control to display the following postcode screen.



## TUNING IN (continued)

Enter your postcode using the number buttons on the remote control followed by the  button.

Then use the  or  buttons to choose the screen format used by your TV (a 16:9 widescreen TV or a squarer 4:3 TV), then press  to start the channel search.

**HINT:** Enter your postcode by pressing the correct number button a number of times to produce the relevant letter (as printed above each button) or number, in the same way as 'texting' with a mobile phone. For example, for an 's' you would press  five times. You do not need to enter a space. If you make a mistake, the  button deletes the last letter or number you entered.





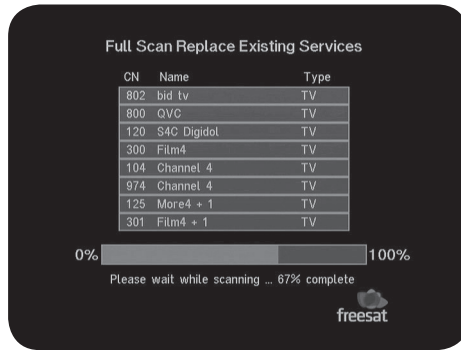

Your Plaza DS•100 receiver will take a few seconds to find and store the available freesat channels, displaying the names of the channels as they are found. When it is finished, the receiver will display the total number of freesat channels it has found.



**Your Plaza DS•100 receiver is now ready for you to receive freesat digital TV and radio.**



**HINT:** When new freesat channels become available, you do not need to tune your Plaza DS•100 receiver again because it is automatically updated.



# 3 EVERYDAY USE

This section describes the day-to-day use of your Plaza DS•100 receiver – how to choose the channel you want to watch and how to control the basic features of your Plaza DS•100 receiver.











## TURNING ON THE RECEIVER



You turn on the Plaza DS•100 receiver by pressing the  button on the remote control or the  button on the front of the receiver. The power light on the front of the receiver changes from red to blue when the receiver is on.

You turn the Plaza DS•100 receiver off, so it goes into standby, by pressing the  button on the remote control or the  button on the receiver. When the receiver is in standby, the power light on the front of it glows red. The Plaza DS•100 uses less power when it is in standby.

**HINT:** You should leave the Plaza DS•100 receiver plugged in, with the socket switched on, at all times (except when there is lightning – see appendix A). If you are not using the receiver, put it in standby by pressing the  button on the remote control or the  button on the front of the receiver.

## CHANGING CHANNELS

Flick through channels by pressing the  and  buttons on the remote control (or the  and  buttons behind the fold-down flap on the front of the Plaza DS•100 receiver). Pressing the  or  button will select the next channel in the channel list. Pressing the  or  button will select the previous channel in the list. When you have chosen the last channel in the list, pressing the  or  button will select the first channel in the list. Similarly, when you are on the first channel, pressing the

 or  button will go to the last channel in the channel list.

If you know the channel number, you can go directly to the channel you want using the number buttons on the remote control. The channel numbers have three digits, and the first channel in the list is 101. As you put in a channel number, each digit appears in the top left of the screen to show the number you have pressed. The radio stations are stored from channel 700 onwards.

Press the  button on the remote control to switch from the channel you are currently watching to the channel you were watching before.

There are several other ways to change channel.

- Use the browsing bar at the bottom of the TV screen (see page 21).
- Use the on-screen channel list (see page 23).

- Use the electronic programme guide (see page 25).

**HINT:** The channel numbers are set by freesat. Because there are spaces left for future channels to join freesat, there are some numbers missing in the channel list.



**HINT:** If you enter a number which is not an available channel, the channel you are watching will not change.

## INFORMATION BAR

Whenever you change channel, the Plaza DS•100 displays an information bar at the bottom of the screen. This stays on the screen for about three seconds.









The information bar shows:

- the name of the programme you are watching, and the time it is on from and to;
- the name of the next programme on that channel, and the time it is on from and to;
- the channel number and name; and
- the time.

**HINT:** If the channel you have chosen is not on at that time, the normal information bar is replaced by one that says 'Service not currently available'.

## CHANGING THE VOLUME

You can turn the volume up or down using the  and  buttons on the remote control or the  and  buttons behind the flap on the front of the Plaza DS•100's receiver. You can turn the sound off completely by pressing the  button on the remote control. To put the sound back on at the previous volume, press the  button again.

**HINT:** The volume and mute buttons also affect the sound supplied to the VCR SCART socket, so using these buttons while you are recording a programme will affect the recording.

## SUBTITLES AND AUDIO DESCRIPTION

Many freesat programmes are broadcast with subtitles for people who are deaf or hard of hearing. You display subtitles by pressing the **(SUB)** button, and turn them off by pressing the **(SUB)** button again. Some programmes have an extra soundtrack to tell people who are blind or partially sighted what is happening on screen. When this soundtrack is available, you need to turn the audio description function on by pressing the **(AD)** button on the remote control. Pressing the button again turns the audio description off.







## BROWSING CHANNELS AND PROGRAMMES



You can see what is on the other freesat channels by using the Plaza DS•100 receiver's browsing facility. Press **(INFO)** on the remote control to display the browsing bar.





The browsing bar shows the name and number of the current channel, the time, and the name and times of the programme currently showing. You can use the **(▶)** button to see the details of the next programme on that channel. Press the **(◀)** button to go back.

## BROWSING CHANNELS AND PROGRAMMES (continued)

Pressing  or  changes the browsing bar to show the details of the next channel up or down the channel list, while you are still watching the current channel. By repeatedly pressing the  or  buttons, you can see what is showing on any of the other freesat channels. If you want to watch the channel displayed in the browsing bar, press , or to remove the browsing bar press .

**HINT:** You can also display the browsing bar by pressing the  or  buttons. You can browse through the channels more quickly by pressing just these buttons.

While the browsing bar is displayed, pressing the  button again will display more details about the channel, including a short summary

of the programme on now or next (whichever you choose) and symbols to say whether the channel has audio description, subtitles, or digital text and whether it is broadcast in high definition or Dolby Digital sound (not available with the Plaza DS•100 receiver). Pressing the  button again removes the extra information from the browsing bar.

## USING THE CHANNEL LIST

You can display the channel list by pressing the **LIST** button on the remote control. This lists the channels on the left-hand side of the screen, in number order, with the current channel (as shown in the window on the right-hand side of the screen) highlighted with an orange bar.



Use the **▲** and **▼** buttons on the remote control to move the orange bar up or down through the channel list to highlight the channel you want to watch. Then press **OK** to close the channel list.

Or you can return to the channel that you were watching before using the channel list by pressing the **EXIT** button.

**HINT:** You can move through the channel list more quickly by using the **P+** and **P-** buttons, which move the orange highlight bar through the list one page (11 channels) at a time.

## REGIONAL CHANNELS

BBC and ITV broadcast different variations of their channels for different regions in the UK. With freesat you can see the variations available to other regions.

The regional variations BBC1, BBC2, and ITV1 you receive are based on the postcode that you entered when you installed the Plaza DS•100. Those variations are channel numbers 101, 102 and 103 in the channel list.



You can watch the ITV1 variation for a nearby region by choosing channel number 977. All the BBC1 and BBC2 regional variations are listed in the channel list from number 950.

You can replace your regions variation of BBC1 or BBC2 with that of another region by pressing the button while channel 101 or 102 is highlighted with the orange bar in the channel list screen.

Choose the region that you want, from the list on the right-hand side of the screen, by moving the highlight bar through the list with the and buttons and then pressing . Or you can press the button to leave the region setting the same.



## USING THE PROGRAMME GUIDE

The Plaza DS•100 can display information about programmes that are showing on all freesat channels in the next seven days. You can browse the full programme schedules with the electronic programme guide, which you see by pressing the **EPG** button.



First, choose the section of the programme guide you want to look at – either all channels or a specific channel genre.





Use the , ,  and  buttons to move the orange highlight bar through the list of sections



until it highlights the section you want, then press **OK**.

**HINT:** You can set the Plaza DS•100 receiver to skip the section screen and always display the programmes for all the channels. The 'Advanced use' section starting on page 29 explains how to do this.

The programme guide screen shows a table of the programmes, with each page showing on eight channels over a two-hour period. On the first page of the programme guide, the current programme on the channel you were watching, highlighted in the centre of the screen with an orange bar. A summary of the highlighted programme is shown above the programme guide. The current date and time is shown at the top of the screen, and an orange line down through the table shows the present time in the schedules.

## USING THE PROGRAMME GUIDE (continued)

You look through the scheduled programmes using the  and  button to move through the channels, and the  and  buttons to move the orange highlight bar across to show the programmes showing at different times. As you move the highlight bar through the tables, the programme summary shown above the table changes to reflect the programme highlighted. You can find details of any programme, on any channel, for up to eight days ahead.

When you reach the last channel on a page of the guide, pressing  moves to the next page. Press  to switch the receiver to the channel and programme highlighted by the orange bar. If the programme is on at the time, the receiver will switch to that channel immediately.

If the programme is scheduled for later on, a reminder is set so that when the programme is about to start, a message is displayed on

screen and, after a few seconds, the receiver automatically switches to the relevant channel. When a programme has a reminder set, a clock symbol is shown next to its name in the programme guide table.

**HINT:** You can jump through the programme guide more quickly using the red and green buttons, which move to the next or previous page of eight channels. The yellow and blue buttons move the highlight bar through the schedules a day back or forward.

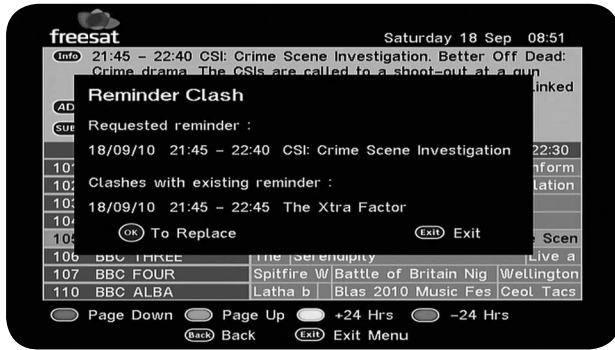

You can set up to eleven reminders but if you try to set a reminder for a programme that is on at the same time as one you have already set a reminder for, a warning is displayed on the screen. You can cancel a reminder by highlighting the programme in the programme guide and pressing **OK** again.

You can leave the programme guide and return to watching TV by pressing the **EPG** or **EXIT** button.

## INTERACTIVE TV SERVICES

Several freesat channels broadcast a range of digital text and interactive services such as news, weather, games, sports information and video alongside normal TV.

You can use the interactive services by pressing the **TEXT** or the red button while watching the TV channel. This will display a menu of services available from that channel or broadcaster.



## INTERACTIVE TV SERVICES (continued)

When you have finished with the interactive services, you can return to normal TV by pressing **(TXT)** again or the **(EXIT)** button.

**HINT:** Different broadcasters provide different interactive services, so we recommend that you try out the interactive options on different channels to discover where the services that most appeal to you are.

## RECORDING FREESAT PROGRAMMES

You can record a programme by connecting a VCR or DVD recorder to the VCR SCART socket on the back of the Plaza DS•100. You will need to choose the recorder's SCART input for recording. See your recorder's manual for more information.

If you have a recorder connected to the receiver, you can record a programme even when you are not at home. Highlight the programme in the programme guide, make a note of the date and time, and set a reminder with the **(OK)** button. Then set the recorder's timer to record from its SCART input on the date and times noted.

Please note that for the recorder's timer to work the Plaza DS•100 must not be in standby mode and 'auto standby' must be disabled (see page 36).

**HINT:** Do not use the channel list, programme, interactive services, and so on while recording a programme as the screen displays associated with these functions will also be recorded.

# 4 ADVANCED USE

The section explains how to get the most out of your Plaza DS•100 receiver.

## TV SCREEN SIZE

The freesat channels broadcast using a widescreen 16:9 format, designed for widescreen TVs.

If you have a squarer 4:3 television, the widescreen image cannot be displayed. You use the **WIDE** button to choose how the Plaza DS•100 fits the 16:9 widescreen image onto your 4:3 screen.

Pressing the **WIDE** button will take you through the three options available:

- only the centre of the image is shown (centre cutout);
- the complete widescreen picture is squeezed into the squarer format (full frame); or
- the complete, unaltered image is shown, smaller and with black bars above and below it.

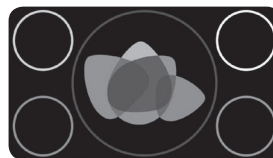

**The full widescreen** broadcast picture.

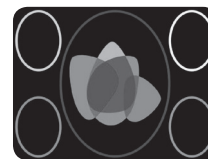

**Full frame** squeezes the widescreen picture into the screen of a 4:3 TV.

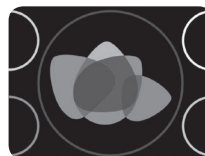

**Centre cutout** displays only the centre of the widescreen picture on a 4:3 TV. This is the factory setting.

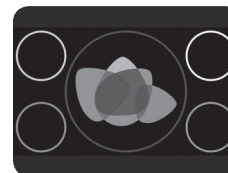

**Letterbox** shows the whole picture on a 4:3 TV with black bars above and below.

**HINT:** The **WIDE** button has no effect on the picture if you have set the TV screen size to '16:9 widescreen' in the settings menu (see page 36).

## TV/DTV

The **TV/DTV** button switches your television from displaying the freesat programmes through the receivers SCART lead to regular broadcasts you receive through the TV aerial. When the Plaza DS•100 is turned on, some televisions will automatically switch to their SCART lead to display the freesat channel. You can use the **TV/DTV** button to release that automatic switch without having to switch off or disconnect the receiver. Pressing the **TV/DTV** button switches the channel displayed on the television between the signal from the aerial (TV) and digital television from freesat (DTV).

## USING THE MENU SYSTEM

Many of the receivers everyday functions are carried out by pressing a single button on the remote control, but the functions used less often are carried out by making a selection from on-screen menus. When you choose one

menu option, it opens up another menu of choices relating to that option.

You open the Plaza DS•100's main menu by pressing the **MENU** button on the remote control. This displays the four main menu options - TV listings, settings, language and information.



You can choose any of these options by pressing the relevant number on the remote control.

**HINT:** At any time when using the menu options you can return to the previous menu screen by pressing the **BACK** button or the **MENU** button. Or, you can return to watching TV by pressing the **EXIT** button.



When you get the Plaza DS•100 the PIN is set to 0000. You can change this to any four digit number, as explained later in this section.

## THE LOCK CODE

Some of the Plaza DS•100 menu options are locked to avoid accidental changes, and you can lock particular channels to prevent some people, such as children, from watching them. To unlock options or channels you need to enter a four-digit PIN using the remote control.

## CHANGING THE CHANNEL LIST

The channel list contains all freesat channels that the receiver found when it was first installed, and may include some channels that you do not watch, do not want to include in the on-screen channel list, or do not want some members of your family to watch.







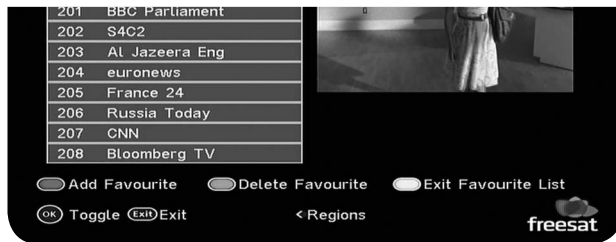

## USING THE FAVOURITE CHANNELS LIST

The favourite channels list makes it easier for you to choose the channel you want to watch, by limiting the on-screen list to just a few channels, such as those you watch the most.



It takes a short time to set up the favourite channels list. First, display the channel list by choosing option 1 from the main menu or by pressing the **LIST** button, then press the yellow button to edit the favourite channels list.



In the list of channels displayed, use the  and  buttons (and the  and  buttons to move a page at a time) to move the orange highlight bar to a channel that you want to include in your favourites. Press the red button to add that channel to the favourite channels list. A channel included in the favourite channels list is shown with a tick against its name. When you have added all the channels that you want to your favourites, press the yellow button again to stop editing the favourites list.

## USING THE FAVOURITE CHANNELS LIST (continued)

**HINT:** You can remove a channel from the favourite channels list by highlighting the channel and pressing the green button. You can also add and delete a channel from your favourites list using the **OK** button.



If you want to see your favourite channels list, go to the channel list and press the green button. To view a channel, highlight it with the

orange bar and press **OK**. You can switch back to the main channel list by pressing the red button.

You can also switch to a channel from the favourite channels list, without going to the channel list.

Press the **FAV** button to switch to the next channel in your favourite channels list (or to the first in the list if you are currently watching a channel that is not in the favourites list). Press the **FAV** button again to switch to the next channel in the list, and so on through your favourites list.

**HINT:** The channels in the favourite channels list are stored in the same order as they appear in the normal channel list, regardless of the order you added them to your favourites list.

## SETTINGS

The selections available from the settings (option 2) in the main menu are concerned with more advanced features of the Plaza DS•100. We recommend that you take the time to read this section carefully before you make changes to the receiver from these menus.

To make changes to any of the settings, first go to the main menu with the **MENU** button, highlighting option 2, and pressing **OK**. Then move the orange highlight bar to the setting that you want to change, and press **OK** to display the options available.

**HINT:** When using the settings menu, you can return to the main menu screen by pressing the **BACK** button or the **MENU** button, or you can go back to watching TV by pressing the **EXIT** button.

## KEY BEEP

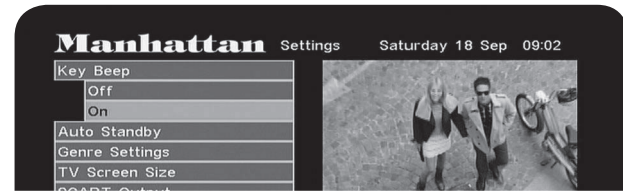



The Plaza DS•100 can produce a small beep through the TV speakers whenever a button on the remote control is pressed. This is to confirm that the button has been pressed and the Plaza DS•100 has received the command. You can turn this beep on or off by moving the orange highlight bar to the option you want and pressing **OK**. A confirmation of the setting is then shown on-screen.

**HINT:** When the key beep option is on, the beep can be heard through the TV speakers even when the receiver's volume is turned down or muted. However, if the TV's volume is turned down or muted, you will not be able to hear it.



## AUTO STANDBY



The Plaza DS•100 automatically goes into standby if it is not used for a long time. If you want to stop the receiver from doing this, use the  and  buttons to move the orange highlight bar to 'disabled' and press . This setting is confirmed on-screen.



## GENRE SETTING



When you press the  button, you get a screen that allows you to display all channels or only channels of a certain genre (type, such as sport, movies, music and so on). If you want to automatically skip the selection screen and see all channels listed in the programme guide, you can turn off the genre setting. Move the orange highlight bar to 'off' and press . The setting is then confirmed on-screen.

## TV SCREEN SIZE



This option allows you to choose which screen size is used when the Plaza DS•100 is turned on. Use the  and  buttons to move the

orange highlight bar to the option you want, then press **OK**. The setting is then confirmed on-screen.

## SCART OUTPUT



This setting alters the signal your TV receives. When you install the receiver, the SCART output is set to RGB, but you can change it to composite video. Use the **▲** and **▼** buttons to move the orange highlight bar to the option you want, then press **OK**. The setting will be confirmed on-screen.

**HINT:** The RGB setting will usually produce the best quality picture, but a few televisions cannot accept this signal. See your TV manual for more guidance.

## PARENTAL SETTINGS





The Plaza DS•100 can be set to prevent people watching adult channels. Move the highlight bar to 'hide adult channels', press **OK** and enter your PIN. The adult category is then removed from the selection screen in the channel list, the adult channels are removed from the channel list and programme guide, and they cannot be selected by putting in the channel number or by skipping through the channels with the **P+** and **P-** buttons. You can allow access to adult channels again by choosing 'show adult channels', pressing **OK**, and entering your PIN.

In the parental settings options you can change the PIN by moving the orange highlight bar to the 'change lock code' option and pressing **OK**. You will need to enter your PIN (the factory setting is 0000) and then enter your new 4-digit PIN. You will need to enter it a second time to confirm your choice.

## MENU TRANSPARENCY SETTINGS

You can turn this setting on so that the menu screens (and other on-screen information) are displayed transparently so that you can see the TV picture behind. Use the **▲** and **▼** buttons to move the orange highlight bar to select 'off' (not transparent), or 25%, 50% or 75%, then press **OK**. The setting will be confirmed on-screen.

## RECEIVER UPGRADE

When new software is made available for your Plaza DS•100, it is automatically downloaded to your receiver through your satellite dish. You can choose to have the receiver updated with new software automatically, or only when you choose to download updates. Use the  and  buttons to move the orange highlight bar, to select either 'manual' or 'automatic', then press . The setting is then confirmed on-screen.



## RESTORING ALL SETTINGS

To restore all settings to what they were when you got the receiver, bring back deleted channels, or retune the receiver if you move to a different area, you can reinstall the Plaza DS•100 as though it were new from the factory. Press  and enter your PIN to start the installation process, and follow the procedure set out in the preparation and tuning in sections of this guide. (see pages 10 and 15).

## CHANGING THE RECEIVER'S LANGUAGE

The freesat channels can broadcast in a number of languages or with subtitles available in a number of languages. The Plaza DS•100 is set to English-language soundtrack and English subtitles, but you can change this setting using the language menu.



Display the main menu by pressing  and press  to display the language menu. Move the orange highlight bar to 'audio language' to alter the choice of language heard, or to 'subtitle language' to alter the language used for subtitles, then press .

## CHANGING THE RECEIVER'S LANGUAGE (continued)



Move the orange highlight bar to the language you want from the list of languages displayed, then press **OK**. Press **EXIT** to return to watching TV.

## RECEIVER INFORMATION

The Plaza DS•100 can display a page of information about your particular receiver and your reception. This includes the signal strength, the version of the receiver hardware

and the software installed, and the postcode you entered when you installed the receiver.

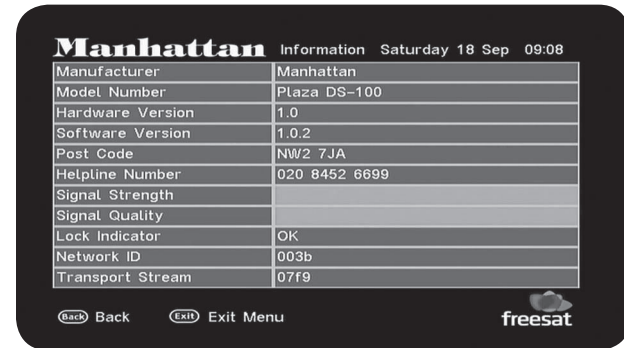

Display the main menu by pressing **MENU**, and press **4** to display the information screen.

**HINT:** We recommend that you have this screen displayed on your TV if you need to phone the Plaza DS•100 helpline.



# 5 NON-FREESAT CHANNELS

This section explains how to set up your Plaza DS•100 receiver to receive channels that are not included with freesat. As well as receiving the many freesat channels, the Plaza DS•100 can also be used to watch other satellite channels as long as a channel is broadcast from the same satellites as freesat and is free.

**HINT:** You have to tune in non-freesat channels and they are less convenient to switch to. Some functions of the Plaza DS•100 are not available when viewing non-freesat channels.



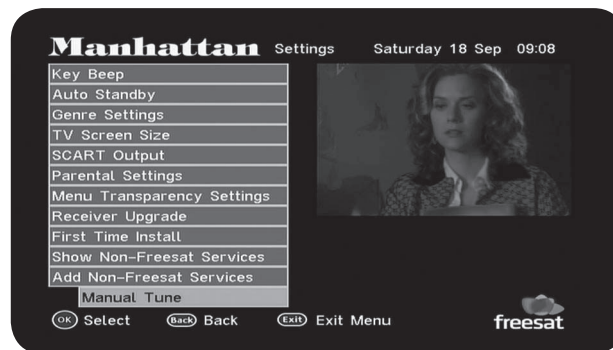

## TUNING IN NON-FREESAT CHANNELS

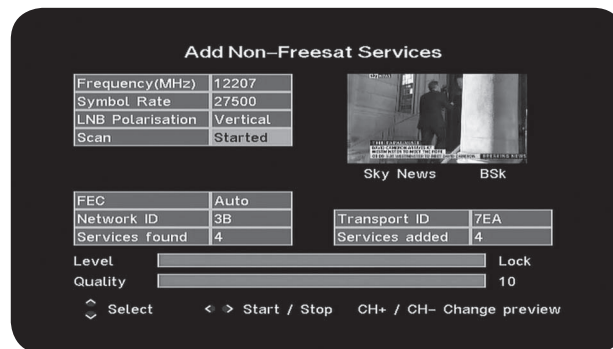

Go to the settings menu by pressing (MENU) followed by (2), highlight the last option, add non-freesat services' and press (OK) twice to open the manual-tuning menu.







## TUNING NON-FREESAT CHANNELS (continued)

Use the  and  buttons to move between the boxes for the 'frequency', 'symbol rate' and 'LNB polarisation' boxes, and in each enter the relevant values with the number buttons or the  and  buttons. The 'level' and 'quality' displays at the bottom of the screen show if there is a signal present with those values.

**HINT:** The tuning information for non-freesat channels may be given in specialist magazines and on the particular channel's website.

Move the highlight bar to the 'scan' box and press  to start scanning for new channels. If any new channels are found, the first of those channels is displayed in the small preview window. You can change the channel displayed

using the  and  buttons. All new channels are stored automatically. Once you have tuned in all the non-freesat channels you want, leave the manual tuning menu and return to the settings menu by pressing .





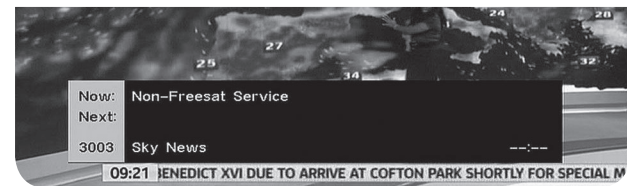

You should now choose the 'show non-freesat services' option, move the orange highlight bar to 'yes', and press . This enables the channel list to display the non-freesat channels for selection and viewing.

## WATCHING NON-FREESAT CHANNELS



Non-freesat channels are stored from channel number 3000 onwards, but they are not listed in

the programme guide and the  button gives no information on the programmes showing. They cannot be added to your favourite channels list and you cannot choose them with the number buttons on the remote control.

You can only choose a non-freesat channel from the channel list or by stepping from another non-freesat channel using the  and  buttons. Press  to display the main channel list and then the  button to switch to the non-freesat list. Choose the non-freesat channel you want to watch by highlighting it with the orange bar using the  and  buttons, then press .

**HINT:** There may be some non-Freesat channels listed that you do not want, and you can delete these in the normal way using the  button.

## APPENDIX A - SAFETY

### POWER

The receiver should be plugged into a 230V to 240V AC, 50Hz supply.

### CABLES

Make sure all cables are positioned so they are not likely to be walked on, crushed or damaged by things placed on or against them. Pay particular attention to the power cable where it goes into the socket and where it comes out of the receiver. Do not connect or adjust cables to the receiver when it is plugged in.

### TEMPERATURE AND MOISTURE

Do not use or leave the receiver in a hot, cold or humid (moist) environment. Do not allow the receiver to get wet – from drips or splashes – as this is dangerous. Do not place vases or other water-filled objects on top of the receiver.

## **VENTILATION**

Slots and openings in the receiver's cover are for ventilation. Do not cover or block them as this could lead to the receiver overheating.

## **CLEANING**

Unplug the receiver before you clean it with a lightly dampened cloth. Do not use liquid or aerosol cleaners.

## **HEAT AND FLAMES**

Do not place the receiver near to naked flames or sources of intense heat, such as an electric fire. Make sure that no flames, such as lighted candles, are placed on top of the receiver.

## **LIGHTNING**

If there is a storm or lightning, unplug the receiver.

## **SERVICING**

Make sure that anyone who services your

receiver is qualified to do so. Do not remove the cover yourself – you could get an electric shock.

## **REPLACEMENT PARTS**

If your receiver needs repairing, make sure the person carrying out the repair uses parts which are specified by us or which have the same specifications as the original part. Other parts may cause a fire, electric shock or other dangers.

**ELECTRICAL SAFETY** Your receiver needs a 230V AC ~ 50Hz mains supply and is fitted with a moulded plug. If the plug breaks or becomes damaged, do not use it. If you change the fuse in the plug, make sure you refit the fuse cover. If the plug needs replacing, follow these instructions. The wires in the mains lead are coloured in line with the following code.

Blue - *Neutral*  
Brown - *Live*

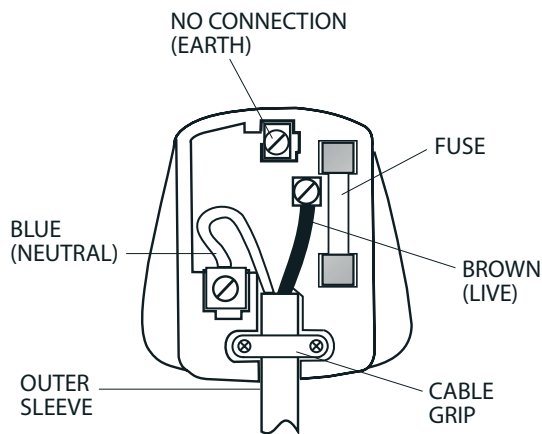

## PROTECTING THE ENVIRONMENT

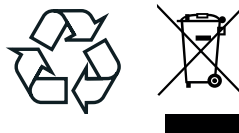

If you one day find that your receiver or remote control needs replacing, or are of no further use to you, do not throw them out with your household waste. Under the Waste Electrical and Electronic Equipment (WEEE) regulations, your local council must provide a suitable recycling centre.

Do not throw batteries in the bin or on a fire. Make sure that you dispose of batteries safely at a local recycling centre. You can also recycle batteries at many supermarkets.

## APPENDIX B – TROUBLESHOOTING

PROBLEM	POSSIBLE CAUSE	WHAT TO DO
<b>Power light off</b>	Power cable disconnected	Check the power cable.
	Mains fuse blown	Check the fuse.
<b>No set up screen</b>	Receiver not switched on	Switch on the receiver, check the power cable, the switch at the socket and the fuse.
	SCART lead disconnected	Check the SCART lead is connected to the receiver and the TV.
	Television not switched to SCART input	Choose the TV's SCART input (see the TV manual for guidance).
<b>Signal strength below 50%</b>	Cable from the satellite dish disconnected	Check the cable connections at the receiver and the dish. Consult your installer if necessary.
	Cable from the satellite dish faulty	Replace the cable from the satellite dish. Consult your installer if necessary.
	Dish in the wrong position	Reinstall the dish. Consult your installer if necessary.
<b>'No signal' message</b>	Cable from the satellite dish disconnected	Check the cable from the dish. Consult your installer if necessary.
	Dish damaged or in the wrong position	Check the dish. Consult your installer if necessary.

<b>No picture or sound</b>	SCART lead disconnected	Check the SCART lead connections at the receiver and the TV.
	TV not switched to SCART input	Choose the TV's SCART input channel.
<b>Full picture not visible</b>	Mismatched screen format	Choose the correct screen size to suit your TV.
<b>No response to remote control</b>	Receiver in standby	Switch the receiver on.
	Remote control not aimed at the receiver correctly	Aim the remote control at the receiver.
	Remote sensor on the front of the receiver is obstructed	Check for obstructions in front of the receiver.
	Batteries in the remote control need replacing	Replace the batteries in the remote control.
<b>Cannot view a channel</b>	Wrong channel number used	Choose the channel from Channel List.
	Channel locked	Enter the PIN. If you have forgotten the PIN, phone the helpline on 020 8450 0005.
<b>No information for a channel in the programme guide</b>	Information on the channel not downloaded	Wait for the download.
	Tuned to non-freesat channel	Tune to a freesat channel
<b>Can't record a channel</b>	No connection to recorder	Connect a SCART lead from the receiver to the recorder.
	Wrong recorder input selected	Select the recorder's SCART input. See the recorder's manual for guidance.

HELPLINE

020 8450 0005

[www.manhattan-tv.com](http://www.manhattan-tv.com)

## APPENDIX C - SPECIFICATIONS

<b>Tuner</b>	Input frequency	950~2150MHz
	Input connector	F type, female 75 ohm
	LNB supply	14.0V / 19.0V (maximum.350mA), short-circuit protected
	Digital signal input level	-25 to -65 dBm
<b>Video</b>	Aspect ratio	4:3, 16:9 and letter box
	Video output	Two SCART sockets; TV (CVBS/RGB) & VCR (CVBS)
<b>Audio</b>	Audio output	Audio left and right
<b>Power Requirements</b>	Mains input voltage	230-240VAC~ 50Hz
	Power consumption	Maximum 10W (LNB with 200mA)
<b>Dimensions</b>	Width, depth and height	Width: 258mm, x depth: 175mm, height: 44mm



## Free Manuals Download Website

<http://myh66.com>

<http://usermanuals.us>

<http://www.somanuals.com>

<http://www.4manuals.cc>

<http://www.manual-lib.com>

<http://www.404manual.com>

<http://www.luxmanual.com>

<http://aubethermostatmanual.com>

Golf course search by state

<http://golfingnear.com>

Email search by domain

<http://emailbydomain.com>

Auto manuals search

<http://auto.somanuals.com>

TV manuals search

<http://tv.somanuals.com>