

OWNER'S MANUAL

MANLEY MASSIVE PASSIVE STEREO TUBE EQ

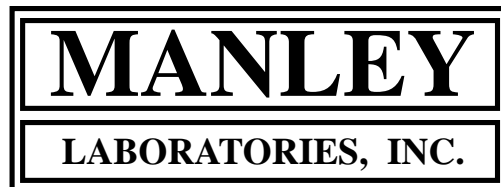

**MANLEY LABORATORIES, INC.
13880 MAGNOLIA AVE.
CHINO, CA. 91710
TEL: (909) 627-4256
FAX: (909) 628-2482**

**<http://www.manleylabs.com>
email: [emanley @ manleylabs.com](mailto:emanley@manleylabs.com)
email: [service @ manleylabs.com](mailto:service@manleylabs.com)**

Rev. MSMPXxxxx

CONTENTS

<i>SECTION</i>	<i>PAGE</i>
INTRODUCTION	3
BACK PANEL & CONNECTING	4
FRONT PANEL	5,6,7,8
CREDITS	8
THE MASSIVE PASSIVE	
BEGINNINGS, THE SUPER PULTEC	9
THE PASSIVE PARAMETRIC	10
WHY PASSIVE, WHY PARALLEL	11
PHASE SHIFT, WHY TUBES	12
CURVES	13 to 16
TUBE LOCATIONS, ETC	17, 18
EQUALIZING	
EQUALIZERS (GENERAL)	19
EQUALIZER TECHNIQUES	20 to 24
TRANSLATIONS	25
TROUBLESHOOTING	26, 27
MAINS CONNECTIONS	28
SPECIFICATIONS	29
WARRANTY	30
WARRANTY REGISTRATION	31
APPENDIX 1 - EXAMPLE SETTINGS	32
APPENDIX 1 - TEMPLATE FOR STORING SETTINGS	33

INTRODUCTION

THANK YOU!...

for choosing the Manley **MASSIVE PASSIVE STEREO TUBE EQUALIZER**. This EQ is supposed to be somewhat different from any EQ you may have used before, as well, this manual may be a bit unusual in that you may find it worthwhile to read. Even though at first glance the Massive Passive looks fairly conventional, you should take an hour and read this manual before you jump to conclusions or confusions. The usual stuff like precautions, hook-up instructions, and operational information is here but also explanations about how and why this is an unusual animal and hints of how you may find different settings than you are used to being the key to getting the most out of this box. There is even a little section of EQ hints or techniques for those who may find that info useful.

As you use this EQ, probably a number of descriptive words may come to you. It has been called "organic", "natural", "smooth", "liquid", "powerful", "sweet", and "the mother of all EQs". There is no single reason why it sounds the way it does but more of a synergy of the advantages of passive EQ, the parallel topology, the tube/transformer amplifiers, the unique shelves and, of course, Manley's construction style and use of premium components. Like the Manley Variable MU, we have found the Massive Passive can easily make anything sound better. Perhaps the combination of the "Vari-MU" and the "Passivo" is the killer combination for music. You may find yourself using it everything. Any gear that you prefer to use on every sound is a sure sign you bought the right piece.

The Massive Passive is intended as an EQ platform and in the future should offer some interesting custom options. At some point we expect to offer other EQ cards that can replace some of the passive cards for particular needs and special applications.

GENERAL NOTES

LOCATION & VENTILATION

The Manley **MASSIVE PASSIVE** must be installed in a stable location with ample ventilation. It is recommended, if this unit is rack mounted, that you allow enough clearance on the top of the unit such that a constant flow of air can move through the ventilation holes. Airflow is primarily through the back panel vents and out through the top.

You should also not mount the Massive Passive where there is likely to be strong magnetic fields such as directly over or under power amplifiers or large power consuming devices. The other gear's fuse values tend to give a hint of whether it draws major power and is likely to create a bigger magnetic field. Magnetic fields might cause a hum in the EQ and occasionally you may need to experiment with placement in the rack to eliminate the hum. In most situations it should be quiet and trouble free.

WATER & MOISTURE

As with any electrical equipment, this equipment should not be used near water or moisture.

SERVICING

The user should not attempt to service this unit beyond that described in the owner's manual. Refer all servicing to your dealer or Manley Laboratories. The factory technicians are available for questions by phone (909) 627-4256 or by email at <service@manleylabs.com>. Fill in your warranty card! Check the manual - Your question is probably anticipated and answered within these pages.....

THE BACK PANEL

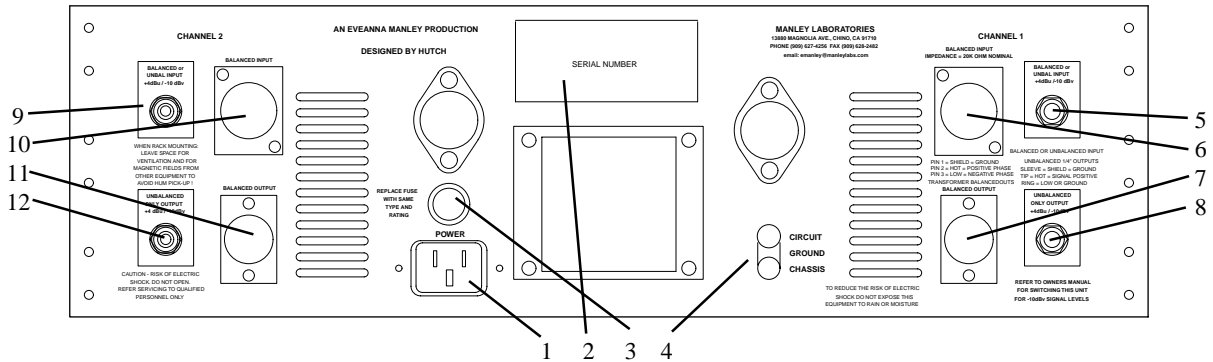

First connect all the cables, then turn on the power, wait 30 seconds, then have fun, as if we had to tell you....

1) **POWER CONNECTOR.** First verify the POWER SWITCH on the front panel is off (CCW). Use the power cable supplied with your Massive Passive. One end goes here and the other end goes to the wall outlet. You know all this.

2) **VOLTAGE LABEL (ON SERIAL STICKER).** Just check that it indicates the same voltage as is normal in your country. It should be. If it says 120V and your country is 220V, then call your dealer up. If it says 120V and you expect 110 it should work fine.

3) **FUSE.** Unplug the power cable first. The Fuse Cap needs a push then turn a quarter twist CCW to pull off. Fuses are meant to "blow" when an electrical problem occurs and is essentially a safety device to prevent fires, shocks and big repair bills. Only replace it if it has "blown" and only with the same value and type (2A slow-blow for 120V, 1A slow-blow for 220V). A blown fuse either looks blackened internally or the little wire inside looks broken. A blown fuse will prevent all the LEDS from lighting and will prevent any power and audio.

4) **GROUND TERMINALS.** You probably don't need to worry about these. Normally there is a metal strip joining CIRCUIT and CHASSIS Grounds. This is the first place to look if you get a hum. Make sure the strap hasn't fallen off or use a piece of wire to join the terminals. The CIRCUIT Ground is the internal audio ground (including the 1/4" jack sleeves). The CHASSIS Ground is the metal chassis, third pin electrical ground and pin 1 of the XLRs. Some studios use special grounding practices and these terminals are meant to make it easy to hook up this unit for a wide variety of installations. They also help with troubleshooting hum problems.

5) **PHONE JACK INPUT.** (Channel One or Left) Accepts balanced or unbalanced sources. Factory set-up for +4dBu pro levels. There are some DIP switches internally that can change this to -10dBv semi-pro or hi-fi levels. The pin out is as follows: Tip = Positive = Hot, Ring = Negative = Low or ground, Sleeve = Circuit Ground. If you use TRS plugs be sure that the ring is connected to the negative or ground and not "open". Input impedance is 20K ohms. See page 16 & 17 for the DIP Switch details.

6) **XLR JACK INPUT.** (Channel One or Left) Accepts balanced or unbalanced sources. Only for +4dBu pro levels. The DIP switches have no effect on the XLRs. The pin out is as follows: PIN 2 = Positive = Hot, PIN 3 = Negative = Low or ground, PIN 1 = Chassis Ground. Be sure that the PIN 3 is connected to the negative or ground and not "open" or a 6dB loss or loss of signal will happen. In general, the XLRs and +4 pro levels are slightly preferable over phone plugs especially if gold plated matching XLRs and good cable are used.

7) **XLR JACK OUTPUT.** (Channel One or Left) Transformer Balanced and Floating. Only for +4dBu pro levels. The DIP switches have no effect on the XLRs. The pin out is as follows: PIN 2 = Positive = Hot, PIN 3 = Negative = Low or ground, PIN 1 = Chassis Ground. Be sure that the PIN 3 is connected to the negative or ground and not "open" or a complete loss of signal will happen. Output impedance is 150 ohms and output levels can reach +37 dBv (hot) which may distort the next piece in the chain.

8) **PHONE JACK OUTPUT.** (Channel One or Left) Unbalanced output only. Factory set-up for +4dBu pro levels. There are some DIP switches internally that can change this to -10dBv semi-pro or hi-fi levels (with a phase reverse). The pin out is as follows: Tip = Positive = Hot, Sleeve = Circuit Ground. If you use TRS plugs be sure that the ring is connected to the negative or ground and not "open". See page 16 & 17 for the DIP Switch details.

9) **PHONE JACK INPUT.** (Channel Two or Right) Same as 5 above.

10) **XLR JACK INPUT.** (Channel Two or Right) Same as 6 above.

11) **XLR JACK OUTPUT.** (Channel Two or Right) Same as 7 above.

12) **PHONE JACK OUTPUT.** (Channel Two or Right) Same as 8 above.

THE FRONT PANEL

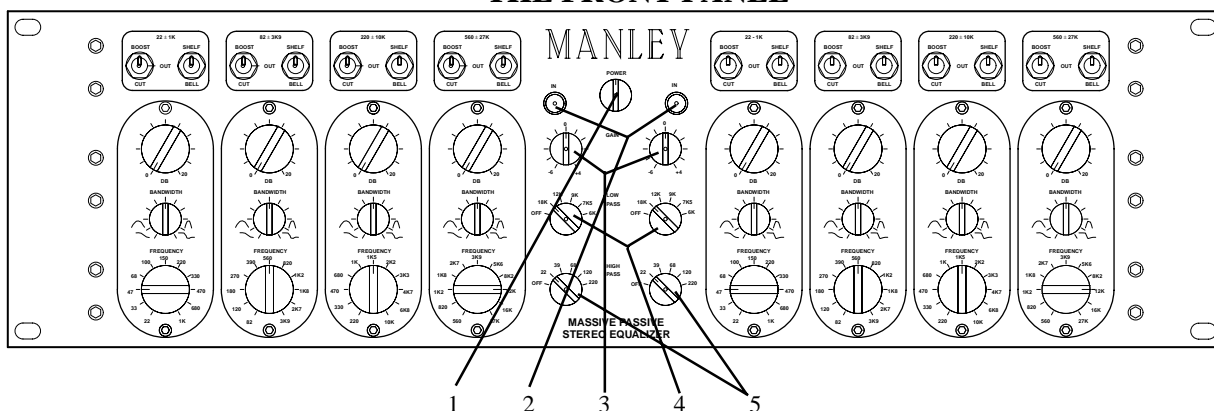

1) **The Power Switch:** First things first, turn it clockwise to power up the unit. There is no "power on LED", instead you can use any of the Boost / Off / Cut switches in Boost or Cut and they light immediately with power on. There is a "warm-up" circuit that forces the unit into "Bypass" for about 20 seconds, to prevent big thumps from hitting your speakers. This also prevents the blue LEDs that indicate "EQ IN" from lighting up for that 20 seconds. This is not a total hardwire bypass - if power is not on, the unit will not pass audio. At trade shows, we have seen a few people turn the "Power Switch" by accident, perhaps thinking it was a tone control. Not knowing, there is a "warm-up" circuit, and seeing no blue light action, they thought they may have broken the unit. The lack of a "power LED" is just one of the deliberate ideosyncracies. 4 reasons: there wasn't a great place to put one, it was redundant with 16 boost/cut LEDs (we were laughing at other panels with dozens of lit LEDs and a fast turn-on LCD screen also sporting a big power LED), and this unit is meant for professionals that we assume can plug in a piece of gear, see (or feel) the switch and turn it on, and it may annoy those who want all gear to be just "normal" ;-)

2) **EQ IN buttons:** Push to activate the EQ circuits. The buttons glow blue when EQ is IN including the Filters and Gain Trims. The "warm-up" circuit prevents both EQ to be IN and the buttons from lighting when it first gets powered up. In "bypass" (unlit) the tubes are not in circuit but the input amplifier and balanced output transformer are in circuit. Yes, real blue LEDs.

3) **Gain Trims:** Intended to help match levels between "Bypass" and "EQ IN" modes so that the EQ effect can be more accurately judged. It is difficult to compare if the level jumps up or down and easy to prefer EQ when mostly it is just louder. These trims only have a small range of -6 to +4 dB of gain. With drastic EQ there may not be enough range to match levels but with drastic EQ this kind of comparison is of little use. The range is small to allow easier and finer adjustments.

4) **Low Pass Filters:** They pass lows and chop highs. There is a separate filter for each switch setting and they only share the switch and one resistor. The filters are entirely passive and "inserted" between the boost sections and cut sections. The **18kHz** filter is probably most useful for warming up digital. It seems to remove some irritating super-sonic noise associated with digital to analog converters. It is designed as a modified elliptical filter down 60dB one octave up (36kHz) on paper but in real life "only" drops about 40 dB. It is flat within 0.5dB up to 16kHz then very steeply drops. It is sonically subtle. **12kHz** position can be considered general purpose hiss killing. It is also very flat up to 11kHz and drops at 30 dB/octave. **9kHz, 7.5kHz & 6 kHz.** These are intended for more creative sound sculpting than as utility filters. They have a 1.5 to 2 dB bump or boost right before they cut at 18dB/octave. This helps compensate for the perceived loss of highs while still allowing deep HF cuts. This gives them a little color and edge as opposed to just dullness. You may find they help remove some of that buzzy super high distortion of cranked guitar rigs as well as help some synth and bass sounds. They are also intended to help with "effects" such as "telephone sound" and vintage simulations and for some techno, rap and industrial style music.

5) **High Pass Filters:** They pass highs and chop lows. There is a separate filter for each switch setting and they only share the switch and one resistor. The filters are entirely passive and "inserted" between the boost sections and cut sections. They are all 18dB/octave (most modern filters are 12), with no bumps and no resonances. We use a large, low DCR, custom inductor. The **22Hz** is very subtle and is designed to remove sub-sonic frequencies that may have been boosted by previous EQ. Most signal below 25Hz is only good for testing or messing up sub-woofers. You may not hear the effect in the studio, but often you can see it on the meters. Now that sub-woofers are becoming common in autos and consumer systems, we are hearing more complaints of excess lows and LF garbage. This filter is in response to these concerns and requests from mastering engineers. The **39Hz** filter can be used similarly, but may be audible with some material. This filter, as with the others, can be used with the normal boost/cut sections for a more tailored low EQ. This can allow bigger and more effective LF boosts while minimising the side-effects of excessive woofer excursions and unwanted audible LF noise like air conditioner or subway rumble. The **68Hz** filter is also general purpose and ideal for most vocals and pop removal. Also good in combination with shelves. **120** and **220Hz** filters are intended for garbage removal, sonic sculpting, and effects. 120 is useful for some vocals. The 220 is for some close miked hi-hats and percussion instruments. Yup, 220Hz tends to be drastic and only occasionally valuable.

Check out the curves on page 16 for a little more detail on these filters.

4) **BANDWIDTH.** Similar to the "Q" control found in many EQs. A more accurate term here would be "Damping" or "Resonance" but we used "Bandwidth" to stay with Pultec terminology and because it is a "constant bandwidth" (*) design rather than "constant Q" and because of the way it uniquely works in both Bell and Shelf modes. In Bell modes, you will find it similar to most Q controls with a wider shape fully CCW and narrower fully CW. The widest Q (at maximum boost) is about 1 for the 22-1K band and 1.5 for the other 3 and the narrowest Q is about 2.5 to 3 for all of the bands and most of the frequencies. On paper, the bell widths appear to have less effect than is apparent on listening and the sound is probably more due to "damping" or "ringing" and the way it interacts with the gain. Also some people associate a wide bell on conventional EQs with more energy boost or cut, and at first impression the Massivo seems to work backward compared with that and narrow bandwidths give more drastic results. On the Massive Passive a narrow bandwidth bells will allow up to the full 20 dB of boost (or cut) and wide bandwidths significantly less at about 6 dB maximum.

In Shelf Modes the Bandwidth has a special function. When this knob is fully CCW, the shelf curves are very similar to almost all other EQs. As you increase the Bandwidth control, you begin to introduce a bell curve in the opposite direction. So if you have a shelf boost, you gradually add a bell dip which modifies the overall shelf shape. At straight up, it stays flatter towards the mid range, and begins to boost further from the mids with a steeper slope but the final maximum part of the boost curve stays relatively untouched. With the Bandwidth control fully CW, that bell dip becomes obvious and is typically 6dB down at the frequency indicated. The boost slope is steeper and the maximum boost may be about 12 dB. These curves were modelled from Pultec EQP1-As and largely responsible for the outrageous "phatness" they are known for. As you turn the Bandwidth knob (CW), it seems as if the shelf curve is moving further towards the extreme frequencies, but mostly of this is just the beginning part of the slope changing and not the peak. This also implies, that you may find yourself using frequencies closer to the mids than you might be used to. These shelf curves have never been available for an analog high shelf before and provide some fresh options.

5) **FREQUENCY.** Each band provides a wide range of overlapping and interleaving frequency choices. Each switch position is selecting a different capacitor and inductor. Only the 22 and 33 Hz on the low band and the 16K and 27K in shelf mode deserve some special explanation. These have been "voiced" a little different from the rest and are somewhat unique.

Why "modify" the way the 22, 33, 16K and 27K shelves work? When we specify that a low shelf is at 22 Hz, it means that only the half-way point of the boost (or cut) is 22 Hz. If we dial up a 20 dB boost set at 22Hz then 22 Hz is half-way up the slope or boosted 10dB. The full amount of the boost (20 dB) is only kicking in around 2 Hz. This is dangerous and almost useless for anything except whale music. Not only that, but now we have a Bandwidth control that seems to push the frequency lower, and at 12:00 essentially flattens the EQ at 22Hz. So we changed the Bandwidth control for those two lowest frequencies so that it acts as a HP filter as you turn it CW and tends to prevent boosting excessive sub-sonic frequencies. To our ears, it seems to "tighten up" the shelf and removes some of the sloppy looseness associated with those sub-sonics.

The 16kHz and 27kHz shelves were also specially "voiced" for similar reasons. In this case, a 50kHz low pass filter prevents these shelves from helping receive the local AM radio stations. The Bandwidth-Dip frequencies were lowered to about 8 kHz so that on a single band, you would have more effective control between the balance of "air" and "sibilance". In practice, it gives you a great deal of air without the usual problem "esses" when you boost a lot of highs.

At extreme high and low frequencies (including 10K and 12K), you might get some unexpected results because of the Bandwidth/Shelf function. For example, you can set up 20 dB of boost at 12K and it can sound like you just lost highs instead of boosting. This happens when the Bandwidth control is more CW only and not when it is CCW. Why? You are creating a dip at 12K and the shelf is only beginning at the fringes of audibility but the dip is where most of us can easily perceive. It takes a little getting used to the way the controls interact. The reverse is also true, where you set up a shelf cut and you get a boost because of the Bandwidth control being far CW. In some ways this simulates the shape of a resonant synthesizer filter or VCF except it doesn't move. These wierd highs are useful for raunchy guitars and are designed to work well with the Filters. There are a lot of creative uses for these bizarre settings including messing up the minds of back-seat engineers. There is some example settings near the back page that may help to show how different this EQ is.

* For the technically minded, there is another and stronger definition of "constant bandwidth" filters but it doesn't seem to apply to pro audio. In FM radio receivers "constant bandwidth" is a type of filter used in the tuning sections, and the filter width allows the reception specs to stay constant as the tuning filter is moved. It is unlikely anybody has ever offered this type of constant bandwidth filter lowered to audio frequencies. Given that we have about 3 decades of frequency in audio, can you imagine an EQ that had a Q of 0.3 (very wide) in the lows and a Q of 30 in the highs (extremely narrow)? For perspective, a Q range of 1 to 10 is a pretty wide span. There are a few EQs that get slightly narrower Qs as the frequency is increased but not even close to true "constant bandwidth" the RF engineers appreciate. This is either deliberate or the result of trying to squeeze too much range out of a simple inductor. Manley Labs prefers the bell shape to remain relatively constant at all frequencies and the Massivo uses 14 tap inductors with low DCR to provide this. The only possibly useful "Q variation" (other than a Q knob) is a circuit that gives a wider Q for boosts and a narrower Q for cuts. This very rare technique is cool for music. It corresponds to the way many engineers use EQs and reduces audible ringing and EQ "signature".

NOTES

- 1) Do not assume the knob settings "mean" what you expect they should mean. Part of this is due to the interaction of the controls. Part is due to the new shelf slopes and part due to a lack of standards regarding shelf specification.
- 2) You may find yourself leaning towards shelf frequencies closer to the mids than you are used to and the "action" seems closer to the edges of the spectrum than your other EQs. Same reasons as above.
- 3) You may also find yourself getting away with what seems like massive amounts of boost. Where the knobs end up, may seem scary particularly for mastering. Keep in mind that, even at maximum boost, a wide bell might only max out at 6 dB of boost (less for the lowest band) and only reaches 20 dB at the narrowest bandwidth. On the other hand, because of how transparent this EQ is, you might actually be EQing more than you could with a different unit. Taste rules, test benches don't make hit records, believe your ears.
- 4) Sometimes the shelves will sound pretty wierd, especially (only) at the narrow bandwidth settings. They might seem to be having a complex effect and not only at the "dialed in" frequency. This is certainly possible. Try wider bandwidths at first.
- 5) If you seem to be boosting all 4 bands at widely separated frequencies and not hearing much "EQ" as you might expect (except for level) this is a side-effect of a passive EQ and probably a good thing. To get drastic sounding EQ you should try boosting a few bands and cutting a few bands. In fact, it is usually best to start with cutting rather than boosting.
- 6) A reasonable starting point for the Bandwidth for shelves is straight up or between 11:00 and 1:00. It was designed this way and is roughly where the maximum flatness around the "knee" is, combined with a well defined steep slope.
- 7) The Massive Passive has some internal dip switches for better optimised -10 applications however it is a slightly flawed implementation - it reverses the phase or polarity so we only recommend using the +4 factory setting. If one *must use* -10 unbalanced mode, please consider using special cables where the input is wired ring hot or using the phase switch on the console or workstation. On the other hand, if a set-up requires -10 levels and can't deal with +4 pro balanced signals, then maybe, absolute polarity issues are a relatively minor problem.
- 8) The Massive Passive may sound remarkably different from other high end EQs and completely different from the console EQs. Yes, this is quite deliberate. Hopefully it sounds better, sweeter, more musical and it complements your console EQs. We saw little need for yet another variation of the standard parametric with only subtle sonic differences. We suggest using the Massive Passive before tape, for the bulk of the EQ tasks and then using the console EQs for some fine tweaking and where narrow Q touch-ups like notches are needed. The Massive Passive is equally at home doing big, powerful EQ tasks such as is sometimes required for tracking drums, bass and guitars, or for doing those demanding jobs where subtlety is required like vocals and mastering.

CREDITS

PRODUCED BY EVEANNA MANLEY

EveAnna suggested that we work on a "tube parametric", and had a lot to do with the look of the Massive Passive including the back-lit panels, engraved inserts and the name. She cleverly allowed the designer almost total freedom in the execution.

NAMED BY: RANDY PORTER & JUSTIN WEIS

We were less than thrilled by the working names we were using which included "Furthermore", and "Antiquazer" so we ran a "name this EQ" contest on our website with a cash or credit prize (good reason to check out www.manleylabs.com once in a while). We got hundreds of names (most featuring the letter Q) but Randy and Justin separately came up with Massive Passive and they both won and they both applied their credit towards the EQ they named. The nickname "Massivo" comes from "Massivo Passivo" which the Manley assemblers prefer to call it.

DESIGNED BY "HUTCH"

Craig Hutchison came up with the concepts, circuits, and boards. Given that the Massivo is quirky, eccentric and over-the-top, you can pretty much guess what the designer is like. He used SPICE3, WAVES plug-ins and several complex looking breadboards and many listening tests in the process. Again, blame him for this long-winded, opinion-filled manual.

OTHER VALUED CONTRIBUTORS

Baltazar helped with circuit boards, mechanical drafting and proto-assembly. Michael Hunter helped develop all the inductors (which was a major task). Dave Hecht (Record Plant), George Peterson (MIX), Seva (WAVES) and Ross Hogarth (Freelance Engineer) were valuable sounding boards in the concept stage and Dave was the first to really evaluate it. Elias Guzman fabricated all the circuit boards including several protos. Pre-production beta-testers include Larry, Rick, Don & Spencer at Precision Mastering, Dave Collins at A&M Mastering, and Eddie Schreyer at Oasis Mastering, all known for their ears and honest opinions. Last but not least, our dealers for their faith in us, especially, Barb and Al at Studio Tech in Texas, Raper Wayman in the UK, Coast in Hollywood, and many more.

Beginnings

The very earliest equalizers were very simple and primitive by today's standards. Yes, simpler than the hi-fi "bass" and "treble" controls we grew up with. The first tone controls were like the tone controls on an electric guitar. They used only capacitors and potentiometers and were extremely simple. Passive simply means no "active" (powered) parts and active parts include transistors, FETs, tubes and ICs where gain is implied. "Passive" also implies no boost is possible - only cut. The most recent "purely passive EQ" we know of was the EQ-500 designed by Art Davis and built by a number of companies including United Recording and Altec Lansing. It had a 10 dB insertion loss. No tubes. It had boost and cut positions but boost just meant less loss. Manley Labs re-created this vintage piece and added a tube gain make-up amp for that 10 dB or make-up gain to restore unity levels. It has a certain sweetness too.

You have probably heard of passive crossovers and active crossovers in respect to speakers or speaker systems. Each has advantages. Almost all hi-fi speakers use a passive crossover mounted in the speaker cabinet. Only one amp is required per speaker. Again, passive refers to the crossover using only capacitors, inductors and resistors. Active here refers to multiple power amplifiers.

One of the main design goals of the Massive Passive was to use only capacitors, inductors and resistors to change the tone. Pultecs do it this way too and many of our favorite vintage EQs also relied on inductors and caps. In fact, since op-amps became less expensive than inductors, virtually every EQ that came out since the mid '70s substituted ICs for inductors. One is a coil of copper wire around a magnetic core and the other is probably 20 or more transistors. Does the phrase "throwing out the baby with the bath water" ring a bell?

Another design goal was to avoid having the EQ in a negative feedback loop. Baxandall invented the common circuit that did this. It simplified potentiometer requirements, minimized the number of parts and was essentially convenient. Any EQ where "flat" is in the middle of the pot's range and turning the pot one way boosts and the other way cuts is a variation of the old Baxandall EQ. Pultecs are not this way. Flat is fully counter-clockwise. For the Massive Passive, Baxandall was not an option. The classical definition of "passive" has little to do with "feedback circuits" and we are stretching the definition a bit here, however, it certainly is more passive this way.

We only use amplification to boost the signal. Flat Gain ! What goes in is what comes out. If we didn't use any amplifiers, you would need to return the signal to a mic pre because the EQ circuit eats about 50 dB of gain. Luckily, you don't have to think about this.

We visited a few top studios and asked "what do you want from a new EQ?" They unanimously asked for "click switch frequencies", "character" rather than "clinical" and not another boring, modern sterile EQ. They had conventional EQs all over the console and wanted something different. They had a few choice gutsy EQs with "click frequencies" that were also inductor/capacitor based (which is why the frequencies were on a rotary switch). Requests like "powerful", "flexible", "unusual" and "dramatic" kept coming up.

We started with these goals: modern parametric-like operation, passive tone techniques through-out, and features different from anything currently available and, most importantly, it had to sound spectacular.

"The Super-Pultec"

Manley Labs has been building a few versions of the Pultec-style EQs for many years as well as an updated version of the EQ-500 (another vintage EQ). These are classic passive EQs combined with Manley's own gain make-up amplifiers. Engineers loved them but we often heard requests for a Manley Parametric EQ with all the modern features but done with tubes. Another request we had was for a "Super-Pultec". We briefly considered combining the "best of" Pultecs into a new product but the idea of some bands only boosting and some only cutting could only be justified in an authentic vintage re-creation and not a new EQ.

The next challenge was to make an EQ that sounded as good or better than a Pultec. With all the hundreds of EQs designed since the Pultec, none really beat them for sheer fatness. We knew why. Two reasons. EQP1-A's have separate knobs for boost and cut. People tend to use both at the same time. You might think that this would just cancel out - wrong.... You get what is known as the "Pultec Curve" . The deep lows are boosted, the slope towards "flat" becomes steeper, and a few dB of dip occurs in the low mids. The second reason for the fatness and warmth was the use of inductors and transformers that saturate nicely combined with vacuum tubes for preserving the headroom and signal integrity.

Could we use a "bandwidth control" to simulate the "Pultec Curve(s)"? The Pultec curve is officially a shelf and shelf EQs don't have a "bandwidth or Q knob"- only the bell curves. So, if we built a passive parametric where each band could switch to shelf or bell and used that "bandwidth" knob in the shelf modes we could not only simulate the Pultecs but add another parameter to the "Parametric EQ" We found that we could apply the "Pultec Curve" to the highs with equally impressive results. This is very new.

The Massive Passive differs from Pultecs in several important areas. Rather than copy any particular part of a Pultec, we designed the "Massivo" from the ground up. As mentioned, each band being able to boost or cut and switch from shelf to bell is quite different from Pultecs. This required a different topology than Pultecs which like most EQs utilize a "series" connection from band to band. The Massive Passive uses a "parallel" connection scheme.

A series connection would imply that for each band's 20 dB of boost, there is actually 20 dB (more in reality) of loss in the flat settings. Yeah, that adds up to over 80 dB, right there, and then there is significant losses involved if one intends to use the same components to cut and to boost. And more losses in the filter and "gain trim". That much loss would mean, that much gain, and to avoid noise there would need to be gain stages between each band and if done with tubes would end up being truly massive, hot and power hungry.

Instead, we used a parallel topology. Not only are the losses much more reasonable (50 dB total!) but we believe it sounds more "natural" and "musical". In many ways the Massive Passive is a very unusual EQ, from how it is built, to how it is to operate and most importantly how it sounds.

We designed these circuits using precise digital EQ simulations, SPICE3 for electronic simulations, and beta tested prototypes in major studios and mastering rooms for opinions from some of the best "ears" in the business.

"The Passive Parametric"

For years, we had been getting requests for a Manley parametric equalizer, but it looked daunting because every parametric we knew of used many op-amps and a "conventional parametric" would be very impractical to do with tubes. Not impossible, but it might take upwards of a dozen tubes per channel. A hybrid design using chips for cheapness and tubes for THD was almost opposite of how Manley Labs approaches professional audio gear and tube designs. Could we combine the best aspects of Pultecs, old console EQs and high end dedicated parametric EQs?

What is the definition of a "Parametric Equalizer"? We asked the man who invented the first Parametric Equalizer and coined the term. He shrugged his shoulders and indicated there really is no definition and it has become just a common description for all sorts of EQs. He presented a paper to the AES in 1971 when he was 19. His name is George Massenburg and still manufactures some of the best parametric EQs (GML) and still uses them daily for all of his major recordings. Maybe he originally meant "an EQ where one could adjust the level, frequency and Q independently". He probably also meant continuously variable controls (as was the fashion) but this was the first aspect to be "modified" when mastering engineers needed reset-ability and rotary switches. The next development was the variation of "Constant Bandwidth" as opposed to "Constant Q" in the original circuits. "Constant Q" implies the Q or bell shape stays the same at every setting of boost and cut. "Constant Bandwidth" implies the Q gets wider near flat and narrower as you boost or cut more. Pultecs and passive EQs were of the constant bandwidth type and most console EQs and digital EQs today are the constant bandwidth type because most of us prefer "musical" over "surgical". Lately we have seen the word "parametric" used for EQs without even a Q control.

We can call the Massive Passive a "passive parametric" but it differs from George's concepts in a significant way. And this is important to understand, to best use the Massive Passive. The dB and bandwidth knobs are not independent. We already noted that the Q of the bell curve widens when the dB control is closer to flat. More significantly, the boost or cut depth varies with the bandwidth control. At the narrowest bandwidths (clockwise) you can dial in 20 dB of boost or cut. At the widest bandwidths you can only boost or cut 6 dB (and only 2 dB in the two 22-1K bands). Somehow, this still sounds musical and natural. The reason seems to be, simply using basic parts in a natural way without forcing them to behave in some idealized conceptual framework.

Another important concept. When you use the shelf curves the frequencies on the panel may or may not correspond to other EQ's frequency markings. It seems there are accepted standards for filters and bell curves for specifying frequency, but not shelves. We use a common form of spec where the "freq" corresponds to the half-way dB point. So, if you have a shelf boost of 20 dB set at 100 Hz, then at 100, it is boosting 10 dB. The full 20 dB of boost is happening until below 30 Hz. Not only that, like every other shelf EQ there will be a few dB of boost as high as 500 Hz or 1K. This is all normal, except.....

Except we now have a working "bandwidth control" in shelf mode. With the bandwidth set fully counter-clockwise, these shelves approximate virtually ever other EQ's shelf (given that some use a different freq spec). As you turn the bandwidth control clockwise, everything changes and it breaks all the rules (and sounds awesome). Lets use an example. If graphs are more your style, refer to these as well. Suppose we use 4.7K on the third band by switching to "boost" and "shelf" and turning the "bandwidth control" fully counter-clockwise. Careful with levels from here on out. Just for fun, select 4.7kHz and turn the "dB" control to the max - fully clockwise. This should be like most other shelf EQs, except with better fidelity, (if you can set them to around 5kHz!). Now, slowly turn the "bandwidth" clockwise. Near 12:00 it should be getting "special". It also sounds higher (in freq). Keep turning. At fully clockwise it seems to have gotten a little higher and some of the sibilance is actually less than in "bypass". It sort of sounds as if the bandwidth is acting like a variable frequency control but better. More air - less harshness.

Compared to "conventional parametrics" in all their variations, the Massive Passive has just "upped the ante" by adding a few useful new parameters. The first is the use of the "bandwidth" in shelf modes. Second is the ability to switch each and every band into shelf. The original parametrics were only "bell". We have seen some EQs that allow the lowest and highest bands to switch to shelf. Now you can use two HF shelves to fine tune in new ways without chaining several boxes together. Lastly, each band can be bypassed or switched from boost to cut without losing a knob setting. This allows twice the resolution from the "dB" pots and allows one to exaggerate an offending note in order to nail the frequency easier, then simply switch to "cut". You can always check, without losing the dB setting by switching back to "boost" for a minute. You can also have absolute confidence that the "zero" position on the dB pot is "flat" which is not the case with center detented pots. Mechanical center and electrical center are rarely the same.

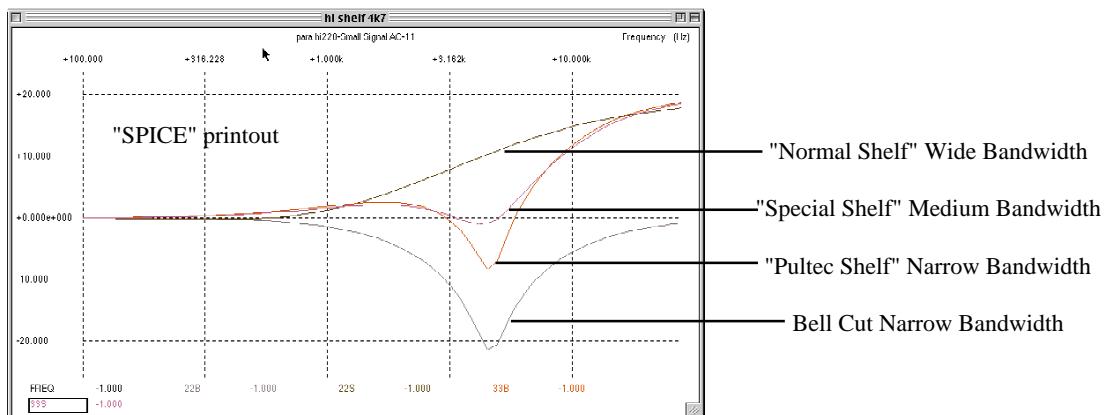

Why Passive?

If you hate tech talk, just skip this section - it has to do with electronic parts and circuits and design philosophy.

All EQs use capacitors. They are very easy to use, predictable, cheap and simple. Some sound slightly better than others. Inductors do almost the mirror function of capacitors. Unfortunately, they can be difficult to use (they can pick up hum), they can be difficult to predict (the essential inductance value usually depends on the power going through them which varies with audio), they are expensive and generally have to be custom made for EQs. These are qualities that lab-coat engineers tend to scowl at. Some effort was aimed at replacing the poor inductors and more effort made to bad-mouth them and justify these new circuits. The main reason was cost. All of the "classic" Eqs used real inductors and that has become the dividing line "sought after vintage" and just old.

What the lab-coats didn't consider was that inductors may have had real but subtle advantages. Is it only obvious to "purists" that a coil of copper wire may sound better than 2 or 3 op-amps, each with over twenty transistors, hundreds of dBs of negative feedback along with "hiss", cross-over distortion and hard harsh clipping?

We mentioned the inductance value can change with applied power. This also turns out to be a surprising advantage. For example, in the low shelf, with heavy boosts and loud low frequency signals, at some point, the inductor begins to saturate and loses inductance. Sort of a cross between an EQ and a low freq limiter. The trick is to design the inductor to saturate at the right point and in the right way.

In the mid-bands and bell curves a somewhat different effect happens. The center-frequency shifts slightly depending on both the waveform and signal envelope. This "sound" is the easily recognizeable signature of vintage EQs. It is not a type of harmonic distortion (though it can be mistaken for this on a test-bench) but more of a slight modulation effect.

Inductors in the form of transformers are also a large part of why vintage gear is often described as "warm" whether it was built with tubes or transistors. In fact, the quality of the transformer has always been directly related to whether a piece of audio gear has become sought after. Saturation in this case involves adding odd harmonics to very low frequencies which either tends to make lows audible in small speakers or makes the bass sound louder and richer (while still measuring "flat"). The key is how much. A little seems to be sometimes desirable (not always) and a little more is beginning to be muddy and a little more can best be described as "blat". The number of audio transformer experts has fallen to a mere hand full and some of them are getting very old.

And Why Parallel?

The Massive Passive is a "parallel design" as opposed to the far more common "series design". A few pages back, we mentioned the main reason for going with a parallel design was to avoid extreme signal loss, which would require extreme gains and present the problem of noise or extreme cost. The parallel approach not only avoided this but has a number of advantages as well.

With the series EQ design, if you set 3 bands to boost the same frequency 15 dB each, the total boost will be band one plus two plus three - or 45 dB - but then it would probably be distorting in a rather ugly way. With the Massive Passive, you can dial in 4 bands to boost 20 dB near 1K and it still will only boost 20 dB total. If you tend to boost 4 bands at widely separated frequencies (like what happens on two day mixes with sneaky producers), it tends sound almost flat, but louder. Other EQs seem to sound worse and worse as you boost more and more. For some people it will act as a "safety feature" and prevent them from goofy EQ. Occasionally, you may be surprised with what looks like radical settings and how close to flat it sounds. A side effect is that if you are already boosting a lot of highs in one band, if you attempt to use another band to tweak it, the second band will seem rather ineffective. You may have to back off on that first band to get the desired tone. You actually have to work at making the Massive Passive sound like heavy-handed EQ by using a balanced combination of boosts and cuts. In a sense it pushes you towards how the killer engineers always suggest to use EQs (ie gentle, not much, more cut than boost). This is good.

While there may be interesting arguments against any interaction between EQ bands, the reasons tend to be more for purely technical biases than based on listening. In nature and acoustics and instrument design, very little of the factors that affect tone are isolated from each other. Consider how a guitar's string vibrates the bridge which vibrates the sound board, resonates in the body, and in turn vibrates the bridge and returns to the string. What is isolated? The fact that the bands are NOT isolated from each other in the Massive is one of the reasons it does tend to sound more natural and less electronic. We noticed this effect in a few passive graphic EQs, notably the "560" and a cut-only 1/3 octave EQ.

There is a type of interaction we did avoid. That is inductor to inductor coupling. It is caused by the magnetic field created by one inductor to be picked up by another. It can cause the inductors to become an unexpected value, or if it is band to band, can cause effects that can best be described as goofy. In the Filter Section we utilized close inductor spacing to get some hum-bucking action but avoid magnetic coupling with careful positioning. Some kinds of interaction suck and some are beneficial.

Phase Shift?

Deadly topic. This is probably the most misunderstood term floating about in the mixing community. Lots of people blame or name phase shift for just about any audio problem that doesn't sound like typical distortion. We ask that you try to approach this subject with an open mind and forget what you may have heard about phase for now. This is not to be confused with "time alignment" as used in speakers, or the "phase" buttons on the console and multi-mic problems.

First - all analog EQs have phase shift and that the amount is directly related to the "shape" of the EQ curve. Most digital EQs too. In fact, one could have 3 analog EQs, 3 digital EQs, and an "acoustic equivalent", and a passive EQ, each with the same EQ shape, and ALL will have the same phase shift characteristics. This is a law, a fact and not really a problem. The two exceptions are: digital EQs with additional algorithms designed to "restore" the phase, and a rare family of digital EQs called FIR filters based on FFT techniques.

Second - Opinions abound that an EQ's phase shift should fall within certain simple parameters particularly by engineers who have designed unpopular EQs. The Massive Passive has more phase shift than most in the filters and shelves and leans towards less in the bells. Does this correspond to an inferior EQ? Judge for yourself.

Third - Many people use the word "phase shift" to describe a nasty quality that some old EQs have and also blame inductors for this. It's not phase shift. Some inductor based EQs use inductors that are too small, tend to saturate way too easily, and create an unpleasant distortion. The Massivo (of course) uses massive inductors (compared to the typical type) which were chosen through listening tests. In fact we use several different sizes in different parts of the circuit based on experiments as to which size combined the right electrical characteristics and "sounded best". The other very audible quality people confuse with phase shift is "ringing". Ringing is just a few steps under oscillating and is mostly related to narrow Qs. It is more accurately described as a time based problem than phase shift and is far easier to hear than phase shift. For our purposes, in this circuit, these inductors have no more phase shift or ringing than a capacitor.

Fourth - A given EQ "shape" should have a given phase shift, group delay and impulse response. There also exist easy circuits that produce phase shift without a significant change in frequency response. These are generally called "all-pass networks" and are usually difficult to hear by themselves. You may have experienced a worse case scenario if you have ever listened to a "phase-shifter" with the "blend" set to 100% (so that none of the source was mixed in) and the modulation to zero. Sounded un-effected, didn't it, and that may have been over 1000 degrees of phase shift. Group delay and impulse response describe the signal in time rather than frequency and are just different ways of describing phase shift. Some research shows these effects are audible and some not. The Massive Passive tends to show that group delay in the mids is more audible than towards the edges of the spectrum and there may be interesting exceptions to generalities and conventional wisdoms. The audible differences between EQs seems to have more to do with Q, distortions, headroom and topology than with phase shift.

Fifth - Phase Shift is not as important as functionality. For example, we chose very steep slopes for some of the filters because we strongly believe the "job" of a filter is to remove garbage while minimally affecting the desired signal. A gentler slope would have brought less phase shift but would not have removed as much crap.

Why Tube Gain Stages?

The stupid answer is the name on the unit is "Manley Labs" and that is what we do. Unlike a current trend, we do not use tubes for THD, clipping character, cool marketing buzz-words, or plagiarism. We began building tube gear because we preferred the sound when it was un-fashionable and re-introduced these glowing gain bottles to both the hi-fi and studio communities when there was virtually no fresh tube designs available. We also stress that, it's not just the tubes, but the way they are used. The sound of a piece of gear is due to many design details and many of the components - always has.

In the Massive Passive, the tube gain stages are new designs developed for this unit. We try to use minimalist techniques where ever possible and use the appropriate technology for the purpose. Simple vacuum tube circuits can excel for medium gain voltage amplifiers and high headroom output stages. A simple tube stage offers better linearity than an equally simple transistor circuit. Transistors have a logarithmic transfer curve and are essentially current devices. Transistor circuits are typically built with huge excess gain which is used for more feedback in order to tame the linearity (THD) but this feedback seems to cause audible transient problems and is directly responsible for the harsh clipping character. Op-amps, which can be less noisy and lower THD, are complex circuits which force music through many transistors and may also bring crossover distortion artifacts and headroom issues into play. The only alternative would have been for the Massivo to use FET / MOSFET high voltage discrete circuits. Someday, we may introduce a version like this but don't phone us up every month asking if we are working on it. We'll let you know.

We use an exceptional op-amp/discrete circuit for the input buffer in order to drive the 150 ohm (worst case) EQ circuit. Not an appropriate place for tubes. The first design used a transformer (3:1) for impedance conversion but it had a 10 dB voltage drop and thus 10 dB more noise. The new input circuit isolates input loading and allows the tube circuits to be better optimised. We use two similar all-tube gain stages per channel for interstage and output line drivers which together cancels some distortion. The output is capable of driving up to +37 dBu! This stage also uses a separate winding on the output transformer (also custom designed) for a little negative feedback to allow lower output impedances and minimal transformer coloration. In other words, because we expect some engineers wanting to boost 20 dB at 100 Hz occasionally, the circuits had to be capable of cleanly delivering it (regardless if the next piece in the chain can deal with it). We used tubes for more headroom (300 volt power supply) rather than more clipping. Generally too, tube circuits clip a little smoother than mega-negative feedback IC circuits.

Some may question "tube reliability" but most major studios have many 30 or 40 year old tube compressors and EQs running every day and some with the original tubes. Not many 15 or 20 year old transistor units are still working or wanted. Tubes will eventually burn out (so do transistors), however, usually you can easily get the type of tube used 30 years ago and you won't need a soldering iron, schematic or technician. Your parents probably used to "fix" the old TV. The bottom line is, good gear tends to be more reliable, and if a problem develops, is both easy to fix, and carries great factory support. We understand that it sometimes involves your professional livelihood and this is indeed often serious and you depend on it. If this is the case, consider getting a few spare tubes which covers 90%+ of emergencies with immediate fixes. Our service department has a great reputation with phone support and fast turn-arounds too.

LOW SHELF CURVES

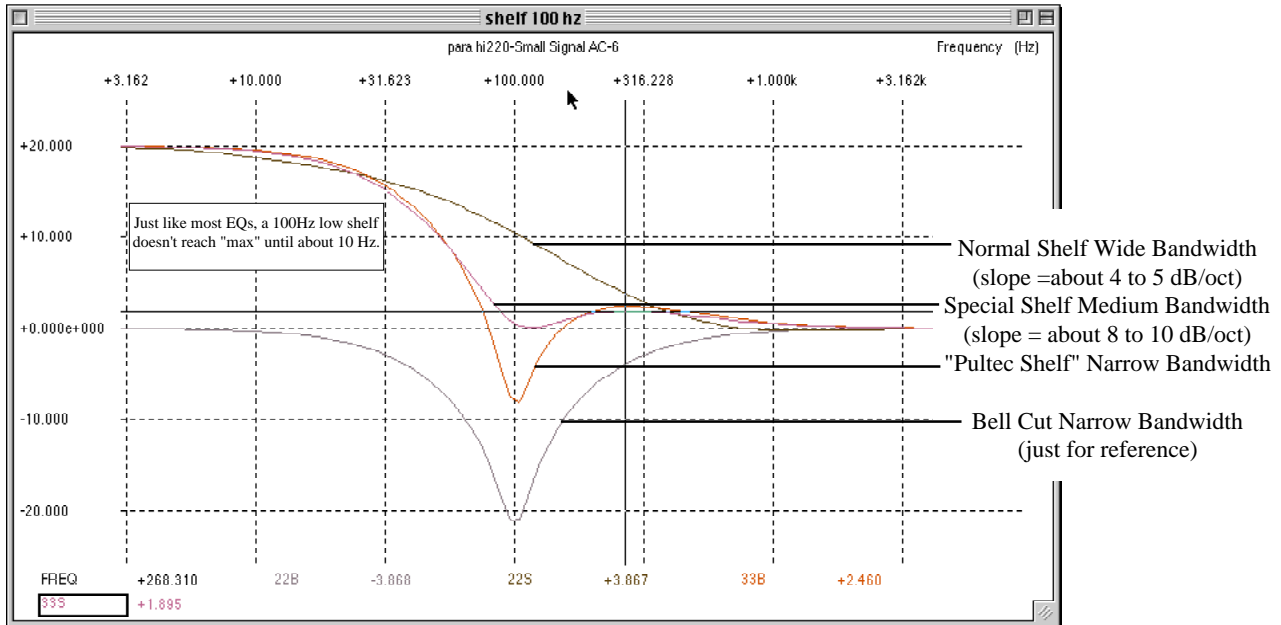

22Hz and 33Hz are different shelves when the Bandwidth is Narrow
The top graph is for the other 20 Low shelves

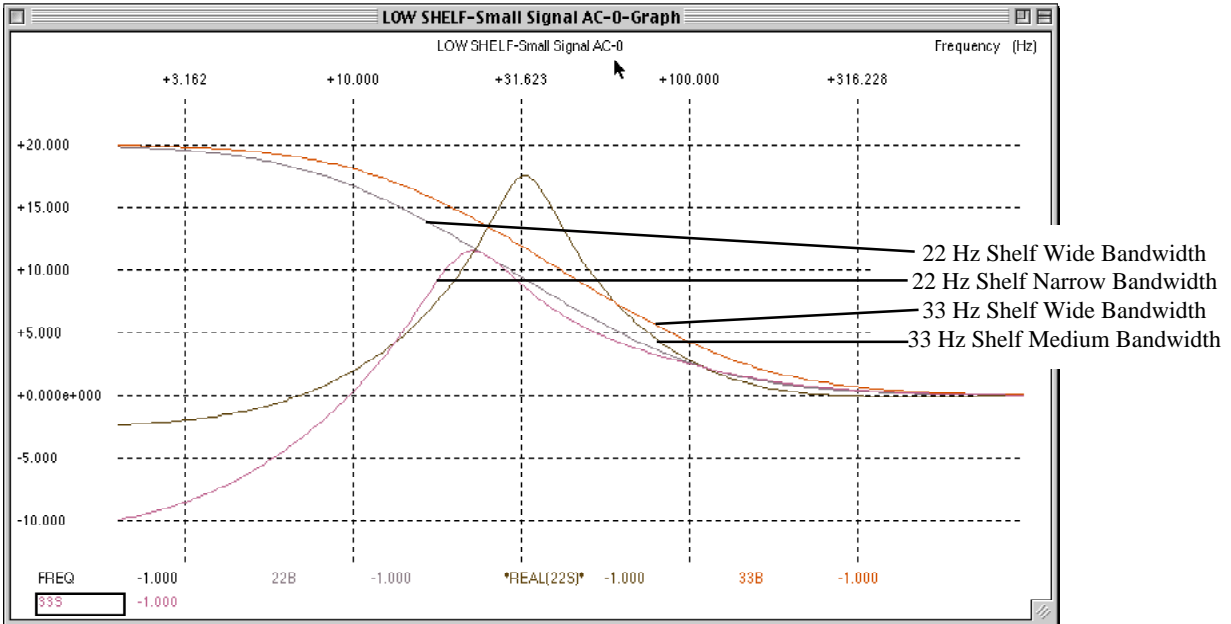

MORE 100Hz SHELVES SHOWING BOOST AND CUT WITH VARIOUS BANDWIDTHS

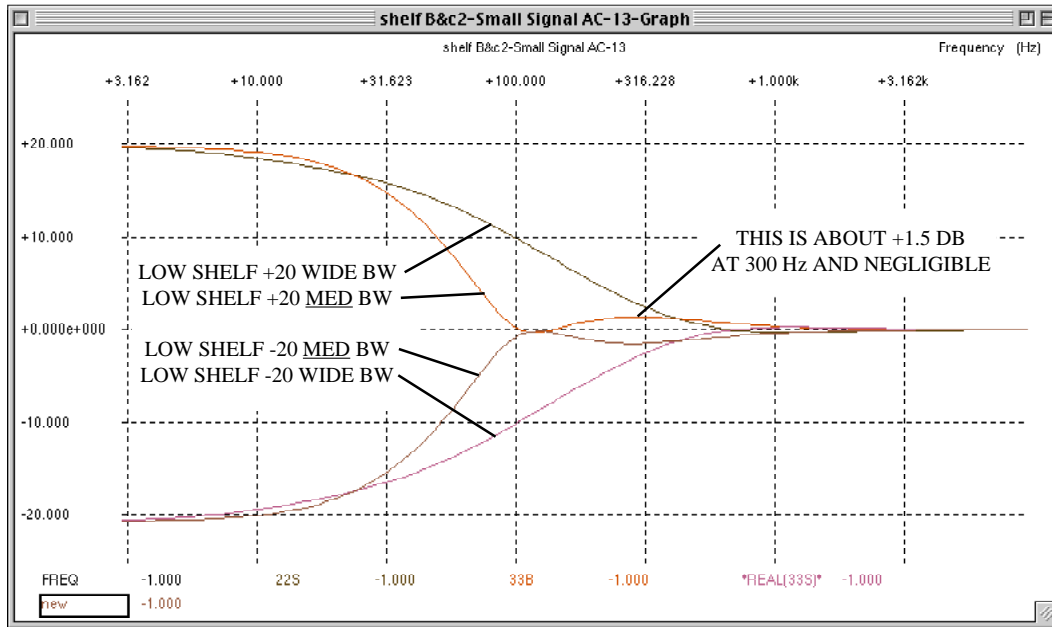

SPICE SIMULATION CURVES

THESE CURVES SHOW ONE OF THE IDEOSYNCRACIES
AND IT IS POSSIBLE FOR A LF BOOST TO SOUND AS IF IT HAS LESS LOWS
DEPENDING ON THE FREQUENCY AND INSTRUMENT.
SIMILAR CURVES APPLY TO THE HIGH SHELVES AND
PARTICULARLY 10K AND 12K CAN BE STRANGE WHEN THE BW IS NARROW

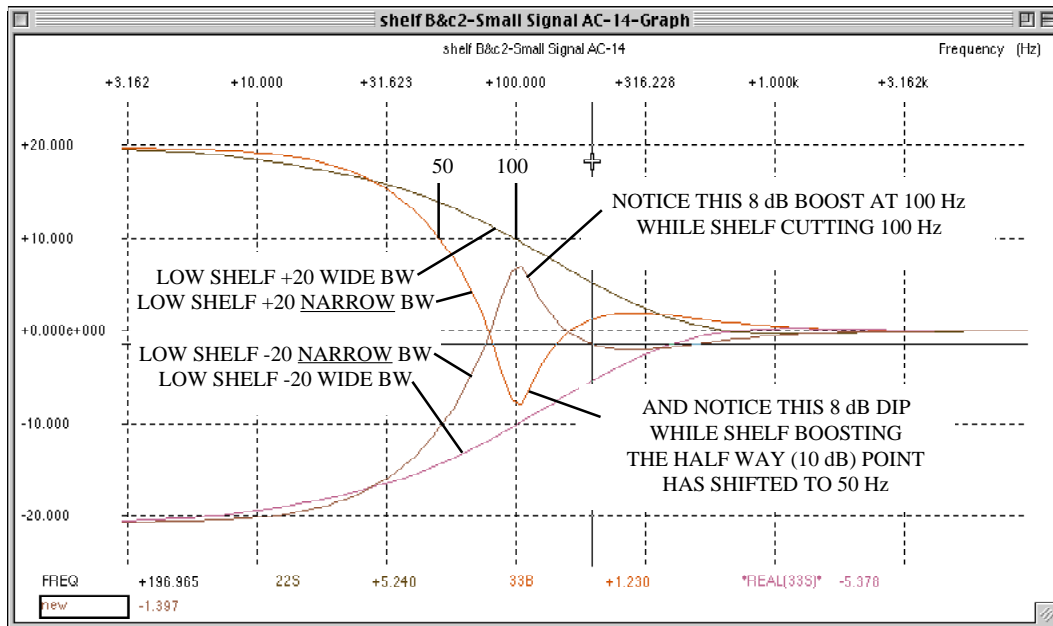

TYPICAL BELL CURVES

"dB" set at max (20 dB) and changing the Bandwidth

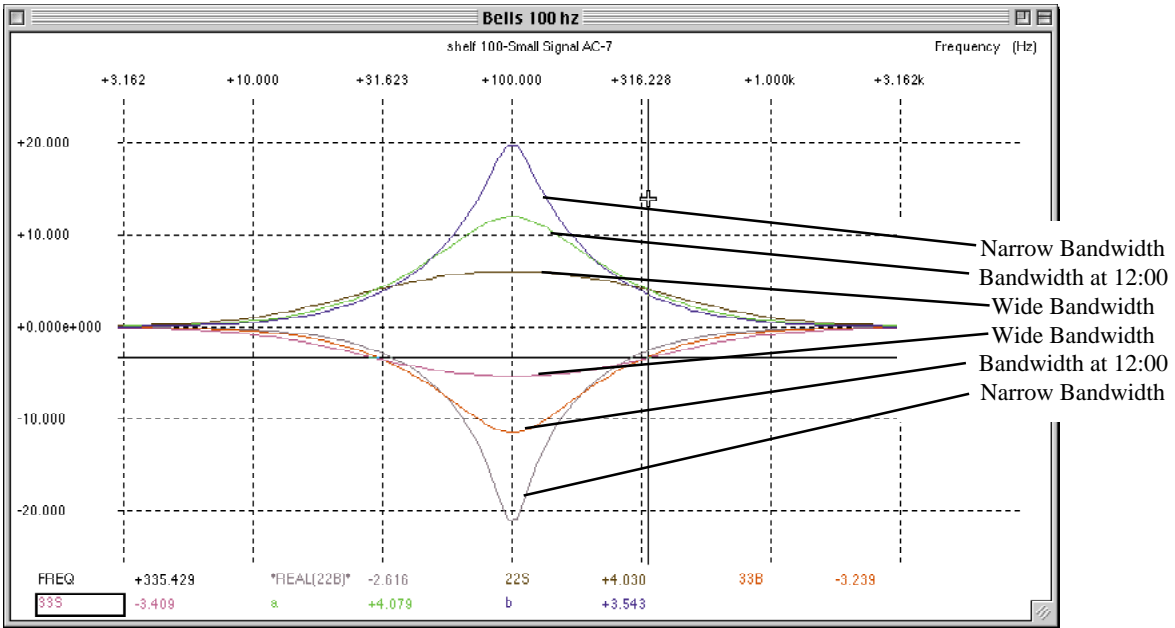

Changing "dB" and Changing Bandwidth

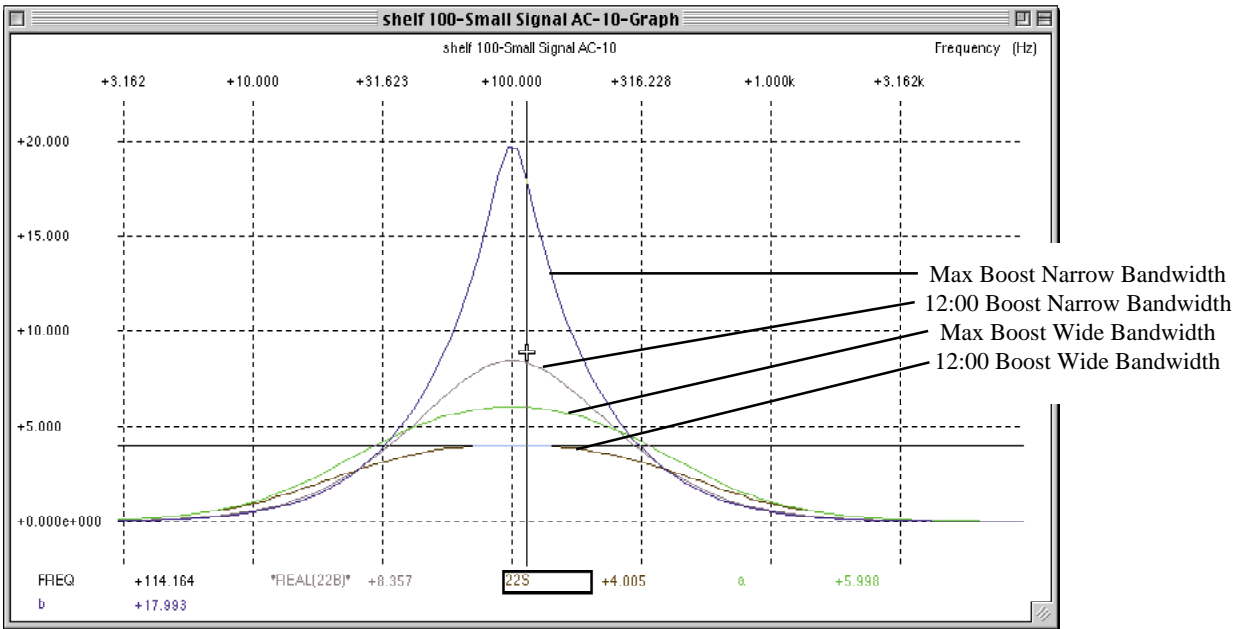

LOW PASS FILTERS

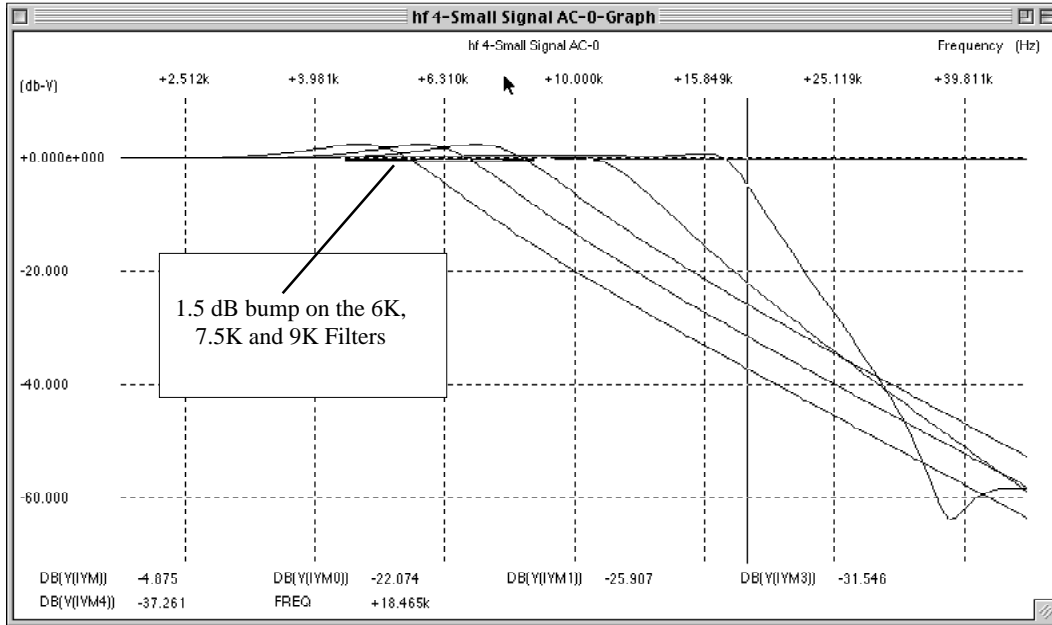

HIGH PASS FILTERS

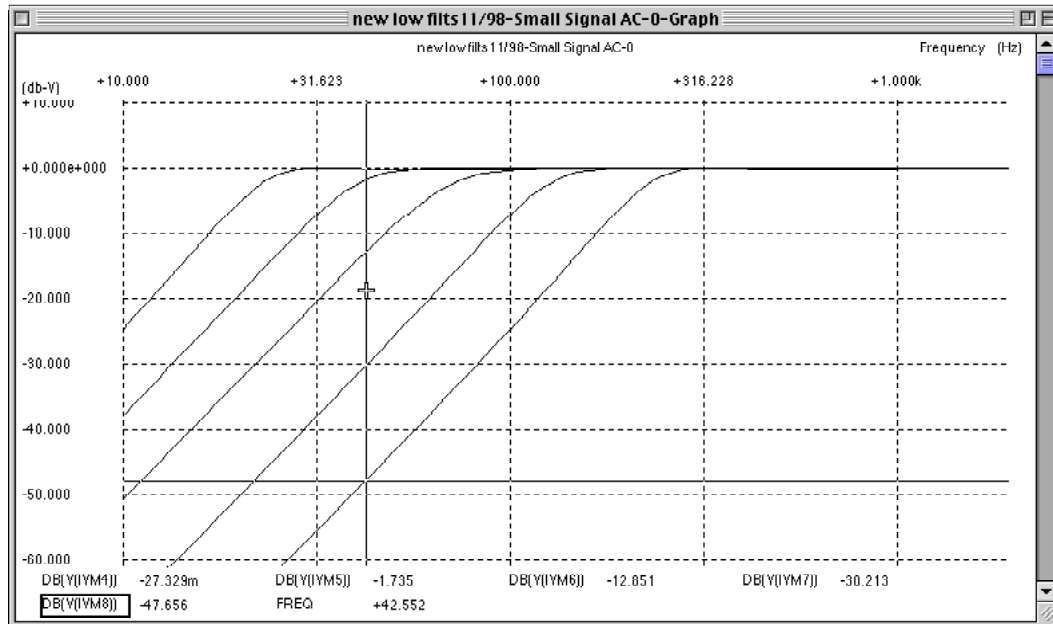

THE GUTS

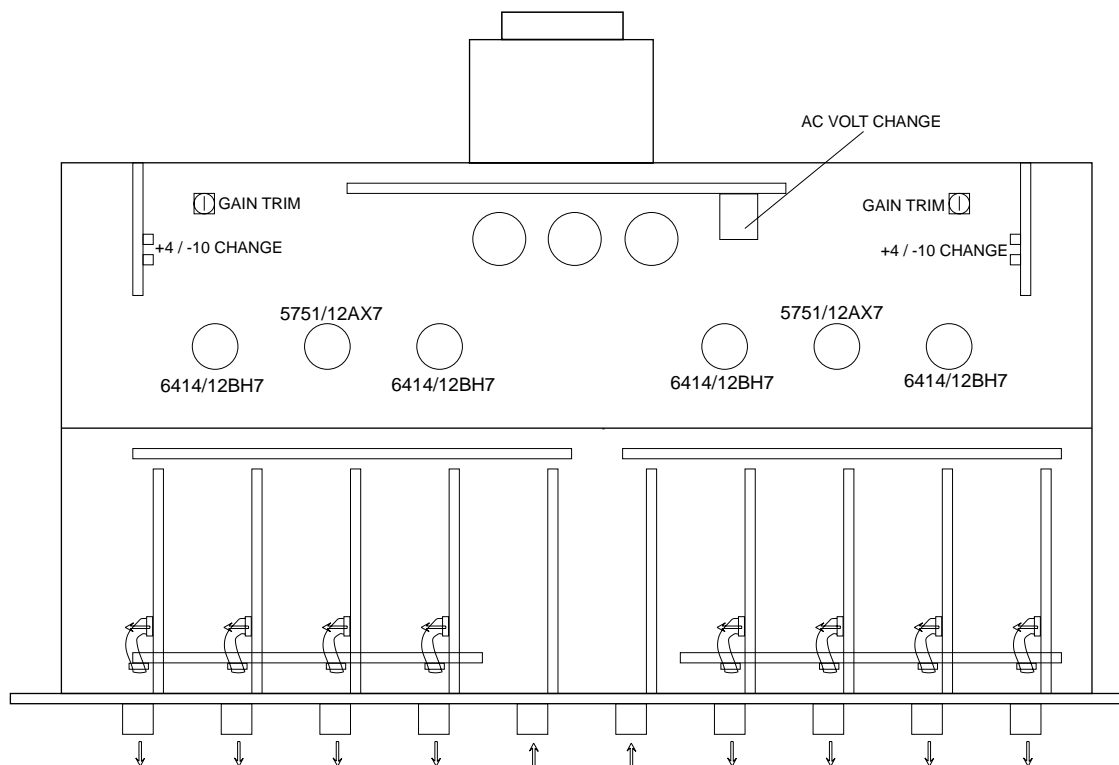

1) **To Open:** Disconnect the AC Power cable, let sit 15 minutes to allow the power supply capacitors to discharge. Remember there are high voltages (300VDC) used in the Massive Passive and that the capacitors may continue to hold a charge after power is removed - **BE CAREFUL!** We suggest using gloves and/or "one hand only" when the top is off. Remove the single Philips Machine screw located on the top perforated panel (towards the back and center). Slide the perforated panel towards the back.

2) **Replacing Tubes:** The tubes are marked as to their type 5751/12AX7 (for voltage gain) and 6414/12BH7 (for line drivers). Another warning: Tubes get HOT. Let them cool before you attempt to touch them. Wiggle the tube back and forth as you pull it up. If you suspect a tube, you can swap it with the other channel. If the problem follows the tube, you were right, it is that tube. If not, try swapping another pair of tubes. It is a good idea to have a few spare tubes for emergencies as this will fix better than 90% of most problems.

3) **Changing AC MAINS VOLTAGE:** Disconnect the AC Power cable. See on the diagram above the "AC VOLT CHANGE". Use a small flat screwdriver set voltage change over switch to 120VAC or 240VAC operation. Replace main Fuse with correct type and value. For fuse information refer to Pg. 29..

4) **Changing the 1/4" phone jacks for -10dBv levels:** The Massive Passive is factory wired for professional +4dBu levels for both all of the XLR and 1/4" phone jacks. This procedure only changes the 1/4" jacks - not the XLRs. Do not assume that "balanced" implies +4dBu levels or that "unbalanced" implies -10dBv consumer levels. Balanced only means that there are 3 wires in the cable and that 2 of these wires carry signal in opposite phases and that the same impedances (source especially) exist. Unbalanced refers to a cable system with two wires (signal and ground). "+4dBu" refers to professional signal levels (0VU=1.228 volts AC into 600 ohms). "-10dBv" refers to consumer signal levels common to hi-fi and low budget semi-pro gear and is typically 14 db lower than pro levels. The common connector is the RCA style phono jack. 1/4" jacks are used for a wide variety of signal types and levels, including +4, -10, instrument Hi-Z and speakers and headphones. 3 conductor plugs are used for balanced signals, inserts (send and return) and stereo (L&R) which tend to be incompatible. Simply plugging in a 1/4" to 1/4" cable from one piece of gear to the next is not guaranteed to work. You may have to check the operators manuals if you run into problems.

See the diagram above for the DIP SWITCH locations and the next page for a closer look.

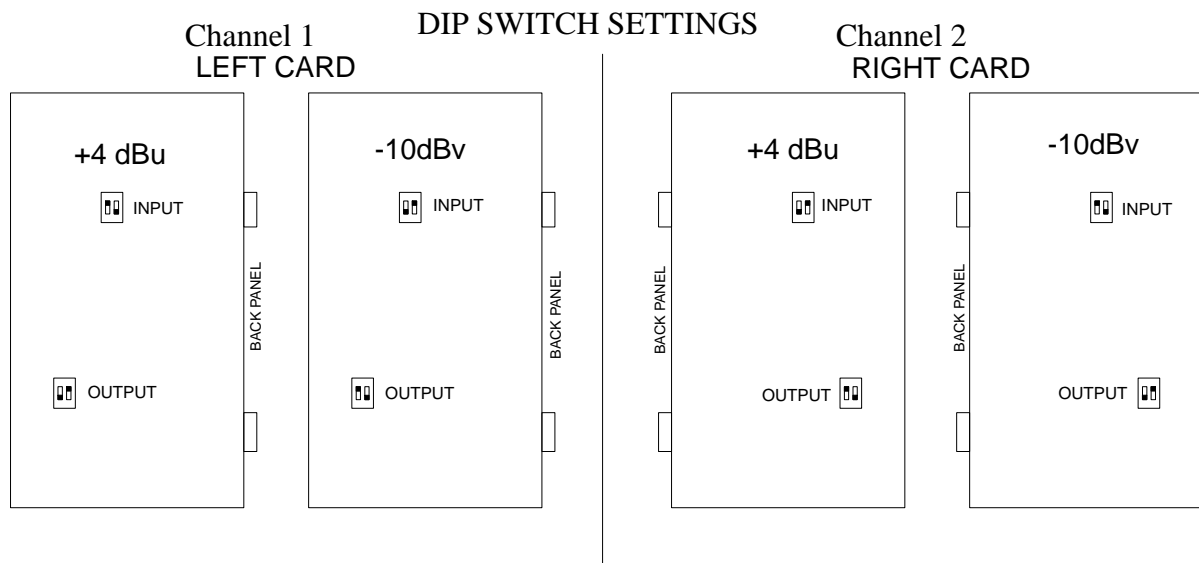

This procedure also results in a polarity reverse which means that the 1/4" outputs will reverse phase both in bypass and EQ. This may not be a problem but you should be aware of this. It is definitely better to keep PC or "polarity correct" in general. If it is a problem, you may be able to correct the polarity simply by hitting the "phase button" on the corresponding channels on the console or re-wiring the input plug so that signal is on the ring and the tip and sleeve are grounded via the shield. This procedure does not affect the XLR levels or polarity. Sorry, but all previous Manley Pro Gear is only designed for +4dBu levels and this is the first accommodation we have made for -10dBv. We really only did it this time because it was easy in this circuit (it was an after-thought) and not intended in the basic design. We suggest using the XLRs first, the 1/4" at +4 levels second and only doing this procedure for -10 levels, if you really must.

Here are the **DIP SWITCHES**. There are two switches on each little package or pair and two packages or pairs on each card and two cards (channel one and channel two). The two switches should always be opposite - one ON and one OFF. UP is ON. When (TOP PAIRS) the switches closest to the front panel are UP and ON and (BOTTOM PAIRS) the switches closest to the front panel are DOWN and OFF the 1/4" jacks are set up for +4 dBu levels. When (TOP PAIRS) the switches closest to the front panel are DOWN and OFF and (BOTTOM PAIRS) the switches closest to the front panel are UP and ON the 1/4" jacks are set up for -10dBv levels. The latter increases the input gain and decreases the output level. The pair of switches closest to the top of the card set the input gain and the pair closest to the bottom set the output levels. On these output switches, if both are OFF then you lose output to the 1/4" jack. If both are ON important parts of the circuit will be shorted together and the unit will oscillate.

5) **Removing individual EQ cards:** You have to remove the top perforated panel first. Each card has a short ribbon cable from the toggle switch board to the EQ card. You have to pull the ribbon connector from the EQ card before you pull out the card. Once the ribbon is free at the EQ card end, unscrew the two allen keys holding the oblong black anodized panel. Gently pull the card towards you, being sure the ribbon cable is not catching on any of the EQ card components. To return an EQ card into its slot, do the procedure in reverse. The only difference is that you need to watch the back of the card and align the 14 pins into the connector and not offset.

Considering there are no active components on these EQ cards it is unlikely they will need to be repaired or removed. There are a few minor differences between the 4 EQ cards and you should not change the order. These differences involve the "voicing" to the 22Hz, 33Hz, 16K and 27K shelves. There is a possibility (plan) for Manley to introduce optional cards for the Massive Passive at some point in the future. We have discussed, "Mastering stepped cards", "Active Constant Q cards", "Clipper Cards", "Notch Filter cards" and others. Due to the enormous interest in the "Mastering stepped cards" and they will be the first to be done, however, remember that it is not possible in this design to really have constant 1dB or 1/2dB steps because the step size is always "scaled" to the bandwidth. If we use an 11 position switch set up for 1/2 dB steps at the narrowest bandwidth, it results in only +/- 5.5 dB of available range and becomes less than +/- 1.5 dB at wide bandwidths. On the other hand, this is how all of the "Mastering Pultecs" we have built, also work. Over half of the mastering engineers have decided to use the regular un-stepped version of the Massive Passive. The "Gain" pots seem to have reasonable resolution and repeatability (twice what a conventional EQ does) and resetting is relatively easy. While step switches make a lot of sense in some EQs, there may be less need in the Massive Passive and there are definite advantages of having the wide range of control especially considering that the Massive tends to not be as intrusive and "electronic colored" that we associate with EQing in general. These options, of course, will not be free, and some options may need to be ordered at prior to the unit being assembled. We suggest evaluating a stock unit before assuming that you need certain options.

The Massive Passive has been planned as an "EQ platform" that should accommodate special functions for a variety of professional needs. There is no time-table planned for these cards and we will first announce them, as usual, on our website <www.manleylabs.com>.

Equalizers

EQs range from simple bass and treble controls on a hifi system to pretty tricky parametric EQs and 1/3 octave graphic EQs. As an audio freak, you have probably tried quite a few EQs and have gotten both great results and sometimes less than great and you probably have a favorite EQ. Now that you probably have a digital system, you may have questions about these digital EQs and the differences between any analog and digital techniques. Let us begin at the beginning, and then get into some real techniques. Who invented the first electronic tone control? Who knows? The first hints of "flat" electronics came decades later. Simple bell and shelf EQs seem to have been born in the 1930's for telephone company use. The Pultec passive circuits came from that era at Western Electric. "Graphic EQs" seem to have been invented in the mid 60's and were common by the early 70's. A 19 year old prodigy, George Massenburg first described, in a 1971 AES paper, the "Parametric Equalizer".

All EQs do one thing — they can make some bands or areas of frequencies louder or quieter than others, manipulating the frequency response. Speakers and mics do that to but we normally think of EQs as something that allow us to alter the frequency response, deliberately, with some knobs and buttons - including the GUI ones. Some equalizers have no controls, they are part of a circuit and generally are almost "invisible" to the user. A good example of this is the EQ circuits used as "pre-emphasis" and "de-emphasis" used for analog tape machines and radio broadcasting. The idea of these is to boost the high frequencies before it hits the tape (or air), then reduce the highs on playback (or reception). This reduces the hiss and noise and usually allows a hotter signal which also improves the noise performance. These EQs usually have trimmers available but we would rarely consider using them for adjusting the tone. Instead, the object is to get a ruler-flat response at this part of the signal chain. It is still called an equalizer. In fact the original definition of "equalizer" was a device to restore all the frequencies to be equal again, in other words, force the frequency response to be as flat as possible.

Other common EQs that you are probably familiar with include the common 1/3 octave graphic EQs with about 30 or 60 cheap sliders across the front panel. These are usually a good tool for tuning a room, but they may be a difficult thing to use for individual sounds. Most 1/3 oct EQs excel when a number of little tweaks spaced across the spectrum are needed but not great for wide tonal changes. Too many resonances. Some room tune experts are now relying on parametrics with continuously variable frequency knobs apparently to "nail" the peaks. One reason 1/3 octave EQs have a bad name are the "real time analyzers" that display a single aspect of the frequency response but without any time information, real or otherwise. People often get much better results with warble tones, or tuning rooms by ear with music. 1/3 octave EQs are appropriate for some mastering tasks but are probably less used because they tend to scare clients. The Massive Passive was not intended for room tuning. Perhaps a future version with active constant Q mid bands in combination with a good 1/3 octave EQ may be a very nice thing for that tricky job.

Parametric EQs come in lots of flavours, 3, 4 or 5 bands, most with 3 knobs per band and lots of variations. The earliest ones offered only bell shapes, no shelves, no filters. Today's most common variation has 2 mid bells with Q, a high shelf, low shelf and filters. We see these in many consoles and in outboard EQs at a wide range of prices. Almost all have limitations either in boost/cut range, Q range, frequency range or overlap and audio performance.

Now we have a new breed of digital parametrics that have few limitations - other than does it actually sound good and is it available for your format and is it stable and bug-free and is it a hassle to get a signal in and out of it? Within their realm, some are getting good.

Passive EQs have come out over the the 60 (150) odd years for a variety of different purposes. If we include all inductor/capacitor based EQs the list includes API 560's, most of Rupert's designs up to the 80's, all the Pultecs and Pultec clones and a number of high end 1/3 octave graphics. Essentially the list includes most of the desirable vintage EQs that comprise many engineer's all-time favorites. The Massive Passive is one of the only non-clone tube passive EQs and the only one we know of that is 4 band quasi-parametric with boost and cut on each band. There ain't nothin' like it.

Now there are a large number of enhancers, excitors, extenders and multi-band compressors, that usually use combination of EQ, distortion, dynamic effects and deliberate phase shift to create effects that are related to EQ. They all seem to come with a warning "not to overuse". The more "secretive" it is the more we should hold it suspect. Some of these are boxes are useful and often a reasonable alternative to conventional EQs. Sometimes, we think "if my EQs and Limiters did what I wanted, then I sure wouldn't use this". We hope that the Massive helps towards this quest. If you like what the magic boxes do, use them, but carefully because the results are rarely reversible.

What most EQ's have in common is in the shapes of the shelves. Almost all shelves can be designated as "first order" which means that a single capacitor (or inductor) is used to shape the frequency response. Second order implies two components, etc. A first order filter is generally 6 dB/oct, second order should be 12 dB/oct, third order 18, etc. Shelf EQs never quite get to 6 dB/oct and at the steepest point seem to be 4.5 dB/oct which is pretty gentle and why a 10K boost seems to affect mids. Bell curves are normally second order but arranged to create a damped resonance. On a first order shelf, the capacitor may be surrounded by any number of components to create gain or to simulate an inductor or for other purposes. These other components are a large reason why different EQs sound different, but that single capacitor sets up a frequency response curve that is very similar for almost all EQs. The shelves on the Massive Passive combine a first order shelf with a variable depth second order bell. At wide bandwidths it acts first order and at narrow bandwidths approaches third order. We have played with true second and third order shelves with real 12 and 18 dB/oct slopes and they sound pretty damn good. When you boost or cut a band of frequencies, with a steeper slope, you affect the frequencies that you are aiming for, with much less action on other frequencies that you didn't intend to touch. Of course, to build an EQ like this with frequency selection (even more need) the component cost and complexity rises fast.

The future of EQs may bring us bells where each side (high & low) plus the top "flatness" can be adjusted separately. We are beginning to see variations of shelves in plug-ins but so far it is just Tom copying Dick who mimicked an analog circuit by Harry. Perhaps another parameter would be nice like, a separately adjustable phase shift or distortion. And if we could bend the rules of nature and have a non-resonant bell with zero ringing, we might have something truly new to hear. It would be very transparent but probably quite unnatural sounding. There is validity to "physical modelling" even in analog EQ circuits. "Natural" is kinda nice and *very easy* to listen to.

EQ TECHNIQUE

One of the best things about almost all EQs is that you don't really need an instruction manual. You plug it in, turn a few knobs and when nothing happens you take it out of "bypass" and the rest is easy. You just keep twiddling until it sounds like you want it to. Most digital devices like synthesizers and reverbs tend to get a lot of use from the included presets. Most guys just don't want to get into that kind of "programming". EQs are the opposite where most guys will ignore the presets and start from scratch or flat. This section may be most helpful for the musician non-engineers, and may be applicable to EQs in and music engineering in general. There are no real rules here, just hints, suggestions and bits of other peoples wisdom.

Not so long ago, in order to get your chance at the console, you had to follow the path from cleaning toilets, to making coffee, to assisting, to engineering to producing. It cost years of micro-paychecks and humble pie. Not so anymore. If you want your turn at the console, you buy a console or be the main employee at a private studio. There were some benefits of watching the old pro's make the gear sound great and being able to ask how and why. What we hope to do here is be a small substitute for those who didn't get that opportunity. Specific settings for EQs are different for different situations. Some of these examples drift a bit from just EQing but we include them for reference and to make EQing less of a fixer.

Live Sound: In this author's experience, live sound usually required the most drastic and heavy handed EQ. Every factor contributes to this: Not the greatest mics, lots of leakage, feedback, strange sounding stages and rooms, questionable house speakers. No luxuries like mic positioning, just a quick sound-check (sometimes) and the doors open. Tapes from live shows are almost as tough. If you are accustomed to studio recording and clean tracks, you may need to adjust your techniques in a hurry. Sometimes, you get these wonderful clean tapes with a lot of energy. These tapes should be easy. Other tapes can be pretty messy. Some of your usual studio tricks are not working this time. With these tapes, you just might try taking the "house mixer" approach. Pull down the effects, there's too much leakage, and dig in with those EQs. It might help to start out with a good "fader only" mix and avoid using those "solo" buttons until you get the EQ roughed out. Gates may help, but may be audible and disconcerting if the leakage is gruesome. You might have to write mutes early and avoid too much compression. EQing the vocals may cause a lot of leakage problems if you boost lows or highs significantly. If you get a raw tape with virtually no EQ or compression when it was recorded you may need to use "unusual" and more EQ on many of the tracks. Usually, the best approach is to try to smooth it out but not kick it into submission, but remember, this is raw and may need more help than studio tracks.

Tracking the band: (in the studio) A bunch of musicians, a bunch of mics, and typically not a bunch of budget. Well, at least you have some good mics. By far, the best way to EQ at this stage is to use those good mics to your advantage. With the right mic and the right position, very little console EQ is needed. Use the rooms appropriate to the instrument and use separation to control unwanted spillage, get the instruments physically sounding awesome (we wish), then use the mics to create a natural picture with real room ambiance. The better the mic technique, the less EQ that will be needed. In fact, with less fix-it EQ, the easier it will be to finesse your available EQ. Hit "Record", finesse it in the mix. More important to get the vibe, than to burn out the band doing sound checks and tweaks.

If mic choice is a mystery, you might want to research some Steve Albini or George Massenburg interviews. Rather than guess wrong, some engineers compare 3 or 4 probable choices. Some choose the mic that minimizes EQing later, some hear the mic's transient or dynamic character and anticipate what some EQ should add in a nice way. Some guys have been there, done that, and know exactly what they like and don't, (but always seem to be ready to learn more) and bring in their own mics to get thier trademark sound.

The closer you have the mic to some instruments, the more likely EQ will be needed and less likely you will get both some great leakage and some not-so-good leakage. Close miking is better when you intend to sculpt the sound. Distant miking is better for documenting (recording) the music. On vocals and room mics, many use big diaphragm condenser tube mics where you want smoothness and richness. Some tube mics may add a bit of "attitude" and aggressiveness and some are very "real" sounding. The biggest differences in this family of mics is the two lowest and highest octaves and what the back of the mic sounds like. Small diaphragm condensers can be fast, bright, clear but sometimes brittle, hard or thin. Some are quite good for acoustic instruments, cymbals and hi-hats. Watch out, there is a wide variation in maximum SPL and noise with these. Of course most engineers favor large diaphragm condensers and typically use FET types on drums and guitars. The pattern choice is an important tool. Remember that the proximity effect (low boosting) is biggest in "figure 8", moderate in "cardioid" and non-existent in "omni". It is worth listening to both the "room tone" and instrument in the 3 main patterns - it's often surprising. The low roll-off (HP) should be used where ultra-lows are not needed or wanted and the filter kills some of the room noise and air conditioning rumble. Dynamic mics are more commonly used close for guitar amps, drums and sometimes horns. Ribbon mics have their resonance in the deep lows and typically have a softish top end. They seem to have a more "ear-like" dynamic range. This makes them a superb choice for raunchy guitar amps, horns and anything that may be too edgy. Some are cardioid and some figure 8. Try using 2 figure 8's as a stereo pair (rotated 90 degrees ala Blumlein). Officially, miking technique is not EQing but it does some of the same things and does it in the beginning. This makes EQing easier and elegant.

When you do have to EQ, the band tracking session is the time to be careful and conservative. Most experienced pro engineers don't wing it here. Safe, fast, ready, recorded. It may not sound as "slamming" as it could be, but wait, it still gets overdubs and a real mix. Engineers who don't play it safe at the right time tend to find other occupations like accounting. You can fix the EQ and Compression later particularly if you are working digital. You may want to save those initial more-or-less flat tracks though, for a few days or weeks, just in case.

Another little detour. There always seems to be some fascination with re-capturing some of that 60's and even early 70's sound. These were the days of 4 track and 8 track analog machines and no time-code or sync systems. They didn't have a lot of gear, so it was important to have the good stuff. Much of it was vacuum tube or passive. Overdubs were a luxury but they could mix those 4 or 8 tracks to mono or stereo and bounce them over to another machine. It was analog tape so you couldn't do it more than a few times. So, what are the priorities when you record that way?

1) The song and the vocals was what producers wanted and perhaps that hasn't changed much. Bands were recorded with live vocals back then. Even overdubs were a band thing. Much of the signature of both the British or American sound were the vocal harmonies. Same today.

2) It was only practical to record as a band, as a group. They rarely used a click, except for TV & film scores. The "groove", as today, was important, but it was a little less rigid. It sometimes meant MANY band takes with different tempos and stylings.

3) Arrangements were often written in stone. It was cool to walk in with a working rehearsed arrangement. Sometimes professional arrangers were hired. The fewer the instruments, the easier it is to make each one sound great. They 'featured' instruments by writing musical rests for the other parts rather than moving a fader. Big and powerful dynamics could mean more players, more chairs.

4) The mixes were critical because the word re-mix wasn't created yet. Remember, each "bounce" had to be a real mix and these submixes were the basis of the final mix. This is where they EQed most. Part of the British sound was dipping a bit between 200 Hz and 1K on some instruments. It was the "proper" way to clear space for each instrument. Bass was hinted as the secret of rock and roll. Part of the American sound was both the bored union engineers and the young rookies. There wasn't much gear so they stretched it and pushed it hard. Simple shelf EQs and filters were the norm and "bell curves" were rare until the mid 70's. However, they sometimes had 5 to 7 band graphic EQs. They could and did cut tape so they mixed in sections and spliced - no automation.

5) Not much effects in dem days; tape slap, live chamber reverb and/or EMT plates. Some were OK and some were plain bad. They did focus more on creating an acoustic space with the mics. It wasn't until 16 track that it became fashionable to focus on separation and dead rooms. Then we heard a lot of overdubs and double tracking and we got the 70's sound.

6) DI boxes and synths were very rare, percussion was normal, "unusual" instruments were cool. Song "structure" often leaned toward a few standard patterns (ABABCAB). It was a more innocent era but more likely to be censored. On the other hand, the phrase "politically correct" would have been viewed as a joke, an oxymoron.

Some of these techniques may be useful to you whether you are attempting to resurrect the 60s or the get the cool grunge of the 90's. Some tricks like the editing of mix sections can be transposed to workstations with all the advantages of both. It sure can be a better alternative to an long automated homogenized mix. Limiting overdubs may inspire getting that perfect band groove and may spur creativity. Limiting yourself to shelves and filters or old gear may be a silly way to get the 60s sound. When you want to lean on shelves, the Massive Passive EQ shelves and filters are about as good as it gets. In other words, an old analog engineer will feel right at home - well "hear" right at home". Now if you could just remove that computer screen.....

Individual Sounds: There just isn't a general EQ that works on all snare drums, or kicks or vocals. Too much depends on the player, the instrument, the room, the mic, and a hundred other variables. We heard of one producer that insisted on cloning a guitar sound he once got by insisting on using this elaborate chain that he had documented of amps, mics, several vintage compressors and several old EQs. There were 3 problems. This producer insisted that only the exact settings he had so carefully noted were used. It was a different studio with different individual units, like mics, like rooms, consoles, engineers.

The last problem was that they only had a few weeks to shout at each other. Avoid that technique. You gotta be creative, play it by ear, use your own variation if it works out that way this time. Only the final result counts. There are many ways to get a killer sound and too damn few that work every time. You may know most of this already.

General Suggestions: If you are recording acoustic instruments, the most important first step is going out to the studio and listening, evaluating and memorizing. Next step, if there is a way you can fix a sound physically, like changing a drum skin, or tuning a tom, this is the time and place. If you can, you should attempt to improve the mic choice and positioning. There's always room for improvement, but most often the obstacle is "available time". EQing is usually faster than experimenting with mics unless the producer wants "perfection". EQ is maybe more dangerous though and a poor substitute for great mic technique.

Vocals: There is something that makes EQing vocals very difficult. Human beings have evolved hearing fine tuned to other human's voices. Not many people know precisely what a drum sounds like but almost everybody can recognize when the vocal sounds weird or natural. Another common factor is the goal of making a mediocre vocal sound awesome through the miracle of electronics. The toughest one is when the singer deeply desires to sound like their idol and thinks that the only difference is the gear and settings. With luck, you may work with a great singer and discover you need no EQ and it sounds incredible. Same is true with spoken words. Some of the best paid guys are those professional voices that do narration, voice-overs and character voices. They don't do it with EQ, it's in the voice. If the singer is having headphone adjustment problems, try flipping the phase of the mic and asking the singer which they prefer. Some mics are out of phase with some people's bone conduction or the headphones are 180 degrees out, but there seems to be 50-50 odds that flipping the phase will sound better to them and about 99% likely it will sound the same to you (until you put on their phones talk into the mic and check it out).

We commonly chop off the lows while recording voice to kill room rumble and "pops". Some use a HP switch on some mics, some angle the mic so its not directly facing the mouth, some use the mic pre filters and some use their console EQ. The Massive Passive HP filters are as good or better than anything you have been using for filters. The other most common technique is boosting highs. Part of this is because somebody used a dull mic because it was advertised as "warm". The other reason to boost is a bright, airy voice may be needed with massively over-dubbed, over-synthed mixes just to get above the track. Watch out for boosting too much esses as you try to get it bright. Conventional high shelves (even if set for 16K) will boost the esses and possibly the mids. The Massive Passive was designed to not have that very common problem and allow some unusually gorgeous highs. Some engineers, avoid EQing to tape while recording, but use it in the monitor or mix channels as needed. This way, they still get a good working mix and may hear if headphone leakage will end up being a problem. On the other hand, as the tracks add up, some engineers find it more practical to EQ tracks while recording, so that speedy fader mixes are simple for the months of overdubs. In the mix, if you find yourself wanting to boost a lot of highs, try dipping the mids and boosting the highs less. If you still need a de-esser use it as the last processor in the vocal chain in the mix. Wanna know one of the least expensive and best de-essers? "A bit of chewing gum or wax filling the gap in the singer's front teeth."

Rather than try to do all your compression while recording vocals, save some for the mix. This takes a little pressure off of finding the "ultimate" compressor with perfect settings and you have the option of compressing the vocals as a group.

Real Drums: Typically need lots 'o' EQ because we typically close-mike individual drums. Big shelf boosts on the Massive Passive are particularly good. When EQing watch out for leakage so have the drummer play the whole kit alternating with a drum you are working on - keep those other faders up. Sometimes, boosting too much highs on a snare or toms may boost the hi-hat and cymbals out of control. Gates may be needed in profusion when the close-mic style and drastic modification is desired. Another consideration is EQ ringing and time smear. Drums particularly are good at showing off bad EQ settings. The transients "trigger" ringing, so big narrow bell boosts become obvious EQ. Usually this is to be avoided. Steep filters bring group delay which smears the time clues and transient accuracy, especially when the filters are nearer the mid band. Watch out for this. Occasionally these "effects" can be useful especially if used for their effect-value such as transforming a click into a drum.

Spend a little less time working on individual drum sounds and get the mix up sooner and get the groove going earlier, then go back to adjust EQ as needed. Keep in mind that the hi-hat and snare work together, which should fit with the bass drum and bass, and that most people hear the drums as one instrument and mostly engineers hear them as several individual sounds or tracks. The blend and groove are most important, the image or room sound is what sets the "tone". The EQ and processing may be used to ensure the best overall groove and image rather than make each drum "perfect".

Yes, it is legal to EQ and Limit overhead and room mics. EQ both sides of a stereo pair identically and "link" limiters. If you are lucky you can almost get most of the drum sound from the overheads or room mics, with some bass drum and maybe snare snuck in. You should also consider suggesting to the drummer to bring lighter, brighter, smaller cymbals in than what he or she uses live. Either you know why we say this or you will find out.

Some engineers use a combination of a filter (set between 25 and 50 Hz) and a shelf boost (between 100 and 200Hz, roughly). It almost approximates a standard bell boost, but sounds drier and tighter and still huge. The shelf tends to ring less or decay faster than bells, while the filter keeps it clean and under control.

Sampled Drums: Probably pretty good right out of the box. Try using a strange sample and using EQ, compression and clipping to turn it into something totally different. You can turn a click track into a bogus kick drum. It is fun and you might never run out of sounds this way.

Some of the genesis of the rap kick and "808" rediscovery was some NY engineers who would use a drum machine part, to trigger a noise gate on the studio's oscillator set at 40 or 60 Hz. Others found it easier to get similar results with an extinct vintage 808 drum machine sound sampled and EQed. Many went all the way back to using purely the 808s and these little drum machines became sought after, which then sparked an industry of 808 clones and sample disks. These things seem to start off cool and clever and became a bit mindless and overused, then sneered at for a few years, then makes the cycle again. Fashion... At least we don't have Rodeo Drive and Milan suggesting we replace all our gear every season

Percussion: There are two big tricks. The first is don't trust VU meters - use peak meters and don't get too close to full scale. The key word is percussion and the peaks or transients are very short and impressively hot. When in doubt, turn it down. Actually when in doubt, listen to a short bit recorded, then turn it down if it was crunchy. The second trick is to EQ these tracks in the mix, not soloed. We tend to make things bigger by themselves, but the function of percussion is to fit in the track and work with the other instruments. They don't have to be loud to work. Be aware that boosting mids or highs will make peaks easier to clip too.

Bass: Good spot for a reminder. The bass and kick are usually meant to work together musically yet remain separate and distinct. The usual idea is if you have a deep bottom kick then the bass guitar doesn't cover that space. Put it in the low mid part of the spectrum. Or you can make the bass guitar extra-deep and the bass drum in a higher part in the spectrum. You also want to watch where you place the kick's attack and the harmonics of the bass. If you use a mic on the amp plus a DI, expect that when you mix them, they very often sound half out-of-phase. You can use a delay to try to compensate the DI or just use the Massive Passive filters to get the DI lows (filter from the mids up) and mix in the mic/amp highs (filter or shelf cut the lows). What is easier, simpler and can be best is, using only the amp with a damn good selected mic and using the Massive Passive low shelf to nail the bottom.

Guitar: My favorite difficult instrument to EQ. So many different guitar sounds and so little time. Filtering the high freqs on loud amps can make them more amp-like, natural and kills that "studio" buzzy distortion. Check out what filtering highs does with the Massive Passive. The low-pass filter is one of the main functions of speaker simulators. Feel free to play with the simulator's controls along with the Massive Passive LP filters. The mids are especially critical and might take some drastic EQ. This is where you get "singing" lead solos or biting ones or more unusual sounds and its how you can separate a few parts from each other. To get that big bottom you hear in the studio but not in the control room, means that you should have used a ribbon mic and/or miked the cabinet back too. You may still need to EQ but be sure you have some solid lows to work with. The secret to acoustic guitar is no EQ. Getting the sound with instrument choice and with careful miking is how the professionals do it. Again you can dip mids or shelf boost the highs. Sometimes a notch and/or HP filter is absolutely needed.

Leslies: This reminds us of a trick question. When you have a rotating baffle for the lows and a rotating horn for the highs, what is the most critical thing to EQ. Answer - the mids. If you somehow lose the mids, it will sound weak. You can make it bark or bite or soften it into a smooth pad, but the attitude should fit the song, not some memory of some legendary B3 unless it was playing a similar part in a similar texture.

Piano: Different engineers have different ideas on how a piano should sound and how to mic and process it. So much depends on the piano, the player and musical style. Rockers generally want it hard and brite, jazz guys like it warm and classical guys expect distance and perspective. We might suggest starting off with a gentle dip in the 200 Hz to 500 Hz area. The piano may benefit with a shelf boost in the upper mids and highs, but be gentle in the recording stage. Remember it is a percussion instrument and a boost may make it harder to record without clipping. Being such a full range & dynamic instrument, leave yourself options for the mix.

Loops: The trick? Make the bad stuff sound good and the good stuff sound bad. Put it all together and go nuts with the mute switches. For that ol' telephone filter, first try the two mid bands with deep shelf cuts. You might expect to just use the filters but these ones probably neither go high enough nor low enough for this purpose so use them in combination with those deep shelves.

Synths: There is a lot of room to EQ on analog synths and often less with samplers. Watch out for sub-harmonics and ultra-deep lows that the small monitors don't reproduce. What you hear in the studio and what "they" hear with a subwoofer can be different, and that is often an understatement. Some car systems are a good place to evaluate the very deep subwoofer zone.

More often than not, try to leave space for the rest of the tracks by dipping a bell curve strategically. It works better than boosting bells (into resonance) on the remaining tracks. If the arrangement is dense, avoid making every sound as big as a house. The secret to amazing sounding individual tracks are sparse sections where these sounds are featured. The arrangement also helps create contrasts and sets up the thicker sections to be huge. LP Filters can be very interesting on synths because a LP filter sound is a functional part of analog synth hardware (or software). Try making up a synth-like resonant filter with one of the high shelves deeply cut and the Bandwidth turned way up. Too bad you can't sweep it.

Mixes: There are two ways to process a mix. The first is to set up the 2 mix EQ and compression early in the rough mix stage, then mix into the processor. The second and more common way is to get a finished mix then EQ and compress. The first way forces you to mix differently and can produce results that can be powerful, but it can also be dangerous in less than experienced hands. More and more guys are EQing their final mixes. Sort-of pre-mastering or skipping the mastering process altogether. Should you?

Let us describe some of the main ideas in mastering from the mastering engineer's "order of importance" and you can decide.

1) The most important thing in mastering chain is the mastering engineer. These people EQ and compress, edit and check everyone's "final" mixes, a CD or two a day, 5 days a week, and year in and year out. They specialize in the most subtle paths to the polished product. They are expected to bring the clients tapes to be "ready for prime-time" quality and be sure that a problem free master is absolutely ready for any pressing plant. Of course, you are going to have to pay for this "expert" service.

2) The most important piece of gear for mastering is the tweaked-up speaker systems. The best mastering engineers typically spend a great deal of money, time and effort to be sure that their room is true and accurate (to them) and that every last bit of performance is squeezed out of the entire system and that it is that way every day. After all, the big reason we need to go through the mastering process is that most of us mix on cheap, small speakers, self-powered or not. The kinds of speakers most of us use for mixing are about 2%-25% of the reference quality most mastering engineers use every day. If you describe your monitors as "I guess the speakers are good enough to master on" then they're not and if you say " I KNOW these particular monitors in this room are good for mastering" then they probably are. These may well be the same speakers too. Do you understand the difference? (its not just attitude)

3) The rest of the gear in major mastering houses is also so important that "cost is no object". The engineers regularly "shoot-out" new gear and will always buy if it IS better. In a pro mastering house there are no weak links in the chain and no semi-pro gear.

4) There isn't a single processing unit that is the key but more like a combination of several that are mostly slightly utilized. A common scenario is a combination of esoteric analog parametric EQs and compressors along with the digital EQs and dynamics processors, all used together and each for a few dB of its strongest features. Manley Labs is one of the very few names commonly seen in most major mastering facilities.

The newest and least common piece of gear in project level mastering is "DSP Multi-band Compressors". Multi-band compressors have been used to maximize the loudness of radio and network broadcasts for about 20 years. Do you really like the radio squash? Contrary to the ads, a single piece of gear does not make anybody into a mastering engineer. This also does not mean these devices are bad, only that they can be somewhat dangerous, or powerful and sometimes amazing when used properly and carefully. Rather than think of them as multi-band compressors, you will find that they act like multi-compressed EQs. These compressors are changing the EQ all the time so it is important to understand the specifics of the controls and what each does to the sound. Just because it is multi-band doesn't excuse a poorly set-up compressor, in fact, it makes it worse because EQ changes are easier to notice than "flat" gain changes. The most exercised button should be the bypass switch. The mastering engineer may not be able to fix up a tape butchered by these toys. It is becoming a common story, where the mastering engineer sends the client back to re-mix because of an abused multi-band toy.

One can prepare for mastering, fairly simply. Mix to a well maintained 1/2" tape or to a 20 or 24 bit digital format. Many guys mix to DAT only, but mastering engineers will almost always suggest analog. Best format - mix to all three and let the mastering engineer choose. The best prep for the mastering engineer is a well balanced mix. It's fine to compress and EQ the mix, but absolutely don't overdo it. Be careful, you can mess up months of work if you get carried away. The time to de-ess is during mix as the final step in the vocal chain. De-essing a mix in mastering can be 10 times harder. You have probably heard that one of the reasons we master, is to get hotter levels. True, but keep in mind that anybody can compress 20 dB, squash and clip and get super-loud but that mastering engineers do not do that. The way they compress and limit typically gets about 6 dB into the red on a VU meter and rarely sounds compressed or crunched. It is not only about getting louder, but "optimally loud" and not at all messed up in the process.

The best way to prepare for mastering is to do the best mix you can. Don't go nuts on trying to pre-master, by over-compressing and EQing and especially "multi-band limiting". The idea is to let the mastering engineer do their job and not try to do it for them. Leave them enough room to work and get optimal compression. The other thing to remember is to know the speakers you are mixing on. An 8 inch woofer should not sound like an 18 incher. The second most common problem is from engineers who have cranked up their sub woofers and end up with a mix with no bottom. Play other peoples great mixes on your speakers fairly frequently. It helps maintain your reference.

The Circuit

If you are attempting to master the project or “pre-master” (this year’s hot, new audio buzzword) yourself, here are some suggestions. Take a week off after mixing, then listen to the mixes on as many different systems as you can, friend’s homes, cars, boom boxes, headphones, etc. and make notes. With an eye on those notes, adjust. Now check it out on some of those systems again, before you send it out. 80% of mastering is ensuring quality and confidence through expertise, 20% is knob turning and then it is “which knobs, how little (as opposed to much) and when”. On the other hand, it is only two tracks and probably you only intend to do a minor touch-up and you are sure it will help. It may not be as good as it gets but it is a valid improvement and you are not doing anything radical or stupid, so.....go for it!

Miscellaneous Techniques:

Rather than stress out trying to make one EQ solve every problem, try a combination of two different EQs or one for recording and a different one in mixing that track. It's like an old engineer's trick. Rather than look suspect with an EQ boosted 12 dB, he would use three different EQs, each with 4 dB. It looked way better, very “pro” and seriously into gear. Ever have producer looking over your shoulder, checking out your “curves”?.... Nuff said.

Also it is worth experimenting with the order of processors especially when compression, limiting and clipping is involved. We get asked whether it is best to EQ then compress or the other way around. People do it both ways and each has advantages depending on the situation. If you compress first, then you should be able to boost EQ more without clipping. If you compress after EQ, then you smooth the track based on the new tone, which may be more leveled or “even” sounding. De-essing, if needed, is best and easiest as a final or next to final stage. Limiting should be the last step and should be done gently (a few dB) because more rarely sounds better.

EQing a sub-group saves using a lot of EQ on individual tracks and tends to blend and mesh the tracks into a cohesive group and usually makes it easier to mix them. Lots of us group, EQ and compress the drums or backing vocals. You should start off with the group EQ, then the individual channel EQs should fall into place easier. Of course, your console needs to be capable of this.

And for the opposite approach....Some guys “split” a track (or “mult” it or copy it) and EQ one channel lightly and one heavily, then mix them. The advantage is that you can easily change the tone by changing the mix in automation. It also gives twice as many options for adding reverbs and delays now that there are two channels but expect the fader moves to affect the effect sends and balances.

You probably thought of this one - Chaining one channel of the Massive Passive into the next one so that you have 8 bands. Here is the cool trick - put a distortion device in that chain between the EQs. This way you have incredible control of the distortion character. For example, you can boost highs before the distortion, which tends to reduce out the tendency to mostly distort the low mids, then remove some highs after the distortion which removes some of the buzzy edge. This is leaning towards simulating analog tape and guitar amps.....

The first, last and only real rule about EQ is “if it sounds good, do it”. Feel free to experiment. Enjoy and please let us know what adventures you are having with the Massive Passive.

The Massive Passive is not a particularly complicated circuit. The audio comes in, is converted from balanced to unbalanced and DC servo'd and given enough power (a few watts) to drive the EQ (and output in “bypass”) on the two vertical boards that the 1/4” jacks are mounted on. It uses a BB OPA2604 op-amp and a complementary pair of medium current transistors richly biased into near class A operation for this. These two boards also hold the output transformers and loading networks as well as the bypass relays. The transformer has a tertiary feedback winding which doubles as the -10dBv output which sort of explains why it is out-of phase.

The buffered signal is fed to the “buss boards” that connect all of the EQ cards. The signal is first applied to the “dB” pots used for boost. The “dB” pots on each EQ board are 10K dual reverse log and used as a parallel voltage divider so that a boost is actually just less cut. From here it goes to the filters and then to the main tube board for about 25 dB of make-up gain. Then back to the buss board which in turn feeds the “cut” sections then the front panel “gain” pots. From here another stage of make-up gain and out through big “Multi-Cap” capacitors to the outputs. The boost and cut sections are separated this way so that similar impedances can be created which allows the same EQ components to be used for the same frequencies.

Almost all of the parts on each EQ board are capacitors and inductors used for frequency shaping. The 11 position two deck Greyhill switches just select the combinations of C's & L's. Closest to the front is shelf selection. The only slightly complex part is the around the toggle switches. In “bell mode” they have to switch each EQ section from the boost circuit into the cut circuit. In “shelf mode” the components for shelf get switched and the bell components get switched into the opposite section. It uses a relay for this. The same circuit that controls the relays also powers the boost/cut LEDs. Lastly, the toggle switches also restrict the widest bells in bell mode so that at least 6 dB of EQ is available, and allow a few little tricks to voice the two lowest and highest shelves. “Bandwidth” control is just variable series resistance, just like a Pultec.

The two tube amplifiers (per channel) are 3 triode circuits which use one half of a 5751 for voltage gain and direct coupled into a 6414 totem-pole for current gain. The first amplifier uses less than 6 dB of plate to grid feedback. The second amplifier uses the tertiary winding via a trim pot back to the 5751 cathodes for variable feedback and final gain trim.

The power supply provides about 350 VDC for the tubes. The multi section “pi filtering” is on the tube board and is held pretty constant by 3 zener diodes. The supply also gives two 12V medium current outputs for the tube filaments, LEDs and relays. The two regulators mounted on the back panel are for these 12V supplies. There is also a positive and negative 18V regulated supply for the input circuit which is also sent to the buss board for future purposes. Lastly the power-on muting is done with a 555 on the power supply board. It feeds the “bypass” switches which feed the relays.

The only potential tricky part of tracing the signal is due to the signal levels changing (dropping 20 to 25 dB) a few times and being restored a few times. The good news is that, for all the parts in the Massive Passive, there is only a small number in the signal path and mostly in parallel. Over 95% of the repairs should only involve replacing a tube and verifying the gain is unity or needs a little trim.

Translations

This is just a few commonly used musical terms translated into technical terms or specific Massive Passive techniques. Note that these are fairly loose descriptions and definitions. Your mileage may vary.

Bottom, Fat for more:	the deep lows bell boost below 100Hz or use any low shelf up to even 330Hz. When you use a shelf this high, you should experiment with the bandwidth control more towards straight up or towards narrow.
Tubby	probably too much lows. Try removing somewhere between 82 to 220.
Sibilance for less:	between 5kHz and 8kHz for men & between 6kHz and 10kHz for women Bell cut at these freqs or Shelf boost with mid to narrow bandwidth freqs from 4700 to 27K to get more air and ultra-highs while removing sibilance. The exact frequency and bandwidth depends on the singer or source. The typical problem either is a gap in the singer's teeth (that a little chewing gum or wax in the gap may help) or HF distortion typical in many mics and low budget gear. It is better to cure the problem at the source rather than later resort to yet more EQ and de-essers.
Nasal, Squawk	corresponds to too much mids. A Bell cut between 820 and 1500 should help.
Honk	much like "nasal" but probably a little lower. Probably between 400 and 800.
Muddy	usually corresponds to too much low mids and not enough highs. First try bell dipping 220 Hz to 440 Hz
Presence, Edge for more:	usually upper mids, ie 2200 to 4700 try a gentle bell boost at 3300 to start.
Air	the extreme highs like 16kHz or 27kHz. With this EQ you can also try any of the shelves above 6800 and experimenting with the bandwidth control.
Telephone Sound	First try deep shelf cuts using the two mid bands set approximately for 390 and 4700. Experiment with the bandwidths and frequency selects. Try adding the 220 and 6K filters last rather than first.
Attack	usually the upper mids but depends on the instrument. For example on drums and bass for more attack try boosting 2200 Hz, for piano try 4700 or 5600. Limiters usually remove some of these transient heavy areas and may seem to dull the attack. The cure for that is longer "attack times" on the limiter.
Thump	corresponds to the deep lows like between 33 and 68.
Warmth	many vague meanings depending on who said it and in regards to what instrument. You can try adding low mids anywhere below 330 (try 250) or removing the extreme highs (try the 18K and 12K filters). Lately some people mean the sound is too clean or "digital". You can use a combination of shelf boost and shelf cut on the two lowest bands to drive the EQ section hard then restore it to reasonable levels and flatness. You can also try hitting the EQ with a boosted signal and turning the return point down. The usual culprit is too many cold crispy synths and samplers and you likely can't change that decision easily. We include a "preset" near the back page that gives the maximum THD if you want to try this approach.
Pop	with vocals usually means the excessive "P"s and "B"s when the singer is on-axis and close to the mic. First try a "popper stopper" or equivalent and/or try swivelling the mic so that it points to the singers shoulder and use the 120 or 68 filter. With snares it can mean the fundamental anywhere from 330 to 1200 Hz depending on the drum.
"FM DJ"	Lots o' lows and highs. Try dipping mids first. The trick is to start with a real DJ and use a little EQ.
"Old British"	Clear some muddiness by removing some 220 to 470 and boost a bit of presence around 2200 to 4700. An alternative technique is boosting the "defining character" or "note" of each instrument which entirely depends on the instruments. Best to do it without "solo's" and in the mix.

TROUBLE-SHOOTING

There are a number of possible symptoms of something not quite right, some may be interfacing, others we will touch on as well. If you suspect a problem the following paragraphs should help.

NO POWER, NO INDICATORS, NADA - Probably something to do with AC power. Is it plugged in? Check the fuse on the back panel. A blown fuse often looks blackened inside or the little wire inside looks broken or it's resistance measures higher than 2 ohms. A very blackened fuse is a big hint that a short occurred. Try replacing the fuse with a good one of the same value and size. If it blows too, then prepare to send the unit back to the dealer or factory for repair. The fuse is a protection device and it should blow if there is a problem. If the unit works with a new fuse, fine, it works. Sometimes fuses just blow for unknown reasons.

LIGHTS BUT NO SOUND - First try plugging the in and out cables into each other or some other piece of gear to verify that your wires are OK. If not fix them or replace them. Assuming that cables passed sound - it probably is still a wiring thing. The output XLRs are transformer balanced which require both PIN 2 and PIN 3 to be connected somewhere. When driving an unbalanced input (inserts on some consoles) PIN 3 needs to be grounded or connected to PIN 1. Same with the unbalanced 1/4 inch jacks - if driving a balanced input you can't ignore the negative side. It needs to be connected to the sleeve of the phone plug. Another way to do basically the same thing is join PIN 1 and PIN 3 on the XLR male at the destination. Easiest way - Use the balanced with balanced, unbalanced with unbalanced. That is why the options are there.

LEVELS SEEM TO BE WRONG, NO BOTTOM - Several possible scenarios. Manley uses the professional standard of +4 dBm = Zero VU = 1.23 volts AC RMS. A lot of semi-pro gear uses the hi-fi reference of -10 dBm = Zero VU. This is a 14 dB difference that will certainly look goofy and may tend to distort. Often there are switches on the semi-pro gear to choose the pro reference level. If the loss looks close to 6 dB and it sounds thin then one half of the signal is lost. The cause is probably wiring again. One of the two signal carrying wires (the third is ground / shield on pin 1) is not happening. Check the cables carefully because occasionally a cable gets modified to work with a certain unit and it seems to work but its wrong in other situations. If only one side of the Massive Passive exhibits this problem, it may be a problem in the Massimo. See the next item.

ONE SIDE WORKS FINE BUT THE OTHER SIDE IS DEAD - Let's assume this is not wiring. We are pretty sure it is the Massimo. If it were solid state you would generally send it back for repair. Being a tube unit, you can probably find the problem and fix it yourself in a few minutes. Not too many years ago, even your parents could "fix" their own stuff by taking a bag of tubes down to the corner and checking the tubes on a tube tester - but these testers are hard to find today. A visual inspection can usually spot a bad tube just as well. Be careful - there are some high voltages inside the chassis and tubes can get pretty warm, but if you can replace a light bulb you should be able to cruise through this. Before you remove a tube, just take a look at them powered up. They should glow a bit and they should be warm. If one is not, you have already found the problem. The tube's filament (heater) is burnt out or broken like a dead light bulb. The other big visual symptom is a tube that has turned milky white - that indicates air has gotten into the tube or we've joked "the vacuum leaked out". Either way replace the tube. Manley can ship you a tested one for a reasonable price. Before you pull a tube, pull the power out, let the unit sit and cool and discharge for a minute or two, then swap the new tube in, then power, then check. Gentle with those tubes, don't bend the pins by trying to insert the tube not quite right. A little rocking of them as you pull them out or put them in helps. The two taller tubes are the same so you can swap them. If the problem follows the tube you found the problem - a bad tube. No soldering, no meters, one screwdriver - easy. See page 17 for a diagram of tube locations.

HUM - Once again - several possibilities - several cures. Most likely it is a ground loop. Ideally each piece of gear should have one ground connection and only one. However, the short list of grounds include the AC mains plug, the chassis bolted to a rack with other gear, each input and each output. The two most common procedures are: try a 3 pin to 2 pin AC adapter (about a dollar at the hardware store). This while legal in many countries can be dangerous- We went one better; Method two - On the back panel loosen the GROUND TERMINALS and slide the small metal ground strap to one side. This is way better than "method one" because it is safer and removes another possible source - the chassis grounding via the rack. Method three - cutting the shield on one end of each cable. This is done by some studios at every female XLR to "break" all ground loops. All the other gear in the rack is "dumping" ground noise onto the ground. Try removing the EQ from the rack so that it is not touching any metal. You just may have cured a non-loop hum. Some gear radiates a magnetic field and some gear (especially if it has audio transformers or inductors) might receive that hum. A little distance was all it took. The Massive Passive is full of inductors and audio transformers which have the potential of hum pick-up from other units however they are run "hot" to minimise this possibility. It is worth a few placement experiments if you notice hum especially in EQ mode (not bypass).

IT MAKES NOISES WHEN THE FRONT PANEL IS TAPPED - An easy one. Some tubes become microphonic over time. That means they start acting like a bad microphone. Vibration has caused the supports for the little parts in the tube to loosen and now the tube is sensitive to vibration. Easy - Replace the tube. Which one? The one that makes the most noise when you tap it. Usually this will be one of the smaller (gain stage) tubes closest to the front. The Massive Passive will have to be on, connected and speakers up but not too loud for the sake of your speakers.

IT GOT HISSY - Also easy. This is again a common tube symptom. You could swap tubes to find the bad boy, but an educated guess is OK too. Generally the first tube in the path is the one with the most gain and dealing with the softest signals. The usual suspect is the shorter tubes - the 5751/12AX7 voltage amplifiers. You may find that you need to choose the quietest tube out of several of that type - like we do at the factory.

DISTORTION - This might be a tube. Swapping is a good way to find out. It may be a wiring thing or mismatch as well. Wiring problems usually accompany the distortion with a major loss of signal. Mismatches are a bit tougher. The Massive Passive has a high input impedance and low output impedance that can drive 600 ohm inputs of vintage "style" gear. Best place to start is check your settings and meters. It may not be your first guess.

GETTING DISTORTION WHEN WE BOOST A LOT. No doubt. The Massive Passive by itself should have enough headroom so that mega-boosts won't cause clipping in it, however, it can push out about +37dBv, 10 or 15 dB more than most gear can accept without clipping. You're gonna have to turn something down, whether it is the signal feeding the EQ, the "Gain Trims" on the EQ's front panel or the input levels of the next piece. That last option may not help if there is any op-amps before its own volume control and unfortunately that is pretty common.

DC OR SOMETHING AT THE OUTPUT THAT IS INAUDIBLE - The 1/4" unbalanced outputs have a frequency response that goes way down to below 1 Hz. A little very low frequency noise may be seen as speaker movement when monitors are pushed to extreme levels. The XLRs do not exhibit this because the transformers filter below 8 Hz. Also the unbalanced outputs do not like long cheap high capacitance cable. Occasionally a very high frequency oscillation (200 kHz to 400 kHz) may occur in these conditions. Once again use the XLR outputs. Problem solved.

THE GAIN SEEMS OUT OF CALIBRATION - Wait a bit and see if it just needs to warm up. There are only two trimmers inside and they are for adjusting the gain of the two channels up or down a few dB. More than that and you either have a bad cable or bad tube.

Once in a while we get a call from a client with a "digital studio" with confusion about levels. They usually start out by using the digital oscillator from their workstation and finding pegged VU meters the first place they look and they know it can't be the workstation. Even a -6 level from their system pegs the meters. Some of you know already what's going on. That -6 level is referenced to "digital full scale" and the computer might have 18 or 18.5 or 20 dB of headroom built in. That -6 level on the oscillator is actually a real world analog +12 or +14 and those VU meters don't really go much further than +3. There are a few standards and plenty of exceptions. One standard is that normal (non-broadcast) VU meters are calibrated for 0VU = +4 dBm = 1.228 volts into 600 ohms (broadcast is sometimes +8dBm). Another standard is that CDs have a zero analog reference that is -14 dB from digital full scale or maximum. This allows sufficient peak headroom for mixed material but would be a bad standard for individual tracks because they would likely distort frequently. This is why digital workstations use higher references like 18 and 20 - to allow for peaks on individual sounds. It may be too much in some cases and too little in others. Add two other sources of confusion. Peak meters and VU meters will almost never agree - they are not supposed to. A peak meter is intended to show the maximum level that can be recorded to a given medium. VU meters were designed to show how loud we will likely hear a sound and help set record levels to analog tape. By help, we mean that they can be only used as a guide combined with experience. They are kinda slow. Bright percussion may want to be recorded at -10 on a VU for analog tape to be clean but a digital recording using a good peak meter should make the meter read as high as possible without an "over". Here is the second confusion: There aren't many good peak meters. Almost all DATs have strange peak meters that do not agree with another company's DAT. One cannot trust them to truly indicate peaks or overs. Outboard digital peak meters (with switchable peak hold) that indicate overs as 3 or 4 consecutive samples at either Full Scale Digital (FSD) are the best. They won't agree with VU meters or Average meters or BBC Peak Programme (PPM) meters either. Each is a different animal for different uses. When in doubt, use the recorder's meters when recording - they "should" be set up and proper for that medium. Also important - if your DAC has gain trims, and these trims are "out" it can cause distortion, confusion, and a variety of mis-matches. If you don't have calibration tapes or sources - get them, and if you do have them - learn how to use them, and definitely use them. Don't guess, especially if you suspect a significant problem. This is not the type of thing "phone support" is usually good at finding. We have seen guys spend thousands on new gear only to find out a little screwdriver trim would have solved their problems.

MAINS CONNECTIONS

Your MASSIVE PASSIVE has been factory set to the correct mains voltage for your country. The voltage setting is marked on the serial badge, located on the rear panel. Check that this complies with your local supply.

Export units for certain markets have a moulded mains plug fitted to comply with local requirements. If your unit does not have a plug fitted the coloured wires should be connected to the appropriate plug terminals in accordance with the following code.

GREEN/YELLOW	EARTH
BLUE	NEUTRAL
BROWN	LIVE

As the colours of the wires in the mains lead may not correspond with the coloured marking identifying the terminals in your plug proceed as follows;

The wire which is coloured GREEN/YELLOW must be connected to the terminal in the plug which is marked by the letter E or by the safety earth symbol or coloured GREEN or GREEN and YELLOW.

The wire which is coloured BLUE must be connected to the terminal in the plug which is marked by the letter N or coloured BLACK.

The wire which is coloured BROWN must be connected to the terminal in the plug which is marked by the letter L or coloured RED.

DO NOT CONNECT/SWITCH ON THE MAINS SUPPLY UNTIL ALL OTHER CONNECTIONS HAVE BEEN MADE.

Note: This unit has been factory wired for your country. If you plan to take the unit to countries with a different mains voltage you will need to send the Limiter to Manley Labs for the correct power transformer - or use AC voltage converters. See page 17 to convert this unit for a different mains voltage.

SPECIFICATIONS

MANLEY MASSIVE PASSIVE STEREO TUBE EQUALIZER

Maximum Input : 1.5% THD		+20 dBm
Maximum Output : 1.5% THD		
Unbalanced: 20-20K		+37 dBm
Balanced: 100 to 20K		+37 dBm
Low Freq Saturation		+26 @ 20 Hz
Headroom (referenced to +4 dBm)	flat	33 dB
Eq boosted full 20 dB		13 dB
THD & Noise (1kHz @ +4 dBm)		.06%
Frequency Response: +/- 2 dB		8 Hz to 60 kHz
Noise Floor (referred to +4dBm)		-85 dB (A Weight) (ref to +4 dBm)
Signal to Noise		120 dB typical (A Weight) (ref to +37 dBm)
Input Impedance		20 K ohms
Output Impedance		150 ohms
Power Consumption	72 watts	600 mA @ 115VAC
Fuse	2 Amp Slo-Blo (@ 120VAC)	1 Amp Slo-Blo (@ 240VAC)
Size (3U)	19" x 5.25" x 10"	
Actual Weight	21 Lbs	
Shipping Weight	27 Lbs	

(preliminary specs & subject to change)

BLOCK DIAGRAM SHOWING SIGNAL FLOW

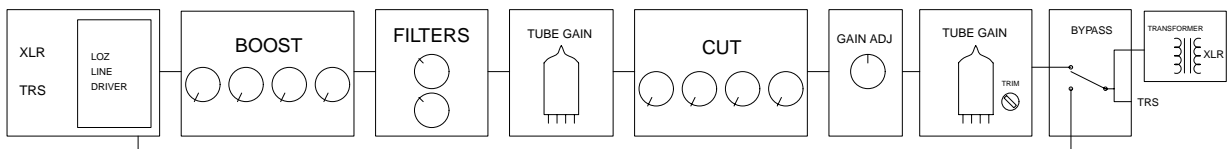

WARRANTY

All Manley Laboratories equipment is covered by a limited warranty against defects in materials and workmanship for a period of 90 days from date of purchase to the original purchaser only. A further optional limited 5 year transferrable warranty is available upon proper registration of ownership within 30 days of date of first purchase.

Proper registration is made by filling out and returning to the factory the warranty card attached to this general warranty statement, along with a copy of the original sales receipt as proof of the original date of purchase, or registration can be made online in the Tech Support section of www.manleylabs.com.

This warranty is provided by the dealer where the unit was purchased, and by Manley Laboratories, Inc. Under the terms of the warranty defective parts will be repaired or replaced without charge, excepting the cost of tubes. Vacuum tubes and meter or badge lamps are warranted for six months provided the warranty registration is completed as outlined above.

If a Manley Laboratories product fails to meet the above warranty, then the purchaser's sole remedy shall be to first obtain a Repair Authorisation from Manley Laboratories and return the product to Manley Laboratories, where the defect will be repaired without charge for parts and labour. All returns to the factory must be in the original packing, accompanied by the Repair Authorisation, and must be shipped to Manley Laboratories via insured freight at the customer's own expense. Factory original packaging can be ordered from Manley Labs. Customer will be charged for new factory original packaging if customer fails to ship product to Manley Labs in the original factory packaging. After repair, the product will then be returned to customer via prepaid, insured freight, method and carrier to be determined solely by Manley Laboratories. Manley Laboratories will not pay for express or overnight freight service nor will Manley Laboratories pay for shipments to locations outside the USA. Charges for unauthorized service and transportation costs are not reimbursable under this warranty, and all warranties, express or implied, become null and void where the product has been damaged by misuse, accident, neglect, modification, tampering or unauthorized alteration by anyone other than Manley Laboratories.

The warrantor assumes no liability for property damage or any other incidental or consequential damage whatsoever which may result from failure of this product. Any and all warranties of merchantability and fitness implied by law are limited to the duration of the expressed warranty. All warranties apply only to Manley Laboratories products purchased and used in the USA. All warranties apply only to Manley Laboratories products originally purchased from an authorised Manley dealer. Warranties for Manley Laboratories products purchased outside the USA will be covered by the Manley Importer for that specific country or region. "Grey Market" purchases are not covered by any warranty. In the case that a Manley Laboratories product must be returned to the factory from outside the USA, customer shall adhere to specific shipping, customs, and commercial invoicing instructions given with the Return Authorisation as Manley Laboratories will not be responsible for transportation costs or customs fees related to any importation or re-exportation charges whatsoever.

Some states do not allow limitations on how long an implied warranty lasts, so the above limitations may not apply to you. Some states do not allow the exclusion or limitation of incidental or consequential damages, so the above exclusion may not apply to you. This warranty gives you specific legal rights and you may also have other rights which vary from state to state.

For Tech Support and Repair Authorisation, please contact:

MANLEY LABORATORIES, INC.
13880 MAGNOLIA AVE.
CHINO, CA. 91710 USA
TEL: (909) 627-4256
FAX: (909) 628-2482
email: service@manleylabs.com

WARRANTY REGISTRATION

We ask, grovel and beg that you please fill out this registration form and send the bottom half to:

MANLEY LABORATORIES
REGISTRATION DEPARTMENT
13880 MAGNOLIA AVE.
CHINO CA, 91710 USA

Or you may FAX this form in to: +1 (909) 628-2482 **or** you may fill in the online warranty registration form found in the Tech Support section of our website www.manleylabs.com **or** you can be really diligent and register your warranty three times to see if we get confused!

Registration entitles you to product support, full warranty benefits, and notice of product enhancements and upgrades, even though it doesn't necessarily mean that you will get them (Just kidding!) You **MUST** complete and return the following to validate your warranty and registration. Thank you again for choosing Manley gear and reading all the way through The Owner's Manual. (We really mean that sincerely, the bit about thanking you for choosing our gear. THANK YOU!!!)

MODEL _____ SERIAL # _____

PURCHASE DATE _____ SUPPLIER _____

PLEASE DETACH THIS PORTION AND SEND IT TO MANLEY LABORATORIES

MODEL _____ SERIAL # _____

PURCHASE DATE _____ SUPPLIER _____

NAME OF OWNER _____

ADDRESS _____

CITY, STATE, ZIP _____

EMAIL: _____

TELEPHONE NUMBER _____

COMMENTS OR SUGGESTIONS? _____

This Preset is a great example of how:

to drive the unit hard for a little THD warmth
to mess up somebody who studies your settings
the Massive Passive is different from other EQs

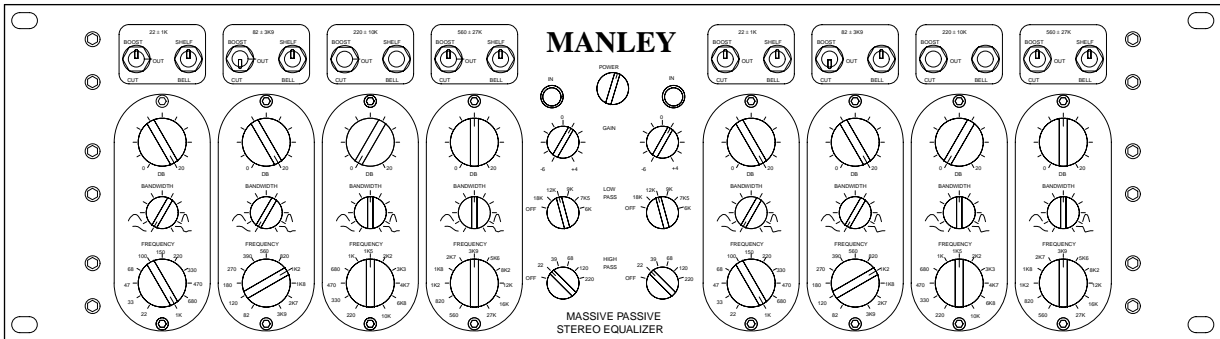

Set this one up with no signal and guess what it will sound like by the panel settings and your experience with other EQs
Try adjusting both high band dB knobs to your needs. For some situations the Low Pass filter can be bypassed.

More presets to do

TEMPLATES FOR STORING MASSIVE PASSIVE SETTINGS

MANLEY

POWER IN IN

GAIN 0 +4 -4 -8

LOW PASS OFF 18K 9K 7K5 6K

HIGH PASS OFF 22 33 47 68 100 150 220 330 470 680 1K 1.5K 2K

MASSIVE PASSIVE STEREO EQUALIZER

<p>22 ± 1K</p> <p>BOOST <input type="checkbox"/> SHELF <input type="checkbox"/> OUT <input type="checkbox"/> CUT <input type="checkbox"/></p> <p>0 20</p> <p>BANDWIDTH</p> <p>FREQUENCY 100 150 220 330 470 680 1K 1.5K 2K</p>	<p>82 ± 3K9</p> <p>BOOST <input type="checkbox"/> SHELF <input type="checkbox"/> OUT <input type="checkbox"/> CUT <input type="checkbox"/></p> <p>0 20</p> <p>BANDWIDTH</p> <p>FREQUENCY 270 390 560 820 1180 1680 2K7 3K9 6K8</p>	<p>220 ± 10K</p> <p>BOOST <input type="checkbox"/> SHELF <input type="checkbox"/> OUT <input type="checkbox"/> CUT <input type="checkbox"/></p> <p>0 20</p> <p>BANDWIDTH</p> <p>FREQUENCY 680 880 1K 1K5 2K2 3K3 4K7 6K8 10K</p>	<p>560 ± 27K</p> <p>BOOST <input type="checkbox"/> SHELF <input type="checkbox"/> OUT <input type="checkbox"/> CUT <input type="checkbox"/></p> <p>0 20</p> <p>BANDWIDTH</p> <p>FREQUENCY 1K8 2K7 3K9 560 820 1180 1680 27K</p>
--	--	--	---

PROJECT..... ENGINEER..... LEFT CHANNEL TRACK.....

SONG..... DATE..... RIGHT CHANNEL TRACK.....

NOTES.....

MANLEY

POWER IN IN

GAIN 0 +4 -4 -8

LOW PASS OFF 18K 9K 7K5 6K

HIGH PASS OFF 22 33 47 68 100 150 220 330 470 680 1K 1.5K 2K

MASSIVE PASSIVE STEREO EQUALIZER

<p>22 ± 1K</p> <p>BOOST <input type="checkbox"/> SHELF <input type="checkbox"/> OUT <input type="checkbox"/> CUT <input type="checkbox"/></p> <p>0 20</p> <p>BANDWIDTH</p> <p>FREQUENCY 100 150 220 330 470 680 1K 1.5K 2K</p>	<p>82 ± 3K9</p> <p>BOOST <input type="checkbox"/> SHELF <input type="checkbox"/> OUT <input type="checkbox"/> CUT <input type="checkbox"/></p> <p>0 20</p> <p>BANDWIDTH</p> <p>FREQUENCY 270 390 560 820 1180 1680 2K7 3K9 6K8</p>	<p>220 ± 10K</p> <p>BOOST <input type="checkbox"/> SHELF <input type="checkbox"/> OUT <input type="checkbox"/> CUT <input type="checkbox"/></p> <p>0 20</p> <p>BANDWIDTH</p> <p>FREQUENCY 680 880 1K 1K5 2K2 3K3 4K7 6K8 10K</p>	<p>560 ± 27K</p> <p>BOOST <input type="checkbox"/> SHELF <input type="checkbox"/> OUT <input type="checkbox"/> CUT <input type="checkbox"/></p> <p>0 20</p> <p>BANDWIDTH</p> <p>FREQUENCY 1K8 2K7 3K9 560 820 1180 1680 27K</p>
--	--	--	---

PROJECT..... ENGINEER..... LEFT CHANNEL TRACK.....

SONG..... DATE..... RIGHT CHANNEL TRACK.....

NOTES.....

Free Manuals Download Website

<http://myh66.com>

<http://usermanuals.us>

<http://www.somanuals.com>

<http://www.4manuals.cc>

<http://www.manual-lib.com>

<http://www.404manual.com>

<http://www.luxmanual.com>

<http://aubethermostatmanual.com>

Golf course search by state

<http://golfingnear.com>

Email search by domain

<http://emailbydomain.com>

Auto manuals search

<http://auto.somanuals.com>

TV manuals search

<http://tv.somanuals.com>