



marantz[®]

5 Disc CD Changer

CC4003

User Guide



The lightning flash with arrowhead symbol within an equilateral triangle is intended to alert the user to the presence of uninsulated "dangerous voltage" within the product's enclosure that may be of sufficient magnitude to constitute a risk of electric shock to persons.



The exclamation point within an equilateral triangle is intended to alert the user to the presence of important operating and maintenance (servicing) instructions in the literature accompanying the product.

WARNING

TO REDUCE THE RISK OF FIRE OR ELECTRIC SHOCK, DO NOT EXPOSE THIS APPLIANCE TO RAIN OR MOISTURE.

CAUTION: TO PREVENT ELECTRIC SHOCK, MATCH WIDE BLADE OF PLUG TO WIDE SLOT, FULLY INSERT.

ATTENTION: POUR EVITER LES CHOCS ELECTRIQUES, INTRODUIRE LA LAME LA PLUS LARGE DE LA FICHE DANS LA BORNE CORRESPONDANTE DE LA PRISE ET POUSSER JUSQU'AU FOND.

LASER SAFETY

This unit employs a laser. Only a qualified service person should remove the cover or attempt to service this device, due to possible eye injury.

CAUTION : USE OF CONTROLS OR ADJUSTMENTS OR PERFORMANCE OF PROCEDURE OTHER THAN THOSE SPECIFIED HEREIN MAY RESULT IN HAZARDOUS RADIATION EXPOSURE.

NOTE:

This equipment has been tested and found to comply with the limits for a Class B digital device, pursuant to Part 15 of the FCC Rules. These limits are designed to provide reasonable protection against harmful interference in a residential installation. This equipment generates, uses and can radiate radio frequency energy and, if not installed and used in accordance with the instructions, may cause harmful interference to radio communications. However, there is no guarantee that interference will not occur in a particular installation. If this equipment does cause harmful interference to radio or television reception, which can be determined by turning the equipment off and on, the user is encouraged to try to correct the interference by one or more of the following measures:

- Reorient or relocate the receiving antenna.
- Increase the separation between the equipment and receiver.
- Connect the equipment into an outlet on a circuit different from that to which the receiver is connected.
- Consult the dealer or an experienced radio/TV technician for help.

NOTE:

Changes or modifications may cause this unit to fail to comply with Part 15 of the FCC Rules and may void the user's authority to operate the equipment.

This Class B digital apparatus complies with Canadian ICES-003.

Cet appareil numerique de la Classe B est conforme a la norme NMB-003 du Canada.

IMPORTANT SAFETY INSTRUCTIONS

READ BEFORE OPERATING EQUIPMENT

This product was designed and manufactured to meet strict quality and safety standards. There are, however, some installation and operation precautions which you should be particularly aware of.

1. Read these instructions.
2. Keep these instructions.
3. Heed all warnings.
4. Follow all instructions.
5. Do not use this apparatus near water.
6. Clean only with dry cloth.
7. Do not block any ventilation openings. Install in accordance with the manufacturer's instructions.
8. Do not install near any heat sources such as radiators, heat registers, stoves, or other apparatus (including amplifiers) that produce heat.
9. Do not defeat the safety purpose of the polarized or grounding-type plug. A polarized plug has two blades with one wider than the other. A grounding type plug has two blades and a third grounding prong. The wide blade or the third prong are provided for your safety. If the provided plug does not fit into your outlet, consult an electrician for replacement of the obsolete outlet.
10. Protect the power cord from being walked on or pinched particularly at plugs, convenience receptacles, and the point where they exit from the apparatus.
11. Only use attachments/accessories specified by the manufacturer.
12. Use only with the cart, stand, tripod, bracket, or table specified by the manufacturer, or sold with the apparatus. When a cart is used, use caution when moving the cart/apparatus combination to avoid injury from tip-over.



13. Unplug this apparatus during lightning storms or when unused for long periods of time.
14. Refer all servicing to qualified service personnel. Servicing is required when the apparatus has been damaged in any way, such as power-supply cord or plug is damaged, liquid has been spilled or objects have fallen into the apparatus, the apparatus has been exposed to rain or moisture, does not operate normally, or has been dropped.

Additional Safety Information!

- This product should not be placed in a built-in installation such as a bookcase or rack unless proper ventilation is provided or the manufacturer's instructions have been adhered to.
- Apparatus shall not be exposed to dripping or splashing and that no objects filled with liquids, such as vases, shall be placed on the apparatus.
- When the switch is in the OFF position, the apparatus isn't completely switched-off from the MAINS.
- The equipment shall be installed near the power supply so that the power supply is easily accessible.
- Do not expose the unit to excessive heat such as direct sunlight, fire or the like.

Thank you for choosing the Marantz product.
 Please read this User Guide thoroughly to ensure proper operation and installation before using this product.
 After reading this User Guide, be sure to keep this for your future reference.

ACCESSORIES CHECK

Before use, check the below accessories were included in the package.

- Remote controller 1

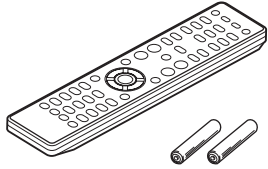

- AAA-size batteries 2
- AC power cord 1
- Audio connecting cable 1

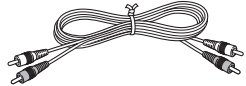

- Remote control connecting cable 1

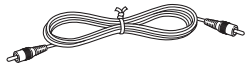

- User guide 1
- Warranty card (U.S.A. x 1, Canada x 1)

CONTENTS

FEATURES	2	TROUBLESHOOTING	13
BEFORE USING	2	GENERAL	13
EQUIPMENT MAINS WORKING SETTING	2	DISC PLAYBACK	13
INAPPROPRIATE PLACES FOR INSTALLATION	2	OTHERS	14
PRECAUTIONS	2	ABOUT WMA PLAYBACK	14
NOTES FOR REMOVING SHIPPING SCREWS	2	ABOUT MP3 PLAY BACK	14
USAGE OF REMOTE CONTROLLER	3	PLAYING CD-R/CD-RW DISCS	14
NAMES AND FUNCTIONS	4	ABOUT PLAYING COPY-CONTROLLED CDs	14
FRONT PANEL	4	ABOUT DUALDISC PLAYBACK	14
DISPLAY	4	SPECIFICATIONS	15
REMOTE CONTROLLER	5	DIMENSIONS	15
REAR PANEL	6	NOTES ABOUT THE DISCS	16
BASIC CONNECTIONS	6	CLEANING OF EQUIPMENT EXTERNAL SURFACES ..	16
CONNECTING TO AN AMPLIFIER	6	REPAIRS	16
CONNECTING THE POWER SUPPLY	6		
BASIC OPERATIONS	7		
NORMAL PLAYBACK	7		
CHANGE DISCS WHILE PLAYING	7		
PLAYING YOUR FAVORITE TRACKS OF A DISC	8		
PLAYING YOUR FAVORITE PARTS OF A TRACK	8		
ADVANCED CONNECTIONS	8		
CONNECTING TO A DIGITAL AUDIO COMPONENT ..	8		
REMOTE CONTROL CONNECTION	8		
CONNECTING OTHER EQUIPMENT	9		
ADVANCED OPERATIONS	9		
SWITCHING PLAYING TIME DISPLAY	9		
REPEAT PLAY	9		
PLAYING TRACKS IN A RANDOM SEQUENCE (RANDOM PLAY)	10		
PLAYING TRACKS IN A SPECIFIC SEQUENCE (PROGRAM PLAY)	10		
DISPLAY WINDOW BRIGHTNESS ADJUSTMENT ..	11		
REMOTE CONTROL CODE SETTING	12		

NAMES AND FUNCTIONS
 BASIC CONNECTIONS
 BASIC OPERATIONS
 ADVANCED CONNECTIONS
 ADVANCED OPERATIONS
 TROUBLESHOOTING
 OTHERS

FEATURES

SUPPORTS MP3 AND WMA FILE PLAYBACK

MP3 and WMA files that have been recorded onto CD-R or CD-RW discs can be played back on this CD player. (See page 14)

WHILE PLAYING A DISC, FOUR OTHER DISCS CAN BE CHANGED

DIRECT DISC ACCESS BUTTON

Direct Disc Access button is equipped both on the front panel of the unit and on the remote controller for one-touch disc change to any of the 5 discs in the unit.

VARIOUS PLAY MODES SUCH AS RANDOM, PROGRAM AND REPEAT

HEADPHONE JACK WITH VOLUME

RS-232C CONTROL PORT AND IR FLASHER INPUT

RS-232C port which supports both unit control and operating status transmission is equipped to enable central control with custom installation. Also, Flasher input is equipped to realize wired control when you cannot use remote control due to the installation on the rack, etc.

5 SETS OF BUILT-IN REMOTE CONTROL CODES

Because there are 5 sets of built-in remote control code signals for between the unit and remote controller, up to 5 units installed in the same place can be remotely controlled independently.

ALUMINUM FRONT PANEL

Hairline finish aluminum front panel is used for quality look.

BEFORE USING

EQUIPMENT MAINS WORKING SETTING

Your Marantz product complies with the household power and safety requirements in your area. This product can be powered by 120 V AC only.

INAPPROPRIATE PLACES FOR INSTALLATION

To keep your unit in perfect working order for the longest possible time, avoid installing the unit in the following locations.

- Wherever it will be exposed to direct sunlight
- Wherever it will be close to a heater or other heat-radiating appliance
- Wherever the humidity is high or ventilation is poor
- Wherever it is very dusty
- Wherever it will be subject to vibration
- On top of a rickety stand or in an unstable location which is tilted at an angle
- Near windows where there is a chance of exposure to rain, etc.
- On top of an amplifier or other component which dissipates a great deal of heat

To ensure proper heat dissipation, install the unit while leaving clearances between the unit and wall or other components, as shown in the figure below.

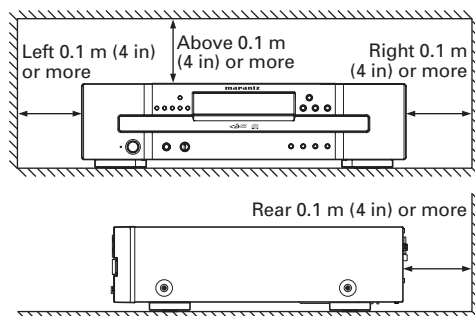

DO NOT PLACE OBJECTS ON TOP

Refrain from placing any objects on top of the unit.

PRECAUTIONS

- In winter, droplets of water form on the insides of the windows of a heated room: this is called condensation. This unit uses an optical lens, so the condensation may form in the following cases.

- In a room immediately after the heating has been turned on
- In a room where the humidity level is high
- When the unit has been suddenly brought from a cold location into a warm room

Since, in cases like this, the track numbers may not be read and the unit is prevented from operating properly, wait about 30 minutes, and then operate the unit.

- If this unit is placed on an object that generates substantial heat, such as an amplifier, the laser inside this unit may be deteriorated.
- This unit may cause interference on a tuner or TV set. If this is the case, place it further away from the tuner or TV set.
- Compact discs have much less noise than analog records and hardly any noise is heard before play starts. Bear in mind, therefore, that if the volume control on the amplifier is set too high, you will risk damaging other audio components.
- This unit cannot play CD-ROMs used with personal computers, game CDs, video CDs, DVDs (video/audio) or DTS-CDs.
- We do not recommend the use of lens cleaners.
- If this unit is placed in a rack with glass doors, do not attempt to open the disc tray with the **▲ OPEN/CLOSE** button on the remote controller with the glass doors shut. Impeded disc-tray movement may result in a failure.

NOTES FOR REMOVING SHIPPING SCREWS

At the bottom of the player there are two red shipping screws for use when the player is transported. Before using the player, turn these screws counterclockwise and remove them.

If the shipping screws are still in place and the power is turned on, unplug the power cord from the power outlet and remove the shipping screws. Retain these screws as they will be needed when the player is transported.

Before transporting the player, take out the discs, close the disc tray, set to standby mode and unplug the power cord from the power outlet. Then install the shipping screws by turning them clockwise. Be sure to fasten them securely.

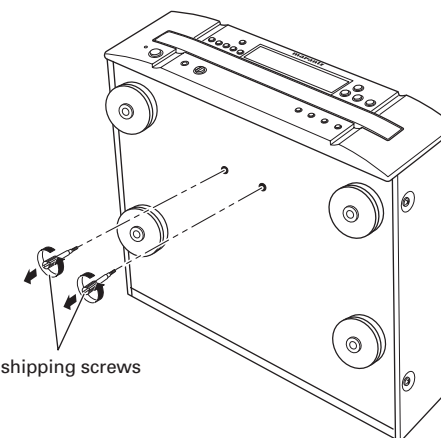

USAGE OF REMOTE CONTROLLER

LOADING BATTERIES

Before using the remote controller for the first time, load the batteries in the remote controller. The batteries provided are used to verify the operations of the remote controller only.

1. Remove the battery cover.
2. Paying close attention to polarity indicators (+ plus and - minus), be sure to insert batteries correctly and as indicated.
3. Return the battery cover to its original position.

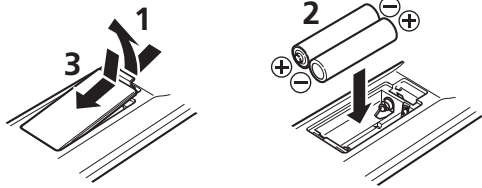

CAUTIONS ON HANDLING BATTERIES

Misusing batteries can lead to fire, injury or soiling of surrounding area as a result of leakage, rupture or corrosion.

Carefully read the following precautions before using batteries.

- Insert the batteries while ensuring that their \oplus and \ominus poles are properly aligned with the corresponding markings on the remote controller.
- Batteries of the same size and shape may have different voltages. Do not use any battery except the type indicated. Do not use old and new batteries together, and do not use different types of batteries together.
- Do not recharge batteries.
- Keep batteries out of the reach of children. Seek medical attention if accidentally ingested.
- Do not carry or store batteries together with metal ball point pens, necklaces, coins, hair pins, etc.
- If you will not be using the remote controller for an extended time (1 month or more), remove the batteries to prevent leakage. If batteries leak, do not touch the fluid with bare hands. Wipe away any fluid in the case and put in new batteries. When doing so, handle with care, because fluid on skin or clothing presents a burn risk. If you accidentally get fluid on your skin, immediately wash with water and seek medical attention.
- Do not heat or take apart batteries or put them in flame or water.

- When disposing of used batteries, please comply with governmental regulations or environmental public instruction's rules that apply in your country or area.
- Do not expose the batteries to excessive heat such as direct sunlight, fire or the like.

OPERATIONAL RANGE

Operate the unit with the remote controller within the range of the illustration below.

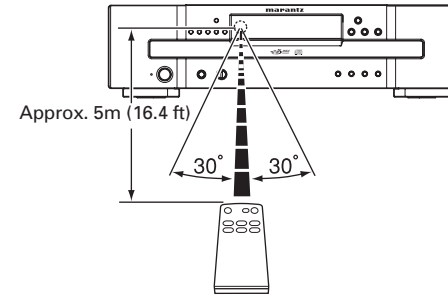

PRECAUTIONS

- Do not allow direct sunlight, an inverter fluorescent light or other strong source of light to shine onto the unit's infrared signal reception window (remote sensor). Otherwise, the operation of the remote controller may be disabled.
- Bear in mind that operating the remote controller may cause other devices operated by infrared rays to be operated by mistake.
- The remote controller cannot be operated if the space between the controller and the unit's remote sensor is obstructed.
- Do not place any objects on top of the remote controller. Doing so may cause one or more buttons to be held down which will cause the batteries to run down.

NAMES AND FUNCTIONS

FRONT PANEL

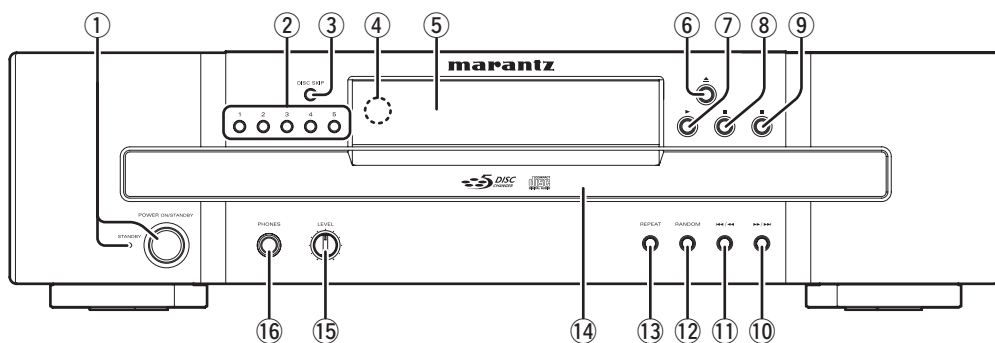

① POWER ON/STANDBY switch STANDBY indicator

This is used to switch the unit's power ON and STANDBY. (See page 7)

② 1-5 button

Choose a disc to play.

③ DISC SKIP button

When this button is pressed while multiple discs are placed on the tray, a disc to play can be chosen with rotating the tray clockwise. (See page 7)

④ Remote sensor

This sensor senses the infrared control signals sent from the remote controller.

⑤ Display

⑥ ▲ button

See page 7.

⑦ ► button

See page 7.

⑧ ■ button

See page 7.

⑨ II button

See page 7.

⑩ ►►/►►► button

See page 8.

⑪ I◀◀/◀◀ button

See page 8.

⑫ RANDOM button

Playback tracks randomly. (See page 10)

⑬ REPEAT button

Playback a track or disc repeatedly. (See page 9)

⑭ Disc tray

The disc to be played is placed on the tray (see page 7).

⑮ LEVEL control

This is used to adjust the headphones volume level. The level increases when turned clockwise.

⑯ PHONES jack

The headphones are connected to this jack. Use headphones that come with a standard plug.

DISPLAY

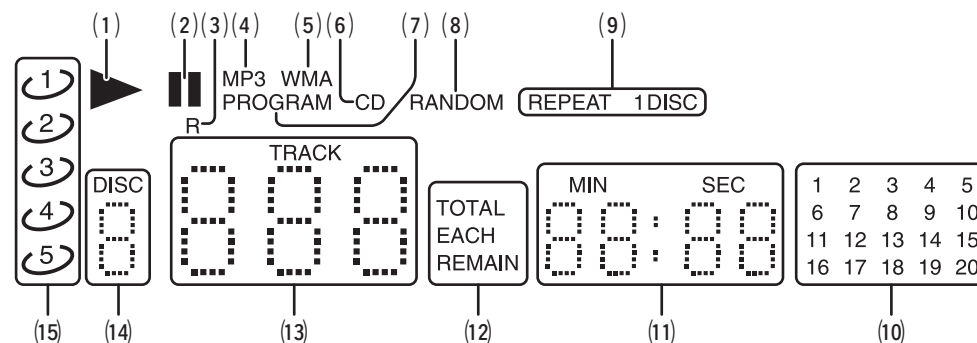

(1) ► (Play) indicator

This lights during disc play.

(2) II (Pause) indicator

This lights when play is paused.

(3) Remote Control indicator

This lights during a remote controller is operated.

(4) MP3 indicator

This lights during MP3 file play.

(5) WMA indicator

This lights during WMA file play.

(6) CD indicator

This lights during Audio CD play.

(7) PROGRAM indicator

This lights during program play.

(8) RANDOM indicator

This lights during random play.

(9) REPEAT indicator

This lights during repeat play.

(10) 1-20 (track number display)

Displays the number of tracks recorded in a disc, the number of remaining tracks, and the number of tracks programmed with program play.

- Cannot display more than 20 tracks.

(11) Time indicator

Displays the time.

(12) REMAIN indicator

This lights while displaying track and disc remaining times.

(13) Track Number indicator

Displays the track number chosen.

(14) Disc Number indicator

Displays the disc number chosen.

(15) Disc indicator

Displays the disc numbers on the tray.

REMOTE CONTROLLER

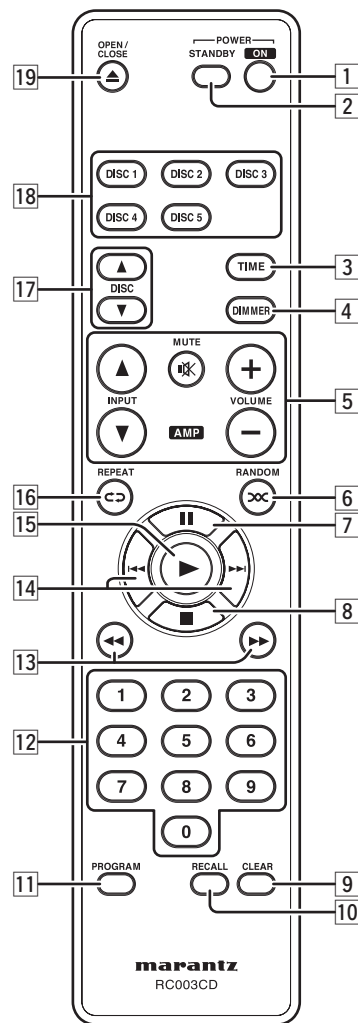
**1 ON button**

When this button is pressed while the unit is in standby status, the power of the unit is turned on. (See page 7)

2 STANDBY button

When this button is pressed while the power is on, the unit goes into the standby status.

3 TIME button

This button is used to switch the time display. (See page 9)

4 DIMMER button

This button is used to adjust the brightness of the display window. (See page 11)

**5 +, - (VOLUME) button
▲, ▼ (INPUT) button
MUTE button**

These are used to operate the corresponding functions of a Marantz integrated amplifier. For each function, refer to User Guide supplied with the Integrated Amplifier.

6 RANDOM button

Playback tracks randomly. (See page 10)

7 II button

See page 7.

8 ■ button

See page 7.

9 CLEAR button

This is used to cancel the programmed tracks. (See page 11)

10 RECALL button

Use this button to check the programmed tracks while programming or stopped programming. (See page 11)

11 PROGRAM button

This button is for program play. (See page 10)

12 Numeric buttons

See page 8.

13 ◀▶ buttons

See page 8.

14 |◀▶| buttons

See page 8.

15 ▶ button

See page 7.

16 REPEAT button

Playback a track or disc repeatedly. (See page 9)

17 DISC ▲, ▼ button

When multiple discs are placed on the tray, the tray can be rotated and a disc to be played can be chosen by pressing one of these buttons. (See page 7)

18 DISC1-DISC5 button

Choose a disc to play. (See page 8, 10)

19 ▲ button

See page 7.

NAMES AND FUNCTIONS

REAR PANEL

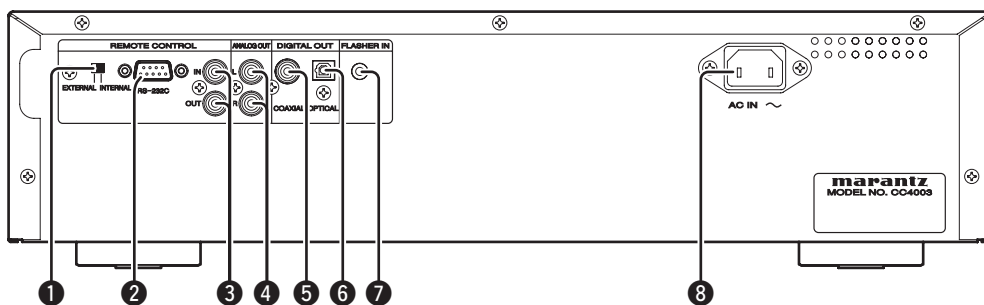

1 EXTERNAL/INTERNAL switch

The switch is set to INTERNAL, when first purchased, enabling the unit's built-in signal reception window to be used.

Before using the supplied connecting cable to make the connection between the unit and the remote control connectors on a Marantz equipment, set the switch to EXTERNAL.

Note

Signals cannot be received from the remote controller if the switch is kept at EXTERNAL when the unit is to be used on its own.

2 RS-232C connector

A control port for professionals (custom installers).

3 REMOTE CONTROL IN and OUT connectors

Using the supplied remote control connecting cable, these connectors enable this unit to be connected to a Marantz component equipped with remote control connectors. These connections make it possible to control an entire system that centers on the amplifier or other such component.

4 ANALOG OUT connectors

The music signals during play are output from these connectors.

5 DIGITAL AUDIO OUT COAXIAL connector

The music signals during play are output digitally from this coaxial output connector.

6 DIGITAL AUDIO OUT OPTICAL connector

The music signals during play are output digitally from this optical output connector.

7 FLASHER IN connector

A control port for professionals (custom installers).

This is used to control the unit from other rooms using keypad, etc.

8 Power cord connector socket

Use the supplied power cord to connect to a standard household power supply outlet.

Connect the unit so that the power cord can be removed easily as a precaution against possible accidents.

BASIC CONNECTIONS

CONNECTING TO AN AMPLIFIER

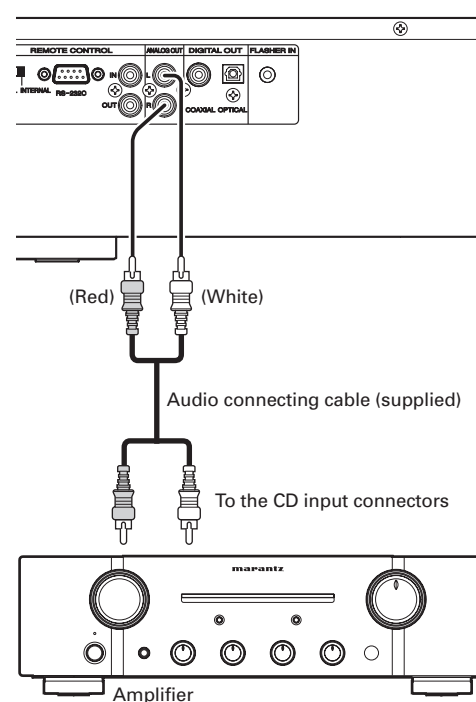

Notes

- Do not connect this unit and other components to mains power until all connections between components have been completed.
- Insert all plugs and connectors securely. Incomplete connections may make noise.
- Be sure to connect the left and right channels properly.
- Be sure to connect input and output properly.
- Refer to the instructions for each component that is connected to this unit.
- Do not bind audio/video connection cables with power cord and speaker cables this will result in generating a hum or other noise.
- Do not connect the unit to the PHONO input connectors on the amplifier.

CONNECTING THE POWER SUPPLY

1. Plug the power cord into AC IN jack on the rear panel.

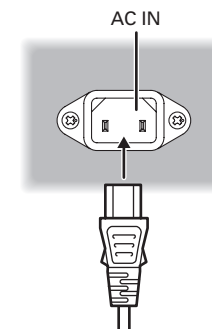

2. Plug the power cord into an AC outlet.
3. Turn on the power switch of the audio unit (amplifier, etc.) that is connected with this unit. Set the selector on the connected unit to this unit.

BASIC OPERATIONS

NORMAL PLAYBACK

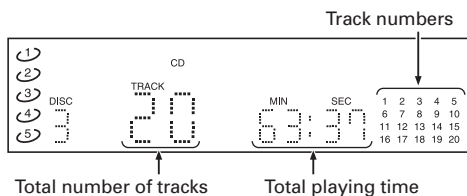
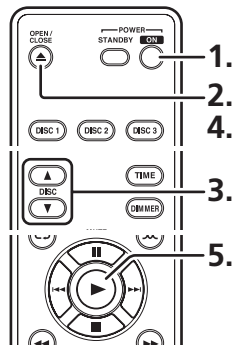
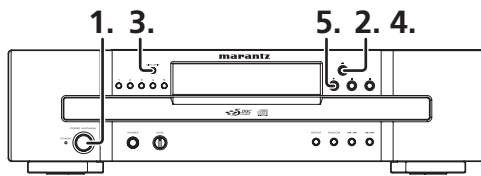

1. Press the **POWER** button on the unit or on the remote controller to turn on the power.
2. Press **▲** button on the unit or remote controller to open the disc tray. Hold the edge of the disc and place on the tray.

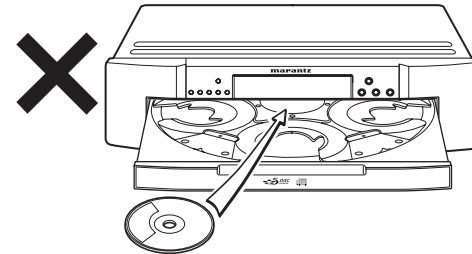
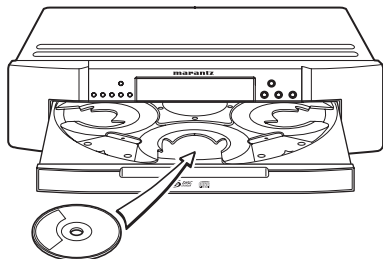

Caution

- Place a disc on each tray correctly. If not, the unit cannot be operated and discs may be damaged.
- Be careful not to have your finger caught when you close the tray. If the finger is caught, press **▲** button to open the tray.
- Do not insert a disc in the way shown as the arrow.

3. To set multiple discs, press **DISC SKIP** button on the unit or **DISC ▲** or **▼** button on the remote controller. With the turn table on the tray rotating, set the disc one by one.
4. Press **▲** button on the unit or remote controller to close the disc tray.
5. When **▶** button on the unit or remote controller is pressed, playback starts from the first track.
 - At this time, "▶" lights up on the display window.
 - All discs are played

(example) To start playback from the disc 2

- Disc 2/first track →.....→ last track
- Disc 3/first track →.....→ last track
- Disc 4/first track →.....→ last track
- Disc 5/first track →.....→ last track
- Disc 1/first track →.....→ last track
- Stop

- Do not touch the signal surface of a disc.
- To play a single CD (8 cm), place the disc with the indentation at the center of the tray.
- Do not place any other media other than a disc on the tray.
- Do not pile up discs on a tray. Do not place more than two disc on a tray.
- Do not force to open/close the tray. Always use **▲** button to open/close the tray.
- While the tray is open and rotating, do not touch or stop the tray with fingers.

PAUSE PLAYBACK

Pressing **||** button on the unit or remote controller pauses the play.

- At this time, "||" lights up on the display window.
- To restart the playback, press **▶** button on the unit or remote controller.
- Pressing **||** button on the unit or remote controller again while pausing restarts the playback.

STOP PLAYBACK

Pressing **■** button on the unit or remote controller stops the playback.

CHANGE DISCS WHILE PLAYING

You can change other discs not being played while playing a disc.

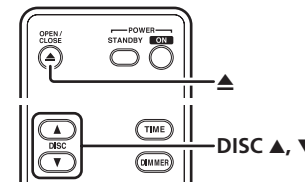
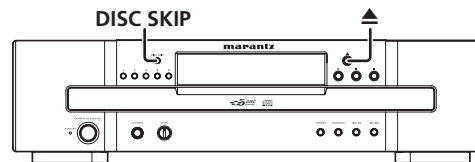

- While disc 1 is playing, press **▲** button to open the tray and change disc 2, 3, and 4.
- To change disc 5, press **DISC SKIP** button on the unit or **DISC ▲** or **▼** button on the remote controller to rotate the turntable on the tray, then change the disc.
- After changing the disc, make sure to press **▲** button to close the disc tray.

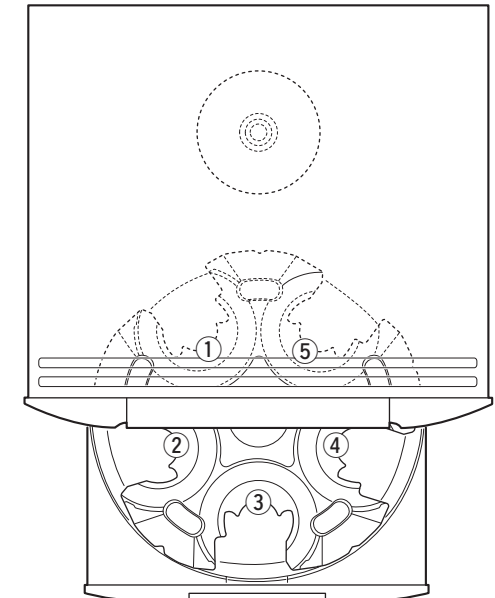

- ①...Disc 1 tray
- ②...Disc 2 tray
- ③...Disc 3 tray
- ④...Disc 4 tray
- ⑤...Disc 5 tray

BASIC OPERATIONS

PLAYING YOUR FAVORITE TRACKS OF A DISC

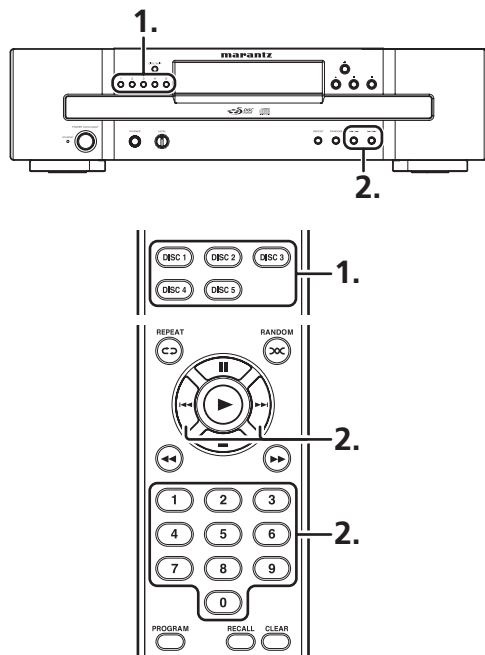

1. Press **DISC1-5** button on the unit or remote controller to choose the disc to play.
 - At this time the first track of the chosen disc is played.
2. Press **◀◀/▶▶** button on the unit, or **◀◀**, **▶▶** or **0-9** button on the remote controller to choose the track number to play.

(example)

- To choose the 9th track: Press **9**.
- To choose the 23rd track: Press **2**, and within 1 seconds press **3**.
- To choose the 123rd track: Press **1**, within 1 seconds press **2**, and within 1 seconds press **3**.

PLAYING YOUR FAVORITE PARTS OF A TRACK

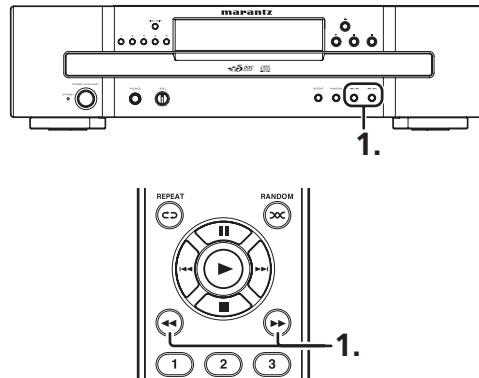

1. Hold **◀◀**, **▶▶** button on the remote controller or **◀◀/▶▶** button on the unit while playing to search the part to play.
2. Release the button when you have found the part.

ADVANCED CONNECTIONS

CONNECTING TO A DIGITAL AUDIO COMPONENT

The unit has one digital optical output connector and one digital coaxial output connector. You can enjoy digital recording when the unit is connected to a CD recorder or other digital recording component.

CONNECTING THE OPTICAL/COAXIAL OUTPUT CONNECTORS

Use an optical/coaxial digital connecting cable available on the market. Insert the plug of the optical digital connecting cable firmly in until it clicks into place. Do not bend or bundle the optical digital connecting cable.

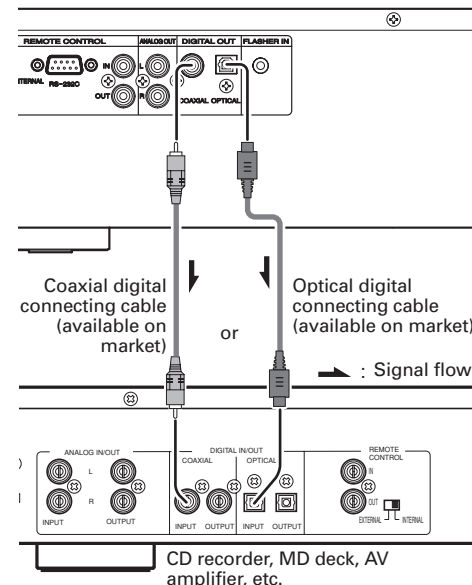

REMOTE CONTROL CONNECTION

Connecting this unit to additional Marantz audio equipment using the supplied remote control connecting cable enables remote control of the connected equipment as a single audio system.

- When connecting equipment incorporating a remote sensor, connect the "remote control out" connector of the equipment to the "remote control in" jack of the unit. When doing this, set this unit's switch to **"EXTERNAL."** This will stop its remote control IR receiver from operating and the unit can now be controlled via the remote control IR receiver of the attached equipment.

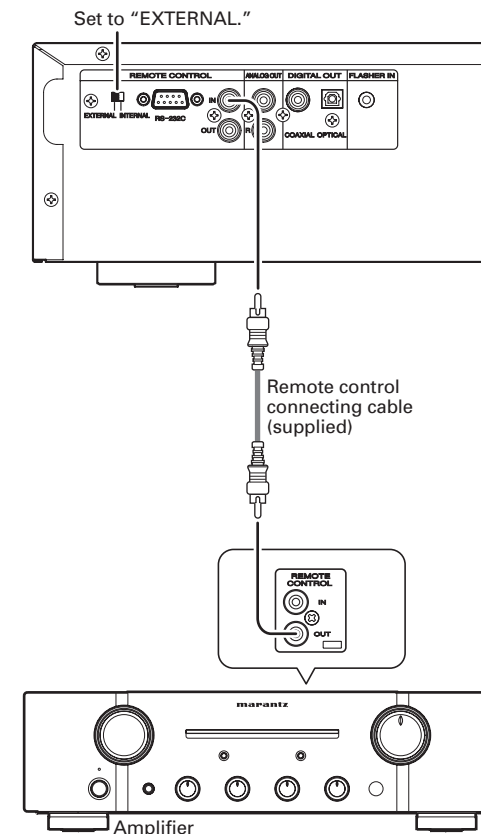

ADVANCED CONNECTIONS

CONNECTING OTHER EQUIPMENT

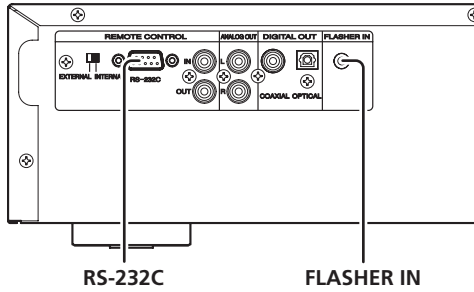

RS232C

Connect an external control device or other device for servicing. (Use a straight cable for the connection.)

FLASHER IN

This unit can be controlled by connecting a control box or other control device to this unit.

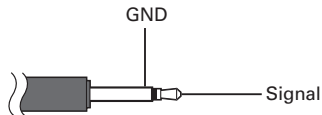

ADVANCED OPERATIONS

SWITCHING PLAYING TIME DISPLAY

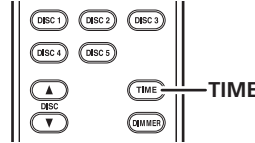

Each time **TIME** button on the remote controller is pressed, the display of the playing time changes as follows:

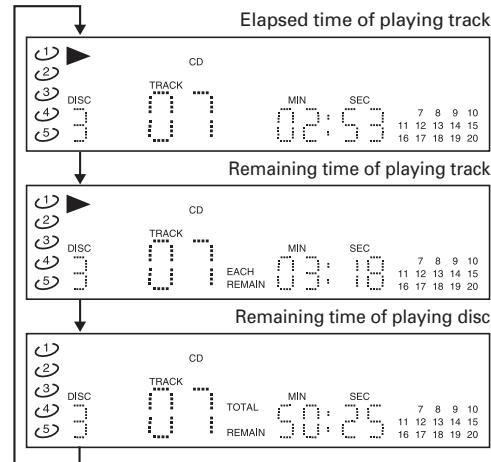

- While an MP3 or WMA file is being played, the remaining time of playing disc will not be displayed.
- During all disc random play, disc remaining time will not be displayed.
- When a program is set up using tracks from only currently selected disc the amount of time remaining in the program is displayed. (Except for MP3 and WMA discs)
- If the total playback time of the tracks programmed exceeds 99 minutes 59 seconds, “- : -” is displayed for the remaining program time.

REPEAT PLAY

Repeat play is a function to automatically play repeatedly.

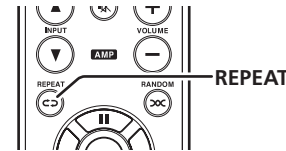
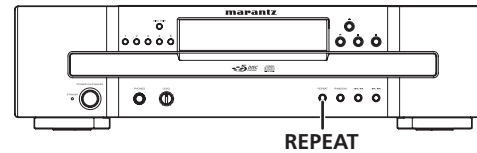

Each time **REPEAT** button on the unit or remote controller is pressed, the Repeat mode changes as follows:



ONE TRACK REPEAT PLAY

Play the chosen track repeatedly.

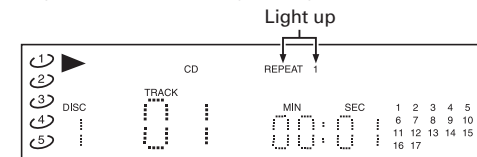

After choosing a track to repeat, press **REPEAT** button on the unit or remote controller once to play the chosen track repeatedly.

- At this time, “**REPEAT 1**” lights up.

ONE DISC REPEAT PLAY

Play the chosen disc repeatedly.

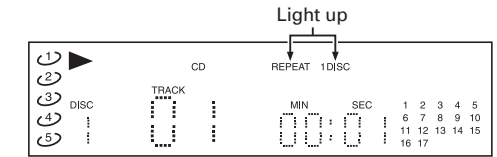

After choosing a disc to repeat, press **REPEAT** button on the unit or remote controller twice to play the tracks of the chosen disc repeatedly.

- At this time, “**REPEAT 1 DISC**” lights up.

ALL DISC REPEAT PLAY

Repeat play all discs on the disc tray.

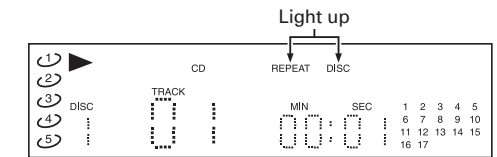

When **REPEAT** button on the unit or remote controller is pressed three times, all discs are played repeatedly.

- At this time, “**REPEAT DISC**” lights up.

STOP REPEAT PLAY

Press the **REPEAT** button on the unit or on the remote control until “**REPEAT**” disappears.

Caution

If **▲** button is pressed during stop and the disc tray is opened, repeat playback is canceled.

ADVANCED OPERATIONS

PLAYING TRACKS IN A RANDOM SEQUENCE (RANDOM PLAY)

Random play is a function to play tracks in random sequence.

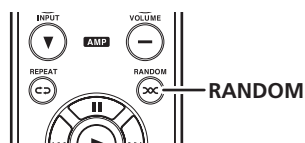
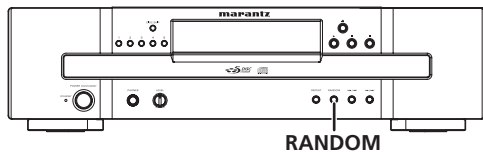

ONE DISC RANDOM PLAY

Random play the chosen disc only.

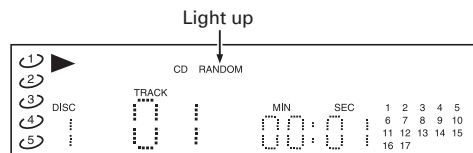

1. Press **RANDOM** button on the unit or remote controller.
 - At this time, "RANDOM" lights up.
2. Press any of the **DISC 1-5** buttons on the unit or remote controller to choose the disc to be played. Press **▶** button on the unit or remote controller.
 - One track is randomly chosen from the selected disc and played.

ALL DISC RANDOM PLAY

Random play all discs on the disc tray.

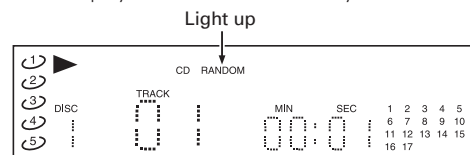

1. Press **RANDOM** button on the unit or remote controller.
 - At this time, "RANDOM" lights up.
2. Press **▶** button on the unit or remote controller.
 - A track is chosen from all discs and played.
 - After playing the track, another track is chosen from all discs randomly and played.

STOP RANDOM PLAY

When random playback is set, press **RANDOM** button on the unit or remote controller.

- At this time, the "RANDOM" indication disappears and random playback is canceled.

Caution

- When **RANDOM** button is pressed while a program is being played, programmed tracks are played in random sequence.
- If **▲** button is pressed during random playback and the tray is opened, random playback is canceled.
- Random playback cannot be started while the tray is open during playback.

PLAYING TRACKS IN A SPECIFIC SEQUENCE (PROGRAM PLAY)

You can choose tracks or discs to play and program them in the order you want to listen.

Up to 50 tracks can be registered for program play.

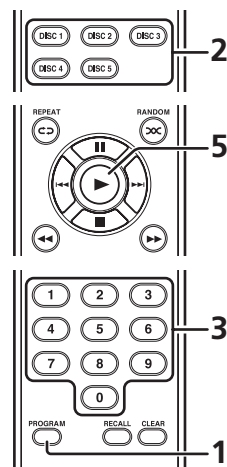
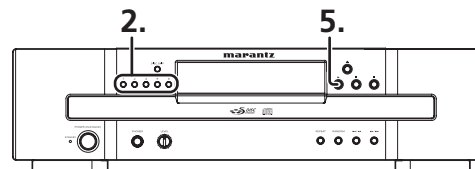

1. While the unit is stopped, press **PROGRAM** button on the remote controller to switch to the Program mode.
 - At this time, "PROGRAM" lights up.

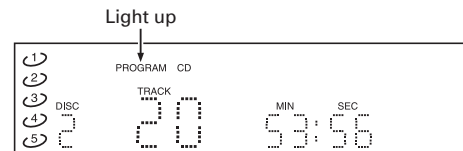

2. Press any of the **DISC 1-5** buttons on the unit or remote controller to choose a disc where the tracks to register are contained. In this example choose disc 2. (Total number of tracks: 20)
 - At this time, the chosen track number lights up.

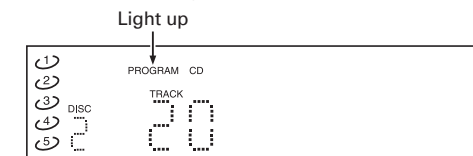

3. Use the Numerical buttons on the remote controller to choose the track number to register. In this example choose track 7.
 - At this time, the chosen track number lights up.

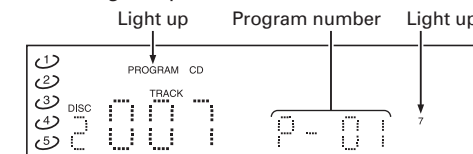

Total playback time of the tracks programmed

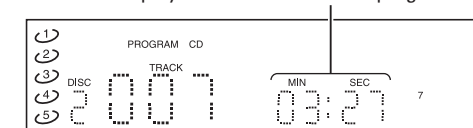

- If programming is performed across several discs, the total playback time is displayed as "-- : --".
- If the total playback time of the tracks programmed exceeds 99 minutes 59 seconds, "-- : --" is displayed.
- When a program is setup with an MP3 or WMA disc, "-- : --" is displayed for the total time.

4. To program multiple tracks, repeat the steps 2. and 3. until all the tracks to be played are programmed.
5. Press ► button on the unit or remote controller to start the program play.

TO RETURN TO NORMAL PLAYBACK

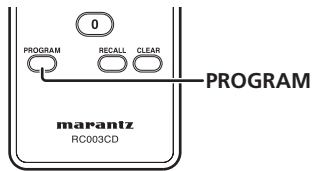

To return to normal playback during program play, press **PROGRAM** button. At this time, the "PROGRAM" indication disappears and normal playback starts from the track being played.

CHECK THE PROGRAM

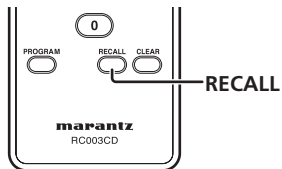

During Program mode (the "PROGRAM" indication is lit), press **RECALL** button on the remote controller.

- Each time **RECALL** button is pressed the programmed tracks are displayed one by one.

CLEAR PROGRAMMED TRACKS

TO CLEAR ONE TRACK AT A TIME

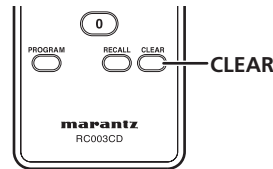

During Program mode, press **CLEAR** button on the remote controller to clear the programmed tracks one by one from the last track.

TO CLEAR WHOLE PROGRAM

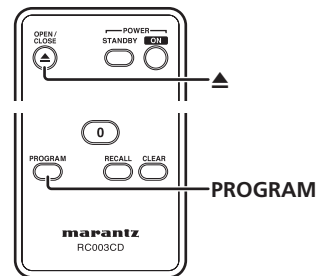
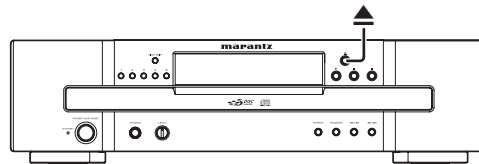

To clear the whole program, press **PROGRAM** button on the unit or remote controller during Program mode so that the PROGRAM indication disappears.

Or press ▲ button and open the disc tray to clear the whole program.

- When the unit switches to standby or power off, the programs are all erased.

DISPLAY WINDOW BRIGHTNESS ADJUSTMENT

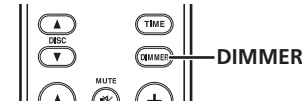

Each time **DIMMER** button on the remote controller is pressed, the display window brightness changes as follows:

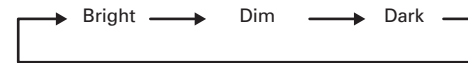

ADVANCED OPERATIONS

REMOTE CONTROL CODE SETTING

- The unit and remote controller have five sets of built-in remote control codes for each. These codes enable up to five CC4003s installed in the same place to be controlled independently.
- To use multiple units at the same time, set the second, third, fourth, and fifth CC4003s and their remote controller' remote control codes.
- To set the codes, follow the procedure below to control only selected unit is remotely controlled.
- At the factory, the unit and remote controller were set to CODE1.

REMOTE CONTROL UNIT SETTING

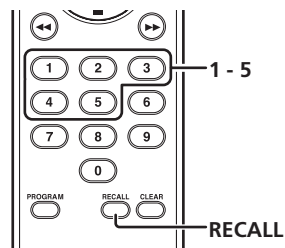

To set CODE2

Press **RECALL** button and Numerical button **2** on the remote controller at a time for five seconds or more.

To set CODE3

Press **RECALL** button and Numerical button **3** on the remote controller at a time for five seconds or more.

To set CODE4

Press **RECALL** button and Numerical button **4** on the remote controller at a time for five seconds or more.

To set CODE5

Press **RECALL** button and Numerical button **5** on the remote controller at a time for five seconds or more.

Caution

*To reset the remote control to CODE1, press **RECALL** button and Numerical button **1** on the remote controller at the same time for five seconds or more.*

CC4003 SETTING

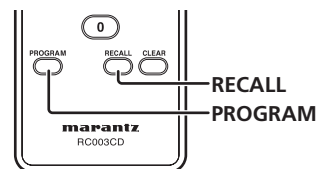

- To synchronize the remote control code of a CC4003 with the corresponding remote controller, simultaneously press the **PROGRAM** and **RECALL** buttons on the remote controller.
- The remote control code set is displayed on the display window on the unit for five seconds, and the setting is completed.

DISPLAY EXAMPLES

- When the remote controller is set to **CODE1**

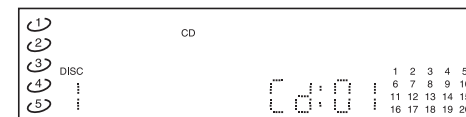

- When the remote controller is set to **CODE2**

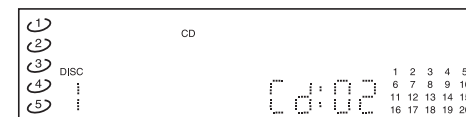

- When the remote controller is set to **CODE3**

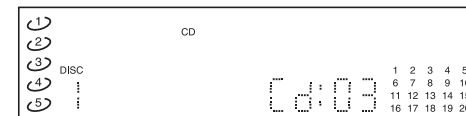

- When the remote controller is set to **CODE4**

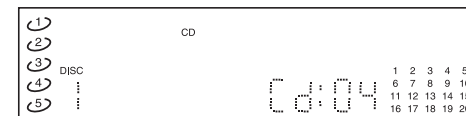

- When the remote controller is set to **CODE5**

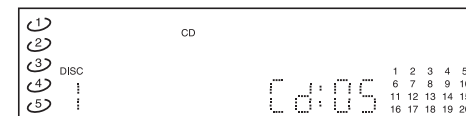

TROUBLESHOOTING

If you have any problem using this product, please be sure to check the items in the following table.

If you trouble cannot be solved, please unplug the power cord immediately and contact your Marantz authorized dealer or service center.

GENERAL

Symptom	Cause	Solution	Page
No power.	The AC power cord is not properly connected.	Plug the AC power cord firmly into the unit.	6
		Plug the AC power plug firmly into a wall outlet.	6
No sound or distorted sound.	The output cables are not firmly connected.	Connect the output cables firmly into the connectors of this unit and the amplifier.	6
	The analog outputs of this unit are connected with the PHONO input connectors of the amplifier.	Do not connect the analog outputs of this unit with the PHONO input connectors of the amplifier.	6
	Improper amplifier operation.	Confirm the input selection, audio volume adjustment, and speaker settings of the amplifier.	6
	Playback of this unit is paused.	Press the Play button.	7
No sound from the connected headphones or distorted sound.	The headphones plug is not firmly connected.	Insert the headphones plug firmly into the headphones jack of this unit.	4
	The headphones level is set to the minimum.	Adjust the headphones level.	4
No digital audio output.	The digital connecting cables are not firmly connected.	Securely connect the digital connecting cables.	8
This unit cannot be controlled with the remote controller.	The batteries of the remote controller are exhausted.	Replace with new batteries.	3
	The remote controller is located outside its operable range.	Check the operable range of the remote controller and use it within that range.	3
	Some object is placed between the unit and remote controller.	Remove the object.	3
	The remote sensor of the unit is exposed to strong light.	Avoid exposing the remote sensor to the strong light.	3
	The EXTERNAL/INTERNAL switch on the rear panel is set to EXTERNAL.	Set the EXTERNAL/INTERNAL switch to INTERNAL.	6

DISC PLAYBACK

Symptom	Cause	Solution	Page
No playback with a disc.	The disc is not loaded properly in the tray.	Load the disc properly.	7
	The disc is placed upside-down. (The label of the disc is facing down.)	Place the disc with its label facing upward.	7
	The disc is dirty.	Clean the disc's surface.	16
	The disc is scratched.	A disc with many scratches may not be playable.	16
	The disc is warped.	The disc may be unable to be played if it is badly warped.	16
	A disc that is not supported by this unit is attempted to be played.	Use a disc that is supported by this unit.	14
	Condensation has formed on the lens inside this unit.	Turn on the unit then wait for about 30 minutes before turning it back on again and using it.	2
No playback with a CD-R/CD-RW disc.	The disc has not been finalized.	Perform finalization of the disc, using writing software.	14
	The recorded data are not in CDDA format for music. Or, an MP3/WMA file has not been recorded properly.	Record data in a proper format supported by this unit.	14

OTHERS

ABOUT WMA PLAYBACK

- Windows Media is a trademark of the Microsoft Corporation in the US and other countries.
- WMA is an abbreviation for “Windows Media Audio” and is an audio compression technology developed by the Microsoft Corporation. WMA data may be encoded using Windows Media® Player Ver. 7, 7.1, Windows Media® Player for Windows® XP, or Windows Media® Player 9 Series.
- Use discs recorded conforming to the ISO 9660 Level 1/Level 2 CD-ROM file system and extended format (Joliet).
- WMA files having DRM copy protection cannot be played.
- Encode WMA files using applications that have received Microsoft Corporation certification. If an uncertified application is used, it may not operate normally.

ABOUT WINDOWS MEDIA DRM

Windows Media Digital Rights Management (DRM) (referred to below as WMDRM) is a platform to prevent playback on computers, digital audio players, network devices and the like in order to securely distribute digital content.

Content protected by WMDRM may be played back only when connected to a media server that has WMDRM functionality.

This system does not comply with any contents protected by WMDRM.

WMA FILES

Standard	Conforming to Microsoft Windows Media Audio 9.2 The following are unsupported <ul style="list-style-type: none"> • WMA9 Series Professional • WMA9 Series Voice • WMA9 Series Lossless • WMA with Video
Extension	.wma
Bit rate [kbps]	48–192
Sampling frequency [kHz]	32/44.1/48
Channels	2ch (Stereo)

ABOUT MP3 PLAY BACK

- Use discs recorded conforming to the ISO 9660 Level 1/Level 2 CD-ROM file system and extended format (Joliet).
- When playing variable bit rate files, it is possible that the playing time may not be displayed accurately.
- For audio quality, a recording rate of 128 kbps or higher is recommended.

MP3 FILES

Standard	MPEG-1 Audio Layer3
Extension	.mp3
Bit rate [kbps]	For MPEG-1 Audio Layer3, 32 - 320
Sampling frequency [kHz]	For MPEG-1 Audio Layer3, 32/44.1/48
Channels	2 ch (Stereo)
Emphasis	OFF

PLAYING CD-R/CD-RW DISCS

This unit can play back the CD-RW (ReWritable) discs as well as ordinary Audio CD and CD-R (Recordable) discs.

- The CD-R and CD-RW discs should contain properly-recorded TOC* information so that they can be played back. In CD recorders, the task of writing TOC information is referred to as finalizing the disc. Discs that are not finalized cannot be properly recognized as an Audio CD and played back by regular CD players and Super Audio CD players. For details, please read the instruction manual provided with a CD recorder.

* TOC stands for Table Of Contents and contains information such as the total number of tracks and total playing time of the disc.

- This unit can play CD format, and CD-R/CD-RW discs which contain WMA/MP3 music data. However, some discs may have problems such as unable to play, noise or sound distortion.
- This device is exclusively a playback device. It cannot record CD-R/CD-RW discs.
- As the playback of a CD-RW disc necessitates partial change of the player setup, it may take longer time for reading the TOC information than when an Audio CD or CD-R disc is played.
- Depending on the application settings and environment, discs recorded with a personal computer may not be able to be played. Please record with the correct format. (For details, please inquire at your application sales agent.)
- Discs recorded with the packet writing system cannot be played.
- Mixed mode CD/enhanced CD and DTS CD discs cannot be played.

ABOUT PLAYING COPY-CONTROLLED CDs

Some copy-controlled CDs may not conform to official CD standards. They are special discs and may not play on the unit.

ABOUT DUALDISC PLAYBACK

- “DualDisc” contains DVD-standard-compliant video and audio on one side and audio for playing on a CD player on the other side, respectively.
- Since the non-DVD audio side does not conform to common CD physical standards, it may not be able to be played.
- In regard to details such as “DualDisc” specifications and standards, please inquire at your selling agent or distributor.

SPECIFICATIONS

AUDIO CHARACTERISTICS

Channels.....	2 channels
Frequency response.....	2 Hz to 20 kHz
Dynamic range.....	100 dB
Signal-to-noise ratio (A-weighted).....	110 dB
Channel separation (1 kHz).....	110 dB
Harmonic distortion (1 kHz).....	0.002%
Wow & flutter.....	Precision of quartz
Audio output.....	2 V rms, stereo
Headphone output (variable maximum).....	16 mW/32 ohms
Digital output	
Coaxial output (pin jack).....	0.5 Vp-p, 75 ohms
Optical output (square optical connector).....	-19 dBm

OPTICAL READOUT SYSTEM

Laser.....	AlGaAs semiconductor
Wavelength.....	780 nm

SIGNAL SYSTEM

Sampling frequency.....	44.1 kHz
Quantization.....	16-bit linear PCM

POWER SUPPLY

Power requirement.....	AC 120 V 60 Hz
Power consumption.....	18 W
Standby power consumption.....	0.6 W

This unit's specifications and exterior are subject to change without notice for improvements.

DIMENSIONS

(Unit: mm (in))

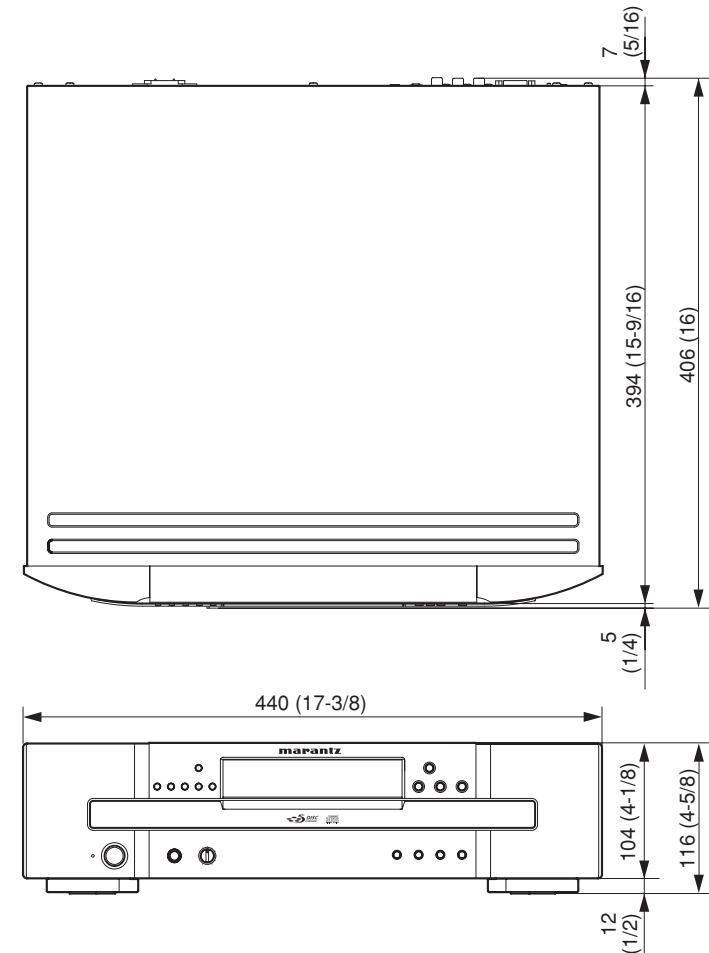

Weight: 7.0 kg

CLASS 1 LASER PRODUCT
 LUOKAN 1 LASERLAITE
 KLASS 1 LASERAPPARAT

OTHERS

NOTES ABOUT THE DISCS

* **Handle the discs carefully so as not to scratch their signal surfaces.**

* **Keep the signal surfaces of the discs clean at all times.**

When cleaning the signal surfaces of discs, always be sure to use the special cleaner and wipe the surfaces in the directions shown in the figure below.

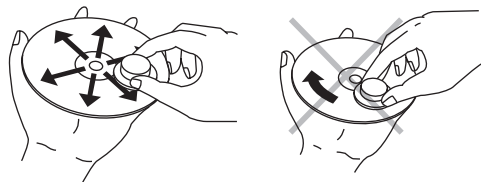

- Wipe the surface radially from the center.
- Do not wipe the surface in the circumferential direction.

* **Do not attach pieces of paper or stickers to the label surfaces of the discs.**

When a disc has a piece of plastic tape or rental CD label with paste protruding from the edge or when a disc still bears traces of sticky tape or adhesive labels, do not attempt to play it. If such a disc is played on the CD player, you may find that you cannot remove it or that some other kind of malfunctioning may occur.

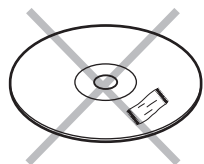

* **Do not use discs which come in special shapes.**

Do not attempt to play heart-shaped or octagonal discs or discs with any other special shapes. You may find that you cannot remove them or that some other kind of malfunctioning may occur in the player.

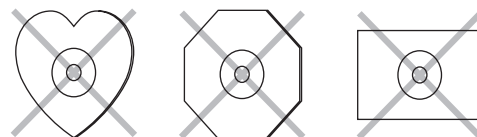

* **Use discs which satisfy the CD standards such as those with the "CD logo", "disc" or "compact disc" mark on their disc label surfaces.**



No guarantees are made for playback if discs which do not satisfy the appropriate CD standards are used.

Similarly, no guarantees are made for their sound quality even if it is possible to play such discs.

* **To protect your discs from damage, avoid placing them in the following locations.**

- Where they will be exposed to direct sunlight or where they will be close to a heater or other heat-radiating appliance
- Where the humidity level is high or it is very dusty
- Near a window or other such location where they may be exposed to rain

* **Get into the habit of putting the discs back in their cases after use.**

CLEANING OF EQUIPMENT EXTERNAL SURFACES

The exterior finish of your unit will last indefinitely with proper care and cleaning. Never use scouring pads, steel wool, scouring powders or harsh chemical agents (e.g., lye solution), alcohol, thinner, benzene, insecticide or other volatile substances as these will mar the finish of the equipment. Likewise, never use cloths containing chemical substances. If the equipment gets dirty, wipe the external surfaces with a soft, lint-free cloth.

If the equipment becomes heavily soiled:

- Dilute some washing up liquid in water, in a ratio of one part detergent to six parts water.
- Dip a soft, lint free in the solution and wring the it is damp.
- Wipe the equipment with the damp cloth.
- Dry the equipment by wiping it with a dry cloth.



REPAIRS

Only the most competent and qualified service technicians should be allowed to service the factory-trained warranty station personnel have the knowledge and special facilities needed for repair and calibration of this precision equipment. After the warranty period has expired, repairs will be performed for a charge if the equipment can be returned to normal operation.

In the event of difficulty, refer to your dealer or write directly to the nearest location to you that is listed on the Marantz Authorized Service Station list. If writing, please include the model and serial number of the equipment together with a full description of what you think is abnormal about the equipment's behaviour.

www.marantz.com

You can find your nearest authorized distributor or dealer on our website.

marantz[®] is a registered trademark.



Free Manuals Download Website

<http://myh66.com>

<http://usermanuals.us>

<http://www.somanuals.com>

<http://www.4manuals.cc>

<http://www.manual-lib.com>

<http://www.404manual.com>

<http://www.luxmanual.com>

<http://aubethermostatmanual.com>

Golf course search by state

<http://golfingnear.com>

Email search by domain

<http://emailbydomain.com>

Auto manuals search

<http://auto.somanuals.com>

TV manuals search

<http://tv.somanuals.com>