

**Marathon Monitors Inc.**  
**AACC 2000 (Carbon) Monitor / Controller**  
**Installation and Operation Handbook**



COPYRIGHT © 1998  
MARATHON MONITORS INC

# Marathon Monitors Inc.

---

Part # F200047

COPYRIGHT © 1998

MARATHON MONITORS INC.

3100 East Kemper Road, Cincinnati, Ohio 45241

1-800-322-4444 (513) 772-7788 FAX: (513) 772-7853

No part of this document may be stored or reproduced by any means whatsoever without prior written permission of Marathon Monitors Inc.

All trademarks used in this publication are duly marked and the sole property of their respective owners. No attempt at trademark or copyright infringement is intended or implied.

Marathon Monitors makes no warranties express or implied beyond the written warranty presented at initial purchase. Marathon Monitors Inc. is not responsible for any product, process, damage or injury incurred while using this equipment. Marathon Monitors makes no representations or warranties with respect to the contents hereof and specifically disclaims any warranties of merchantability or fitness for any particular application or purpose.

**“This product is covered by one or more of the following US Patents:**

**5,484,206; Additional patents pending.**

REVISION 1.1.1 - 1998-02-26 ADD TYPICAL WIRING DIAGRAM.

REVISION 1.1.2 - 1998-04-30 ADD HEADER AND FOOTER TO PAGE 36.

# Marathon Monitors Inc.

---

Table of contents:	
SAFETY and EMC INFORMATION .....	4
Installation Safety Requirements .....	5
Installation requirements for EMC .....	7
Technical Specification .....	8
Installation .....	11
Introduction .....	13
MECHANICAL INSTALLATION .....	13
Wiring of 2-wire EIA-485 serial communications link .....	21
OPERATION .....	23
FRONT PANEL LAYOUTS.....	24
Basic operation .....	26
Operating modes.....	27
Automatic mode.....	28
MANUAL MODE .....	29
PARAMETERS AND HOW TO ACCESS THEM.....	30
Parameter names.....	32
Navigation Diagram.....	33
PARAMETER TABLES .....	37
Alarms.....	44
Diagnostic alarms .....	45
ACCESS LEVELS .....	47
Edit level .....	50
Setting operator access to a parameter .....	50
TUNING .....	53
AUTOMATIC TUNING.....	54
MANUAL TUNING .....	56
Setting the cutback values .....	57
motorized valve control.....	59
Gain scheduling .....	62
CONFIGURATION.....	63
Selecting configuration level .....	64
Changing the passwords .....	65
User calibration .....	85
User Calibration Enable.....	86
Offset calibration .....	87
Two-point calibration.....	89
Calibration points and Calibration offsets.....	92
Parameter Table (Default).....	93
INDEX .....	102

## SAFETY and EMC INFORMATION

Please read this section carefully before installing the controller

This controller is intended for industrial temperature and process control applications where it will meet the requirements of the European Directives on Safety and EMC. Use in other applications, or failure to observe the installation instructions of this handbook may impair the safety or EMC protection provided by the controller. It is the responsibility of the installer to ensure the safety and EMC of any particular installation.

### Safety

This controller complies with the European Low Voltage Directive 73/23/EEC, amended by 93/68/EEC, by the application of the safety standard EN 61010.

### Electromagnetic compatibility

This controller conforms with the essential protection requirements of the EMC Directive 89/336/EEC, amended by 93/68/EEC, by the application of a Technical Construction File. This instrument satisfies the general requirements of an industrial environment as described by EN 50081-2 and EN 50082-2. For more information on product compliance refer to the Technical Construction File.

## SERVICE AND REPAIR

This controller has no user serviceable parts. Contact your nearest MMI Service center (800-322-4444) for repair.

### Caution: Charged capacitors

Before removing an instrument from its case, disconnect the supply and wait at least two minutes to allow capacitors to discharge. Failure to observe this precaution will expose capacitors that may be charged with hazardous voltages. In any case, avoid touching the exposed electronics of an instrument when withdrawing it from the case.

### Electrostatic discharge precautions

When the controller is removed from its case, some of the exposed electronic components are vulnerable to damage by electrostatic discharge from someone handling the controller. To avoid this, before handling the unplugged controller discharge yourself to ground.

### Cleaning

Do not use water or water based products to clean labels or they will become illegible. Isopropyl alcohol may be used to clean labels. A mild soap solution may be used to clean other exterior surfaces of the product.

## Installation Safety Requirements

### Safety Symbols

Various symbols are used on the instrument, they have the following meaning:



Caution, (refer to the accompanying documents)



Functional earth (ground) terminal

The functional earth connection is not required for safety purposes but to ground RFI filters.

### Personnel

Installation must only be carried out by qualified personnel.

### Enclosure of live parts

To prevent hands or metal tools touching parts that may be electrically live, the controller must be installed in an enclosure.

### Caution: Live sensors

The fixed digital inputs, non-isolated dc, logic and outputs and the logic output of dual output modules, are all electrically connected to the main process variable input. If the temperature sensor is connected directly to an electrical heating element then these non-isolated inputs and outputs will also be live. The controller is designed to operate under these conditions. However you must ensure that this will not damage other equipment connected to these inputs and outputs and that service personnel do not touch connections to these i/o while they are live. With a live sensor, all cables, connectors and switches for connecting the sensor and non-isolated inputs and outputs must be mains rated.

### Wiring

It is important to connect the controller in accordance with the wiring data given in this handbook. Take particular care not to connect AC supplies to the low voltage sensor input or other low level inputs and outputs. Only use copper conductors for connections (except thermocouple inputs) and ensure that the wiring of installations comply with all local wiring regulations. For example in the UK use the latest version of the IEE wiring regulations, (BS7671). In the USA use NEC Class 1 wiring methods.

### Power Isolation

The installation must include a power isolating switch or circuit breaker. This device should be in close proximity to the controller, within easy reach of the operator and marked as the disconnecting device for the instrument.

### Earth leakage current

Due to RFI Filtering there is an earth leakage current of less than 0.5mA. This may affect the design of an installation of multiple controllers protected by Residual Current Device, (RCD) or Ground Fault Detector, (GFD) type circuit breakers.

# Marathon Monitors Inc.

---

## Overcurrent protection

To protect the internal PCB tracking within the controller against excess currents, the AC power supply to the controller and power outputs must be wired through the fuse or circuit breaker specified in the technical specification.

## Voltage rating

The maximum continuous voltage applied between any of the following terminals must not exceed 264Vac:

- line or neutral to any other connection;
- relay or triac output to logic, dc or sensor connections;
- any connection to ground.

The controller should not be wired to a three phase supply with an unearthed star connection. Under fault conditions such a supply could rise above 264Vac with respect to ground and the product would not be safe.

Voltage transients across the power supply connections, and between the power supply and ground, must not exceed 2.5kV. Where occasional voltage transients over 2.5kV are expected or measured, the power installation to both the instrument supply and load circuits should include a transient limiting device.

These units will typically include gas discharge tubes and metal oxide varistors that limit and control voltage transients on the supply line due to lightning strikes or inductive load switching. Devices are available in a range of energy ratings and should be selected to suit conditions at the installation.

## Conductive pollution

Electrically conductive pollution must be excluded from the cabinet in which the controller is mounted. For example, carbon dust is a form of electrically conductive pollution. To secure a suitable atmosphere in conditions of conductive pollution, fit an air filter to the air intake of the cabinet. Where condensation is likely, for example at low temperatures, include a thermostatically controlled heater in the cabinet.

## Over-temperature protection

When designing any control system it is essential to consider what will happen if any part of the system should fail. In temperature control applications the primary danger is that the heating will remain constantly on. Apart from spoiling the product, this could damage any process machinery being controlled, or even cause a fire.

Reasons why the heating might remain constantly on include:

- the temperature sensor becoming detached from the process;
- thermocouple wiring becoming a short circuit;
- the controller failing with its heating output constantly on;
- an external valve or contactor sticking in the heating condition;
- the controller setpoint set too high.

# Marathon Monitors Inc.

---

Where damage or injury is possible, we recommend fitting a separate over-temperature protection unit, with an independent temperature sensor, which will isolate the heating circuit.

Please note that the alarm relays within the controller will not give protection under all failure conditions.

## **Grounding of the temperature sensor shield**

In some installations it is common practice to replace the temperature sensor while the controller is still powered up. Under these conditions, as additional protection against electric shock, we recommend that the shield of the temperature sensor is grounded. Do not rely on grounding through the framework of the machine.

## **Installation requirements for EMC**

To ensure compliance with the European EMC directive certain installation precautions are necessary as follows:

- For general guidance refer to MMI Controls EMC Installation Guide, HA025464.
- When using relay or triac outputs it may be necessary to fit a filter suitable for suppressing the emissions. The filter requirements will depend on the type of load. For typical applications we recommend Schaffner FN321 or FN612.
- If the unit is used in table top equipment which is plugged into a standard power socket, then it is likely that compliance to the commercial and light industrial emissions standard is required. In this case to meet the conducted emissions requirement, a suitable mains filter should be installed. We recommend Schaffner types FN321 and FN612.

## **Routing of wires**

To minimise the pick-up of electrical noise, the wiring for low voltage dc and particularly the sensor input should be routed away from high-current power cables. Where it is impractical to do this, use shielded cables with the shield grounded at both ends.

## Technical Specification

### Environmental ratings

Panel sealing:	Instruments are intended to be panel mounted. The rating of panel sealing is IP65, (EN 60529), or 4X, (NEMA 250).
Operating temperature: ventilation.	0 to 55°C. Ensure the enclosure provides adequate ventilation.
Relative humidity:	5 to 95%, non condensing.
Atmosphere:	The instrument is not suitable for use above 2000m or in explosive or corrosive atmospheres.

### Equipment ratings

Supply voltage:	100 to 240Vac -15%, +10%, or optionally:
Supply frequency:	48 to 62Hz.
Power consumption:	15 Watts maximum.
Relay 2-pin (isolated):	Maximum: 264Vac, 2A resistive. Minimum: 12Vdc, 100mA.
Relay changeover (isolated):	Maximum: 264Vac, 2A resistive. Minimum: 6Vdc, 1mA.
Triac outputs (isolated):	30 to 264Vac. Maximum current: 1A resistive.
Leakage current:	The leakage current through triac and relay contact suppression components is less than 2mA at 264Vac, 50Hz.
Over current protection:	External over current protection devices are required that match the wiring of the installation. A minimum of 0.5mm <sup>2</sup> or 16awg wire is recommended. Use independent fuses for the instrument supply and each relay or triac output. Suitable fuses are T type, (EN 60127 time-lag type) as follows; Instrument supply: 85 to 264Vac, 2A, (T). Relay outputs: 2A (T). Triac outputs: 1A (T).
Low level i/o:	All input and output connections other than triac and relay are intended for low level signals less than 42V.
Single logic output:	18V at 24mA. (Non-isolated.)
DC output (Isolated):	0 to 20mA (600Ω max), 0 to 10V (500Ω min).
DC output (Non isolated):	0 to 20mA (600Ω max), 0 to 10V (500Ω min).
Fixed digital inputs:	Contact closure. (Non isolated.)
Triple contact input:	Contact closure. (Isolated.)
Triple logic input:	11 to 30Vdc. (Isolated.)
DC or 2 <sup>nd</sup> PV input:	As main input plus 0-1.6Vdc, Impedance, >100MΩ. (Isolated.)
Potentiometer input:	0.5V excitation, 100Ω to 1.5kΩ Potentiometer. (Isolated.)
Transmitter supply:	24Vdc at 20mA. (isolated.)
Strain gauge supply:	10Vdc. Minimum bridge resistance 300Ω. (Isolated.)
Digital Communications:	EIA-232, 2-wire EIA-485 or 4-wire EIA-485 (All isolated).



# Marathon Monitors Inc.

---

## General

Main PV Input range:  $\pm 100\text{mV}$ , 0 to 10Vdc (auto ranging) and 3 wire Pt100.  
Calibration accuracy: The greater of  $\pm 0.2\%$  of reading,  $\pm 1$  LSD or  $\pm 1^\circ\text{C}$ .  
Cold junction compensation  $>30:1$  rejection of ambient temperature, (for thermocouple i/p).

## Electrical safety

Standards: EN 61010, Installation category II, pollution degree 2.  
CSA C22.2 No.142-M1987.

Installation category II: Voltage transients on any mains power connected to the instrument must not exceed 2.5kV.

Pollution degree 2: Conductive pollution must be excluded from the cabinet in which the instrument is mounted.

Isolation: All isolated inputs and outputs have reinforced insulation to provide protection against electric shock. The fixed digital inputs, non-isolated dc, logic, and the logic output of dual output modules, are all electrically connected to the main process variable input, (thermocouple etc.).

# Marathon Monitors Inc.

---

## Installation

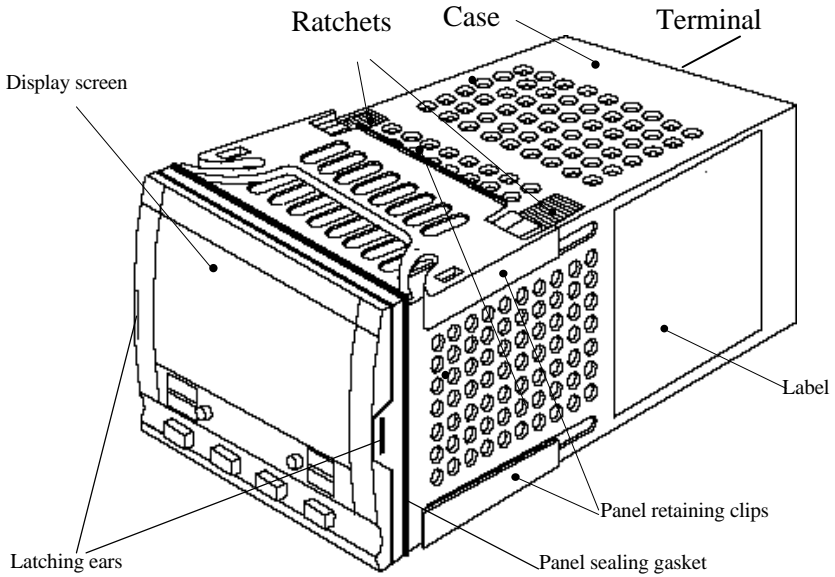

AACC 2000 1/4 DIN controller

**Figure 1 - 3**

# Marathon Monitors Inc.

## Outline dimensions Model 2000

96mm  
3.78in

150mm  
5.91in

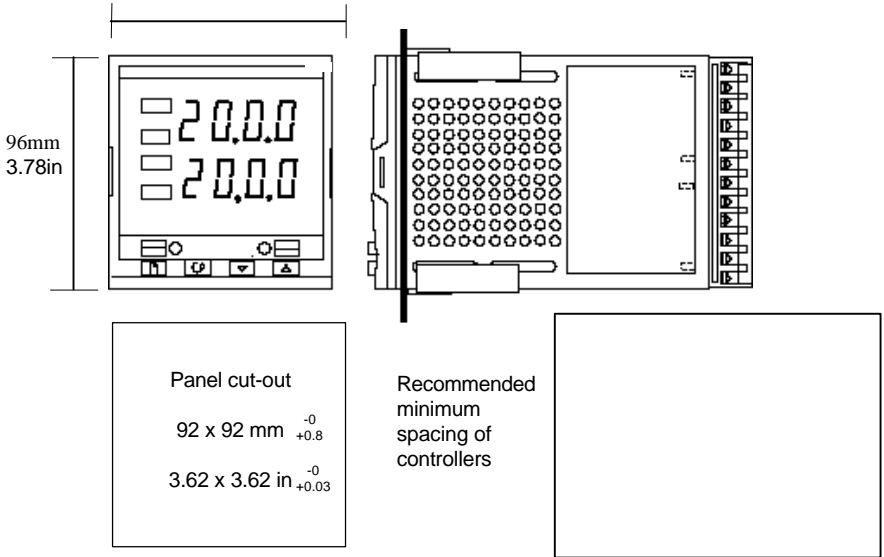

Figure 1-4 Outline dimensions Model 2000 controller

The electronic assembly of the controller plugs into a rigid plastic case, which in turn fits into the standard DIN size panel cut-out shown in Figures 1-3 and 1-4.

## Introduction

Model AACC 2000's are high stability, process controllers with self and adaptive tuning. They have a modular hardware construction which accepts up to three plug-in Input/Output modules and two interface modules to satisfy a wide range of control requirements. Two digital inputs and an optional alarm relay are included as part of the standard hardware.

**Before proceeding, please read the, *Safety and EMC Information.***

## Controller labels

The labels on the sides of the controller identify the ordering code, the serial number, and the wiring connections.

Appendix A, *Understanding the Ordering Code*, explains the hardware and software configuration of your particular controller.

## MECHANICAL INSTALLATION

### To install the controller

1. Prepare the control panel cut-out to the size shown in Figure 1-3, or 1-4.
2. Insert the controller through the panel cut-out.
3. Spring the upper and lower panel retaining clips into place. Secure the controller in position by holding it level and pushing both retaining clips forward.

*Note:* If the panel retaining clips subsequently need removing, in order to extract the controller from the control panel, they can be unhooked from the side with either your fingers, or a screwdriver.

### Unplugging and plugging-in the controller

If required, the controller can be unplugged from its case by easing the latching ears outwards and pulling it forward out of the case. When plugging the controller back into its case, ensure that the latching ears click into place in order to secure the IP65 sealing.

# Marathon Monitors Inc.

All electrical connections are made to the screw terminals at the rear of the controller. If you wish to use crimp connectors, the correct size is AMP part number 349262-1. They accept wire sizes from 0.5 to 1.5 mm<sup>2</sup> (16 to 22 AWG). A set of connectors is supplied with the controller. The terminals are protected by a clear plastic hinged cover to prevent hands, or metal, making accidental contact with live wires.

## Rear terminal layouts

The rear terminal layouts are shown in Figure 1-6. The right-hand column carries the connections to the power supply, digital inputs 1 and 2, alarm relay and sensor input. The second and third columns from the right carry the connections to the plug-in modules. The connections depend upon the type of module installed, if any. To determine which plug-in modules are fitted, refer to the ordering code and wiring data on the controller side labels.

### Model AACC 2000 rear terminal layout

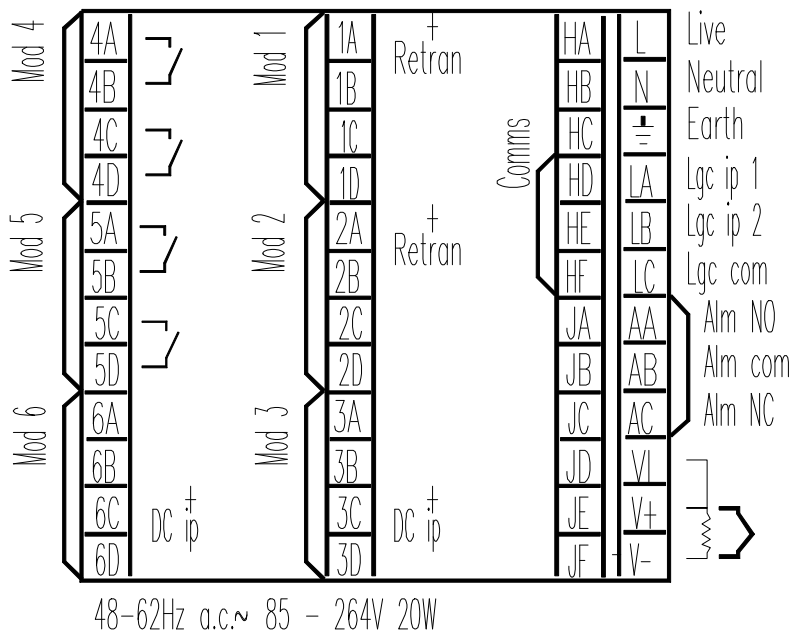
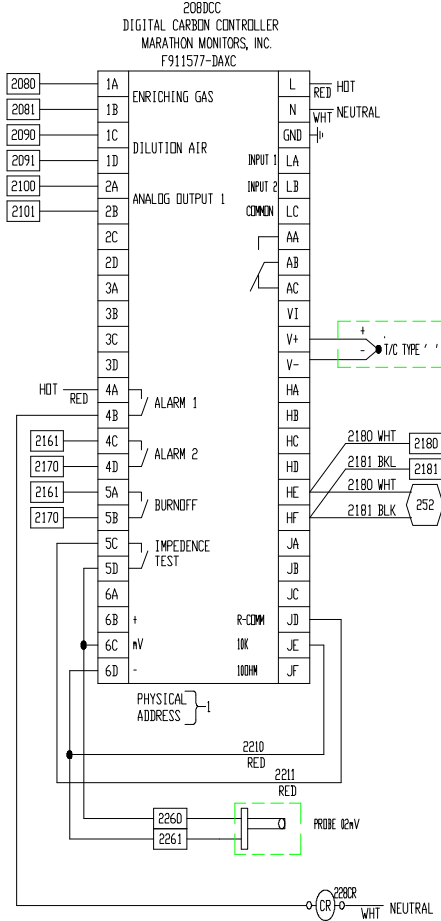

Figure 1-6 Rear terminal layout

# Marathon Monitors Inc.

The display below shows a typical wiring diagram for the AACC2000 Carbon Controller:



Typically a series of letters appear after the part number, see chart below.

- D – Dual Relay
- A – Analog Output
- X – Not Installed
- C – Communications
- I – Analog Input (typically in position 3)

# Marathon Monitors Inc.

## Sensor input connections

The connections for the various types of sensor input are shown below.

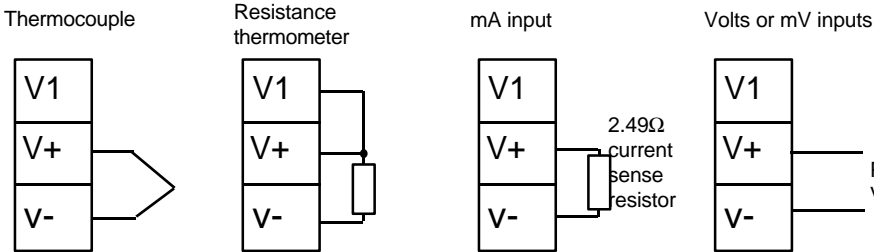

Fig 1-7 Sensor input connections

## PLUG-IN MODULE CONNECTIONS

### Module 1, 2 and 3

Module positions 1, 2 and 3 are plug-in modules. They can be either two terminal modules of the types shown in Table 1-1, or four terminal modules of the types shown in Table 1-2.

The tables show the connections to each module and the functions that they can perform.



# Marathon Monitors Inc.

## Two terminal modules

Note:           Module 1 is connected to terminals 1A and 1B  
                   Module 2 is connected to terminals 2A and 2B  
                   Module 3 is connected to terminals 3A and 3B.



Module type	Terminal identity				Possible functions
	A	B	C	D	
Relay: 2-pin (2A, 264 Vac max.)			Unused		Heating, cooling, alarm, program event, valve raise, or valve lower
Logic - non-isolated (18Vdc at 20mA)			Unused		Heating, cooling, mode 1, mode 2, program event
Triac (1A, 30 to 264Vac)			Unused		Heating, cooling, program event, valve raise, or valve lower
DC output: - non-isolated (10Vdc, 20mA max.)			Unused		Heating, or cooling, or retransmission of PV, setpoint, or control output

Table 1-1 Two terminal module connections

## Snubbers

The relay and triac modules have an internal 15nF/100Ω ‘snubber’ connected across their output, which is used to prolong contact life and to suppress interference when switching inductive loads, such as mechanical contactors and solenoid valves.

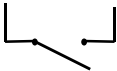
## WARNING

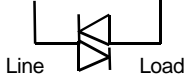
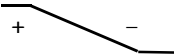
When the relay contact is open, or the triac is off, the snubber circuit passes 0.6mA at 110Vac and 1.2mA at 240Vac. You must ensure that this current, passing through the snubber, will not hold on low power electrical loads. It is your responsibility as the installer to ensure that this does not happen. If the snubber circuit is not required, it can be removed from the relay module (BUT NOT THE TRIAC) by breaking the PCB track that runs crosswise, adjacent to the edge connectors of the module. This can be done by inserting the blade of a small screwdriver into one of the two slots that bound it, and twisting.

# Marathon Monitors Inc.

## Four terminal modules

Note:                   Module 1 is connected to terminals 1A, 1B, 1C and 1D  
                               Module 2 is connected to terminals 2A, 2B, 2C and 2D  
                               Module 3 is connected to terminals 3A, 3B, 3C and 3D

Module type	Terminal identity				Possible functions
	A	B	C	D	
lay: changeover (2A, 264 Vac max.)					Heating, cooling, or alarm,
DC control: Isolated (10V, 20mA max.)	+	-			Heating, or cooling
24Vdc transmitter supply	+	-			To power process inputs
Potentiometer input 100Ω to 15KΩ		+0.5Vdc		0V	Motorised Valve Position feedback
DC retransmission	+	-			Retrans. of setpoint, or process value
DC remote input or Process Value 2 (Module 3 only)	0-10Vdc	RT source	±100mV 0-20mA	COM	Remote Setpoint Second PV
(Refer to Fig. 1-8)					
<b>Dual output modules</b>					
Dual relay (2A, 264 Vac max.)					Heating + cooling Dual alarms Valve raise & lower
Dual Triac (1A, 30 to 264Vac)					Heating + cooling Valve raise & lower
Dual logic + relay (Logic is non-isolated)					Heating + cooling
Dual Logic + triac (Logic is non-isolated)					Heating + cooling
<b>Triple logic input and output modules - see ratings on the next page</b>					
Triple contact input	Input 1	Input 2	Input 3	Common	
Triple logic input	Input 1	Input 2	Input 3	Common	

Table 1-2 Four terminal module connections.

# Marathon Monitors Inc.

## Connections for Process Value 3 in module position 3

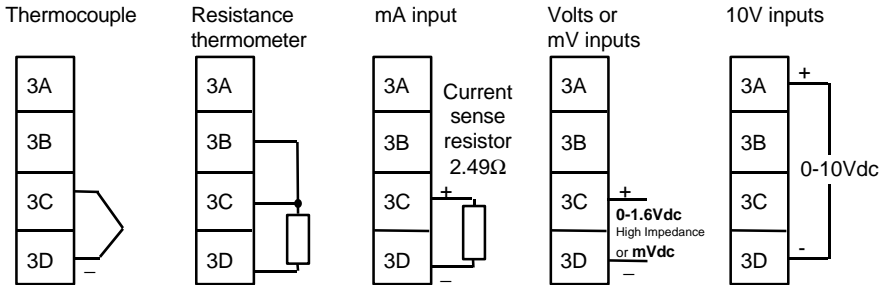

Figure 1-8 Connections for Process Value 2 (PV2)

The diagrams above show the connections for the various types of input. The input will have been configured in accordance with the ordering code.

# Marathon Monitors Inc.

---

## Communication module 1

The Models AACC 2000 will accept a plug-in communications modules.

The possible module types are shown in the table below.

The serial communications can be configured for either Modbus, or MMI protocol.

Communications module 1	Terminal identity (COMMS 1)					
	HA	HB	HC	HD	HE	HF
Module type						
2-wire EIA-485 serial communications	-	-	-	Common	A (-)	B (+)
EIA-232 serial communications	-	-	-	Common	Rx	Tx

Table 1-3 Communication module 1 connections

## Wiring of 2-wire EIA-485 serial communications link

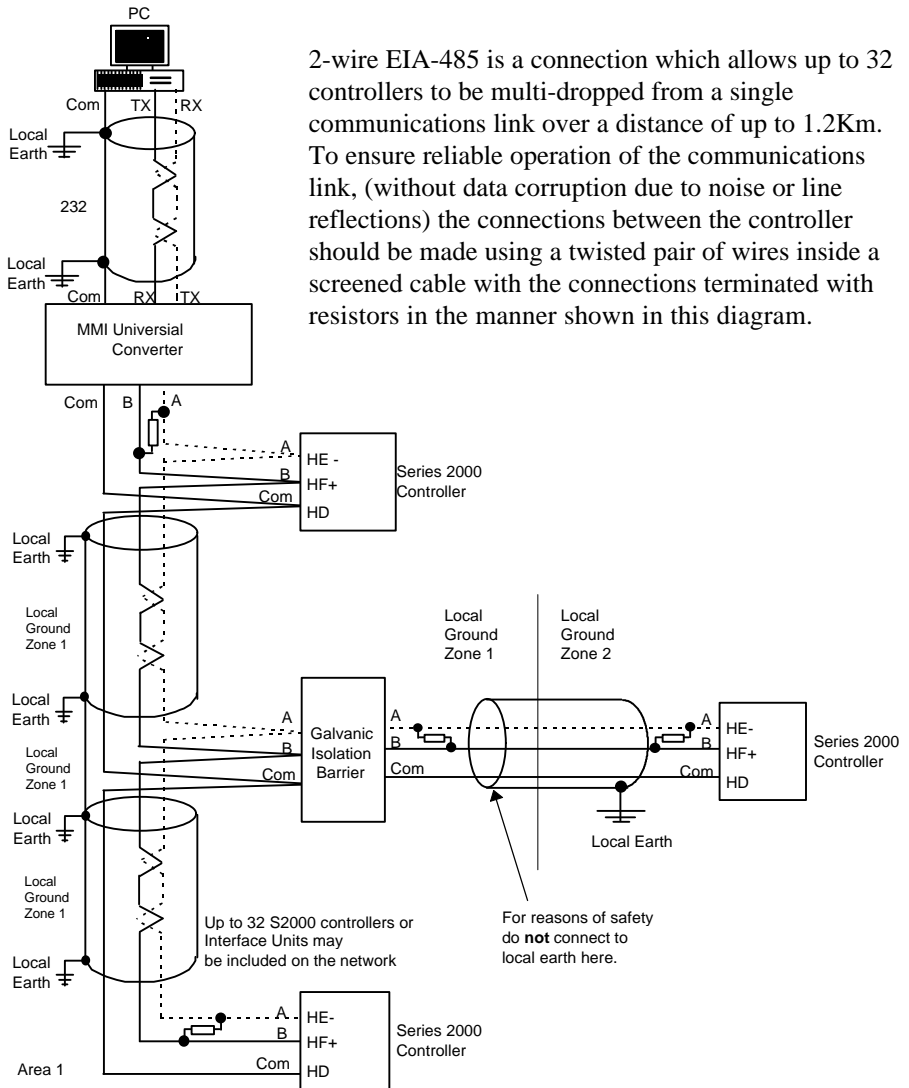

**Note:**

All resistors are 220 ohm 1/4W carbon composition.  
 Local grounds are at equipotential. Where equipotential is not available wire into separate zones using a galvanic isolator.  
 Use a repeater (KD845) for more than 32 units.

**Figure 1-9 EIA-485 wiring**



## OPERATION

This chapter has nine topics:

- FRONT PANEL LAYOUTS
- BASIC OPERATION
- OPERATING MODES
- AUTOMATIC MODE
- MANUAL MODE
- PARAMETERS AND HOW TO ACCESS THEM
- NAVIGATION DIAGRAM
- PARAMETER TABLES
- ALARMS

# Marathon Monitors Inc.

---

## FRONT PANEL LAYOUTs

Figure 2-1 Model AACC 2000 front panel layout

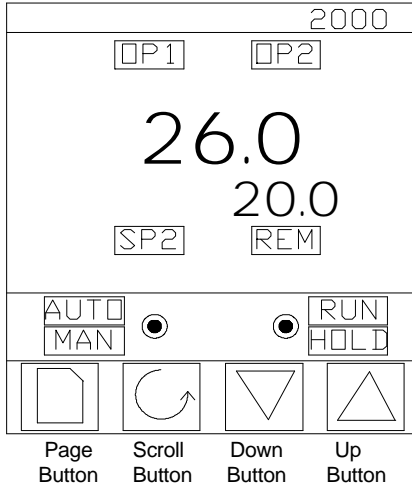



# Marathon Monitors Inc.







Button or indicator	Name	Explanation
OP1	Output 1	When lit, it indicates that the output installed in module position 1 is on. This is normally the heating output on a temperature controller.
OP2	Output 2	When lit, it indicates that the output installed in module position 2 is on. This is normally the cooling output on a temperature controller.
SP2	Setpoint 2	When lit, this indicates that setpoint 2, (or a setpoint 3-16) has been selected.
REM	Remote setpoint	When lit, this indicates that a remote setpoint input has been selected. 'REM' will also flash when communications is active.
	Auto/Manual button	When pressed, this toggles between automatic and manual mode: <ul style="list-style-type: none"> <li>• If the controller is in automatic mode the AUTO light will be lit.</li> <li>• If the controller is in manual mode, the MAN light will be lit.</li> </ul> The Auto/Manual button can be disabled in configuration level.
	Run/Hold button	<ul style="list-style-type: none"> <li>• Press once to start an automatic Probe care cycle</li> <li>• This RUN light indicates when ever a probe care function is in progress</li> </ul>
	Page button	Press to select a new list of parameters.
	Scroll button	Press to select a new parameter in a list.
	Down button	Press to decrease a value in the lower readout.
	Up button	Press to increase a value in lower readout.

Figure 2-3 Controller buttons and indicators

# Marathon Monitors Inc.



---

## Basic operation

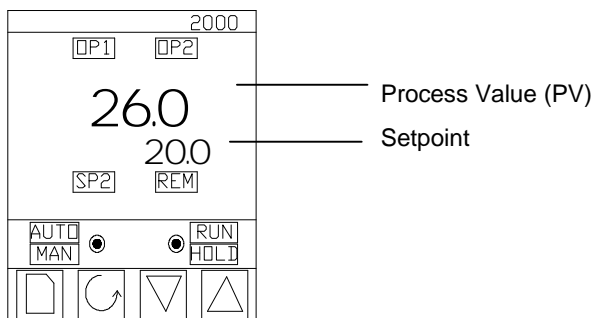
Switch on the power to the controller. It runs through a self-test sequence for about three seconds and then shows the process value, in the upper readout and the *setpoint*, in the lower readout. This is called the **Home** display.





**Figure 2-4 Home display**

You can adjust the setpoint by pressing the  or  buttons. Two seconds after releasing either button, the display blinks to show that the controller has accepted the new value.

OP1 will light whenever output 1 is ON. This is normally the heating output when used as a temperature controller.

OP2 will light whenever output 2 is ON. This is normally the cooling output when used as a temperature controller.

**Note:** You can get back to this display at any time by pressing  and  together. Alternatively, you will always be returned to this display if no button is pressed for 45 seconds, or whenever the power is turned on.

## Alarms

If the controller detects an alarm condition, it flashes an alarm message in the Home display. For a list of all the alarm messages, their meaning and what to do about them, see *Alarms* at the end of this chapter.

## Operating modes

The controller has two basic modes of operation:

- **Automatic mode** in which the output is automatically adjusted to maintain the temperature or process value at the setpoint.
- **Manual mode** in which you can adjust the output independent of the setpoint.

You toggle between the modes by pressing the AUTO/MAN button. The displays which appear in each of these modes are explained in this chapter.

# Marathon Monitors Inc.

## Automatic mode

You will normally work with the controller in automatic mode. If the MAN light is on, press the AUTO/MAN button to select automatic mode. The AUTO light comes on

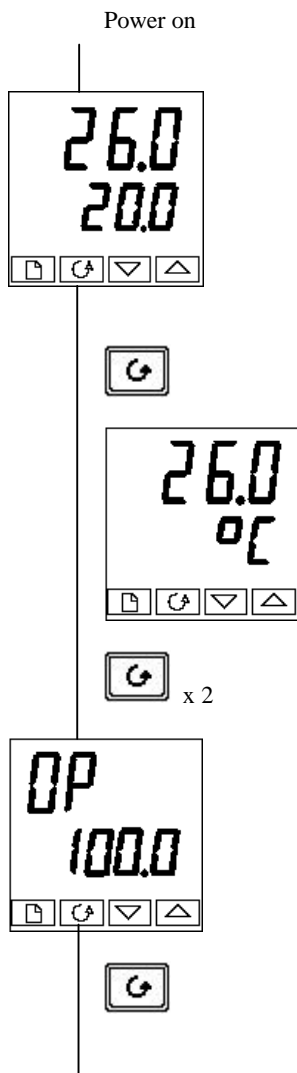

## The Home display

Check that the AUTO light is on.

The upper readout shows the measured temperature.

The lower readout shows the setpoint.

To adjust the setpoint up or down, press

▲ or ▼.

(Note: If Setpoint Rate Limit has been enabled, then the lower readout will show the active setpoint. If ▲ or ▼ is pressed, it will change to show and allow adjustment of, the target setpoint.)

Press  once

## Display units



A single press of  will flash the display units for 0.5 seconds, after which you will be returned to the Home display.



Flashing of the display units may have been disabled in configuration in which case a single press will take you straight to the display shown below.

Press  twice

## % Output power demand

The % output power demand is displayed in the lower readout. This is a read-only value. You cannot adjust it.

Press  and  together to return to the Home display.

Pressing  from the Output Power display may access further parameters. These may be in this scroll list if the 'Promote' feature has been used (see Chapter 3, *Access Level*). When you reach the end of this scroll list, pressing  will return you to the **Home** display.

# Marathon Monitors Inc.

## MANUAL MODE

If the AUTO light is on, press the AUTO/MAN button to select manual mode. The MAN light comes on.

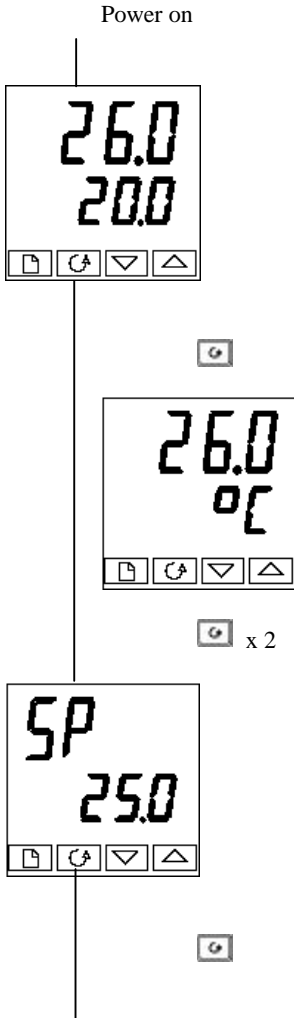

### The Home display

Check that the MAN light is on.

The upper readout shows the measured temperature, or process value. The lower readout shows the % output.

To adjust the output, press ▲ or ▼. (Note: If Output Rate Limit has been enabled, then the lower readout will show the working output. If ▲ or ▼ is pressed, it will change to show and allow adjustment of, the target output.)

Press  once.

### Display units

A single press of  flashes the display units for 0.5 seconds, after which you are returned to the Home display.



Flashing of the display units may have been disabled in configuration, in which case a single press will take you straight to the display shown below.

Press  twice.

### Setpoint

To adjust the setpoint value, press ▲ or ▼.

Press  .

Pressing  from the Output Power display may access further parameters. These may be in this scroll list if the 'Promote' feature has been used (see Chapter 3, *Edit Level*). When you reach the end of this scroll list, pressing  will return you to the **Home** display.

# Marathon Monitors Inc.

---

## PARAMETERS AND HOW TO ACCESS THEM

Parameters are settings, that determine how the controller will operate. For example, alarm setpoints are parameters that set the points at which alarms will occur. For ease of access, the parameters are arranged in lists as shown in the navigation diagram on Pages 2-10 and 2-11. The lists are:

Home list	Autotune list	Output list
Probe list	PID list	Communications
Care list	Motor list	list
User list	Setpoint list	Information list
Alarm list	Input list	Access list.

Each list has a 'List Header' display.

### List header displays

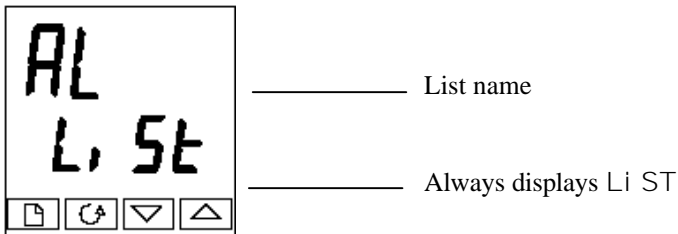

Figure 2-5 Typical list header display



A list header can be recognized by the fact that it always shows 'Li St' in the lower readout. The upper readout is the name of the list. In the above example, 'AL' indicates that it is the Alarm list header. List header displays are read-only.

To step through the list headers, press . Depending upon how your controller has been configured, a single press may momentarily flash the display units. If this is the case, a double press will be necessary to take you to the first list header. Keep pressing to step through the list headers, eventually returning you to the Home display.

To step through the parameters within a particular list, press . When you reach the end of the list, you will return to the list header. From within a list you

## Marathon Monitors Inc.

---

can return to the current list header at any time can by pressing  . To step to the next list header, press  once again.

# Marathon Monitors Inc.

---

## Parameter names

In the navigation diagram, each box shows the display for a selected parameter. The Operator parameter tables, later in this chapter, list all the parameter names and their meanings.

The navigation diagram shows all the parameters that can, potentially, be present in the controller. In practice, a limited number of them appear, as a result of the particular configuration.

The shaded boxes in the diagram indicate parameters that are hidden in normal operation. To view all the available parameters, you must select Full access level. For more information about this, see Chapter 3, Access Levels.

Parameter displays Each list has a 'List Header' display.

## Parameter displays

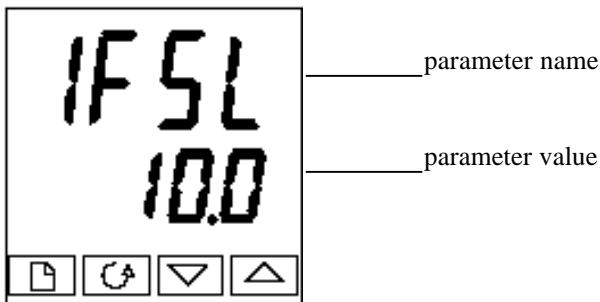



Figure 2-6 Typical parameter display

Parameter displays show the controller's current settings. The layout of parameter displays is always the same: the upper readout shows the parameter name and the lower readout its value. In the above example, the parameter name is 1FSL (indicating Alarm 1, full scale low), and the parameter value is 10.0.

## To change the value of a parameter

First, select the required parameter.

To change the value, press either  or . During adjustment, single presses change the value by one digit.

Keeping the button pressed speeds up the rate of change.

Two seconds after releasing either button, the display blinks to show that the controller has accepted the new value.



# Marathon Monitors Inc.

## Navigation Diagram (Part A) (THE PARAMETERS THAT APPEAR DEPEND UPON HOW THE CONTROLLER HAS BEEN CONFIGURED)

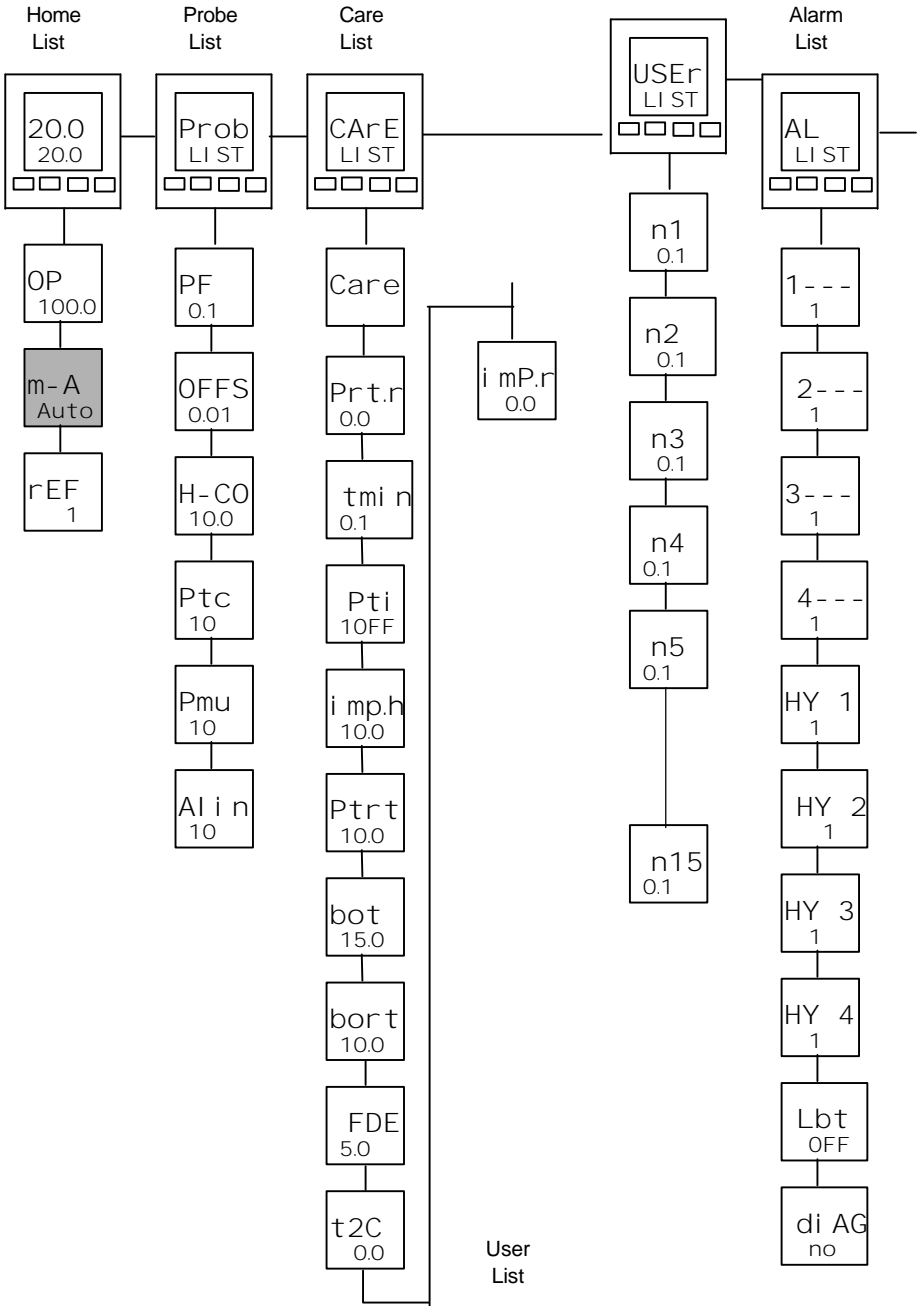

# Marathon Monitors Inc.

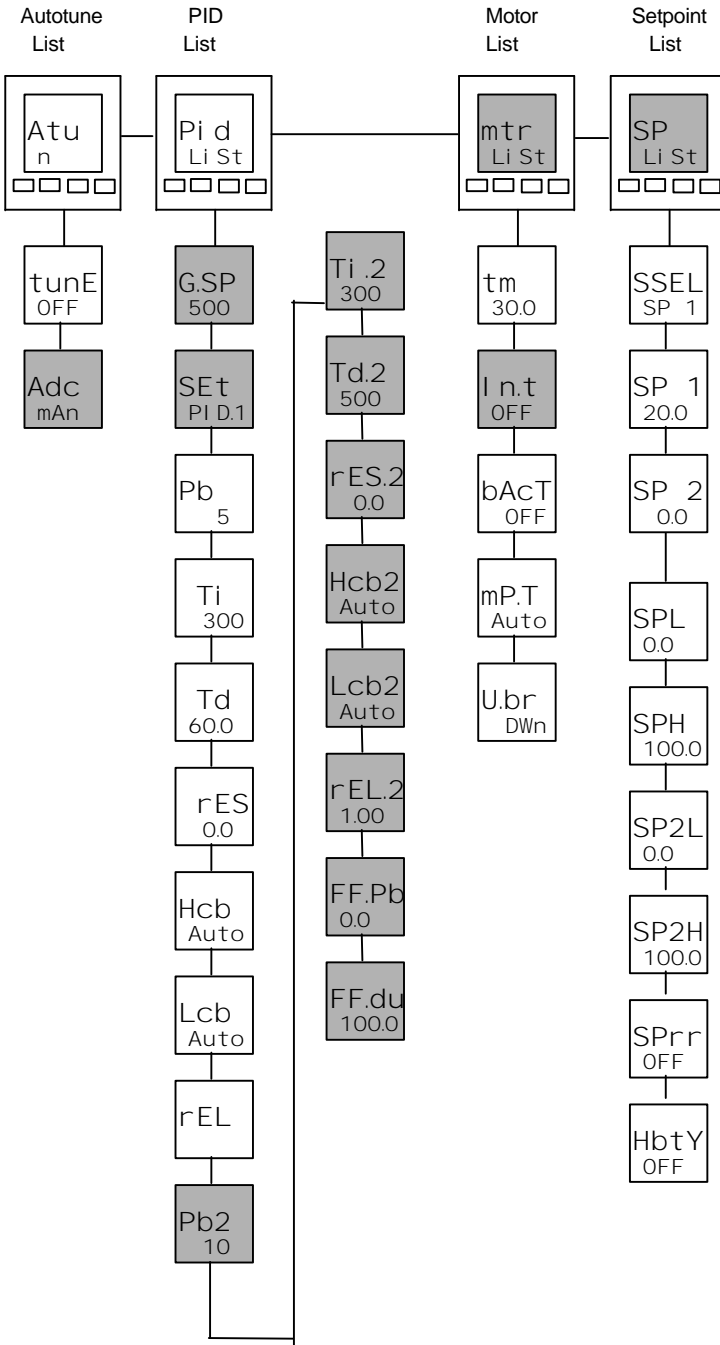

# Marathon Monitors Inc.

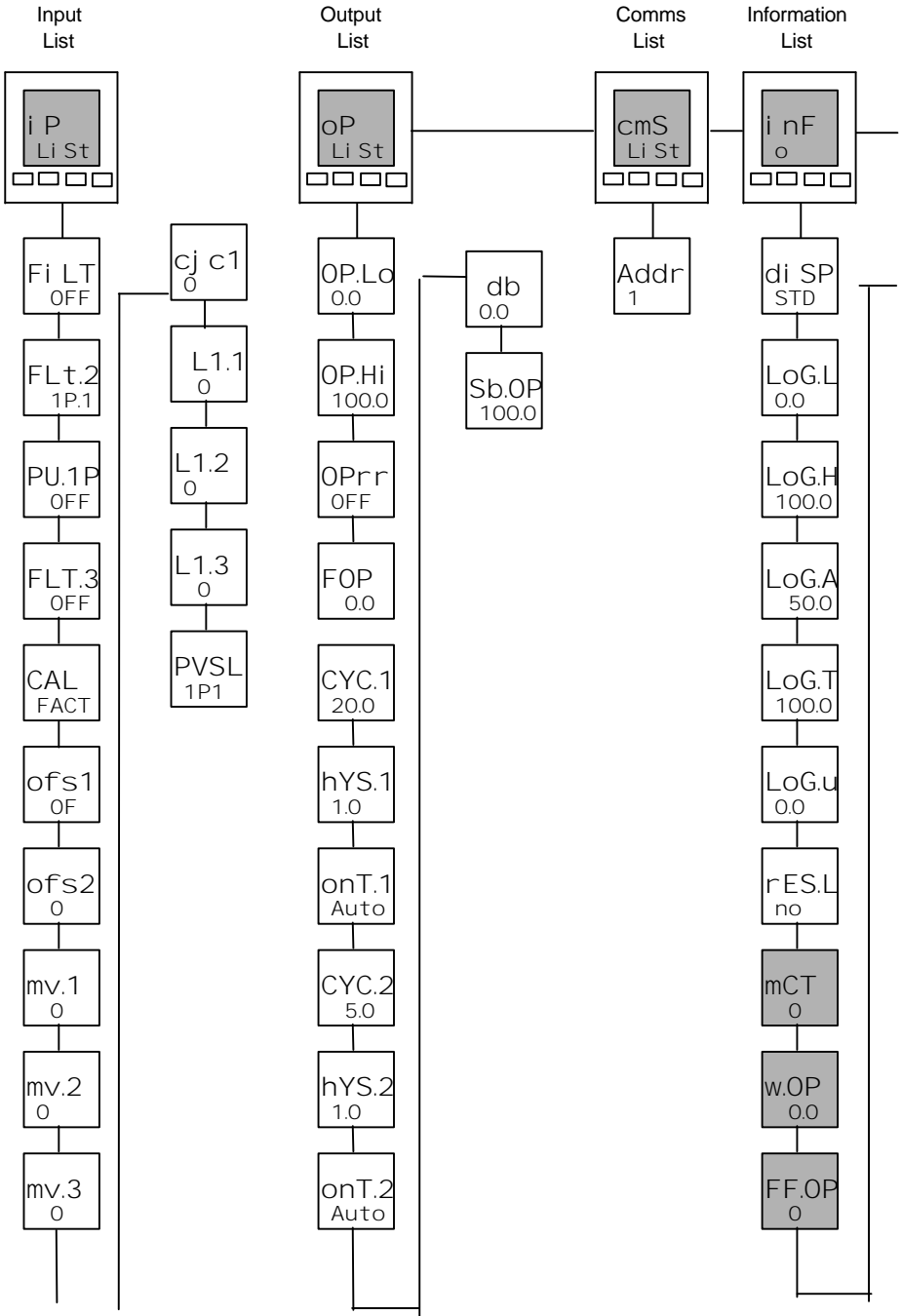

---

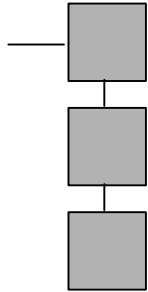

Access  
List

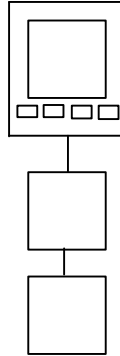

# Marathon Monitors Inc.

---

## PARAMETER TABLES

Name	Description
------	-------------

Home list	
Home	Measured value and Setpoint
OP	% Output level
SP	Target setpoint (if in Manual mode )
m-A	Auto-man select
r eF	Customer defined identification number
+ Extra parameters, if the 'Promote' feature has been used (see Chapter 3, <i>Edit Level</i> ).	

Name	Description
------	-------------

Probe list	
Prob	Process Factor
PF	Process Factor
OFFS	Millivolt input OFFSET
H-CO	Hydrogen or CO constant
PTC	Probe Temperature
Pmu	Probe millivolts
Ai n	AUX input

Name	Description
------	-------------

Care list	
Care	Probe care operation selection
Pr tr	MMI actual Probe recovery time
Tmi n	Minimum temperature for care procedure
PTi	Probe care cycle time
i mp.H	Maximum probe impedance
P tr t	Impedance test recovery time
bot	Burn off time
bor t	Burn off recovery time
FdE	Final delay time
t2C	Time to next care
i mp.r	impedance test result

# Marathon Monitors Inc.

Name	Description
------	-------------

User	User list
n1	user parameter #1
n2	user parameter #2
n3	user parameter #3
n4	user parameter #4
n5 - 15	user parameter #5 - 15

Name	Description
------	-------------

AL	Alarm list
1 - - -	Alarm 1 setpoint value
2 - - -	Alarm 2 setpoint value
3 - - -	Alarm 3 setpoint value
4 - - -	Alarm 4 setpoint value
<i>In place of dashes, the last three characters indicate the alarm type. See alarm types table:</i>	
HY 1	Alarm 1 Hysteresis (display units)
HY 2	Alarm 2 Hysteresis (display units)
HY 3	Alarm 3 Hysteresis (display units)
HY 4	Alarm 4 Hysteresis (display units)
Lb t	Loop Break Time in <b>minutes</b>
di AG	Enable Diagnostic alarms 'no' / 'YES'
<b>Alarm types table</b>	
- FSL	PV Full scale low alarm
- FSH	PV Full scale high alarm
- dEv	PV Deviation band alarm
- dHi	PV Deviation high alarm
- dLo	PV Deviation low alarm
- LCr	Load Current low alarm
- HCr	Load Current high alarm
- FL2	Input 2 Full Scale low alarm
- FH2	Input 2 Full Scale high alarm
- LOP	Working Output low alarm
- HOP	Working Output high alarm
- LSP	Working Setpoint low alarm
- HSP	Working Setpoint high alarm
4rAt	Rate of change alarm ( <i>AL 4 only</i> )

Atun	Autotune list
------	---------------

# Marathon Monitors Inc.

---

tunE	One-shot autotune enable
drA	Adaptive tune enable
drA.t	Adaptive tune trigger level in display units. Range = 1 to 9999
Adc	Automatic Droop Compensation (PD control only)

# Marathon Monitors Inc.

Name	Description
Pi d	<b>PID list</b>
G.SP	If Gain Scheduling has been enabled (see Chapter 4), this parameter sets the PV below which 'Pi d.1' is active and above which 'Pi d.2' is active.
SEt	'Pi d.1' or 'Pi d.2' selected
Pb	Proportional Band (SEt 1) (in display units)
ti	Integral Time in secs(SEt 1)
td	Derivative Time in secs (SEt 1)
rES	Manual Reset (%) (SEt 1)
Hcb	Cutback High (SEt 1)
Lcb	Cutback Low (SEt 1)
rEL.C	Relative Cool Gain (SEt 1)
Pb2	Proportional Band (SEt 2)
ti 2	Integral Time in secs(SEt 2)
td2	Derivative Time in secs (SEt 2)
rES.2	Manual Reset (%) (SEt 2)
Hcb2	Cutback High (SEt 2)
Lcb2	Cutback Low (SEt 2)
rEL.2	Relative Cool Gain (SEt 2)
<i>The following three parameters are used for cascade control. If this facility is not being used, then they can be ignored.</i>	
FF.Pb	SP, or PV, feedforward propband
FF.tr	Feedforward trim %
FF.dv	PID feedforward limits $\pm$ %
mtr	<b>Motor list - see Table 4-3</b>
tm	Valve travel time in seconds
ln.t	Valve inertia time in secs
bAc.t	Valve backlash time in secs
mp.t	Minimum ON time of output pulse
U.br	Valve sensor break strategy



# Marathon Monitors Inc.

---

Name	Description
------	-------------

SP	Setpoint list
SSEL	Select SP 1 to SP16, depending on configuration
SP 1	Setpoint one value
SP 2	Setpoint two value
SP L	Setpoint 1 low limit
SP H	Setpoint 1 high limit
SP2.L	Setpoint 2 low limit
SP2.H	Setpoint 2 high limit
SPrr	Setpoint Rate Limit
Hb.ty	Holdback Type for setpoint rate limit (OFF, Lo, Hi , or bAnd)

i P	Input list
Fi Lt	IP1 filter time constant (0.0 - 999.9 seconds).
FLt.2	IP2 filter time constant (0.0 - 999.9 seconds).
PV.i p	Selects 'i p.1' or 'i p.2'
FLt.3	DC input Filter Time Constant
CAL	User Calibration Enable
OFS.1	simple offset
OFS.2	PV2 simple offset
mV.1	ADC Converter millivolts
mV.2	ADC Converter millivolts PV2
mV.3	Second PV millivolts input
CJC.1	IP1 cold junction temp. reading
CJC.2	IP2 cold junction temp. reading
Li .1	IP1 linearised value
Li .2	IP2 linearised value
Li .3	DC Input 3
PV.SL	Current Input or Inputs used for PV

# Marathon Monitors Inc.

Name	Description
------	-------------

oP	Output list
<i>Does not appear if Motorised Valve control configured.</i>	
OP.Lo	Low power limit (%)
OP.Hi	High power limit (%)
OP.r	Output Rate Limit (% per sec)
FOP	Forced output level (%)
CYCH	Heat cycle time (0.2S to 999.9S)
hY.S.H	Heat hysteresis (display units)
ont.H	Heat output min. on-time (secs) Auto (0.05S), or 0.1 - 999.9S
CY.C	Cool cycle time (0.2S to 999.9S)
hY.S.C	Cool hysteresis (display units)
ont.C	Cool output min. on-time (secs) Auto (0.05S), or 0.1 - 999.9S
HC.db	Heat/cool deadband (display units)
Sb.OP	Sensor Break Output Power (%)

cmS	Comms list
Addr	Communications Address

i nFo	Information list
di SP	Configure lower readout of Home display to show:
	VPoS     Valve position
	Std       Standard - display setpoint
	AmPS     Load current in amps
	OP                     Output
	Stat       Program status
	PrG.t     Program time remaining in                     hours
	Li 2       Process value 2
	rAt         Ratio setpoint
	PrG         Selected program number
	rSP         Remote setpoint
LoGL	PV minimum
LoGH	PV maximum
LoGA	PV mean value
Loq.t	Time PV above Threshold level
Loq.v	PV Threshold for Timer Log

# Marathon Monitors Inc.

---

Name	Description
------	-------------

<b>i nFo</b>	<b>Information list - <i>continued</i></b>
rES.L	Logging Reset - 'YES/no'
<i>The following set of parameters is for diagnostic purposes.</i>	
mCt	Processor utilisation factor
w.OP	Working output
FF.OP	Feedforward component of output
VO	PID output to motorised valve
P OP	Proportional component of output
I OP	Integral component of output
d OP	Derivative component of output

<b>ACCS</b>	<b>Access List</b>
codE	Access password
Goto	Goto level - OPEr, FuLL, Edi t or conF
ConF	Configuration password



# Marathon Monitors Inc.

## Alarms

### Alarm annunciation

Alarms are flashed as messages in the Home display. A new alarm is displayed as a double flash followed by a pause, old (acknowledged) alarms as a single flash followed by a pause. If there is more than one alarm condition, the display cycles through all the relevant alarm messages. Table 2-1 and Table 2-2 list all of the possible alarm messages and their meanings.

### Alarm acknowledgement and resetting

Pressing both  and  at the same time will acknowledge any new alarms and reset any latched alarms.

### Alarm modes

Alarms will have been set up to operate in one of several modes, either:

- **Non-latching**, which means that the alarm will reset automatically when the Process Value is no longer in the alarm condition.
- **Latching**, which means that the alarm message will continue to flash even if the alarm condition no longer exists and will only clear when reset.
- **Blocking**, which means that the alarm will only become active after it has first entered a safe state on power-up.

### Alarm types

There are **two** types of alarm: **Process alarms** and **Diagnostic alarms**.

#### Process alarms

These warn that there is a problem with the process which the controller is trying to control.

Alarm Display	What it means
_FSL*	PV Full Scale Low alarm
_FSH*	PV Full Scale High alarm
_dEv*	PV Deviation Band alarm
_dHi *	PV Deviation High alarm
_dLo*	PV Deviation Low alarm
_LCr*	Load Current Low alarm
p.FLt	Probe impedance test fault.

Alarm Display	What it means
_FL2*	Input 2 Full Scale Low alarm
_FH2*	Input 2 Full Scale High alarm
_LOP*	Working Output Low alarm
_HOP*	Working Output High alarm
_LSP*	Working Setpoint Low alarm

\* In place of the dash, the first character will indicate the alarm number.

Table 2-1 Process alarms

# Marathon Monitors Inc.

## Diagnostic alarms

These indicate that a fault exists in either the controller or the connected devices.

Display shows	What it means	What to do about it
EE.Er	<i>Electrically Erasable Memory Error:</i> The value of an operator, or configuration, parameter has been corrupted.	This fault will automatically take you into Configuration level. Check all of the configuration parameters before returning to Operator level. Once in Operator level, check all of the operator parameters before resuming normal operation. If the fault persists, or occurs frequently, contact MMI Controls.
S.br	<i>Sensor Break:</i> Input sensor is unreliable or the input signal is out of range.	Check that the sensor is correctly connected.
L.br	<i>Loop Break</i> The feedback loop is open circuit.	Check that the heating and cooling circuits are working properly.
Hw.Er	<i>Hardware error</i> Indication that a module is of the wrong type, missing, or faulty.	Check that the correct modules are fitted.
no.i o	<i>No I/O</i> None of the expected I/O modules is fitted.	This error message normally occurs when pre-configuring a controller without installing any of the required I/O modules.
rmt.F	<i>Remote input failure.</i> the remote DC input, is open or short circuit	Check for open, or short circuit wiring on the remote DC input.
LLLL	<i>Out of range low reading</i>	Check the value of the input.
HHHH	<i>Out of range high reading</i>	Check the value of the input.
Err1	<i>Error 1: ROM self-test fail</i>	Return the controller for repair.
Err2	<i>Error 2: RAM self-test fail</i>	Return the controller for repair.
Err3	<i>Error 3: Watchdog fail</i>	Return the controller for repair.
Err4	<i>Error 4: Keyboard failure</i> Stuck button, or a button was pressed during power up.	Switch the power off and then on, without touching any of the controller buttons.
Err5	<i>Error 5: Faulty internal communications.</i>	Check printed circuit board interconnections. If the fault cannot be cleared, return the controller for repair.

# Marathon Monitors Inc.

---

Table 2-2b Diagnostic alarms

## ACCESS LEVELS

This chapter describes the different levels of access to the operating parameters within the controller.

There are three topics:

- THE DIFFERENT ACCESS LEVELS
- SELECTING AN ACCESS LEVEL
- EDIT LEVEL

### THE DIFFERENT ACCESS LEVELS

There are four access levels:

- **Operator level**, which you will normally use to operate the controller.
- **Full level**, which is used to commission the controller.
- **Edit level**, which is used to set up the parameters that you want an operator to be able to see and adjust when in Operator level.
- **Configuration level**, which is used to set up the fundamental characteristics of the controller.

Access level	Display shows	What you can do	Password Protection
Operator	OPER	In this level, operators can view and adjust the value of parameters defined in Edit level (see below).	No
Full	FULL	In this level, all the parameters relevant to a particular configuration are visible. All alterable parameters may be adjusted.	Yes
Edit	Edit	In this level, you can determine which parameters an operator is able to view and adjust in Operator level. You can hide, or reveal, complete lists, individual parameters within each list and you can make parameters read-only or alterable. (See <i>Edit level</i> at the end of this chapter).	Yes
Configuration	CONF	This special level allows access to set up the fundamental characteristics of the controller.	Yes

Figure 3-1 Access levels

# Marathon Monitors Inc.

## SELECTING AN ACCESS LEVEL

Access to Full, Edit or Configuration levels is protected by a password to prevent unauthorised access.

If you need to change the password, see Chapter 6, *Configuration*.

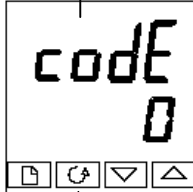



### Access list header

Press  until you reach the access list header 'ACCS'.

Press .

### Password entry

The password is entered from the 'code' display. Enter the password using  or . Once the correct password has been entered, there is a two second delay after which the lower readout will change to show 'PASS' indicating that access is now unlocked.





The pass number is set to '1' when the controller is shipped from the factory.

*Note;* A special case exists if the password has been set to '0'. In this case access will be permanently unlocked and the lower readout will always show 'PASS'.

Press  to proceed to the 'Goto' page.

(If an *incorrect* password has been entered and the controller is still 'locked' then pressing  returns you to the 'ACCS' list header.)

### Access to Read-only Configuration

From this display, pressing  and  together will take you into Read-Only Configuration without entering a password. This will allow you to view all of the configuration parameters, but not adjust them. If no button is pressed for ten seconds, you will be returned to the Home display. Alternatively, pressing  and  together takes you immediately back to the Home display





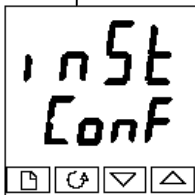

Alternative path if  
'conf' selected



## Level selection

The 'Goto' display allows you to select the required access level.

Use  and  to select from the following display codes:

OPER: Operator level

FULL: Full level

Edit: Edit level

CONF: Configuration level

Press 

If you selected either 'OPER', 'FULL' or 'Edit' level you will be returned to the 'ACCS' list header in the level that you chose. If you selected 'CONF', you will get a display showing 'CONF' in the upper readout (see below).

## Configuration password

When the 'CONF' display appears, you must enter the Configuration password in order to gain access to this level. Do this by repeating the password entry procedure described in the previous section.

The configuration password is set to '2' when the controller is shipped from the factory. If you need to change the configuration password, see Chapter 6, *Configuration*.

Press 

## Configuration level

The first display of configuration is shown. See Chapter 6, *Configuration*, for details of the configuration parameters.

For instructions on leaving configuration level, see Chapter 6, *Configuration*.

# Marathon Monitors Inc.

---

## Returning to Operator Level

To return to operator level from either 'FuLL' or 'Edi t' level, repeat entry of the password and select 'OPeR' on the 'GOTO' display.



In 'Edi t' level, the controller will automatically return to operator level if no button is pressed for 45 seconds.

## Edit level



Edit level is used to set which parameters you can view and adjust in Operator level. It also gives access to the 'Promote' feature, which allows you to select and add ('Promote') up to twelve parameters into the Home display list, thereby giving simple access to commonly used parameters.

## Setting operator access to a parameter

First you must select Edi t level, as shown on the previous page.

Once in Edi t level, you select a list, or a parameter within a list, in the same way as you would in Operator, or Full, level – that is to say, you move from list header to list header by pressing , and from parameter to parameter within each list using .

**However, in Edit level what is displayed is not the value of a selected parameter, but a code representing that parameter's availability in Operator level.**

When you have selected the required parameter, use  and  buttons to set its availability in Operator level.

There are four codes:

ALt r Makes a parameter alterable in Operator level.

PrO Promotes a parameter into the Home display list.

rEAd Makes a parameter, or list header, read-only (*it can be viewed but not altered*).

HI dE Hides a parameter, or list header.

For example:



The parameter selected is Alarm 2, Full Scale Low

It will be alterable in Operator level

## Hiding or revealing a complete list

To hide a complete list of parameters, all you have to do is hide the list header. If a list header is selected, only two selections are available: rEAd and HI dE.

(It is not possible to hide the 'ACCS' list, which always displays the code: 'Li St'.)

# Marathon Monitors Inc.

---

## Promoting a parameter

Scroll through the lists to the required parameter and choose the 'PrO' code. The parameter is then automatically added (promoted) into the Home display list. (The parameter will also be accessible, as normal, from the standard lists.) A maximum of twelve parameters can be promoted. Promoted parameters are automatically 'alterable'.

# **Marathon Monitors Inc.**

---

This sheet intentionally left blank

## TUNING

Before tuning, please read Chapter 2, *Operation*, to learn how to select and change a parameter.

This chapter has five topics:

- WHAT IS TUNING?
- AUTOMATIC TUNING
- MANUAL TUNING
- COMMISSIONING OF MOTORISED VALVE CONTROLLERS
- GAIN SCHEDULING

### WHAT IS TUNING?

In tuning, you match the characteristics of the controller to those of the process being controlled in order to obtain good control. Good control means:

- Stable, 'straight-line' control of the process variable at setpoint without fluctuation
- No overshoot, or undershoot, of the process variable setpoint
- Quick response to deviations from the setpoint caused by external disturbances, thereby rapidly restoring the process variable to the setpoint value.

Tuning involves calculating and setting the value of the parameters listed in Table 4-1. These parameters appear in the 'Pi d' list.

Parameter	Code	Meaning or Function
Proportional band	Pb	The bandwidth, in display units, over which the output power is proportioned between minimum and maximum.
Integral time	t <sub>i</sub>	Determines the time taken by the controller to remove steady-state error signals.
Derivative time	t <sub>d</sub>	Determines how strongly the controller will react to the rate-of-change of the measured value.
High Cutback	Hcb	The number of display units, above setpoint, at which the controller will increase the output power, in order to prevent undershoot on cool down.
Low cutback	Lcb	The number of display units, below setpoint, at which the controller will cutback the output power, in order to prevent overshoot on heat up.
Relative cool gain	r <sub>EL</sub>	Only present if cooling has been configured and a module is fitted. Sets the cooling proportional band, which equals the Pb value divided by the r <sub>EL</sub> value.

## AUTOMATIC TUNING

Two automatic tuning methods are provided in the AACC 2000:

- **A one-shot tuner**, which automatically sets up the initial values of the parameters listed in Table 4-1 on the previous page.
- **Adaptive tuning**, which continuously monitors the error from setpoint and modifies the PID values, if necessary.

### One-shot Tuning

The 'one-shot' tuner works by switching the output on and off to induce an oscillation in the measured value. From the amplitude and period of the oscillation, it calculates the tuning parameter values.

If the process cannot tolerate full heating or cooling being applied during tuning, then the level of heating or cooling can be restricted by setting the heating and cooling power limits in the 'oP' list. However, the measured value *must* oscillate to some degree for the tuner to be able to calculate values.

A One-shot Tune can be performed at any time, but normally it is performed only once during the initial commissioning of the process. However, if the process under control subsequently becomes unstable (because its characteristics have changed), you can re-tune again for the new conditions.

It is best to start tuning with the process at ambient process variable. This allows the tuner to calculate more accurately the low cutback and high cutback values which restrict the amount of overshoot, or undershoot.

### How to tune

1. Set the setpoint to the value at which you will normally operate the process.
2. In the 'Atun' list, select 'tunE' and set it to 'on'.
3. Press the Page and Scroll buttons together to return to the Home display. The display will flash 'tunE' to indicate that tuning is in progress.
4. The controller induces an oscillation in the process variable by first turning the heating on, and then off. The first cycle is not complete until the measured value has reached the required setpoint.
5. After two cycles of oscillation the tuning is completed and the tuner switches itself off.
6. The controller then calculates the tuning parameters listed in Table 4-1 and resumes normal control action.

If you want 'Proportional only', 'PD', or 'PI' control, you should set the 'ti' or 'td' parameters to OFF before commencing the tuning cycle. The tuner will leave them off and will not calculate a value for them.

## Typical automatic tuning cycle

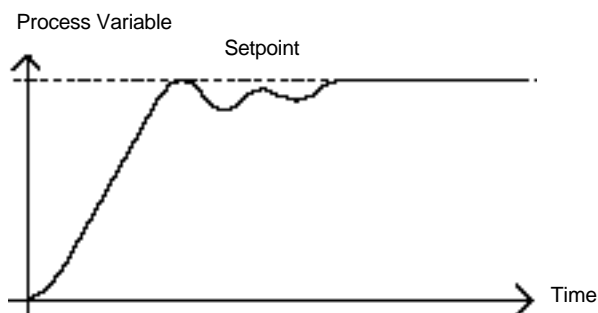

## Calculation of the cutback values

*Low cutback* and *High cutback* are values that restrict the amount of overshoot, or undershoot, that occurs during large step changes in process variable (for example, under start-up conditions).

If either low cutback, or high cutback, is set to 'AUTO' the values are fixed at three times the proportional band, and are not changed during automatic tuning.

## Adaptive tune

Adaptive tuning is a background algorithm, which continuously monitors the error from setpoint and analyses the control response during process disturbances. If the algorithm recognises an oscillatory, or under-damped, response it recalculates the  $P_b$ ,  $t_i$  and  $t_d$  values.

Adaptive tune is triggered whenever the error from setpoint exceeds a trigger level. This trigger level is set in the parameter 'drA.t', which is found in the Autotune list. The value is in display units. It is automatically set by the controller, but can also be manually re-adjusted.

*Adaptive tune should be used with:*

1. Processes whose characteristics change as a result of changes in the load, or setpoint.
2. Processes that cannot tolerate the oscillation induced by a One-shot tune.

*Adaptive tune should not be used:*

1. Where the process is subjected to regular external disturbances that could mislead the adaptive tuner.
2. On highly interactive multiloop applications. However, moderately interactive loops, such as multi-zone extruders, should not give a problem.

# Marathon Monitors Inc.

---

## MANUAL TUNING

If for any reason automatic tuning gives unsatisfactory results, you can tune the controller manually. There are a number of standard methods for manual tuning. The one described here is the Ziegler-Nichols method.

With the process at its normal running process variable:

1. Set the Integral Time 'ti' and the Derivative Time 'td' to OFF.
2. Set High Cutback and Low Cutback, 'Hcb' and 'Lcb', to 'Auto'.
3. Ignore the fact that the process variable may not settle precisely at the setpoint.
4. If the process variable is stable, reduce the proportional band 'Pb' so that the process variable just starts to oscillate. If the process variable is already oscillating, increase the proportional band until it just stops oscillating. Allow enough time between each adjustment for the loop to stabilise. Make a note of the proportional band value 'B' and the period of oscillation 'T'.
5. Set the Pb, ti, td parameter values according to the calculations given in Table 4-2.

Type of control	Proportional band 'Pb'	Integral time 'ti'	Derivative time 'td'
Proportional only	2xB	OFF	OFF
P + I control	2.2xB	0.8xT	OFF
P + I + D control	1.7xB	0.5xT	0.12xT

Table 4-2 Tuning values



# Marathon Monitors Inc.

---

## Setting the cutback values

The above procedure sets up the parameters for optimum steady state control. If unacceptable levels of overshoot or undershoot occur during start-up, or for large step changes in process variable, then manually set the cutback parameters 'LCB' and 'HCB'.

*Proceed as follows:*

1. Set the low and high cutback values to three proportional bandwidths (that is to say,  $Lcb = Hcb = 3 \times Pb$ ).
2. Note the level of overshoot, or undershoot, that occurs for large atmosphere changes (see the diagrams below).

In example (a) increase 'LCb' by the overshoot value. In example (b) reduce 'LCb' by the undershoot value.

### Example (a)

Atmosphere

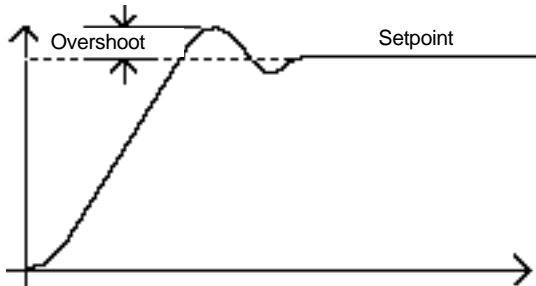

### Example (b)

Atmosphere

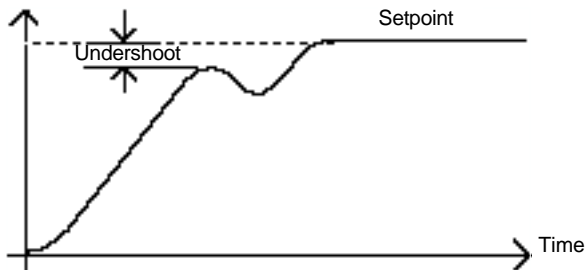

Where the atmosphere approaches setpoint from above, you can set 'Hcb' in a similar manner.

## Integral action and manual reset

In a full three-term controller (that is, a PID controller), the integral term 'ti' automatically removes steady state errors from the setpoint. If the controller is set up to work in two-term mode (that is, PD mode), the integral term will be set to 'OFF'. Under these conditions the measured value may not settle precisely at setpoint. When the integral term is set to 'OFF' the parameter *manual reset* (code 'rES') appears in the 'Pi d Li St' in 'FuLL' level. This parameter represents the value of the power output that will be delivered when the error is zero. You must set this value manually in order to remove the steady state error.

## Automatic droop compensation (Adc)

The steady state error from the setpoint, which occurs when the integral term is set to 'OFF' is sometimes referred to as 'droop'. 'Adc' automatically calculates the manual reset value in order to remove this droop. To use this facility, you must first allow the process variable to stabilise. Then, in the autotune parameter list, you must set 'Adc' to 'ON'. The controller will then calculate a new value for manual reset, and switch 'Adc' to 'OFF'.

'Adc' can be repeated as often as you require, but between each adjustment you must allow time for the process variable to stabilise.

# Marathon Monitors Inc.

---

## Motorized valve control

The AACC 2000 can be configured for motorised valve control as an alternative to the standard PID control algorithm. This algorithm is designed specifically for positioning motorised valves.

These are ordered pre-configured as Model numbers:

- 2000/VC motorised valve controllers
- 2000/VP motorised valve controllers with a single setpoint programmer
- 2000/V4 motorised valve controllers storing four setpoint programs.
- 2000/VM motorised valve controllers storing twenty setpoint programs.

Figure 1-11 in Chapter 1 shows how to connect a motorised valve controller. The control is performed by delivering open, or close, pulses in response to the control demand signal.

The motorised valve algorithm can operate in one of three ways:

1. The so-called *boundless* mode, which does not require a position feedback potentiometer for control purposes; although one can be connected and used purely to display the valve's position.
2. Bounded, (*or position*), control mode, which requires a feedback potentiometer. This is closed-loop control determined by the valve's position.

The desired control mode is selected in the 'i nSt' list in configuration level.

The following parameter list will appear in the navigation diagram shown in Chapter 2, if your controller is configured for motorised valve control.

Name	Description	Values		
mtr	<b>Motor list</b>	<b>Min</b>	<b>Max</b>	<b>Default</b>
tm	Valve travel time in seconds. This is the time taken for the valve to travel from its fully closed position to its fully open position.	0.1	240.0	30.0
lnt	Valve inertia time in seconds. This is the time taken for the valve to stop moving after the output pulse is switched off.	OFF	20.0	OFF
bAct	Valve backlash time in seconds. This is the minimum on-time required to reverse the direction of the valve. i.e. the time to overcome the mechanical backlash.	OFF	20.0	OFF
mp.t	Output pulse minimum on-time, in seconds.	Auto	100.0	Auto
U.br	Valve sensor break strategy.	rEST, uP, dwn		dwn

# Marathon Monitors Inc.

---

## COMMISSIONING THE MOTORISED VALVE CONTROLLER

The commissioning procedure is the same for both bounded and boundless control modes, except in bounded mode you must first calibrate the position feedback potentiometer, as described in the section below.

Proceed as follows:

1. Measure the time taken for the valve to be raised from its fully closed to its fully open position and enter this as the value in seconds into the 'tm' parameter.
2. Set all the other parameters to the default values shown in Table 4-3.

The controller can then be tuned using any of the automatic, or manual, tuning procedures described earlier in this chapter. As before, the tuning process, either automatic or manual, involves setting the values of the parameters in Table 4-1. The only difference with boundless control is that the derivative term 'td', although present, will have no effect.

### Adjusting the minimum on-time 'mp.t'

The default value of 0.2 seconds is satisfactory for most processes. If, however, after tuning the process, the valve activity is excessively high, with constant oscillation between raise and lower pulses, the minimum on-time can be increased.

The minimum on-time determines how accurately the valve can be positioned and therefore the control accuracy. The shorter the time, the more precise the control.

However, if the time is set too short, process noise will cause an excessively busy valve.

### Inertia and backlash settings

The default values are satisfactory for most processes, i.e. 'OFF'.

**Inertia** is the time taken for the valve to stop after the output pulse is turned off. If this causes a control problem, the inertia time needs to be determined and then entered into the parameter, 'ln.t'. The inertia time is subtracted from the raise and lower output pulse times, so that the valve moves the correct distance for each pulse.

**Backlash** is the output pulse time required to reverse the direction of the valve, i.e. the time taken to overcome the mechanical backlash of the linkages. If the backlash is sufficient to cause a control problem, then the backlash time needs to be determined and then entered into the parameter, 'bac.t'.

The above two values are not part of the automatic tuning procedure and must be entered manually.

## CALIBRATING THE POSITION FEEDBACK POTENTIOMETER



























Before proceeding with the feedback potentiometer calibration, you should ensure, in configuration level, that module position 2 (2a), or 3 (3a), has its 'i d' indicating 'Pot.i', (meaning *Potentiometer Input*). Continue to scroll down the module

# Marathon Monitors Inc.

---

configuration list. 'func' should be set to 'Vpos', 'VAL.L' must be set to '0' and 'VAL.H' to '100'.

Exit from configuration and you are now ready to calibrate the position feedback potentiometer. Proceed as follows.

1. In Operator level, press the AUTO/MAN button to put the controller in Manual mode.
2. Drive the valve to its fully open position using .
3. Press  until you get to 'i p-Li st'.
4. Press  to get to 'PCAL-OFF'.
5. Press  or  to turn 'PCAL' to 'on'.
6. Press  and the upper readout indicates 'Pot'.
7. Press  or  to get to 'Pot-3A.Hi'. (Assuming that the Potentiometer Input Module is in module position 3.)
8. Press  to go to 'GO-no'.
9. Press  or  to see 'GO-YES', which starts the calibration procedure.
10. Calibration is complete when the display returns to 'GO-no'.
11. Press  and  together to return directly to the Operator level.
12. The controller should still be in Manual mode.
13. Drive the valve to its fully closed position using .
14. Press  until you get to 'i p-Li st'.
15. Press  to get to 'PCAL-OFF'.
16. Press  or  to turn 'PCAL' to 'on'.
17. Press  and the upper readout indicates 'Pot'.
18. Press  or  to get to 'Pot-3A.Lo'.
19. Press  to go to 'GO-no'.
20. Press  or  to see 'GO-YES', which starts the calibration procedure.
21. Calibration is complete when the display returns to 'GO-no'.
22. Press  and  together to return directly to the Operator level.
23. Press the AUTO/MAN button to place the controller in AUTO and the calibration of the position feedback potentiometer is now complete.

# Marathon Monitors Inc.

---

## Gain scheduling

Gain scheduling is the automatic transfer of control between one set of PID values and another. In the case of the AACC 2000 controllers, this is done at a presettable process value. It is used for the more difficult to control processes which exhibit large changes in their response time or sensitivity at, for example, high and low process variables, or when heating or cooling.

The AACC 2000 has two sets of PID values. You can select the active set from either a digital input, or from a parameter in the PID list, or you can transfer automatically in gain scheduling mode. The transfer is bumpless and will not disturb the process being controlled.

To use gain scheduling, follow the steps below:



### Step 1: Enable in configuration level

Gain scheduling must first be enabled in Configuration level. Goto the Inst Conf list, select the parameter Gsch, and set it to YES.



### Step 2: Set the transfer point

Once gain scheduling has been enabled, the parameter G.SP will appear at the top of the Pi d list in FuLL access level. This sets the value at which transfer occurs. PID1 will be active when the process value is below this setting and PID2 when the process value is above it. The best point of transfer depends on the characteristics of the process. Set a value between the control regions that exhibit the greatest change

### Step 3: Tuning

You must now set up the two sets of PID values. The values can be manually set, or automatically tuned as described earlier in this chapter. When tuning automatically you must tune twice, once above the switching point G.SP and again below the switching point. When tuning, if the process value is below the transfer point G.SP the calculated values will automatically be inserted into PID1 set and if the process value is above G.SP, the calculated values will automatically be inserted into PID2 set.

## CONFIGURATION

This chapter consists of six topics:

- SELECTING CONFIGURATION LEVEL
- LEAVING CONFIGURATION LEVEL
- SELECTING A CONFIGURATION PARAMETER
- CHANGING THE PASSWORDS
- NAVIGATION DIAGRAM
- CONFIGURATION PARAMETER TABLES.

In configuration level you set up the fundamental characteristics of the controller. These are:

- The type of control (e.g. reverse or direct acting)
- The Input type and range
- The Setpoint configuration
- The Alarms configuration
- The Programmer configuration
- The Digital input configuration
- The Alarm Relay configuration
- The Communications configuration
- The Modules 1, 2 & 3 configuration
- Calibration
- The Passwords.

---

### WARNING



**Configuration is protected by a password and should only be carried out by a qualified person, authorised to do so. Incorrect configuration could result in damage to the process being controlled and/or personal injury. It is the responsibility of the person commissioning the process to ensure that the configuration is correct.**

---

## Selecting configuration level

There are two alternative methods of selecting Configuration level:



- If you have already powered up, then follow the access instructions given in Chapter 3, *Access levels*.

Alternatively, press  and  together when powering up the controller. This will take you directly to the 'CONF' password display.



### Password entry

When the 'CONF' display appears, you must enter the Configuration password (which is a number) in order to gain access to Configuration level.



Enter the password using the  or  buttons.

The configuration password is set to '2' when the controller is shipped from the factory.

Once the correct password has been entered, there is a two second delay, after which the lower readout will change to 'PASS' indicating that access is now unlocked.

*Note:* A special case exists if the password has been set to '0'. In this situation, access is permanently unlocked and the lower readout will always show 'PASS'.

Press  to enter configuration.

(If an incorrect password has been entered and the controller is still 'locked' then pressing  at this point will take you to the 'Exit' display with 'no' in the lower readout. Simply press  to return to the 'CONF' display.)

You will obtain the first display of configuration.





# Marathon Monitors Inc.



---

## LEAVING CONFIGURATION LEVEL

To leave the Configuration level and return to Operator level Press  until the 'Exit' display appears.

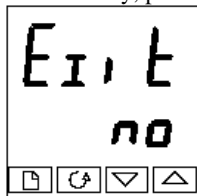
Alternatively, pressing  and  together will take you directly to the 'Exit' display



Use  or  to select 'YES'. After a two-second delay, the display will blank and revert to the Home display in Operator level.

## SELECTING A CONFIGURATION PARAMETER

The configuration parameters are arranged in lists as shown in the navigation diagram in



Figure 6.1.

**To step through the list headers**, press the Page  button.

**To step through the parameters** within a particular list press the Scroll  button. When you reach the end of the list you will return to the list header.

You can return directly to the list header at any time by pressing the Page  button.

### Parameter names

Each box in the navigation diagram shows the display for a particular parameter. The upper readout shows the name of the parameter and the lower readout its value. For a definition of each parameter, see the Configuration Parameter Tables at the end of this chapter. To change the value of a selected parameter, use the  and  buttons.

The navigation diagram shows all the lists headers and parameters that can, potentially, be present in the controller. In practice, those actually present will vary according to the particular configuration choices you make.

## Changing the passwords

There are TWO passwords. These are stored in the Password configuration list and can be selected and changed in the same manner as any other configuration parameter.

The password names are: 'ACC.P' which protects access to Full level and Edit level  
'cnF.P' which protects access to Configuration level.

# Marathon Monitors Inc.

## NAVIGATION DIAGRAM (PART A)

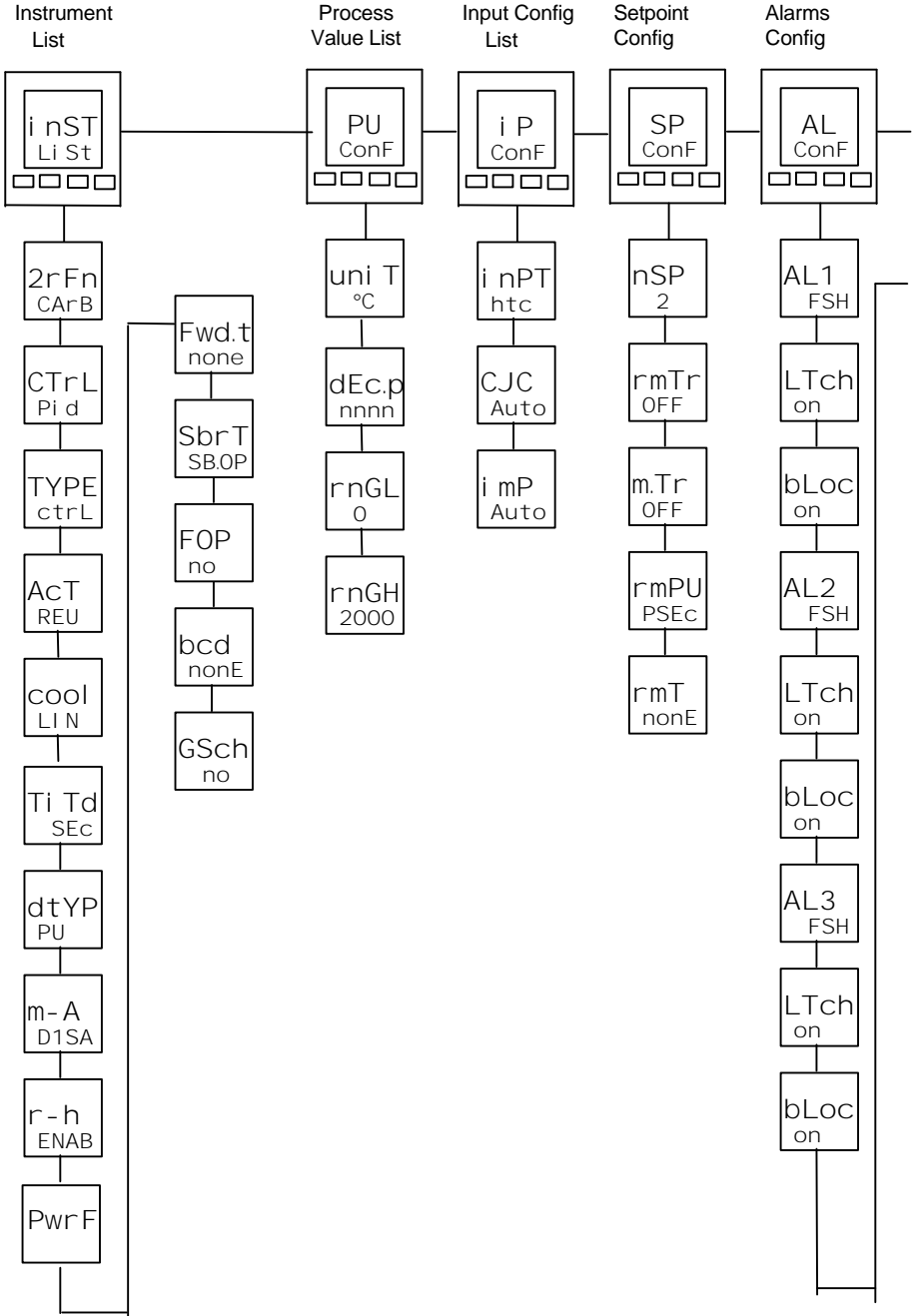

# Marathon Monitors Inc.

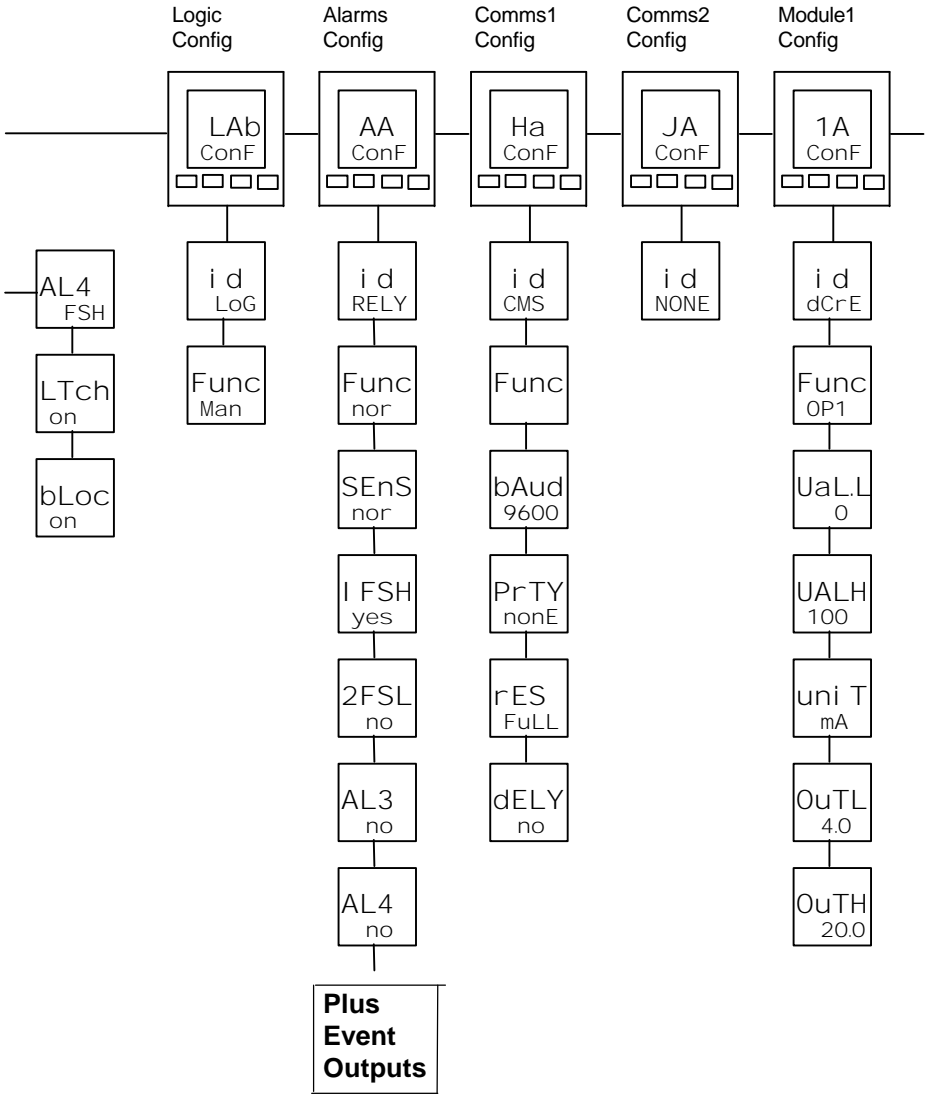

# Marathon Monitors Inc.

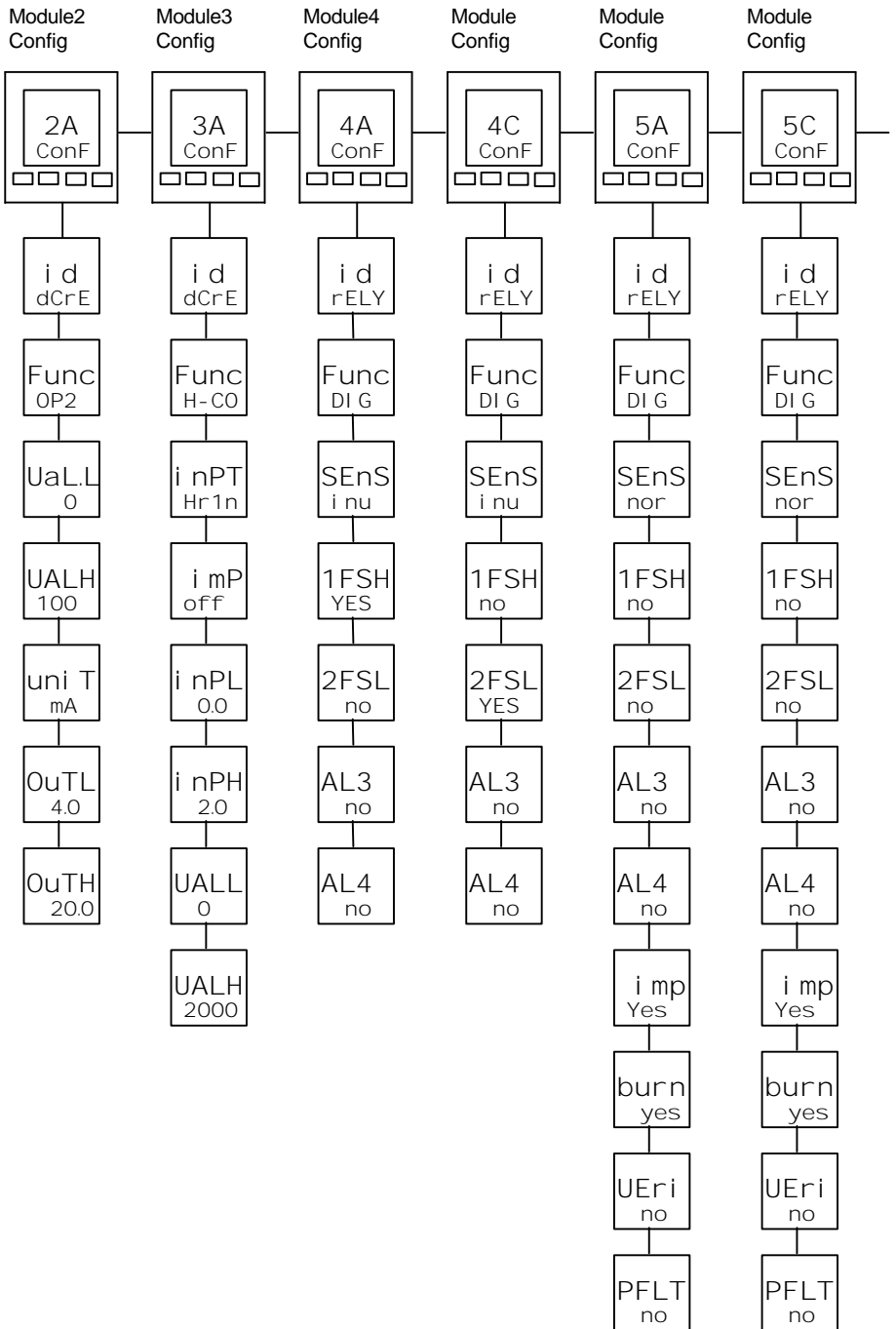

# Marathon Monitors Inc.

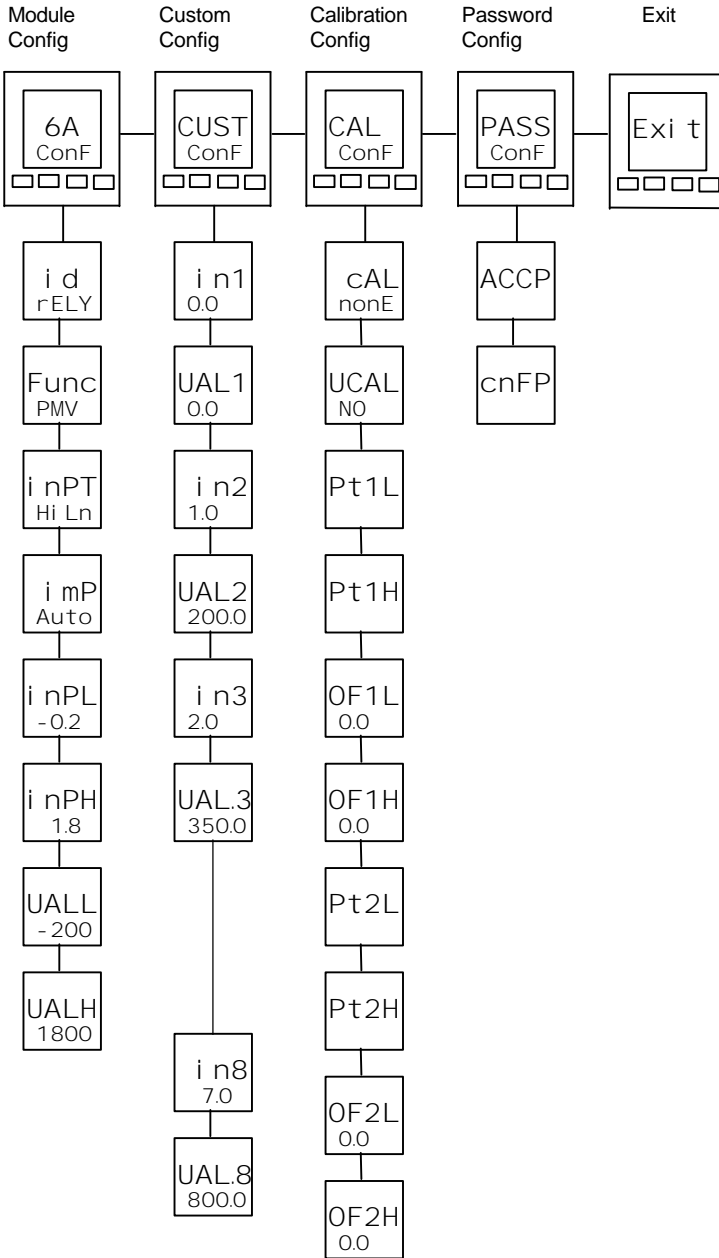

# Marathon Monitors Inc.

## CONFIGURATION PARAMETER TABLES

Name	Description	Values	Meaning
<b>i nSt</b>	<b>Instrument configuration</b>		
ZrFn	Instrument Function	Carb	% Carbon
Ctrl	Control type	Pi d On.OF VP  VP b	PID control On/off control Boundless motorised valve control - <i>no feedback required</i> Bounded motorised valve control - <i>feedback required</i>
tYPE	Instrument USE	ctrL Mon	Controller Monitor
Act	Control action	rEv di r	Reverse acting Direct acting
Cool	Type of cooling	Li n oi L  H2O FAn  ProP on.OF	Linear Oil (50mS minimum on-time) Water (non-linear) Fan (0.5S minimum on-time) Proportional only to error On/off cooling
ti .td	Integral & derivative time units	SEc mi n	Seconds, OFF to 9999 Minutes, OFF to 999.9
m-A	Front panel Auto/Man button	EnAb di SA	Enabled Disabled
r-h	Front panel Run/Hold button	EnAb di SA	Enabled Disabled
PwrF	Power feedback	on OFF	On Off
Fwd.t	Feed forward type	none FEEd SP.FF PV.FF	None Normal feed forward Setpoint feed forward PV feed forward
Sbr.t	Sensor break output	Sb.OP HoLd	Go to pre-set value Freeze output
FOP	Forced manual output	no  trac  Step	Bumpless Auto/Manual transfer Returns to the Manual value that was set when last in Manual mode Steps to forced output level. Value set in 'FOP' of 'op-Li st' in Operator Level
bcd	BCD input function	none prog sp	Not used Select program number Select setpoint number



# Marathon Monitors Inc.

**Linear Input Scaling** – The next 4 parameters only appear if a linear or sq rt input is chosen.

i np.L		Input value low
i np.H		Input value high
VAL.L		Displayed reading low
VAL.H		Displayed reading high

Name	Description	Values	Meaning
SP	<b>Setpoint configuration</b>		
nSP	Number of setpoints	2, 4, 16	Select number of setpoints available
rm.tr	Remote Tracking	OFF trAc	Disable Local setpoint tracks remote setpoint
m.tr	Manual Track	OFF trAc	Disable Local setpoint tracks PV when in manual
rmP.U	Setpoint rate limit units	PSEc Pmi n PHr	Per second Per minute Per hour
rmt	Remote setpoint configuration	nonE SP Loc.t rmt.t	Disable Remote setpoint Remote setpoint + local trim Remote trim + local setpoint



# Marathon Monitors Inc.

AL	Alarm configuration	Values
<i>The controller contains four 'soft' alarms, which are configured in this list. Once configured, they can be attached to a physical output as described in the alarm relay configuration list, 'AA Conf'.</i>		
AL1	Alarm 1 Type	<i>see Table A</i>
Ltch	Latching	no/YES/Evnt/mAn*
bLoc	Blocking	no/YES
AL2	Alarm 2 Type	<i>see Table A</i>
Ltch	Latching	no/YES/Evnt/mAn*
bLoc	Blocking	no/YES
AL3	Alarm 3 Type	<i>see Table A</i>
Ltch	Latching	no/YES/Evnt/mAn*
bLoc	Blocking	no/YES
AL4	Alarm 4 Type	<i>see Table A</i>
Ltch	Latching	no/YES/Evnt/mAn*
bLoc	Blocking (not if 'AL4' = 'rAt')	no/YES

Table A - Alarm types	
Value	Alarm type
OFF	No alarm
FSL	PV Full scale low
FSH	PV Full scale high
dEv	PV Deviation band
dHi	PV Deviation high
dLo	PV Deviation low
LCr	Load Current low
HCr	Load Current high
FL2	Input 2 Full Scale low
FH2	Input 2 Full Scale high
LOP	Working Output low
HOP	Working Output high
LSP	Working Setpoint low
HSP	Working Setpoint high
rAt	PV Rate of change <i>AL4 only</i>

## Alarm Modes

'no' means that the alarm will be non-latching.

'YES' means that the alarm will be latched, with automatic resetting. Automatic resetting means that if a reset is actioned before the alarm has cleared, then it will automatically reset when it clears

# Marathon Monitors Inc.

Name	Description	Values	Meaning
------	-------------	--------	---------

LA	Digital input 1 configuration		Action on contact closure
i d	Identity	LoG.i	Logic input
Func	Function of input <i>The function is active when the input has a contact closure to the common terminal - LC</i>	nonE mAn rmt SP.2 Pi d.2 ti H tunE drA Ac.AL AccS Loc.b uP  dwn  ScrL  PAGE  bcd.1 bcd.2 bcd.3 bcd.4 bcd.5 bcd.6 Stby  PV.SL  I MP	No function Manual mode select Remote setpoint select Setpoint 2 select PID set 2 select Integral hold One-shot self-tune enable Adaptive tune enable Acknowledge alarms Select Full access level Keylock Simulate pressing of the <input type="button" value="▲"/> button Simulate pressing of the <input type="button" value="▼"/> button Simulate pressing of the <input type="button" value="↻"/> button Simulate pressing of the <input type="button" value="□"/> button  Least significant BCD digit 2nd BCD digit 3rd BCD digit 4th BCD digit 5th BCD digit Most significant BCD digit Standby - ALL control outputs turned OFF (alarm Outputs are not affected) PV Select: Closed = PV1 / Open = PV2 Initiate Impedance test
	<i>These BCD inputs are used to select either a program number or the setpoint number according to the setting of the parameter 'bcd' in the 'i nSt' configuration list</i>		

Lb	Digital input 2 configuration		Action on contact closure
	As per <b>Digital input 1</b> configuration		

# Marathon Monitors Inc.

Name	Description	Values	Meaning
<b>AA</b>	<b>Alarm relay configuration</b>		
i d	Identity	rELy	Relay output
Func	Function	nonE dI G	No function Digital output
SEnS	Digital output sense	nor  i nv	Normal ( <i>output energises when TRUE, e.g. program events</i> )  Inverted ( <i>output de-energises when TRUE, e.g. alarms</i> )
<i>The following digital events appear after 'SEnS'. Any one, or more, of the events can be combined on to the output (see Fig. 6-2) by selecting 'YES' in the lower readout.</i>			
1 - - -	Alarm 1 active	YES / no	(- - -) = alarm type (e.g. FSL).  If an alarm has not been configured  in 'AL ConF' list, then display will  differ:- e.g. Alarm 1 = 'AL 1'.
2 - - -	Alarm 2 active	YES / no	
3 - - -	Alarm 3 active	YES / no	
4 - - -	Alarm 4 active	YES / no	
mAn	Controller in manual mode	YES / no	
Sbr	Sensor break	YES / no	
SPAn	PV out of range	YES / no	
Lbr	Loop break	YES / no	
Ld.F	Load failure alarm	YES / no	
tunE	Tuning in progress	YES / no	
dc.F	Voltage output open circuit, or mA output open circuit	YES / no	
rmt.F	module connection open circuit	YES / no	
i P1.F	Input 1 Failure		
I MP	Impedance test in progress		
burn	Probe burn off in progress		
VERI	Probe verification in progress		
VFLT	Verification Fault		
PFLT	Probe Fault		
nw.AL	New Alarm has occurred	YES / no	
End	End of setpoint rate limit, or end of program	YES / no	
SYnc	Program Synchronisation active	YES / no	

# Marathon Monitors Inc.

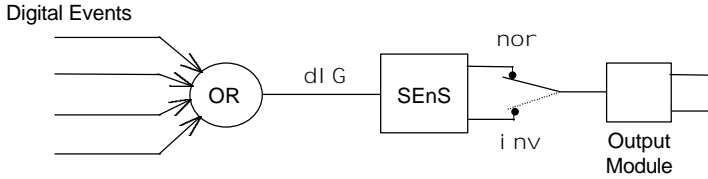

Figure 6-2 Combining several digital events on to one output

Name	Description	Values	Meaning
HA	<b>Comms 1 module config</b>		
i d	Identity of the module installed	cmS	2-wire EIA-485

For 'i d' = 'cmS' (Digital communications) use this parameter table:			
Func	Function	mod mAr	Modbus protocol Marathon Monitors protocol
bAud	Baud Rate	1200, 2400, 4800, 9600, 19.20(19,200)	
dELy	Delay - quiet period, required by some comms adaptors	no YES	No delay Delay active - 10mS
Prty	Comms Parity	nonE EvEn Odd	No parity Even parity Odd parity
<i>The following parameters only appear if the function chosen is Modbus protocol.</i>			
rES	Comms Resolution	FuLL I nt	Full resolution Integer resolution

# Marathon Monitors Inc.

JA	module config		
NO configuration required			
Name	Description	Values	Meaning

1A/b/C <sup>(1)</sup>	Module 1 configuration		
i d	Identity of module installed  <i>(1) If a dual-, or triple-, channel module is installed then the list headers 1b and 1C also appear</i>	nonE rELY dC.OP LoG LoG.i SSr dc.rE  dc.OP	Module not fitted Relay output Non-isolated DC output Logic/ output Logic input Triac output DC retransmission (isolated) Isolated DC output

For 'i d' = 'rELY', 'LoG', or 'SSr' use this parameter table:				
Func	Function  <i>(Only Channels 1A and 1C can be Heating, or Cooling)</i>  <i>(Only if 'i d' = 'LoG')</i> <i>(Only if 'i d' = 'LoG')</i>	nonE dI G HEAt COOL up dwn SSr.1 SSr.2	Function disabled Digital output function Heating output Cooling output Open motorised valve Close motorised valve mode 1 heating mode 2 heating	
VAL.L			% PID demand signal giving minimum output – 'Out.L'	
VAL.H			% PID demand signal giving maximum output – 'Out.H'	
Out.L				Minimum average power
Out.H				Maximum average power
SEnS	Sense of output <i>(Only if 'Func' = 'dI G')</i>	nor  i nv	Normal ( <i>output energises when TRUE, e.g program events</i> ) Inverted ( <i>output de-energises when TRUE, e.g. alarms</i> )	
<b>Notes:</b> 1. When 'SEnS' appears, then further parameters are available. These are identical to those in the 'AA ConF' list on Page 6-12.				

# Marathon Monitors Inc.

2. To invert a PID output, the Val. H can be set below the Val.L

Name	Description	Values	Meaning
------	-------------	--------	---------

For 'i d' = 'dc.OP', 'dc.rE', or 'dc.OP' use this parameter table:

Func	Function	nonE	Function disabled	
		HEAt	Heating output	
		COOL	Cooling output	
		PV	Retransmission of PV	
		wSP	Retransmission of setpoint	
		Err	Retransmission of error signal	
		OP	Retransmission of OP power	
VAL.L	<div style="display: flex; align-items: center;"> <div style="margin-right: 10px;">%PID, or Retransmission Value</div> </div>		% PID, or Retrans'n Value, giving minimum output	
VAL.H			% PID, or Retrans'n Value, giving maximum output	
uni t				vOLt = Volts, mA = milliamps
Out.L				Minimum electrical output
Out.H				Maximum electrical output

For 'i d' = 'LOG.i' (i.e logic input) use the 'LA Conf' list on Page 6-11.

2A/b/C	Module 2 configuration		
As per module 1 configuration, but excluding the 'SSr.1', 'SSr.2' functions.			
i d	Identity of module installed. As per module 2 plus:	tPSU	Transmitter power supply
		Pot.i	Potentiometer input

Continued on next page

# Marathon Monitors Inc.

For 'i d' = 'Pot.i (i.e. potentiometer input module) use this parameter table:			
Func	Function	nonE rSP Fwd.i rOP.h rOP.L VPoS	Function disabled Remote Setpoint Feedforward input Remote OP power max. Remote OP power min. Motorised valve position
VAL.L			Displayed value low equivalent to 0% potentiometer position
VAL.H			Displayed value high equivalent to 100% potentiometer position

# Marathon Monitors Inc.

<b>3A/b/C</b>	<b>Module 3 configuration</b>		
As per module 2 configuration, plus 'i d' = 'dC.i P'			
For 'i d' = 'dC.i P' use this parameter table. <b>THIS INCLUDES THE SECOND PV FUNCTIONS</b>			
Func	Function	nonE rSP Fwd.i rOP.h rOP.L Hi Lo Ftn    SEL  trAn	Function disabled Remote Setpoint Feedforward input Remote OP power max. Remote OP power min. PV = The highest of i P.1, or i P.2 PV = The lowest of i P.1, or i P.2 Derived function, where $PV = (f.1 \times i P1) + (f.2 \times i P2)$ . 'F.1' and 'F.2' are scalars which are found in 'i p-Li st' of Operator Level Select i p.1, or i p.2 via Comms, front panel buttons, or a digital input Transition of control between i p.1 and i p.2. The transition region is set by the values of 'Lo.l p' and 'Hi .l p', which are found in 'i p-Li st' of Operator Level. PV = i p.1 below 'Lo.l p' PV = i p.2 above 'Hi .l p'
i npt	Input type	Refer to 'i p Conf' for all types, + the following:	
		Hi l n	High Impedance (range = 0 to 2 volt)
CJC	Cold Junction Compensation	OFF Auto 0°C 45°C 50°C	No cold junction compensation Automatic internal compensation 0°C external reference 45°C external reference 50°C external reference
i mp	Sensor Break Impedance	Off Auto Hi Hi .Hi	Disabled ( <i>only with linear inputs</i> ) Factory set Impedance of input > 15KΩ Impedance of input > 30KΩ



# Marathon Monitors Inc.

**Linear Input Scaling** – *The next four parameters only appear if a linear input is chosen.*

i nP.L		Input value low	
i nP.H		Input value high	
VAL.L		Displayed value low	
VAL.H		Displayed value high	
<b>Name</b>	<b>Description</b>	<b>Values</b>	<b>Meaning</b>

4 A /C	<b>Module configuration</b>		
As per module AA configuration			

5 A /C	<b>Module configuration</b>		
As per module AA configuration			

<b>Name</b>	<b>Description</b>	<b>Values</b>	<b>Meaning</b>
-------------	--------------------	---------------	----------------

6A	<b>Module configuration</b>		
i d	Identity of module DC input	rELy	DC input
Func	Function	nonE	Pin v probe mv input
i nPT	Input type	Hi l n	High Impedance (range = 0 to 2 volt)
i nP.L		Input value low	
i nP.H		Input value high	
VAL.L		Displayed value low	
VAL.H		Displayed value high	

# Marathon Monitors Inc.

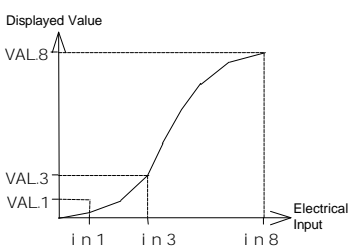
Cust	8-point Custom Linearisation <sup>(1)</sup>	
i n 1	 <p>The graph shows a curve representing the relationship between 'Electrical Input' (x-axis) and 'Displayed Value' (y-axis). The x-axis has points labeled 'i n 1', 'i n 3', and 'i n 8'. The y-axis has points labeled 'VAL.1', 'VAL.3', and 'VAL.8'. The curve starts at (i n 1, VAL.1), passes through (i n 3, VAL.3), and ends at (i n 8, VAL.8). The curve is non-linear, showing a steeper slope between i n 3 and i n 8.</p>	Custom input 1
VAL.1		Linearisation Value representing i n 1
i n 8		Custom input 8
VAL.8		Linearisation Value representing i n 8

**Note:**

1. Custom Linearisation is only available when '3a-Conf' or i P- Conf list has 'i npt' set to 'mV.C', or 'mAC', or 'V.C'.
1. The values and inputs must be continuously increasing or decreasing

# Marathon Monitors Inc.

Name	Description	Values	Meaning
------	-------------	--------	---------

CAL	Calibration		
<i>In this mode you can</i> <ol style="list-style-type: none"> <li>1. Calibrate the instrument using a mV source - rCAL or ref source cal.</li> <li>2. Offset the calibration to account for errors in actual sensor measurement and a ref sensor - UCAL or user calibration</li> <li>3. Return to factory set calibration - FACT or factory set calibration.</li> </ol>			
rCAL	Calibration point	nonE	No calibration
		PV	Calibrate main Process Value input.
		PV.2	Calibrate DC input, or PV 2.
		1A.Hi	Calibrate DC output high - Module 1
		1A.Lo	Calibrate DC output low - Module 1
		2A.Hi	Calibrate DC output high - Module 2
		2A.Lo	Calibrate DC output low - Module 2
		3A.Hi	Calibrate DC output high - Module 3
		3A.Lo	Calibrate DC output low - Module 3

▶ Goto User calibration table-See also chapter 7

▶ Go to input Calibration table

▶ Go to DC Output Calibration table

<b>INPUT CALIBRATION</b>			
<i>For 'CAL' = 'PV', or 'PV.2', the following parameters apply.</i>			
PV	PV Calibration Value  <ol style="list-style-type: none"> <li>1. Select calibration value</li> <li>2. Apply specified input</li> <li>3. Press <input type="button" value="G"/> to step to 'GO'</li> </ol> <p style="text-align: right; margin-top: 10px;"><i>See Note below.</i></p>	I dLE	Idle
		mv.L	Select 0mV as the calibration point
		mv.H	Select 50mV as the calibration point
		V 0	Select 0Volt as the calibration point
		V 10	Select 10V as the calibration point
		CJC	Select 0°C CJC calibration point
		rtd	Select 400Ω as the calibration point
		HI 0	High impedance: 0Volt cal'n point
		HI 1.0	High impedance: 1.0 Volt cal'n point
		FACT	Restore factory calibration
GO	Start calibration	no	Waiting to calibrate PV point

# Marathon Monitors Inc.

Select 'YES' with ▲ or ▼ Wait for calibration to complete.	YES	Start calibration
	buSy	Busy calibrating
	donE	PV input calibration completed
	FAI L	Calibration failed

**Note.** When a DC input module is installed for the first time, or there is a requirement to change one, then the microprocessor in the controller needs to read the factory calibration data stored in the module. Select 'FACT' as the calibration value. Step to 'GO' and start calibration.

<b>DC Output Calibration</b>			
<i>The following parameters apply to DC output modules ie for rCAL = 1A.Hi to 3A.Lo</i>			
cAL.H	Output Calibration High	0	0 = Factory set calibration. Trim value until output = 9V, or 18mA
cAL.L	Output Calibration Low	0	0 = Factory set calibration. Trim value until output = 1V, or 2mA

<b>User calibration</b>		
UCAL	User calibration enable	Yes/no
pt1.L	Low calibration point for Input 1	The factory calibration point at which the low point offset was performed.
pt1.H	High calibration point for Input 1	The factory calibration point at which the high point offset was performed.
OF1.L	Offset Low for Input 1	Calculated offset, in display units.
OF1.H	Offset High for Input 1	Calculated offset, in display units.
pt2.L	Low calibration point for Input 2	The factory calibration point at which the low point offset was performed.
pt2.H	High calibration point for Input 2	The factory calibration point at which the high point offset was performed.
OF2.L	Offset Low for Input 2	Calculated offset, in display units.
OF2.H	Offset High for Input 2	Calculated offset, in display units.

<b>Name</b>	<b>Description</b>	<b>Values</b>	<b>Meaning</b>
PASS	<b>Password configuration</b>		
ACC.P	FuLL or Edit level password		
cnF.P	Configuration level password		
Exi t	<b>Exit configuration</b>	no/YES	

## User calibration

This chapter has five topics:

- WHAT IS THE PURPOSE OF USER CALIBRATION?
- USER CALIBRATION ENABLE
- OFFSET CALIBRATION
- TWO POINT CALIBRATION
- CALIBRATION POINTS AND CALIBRATION OFFSETS

To understand how to select and change parameters in this chapter you will need to have read Chapter 2 - *Operation*, Chapter 3- *Access Levels* and Chapter 6 - *Configuration*.

### WHAT IS THE PURPOSE OF USER CALIBRATION?

The basic calibration of the controller is highly stable and set for life. User calibration allows you to offset the 'permanent' factory calibration to either:

1. Calibrate the controller to the your reference standards.
2. Match the calibration of the controller to that of a particular transducer or sensor input.
3. Calibrate the controller to suit the characteristics of a particular installation.
4. Remove long term drift in the factory set calibration.

**User calibration works by introducing a single point, or two-point, offset onto the factory set calibration.**

## User Calibration Enable

The User calibration facility must first be enabled in configuration level by setting the parameter 'UCAL' in the input conf list to 'YES'. This will make the User calibration parameters visible in Operator 'FULL' level.

Select configuration level as shown in Chapter 5, *Configuration*.

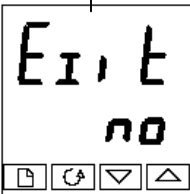

### The Calibration Configuration List



Press  until you reach the 'CAL-Conf' list.

Press  until you reach 'UCAL'.



### User Calibration Enable

Use  or  to select:

- YES: Calibration enable
- no: Calibration disabled

Press  and  together to go to the Exit display.

### Exit configuration

Use  or  to select 'YES' to return to Operator level.

## Offset calibration

Offset calibration is used to apply a single fixed offset over the full display range of the controller.

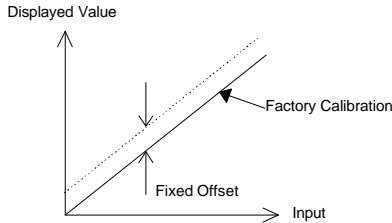

To calibrate, proceed as follows:

1. Connect the input of the controller to the source device to which you wish to calibrate.
2. Set the source to the desired calibration value.
3. The controller will display the current measurement of the value.
4. If the displayed value is correct, then the controller is correctly calibrated and no further action is necessary. If it is incorrect, then follow the steps shown below. Select 'FuLL' access level, as described in Chapter 3.

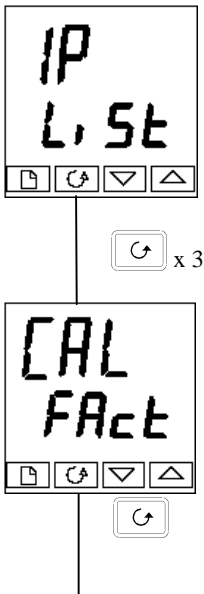

### Input list header

Press  until you reach the input list header.

Press  until you reach the 'CAL' display.

### Calibration type

- FACT: Factory Calibration
- USEr: User Calibration

Use  or  to select 'FACT'.

Selecting 'FACT' reinstates the factory calibration and allows the application of a single fixed offset.

Press  continued on the next page

# Marathon Monitors Inc.

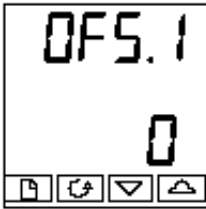

See table on the right for additional parameters.

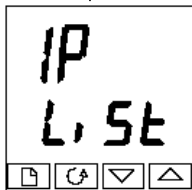

## Set Offset 1

Use or to set the offset value of Process Value 1 (PV1).

The offset value is in display units Press

## Set Offset 2

Use or to set the offset value of Process Value 2 (PV2), *if configured*.

The offset value is in display units.

Press

The table below shows the parameters which appear after 'OFS.2'. These are all read only values and are for information. Press to step through them.

mV.1	IP1 measured value (at terminals)
mV.2	IP2 measured value (at terminals), if DC input in Module 3 position
CJC.1	IP1 Cold Junction Compensation
CJC.2	IP2 Cold Junction Compensation
Li .1	IP1 Linearised Value
Li .2	IP2 Linearised Value
PV.SL	Shows the currently selected input

If you do not want to look at these parameters, then press and this returns you to the 'i P-Li St' header.

To protect the calibration against unauthorised adjustment, return to Operator level and make sure that the calibration parameters are hidden. Parameters are hidden using the 'Edit' facility described in Chapter 3, *Access Levels*



# Marathon Monitors Inc.

## Two-point calibration

The previous section described how to apply a offset, or trim, calibration, which applies a fixed offset over the full display range of the controller. A two-point calibration is used to calibrate the controller at two points and applies a straight line between them. Any readings above, or below, the two calibration points will be an extension of this straight line. For this reason it is best to calibrate with the two points as far apart as possible.

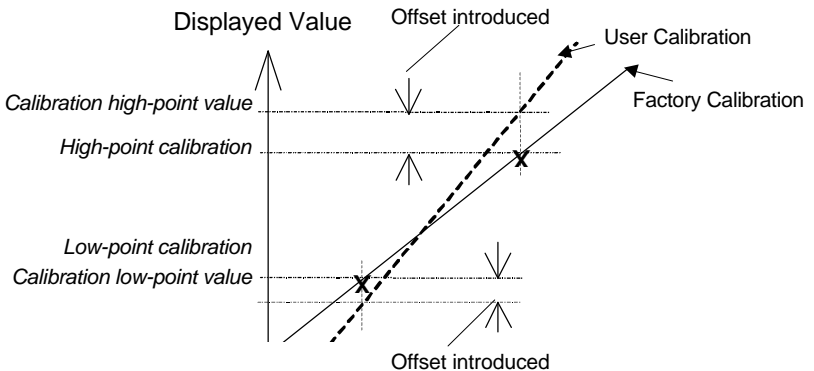

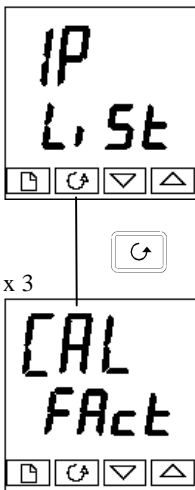

Proceed as follows:

1. Decide upon the low and high points at which you wish to calibrate.
2. Perform a two point calibration in the manner described below



### Input list header

Press  until you reach the input list header, 'i p Li St'.

Press  until you reach the 'CAL' display.

### Calibration type

- FACT: Factory Calibration
- USER: User Calibration

Use  or  to select 'USER'.

Selecting 'USER' enables two-point calibration.

[If two-point calibration is unsatisfactory, select 'FACT' to return to the factory set calibration.]

Press 

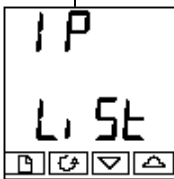

## Select Low-point Calibration

This is the Calibration Status display. This display shows that no input is selected for calibration.

- none: No selection
- i p1.L: Input 1 (PV1) calibration low-point selected
- i p1.H: Input 1 (PV1) calibration high-point selected
- i p2.L: Input 2 (PV2) calibration low-point selected
- i p2.H: Input 2 (PV2) calibration high-point selected

Use / to select the parameter for the Low Calibration point of Input 1, 'i p1.L'.

Press

## Adjust low-point calibration

This is the display for adjusting the Low Calibration point of Input 1. The lower readout is a live reading of the process value, which changes as the input changes.

Make sure that the calibration source is connected to the terminals of Input 1, switched on and feeding a signal to the controller. It should be set to the desired low-point calibration value. If the lower readout does not show this value, then use / to adjust the reading to the required value.

Press to return to the 'i p-Li St' header.

To perform the High-point Calibration, repeat the above procedure, selecting 'i p1.H' in the 'CAL.S' display for adjustment.

Press three times.

## Calibration type

'USER' was selected for the Low-point Calibration, and has remained selected.

Press

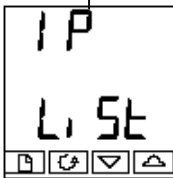
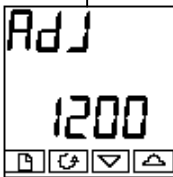

## Select High-point Calibration

This is the Calibration Status display, again.

Use / to select the parameter for the High-point Calibration of Input 1, 'i p1.H'.

Press

## Adjust High-point Calibration

This is the display for adjusting the High Calibration point of Input 1. The lower readout is a live reading of the process value, which changes as the input changes.

Feed the desired high-point calibration signal to the controller, from the calibration source. If the lower readout does not show this value, then use / to adjust the reading to the required value.

Press to return to the 'i p-Li St' header.

To protect the calibration against unauthorised adjustment return to Operator level and make sure that the calibration parameters are hidden. Parameters are hidden using the 'Edi t' facility described in Chapter 3.

To perform a User Calibration on Input 2, proceed as with Input 1 above, except that when 'CAL-S-nonE' appears, press / until 'CAL-S-i P2.L' is obtained, then proceed as with Input 1. Repeat the procedure for 'i P2.H'

# Marathon Monitors Inc.



---

## Calibration points and Calibration offsets

If you wish to see the points at which the User calibration was performed and the value of the offsets introduced, then these are shown in Configuration, in 'CAL - Conf'.

The parameters are:

Name	Parameter description	Meaning
pt1.L	Low calibration point for Input 1	The factory calibration point at which the low point offset was performed.
pt1.H	High calibration point for Input 1	The factory calibration point at which the high point offset was performed.
OF1.L	Offset Low for Input 1	Calculated offset, in display units.
OF1.H	Offset High for Input 1	Calculated offset, in display units.
pt2.L	Low calibration point for Input 2	The factory calibration point at which the low point offset was performed.
pt2.H	High calibration point for Input 2	The factory calibration point at which the high point offset was performed.
OF2.L	Offset Low for Input 2	Calculated offset, in display units.
OF2.H	Offset High for Input 2	Calculated offset, in display units.

**Note:** The value of each of the parameters in the above table may also be altered by using the / buttons.

## Parameter Table (Default)

### Home list

Process Variable	
Target Setpoint	
Output power	OP
Auto/Manual Mode	M-a
Reference Number	rEF

### Probe List

Process Factor	PF
Milivolt Offset	OFFS
H-CO Compensation	H-CO
Probe Temperature	Ptc
Probe Millivolts	Pmv
Auxilliary Input	Axin

### Care List

Care	CArE
Measured Recovery Time	prr.r
Temperature Minimum	tmin
Verification Test Result	VrF.r
Probe Test Interval	Pti
Maximum Impedance	imPH
Probe Test Recovery Time	Prrt
Burn Off Time	bot
Burn Off Recovery Time	bort
Final Delay	FdE
Time Of Average 2	tA2
Probe Impedance Result	imp.r

# Marathon Monitors Inc.

---

## User List

Number 1	n1	
Number 2	n2	
Number 3	n3	
Number 4	n4	
Number 5	n5	
Number 6	n6	
Number 7	n7	
Number 8	n8	
Number 9	n9	
Number 10	n10	
Number 11		n11
Number 12		n12
Number 13		n13
Number 14		n14
Number 15		n15

## Alarm List

Alarm 1 Setpoint	1---
Alarm 2 Setpoint	2---
Alarm 3 Setpoint	3---
Alarm 4 Setpoint	4---
Alarm 1 Hysteresis	HY1
Alarm 2 Hysteresis	HY2
Alarm 3 Hysteresis	HY3
Alarm 4 Hysteresis	HY4
Loop Break Time	Lbt
Enable Diagnostic Messages	diAG

## Autotune List

Autotune Enable	tunE
Automatic manual Reset Calculation	Adc

# Marathon Monitors Inc.

---

## PID List

Gain Scheduler Setpoint	G.SP	
Current PID Set		Set
Proportional Band PID1	Pb	
Integral Time PID1	ti	
Derivative Time PID1	td	
Manual Reset		rES
Cutback High	Hcb	
Cutback Low PID1	Lcb	
Relative Cool Gain PID1	rEL.C	
Proportional Band PID2	Pb2	
Integral Time PID2	ti2	
Derivative Time PID2	td2	
Manual Reset PID2	rES2	
Cutback High PID2	Hcb2	
Cutback Low PID2	Lcb2	
Relative Cool Gain PID2	rEL2	
FeedForward Proportional Band	FF.Pb	
FeedForward Trim Limit	FF.du	

## Motor List

Valve Travel Time	tm	
Valve Inertia Time	Int	
Valve Backlash Time	bAct	
Minimum On Time	MP.t	
Valve Sensor Break Strategy	U.br	

## Setpoint List

Setpoint Select		SSEL
Setpoint 1	SP1	
Setpoint 2	Sp2	
Setpoint 1 Low Limit	SPL	
Setpoint 1 High Limit	SPH	
Setpoint 2 Low Limit	SP2L	
Setpoint 2 High Limit	SP2H	
Local Setpoint trim	Hbty	

# Marathon Monitors Inc.

---

## Input List

Filter 1	FiLt
Filter 2	FLt2
Filter 3	FLT3
Calibration	CAL
CJC Temperature	CJC

## Output List

Low Power Limit	OP.Lo
High Power Limit	OP.Hi
Output Rate Limit	Opr
Forced Output Power	FOP
Cycle time OP1	CYC.1
Hysteresis OP1	hYS.1
OP1 Minimum On Time	ont.1
Cycle time OP2	CYC.2
Hysteresis OP1	hYS.2
OP2 Minimum On time	ont.2
Deadband	db
Sensor Break Output Power	Sb.OP

## Comms List

Comms Address	Addr
---------------	------

## Info List

Custom Display Type	diSP
SPC Minimum PV	LoG.L
SPC Maximum PV	Log.H
SPC Mean PV	LoG.A
SPC Time above TIME Trigger	LoG.t
PV Threshold for Timer Log	LoG
SPC Reset	rES
Control task execution	
time high water mark	mCt
Working Output	w.OP
Feedforward Output	FF.OP
Proportional Output	Pop
Integral Output	IOP
Derivative Output	dOP

Continued on next page.....



# Marathon Monitors Inc.

---

## Configuration Mode Parameters

### Inst Conf

Function: O2, %C, Dewpoint, Redox	Zr.Fn	
Control Type		Ctrl
Instrument type: Monitor/Controller	tYPE	
Control Action		Act
Control Time Units	ti.td	
Manual Key Enable	m-A	
dtYP	dtYP	
Feedforward Type	Fwd.t	
Bumpless PD Control	Pd.tr	
Sensor Break Action	Sbr.t	
Forced Manual Availability	FOP	
BCD Input Function	bcd	
Gain Scheduling	Gsch	

### PV Conf

Instrument Units		unit
Display Resolution	dEc.P	
Exponent	ExP	
Setpoint Minimum	rnG.L	
Setpoint maximum	rnG.H	

### IP Conf

Linearisation type	inPt	
CJC Type	CJC	
Sensor break Impedance	imP	

### SP Conf

Number of Setpoints	nSP	
Remote Tracking Configuration	rm.tr	
manual track Configuration	m.tr	
SRL rate units		rmP.U
Remote Setpoint Configuration	rmt	

Continued on next page.....

# Marathon Monitors Inc.

---

## Alarm Conf

Alarm 1 Type	AL1	
Alarm 1 Latch	Ltch	
Alarm 1 Block		bLoc
Alarm 2 Type	AL2	
Alarm 2 Latch	Ltch	
Alarm 2 Block	bLoc	
Alarm 3 Type	AL3	
Alarm 3 Latch	Ltch	
Alarm 3 Block	bLoc	
Alarm 4 Type	AL4	
Alarm 4 Latch	Ltch	
Alarm 4 Block	bLoc	

## LA/B Conf

Logic Input A Ident	id	
Logic Input A Slot Function	Func	
Logic Input B Ident	id	
Logic Input B Slot Function	Func	

## Module AA Conf

Fixed Module AA Ident	id	
Fixed Module AA Slot Function	Func	
Summary OP AA invert	Sens	
Summary OP AA Conf		

## Module H Conf

Interface Module H Ident	id	
Interface Module H Slot Function	Func	
Baud Rate	bAud	
Comms Parity		Prty
Comms Resolution	rES	
Comms Delay	dELY	

## Module 1A Conf

Module 1A Ident	id	
Module 1A Slot Function	Func	
Module 1A Low Value	VAL.L	
Module 1A High Value	VAL.H	
Output 1A units	unit	
Module 1A Low Output Range	Out.L	
Module 1A High Output Range	Out.H	

Continued on next page.....

# Marathon Monitors Inc.

---

## Module 2A Conf

Module 2A Ident	id
Module 2A Slot Function	Func
Module 2A Low Value	VAL.L
Module 2A High Value	VAL.H
Output 2A units	unit
Module 2A Low Output Range	Out.L
Module 2A High Output Range	Out.H

## Module 3A Conf

Module 3A Ident	id
Module 3A Slot Function	Func
Module 3A Input Type	inPt
Module 3A Sensor break Impedance	iMP
Module 3A Input Value Low	inP.L
Module 3A Input Value High	inP.H
Module 3A Displayed Value Low	VAL.L
Module 3A Displayed Value High	VAL.H

## Module 4A Conf

Module 4A Ident	id
Module 4A Slot Function	Func
Summary OP 4A Invert	SEnS
Summary OP 4A configuration	

## Module 4C Conf

Module 4C Ident	id
Module 4C Slot Function	Func
Summary OP 4C Invert	SEnS
Summary OP 4C configuration	

## Module 5A Conf

Module 5A Ident	id
Module 5A Slot Function	Func
Summary OP 5A Invert	SEnS
Summary OP 5A configuration	

## Module 5C Conf

Module 5C Ident	id
Module 5C Slot Function	Func
Summary OP 5C Invert	SEnS
Summary OP 5C configuration	

Continued on next page.....

# Marathon Monitors Inc.

---

## Module 6A Conf

Module 6A Ident	id
Module 6A Slot Function	Func
Module 6A Input Type	inPt
Module 6A Sensor break Impedance	iMP
Module 6A Input Value Low	inP.L
Module 6A Input Value High	inP.H
Module 6A Displayed Value Low	VAL.L
Module 6A Displayed Value High	VAL.H

## CUST Conf

Input 1	in 1
Value 1	VAL.1
Input 2	in 2
Value 2	VAL.2
Input 3	in 3
Value 3	VAL.3
Input 4	in 4
Value 4	VAL.4
Input 5	in 5
Value 5	VAL.5
Input 6	in 6
Value 6	VAL.6
Input 7	in 7
Value 7	VAL.7
Input 8	in 8
Value 8	VAL.8

## CAL Conf

## PASS Conf

Access Mode User Password	ACC.P
Configuration Mode User Password	cnF.P

Continued on next page.....

# Marathon Monitors Inc.

---

## Special Parameters

### ABC Constant Transfer

A Constant low 16 bits

A Constant high 16 bits

B Constant low 16 bits

B Constant high 16 bits

C Constant low 16 bits

C Constant high 16 bits

Transfer Location, 0 - 15

Transfer Action; 81=write, 82=read

## INDEX

ACCESS LEVELS .....	46
Adaptive tune .....	38, 54, 73
<b>Adjust low-point calibration</b> .....	89
Adjusting the minimum on-time .....	59
Alarm types .....	37, 43, 72
Alarms .....	22, 25, 43, 62, 65, 66
<b>Automatic mode</b> .....	22, 26, 27
<b>Backlash</b> .....	59
<b>Blocking</b> .....	43, 72
CALIBRATING THE POSITION FEEDBACK POTENTIOMETER .....	59
Changing the passwords .....	64
COMMISSIONING THE MOTORISED VALVE CONTROLLER .....	59
<b>Comms</b> .....	34, 41, 66, 75, 79
Communication .....	8, 19, 30, 41, 62
Configuration level .....	44, 46, 47, 48, 61, 63, 64, 83
Configuration password .....	42, 48, 63
<b>Diagnostic alarms</b> .....	37, 43, 44, 45
Gain scheduling .....	61
<b>Home</b> .....	25, 27, 28, 29, 30, 32, 36, 41, 43, 47, 49, 50, 53, 64
<b>Inertia</b> .....	59
Inertia and backlash settings .....	59
Input list header .....	88
Installation .....	12
<b>Latching</b> .....	43, 72
Level selection .....	48
<b>Manual mode</b> .....	22, 26, 36, 60, 69, 73
Navigation .....	65
<b>Non-latching</b> .....	43
offset calibration .....	86
PARAMETERS .....	30
Password entry .....	47, 63
Process alarms .....	43
Promoting a parameter .....	50
SAFETY and EMC INFORMATION .....	4
<b>Select Low-point Calibration</b> .....	89
SELECTING A CONFIGURATION PARAMETER .....	64
<b>Setpoint</b> .....	17, 24, 25, 27, 29, 30, 33, 36, 37, 40, 62, 65, 69, 71, 72, 73, 78, 79
Snubbers .....	16
Technical Specification .....	8
TUNING .....	52, 53, 55

# Marathon Monitors Inc.

---

Two-point calibration .....	88
User calibration .....	84

## Free Manuals Download Website

<http://myh66.com>

<http://usermanuals.us>

<http://www.somanuals.com>

<http://www.4manuals.cc>

<http://www.manual-lib.com>

<http://www.404manual.com>

<http://www.luxmanual.com>

<http://aubethermostatmanual.com>

Golf course search by state

<http://golfingnear.com>

Email search by domain

<http://emailbydomain.com>

Auto manuals search

<http://auto.somanuals.com>

TV manuals search

<http://tv.somanuals.com>