

Owner's Manual

N°432
N°431

markit
evinson®
MISSION: MAKE IT EASIER

WARNING: TO REDUCE THE RISK OF FIRE OR ELECTRIC SHOCK, DO NOT EXPOSE THIS APPLIANCE TO RAIN OR MOISTURE.



The lightning flash with arrowhead symbol, within an equilateral triangle, is intended to alert the user to the presence of uninsulated “dangerous voltage” within the product’s enclosure that may be of sufficient magnitude to constitute a risk of electric shock to persons.



The exclamation point within an equilateral triangle is intended to alert the user to the presence of important operating and maintenance (servicing) instructions in the literature accompanying the appliance.



Marking by the “CE” symbol (shown left) indicates compliance of this device with the EMC (Electromagnetic Compatibility) and LVD (Low Voltage Directive) standards of the European Community.

NOTICE

This equipment has been tested and found to comply with the limits for a Class B digital device, pursuant to Part 15 of the FCC Rules. These limits are designed to provide reasonable protection against harmful interference in a residential installation. This equipment generates, uses and can radiate radio frequency energy and, if not installed and used in accordance with the instructions, may cause harmful interference to radio communications. However, there is no guarantee that interference will not occur in a particular installation. If this equipment does cause interference to radio or television reception, which can be determined by turning the equipment on and off, the user is encouraged to try to correct the interference by one or more of the following measures:

- Reorient or relocate the receiving antenna;
- Increase the separation between the equipment and the receiver;
- Connect the equipment into an outlet on a circuit different from that to which the receiver is connected;
- Consult the dealer or an experienced radio/TV technician for help.

This digital apparatus does not exceed the Class B limits for radio noise emissions from digital apparatus set out in the Radio Interference Regulations of the Canadian Department of Communications.

Le present appareil numerique n'emet pas de bruits radioelectriques depassant les limites applicables aux appareils numeriques de la class B prescrites dans le Reglement sur le brouillage radioelectrique edicte par le ministere des Communications du Canada

CAUTION: Changes or modifications not expressly approved by the party responsible for compliance could void the user’s authority to operate the equipment.

Important Safety Instructions

Please read all instructions and precautions carefully and completely before operating your Mark Levinson power amplifier.

1. **ALWAYS** disconnect your entire system from the AC mains before connecting or disconnecting any cables, or when cleaning any component.
2. This product must be terminated with a three-conductor AC mains power cord that includes an earth ground connection. To prevent shock hazard, all three connections must **ALWAYS** be used.
3. AC extension cords are **not** recommended for use with this product.
4. **NEVER** use flammable or combustible chemicals for cleaning audio components.
5. **NEVER** operate this product with any covers removed.
6. **NEVER** wet the inside of this product with any liquid.
7. **NEVER** pour or spill liquids directly onto this unit.
8. **NEVER** block airflow through ventilation slots or heat sinks.
9. **NEVER** bypass any fuse.
10. **NEVER** replace any fuse with a value or type other than those specified.
11. **NEVER** attempt to repair this product. If a problem occurs, contact your Mark Levinson retailer.
12. **NEVER** expose this product to extremely high or low temperatures.
13. **NEVER** operate this product in an explosive atmosphere.
14. **ALWAYS** keep electrical equipment out of the reach of children.
15. **ALWAYS** unplug sensitive electronic equipment during lightning storms.
16. In CE countries, this amplifier is considered “professional equipment.” In order to comply with CE requirements, the customer is required to obtain permission from the local supply authority before connecting this equipment.

From all of us at Mark Levinson, thank you for choosing a Mark Levinson Power Amplifier.

4



3 Oak Park
Bedford, MA 01730-1413 USA
Telephone: 781-280-0300
Fax: 781-280-0490
www.marklevinson.com

Customer Service

Telephone: 781-280-0300
Sales Fax: 781-280-0495
Service Fax: 781-280-0499

Product Shipments

16 Progress Road
Billerica, MA 01821-5730 USA
Part No. 070-630670 | Rev 4 | 05/04

“Mark Levinson” and the Mark Levinson logo are registered trademarks of Harman International Industries. U.S. patent numbers and other worldwide patents issued and pending.

“Madrigal Audio Laboratories” and the Madrigal Audio Laboratories logo are registered trademarks of Harman International Industries. U.S. patent numbers and other worldwide patents issued and pending.

©2004 Harman Specialty Group. All rights reserved.

This document should not be construed as a commitment on the part of Harman Specialty Group. The information it contains is subject to change without notice. Harman Specialty Group assumes no responsibility for errors that may appear within this document.

Table of Contents

Unpacking6
Product Registration6
Installation Considerations7
Placement7
Ventilation8
Power Requirements8
Warm-up & Break-in Period9
Operating States10
Continuous Operation10
Special Design Features11
Massive Power Supply11
Balanced Design11
Extensive Protection12
Front Panel13
Rear Panel15
Linking20
Making Link Connections20
Constructing Link Communication Cables21
Creating a Slave Chain21
Link Controls24
Troubleshooting25
Care & Maintenance28
Specifications29
Declaration of Conformity30
Dimensions, N°43231
Dimensions, N°43132
Rack-Mounting33
Notes34

Unpacking



Warning!

DO NOT attempt to lift or move the N°432/431 without adequate assistance. Failure to follow the procedures included in this section may result in personal injuries and/or product damage.

The N°432/431 are massive power amplifiers. The N°432 ships at 125 pounds (57kg) and the N°431 ships at 105 pounds (48kg). **Rear panel handles** are provided for safe, convenient lifting and moving. Proper lifting requires at least two people.



Caution!

DO NOT attempt to lift the N°432/431 from its packing carton alone.

DO NOT attempt to lift the N°432/431 while bending at the waist. When lifting, stand as straight as possible using the leg muscles to lift.

When unpacking the N°432/431:

- **DO** save all packing materials for possible future shipping needs.
- **DO** inspect the N°432/431 for signs of damage during shipment. If damage is discovered, contact an authorized Mark Levinson dealer for assistance making appropriate claims.

Product Registration

Please register the N°432/431 within 15 days of purchase. To do so, register online at www.marklevinson.com or complete and return the included product registration card. Product registration serves no warranty purposes. Retain the original, dated sales receipt as proof of warranty coverage.

Installation Considerations

The N°432/431 requires special care during installation to ensure optimal performance. Pay particular attention to the precautions included in this section and to other precautions included throughout this owner's manual.

Placement

- **DO** review *“Important Safety Instructions”* and *“Power Requirements”* before installing the N°432/431.
- **DO** place the N°432/431 on a solid, flat, level surface such as a table, shelf, or floor OR bolt the N°432/431 into a rack-mounting system. Use a purpose-built rack-mounting system to accommodate the weight of the power amplifier. Refer to *“Rack-Mounting”* for additional information.
- **DO** position the N°432/431 close to associated loudspeakers to keep loudspeaker wires as short as possible. Use longer interconnecting cables between the preamplifier and the power amplifier. This is preferable because interconnecting cables pass low-voltage signals, which transmit over distances with greater accuracy than the high-voltage signals required by loudspeakers.
- **DO** allow at least a 6-inch (15cm) clearance behind the N°432/431 for the power cord and signal cables to bend without crimping or straining.
- **DO** refer to *“Dimensions”* for assistance with custom installations.
- **DO NOT** position the N°432/431 near low-level components. These power amplifiers are capable of producing massive output currents, which could generate significant magnetic fields that induce noise in some sensitive components.
- **DO NOT** place the N°432/431 on a windowsill or in another location in which it will be exposed to direct sunlight.

Caution!

Before moving the N°432/431, make sure it is powered off with the front panel power button. Then, make sure the power cord is disconnected from the ~ac mains connector and the electrical outlet. Do not attempt to move the N°432/431 without adequate assistance. Proper lifting requires at least two people.

Ventilation

- **DO** select a dry, well-ventilated location out of direct sunlight.
- **DO** allow at least a 2 to 3-inch (5 to 8cm) clearance above the N°432/431 for proper heat dissipation through air circulation. The N°432/431 is designed for passive, convection cooling.
- **DO NOT** obstruct the ventilation holes on the top and bottom of the N°432/431 or reduce airflow through the N°432/431.
- **DO NOT** place the N°432/431 on a thick rug or carpet or cover the N°432/431 with a cloth, as this might prevent proper cooling. If the N°432/431 is placed on the floor, use a thick piece of tempered glass to provide firm support and proper ventilation.
- **DO NOT** expose the N°432/431 to high temperatures, humidity, steam, smoke, dampness, or excessive dust. Avoid installing the N°432/431 near radiators and other heat-producing appliances.

Note

In general, better ventilation is required if the top of the N°432/431 is too hot to touch when the power amplifier is "idle." Open equipment racks provide the best ventilation for power amplifiers. However, if the power amplifier must be placed in a cabinet that restricts airflow, consider drilling holes in the shelf underneath the power amplifier to improve ventilation or using fans to increase air circulation.

Power Requirements

When shipped, the N°432/431 is configured for 100V, 120V, 220V, 230V or 240V AC power operation at 50 or 60Hz based on the country for which it is manufactured. Before operating the N°432/431, make sure the ~ac mains connector label indicates the correct operating voltage for the current location.

Caution!

Do not attempt to adjust the operating voltage. Consult an authorized Mark Levinson dealer if the operating voltage is incorrect or if the operating voltage must be changed for relocation purposes.

Be advised that different operating voltages may require the use of different power cords and/or attachment plugs. Contact an authorized Mark Levinson dealer for assistance.

The N°432/431 is capable of passing remarkable musical signals regardless of signal and loudspeaker demands. On either an instantaneous or continuous basis, these power amplifiers can drive exceptional power levels into most all loudspeaker loads. Depending on listening habits, loudspeaker demands, and the number of power amplifiers present in the system – it is possible for the electrical service to become the limiting performance factor.

In this case, consider installing a dedicated AC circuit for the home entertainment system. Contact a licensed electrician for assistance. If more than one AC circuit is providing power to the system, contact a licensed electrician to ensure that all components are operating with the same solid, low-impedance ground reference.



Important:

Building regulations and electrical codes differ from location to location, making it impossible to anticipate the requirements of high-current AC circuits such as the N°432/431 are capable of using. Contact a local, licensed electrician for information.

Warm-up & Break-in Period

Although the N°432/431 delivers superior performance from the first time it is powered on, this performance will continue to improve as the power amplifier reaches its normal operating temperature and various components “break in.” The greatest performance improvements will occur within the first 25 to 50 hours of use. Sound quality will continue to improve for about 300 hours.

After this initial period, performance will remain consistent unless power is disconnected from the **~ac mains connector**. Power is considered disconnected when the N°432/431 is powered off with the **power button**; the power cord is disconnected from the **~ac mains connector** or the electrical outlet; or an extended power failure or power outage occurs. Power is not disconnected when the N°432/431 is in **standby** or **sleep mode**.

When power returns, the N°432/431 will require a brief warm-up and break-in period (not the full 300 hours). It is recommended to allow the N°432/431 and other audio components to stabilize for about 2 minutes.

Operating States

The N°432/431 has four operating states:

1. Off

Power is disconnected from the **~ac mains connector**.

2. Sleep Mode

Power is connected to a small power supply, communication circuits, and control circuits. When taken out of **sleep mode**, the N°432/431 requires a brief warm-up and break-in period. In **sleep mode**, the N°432/431 consumes less than 15W of power.

3. Standby

Power is connected to the main power supply and voltage gain stages. Power is not connected to the output (current gain) stage. Because voltage gain stages are kept at their normal operating temperatures, the N°432/431 remains warmed-up to deliver an optimal performance. In **standby**, the N°432/431 consumes about 50W of power.

4. On

Power is connected to the **~ac mains connector** and all power amplifier components.

Continuous Operation

The N°432/431 should be unplugged during lightning storms and extended periods of non-use. Otherwise, it is designed for continuous operation. For best performance, make sure power is connected to the **~ac mains connector** at all times. During normal operation, do not use the **power button** to power off the N°432/431. Instead, use the **standby button** to place the N°432/431 into **standby**, which allows the power amplifier to remain warmed-up to deliver optimal performance at all times.

Special Design Features

Thank you for purchasing the N°432/431 Power Amplifier. While these amplifiers are straightforward in everyday use, they include several design features that are responsible for their outstanding performance. In particular, these amplifiers defy the accepted wisdom that it is impossible to design a large, powerful amplifier that also has all the finesse of the finest smaller amplifiers. A few of the technical highlights that make this possible are described below.

Massive Power Supply

The N°432/431 features two large, robust power supplies. Each supply includes a high-capacity, low-noise toroidal transformer, and four large, low ESR (“Equivalent Series Resistance”) capacitors.

Heavy oxygen-free copper bus bars enhance the efficiency of power distribution within the amplifier and eliminate variances introduced by the wiring harnesses that are commonly found in even high-performance amplifiers. High-frequency power supply bypass is accomplished on individual PC boards by components of several film types. The resulting uniformly low power supply impedance seen by the various circuits within the amplifier lays the foundation for massive power and extraordinary finesse that characterizes Mark Levinson amplifiers.

Balanced Design

A truly balanced input topology eliminates the need for an input buffer amplification stage, allowing the first stage differential amplifier to be driven directly by the source. Matched impedances are presented to the source. Both signals travel through identical circuit paths.

Meticulous attention to the layout of the amplifier, including careful mirror-imaging of circuits to cancel magnetic fields, was essential to minimize magnetic field distortions that can occur with such a massive power delivery system. A balanced input signal remains balanced throughout the voltage gain stages. Rejection of common mode noise and distortion is achieved in the final, current gain stage.

Extensive Protection

The N°432/431 is designed to shut itself down if it senses any of a number of fault conditions that could cause damage to itself or to associated loudspeakers.

These fault conditions include:

- the presence of DC (direct current) at the output
- demand for excessive current at the output, indicating a short-circuit
- over-voltage or under-voltage conditions (+5% to -10%) at the **~ac mains connector**
- unsafe operating temperatures in any of several critical areas within the amplifier

In the case of either significant DC offset or an over-current condition, the amplifier will shut down to protect itself and the associated loudspeakers. The front panel **indicator LED** will blink rapidly, remaining lit about half of the time. To restore normal operation, remove the cause of the fault and power cycle the amplifier with the **power button**.

If the **~ac mains connector** voltage is too high or too low for safe operation, the amplifier will automatically enter **sleep mode** and the front panel **indicator LED** will blink rapidly, remaining on most of the time. The amplifier will not come out of **sleep mode** until the **~ac mains connector** voltage is again within the normal operating range. For example, a 120V amplifier will operate between approximately 108-132VAC; a 230V amplifier will operate between approximately 207-253VAC. Outside of these generous limits, the amplifier will enter **sleep mode**. Once the fault condition is removed, the amplifier can be taken out of **sleep mode**.

If the amplifier overheats despite its innovative heat sinking and cooling system, it will enter and remain in **sleep mode** until the temperature at the output heat sinks drops below 85°C (158°F or 358K). The front panel **indicator LED** will blink rapidly, remaining unlit most of the time. Once the fault condition is removed, the amplifier can be taken out of **sleep mode**.

In addition, the AC input to each transformer is fused to protect against excessive current conditions such as driving shorted outputs. Inrush limiting prevents premature aging of power supply components during power-up, and switches off-line once the power supply has been charged.

Finally, your amplifier incorporates a controlled clipping circuit that prevents the output devices from saturating. The harsh high-frequency harmonics generated by hard-clipped output devices are avoided by the wave-shaping action of this controlled clip circuitry.

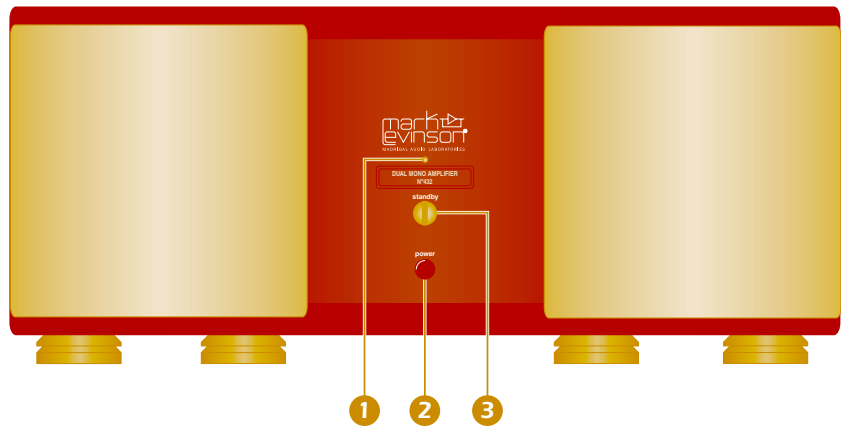

Front Panel

The numbers in the front panel illustration shown above correspond with the numbered items that begin below.

1. Indicator LED

Indicates the **operating state** of the N°432/431 and provides diagnostic information when a **fault condition** occurs.

LED Behavior	Description
Fully lit	Indicates that the power amplifier is powered " on ."
Slowly blinking	Indicates that the power amplifier is in standby .
Dimly lit	Indicates that the power amplifier is in sleep mode .
Not lit	Indicates that the power amplifier is powered " off ."
Rapidly blinking (on most of the time)	Indicates that a power-related fault has occurred.
Rapidly blinking (on half of the time)	Indicates that a signal-related fault* has occurred.
Rapidly blinking (off most of the time)	Indicates that a thermal-related fault has occurred.

* *Signal-related faults include significant DC offset at the output due to either DC in the input signal or a failed component within the amplifier OR excessive current demands due to a short-circuited loudspeaker wire.*

Refer to "Extensive Protection" for additional information about **fault conditions**. If the amplifier will not power on at all (even to **sleep mode**), check **~ac mains connections** or have an authorized Mark Levinson dealer inspect the internal fuses (which are not user-serviceable).

2. Power Button

Powers the N°432/431 on and off when the power cord is connected to the **~ac mains connector** and an electrical outlet. When the N°432/431 is powered on, pressing and releasing the **power button** disconnects power from the **~ac mains connector** and powers the N°432/431 off.

When the N°432/431 is powered off, pressing and releasing the **power button** connects power to the **~ac mains connector** and powers the N°432/431 on. If the **power save mode switch** is set to on, the N°432/431 enters **sleep mode**. If the **power save mode switch** is set to off, the N°432/431 enters **standby**.



Note:

The N°432/431 must be powered on with the power button to respond to remote trigger commands.

3. Standby Button

Places the N°432/431 into **standby** or **sleep mode** and takes the N°432/431 out of **standby** or **sleep mode**. When the N°432/431 is powered on, pressing and releasing the **standby button** places the N°432/431 into **standby** or takes the N°432/431 out of **standby**, allowing it to remain warmed-up to deliver an optimal performance at all times.

Pressing and holding the **standby button** places the N°432/431 into **sleep mode**. When the N°432/431 is in **sleep mode**, pressing and releasing the **standby button** takes the N°432/431 out of **sleep mode**. If the **power save mode switch** is set to on, the N°432/431 powers on into **sleep mode**. If the **power save mode switch** is set to off, the N°432/431 enters **standby**.

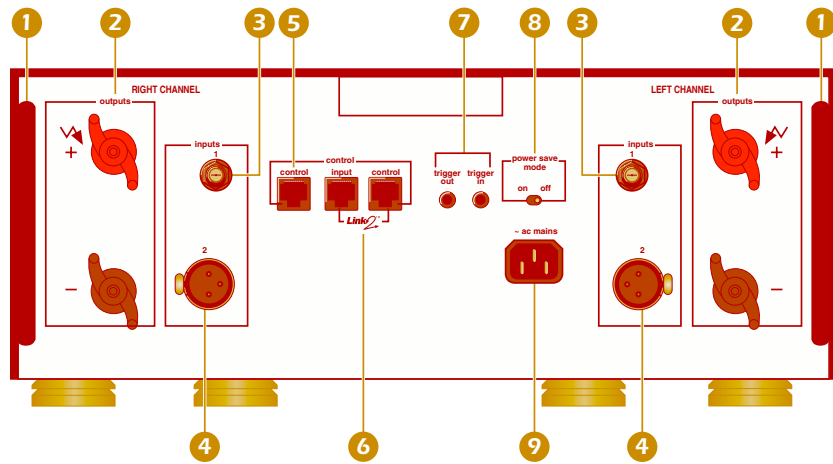

Rear Panel

The numbers in the rear panel illustration shown above correspond with the numbered items that begin below.



Caution!

Never make or break connections to the N°432/431 unless it and all associated components are powered off and disconnected from electrical outlets. Before making connections to the N°432/431, make sure the associated preamplifier master volume is set to a reasonable level.

15

1. Rear Panel Handles

Allow for safe, convenient lifting and moving of the N°432/431. Refer to "Unpacking" for additional information.



Caution!

DO NOT attempt to lift the N°432/431 from its packing carton alone.

DO NOT attempt to lift the N°432/431 while bending at the waist. When lifting, stand as straight as possible using the leg muscles to lift.

2. Loudspeaker Binding Posts (Outputs)

Provide left and right-channel audio output. Two custom-made, gold-plated, high-current binding posts labeled + (positive) and - (negative) are available for each channel. Positive binding posts are red; negative binding posts are black.



Caution!

NEVER connect power amplifier outputs to any component other than a loudspeaker.

NEVER short-circuit power amplifier outputs.

NEVER connect power amplifier outputs to another power amplifier's outputs.

For best performance, use high-quality loudspeaker cables. To connect these cables, use a high-quality spade or hook lug soldered to the cable or crimped to the cable with extremely high pressure.

- Connect the + (positive) binding posts on the N°432/431 to positive inputs on the associated loudspeaker.
- Connect the – (negative) binding posts on the N°432/431 to negative inputs on the associated loudspeaker.



Spade Lug



Hook Lug



Caution!

DO NOT OVERTIGHTEN the N°432/431 binding posts. The innovative design of these binding posts provides more leverage than more traditional designs. Tight, high-contact pressure connections can be achieved with finger-tightening. Special tools are not needed.

DO NOT FORCE the N°432/431 binding post “wings” up and over a bent or oversized connector. Doing so may result in binding post damage. If the connector obstructs “wing”-turning, slide it into place when the binding post opening provides a snug fit. Then, use quarter-turns to tighten the connection as needed.

3. Unbalanced Input

Provides left and right-channel audio input. One stereo RCA connector is available to accept unbalanced input signals from an associated preamplifier. These signals are converted to balanced signals upon receipt, and processed as balanced signals thereafter.

If the associated preamplifier does not support balanced connections, connect the RCA output on the preamplifier to the RCA input on the N°432/431. To reduce the chance of noise at the (otherwise un-terminated) inverting XLR input, insert the supplied U-shaped shorting-straps between pins 1 and 3. (These shorting-straps are installed when the N°432/431 is shipped.)

4. Balanced Input

Provides left and right-channel audio input. One stereo XLR connector is available to accept balanced input signals from an associated preamplifier.

For best performance, use balanced connections whenever possible. Refer to the illustration below and to the associated preamplifier documentation to ensure that N°432/431 XLR input pin assignments correspond to the associated preamplifier XLR output pin assignments. If not, wire the cable so that the appropriate input pin connects to the appropriate output pin.

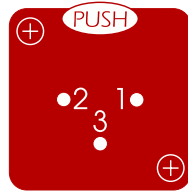

Pin 1: Signal ground

Pin 2: Signal + (non-inverting)

Pin 3: Signal – (inverting)

Connector ground lug: chassis ground

Note

Before making balanced connections, remove the U-shaped shorting-straps between pins 1 and 3 on the N°432/431 XLR inputs and save them for possible future use. These shorting-straps are installed when the N°432/431 is shipped.

17

5. RS-232 Communications Port

Provides serial control, performing flash memory software upgrades and facilitating external control in AMX™ and Crestron™ systems. One connector labeled control is available.

6. Link2™ Communication Ports

Provide “links” to compatible Mark Levinson preamplifiers and power amplifiers, allowing the N°432/431 and linked preamplifiers or power amplifiers to share Link controls. Two 6-pin modular RJ-11 jacks labeled **Link2™ input** and **Link2™ control** are available.

The **Link2™ input** communication port can be connected to a compatible Mark Levinson preamplifier that offers Link or **Link2™** communication ports. Both the **Link2™ input** and **Link2™ control** communication ports can be connected to a compatible Mark Levinson power amplifier that offers **Link2™** communication ports.

Note

Refer to “Linking” BEFORE linking the N°432/431 to other Mark Levinson components.

7. trigger in and out connectors

Provide DC trigger control. One 1/8-inch mini-jack labeled **trigger in** is available to receive 12 or 5V DC signals from a connected component, and one 1/8-inch mini-jack labeled **trigger out** is available to pass these signals along to a connected power amplifier. The illustration below shows tip polarity requirements.



Connect the **trigger in** connector on the N°432/431 to the trigger out connector on a compatible component. Toggling the connected component between on and standby will toggle the N°432/431 between on and **standby** or on and **sleep mode** (depending on the **power save mode switch** setting).

Connect the trigger out connector on the N°432/431 to the trigger in connector on a compatible power amplifier. The N°432/431 will pass DC signals along to the connected power amplifier, creating a “daisy-chain” of trigger control.

8. power save mode switch

Determines the N°432/431’s response to reductions in DC trigger voltage, from “high” (5-12V) to “low” (0V).

Important!

DO NOT change the power save mode switch setting when the N°432/431 is powered on. Make sure power is disconnected from the ~ac mains connector before making adjustments.

When the **power save mode switch** is set to on, the N°432/431 powers on in **sleep mode**. If the N°432/431 is configured for trigger control, incoming DC signals toggle the N°432/431 between on and **sleep mode**.

When the **power save mode switch** is set to off, the N°432/431 powers on in **standby**. If the N°432/431 is configured for trigger control, incoming DC signals toggle the N°432/431 between on and **standby**.

9. ~ac mains connector

Provides power to the N°432/431 through the supplied power cord when the supplied power cord is connected to the **~ac mains connector** and the electrical outlet. One IEC-standard AC mains receptacle labeled ~ac mains is available.

Note

Before operating the N°432/431, make sure the ~ac mains connector label indicates the correct operating voltage for the current location.



Warning!

The N°432/431 has been safety-tested and designed for operation with a three-conductor power cord. Do not defeat the “third pin” or “earth ground” of the power cord.

The N°432/431 includes internal fuses as a final stage of protection. The protection circuitry is designed so that only a catastrophic failure will cause these fuses to blow. If this occurs, disconnect the power cord from the N°432/431 **~ac mains connector** and the electrical outlet. Then, contact an authorized Mark Levinson dealer for assistance. **Do not attempt to replace the fuse. There are no user-serviceable parts within the N°432/431.**



Danger!

Potentially dangerous voltages and current capabilities exist within the N°432/431, even when power is disconnected from the ~ac mains connector. **DO NOT** attempt to open the amplifier's cabinet. There are no user-serviceable parts inside the amplifier. Refer all servicing to an authorized Mark Levinson dealer.

- **DO** use Link or Link² slave in, slave out, Link² communication ports. **DO NOT** use panel connectors.

Use the supplied Link communication cables, which are included in the accessory box.

Do not use constructed Link communication cables. Refer to the "Link Communication Cables" for additional information.

Do not use Link or Link² slave in, slave out, Link² communication ports made with other connectors. Do not use Link² slave in, slave out, Link² communication ports and other linked devices. This voids the manufacturer's warranty.

Constructing Link Communication Cables

Link communication cables can be constructed using an 8-conductor modular telephone cable with the appropriate plug crimped on each end.

- Use an 8-pin RJ-45 plug when connecting to a preamplifier. RJ-45 plugs provide an 8-pin connection.
- Use a 6-pin RJ-11 plug when connecting to a power amplifier. RJ-11 plugs provide a 6-pin connection in which connector pins 7 and 8 are not used.

Note

BEFORE making Link connections, refer to the appropriate documentation for Link or *Link2* communication port specifications for other Mark Levinson components.

When linking components with constructed Link communication cables, twist the cable 180° as shown in the illustration below for a straight-through (pin 1-to-pin 1) connection.

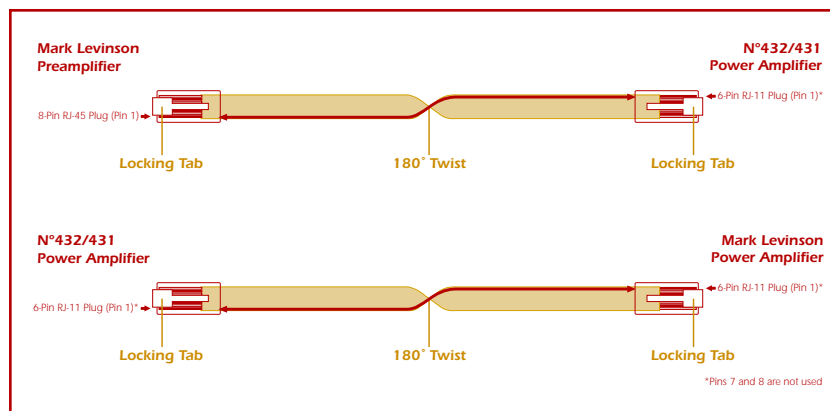

21

Note

Contact Mark Levinson Customer Service at 781-280-0300 or www.marklevinson.com for additional assistance making Link connections.

Creating a Slave Chain

Making Link connections creates a slave chain that facilitates communication among linked components, allowing them to share certain controls.

All slave chains:

- Must include compatible Mark Levinson components. The N°432/431 is compatible with the components listed on the previous page. Refer to the appropriate documentation for Link compatibility information about other Mark Levinson components.

- Must include components that are connected in a certain order to prevent communication from terminating. Power amplifiers such as the N°432/431 must be the last components in a slave chain.

Note

The slave chains in this section include preamplifiers and power amplifiers. However, slave chains can also include digital audio processors and digital transports. Refer to the appropriate documentation for information about including these Mark Levinson components in a slave chain.

The table below indicates slave chain requirements for preamplifiers and power amplifiers.

Component	Requirements & Connections
Preamplifier (e.g., N°320S)	<ul style="list-style-type: none"> • No maximum number per slave chain. • Connect the Link2™ or slave out communication port on the preamplifier to the Link2™ input communication port on the first power amplifier.
Power Amplifier (e.g., N°432/431)	<ul style="list-style-type: none"> • Maximum of six per slave chain. • Connect the Link2™ input communication port on the first power amplifier to the Link2™ or slave out communication port on the preamplifier. • Connect up to six power amplifiers in a “daisy chain” using Link2™ input-to-Link2™ control communication port connections. The Link2™ control communication port on the last power amplifier is not connected.

To create a slave chain that includes the N°432/431:

1. Make sure the N°432/431 and all associated components are powered off.
2. Connect the **Link2™** **input** communication port on the first power amplifier to the **Link2™** or **slave out** communication port on the preamplifier.

If desired, connect the **Link2™** **control** communication port on the first power amplifier to the **Link2™** **input** communication port on another power amplifier. Up to six power amplifiers can be included in a slave chain using “daisy chain” **Link2™** **input-to-Link2™** **control** communication port connections. The **Link2™** **control** communication port on the last power amplifier is not connected.

Refer to the table on the previous page and to the illustration below for additional assistance.

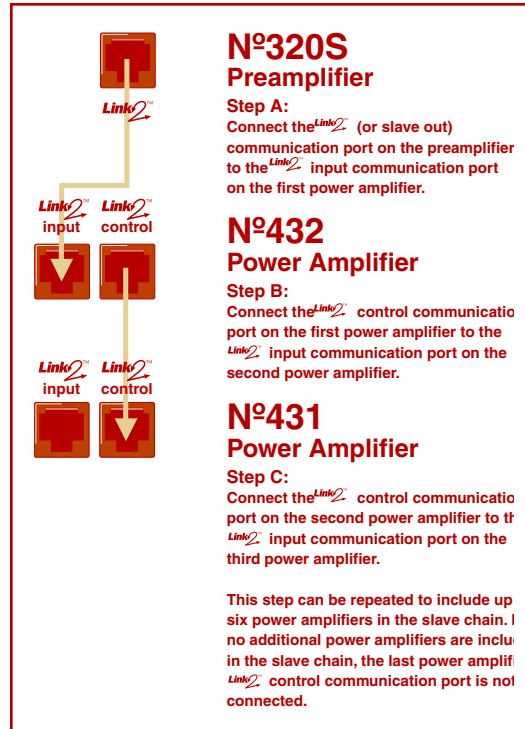

3. When Link connections have been made, power on linked components **ONE AT A TIME** in the order specified below. Allow each component to complete its initialization sequence before proceeding to the next component.
- Digital Transports
 - Digital Audio Processors
 - Preamplifier
 - Power Amplifiers (begin with the first power amplifier in the slave chain)

23

At this point, the front panel standby LEDs on all linked components should be blinking in unison.

Note

Linked components must be powered on ONE AT A TIME in the specific order listed in step 3 (above) to ensure proper functioning of Link controls. DO NOT use a power strip switch to power on several components at once. When power is supplied to a power strip, connected components that do not include a power button will automatically power on.

4. Take the linked preamplifier out of standby.

- All linked power amplifiers should come out of standby as well. If this does not occur, repeat steps 3 and 4. If problems persist, contact Mark Levinson Customer Service at 781-280-0300 or www.marklevinson.com.

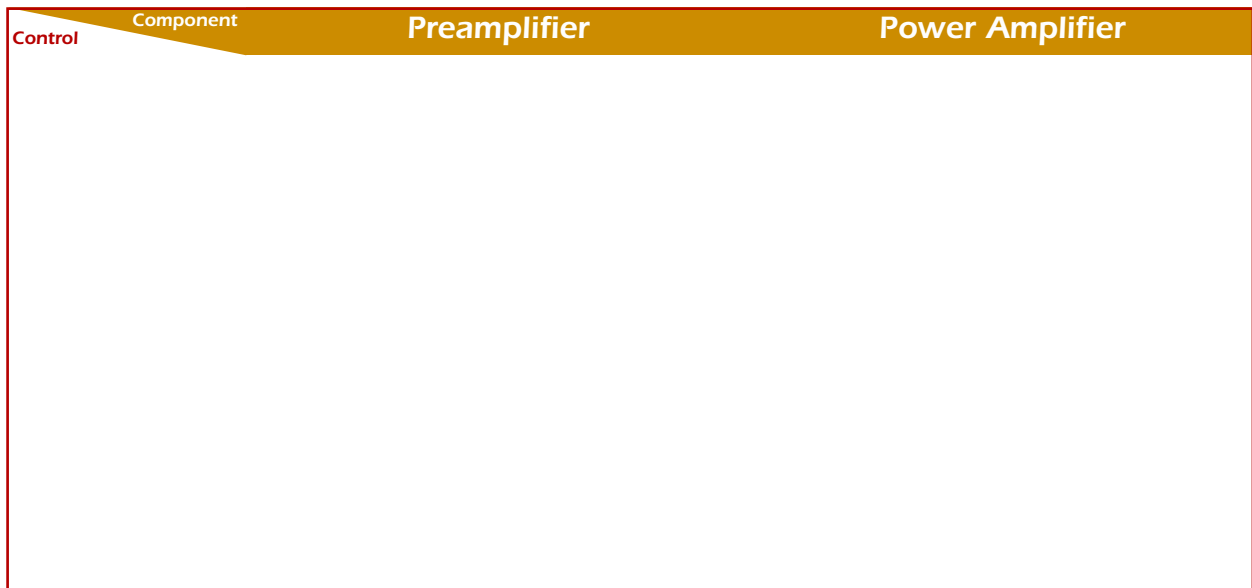

Troubleshooting

Incorrect operation is sometimes mistaken for malfunction. If problems occur, refer to this section for troubleshooting information. If problems persist, contact Mark Levinson Customer Support at 781-280-0300 or www.marklevinson.com.

1. No audio and the front panel indicator LED is not lit.

- Examine ~ac mains connections to ensure the power cord is connected to the **~ac mains connector** and the electrical outlet.
- Make sure the N°432/431 is powered on with the **power button**.
- Examine the electrical circuit breaker to ensure that power is supplied to the electrical outlet to which the N°432/431 is connected.
- A power loss or power outage may have occurred. In this case, power cycle the N°432/431 with the **power button**, waiting at least 10 seconds between powering the N°432/431 off and on.
- A fuse may be blown inside the N°432/431. In this case, disconnect the power cord from the **~ac mains connector** and the electrical outlet. Then, contact an authorized Mark Levinson dealer. **Do not attempt to replace the fuse. There are no user-serviceable parts within the N°432/431.**



Danger!

Potentially dangerous voltages and current capabilities exist within the N°432/431, even when power is disconnected from the ~ac mains connector. **DO NOT** attempt to open the amplifier's cabinet. There are no user-serviceable parts inside the amplifier. Refer all servicing to an authorized Mark Levinson dealer.

2. No audio and the front panel indicator LED is dimly lit.

- The N°432/431 is in **sleep mode**. To take it out of **sleep mode**, press and release the **standby button**. The N°432/431 will power on or enter **standby mode** based on the **power save mode switch** setting.
- A power loss or power outage may have occurred. In this case, power cycle the N°432/431 with the **power button**, waiting at least 10 seconds between powering the N°432/431 off and on.

3. No audio and the front panel indicator LED is blinking slowly.

- The N°432/431 is in **standby**. To take it out of **standby**, press and release the **standby button**. The N°432/431 will power on.

4. No audio and the front panel indicator LED is blinking rapidly, remaining lit most of the time.

- Examine ~ac mains connections to ensure the power cord is connected to the **~ac mains connector** and the electrical outlet.
- Power cycle the N°432/431 with the **power button**, waiting at least 10 seconds between powering the N°432/431 off and on.
- Contact an authorized Mark Levinson dealer.

5. No audio and the front panel indicator LED is blinking rapidly, remaining lit about half of the time.

- A **signal-related fault condition** is present, probably either a DC offset or an over-current condition. If this occurs:
 - a. Power the N°432/ 431 off with the **power button**.
 - b. Disconnect the input signal and loudspeaker wires.
 - c. Wait 10 seconds.
 - d. Power the N°432/431 on with the **power button**.
 - e. Bring the unit out of standby by pressing and releasing the **standby button**.

If the N°432/431 powers on, repeat these steps, reconnecting input signal and loudspeaker wires one at a time to determine what is causing the fault condition. Remember to power the N°432/431 off with the **power button** before making or breaking connections. If the N°432/431 does not power on, there is an internal failure. Contact an authorized Mark Levinson dealer.

6. No audio and the front panel indicator LED is blinking rapidly, remaining unlit most of the time.

- A **thermal-related fault condition** is present, which causes the N°432/431 to enter **sleep mode**. Once the heat sinks have cooled below 85°C (158°F or 358K), the N°432/431 can be taken out of **sleep mode** with the **standby button**.

7. No audio and the front panel indicator LED is lit at full brightness.

- The N°432/431 is powered on, but is not passing a signal. Examine signal cables to ensure a solid connection between the N°432/431 and the associated preamplifier and loudspeakers.

8. The amplifier keeps powering off.

- A fault condition may be present at the input (e.g., a DC signal from the preamplifier) or the output (e.g., short-circuited loudspeaker wires). If this occurs:
 - a. Power the N°432/ 431 off with the **power button**.
 - b. Disconnect the input signal and loudspeaker wires.
 - c. Wait 10 seconds.
 - d. Power the N°432/431 on with the **power button**.

If the N°432/431 powers on without entering **standby** or **sleep mode**, a fault condition is present at the input or the output. To isolate the problem:

- a. Power the N°432/ 431 off with the **power button**.
- b. Reconnect the loudspeaker wires.
- c. Power the N°432/431 on with the **power button**.

27

If the N°432/431 powers on into **standby** or **sleep mode**, the fault condition is present at the input. If not, the fault condition is present at the output.

9. If all else fails...

- Power cycle the N°432/431 with the **power button**, waiting at least 10 seconds between powering the N°432/431 off and on.
- Contact an authorized Mark Levinson dealer.
- Contact Mark Levinson Customer Service at 781-280-0300 or www.marklevinson.com.

Care & Maintenance

The N°432/431 requires routine care and maintenance to ensure optimal performance. The bulleted items included in this section indicate maintenance procedures that should be performed on a regular basis.

Note

Failure to perform the maintenance procedures included in this section may void the manufacturer's warranty and/or standard repair policies.

- Use a feather duster or a low-pressure blower to remove dust from the N°432/431 exterior surface.
- Use a soft, lint-free cloth to remove dirt and fingerprints from the N°432/431 exterior surface. Do not use a cloth made with steel wool or metal polish. If needed, this cloth can be dampened with isopropyl alcohol. Do not dampen the cloth with Benzene, acetone-based cleaners, and other commercial cleaners. Wipe the N°432/431 exterior surface in the same direction as the grain of the brushed aluminum.

28



Caution!

Do not apply liquid directly to the N°432/431 exterior surface. Doing so may damage electrical components.

- Refer to “*Installation Considerations*” for information about preventative maintenance.

Specifications

The correlation between published specifications and performance is unreliable. Measurements of your amplifier yield excellent results by any standards. However, only those specifications that apply to its actual operation are included here. All specifications are subject to change at any time.

- N°432 rated power output:**
- 400 w/ch rms power @ 8Ω
 - 800 w/ch rms power @ 4Ω

- N°431 rated power output:**
- 200 w/ch rms power @ 8Ω
 - 400 w/ch rms power @ 4Ω

All above power ratings from 20 Hz–20kHz at <0.5% THD (assuming that the AC mains can deliver adequate current, without its own voltage sagging)

- Frequency response:**
- within .3 dB from 20 Hz to 20 kHz

- Signal to Noise ratio:**
- better than –65 dB (ref. 2.83V)

- Input impedance:**
- 100kΩ (balanced)
 - 50kΩ (unbalanced)

- Voltage gain:**
- 26.8 dB

- Input sensitivity:**
- 2.83V output: 130 mV for both models
 - Full output: 2.58V for N°432, 1.82V for N°431

- N°432 power consumption:**
- 650W in on, 130W in standby, 10W in sleep

- N°431 power consumption:**
- 375W in on, 100W in standby, 10W in sleep

- Mains voltage:**
- determined by the needs of country for which the unit was manufactured; cannot be reset by dealer or user

- Overall dimensions:**
- See “Dimensions”

- N°432 shipping weight:**
- 125 lbs. (57 kg) each

- N°431 shipping weight:**
- 105 lbs. (48 kg) each

- N°432 net weight:**
- 115 lbs. (52 kg) each

- N°431 net weight:**
- 95 lbs. (43 kg) each

- Connector complement:**
- four custom binding posts
 - two 3-pin XLR balanced input connectors
 - two RCA input connectors
 - two 1/8" mini-jacks for remote turn-on
 - one RS-232 port on RJ-11
 - two Mark Levinson communications ports on RJ-11, RJ-45
 - one IEC-standard AC receptacle

- Output impedance:**
- less than 0.02Ω from 20–20,000 Hz

- Damping factor:**
- greater than 400, 20–20,000 Hz @ 8Ω

Declaration of Conformity

Application of Council Directive(s):

89/336/EEC and 73/23/EEC, as amended.

Standard(s) to which Conformity is Declared:

- EN 55103-1:1996
- EN 55103-2:1996
- EN 60065:1998

Manufacturer:

Harman Specialty Group
3 Oak Park
Bedford, MA 01730-1413 USA

The equipment identified here conforms to the Directive(s) and Standard(s) specified above.

Type of Equipment:

Power Amplifiers

Models:

Mark Levinson N°432 and N°431

Date:

May 2004

Harman Specialty Group
Vice President of Engineering
3 Oak Park
Bedford, MA 01730-1413 USA
Telephone: 781-280-0300
Fax: 781-280-0490
www.harmanspecialtygroup.com

Dimensions, N°432

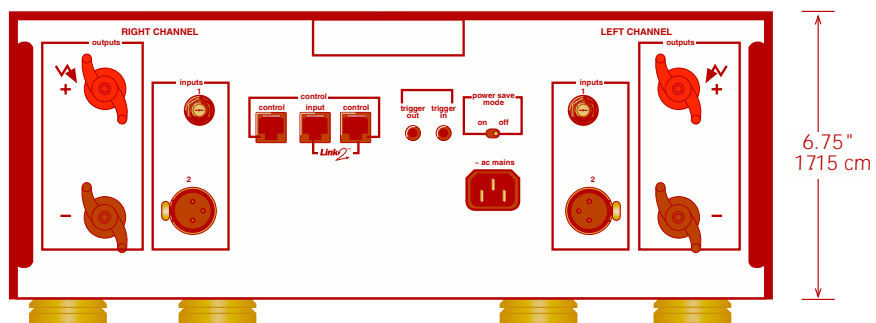
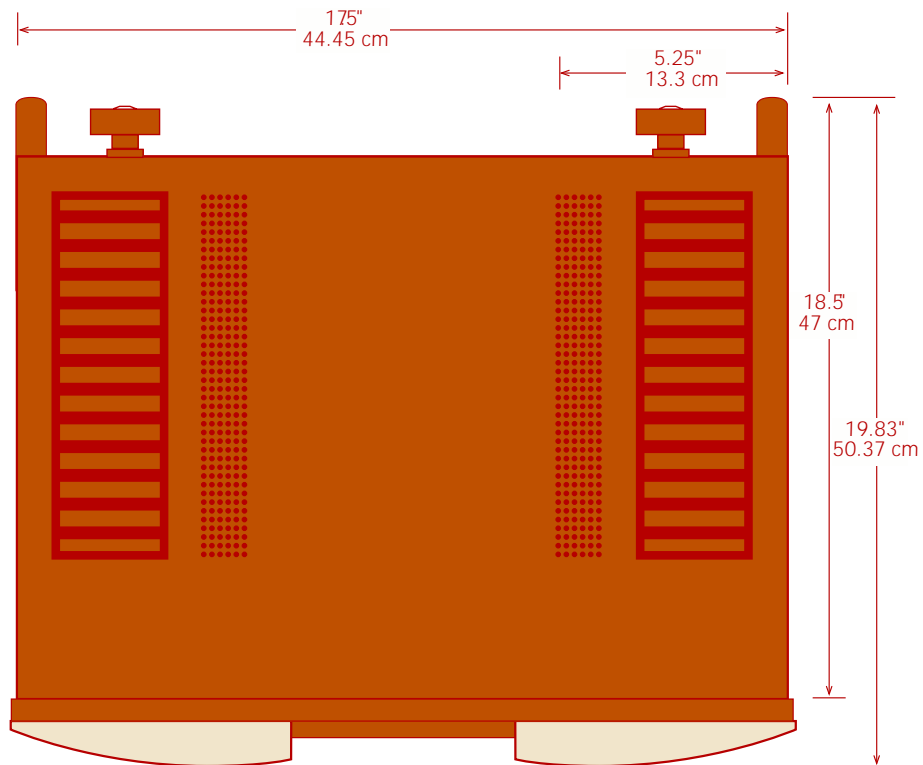
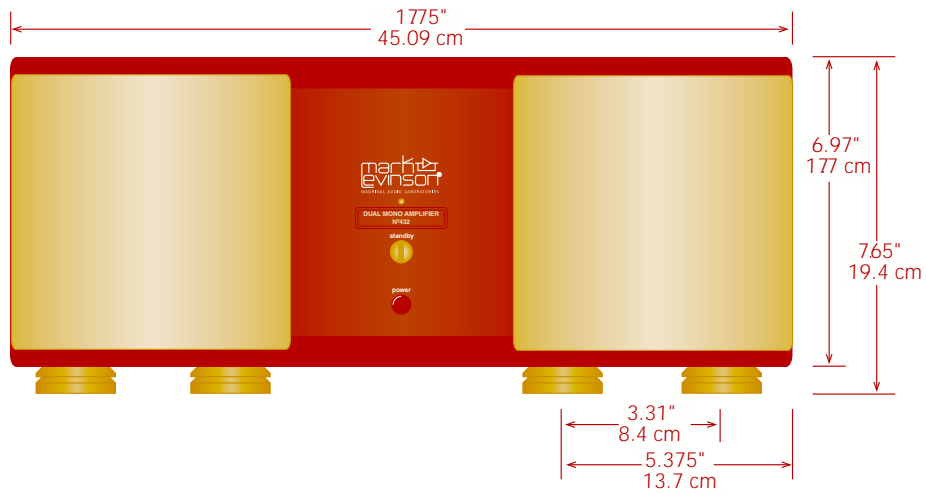

Rack-Mounting

If you need or prefer to rack mount your amplifiers, contact your Mark Levinson dealer about the optional rack mount kit. This purpose-designed assembly provides the needed ventilation for the heat sink "chimneys" of the amplifiers, as well as the support required for this heavy component.

To use the rack mount kit, simply bolt the shelf securely to the rack, remove the four feet from the bottom of the amplifier, slide the amplifier into place, and then secure the amplifier to the shelf using the two remaining screws provided with the kit. Slots on the rear of the shelf may be used for dressing cables or using cable ties.

The drawing below will help you visualize the assembly.

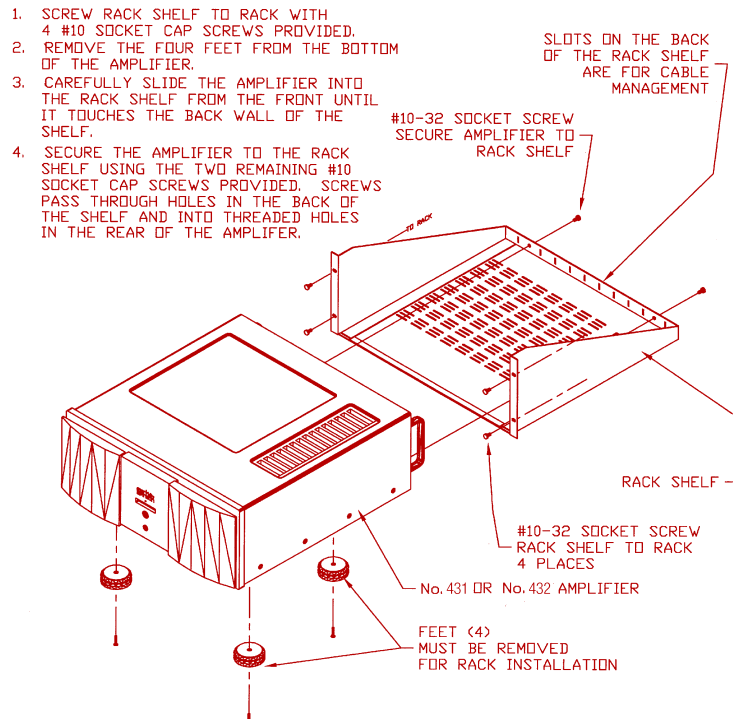

The mounted N°432 amplifier and rack mount kit occupies four standard rack units of height. The N°431 amplifier and rack kit takes up three standard rack units of height.

Lined paper template with 25 horizontal lines and a vertical margin line on the left side.



3 Oak Park, Bedford, MA, 01730-1413 USA | Telephone: 781-280-0300 | Fax: 781-280-0490 | www.marklevinson.com

Customer Support: Telephone: 781-280-0300 | Sales Fax: 781-280-0495 | Service Fax: 781-280-0499

Product Shipments: 16 Progress Road, Billerica, MA 01821-5730 USA

Part No. 070-630670 | Rev 4 | 05/04

Free Manuals Download Website

<http://myh66.com>

<http://usermanuals.us>

<http://www.somanuals.com>

<http://www.4manuals.cc>

<http://www.manual-lib.com>

<http://www.404manual.com>

<http://www.luxmanual.com>

<http://aubethermostatmanual.com>

Golf course search by state

<http://golfingnear.com>

Email search by domain

<http://emailbydomain.com>

Auto manuals search

<http://auto.somanuals.com>

TV manuals search

<http://tv.somanuals.com>