

MARK OF FITNESS FIVE YEAR WARRANTY

-U.S. Customers Only-

Mark of Fitness, Inc., warrants this product to be free of defects in material and workmanship for a period of five years, except cuff which has one year warranty.

Should any defects be discovered within five years of purchase, Mark of Fitness, Inc. will repair the defective product or parts at no charge for labor or materials provided:

1. Said unit is returned postage paid to the factory for servicing, marked Attn: Service Department.

2. Proof of date of purchase is included with the product.

3. A letter accompanies the product and indicates the complaint or defect to be remedied.

4. A check or money order in the amount of \$7.95 is included to cover the shipping and handling costs.

In the event the defect may be remedied without returning the unit, contact the firm by phone or mail first, and every effort will be made to supply the replacement parts quickly and at no charge.

This warranty does not apply to any unit that has been tampered with, abused, accidentally damaged or to damage incurred through improper packing and mishandling in transit to or from the factory.

This warranty gives you specific legal rights, and you may have other rights which vary from state to state.



Model MF-46

AUTOMATIC INFLATION

BLOOD PRESSURE MONITOR

CONTENTS	Page	Page
BASIC PRODUCT INFORMATION	9	WRAPPING THE CUFF 12
PRECAUTIONS FOR USE	10	MEASUREMENT PROCEDURES 13
TIPS ON TAKING YOUR BLOOD PRESSURE	10	MEMORY FUNCTIONS 13
INSTALLING BATTERIES AND SETTING THE CLOCK	11	DELETING STORED DATA 14
CORRECT MEASURING POSTURE	12	CARE AND MAINTENANCE 14
		ERROR DISPLAYS AND TROUBLESHOOTING . . 15

**INSTRUCTIONS
ENGLISH**

**INSTRUCTIONS
ENGLISH**

**INSTRUCTIONS
ENGLISH**

**MANUAL DE INSTRUÇÕES
PORTUGUÊS**



Mark of Fitness, Inc.

621 Shrewsbury Avenue

Shrewsbury, New Jersey 07702

Phone (732) 842-7200 Fax (732) 842-0558

Customer Service (888) 343-1558

e-mail custserv@markfit.com

web site www.markoffitness.com

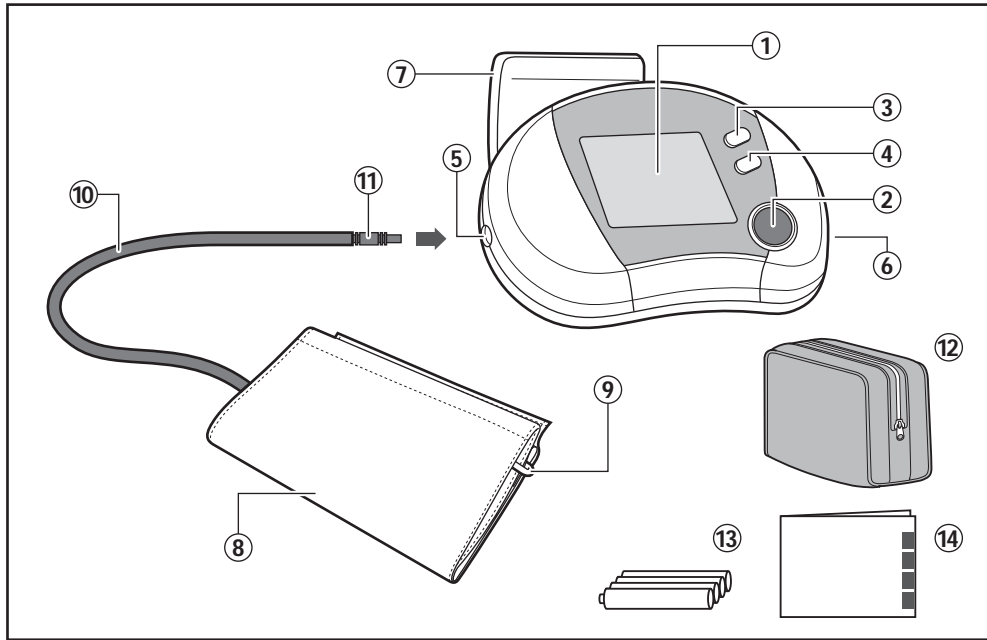

PARTS NAMES AND PRODUCT COMPONENTS

- | | | | |
|--|-------------------|--------------------|----------------------|
| ① DISPLAY (SYS:systolic/DIA:diastolic/PUL:pulse) | ② ON/OFF BUTTON | ③ MEMORY BUTTON M1 | ④ MEMORY BUTTON M2 |
| ⑤ AIR CONNECTOR | ⑥ AC ADAPTER JACK | ⑦ CUFF HOLDER | ⑧ CUFF |
| ⑩ AIR HOSE | ⑪ TUBE PLUG | ⑫ CARRYING BAG | ⑬ 4 X AA BATTERY |
| | | | ⑭ INSTRUCTION MANUAL |

NOM DES PIÈCES ET COMPOSANTES DU PRODUIT

NOMBRE DE LAS PIEZAS Y COMPONENTES DEL PRODUCTO

NOMES DAS PEÇAS E COMPONENTES DO PRODUTO

fig.1
INSTALLING BATTERIES AND SETTING THE CLOCK p.11

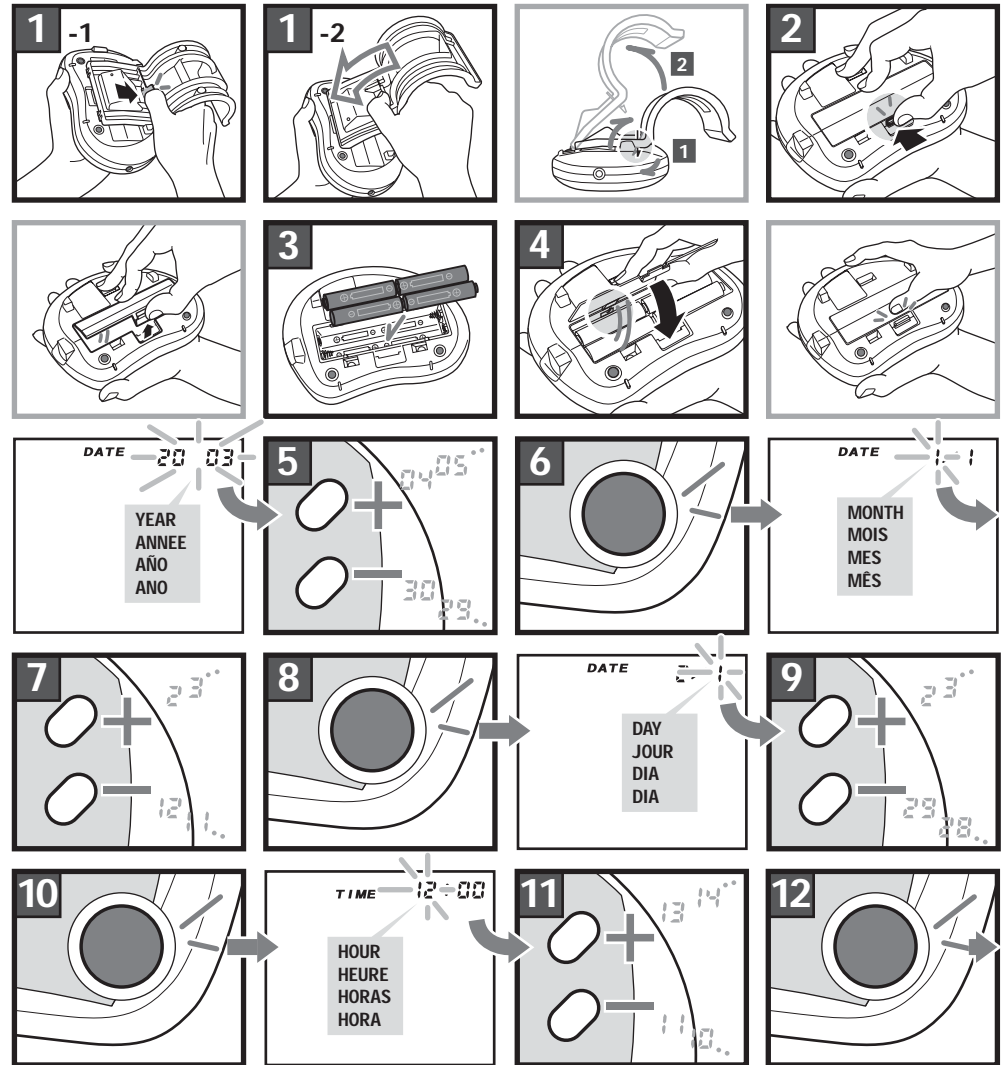

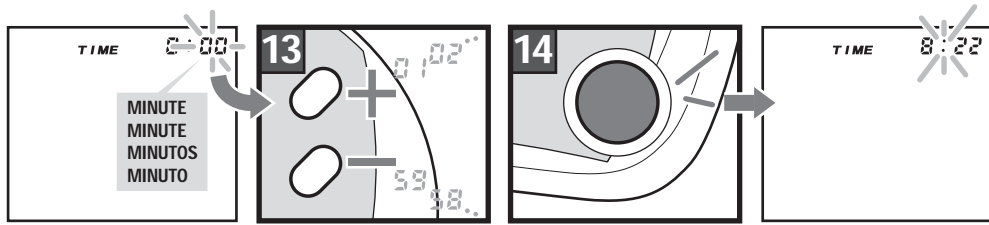

fig.2
CORRECT MEASURING POSTURE p.12
POSTURA CORRECTA DE MEDICIÓN p.X

POSTURE DE MESURE p.X
POSTURA CORRECTA PARA MEDIÇÃO p.X

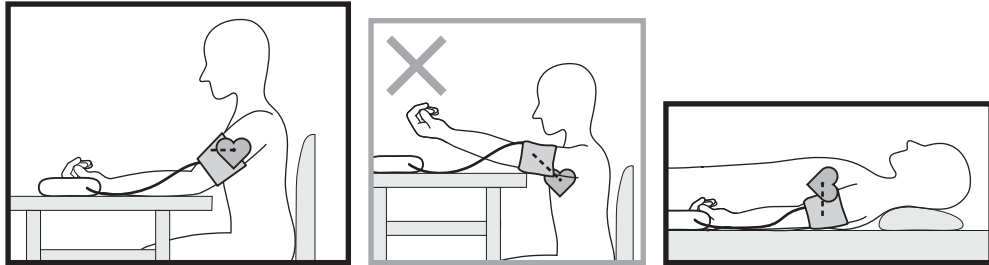

fig.3
WRAPPING THE CUFF p.12
COLOCACIÓN DEL BRAZALETE p.X

ENROULEMENT DU BRASSARD p.X
COLOCAÇÃO DA BANDA p.X

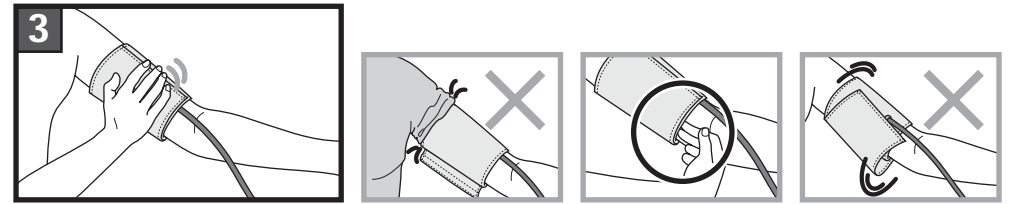
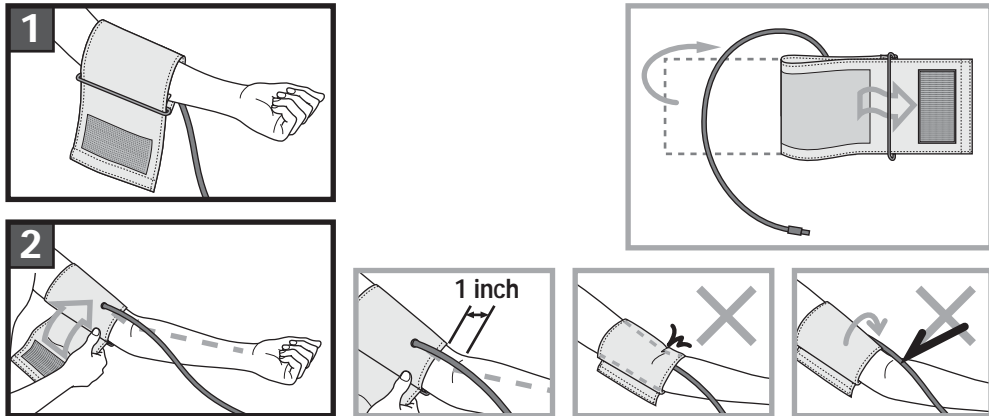

fig.4
MEASUREMENT PROCEDURES p.13
CÓMO EFECTUAR LA MEDICIÓN p.X

MÉTODE DE MESURE p.X
PROCEDIMENTOS DE MEDIÇÃO p.X

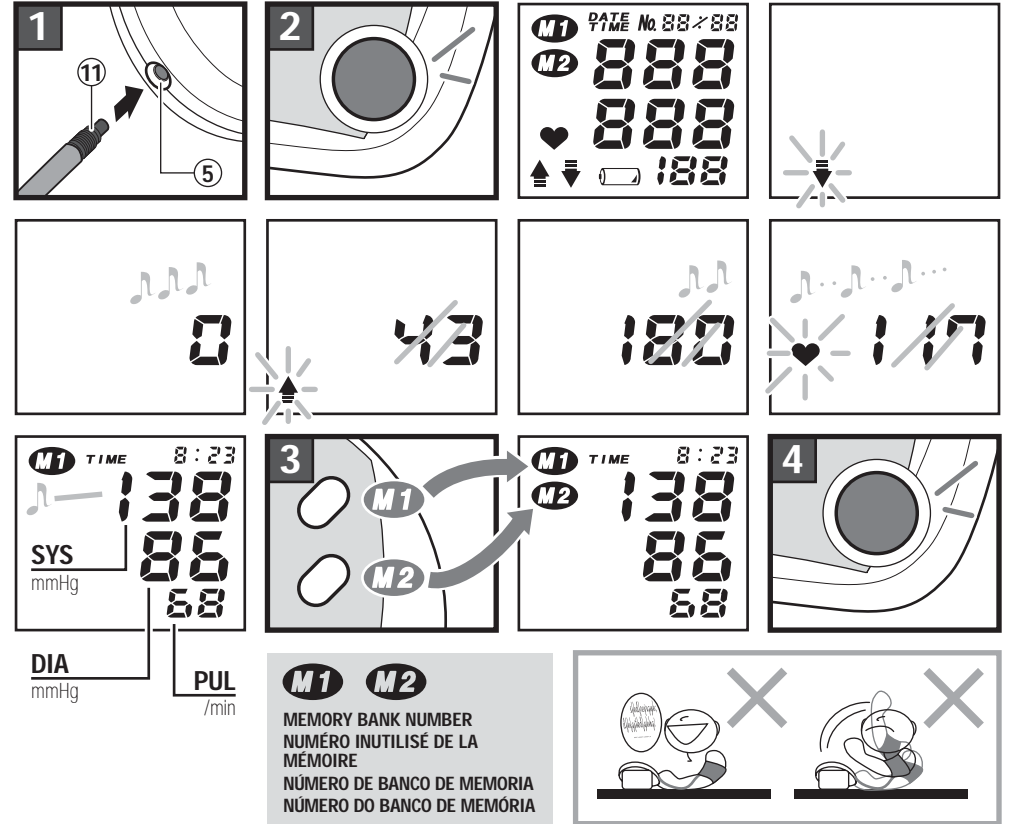

fig.5
MEMORY FUNCTIONS p.13
FUNCIONES DE MEMORIA p.X

FUNCTIONNEMENT DE LA MÉMOIRE p.X
FUNÇÕES DA MEMÓRIA p.X

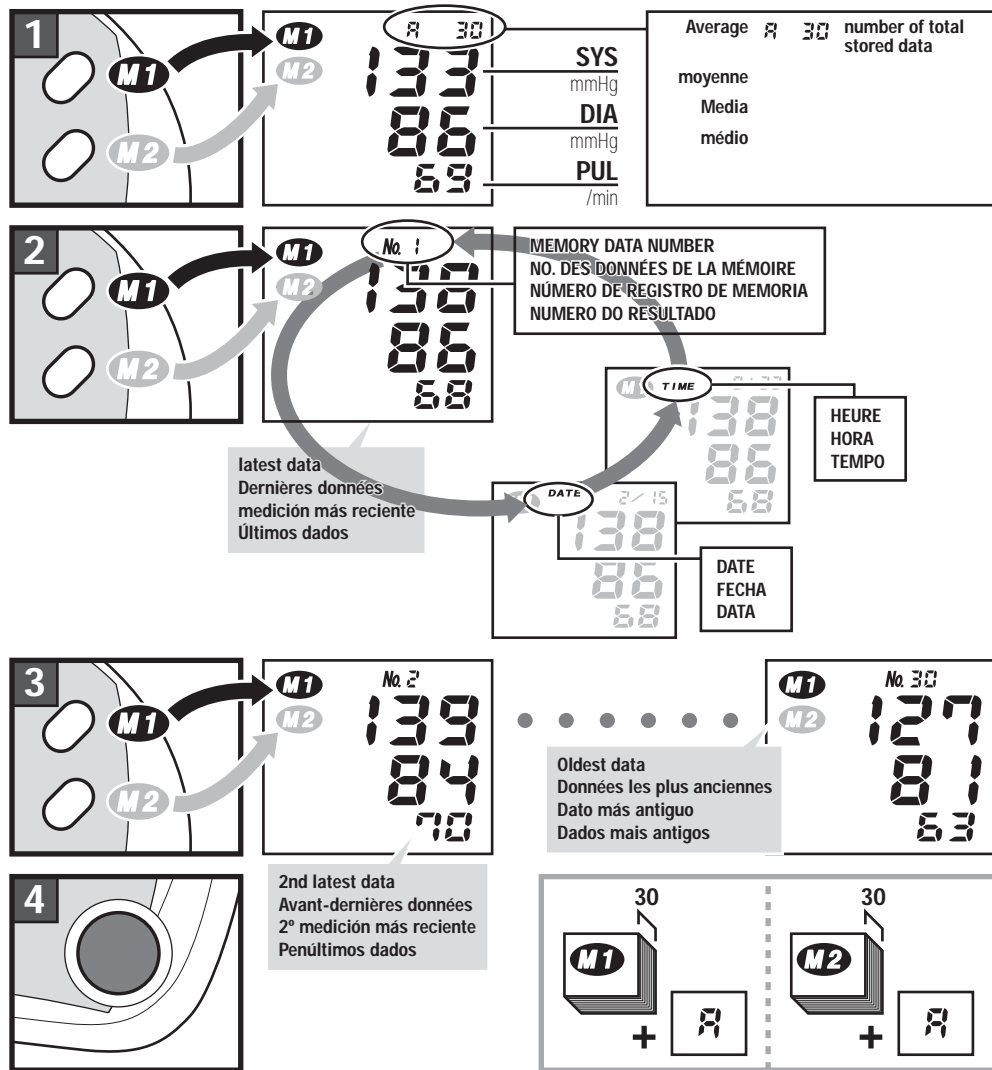
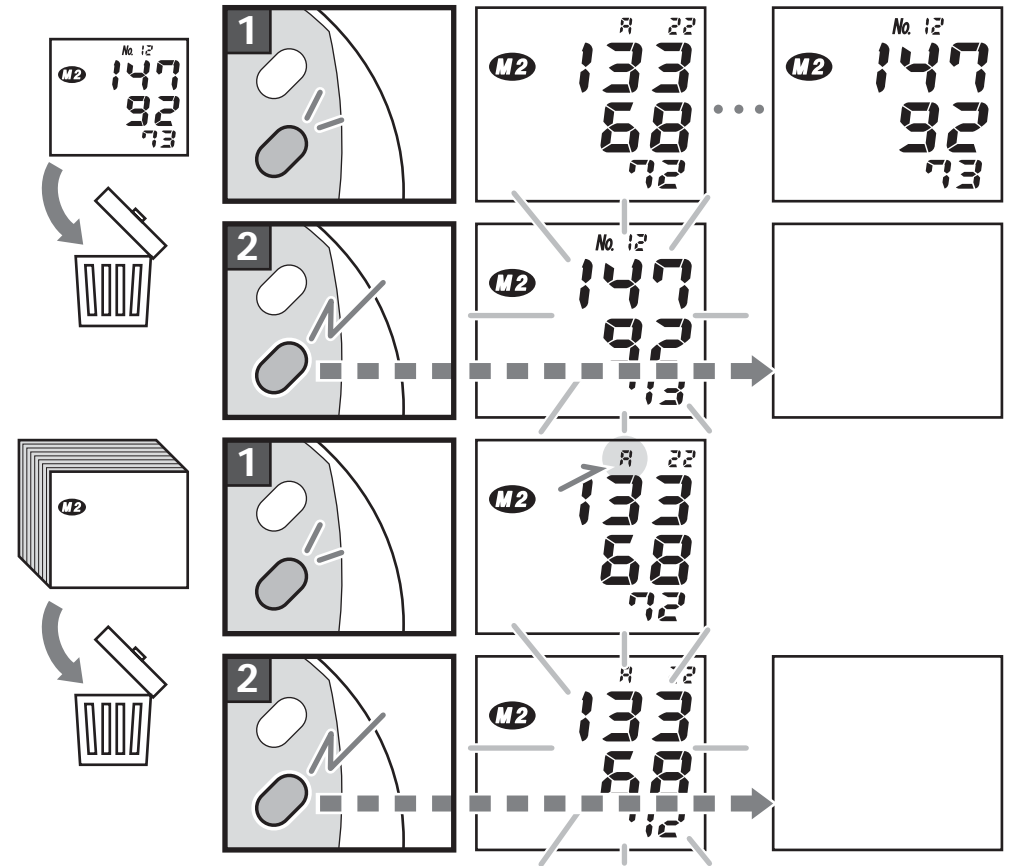

fig.6
DELETING STORED DATA p.14



BASIC PRODUCT INFORMATION

This manual is intended to assist the user in the safe and efficient operation of the Model MF-46 Digital Blood Pressure Monitor. The product must be used in accordance with the procedures contained in this manual and must not be used for purposes other than those described herein. It is important to read and understand the entire manual. In particular, please read carefully and become familiar with the section entitled "TIPS ON TAKING YOUR BLOOD PRESSURE".

The user is cautioned that the system may fail to yield specified measurement accuracy if operated or stored in temperature or humidity conditions outside the limits stated in the specifications section of this manual. Also, an inaccurate reading may result if this instrument is used on a child's arm. Consult your physician if you wish to take a child's blood pressure.

Indications for Use

The MF-46 system is intended for the non-invasive measurement of systolic and diastolic blood pressure and determination of heart rate in adult patients, i.e., age 15 and above. The product is recommended for use by patients with labile blood pressure or known hypertension in a home care environment as an adjunct to medical management. The cuff will accommodate an upper arm circumference range of approximately 8.7 to 12.6 inches (22 to 32 centimeters). Pressure is measured over a range of 0 to 300 mmHg and heart rate over a range of 40 to 160 beats/minute.

Method of Measurement

This product employs the oscillometric method for measurement of blood pressure and heart rate. The cuff is connected to the main unit and wrapped around the arm. Circuits within the monitor sense the small oscillations in

pressure against the cuff produced by the expansion and contraction of the arteries in the arm in response to each heart beat. The amplitude of each pressure wave is measured, converted to millimeters of mercury, and displayed on the LCD as a digital value. Memory circuit stores the 30 most recent measurement results for comparison.

Accuracy was evaluated during clinical studies in which results with the MF-46 system were compared with simultaneous auscultatory measurements obtained with a standard sphygmomanometer. In these studies, the onset of the fourth (or fifth) Korotkoff sound was taken as the diastolic pressure for the purpose of determining overall efficacy. A copy of this study is available from the manufacturer on request. To insure that accuracy is maintained, compare readings obtained with the MF-46 system with values measured by a trained observer using a manual sphygmomanometer at least every 6 months.

Blood pressure measurements determined with this device are equivalent to those obtained by a trained observer using the cuff stethoscope auscultation method, within the limits prescribed by the American National Standard, Electronic or Automated Sphygmomanometers.

The MF-46 system has the ability to function according to its specifications in the presence of common arrhythmias such as atrial or ventricular premature beats or atrial fibrillation.

CAUTION!

Do not use cuffs other than the original cuff included with this product.

SPECIFICATIONS

Model	: MF-46	Power Consumption	: 4W (max.)
Operating Principle	: Oscillometric method	Memory	: 30 measurement results x 2, computation of the average of stored Data
Indicator	: 13 digits LCD display	Operating environment	: +50F to+104F, 15 to 90% relative humidity
Pressure indicating Range	: 0 to 300 mmHg (Cuff pressure)	Storage environment	: -4F to+122F, 15 to 95% relative humidity
Measuring Range	: 50 to 250 mmHg (systolic) 40 to 180 mmHg (diastolic) 40 to 160 pulse/min. (pulse rate)	Cuff	: Coverage arm circumference : 8.7 to 12.6 in. [22 to 32 cm]
Accuracy	: ±3 mmHg (Cuff pressure) ±5% of reading (pulse rate)	Main Unit	: Weight : Approx. 13.4 oz. [370 g] (without batteries) Size : 6.4 x 7 x 3.2 in [163 x 180 x 83 mm] (W x D x H) when CUFF HOLDER attached
Inflation	: Automatic inflation		
Deflation	: Electric control valve		
Exhaust	: Automatic exhaust valve		
Power Supply	: 4 pcs. 1.5 volt "AA" (R6P/LR6) type batteries or AC adapter	Specifications are subject to change without notice due to improvements in performance.	

PRECAUTIONS FOR USE

Do not use this instrument without consultation with your doctor if you are under dialysis therapy or on anticoagulants, antiplatelets or steroids. Use of this instrument under such conditions could cause internal bleeding.

To avoid any possibility of accidental strangulation, keep this unit away from children and do not drape AIR HOSE ⑩ around your neck.

For specific information on your blood pressure, contact your physician. Never make any judgment on measurement results on your own.

Use of this device in areas near portable phones, microwave ovens or other devices with strong electromagnetic field may cause malfunctions.

TIPS ON TAKING YOUR BLOOD PRESSURE

Blood pressure is a measurement of the force exerted by the heart in pumping the blood through the arteries and the resistance by the veins in this flow.

Blood pressure changes easily as influenced by mental and physical factors and is never constant.

Causes for Changes in Blood Pressure

- Body movement
- Drinking Alcohol
- Temperature
- Conversation
- Smoking
- Changes in the surroundings such as movement or noise, etc.
- Mental Tension
- Emotions
- Meals
- Recent Urination or Bowel Movement

In general, blood pressure is highest during the working hours and gradually decreases during the afternoon and evening hours. It is low during sleep and slowly increases at a relatively fast rate after arising from bed.

Blood pressure measured at home tends to be lower than when measured in a hospital, clinic or doctor's office.

When blood pressure is measured in a hospital, it could be higher than when measured at home. This is because you are tense at the hospital and relaxed at home. It is important to know your stable normal blood pressure at home.

Let a qualified physician interpret your blood pressure readings.

Depending on your age, weight and general condition, blood pressure can be slightly different. Consult with your doctor on determining what blood pressure is normal for you.

Blood pressure classification by WHO (1999)

Blood pressure changes shown below.
Upper arm blood pressure date.

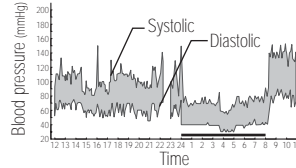

180~	(severe)					
160~179	(moderate)					
140~159	(mild)					
130~139	High Normal					
120~129	Normal					
~120	Optimal					
SYS mmHg		80	85	90	100	110
DIA		80	84	89	99	109

Rest for approximately five minutes and take your blood pressure while relaxed in a quiet environment.

TIPS ON TAKING YOUR BLOOD PRESSURE

Take blood pressure measurement with the correct posture and do not move nor speak during measurement.

Avoid exercise, eating, drinking alcohol, smoking and other activities that affect your blood pressure right before a measurement.

Take your blood pressure every day at the same time.

The ambient temperature should be approximately 68°F (20°C) when you take your blood pressure.

INSTALLING BATTERIES AND SETTING THE CLOCK see fig. 1

1 Turn the unit over and remove CUFF HOLDER ⑦ from the unit.

2 Open the battery cover.

Never forcefully remove CUFF HOLDER or the battery cover.

3 Install four "AA" type batteries into the compartment as indicated. Make sure that the polarities correspond to the (+) and (-) marks.

4 Close the battery compartment cover.

Year flashes on the display.

Clock can be set only after the batteries are reinstalled. Adjust the clock so that measurement results are stored with correct date and time.

5 Use M1 ③ to increase the flashing number and M2 ④ to decrease the number.

6 Press ON/OFF BUTTON ② to confirm and move to next step.

Month flashes.

7 Adjust month with M1 and M2 buttons.

8 Press ON/OFF BUTTON and day flashes.

CAUTION! Do not use rechargeable batteries.

battery replacement indication
Replace all the batteries when the battery replacement indication appears on the display or nothing is displayed even if ON/OFF BUTTON ② is depressed.

Use alkaline batteries to increase battery life. Use of regular Carbon-Zinc batteries will necessitate more frequent replacement. The enclosed batteries are for monitoring, and their life may be shorter than that of commercial batteries.

Since neither the device nor batteries are household waste, follow your local recycling rules and dispose of them at appropriate collection sites.

Operation with an AC adapter
AC ADAPTER JACK ⑥ is located on the right side of the unit. **Do not use any adapters other than the one specified below.**

Specifications of the AC adapter to be selected are:
Output voltage : 6 VDC ±5%
Input voltage range : Standard voltage ±15%
Maximum electric load : 600mA or higher

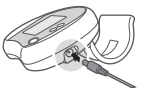

INSTALLING BATTERIES AND SETTING THE CLOCK

- 9 Adjust day with M1 and M2 buttons.**
- 10 Press ON/OFF BUTTON and hour flashes.**
- 11 Adjust with M1 and M2 buttons.**
- 12 Press ON/OFF BUTTON and minute flashes.**
- 13 Adjust with M1 and M2 buttons.**
- 14 Press ON/OFF BUTTON, the clock is set and the unit is turned off.**

The clock operates in 24-hour mode.

The clock is displayed while the unit is turned off.

Output plug polarity	:	Center Negative	⊕—⊖
Output plug shape	:	External diameter	5.50±0.1 mm
	:	Internal diameter	2.10±0.1 mm
	:	Length	9.5±0.3 mm

An approved adapter is the RadioShack PN 273-1761, with adaptaplug "M" PN 273-1716.

Remove the batteries when operating the unit with AC adapter for extended period of time.

When batteries are removed or AC adapter is unplugged, the clock returns to the default value.

CORRECT MEASURING POSTURE

see fig.2 

Sit at the table and let the table support your arm as you take the blood pressure measurement. Make sure that the measurement location on the upper arm is at approximately the same height as the heart, and that the forearm is extended naturally on the table and does not move.

You may lie on your back and take the measurement. Look at the ceiling, stay calm, and do not move your neck or body during the measurement. Again, make sure that the measurement location on the arm is at approximately the same height as the heart.

WRAPPING THE CUFF

see fig.3 

- 1 With the tube of the cuff positioned in the direction of the fingertips, place it on your left arm.**
- 2 Wrap the cuff around the arm with the edge of the cuff approximately 1 inch (2.5 cm) above the elbow.**
- 3 Press the surface of the cuff to make sure that it is attached securely.**

When wrapping the cuff, wrap it loosely enough around the arm so that two fingers can be placed between the cuff and the arm. If the cuff is wrapped more tightly or loosely than this, inaccurate blood pressure readings may result.

If you are wearing a shirt that might restrict circulation in your upper arm or you roll your sleeve up over the upper arm, the blood flow will be restricted, preventing accurate measurement.

MEASUREMENT PROCEDURES

see fig.4 

Take deep breaths and relax. Do not move, chat or strain your arm or hand during measurement.

- 1 Insert TUBE PLUG ⑪ into AIR CONNECTOR ⑤.**
- 2 Press ON/OFF BUTTON ②.**

Beep sounds and the monitor automatically starts inflation.

The inflation stops as beep sounds and the displayed value (pressure) decreases.

The pulse is indicated by heart mark "♥" with synchronizing beep.

Long beep sounds as the measurement completes and maximum and minimum blood pressures and pulse rate are displayed.

Deflation mark appears and the unit automatically exhausts the air from the cuff.

- 3 Press either one of MEMORY BUTTONS, M1 ③ or M2 ④, and the result is stored in the selected bank.**

The selected memory bank number is shown on the display. The result is stored in the bank which is selected when the unit is turned off. *When a measurement resulted in an error, it will not be stored.*

- 4 Press ON/OFF BUTTON to turn off the power.**

If you forget to turn off the unit, it will be automatically turned off after 3 minutes.

Stopping Measurement
Press ON/OFF BUTTON ② and the monitor will stop inflation, discharge air rapidly, and then turn off.

Do not take repeated measurements. blood can be forced into tissues beyond the cuff, which would result in incorrect measurements. Let your arm rest for at least 5 minutes.

Automatic Repressurization

If the pressure applied is judged insufficient in the early phase of measurement or if movement of arm or hand occurs during measurement, the unit will inflate again to a level about 40 mmHg higher. Automatic Repressurization is repeated until a measurement is made. However, *this does not indicate a problem.*

To manually control pressurization, hold down ON/OFF BUTTON immediately after the start of inflation and release it when the pressure reaches the level 50 mmHg higher than the expected maximum systolic pressure. If the pressure value has exceeded 180 mmHg, the inflation will stop when the key is released. Pressure can be increased to approximately 300 mmHg.

MEMORY FUNCTIONS

see fig.5 

Measured result is stored in either M1 or M2. Each of two memory banks can hold up to 30 results and their average. When the number of measurements exceeds 30, the oldest data will be deleted to record new data. You may decide which bank to store your measurement results to avoid data mixture with someone else's, or may use two banks to save data measured in the morning and evening separately.

Recalling measured data

- 1 Press MEMORY BUTTON M1 ③ or M2 ④ to see stored data.**

MEMORY FUNCTIONS

The average of the stored result in the selected bank is displayed.

The latest result stored is displayed when there is only a single result and the clock display remains when there are no results stored. The indication at the top of the display alternately changes from memory data number to date and to time. The memory data is displayed for approximately 30 seconds. Approximately 30 seconds after MEMORY BUTTON is released, the apparatus will turn off.

2 Press MEMORY BUTTON to move to next data.

The memory data number 1 is the latest among the stored data in the selected memory bank.

3 Every depression of the key switches among the memory data.

As MEMORY BUTTON is pressed, the memory data number increases: the bigger the number, the older the result.

4 Press ON/OFF BUTTON ② and turn off the unit.

DELETING STORED DATA

see fig. 6 

Deleting a single data

1 Show the data to be deleted following the steps in MEMORY FUNCTIONS.**2 Press and hold down MEMORY BUTTON M1 ③ or M2 ④ whichever the data is stored.**

The displayed data starts flashing.

Hold down the button until the display disappears.

Deleting all data in a bank

1 Press MEMORY BUTTON M1 ③ or M2 ④ and show the average of the bank to be deleted.**2 Press and hold down selected MEMORY BUTTON.**

The displayed data starts flashing.

Hold down the button until the display disappears.

CARE AND MAINTENANCE



Because the unit includes precision parts, care should be taken to avoid extreme temperature variations, humidity, shock, dust, and direct sunlight. Do not drop or strike the unit. Make sure not to expose the unit to moisture. **This unit is not water resistant.**

Use only a soft, dry cloth to clean the unit. Do not use gasoline, paint thinner, or other strong solvents on the unit. Since the cuff may absorb perspiration and other fluids, inspect it for stain and discoloration after each use. When cleaning the cuff, do not machine wash or scrub it. Use a synthetic detergent and gently rub the surface. Make sure fluid never gets in AIR HOSE ⑩. Air dry thoroughly.

When storing the unit, do not place heavy objects on it and do not coil AIR HOSE too tightly. When the unit has been stored at a temperature below the freezing point, keep it for at least 1 hour in a warm place before using it. Remove the batteries if the instrument is to be stored for an extended period of time. **Keep**

CARE AND MAINTENANCE





the batteries out of reach of children.

We suggest that you have your blood pressure monitor checked every 2 years. This operation may only be performed by the manufacturer or by firms authorized by the manufacturer.

Do not inflate the cuff when it is not wrapped around your arm.

Do not disassemble or modify the unit.

ERROR DISPLAYS AND TROUBLESHOOTING

ERROR SYMOL / SYMPTOM	CAUSE / CHECK POINT	REMEDY
	OVER-PRESSURIZATION The cuff was inflated to the maximum pressure because of movement of body etc.	Do not move during measurement.
	MEASUREMENT ERROR Measurement could not be made because of moving or talking during measurement.	Remain still and quiet during measurement.
	INFLATION ERROR TUBE PLUG ⑪ is not correctly inserted.	Reinsert TUBE PLUG ⑪ and make sure that it is securely inserted.
	DEFLATION ERROR Movement or talking was detected during measurement.	Turn off the power and make another measurement while being quiet and still.
	IMPROPER OPERATION ON/OFF BUTTON ② was accidentally pressed during battery replacement.	Press ON/OFF BUTTON ② to turn off the power once and press it again to start a measurement.
No display when ON/OFF BUTTON ② is pressed.	Have the batteries polarities been positioned incorrectly? Have the batteries run down? Are the battery terminals clean?	Reinsert the batteries in the correct position. Replace them with new ones. Clean the battery terminals with a dry cloth.

ERROR DISPLAYS AND TROUBLESHOOTING

ERROR SYMOL / SYMPTOM	CAUSE / CHECK POINT	REMEDY
No display when MEMORY BUTTON (③ or ④) is pressed.	Is there any measured result stored in the memory? Are you pressing the right MEMORY BUTTON? Have the batteries run down?	Nothing is displayed when there is no measured data stored. Check the memory bank number. Replace them with new ones.
Cannot make great number of measurements.	Are you using alkaline batteries?	Use alkaline batteries to increase battery life.
Cannot complete the measurement.	Have the batteries run down?	Replace all four batteries with new ones.
Blood pressure is different each time. The reading is extremely low (or high).	Are you measuring with correct posture? Blood pressure readings constantly vary with time of measurement and nervous condition.	Measure with the correct posture. See TIPS ON TAKING YOUR BLOOD PRESSURE.
Pulse rate is too low (or too high).	Did you move during the measurement? Did you make measurement right after exercise?	Remain still during the measurement. Measure again after resting for more than 5 minutes.
The power is automatically turned off.	Have you left the instrument untouched after the measurement?	This does not indicate a problem. The instrument automatically turns off 3 minutes after a measurement or 30 seconds after memory display.

If you cannot get correct measurement with the methods above, do not tamper with the internal mechanism. Contact your dealer. If the unit malfunctions, please return it to the dealer or an authorized service representatives for service according to the warranty. Service data are provided to qualified dealers by the manufacturer.

Free Manuals Download Website

<http://myh66.com>

<http://usermanuals.us>

<http://www.somanuals.com>

<http://www.4manuals.cc>

<http://www.manual-lib.com>

<http://www.404manual.com>

<http://www.luxmanual.com>

<http://aubethermostatmanual.com>

Golf course search by state

<http://golfingnear.com>

Email search by domain

<http://emailbydomain.com>

Auto manuals search

<http://auto.somanuals.com>

TV manuals search

<http://tv.somanuals.com>