

## FCC Statement

### For product sold in USA

This device complies with Part 15 of the FCC Rules.

Operation is subject to the following two conditions:

(1) This device may not cause harmful interference, and (2) this device must accept any interference received, including interference that may cause undesired operation.

• This equipment has been tested and found to comply with the limits for a Class B digital device, pursuant to part 15 of the FCC rules. These limits are designed to provide reasonable protection against harmful interference in a residential installation. This equipment generates, uses and can radiate radio frequency energy and, if not installed and used in accordance with the instructions, may cause harmful interference to radio communications. However, there is no guarantee that interference will not occur in a particular installation. If this equipment does cause harmful interference to radio or television reception, which can be determined by turning the equipment off and on, the user is encouraged to try to correct the interference by one or more of the following measures:

- Reorient or relocate the receiving antenna.
- Increase the separation between the equipment and receiver.
- Connect the equipment into an outlet on a circuit different from that to which the receiver is connected.
- Consult the dealer or an experienced radio/TV technician for help.

**NOTE: Changes or modifications not expressly approved by the manufacturer responsible for compliance could void the user's authority to operate the equipment.**

### For product sold in Canada • Pour les produits vendus au Canada

THIS CLASS B DIGITAL APPARATUS COMPLIES WITH CANADIAN ICES-003.

CET APPAREIL NUMÉRIQUE DE LA CLASSE B EST CONFORME À LA NORME NMB-003 DU CANADA.  
(VALID FOR CANADA ONLY • VALABLE AU CANADA SEULEMENT)

Operation is subject to the following two conditions:

(1) this device may not cause interference, and (2) this device must accept any interference, including interference that may cause undesired operation of the device.

L'utilisation de ce dispositif est autorisée seulement aux conditions suivantes :

(1) Il ne doit pas produire de brouillage et (2) il doit pouvoir tolérer tout brouillage radioélectrique reçu, même si ce brouillage est susceptible de compromettre son fonctionnement.

## BARBIE GIRLS™ CUSTOMER SUPPORT

For questions about the Barbie Girl™ device  
and BarbieGirls.com, call

**US and Canada:** service.mattel.com or call **877 3BARBIE** (877-322-7243),  
M-F 9am - 7pm, Sat 11am - 5pm, Eastern Time.

**UK:** service.mattel.com/uk or Call 01628 500303, M-F 9am - 5pm

**Australia:** 1300 135 312 or 1800 674 753 M-F 8am - 4:30pm, EST.

**New Zealand:** 0800 174 063 M-F 10am - 6:30pm, Australia EST.

For U.S.A. market only:

We want you to have fun playing with our products.

Please give us your feedback by filling out the short on-line survey.

Go to:

**service.mattel.com/surveys**

Thanks for helping us make great toys even better!

Mattel Canada Inc., Mississauga, Ontario L5R 3W2. You may call us free at/ Composez sans frais le 1-800-524-8697.

Mattel U.K. Ltd., Vanwall Business Park, Maidenhead SL6 4UB.

Mattel Australia Pty., Ltd., Richmond, Victoria. 3121. Consumer Advisory Service - 1300 135 312.

Mattel East Asia Ltd., Room 1106, South Tower, World Finance Centre, Harbour City, Tsimshatsui, HK, China.

Diimport & Diedarkan Oleh: Mattel SEA Ptd Ltd.(993532-P) Lot 13.5, 13th Floor, Menara Lien Hoe, Persiaran

Tropicana Golf Country Resort, 47410 PJ. Tel:03-78803817, Fax:03-78803867.

Mattel, Inc., 333 Continental Blvd., El Segundo, CA 90245 U.S.A. Consumer Relations 1 (800) 524-8697.

Download from [Www.Somanuals.com](http://Www.Somanuals.com). All Manuals Search And Download.



## INSTRUCTIONS



L2935-092064

Keep these instructions for future reference  
as they contain important information.



© 2007 Mattel, Inc., 333 Continental Blvd., El Segundo, CA 90245 USA. All Rights Reserved. Tous droits réservés. Macromedia is a trademark of Adobe Systems Incorporated. Pentium is a trademark or registered trademark of Intel Corporation or its subsidiaries in the United States and other countries. Windows Media Player, Windows and the Windows logo are trademarks, or registered trademarks of Microsoft Corporation in the United States and/or other countries. This product is protected by certain intellectual property rights of Microsoft. Use or distribution of such technology outside of this product is prohibited without a license from Microsoft. iTunes is a registered trademark of Apple, Inc. in the United States and/or other countries. miniSD is a trademark of SD-3C, LLC.

## GENERAL

### SYSTEM REQUIREMENTS:

Windows® XP or Windows® Vista; Pentium® III 800 MHz or above or equivalent processor; 512MB RAM; 200MB free hard drive space; DirectX 9.0b or above; Internet Explorer 6.0 or later with SP1 and Macromedia Flash Plug In; Internet connection (broadband recommended); Windows Media Player 11; USB 2.0 port; CD-ROM drive;  
*NOT MAC O/S COMPATIBLE.*

Software use is subject to acceptance of the End User License Agreement.

### FEATURES:

512MB built-in memory

Holds up to 120 songs/8 hours of MP3 music <sup>1</sup>

Holds up to 240 songs/16 hours of WMA music <sup>1</sup>

Expandable miniSD card slot, up to 2GB (card sold separately)

USB connector

Built-in rechargeable lithium polymer battery (charges via the USB port)

Up to 10 hours of battery life per charge <sup>2</sup>

3.5mm headphone jack

<sup>1</sup> Song capacity based on 4 minutes per song and 128-Kbps MP3 encoding or 64 Kbps WMA encoding; actual capacity varies by content and bit rate.

<sup>2</sup> Playback varies with use. Rechargeable batteries have a limited number of charges.

## TABLE OF CONTENTS

<b>UNPACK CONTENTS</b> .....	2
<b>FASHION PLAY</b> .....	3
<b>ONLINE PLAY</b> .....	4
Installation & Registration .....	4
Remove Player Safely from Computer .....	5
Barbie Girls™ Software .....	7
Note To Parents .....	7
Chat .....	7
Best Friends Registration .....	8
<b>MUSIC PLAY</b> .....	9
Charging the Battery .....	9
Transferring Music Files .....	10
Transferring Music From CD to your Computer .....	10
Transferring Music to Barbie Girl™ .....	11
Controls .....	12
Listening To Music .....	14
Listening Tips .....	14
Music on the Go! .....	14
Optional miniSD Card .....	15
<b>HINTS</b> .....	16
<b>STORAGE</b> .....	17
Horizontal Use .....	17
Wall mounted .....	17

## UNPACK CONTENTS

Please remove items from the package and compare to the contents shown here (1). If any items are missing, contact your local Mattel office. Fashions may vary.



Turn package over and peel off labels as shown (2).  
Remove paper cover and Online Startup Guide (3).  
Remove CD-ROM from back compartment (4).

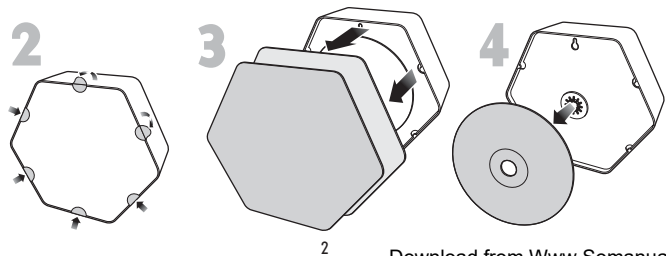

## FASHION PLAY

Mix and match “face”, “fashions” and “hair” to create your own look.

**To disassemble:** Insert the “key” on the belt clip into the slot then twist to remove the back cover of your Barbie Girl™ (1 & 2).

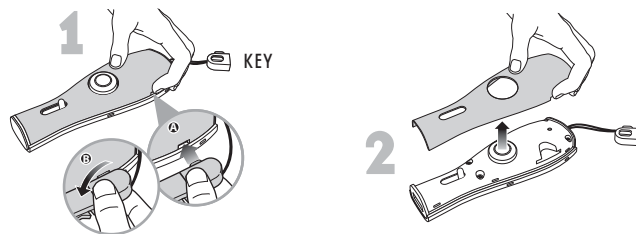

**To remove fashion pieces:**

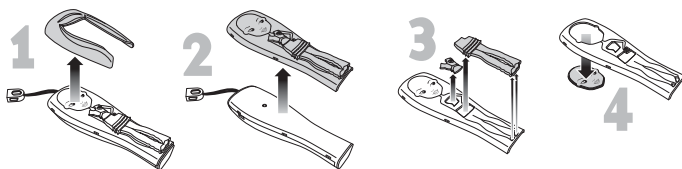

**To add fashion pieces:**

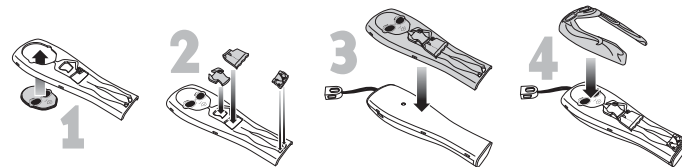

## ONLINE PLAY

Your Barbie Girl™ includes a one-year premium subscription at BarbieGirls.com. Your one-year subscription is activated when you register your Barbie Girl™ during the CD registration process. At the end of one year, your premium subscription will expire and you will be given the option to renew.

### Installation and Registration

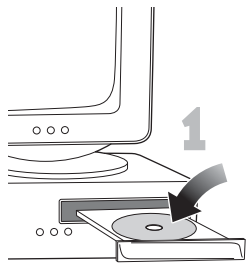

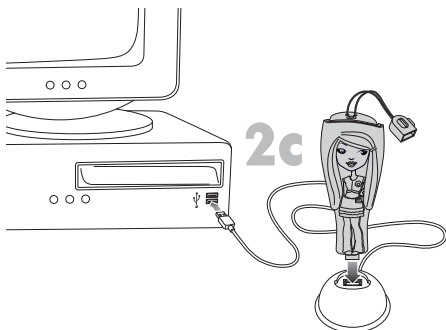
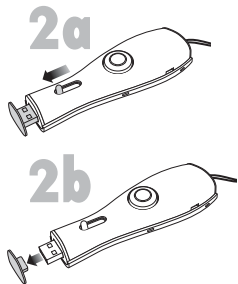

**1.** Insert the CD-ROM into your CD drive (1) to launch the installer. If it doesn't launch automatically, double-click "My Computer" on your Desktop, then double-click on the CD drive. Double-click "setup.exe".

**2.** After installation is complete, plug the docking station into your computer's USB port and place your Barbie Girl™ device in the docking station (2a-2c).

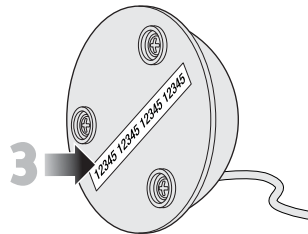

**3.** Make sure you're connected to the Internet, and use the code found on the bottom of your docking station (3) to register.



**4.** Go online and start exploring! You can watch a video tour about BarbieGirls.com. Click on the  icon if you need help along the way.

**5.** When finished, remove the device from your computer safely.

**Follow this procedure to prevent damage to your Barbie Girl™:**



Double-click the "Safely Remove Hardware" icon in the System Tray (4a).

In the "Safely Remove Hardware" window that appears, click on the "Barbie Girls" entry (4b). Click "Stop" (4c).

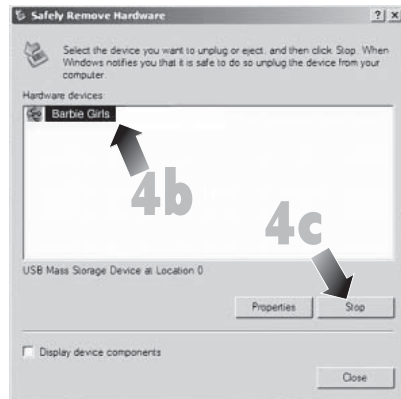

The “Stop a Hardware device” window pops up. Click “OK” (4d). When the “Safe To Remove Hardware” bubble appears you can unplug the docking station from the computer, or unplug your Barbie Girl™ from the docking station.



If you can't see the “Safely Remove Hardware” icon, double-click on “My Computer”. Right-click on the “Barbie Girl” entry and select “Eject”. Now it is safe to unplug your Barbie Girl™.

**5.** Retract the USB connector (5a) and replace the protective cover (5b).

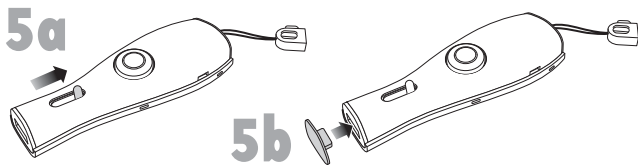

## Barbie Girls™ Software

Use the Barbie Girls™ software for easy access to BarbieGirls.com and your music. Launch the software by double-clicking on the desktop icon . Or, just plug in your Barbie Girl™. The software will launch automatically.

You can connect to BarbieGirls.com, add new Best Friends, or launch Windows Media Player™ to transfer music to your Barbie Girl™.

### Note to Parents:

BarbieGirls.com was designed to be a safe, fun and exciting place for girls to play online. Our special B Chat™ feature utilizes a sophisticated word filter that keeps chat appropriate and prevents personal information, such as your child's name, phone number or address, from being given out to anyone unknown to you. You can help by spending time online with your child and monitoring your child's online use!

### Chat

BarbieGirls.com offers two kinds of chat. B Chat™ is available to all Barbie Girls™ characters online, and does not allow girls to share personal information. Secret B Chat™ is available only to girls who follow the Best Friends registration process below. With Secret B Chat™, girls can chat about even more!

## Best Friends Registration

Your best friends in real life can become your best friends online too! You can have a Secret B Chat™ with your best friends on BarbieGirls.com. It's easy:

**1)** Place your friend's Barbie Girl™ in your docking station to launch the Best Friends installer. If the Barbie Girls™ software is already running, just click the "Add a Best Friend" icon. 

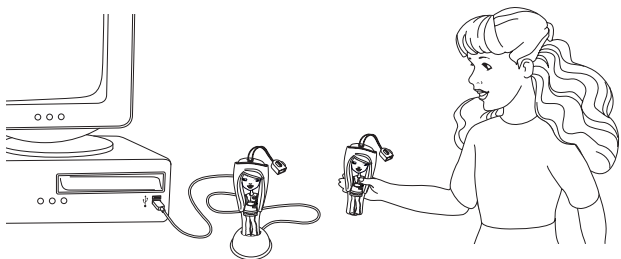

**2)** Enter both of your screen names and your password.

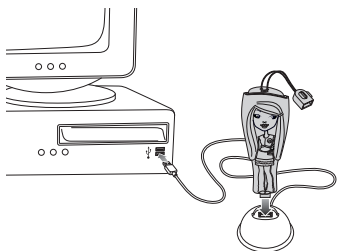

**3)** Go online to play! 

## MUSIC PLAY

### Charging the Battery

Barbie Girl™ contains a rechargeable battery and charges via your USB port. Charge the battery before using the device. Slide knob toward bottom of device to expose the USB connector (**1**). Remove the USB connector's protective cover (**2**) and save. Plug into docking station (**3**), and plug the docking station into a USB port on your computer.

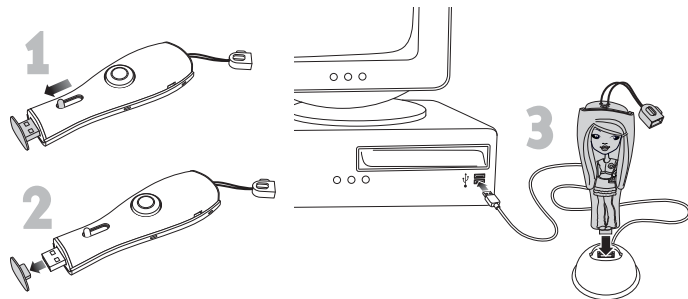



It will take up to three hours to recharge. The LED lights when charging, and turns off when Barbie Girl™ is fully charged. Barbie Girl™ can play back for approximately 10 hours when fully charged. When the LED flashes or volume decreases, it is time to recharge the battery.

## Transferring Music Files

**NOTE:** Distributing copies of music tracks without permission is a violation of international copyright laws.



### Transferring Music From CD to your Computer

1. Launch the Barbie Girls™ software by plugging in your Barbie Girl™ or double-clicking the desktop icon . Click the “Transfer Music” icon to start Windows Media Player™. 
2. Insert an audio CD into your CD-ROM drive.
3. Click the “Rip” tab. Check the songs you want to transfer to your music library. 
4. Click “Start Rip”. After a short time the songs will be added to your library and can then be added to your Barbie Girl™.

For additional information about ripping music, click the “Help” menu in Windows Media Player.

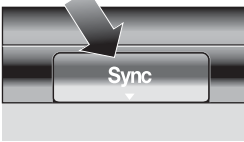

### Transferring Music to Barbie Girl™

1. Launch the Barbie Girls™ software by plugging in your Barbie Girl™ or double-clicking the desktop icon . Click the “Transfer Music” icon to start Windows Media Player™. 
2. Click the “Sync” tab. Click “Library” to view the songs in your library.
3. Drag songs to the right window.
4. Click “Start Sync” to copy songs to Barbie Girl™. 
5. When sync is complete, disconnect Barbie Girl™ from your computer safely. See pages 5 and 6.

If a miniSD card is attached, music will sync to the miniSD card first. To sync to onboard memory, click “Next Device->”. Follow steps 3 through 5 above.

If MP3 or WMA files are present in an attached miniSD card, music will play first from onboard memory, then from the card.

For additional information about syncing music, click the “Help” menu in Windows Media Player.

## Controls

**POWER ON:** Plug in the earbuds (1) to turn your Barbie Girl™ on. Or if the earbuds are already in, hold down the PLAY/PAUSE button for 3 seconds to turn your Barbie Girl™ on. The LED lights when the power is on.

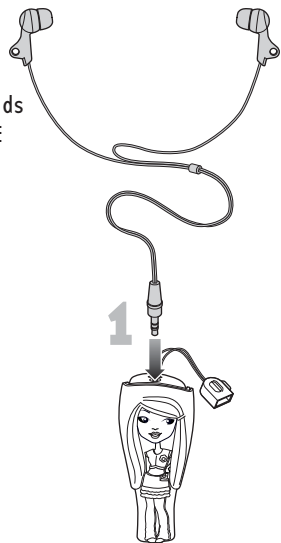

Adjust the volume by pressing the VOLUME UP [ + ] or VOLUME DOWN [ - ] button.

Music playback will start automatically after a few seconds.

Press the PLAY / PAUSE [ ▶|| ] button to pause the music. Press again to continue play.

During playback, press and hold the SKIP / SEARCH FORWARD [ ▶▶ ] button to advance forward within a song (or, press and hold the SKIP / SEARCH BACKWARD [ ◀◀ ] button to move backwards through a song). Release the button when you have located the section you wanted. Normal playback resumes.

Press and release the SKIP / SEARCH FORWARD [ ▶▶ ] button to advance to the next song. Repeat until you get to the desired song.

Press and release the SKIP / SEARCH BACKWARD [ ◀◀ ] button to hear the beginning of the current song. Press again to go back to the beginning of the previous song. Repeat until you get to the desired song.

**POWER OFF:** To turn your Barbie Girl™ off, hold down the PLAY/PAUSE [ ▶|| ] button for 3 seconds. The LED turns off. You can also unplug the earbuds to turn the power off.

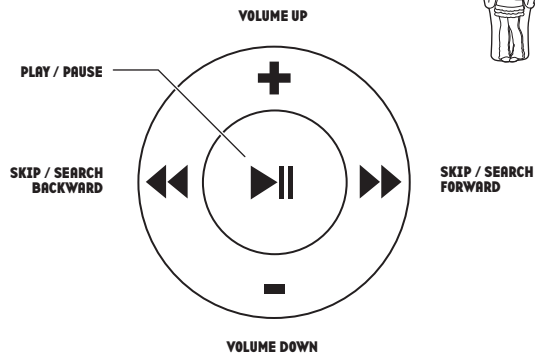



## Listening To Music

Barbie Girls™ earbuds come with 3 sizes of earpieces. Use the set that best fits your ears. To remove an earpiece, grasp it carefully and pull away from the earbud. To attach an earpiece, push it over the stem on the earbud.

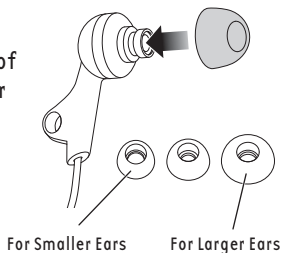

## Listening Tips

To protect your hearing, ALWAYS follow these instructions:

1. Connect the earbuds to the device as shown.
2. After a few seconds, playback will begin automatically.
3. Press the VOLUME DOWN [ - ] button several times.
4. Put the earbuds in your ears.
5. Slowly increase the volume by pressing the VOLUME UP [ + ] button until you hear the music clearly and without distortion. Use this setting for future listening.

## Music On The Go!

Your Barbie Girl™ is portable.

Insert the Belt Clip into the device (1). Slide the belt clip down onto your belt or the top edge of your trousers (2) as shown. Disconnect the belt clip by pressing the button on the connector (3).

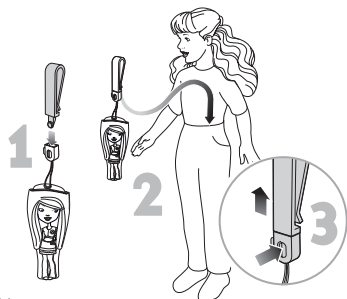

## miniSD CARD

Your Barbie Girl™ has a built-in miniSD card reader that will allow you extra song/file storage capacity of up to 2GB (card not included).

**CAUTION:** Hold down the PLAY/PAUSE button for 3 seconds to turn Barbie Girl™ off before inserting or removing a miniSD card.

### To remove the miniSD card:

Your Barbie Girl™ comes with a protective plastic card. To remove the card, remove the cover (see 1 & 2, below), then push in on the edge. The card will pop out.

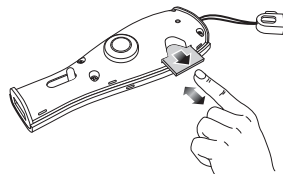

### To insert the miniSD card:

Insert the “key” on the belt clip into the slot then twist to remove the back cover of your Barbie Girl™ (1 & 2). Insert the miniSD card as shown (3). Replace the cover (4).

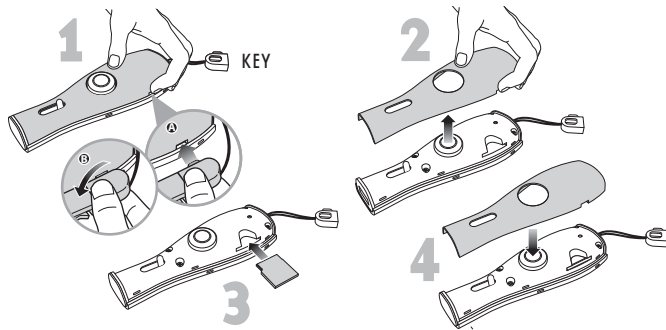

## HINTS

Your Barbie Girl™ is not compatible with music downloaded from the iTunes™ store, or WMA files protected with DRM.

If you ever need to reset your Barbie Girl™ – Remove the cover from the back of your Barbie Girl™ (see page 3). Use a paper clip to press the reset switch as shown. Replace the cover. Resetting your Barbie Girl™ will not delete any of your music files.

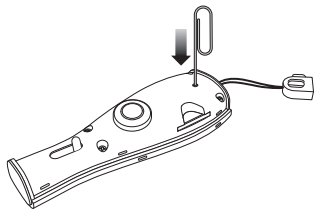

If you're having trouble registering your Barbie Girl™ or making Best Friends, make sure everything is plugged in. Check the connection between your Barbie Girl™ and the docking station, and make sure the docking station cable is plugged into your USB port. Make sure you're connected to the Internet.

See back cover for customer support information.

## STORAGE

Barbie Girl™ comes with a durable storage case. It can be used horizontally or mounted on a wall.

### Horizontal Use

Attach the CD to the rear of the storage case (1). Put all the components of your Barbie Girl™ into the storage case (2). Put the lid on the storage case (3).

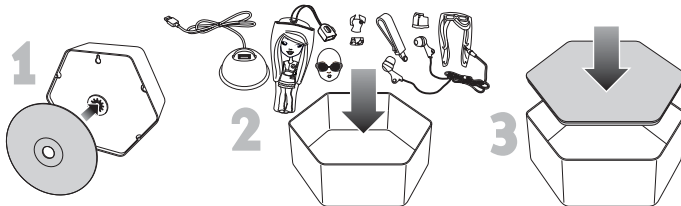

### Wall Mounted

Attach the CD to the rear of the storage case (1). Insert the slot on back of storage case onto a nail or screw that is secured into a wall (2). Put all the components of your Barbie Girl™ into the storage case (3). Put the lid on the storage case (4).

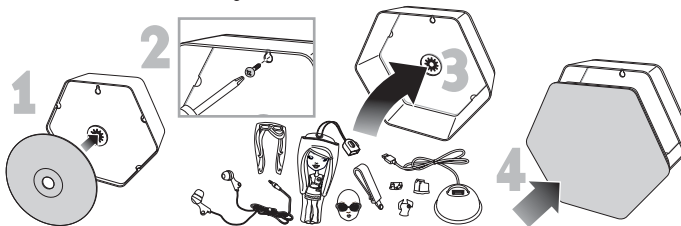

## BATTERY SAFETY INFORMATION

Product includes a non-replaceable lithium battery.

In exceptional circumstances batteries may leak fluids that can cause a chemical burn injury or ruin your product.

To avoid battery leakage:

Dispose of batteries safely.

Do not dispose of this product in a fire. The batteries inside may explode or leak.

### Adult Note:

To remove battery for safe disposal, open the Barbie Girl™ device using a Phillips head screwdriver (not included) and remove battery.



Protect the environment by not disposing of this product with household waste (2002/96/EC). Check your local authority for recycling advice and facilities.

## Free Manuals Download Website

<http://myh66.com>

<http://usermanuals.us>

<http://www.somanuals.com>

<http://www.4manuals.cc>

<http://www.manual-lib.com>

<http://www.404manual.com>

<http://www.luxmanual.com>

<http://aubethermostatmanual.com>

Golf course search by state

<http://golfingnear.com>

Email search by domain

<http://emailbydomain.com>

Auto manuals search

<http://auto.somanuals.com>

TV manuals search

<http://tv.somanuals.com>