

LIMITED WARRANTY* ONE (1) YEAR:

Your *Elite* appliance is built with precision, inspected and tested before leaving our factory. It is warranted, to the original purchaser, to be free from any manufacturing defects under normal use and conditions for one (1) year, cord excluded. During that period, should the appliance fail to operate properly, return the appliance with your sales receipt to the store where purchased. This warranty gives you special legal rights and you may also have other rights to which you are entitled, which may vary from state to state. If you use your appliance for household use and according to instructions, it should give you years of satisfactory service.

This limited warranty covers appliances purchased and used within the surrounding United States and does NOT cover:

- Damages caused from improper usage or installation of appliance.
- Damages caused from shipping.
- Defects other than manufacturing defects.
- Breakage caused by misuse, abuse, accident, alteration, lack of proper care and maintenance, or incorrect current or voltage.
- The loss or missing parts of the appliance. Parts will need to be purchased separately.
- Damage from service by other than an authorized dealer or service center.
- Any transportation and shipping charges.

RETURNS: Any return of defective merchandise to the manufacturer must be processed accordingly by contacting customer service first to obtain RA # (Return Authorization Number). We will not accept any returns of merchandise without an applicable RA #.

*One Year Warranty valid only in the United States, **excluding** Alaska, Hawaii, and Puerto Rico.

For international warranty, please contact the local distributor.

**Any instructions or policy included in this manual may subject to change at any time.

Model EPM -400

Elite Popcorn Maker

Distributed by: **MAXI-MATIC®**, USA

18401 E. Arenth Ave. Building B. City of Industry, CA 91748

Customer Service Department: (626) 912-9877 Ext. 116/120 MON-FRI 9am-5pm PCT

Email: info@maxi-matic.com

POPCORN MAKER



INSTRUCTION MANUAL

ALWAYS READ ALL INSTRUCTIONS BEFORE USING

IMPORTANT SAFEGUARDS

When using any electrical appliance, basic safety precautions should always be followed, including the following:

1. **READ ALL INSTRUCTIONS BEFORE USING YOUR POPCORN MACHINE.**
2. Keep door closed while operating. Do not touch kettle while operating – this area gets **HOT**.
3. Do not touch hot surfaces. Always use handles or knobs to operate.
4. To avoid any risk of electrical shock, do not immerse cord or plug into water or other liquid.
5. Close supervision is necessary when it is being used by or near children.
6. Unplug main power cord from outlet while not in use and before cleaning.
7. Allow **HOT** parts to cool down before moving.
8. **DO NOT** operate the appliance with damaged cord or plug, malfunction or with any mechanical damages. Send the unit to the nearest authorized service center for examination and repairs (ONLY technicians should open up the unit)
9. It may cause injury by using any accessory or attachment not provided or recommended by manufacturer.
10. Do not pop the kernel with a dry pot (without oil).
11. Do not immerse popping kettle set into water.
12. Kettle surface is **HOT** and should **NOT** be touched during popping or immediately after use.
13. Unplug, clean and cover the unit and store into dry and safe place if not being used for long time.
14. Do not leave power cord hanging over edge of table or counter or come in contact with any hot surfaces.
15. Do not place the unit on or near a hot gas or electric burner or in a heated oven.
16. Extreme caution must be paid when moving the appliance containing hot oil or other hot liquids.
17. Always connect the plug to the popping kettle first, and then the main power cord into the wall outlet.
18. Turn ALL switches to “OFF” position before disconnect power plug from the wall supply outlet.
19. Always position appliance close to a power outlet to avoid tripping over power cord.
20. Not recommended for use outdoors.
21. Do not use appliance for other than indicated usage.
22. The popping kettle should **NOT** be connected with ANY plug and socket system out of this unit.
23. To avoid overheating, always add oil and then kernels before operating.
24. Extreme caution must be paid when emptying popcorn from the kettle. Always place the kettle over a counter-top so the residual oil or condensation will not cause burns
25. **KEEP OUT OF REACH OF CHILDREN.**
26. **DO NOT CLEAN USING ANY ABRASIVE MATERIAL.**
27. **NEVER LEAVE UNATTENDED WHILE IN USE.**
28. **NEVER FORCE ANY PARTS OR BRACKETS INTO POSITION.**
29. **NO PARTS ARE INTENDED FOR THE DISHWASHER.**

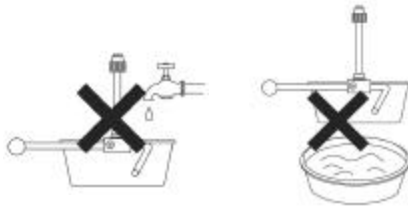

**SAVE THESE INSTRUCTIONS
FOR HOUSEHOLD USE ONLY**

INTRODUCTION:

Thank you for purchasing the old fashioned popcorn maker. This is a great item to have around any fun household or atmosphere. It will add a touch of nostalgic delight to any recreation room with its great turn of the century vendor style design.

Although the popcorn maker may look old fashioned, rest assured that the appliance uses the latest technological advances in kettle popcorn operation. You never have to go without the old fashioned taste of delicious freshly popped popcorn when watching a movie right at home with your family. It is a great way to spend some fun and quality time with the loved ones.

Here are some great recipe tips to use with your popcorn maker.

- **Regular Theater Style Popcorn** – Simply add butter and salt to your liking.
- **Southwestern Flare** – Add a teaspoon of powdered ranch dressing in a packet mixed with some cayenne pepper.
- **Garlic Gourmet** – ¼ teaspoon of garlic powder and garlic salt and shake it up.
- **Cheesy Cheddar** – ½ teaspoon of powdered cheddar cheese.
- **Muy Caliente** – A touch of cayenne pepper, ½ teaspoon of powdered cheddar cheese, and ½ a cup of jalapeño peppers that have been pat dried.
- **The Work** – ¼ teaspoon of garlic powder, powdered cheese, onion powder, cayenne pepper, and salt and pepper.

* Make sure to shake or toss well in order to cover all the popcorn with the seasonings from above.

* All the above are just references and can be adjusted to your own taste.

The popcorn maker is a great excuse to have celebrations or gatherings for no particular reason at all. Simply invite your neighbors or your friends, or gather around with the family.

Here are a few fun ideas for when to use your popcorn maker:

MOVIES:

- A night of Cowboys and Indians movies with Southwestern Flare flavored popcorn.
- An evening of sappy romantic comedies accompanied with Regular flavor or Cheddar flavor. Avoid the Garlic Gourmet or The Works for any romance.

PARTIES & GET-TOGETHERS:

- Birthdays
- 50s, 60s, 70s or 80s music theme night
- Board Games
- Sports Night
- Poker Night
- Karaoke Night

WHERE TO USE YOUR POPCORN MAKER:

Always make sure the popcorn maker is set on a flat and level surface before operating.

- Office
- Recreation Room
- Family Room
- Club House

You are now ready to use your popcorn maker. Have fun and enjoy!

Model no. & Specifications:

Model no.: EPM-400

Voltage : AC 120V~60Hz

Input Power: 860W

Please read this user manual carefully before assembling and using.

Assembling Parts

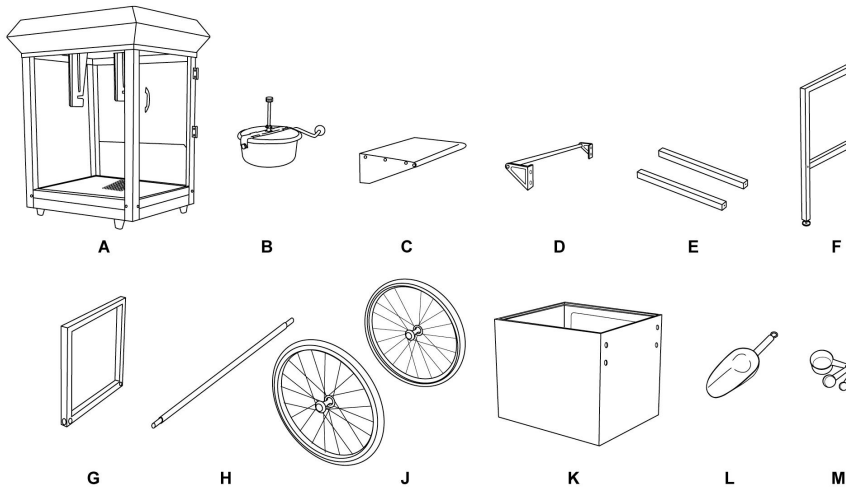

- A. Main unit x 1 pc
B. Popping pot x 1 pc
C. Working platform x 1 pc
D. Hand rail x 1 pc
E. Square pole x 2 pcs
F. Long stand x 1 set
G. Short stand x 1 set
H. Wheel axis x 1 pc
J. Wheels x 2 pcs.
L. Popcorn scoop x 1 pc
M. Kernel scoop + Oil scoop set
- N. Parts x 1 box include:
- (Package A) gold plated bolts x 8 pcs. + nuts x 8 pcs. + washers x 8 pcs.
 - (Package C) metal sleeves x 2 pcs. + nuts with round cap x 2 pcs.
 - (Package B) bolts x 8 pcs. + washers x 4 pcs.
 - (Package D) wrench x 2 pcs.

Assembling Instructions:

- 1 . Use bolts & washers (Package B) provided to connect to the Long stand (F) and the 2-pcs of the square poles (E) together.
- 2 . Connect the completed above parts (1) with the short stand (G) by using the bolts & washer in – (Package B).
- 3 . Insert axis (H) into short stand. Place sleeves and washers from (Package C) onto each side of wheels (J) and fix it with the round cap nuts with wrenches provided in (Package D).
- 4 . Turn the storage cabinet (K) up side down for convenient assembly. Insert both ends of the short and long stand into the bottom of (H) and then fix by bolts in (Package B).
- 5 . Turn the completed unit back to up-right position. Install the handrail (D) onto the left hand & the working platform (C) on the right hand by bolts & nuts with washers included in (Package A).
- 6 . Place the main unit (A) onto the topside of the storage cabinet. (Caution: Power cord outlet should be inserted into the U-shape position.)
- 7 . Hook up the Kettle Pot (B) onto the hanger. (Caution: Roller bar should be on the door side and also check if gears between pot and ceiling are perfectly matched).
- 8 . Connect the power plug from the ceiling with the socket on the bottom of the pot.
- 9 . Open the door of the storage cabinet and release the spring shaft beneath the main unit in order to fix the main unit with the storage base.

Remark: Main unit alone could be used and placed on a stable counter top for operation.

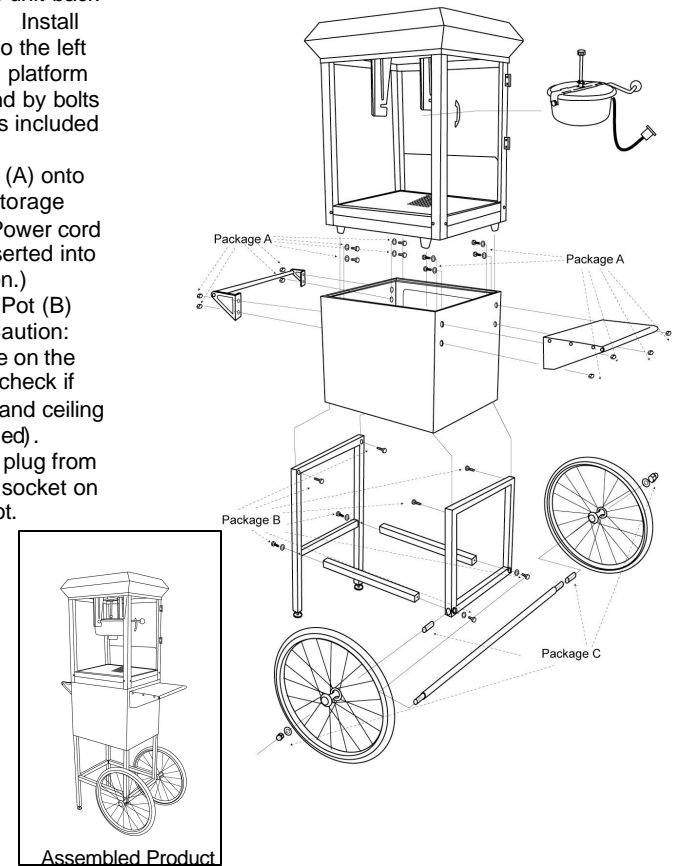

USING YOUR POPCORN MAKER

TIP: The popcorn maker comes with a handy storage compartment. It is a convenient way for you to store any utensils or non-perishable ingredients right along with your popcorn maker. You will always be prepared and well equipped to make hot, fresh popcorn anytime.

- 1) Make sure the popcorn maker is unplugged before you do any of the following.
- 2) Before using the unit, please check carefully if voltage is suitable to the wattage. (Please check if the voltage is matching with rating label specified next to the power cord).
- 3) Clean the internal surface of the kettle pot and main unit surfaces.
- 4) Main unit has 3 function switches as follows:

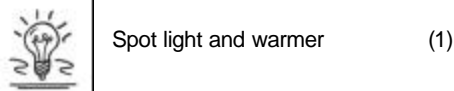

Spot light and warmer (1)



Stirrer (2)



Stainless steel Pot heater (3)

- 5) Hook up the kettle onto the hanger of the main unit.
- 6) Now you can plug in the power cord to the popcorn maker.
- 7) Switch on the light and heater (1 & 3), and fill the kettle with 1-Tablespoon of vegetable oil (Fig. 1). Do not use butter inside the kettle. Butter will burn.
- 8) Kettle should be pre-heated for 3 to 4 minutes with oil (until steam comes out from the pot).
- 9) Measure out ½-Cup of plain popcorn kernels. Make sure to use plain popcorn kernels with no seasoning or salt as it will cause the oil to splatter.
- 10) Lift the lid and then pour in the kernels carefully. (Fig. 2) **Caution: Lid will be hot!**
- 11) Switch ON the Stirrer (2) . (Fig. 3)
- 12) Shut the door carefully.
- 13) Popcorn starts popping out through the lid after about 2 to 3 minutes. (Fig. 4)
- 14) Switch OFF the stirrer & heater (2 & 3) when popping is complete (No more popping sounds from the pot). Rotate the roller bar of the pot and pour out all remaining popcorn from pot. **Caution: Kettle will be hot!**
- 15) Keep heater switch (3) OFF if the unit is not being continuously used.
- 16) Serve your popcorn with popcorn scoop provided.
- 17) Remove plug from power supply if the unit is not being used for a long period of time.
- 18) Repeat step 7 to 12 for continuous popping.

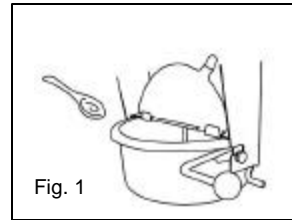

Fig. 1

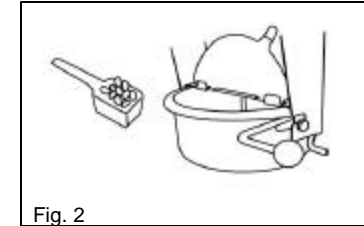

Fig. 2

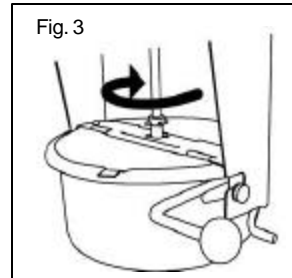

Fig. 3

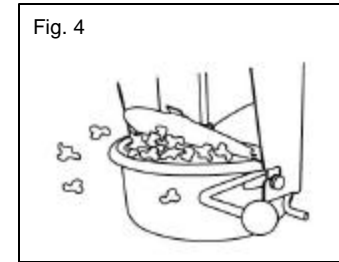

Fig. 4

Cleaning and Maintenance

To avoid burning of excess oils on the bottom of the kettle, it is strongly recommended to clean the kettle after using 3 to 4 times.

After using the popcorn machine, users should use wet towel to clean up the main unit, main body and glasses; rubbish tray is strongly recommended to clean frequently to prevent any bacteria growth.

Quick Cleaning Procedure:

Switch OFF (2 & 3). Pour 1-1/2 to 2 cups of water (NO detergent is necessary) into kettle. Switch ON the stirrer (2) & heater (3) again to boil the water and let the stirrer turn in order to remove excess amount of seasoning or grit stuck on the surface. Pour out the water after about 1 to 2 minutes of boiling. **Caution: Kettle will be hot!** Repeat the same procedure 2 to 3 times for better results.

Standard cleaning procedure:

1. Repeat the above "Quick cleaning procedure" until clean.
2. Switch off the machine and wait for the kettle to cool down. Clean the interior and exterior of the kettle with a brush or damp cloth. (NEVER immerse the kettle into water.)

Free Manuals Download Website

<http://myh66.com>

<http://usermanuals.us>

<http://www.somanuals.com>

<http://www.4manuals.cc>

<http://www.manual-lib.com>

<http://www.404manual.com>

<http://www.luxmanual.com>

<http://aubethermostatmanual.com>

Golf course search by state

<http://golfingnear.com>

Email search by domain

<http://emailbydomain.com>

Auto manuals search

<http://auto.somanuals.com>

TV manuals search

<http://tv.somanuals.com>