

---

**maxon**<sup>®</sup>

*A World of Communications*

---



# SM-2000 SERVICE MANUAL

MAXON AMERICA, Inc.  
10828 N. W. Air World Drive  
Kansas City, MO 64153  
Phone 816-891-6320 Fax 816-891-8815  
680-100-0045 Revision C ECO 98017

December 98



# MAXON SM-2000 MOBILE

## TABLE OF CONTENTS

### TABLE OF CONTENTS

<b>Table Of Contents</b> .....	<b>i</b>
<b>Specifications</b> .....	<b>1</b>
Transceiver Nominal Performance .....	1
General .....	1
Transmitter .....	2
Tx Tone Modulation Characteristics .....	4
Sub Audible Tones - DCS .....	4
Receiver .....	4
Rx Tone Demodulation Characteristics .....	5
Accessories .....	5
Reliability Analysis .....	5
Programmer .....	5
<b>Introduction</b> .....	<b>6</b>
<b>Unpacking Information</b> .....	<b>7</b>
<b>General Description</b> .....	<b>8</b>
<b>Description Of Controls</b> .....	<b>9</b>
<b>Theory Of Operation</b> .....	<b>11</b>
RF Section (SM-2150/VHF) .....	13
RF Section (SM-2450/UHF) .....	17
PLL .....	20
<b>Test Setup</b> .....	<b>21</b>
<b>SM-2150/VHF Alignment Procedure</b> .....	<b>22</b>
<b>Alignment Points Diagram (SM-2150/VHF)</b> .....	<b>26</b>
<b>SM-2450/UHF Alignment Procedure</b> .....	<b>27</b>
<b>Alignment Points Diagram (SM-2450/UHF)</b> .....	<b>31</b>
<b>Component Replacement</b> .....	<b>32</b>
Surface Mount Components .....	32
Surface Mount Removal .....	32
Surface Mount Component Replacement .....	33
Surface Mounted Integrated Circuit Replacement .....	33
<b>Parts List Common to SM-2000</b> .....	<b>34</b>
<b>Electrical Parts List Main Board Digital Section (SM-2000)</b> .....	<b>35</b>
<b>Electrical Parts List Band Chart (SM-2150/VHF)</b> .....	<b>37</b>
<b>Electrical Parts List Main Board (SM-2150/VHF)</b> .....	<b>38</b>
<b>Electrical Parts List Band Chart (SM-2450/UHF)</b> .....	<b>42</b>
<b>Electrical Parts List Main Board (SM-2450/UHF)</b> .....	<b>44</b>
<b>Component Pinout (SM-2000)</b> .....	<b>48</b>
<b>Voltage Charts (SM-2150/VHF)</b> .....	<b>51</b>
<b>Voltage Charts (SM-2450/UHF)</b> .....	<b>54</b>
<b>Trouble Shooting Chart (SM-2000)</b> .....	<b>57</b>

# MAXON SM-2000 MOBILE

## TABLE OF CONTENTS

<b>Schematics and Block Diagrams</b> .....	<b>59</b>
SM-2150/VHF Front End Schematic .....	59
SM-2450/UHF Front End Schematic .....	59
SM-2000 TCXO Schematic .....	59
MA-4472 Microphone Schematic .....	60
SM-2000 Control Head Schematic .....	60
SM-2000 Block Diagram .....	61
SM-2000 Digital Schematic .....	62
SM-2150/VHF RF Schematic .....	63
SM-2450/UHF RF Schematic .....	64
<b>PCB Layouts</b> .....	<b>65</b>
SM-2000 Control Head PCB Layout .....	65
SM-2150/VHF PCB Layout .....	66
SM-2450/UHF PCB Layout .....	67
<b>SM-2000 Exploded View</b> .....	<b>68</b>
SM-2000 Exploded View Parts List .....	69



# MAXON SM-2000 MOBILE SPECIFICATIONS

## SPECIFICATIONS

### TRANSCEIVER NOMINAL PERFORMANCE

- Performance Specifications ..... FTZ 17TR2049 July 88  
TIA/EIA-603  
IEC 68 Series  
EC 529 IP54  
MIL STD 810 C,D,E
- RF Output Power ..... 25 W
- Modulation Type..... G3E/F3E (PM/FM)
- Audio power ..... 4 W
- Intermediate frequencies ..... 45 MHz  
455 kHz
- Number of Channels..... 4
- Frequency Source..... Synthesizer

### GENERAL

- Power Supply..... 13.2 VDC nominal CEPT  
15.6 VDC maximum (extreme)  
10.8 VDC minimum (extreme)  
13.8 VDC nominal TIA/EIA-603
- Temperature Range
- Storage ..... 80°C Maximum; -40°C Minimum  
(Extreme)
- Operating (to spec) ..... 25°C Nominal;  
60°C Maximum; -30°C Minimum  
(Extreme)

### Current Consumption

<b>DC Current</b>	
Standby (Muted)	< 140 mA
Unmuted	
25% Max. AF power	< 350 mA
50% Max. AF power	< 450 mA
100% Max. AF power	< 570 mA
Transmit	
1 Watt RF power	1.6 A
3 Watts RF power	2.4 A
25 Watts RF power	6.7 A

# MAXON SM-2000 MOBILE

## SPECIFICATIONS

Switching range TX and RX (without re-tuning)

BAND	Operational Bandwidth			
	TX		RX	
	MIN	MAX	MIN	MAX
VHF Band 1	136	162	136	162
VHF Band 2	148	174	148	174
UHF Band 1	400	430	400	430
UHF Band 2	420	450	420	450
UHF Band 3	440	470	440	470
UHF Band 4	470	490	470	490
UHF Band 5	490	512	490	512

**Channel spacing** ..... 25 kHz / 20 kHz / 12.5 kHz  
programmable  
(25 kHz - 12.5kHz switchable  
by CPU control)

**Dimensions** (in / mm)..... 2(H) x 7(W) x 6.25(D)  
45(H) x 157(W) x 140(D)

**Weight** ..... 3lbs, 6oz/ 1.6kg (with mic)

### TRANSMITTER

Tests methods are ETS 300 086 Jan  
1991 unless stated

#### Performance Without Sub audible Modulation

**Carrier Power** @ nominal conditions

**Max. Rated Output Power**..... 25 W +/-10% nominal  
25 W +2/-3 dB @ extreme conditions  
across switching range

**Hi Switched by CPU** ..... 1 – 25 W  
Continuously adjustable

**Low Switched by CPU** ..... 1 – 3 W  
Continuously adjustable

**Frequency stability (SM-2150)** ..... ±5.0 ppm (± 0.00025%)

**Frequency stability (SM-2450)** ..... ±2.5 ppm (± 0.00025%)

**Peak audio frequency deviation**  
(across switching range)

# MAXON SM-2000 MOBILE SPECIFICATIONS

Channel Spacing (kHz)	Without sub audible tone modulation	With sub audible tone modulation @ 10% peak deviation
	MAX DEV	
<b>25</b>	<b>± 5.0 kHz</b>	<b>± 5.0 kHz</b>
<b>12.5</b>	<b>± 2.5 kHz</b>	<b>± 2.5 kHz</b>

**Audio characteristic** ..... (Method as FTZ 17 TR 2049 July 1988)

**MOD Type G3** ..... Within +1/-3 dB of 6 dB/octave  
pre-emphasis curve:  
300 Hz – 2.55 kHz for 12.5 kHz  
Channel Spacing  
300 Hz – 3 kHz for 20 , 25 kHz  
Channel Spacing

**MOD Type F3** ..... Within +1/-3 dB of 6 dB/octave  
pre-emphasis curve:  
300 Hz – 2.55 kHz for 12.5 kHz  
Channel Spacing  
300 Hz – 3 kHz for 20 , 25 kHz  
Channel Spacing

**Adjacent channel power**

25 kHz < 70 dBc  
12.5 kHz < 60 dBc

**TX spurious emissions (conducted)**

9 kHz – 1 GHz < -36 dBm  
1 – 4.0 GHz < -30 dBm

**TX spurious emissions (radiated)**

9 kHz – 1 GHz < -36 dBm  
1 – 4.0 GHz < -30 dBm

**TX spurious emissions (radiated)**

9 kHz – 1 GHz < -36 dBm  
1 – 4.0 GHz < -30 dBm

**Modulation limiting characteristics** ..... Method as FTZ17 TR2049 July 1988  
=75% peak deviation

**Transmitter audio distortion (without CTCSS)** ..... Method as FTZ17 TR 2049 July 1988  
1 kHz modulation input < 5 %

**Transmitter audio distortion (with CTCSS)** ..... Method as EIA RS 220A Mar 79

Audio frequency 1 kHz < 8 %  
Any CTCSS frequency combined

**Hum & noise (residual modulation)** ..... > 40 dB

# MAXON SM-2000 MOBILE

## SPECIFICATIONS

### TX TONE MODULATION CHARACTERISTICS

#### Sub audible tones - CTCSS

Tone range.....	67 – 250 Hz @ 0.3 % accuracy
Tone standard .....	RS-220A EIA Standard
Non-standard tones.....	50 – 260 Hz @ 0.3 % accuracy
Nominal tone deviation.....	10 % peak system deviation

### SUB AUDIBLE TONES - DCS

Tone standard .....	Normal and inverted
Nominal tone deviation.....	10 % peak system deviation

### RECEIVER

Performance without sub audible modulation..... Method ETS 300-086 JAN 1991  
unless stated

Sensitivity 12 dB SINAD .....

< - 118 dBm
-------------

Amplitude characteristic .....

± 3 dB
--------

#### Co-channel rejection

25 kHz	< - 6 dB
12.5 kHz	< - 10 dB

#### Adjacent channel selectivity

25 kHz	> 70 dB @ nominal conditions
12.5 kHz	> 60 dB @ nominal conditions

Spurious response rejection .....

> 70 dB (100 kHz - 4 GHz)
---------------------------

#### Intermodulation response rejection

± (25 kHz & 50 kHz)	> 65 dB (3 generator method)
± (50 kHz & 100 kHz)	

#### Blocking

± 1 MHz	> 85 dB
± 5 MHz	> 85 dB
± 10 MHz	> 85 dB

#### RX spurious emissions (conducted)

9 kHz – 1 GHz	- 57 dBm
1 GHz – 4.0 GHz	- 47 dBm

#### RX spurious emissions (radiated)

9 kHz – 1 GHz	-57 dBm
1 – 4.0 GHz	-47 dBm



# MAXON SM-2000 MOBILE SPECIFICATIONS

AF power .....	5 W maximum @10% Distortion into a 4 ohm load. 4 Watts nominal.
AF frequency response .....	Method as FTZ 17 TR 2049 July 1988
MOD Type G3 .....	Within +1/-3 dB of 6 dB/octave de-emphasis curve 300 Hz – 2.55 kHz for 12.5 kHz Channel Spacing 300 Hz – 3 kHz for 25 kHz Channel Spacing
MOD Type F3 .....	Within +1/-3 dB of 6 dB/octave de-emphasis curve 300 Hz – 2.55 kHz for 12.5 kHz Channel Spacing 300 Hz – 3 kHz for 25 kHz Channel Spacing
RX Hum & Noise .....	> 40 dB

## RX TONE DEMODULATION CHARACTERISTICS

### Subaudible tones - CTCSS/DCS

CTCSS tone range .....	67 Hz to 250 Hz
CTCSS tone standard .....	RS-220A EIA Standard
CTCSS non-standard tones .....	50 – 260 Hz
DCS tone standard .....	Standard and inverted
Decode Sensitivity .....	Method: Decrease signal level @ 10% peak deviation
All tone .....	<= 9 dB SINAD
Environmental .....	IEC529 level IP54 MIL STD 810C
EMC .....	EMC Directive 89/336/EEC May 1989 ETS 300.279

## ACCESSORIES

MA4472 Microphone

## RELIABILITY ANALYSIS

	Calculation method
MTBF .....	15,000 Hr. MIL-HDBK-217F. Ground benign. Parts stress method.
MTTR .....	30 Min. (Average time to rework any SMD component & reassemble).

## PROGRAMMER

..... SMP4004C

# MAXON SM-2000 MOBILE

## INTRODUCTION

### INTRODUCTION

Advanced state-of-the-art technology is used in the design and manufacturing of the SM-2000 Mobile. The Phase Lock Loop (PLL) synthesizer provides more flexibility and capability in the SM-2000 Mobile. This scanning mobile has 4 channel capability. It offers CTCSS, DCS, scanning, priority channel, and many other functions. All these functions are controlled by the micro controller. The micro controller reads specific channel information from an Electronically Erasable Programmable Read Only Memory (EEPROM).

# MAXON SM-2000 MOBILE

## UNPACKING INFORMATION

### UNPACKING INFORMATION

*Check the carton carefully for the following items:*

- 1 Transceiver Unit
- 2 Microphone
- 3 DC Power Cord
- 4 Mobile Mounting Bracket
- 5 Assembly Hardware
- 6 Operating Guide

# MAXON SM-2000 MOBILE

## GENERAL DESCRIPTION

### GENERAL DESCRIPTION

The Maxon SM-2000 is a rugged two way FM mobile radio which operates from 136-174 MHz (VHF) in two bands & 400-512 MHz (UHF) in five bands. The SM-2000 is a synthesized radio utilizing microcomputer technology to provide reliable high quality simplex two-way mobile communications. The SM-2000 transmitter output power level is 25 watts over a wide bandwidth, with a receiver operational bandwidth that covers the specified frequency band. The basic radio package includes the following features:

- *Microprocessor Control*
- *Synthesized RF Channel Selection (Frequency Control)*
- *CTCSS Encode / Decode*
- *DCS Encode / Decode*
- *Priority Channel Scan*
- *5 PPM Frequency Stability (SM-2150/VHF)*
- *2.5 PPM Frequency Stability (SM-2450/UHF)*
- *Field Programmable with PC*
- *Internal 4 watt speaker, with Volume Control*
- *Busy Channel Lockout*

The small size of the SM-2000 radio makes it ideal for front mounting in conventional vehicles. The radio is operated with a simple hand held microphone in combination with the operating controls described in the following section.

# MAXON SM-2000 MOBILE

## DESCRIPTION OF CONTROLS

### DESCRIPTION OF CONTROLS

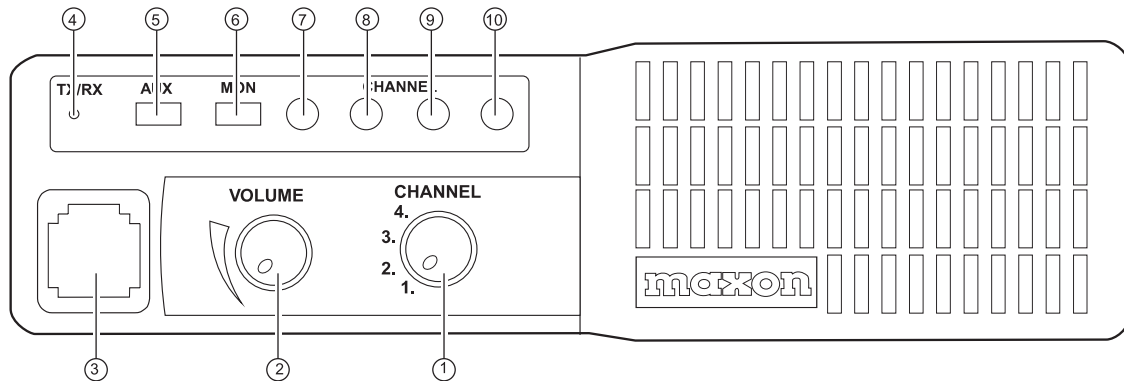

**Figure 1 SM-2000 Front Panel**

### DESCRIPTION OF CONTROLS

The controls, indicators and microphone/programming connector are located on the front panel. The Monitor and Auxiliary buttons are located on the radio's front panel. The following table details the Mobile controls, indicators, and connections.

**TABLE 2**

Controls, Indicators, And Connections	
ITEM	FUNCTION
1. Channel Select Switch	Rotary switch, used to select one of 4 channels (max.) and to engage scanning function
2. ON/OFF Volume Control	Main power switch and volume control. Fully counter clockwise is off position
3. Microphone Connect Jack	Used to connect the microphone to the mobile
4. Busy/Call/TX	Tri-colored LED indicator
5. Auxiliary (AUX) Switch	Used for control of after market accessories
6. Monitor Switch	When pushed, monitors the chosen channel
7-10. Channel Indicator LED's	Indicates the channel when illuminated

# MAXON SM-2000 MOBILE

## DESCRIPTION OF CONTROLS

Rear Panel Connections	
ITEM	FUNCTION
1. Antenna Connector ( S0-239 )	50 ohm connector
2. DC Power Connector	Used to connect the mobile to the power supply 13.2 VDC or 13.8 VDC U.S.A.
3. External Speaker Connector	Multipurpose socket used to connect to a remote speaker or for test connection

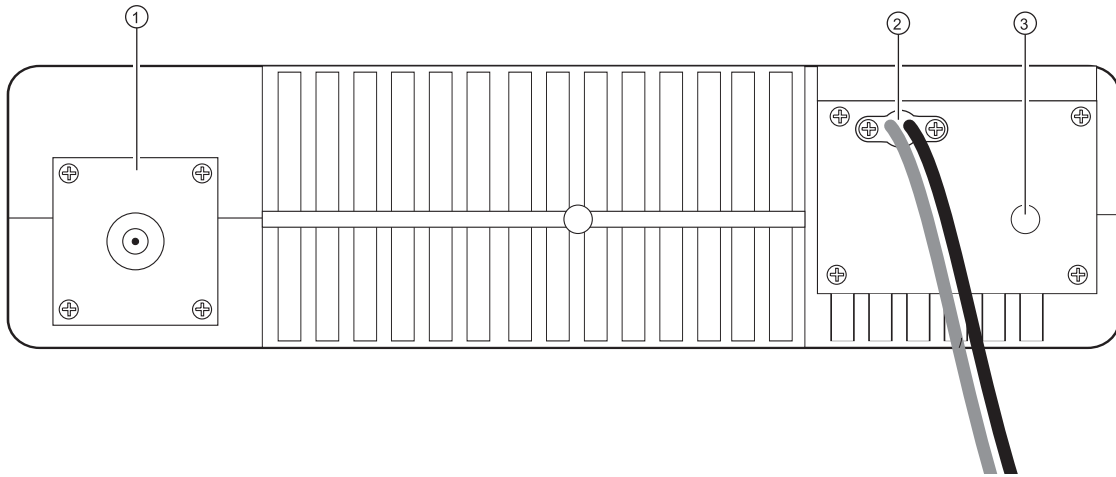

Figure 2 SM-2000 Rear Panel

# MAXON SM-2000 MOBILE

## THEORY OF OPERATION

### THEORY OF OPERATION

Each of the Scanning Mobile radios, UHF & VHF, include a unique main P.C.B. consisting of RF, Digital and Analog circuitry.

#### DIGITAL CIRCUITRY

IC 411 and IC412 are digitally-controlled analog switches which internally consist of three single pole, double throw switches. By placing a high (5V) or low (0V) on the control lines which consists of A,B, and C. "A" controls the X ports "B" controls the Y ports and "C" controls the Z ports. Example: A high on control "A" would connect X to X1. A low on control "A" would connect X to X0.

#### CTCSS/DCS Decode Circuits

Discriminator audio from Pin 9 of IC 109 is fed to IC 406 and associated parts, which are the first 2 poles of a 6th order 250Hz Chebyshev low pass filter. The output from Pin 1 (IC406A) is fed into IC411 (Pin 2) and output to Pin 15 (IC411). The signal is then fed to Pin 8 (IC407) which is a 6th order low pass Butterworth switched capacitor filter. The output from the Butterworth filter (Pin 3 IC407) is then fed to the remaining 4 poles of the 6th order Chebyshev, which consist of IC 406C and one of the two operational amplifiers internal to IC407 (MF6-100) along with associated components. Both the Chebyshev and the Butterworth combines for a 4dB ripple low pass filter when programmed for 250Hz. The output of IC406C(Pin 8) is fed into the remaining operational amplifier internal to IC407 (MF6-100) which forms the squaring circuit for the Decode signal. The signal is output from Pin 2 IC407 (MF6-100) and fed into IC409 (micro) where it is matched with a preprogrammed frequency. If successful a Decode occurs, which is shown by a green L.E.D. on the front panel of the UHF Scanning Mobile and audio is heard. If valid Decode was not seen, the busy L.E.D. (Yellow) would be shown.

#### CTCSS/DCS Encoder Circuit

During TX encode the tone squelch digital signal is produced as a 3-bit parallel word at Pins 15 (A), 16 (B), and 18C of the micro controller (IC409). The 3-bit digital signal is converted to an analog signal by resistors R427, 428, and 430. The analog signal is fed into IC411 Pin 1. The signal is output on Pin 15 (IC411) and fed into Pin 8 of IC407 (6th order Butterworth clock tuned low pass filter). The filtered encode output from Pin 3 (IC407) is fed into Pin 13 (IC411) and output on Pin 14 (IC411).

The filtered encode signal is fed to IC405B and RV403 (sub-audible gain control), the output of IC405B is then fed to the audio mixer circuit.

#### Channel Select Circuit

One of 4 channels may be selected using the channel switch on the front panel. The channel switch SP4T (single pole 4 throw) with output to 4 channel LED's and to diode's to be converted to an inverted 4-Bit binary code. The binary code inverted is equal to the channel number. The binary code is decoded by the micro controller enabling the appropriate RX or TX frequency and associated data to be selected from the EEPROM.

- **NOTE:**It is possible any one of the 4 channel locations can be a scanning position. Refer to Operators Manual for further instructions.

# MAXON SM-2000 MOBILE

## THEORY OF OPERATION

### EEPROM

RX/TX channels, CTCSS/DCS as well as other data from the programmer are stored in the EEPROM. The data stored is retained without power supplied. This is a non-volatile memory. The EEPROM may have information re-programmed or erased. IC408 is an EEPROM with 2048 (256x 8) bit capacity and data is written and read serially, with the Programming cable through the front panel microphone connector.

### High Pass Filter

The high pass filter is an 8-pole .1dB chebyshev active filter that comprises IC410 and associated components. The de-emphasis is provided by resistor R451 and capacitor C452. Receive audio is passed to IC410 by Pin 4 of IC411 where sub-audible tones below 250Hz are removed. Mic audio is also fed into IC410 via IC411 (Pin 4) where sub-audible voice products below 250Hz are also removed.

### Mute (Squelch) Circuit

The mute circuit which is controlled by the output of IC409 (micro) pin 77 (386) is connected to Q409 via R438 which opens analog gate IC401D and mutes the audio path to the AF amplifier, in conjunction with Q137 shorting the input to audio amp IC108.

### TX Audio and Filter Circuits

Microphone audio from front panel (via IC412), is fed into IC401A, and into IC404B (Pin 6). The TX audio is output on Pin 7 (IC404B) and into the high pass filter (IC410), where sub-audible voice products are removed. The TX audio output from IC410 is fed into IC404A&B which with associated parts form a pre-emphasis mic amplifier and limiter. The output from Pin 1 IC404A is fed to RV402 (TX Modulation Level Adjust) and fed into IC404C&D with associated parts to form a 3kHz low pass filter. The output of IC404D (Pin 14) is then fed into the Audio Mixer Circuit.

### Audio Mixer and Inverter

IC405A is an audio mixer where audio and sub-audible tones are combined. RV403 is used as a level control for the Sub-audible tones. This level is summed with amplified, pre-emphasized, and limited audio and feed to IC405A, which is an inverting amplifier. The output is fed to the VCO and TCXO to provide the necessary modulation signal.

### Analog Ground Supply

IC406D supplies analog ground (2.0V) to all operational amplifier circuits except for IC405A and IC405D.



# MAXON SM-2000 MOBILE

## THEORY OF OPERATION

### PLL

IC101 (MC1459IF) is a PLL frequency synthesizer with an on-board 1.1 GHZ divide by 64/65 dual modulus prescaler. In addition to the prescaler and frequency counters, the synthesizer IC has a phase detector and a C register (Configuration register) that allows certain functions to be configured as desired.

The synthesizer is serially controlled by three wire input to the IC. Serial data is fed to pin 19 of the IC. Serial data CLK (pin 18) and active low ENABLE (pin 17) are the input pins that allow data transfer into the integrated circuit for control and frequency selection.

Data transfer is byte-oriented and may be shifted in 1, 2 or 3-byte patterns. One byte (8 bits) accesses the C or configuration register, two bytes (16 bits) access the R register and 3 bytes (24 bits) access the A register.

Internally the synthesizer has three counters used as frequency dividers. These counters are the R,A and N counters. The R counter is actually controlled by 3 bits of the R register while the remaining 13 bits determine the divide by R value. The frequency at pin 20 (12.8 MHz) is divided by R to determine the frequency steps of the PLL synthesizer. In programming the radio, 5.0 kHz or 6.250 kHz step sizes can be selected for any channel.

The 24-bit A register controls the N and A (prescaler) counts. Together these counts determine the total synthesizer divide ratio affecting the  $f_{in}$  (frequency input) signal from the VCO. A0-A7 are the A counter values. A8-A19 are the N counter values. A21 and A20 must always be set high. A23 and A22 are both set to 0 which controls the function of output A and causes it to be a port. This port, output A, is used to set TX power high or low. A high output on port A sets transmit power low.

The 8-bit C register performs control functions as stated:

- C7 sets polarity of the phase detector bits. Logic "0" is normal.
- C6 determines the phase detector used. A logic "0" selects theta V and theta R outputs
- C5 enables the lock detector when its logic is "1".
- C4 when a logic "1", puts CMOS sections in standby mode.
- C3 and C2 set phase detector current at the PD output. Not used in this application.
- C1 is the value present at Output A.
- C0 is the value present at Output B.

Transistors Q101 through Q104, along with related resistors and capacitors, connect the dual pin theta V and Theta R outputs into a 2 mA current source that is powered by a 20V DC to DC converter. This allows the tuning voltage to be approximately 3 to 17 VDC.

# MAXON SM-2000 MOBILE

## THEORY OF OPERATION

### RF SECTION (SM-2150/VHF)

#### **VHF Transmitter**

The Transmitter is comprised of:

1. Microphone Audio Circuit
2. Transmitter Stage and Harmonic Filter
3. Automatic Power Control
4. Frequency Synthesizer Circuit

#### **Microphone Audio Circuit**

Microphone audio from the digital circuitry is amplified, pre-emphasized, limited, and mixed with Sub-Audible and applied to the VCO at Pin 1, through RV101, to balance VCO and TCXO modulation.

#### **Transmitter Stage and Harmonic Filter**

When in the transmit mode of operation the diode D103 is forward biased enabling the RF signal to pass to the pre-driver Q118 by Q116 and Q117. The amplified RF signal is amplified again by Q120. The amplified RF signal passes through the stripline coupler and is fed to the harmonic low pass filter, comprising of L128, L130, L131, and L132, capacitor 271, 273, 275, 277, and 283 and then to the antenna connector (ANT). The stripline coupler provides a sample of the RF signal for the automatic power control. During transmit D107 is forward biased which connects the power amp, D120, to the antenna. D120 is forward biased inhibiting transmit signal power from being fed to the receiver circuitry.

#### **Automatic Power Control**

The automatic power control contains the stripline coupler, diode D107 and variable resistor VR104, IC104A, and three transistors Q123, Q124, and Q125. IC104A forms a differential amplifier. The RF signal present in the coupler is rectified by D107, to produce a DC voltage proportional to RF power which is applied to Pin 3 of IC104A. TX 8.5V is also applied to the input of IC104A via the potential divider R168, VR104, and R170 at pin 2. The different signal at output of IC104A is passed to Q124 and Q125 to produce a constant power output to the antenna connector (ANT). VR104 is used to adjust the RF high power level. VR105 is used to set the low power setting.

#### **RX & TX Voltage Controlled Oscillator Circuit**

The circuit contains two VCO's. One for producing carrier frequencies during transmit and one for producing the local oscillator frequency during receive. The circuit also has RX and TX power line filters.

#### **RX & TX Power Line Filters**

Transistors Q353 and Q354 are configured as TX5v and RX5v power supply ripple filters respectively.

# MAXON SM-2000 MOBILE

## THEORY OF OPERATION

### RX VCO

The RX VCO comprises JFET Q351, coil L356 and varactor D353 and is configured as a Colpits oscillator. D353 produces a change in frequency with a change in DC voltage and is controlled by the phase detector signal present at the anode. The local oscillator signal at the drain of Q351 is applied to RF out of the module when diode D103 is reverse biased and D104 is forward biased. L356 is used for PLL alignment.

### TX VCO

The TX VCO comprises JFET Q352 coil L353 and varactor D352 and is configured as a colpits oscillator. The AF signal at MOD port is applied to the cathode of D352. The control voltage from the loop filter is applied to the drain of Q352 and is passed to the power amplifier and harmonic filter via the buffer Q113 and Q114. When diode D103 is forward biased and D104 is reversed biased L353 is used for PLL alignment.

### Loop Filter

Transistor Q101 to Q104 and associated components form a loop filter. The phase detector from Pin3 and 4 of IC101 are filtered to remove any reference frequency harmonics and applied to the voltage controlled oscillator.

### PLL Frequency Synthesizer

The PLL frequency synthesizer (IC101) contains an oscillator for the reference divider, a programmable divider, a phase/frequency Comparator and an out of lock detector and a Prescaler.

### Reference Oscillator

The reference oscillator of IC01 along with a 10.25 or 12.8MHz TCXO, varactor diode D701 and D702, and the thermistors TH701, TH702, and TH703 produce a temperature compensated 10.25 or 12.8MHz reference.

### Programmable Dividers

The serial frequency data (DATA) is received by the data programmable divider at Pin 19 of IC101 from Pin 1 of IC409 (Micro controller) out. The internal Prescaler divided input frequency at pin 11 of IC1 is further divided by the programmable divider. The 10.25 or 12.8MHz TCXO frequency at pin 20 is the reference divider to produce a reference frequency of 5 or 6.25kHz respectively. The internal programmable divided frequency (Fv) and the reference frequency (Fr) are fed to the internal phase detector.

### Phase Detector

The phase detector produces negative pulses when  $F_v < F_r$ , positive pulses when  $F_v > F_r$ . When  $F_v = F_r$  and phase is the same, the phase detector presents a high impedance at Pin 4. The signal at Pin 2 is applied to the VCO via the loop filter.

# MAXON SM-2000 MOBILE

## THEORY OF OPERATION

### Out of Lock Detector

The out-of-lock detector produces a high logic level when Fr and Fv are in the same phase and frequency, low logic level pulses when the loop is out-of-lock at Pin 2 of IC101. The signals at Pin 2 of IC101 are buffered by Q106 and then integrating by R114 and C122. The product of the integrating circuit is fed to L/D port.

### Prescaler

The internal Prescaler of IC101 divides the incoming signal frequency from the VCO via input pin 1 by 64 or 65. The divided VCO frequency is passed to the 6-stage A counter and 12-stage N counter.

### Receiver

The receiver uses Dual Conversion Superheterodyning techniques, it is comprised of:

1. RF amplifier
2. First Mixer and First IF Amplifier
3. Second Mixer, Second IF Amplifier and FM Detector
4. Receiver Audio Circuit
5. Mute (squelch) Circuit

### RF Amplifier

The signal received via the antenna is routed through the 9th chebyshev low-pass filters containing capacitors C273, C275, C277, C280, C283 and coils L128, L130, L131, L132, and is passed through the front-end module (RF amplifier) via pin 1. The front-end module contains L800 to L806 and Q800. The front-end module is configured to enable the RF signal at the operating frequency to pass the first mixer.

### First Mixer and First IF Amplifier

The VCO local oscillator signal routed through buffer transistor Q113 and Q114 is filtered by C164, C165, C281, C310, and L110, L123. IC102 produces a difference frequency IF of 45MHz from pin 6 of the front-end module and the filtered VCO local oscillator signal at pin 1. The 45MHz difference frequency is filtered by the 2-pole crystal filter CF101. The tuned circuit T101 and T102 and associated components provide matching of the crystal filter to insure good band-pass response and selectivity. The IF signal is amplified by Q130 and passed to the second mixer, second IF and FM detector IC109.

### Second Mixer, Second IF and FM Detector

A signal conversion FM receiver integrated chip, IC109 contains the second mixer, second IF and FM detector functions. The second local oscillator frequency is determined by the crystal X101 connected to pin 1 of IC109. The IF signal is received at pin 16 of IC109 via R203 and coupling capacitor C182. The second IF frequency of 455kHz is produced when the different frequency is applied to the mixer via Pin 6. The output of the second mixer via Pin 3 is applied to a 455kHz band-pass filter, CF104 for 25kHz and CF103 for 12.5kHz channel spacing. The output of CF104 is passed to a high gain IF amplifier (limiter) in IC109 via Pin 5. The amplified signal is coupled to the adjustable quadrature detector T103. Any detected signal is produced at Pin 9 of IC109 and applied to the Receiver Audio Circuit and the Mute (Squelch) Circuit.

# MAXON SM-2000 MOBILE

## THEORY OF OPERATION

### Receiver Audio Circuit

The receiver audio circuit is comprised of a low pass filter and an audio amplifier on the RF PCB.

### Low Pass Filter

The low pass filter is configured from coil L227, capacitor C201 and resistor R206. AF signals from Pin 9 of IC109 are filtered by the low pass filter to remove any components of the 455kHz IF signal. The filtered signal is passed to the high pass filter.

### High Pass Filter

The de-emphasized audio signal from the high pass filter is fed to the audio amplifier (IC108).

### Audio Amplifier

IC108 is the audio amplifier. The audio signal is passed to IC108. The gain of the amplifier is set by resistor R153. The amplified audio signal at Pin 4 of IC108 is applied to the external speaker.

### Mute (Squelch) Circuit

The squelch circuit switches off the audio power amplifier in the absence of audio signal. The squelch circuit comprises a 50kHz pass band filter, squelch control (RV103) and a noise detect circuit.

The audio signal from Pin 9 of IC 109 is filtered by the 50kHz bandpass filter formed by L228, L229, C191, C192, and C193. The noise in the IF pass band is accepted, frequencies in the voice frequency band are rejected and noise present at the output of the filter is applied to the noise detect circuit via RV103. RV103 is used to adjust the squelch sensitivity.

### Noise Detect Circuit (SQ Board)

The noise detect circuit in conjunction with IC109 consists of transistor Q133 and Q132, thermistor TH101 and diode D125. Any noise signal present is applied to the base of Q133 of the SQ circuit from Pin 11 of IC109. The signal is amplified by Q133 rectified by D11 and then buffered by Q132. The buffered signal output is applied to the squelch trigger of IC109 Pin 12 via resistor R200. The squelch trigger output (Pin 13 of IC109) is applied to the Micro controller on the Digital circuit. When noise is present, the voltage at Pin 12 of IC109 exceeds 0.7V, the squelch trigger output is 0V (logic0) muting the receiver audio circuit. When no noise is present the voltage at Pin 12 of IC109 is less than 0.7 and Pin 13 of IC109 is at 5V (logic1), unmuting the audio circuit.

# MAXON SM-2000 MOBILE

## THEORY OF OPERATION

### RF SECTION (SM-2450/UHF)

#### **UHF Transmitter**

The Transmitter is comprised of:

1. Microphone Audio Circuit
2. Transmitter Stage and Harmonic Filter
3. Automatic Power Control
4. Frequency Synthesizer Circuit

#### **Microphone Audio Circuit**

Microphone audio is pre-emphasized, limited and mixed with sub-audible tones to provide the modulating signal for the transmitter. This combined modulation is applied to TCXO modulation pin 1 and also to the VCO modulation input via RV101 to effect 2-point modulation. RV101 is a modulation balance control that equalizes modulation sensitivities of the two oscillators.

#### **Transmitter Stage and Harmonic Filter**

Power Amplifier IC103 is an RF Module. In transmit, diode D103 is forward biased allowing the RF signal to pass to the input of IC103 via Q116 and Q117. The amplified RF output passes through the stripline coupler and is fed to the harmonic low pass filter, consisting of spring coils L118, L120, L121 and L125 and capacitors C271, 273, 275, 277 and 280, and then to the antenna connector. The stripline coupler provides a sample of the RF signal for automatic power control. During TX, D108 connects the power amp to the antenna. D120 and D121 are forward biased reducing transmit signal power at the receiver input.

#### **Automatic Power Control**

The automatic power control contains the stripline coupler, diode D107, and variable resistor RV104, op amp IC104, and two transistors: Q124 and Q125. IC104 acts as a differential amplifier. The RF signal is rectified by D107 to produce a DC voltage, proportional to RF power, that is applied to IC104 pin 3. Voltage divider R168, RV104 and R170 monitors TX 8.5V dc to develop a reference for IC104A pin 2. The difference at the output of (IC104 pin 1) is passed to Q124 and drives the collector of Q125. This feedback controls the gain of IC103 to maintain a constant RF power output. RV104 is used to adjust the RF high power level. RV105 is used to set the low power setting.

#### **Frequency Synthesizer Circuit**

With data received from the EEPROM ( IC408 ) the frequency synthesizer circuit controls and produces the RF carrier frequency for the transmitter during transmit and the local oscillator frequency for the receiver.

The frequency synthesizer circuit is comprised of:

1. RX and TX voltage controlled oscillator module.
2. Loop Filter
3. PLL Frequency Synthesizer

# MAXON SM-2000 MOBILE

## THEORY OF OPERATION

### Voltage Controlled Oscillator Circuit

The circuit produces carrier frequencies during transmit and local oscillator frequencies during receive. Transistor Q107 is configured as a power supply ripple filter. The VCO utilizes transistor Q108, varactor D101, D102 and trimmer capacitor TC101. These components are configured as a Colpitts oscillator. D101 and D102 produce a change in frequency with a change in DC voltage and are controlled by the phase detector. Q110 and Q111 are an amplifier and buffer for the output of the oscillator.

### Receiver

The receive signal passes through the low pass filter, then onward to pin 1 of the Front End module. A bandpass filter consisting of C801-C810 (see band chart for different band values) and L801-L803 is coupled to the base of Q801 (2SC5084) which is the RF amplifier. Diode D801 serves as protection from static and RF overload from nearby transmitters. The output of Q801 is coupled to a second bandpass filter consisting of C812-C824 and L804-L807. The output of the Front End (pin 6) is coupled to the double balanced mixer IC102. The receiver Front End Module is factory pre-tuned and requires no field adjustment. Repair is effected by replacement of the entire (properly banded) module. Frequency bands are listed in the SPECIFICATIONS section of this manual.

The receiver Front End module pin-outs are:

1. RF Input
2. Input Ground
3. Ground
4. Receive +5VDC
5. Output Ground
6. RF Output

### First Mixer

IC102 is a Double Balanced Mixer which provides a 45MHz intermediate frequency output. The filtered frequency from the Front End is coupled to signal input pin3 of the mixer. The Local Oscillator from the VCO module runs 45MHz lower than the receive frequency and is coupled to IC102 at pin6. The resultant IF output exits at mixer pin2. The 45MHz IF output is matched to the input of the 4 pole monolithic crystal filter by C179, L119, C172 and C173. The crystal filter provides a bandwidth of + and - 7.5kHz from the operating frequency for the signal providing a high degree of spurious and intermodulation protection. Additionally, a 90MHz trap is placed at the filter input to provide additional attenuation of the second order IMD (Intermodulation Distortion). The output of the filter is impedance matched by T101, C175, and C176 to the base of the post filter IF amplifier Q130 (MMBC1321).

### Second Oscillator- Mixer- Limiter and FM Detector

The output of IF amplifier Q130 is coupled through C182 to the input of IC109 (Pin16), an MC3371 device. IC109 is a monolithic single-conversion FM receiver containing a mixer, the second local oscillator, limiter and quadrature detector. The second local oscillator is crystal-controlled by X101 and operates at 44.545 Mhz. Mixing the second L.O. with the 45.0 Mhz IF input signal provides a resultant 455 kHz signal at the second mixer output. The mixer output is then routed to CF103 (455HT) for channel spacing of 12.5 kHz or to CF104 (455F) for channel spacing of 20 or 25kHz. These ceramic filters provide adjacent channel selectivity for the desired bandwidths. Selection of CF103 or CF104 is software controlled and programmable on a channel to channel basis.

Filter selection is performed by Q135, D126 and D126. The selected filter output drives a high gain limiting amplifier that is internally coupled to the quadrature detector. Referring to the RF schematic, with Channel Spacing low, Q135 is off and CF104 is the selected filter.

# MAXON SM-2000 MOBILE

## THEORY OF OPERATION

The quadrature detector is also configurable for narrow or wide channel spacing by software control of Q219 and diode D127. These components with R219 parallel R211 to maintain audio output at the proper level for the selected bandwidth.

Q134 inserts wideband squelch adjustment RV102 into the circuit whenever standard filter CF104 is selected. This tends to broaden the filter response and provide the higher frequency noise components needed to activate the squelch.

### Squelch (Mute) Circuit

The squelch output is sent to microcontroller pin 7 after processing by the squelch circuits. The squelch circuit consists of a double-tuned BPF (Band Pass Filter) and also a noise detector circuit. Details of these circuits are discussed next.

### Squelch Noise Band Pass Filter

The output signal from pin 9 of IC109 (MC3371) is filtered to remove the 455 kHz IF variations. The remaining audio is then filtered by a double-tuned BPF consisting of resonator L228-C191, resonator L229-C193 and coupling capacitor C192. The noise in the IF passband is accepted and voice frequencies are rejected. Any noise present at the filter output is applied to the noise detector via RV103. RV103 is used to set the squelch circuit sensitivity and is normally adjusted to produce a noise squelch opening sensitivity of 10dB to 12dB SINAD.

### Noise Detector

The noise detector operating in conjunction with IC109 consists of Q132, Q133, D125, D129, TH101 and their associated biasing components. Noise from RV103 is amplified by an op amp within IC109. This noise spectrum is further amplified by Q133 and rectified by D125. This output is buffered by Q132 and fed to the SQ IN (IC109 pin 12) through R200. When the mute is activated, (IC109 pin9) goes low to pull the base of inverter Q131 low. Q131 collector goes high thereby signalling the microprocessor to mute the receiver audio.

### Low Pass Filter

The audio output of (IC109 pin9) is fed to a LPF (Low Pass Filter) consisting of R206 and C201. This RC attenuates 455 kHz IF energy which normally appears at the output of the FM receiver chip. The audio is then routed to the input of IC406A LPF for audio processing.

### Speaker Audio Amplifier

After signal detection and audio filtering, the low level audio is returned to pin 1 of IC108, the Audio PA. IC108, a TDA2003 device, provides sufficient power gain to drive the mobile speaker. Digital transistor Q137 mutes the audio amplifier by grounding R157 when the transistor turns on. When Q137 base is high, the transistor is on and the mobile is muted. Conversely when Q137 is off, the mute is released and audio is heard.



# MAXON SM-2000 MOBILE TEST SETUP

## TEST SETUP

### TRANSMIT TESTS

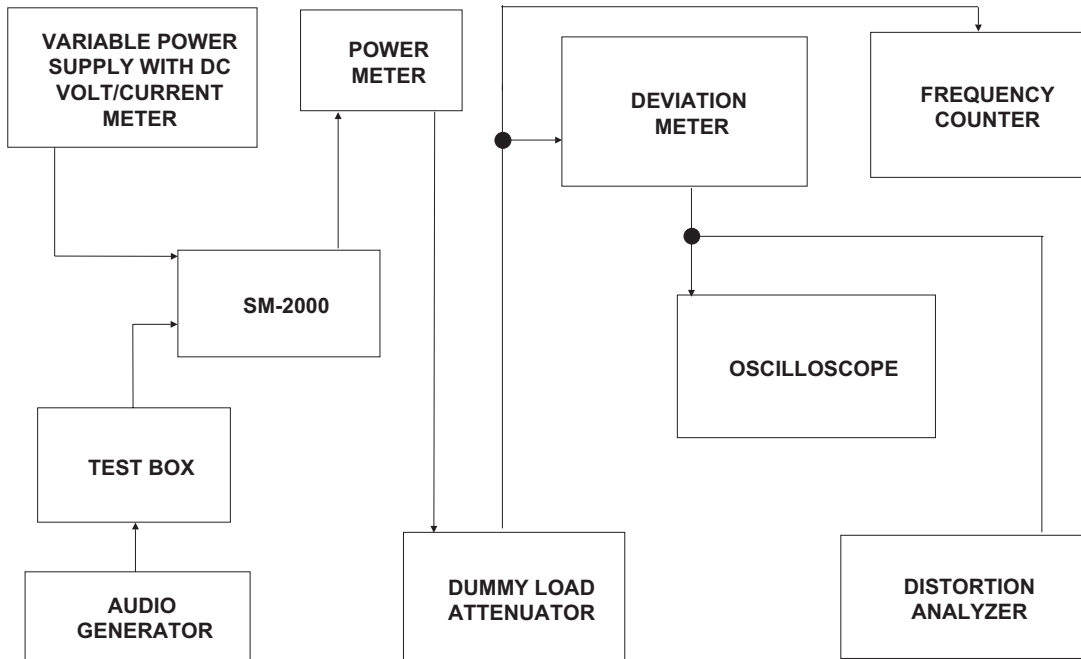

### RECEIVER TESTS

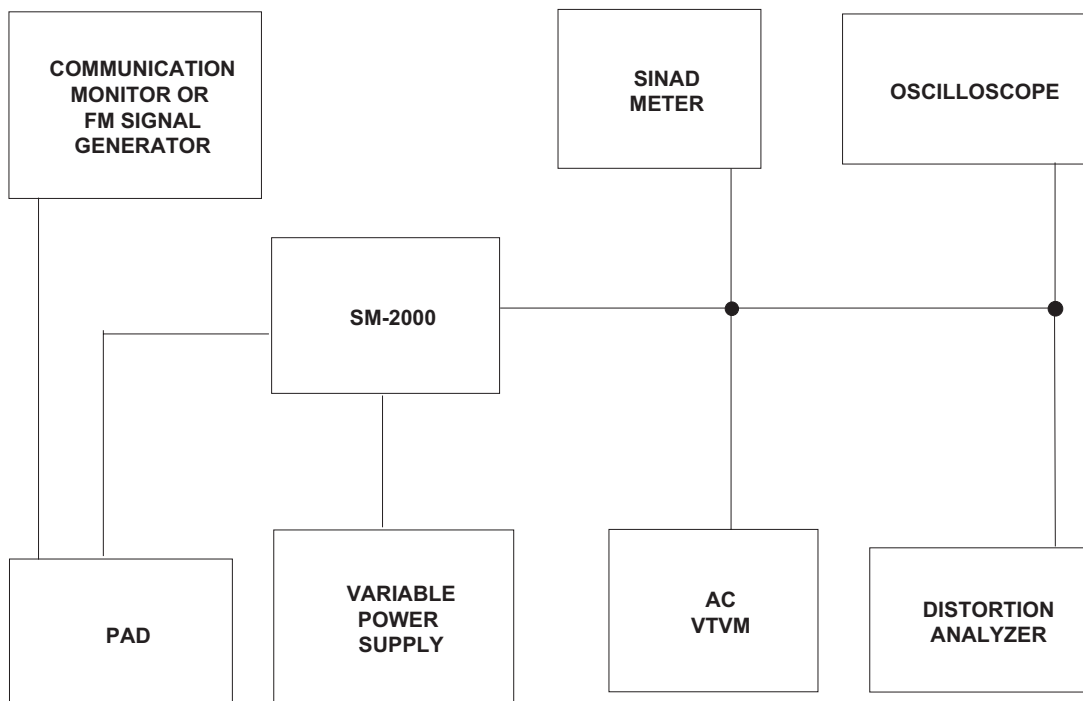

# MAXON SM-2000 MOBILE

## SM-2150/VHF ALIGNMENT PROCEDURE

### SM-2150/VHF ALIGNMENT PROCEDURE

It is important that the TCXO be on the correct frequency before performing a complete alignment of the radio. An incorrect TCXO frequency can impair the performance and even cause mis-alignments.

Normally the transmitter is monitored with a frequency counter or service monitor while the transmitter is keyed at it's highest frequency. The TCXO is adjusted for the least frequency error. Typically the frequency is 470MHz with a frequency error of +/-750Hz or less. TC701 adjusts the center frequency if necessary.

#### PLL Alignment

- **NOTE: If the PLL is out- of- lock, an audible warning will be heard and the front panel red LED will flash.**
- 1. Connect an RF power meter to the ANT socket.
- 2. Using the channel switch, select channel with the lowest transmit frequency.
- 3. Connect a DC voltmeter to test point 1 (TP1) accessed via the hole in the VCO cover.
- 4. Set the PTT switch to transmit.
- **Note: The transmitter switching band width of this radio is 25MHz. A transmitter frequency range of more than 26MHz may be programmed and used if the voltage specification in step 5 is met.**
- 5. Adjusting L353, set the voltage measured at TP1, measure and check that the voltage is above 2.1 volts. If the voltage is below 2.1 volts the transmitter frequency programmed is too high for the operating bandwidth of the radio.
- 6. Set the PTT switch to receive.
- 7. Using the channel switch select channel with the lowest receive frequency.
- 8. Adjusting L356, set the voltage measured at TP1. Measure and check that the voltage is above 1.5 volts. If the voltage is below 1.5 volts the receive frequency programmed is too high for the operating bandwidth of the radio.
- **Note: The receiver switching bandwidth of this radio is 26MHz. A receiver frequency range of more than 26MHz may be programmed and used if the voltage specification in Step 8 is met. There may be some degradation in actual receiver performance, if bandwidth of more than 26MHz is used.**

# MAXON SM-2000 MOBILE

## SM-2150/VHF ALIGNMENT PROCEDURE

### Receiver Alignment RF

- **NOTE: The Receiver front end is a pre-aligned module. There are no available field adjustments.**
1. Connect an RF signal generator to the ANT socket and a SINAD meter to the external speaker jack ( J1 ) located at the rear panel.
  2. Adjust RV103 to the fully open position to hear receiver noise.
  3. Adjust the VOLUME control to mid position.
  4. Using the channel switch, select the programmed middle receive frequency.
  5. Set the RF signal generator to the same receive channel frequency.
  6. Set the audio frequency to 1kHz at 3K deviation for wide band (25kHz).
  - 6B. Set the audio frequency to 1kHz at 1.5K deviation for narrow band (12.5kHz).
  7. Adjust the RF output voltage level of the RF signal generator until the 1kHz signal is heard.
- **NOTE: The RF output voltage level and the SINAD reading.**
8. Adjust T102 for an improvement in SINAD.
  9. Adjust the RF output voltage level of the RF signal generator keeping the SINAD meter readings between 6dB and 12dB.
  10. Adjust T101 for an improvement in SINAD.
  11. Adjust the RF output voltage level of the RF signal generator keeping the SINAD meter readings between 6dB and 12dB .
  12. Check for an RF voltage signal level of 0.31uV and a SINAD meter reading of 12dB or greater.
  13. Select the highest receive frequency and check for a SINAD meter reading of 12dB or greater, at 0.42uV . (Sensitivity at the operational band edge).
  14. Select the lowest receive frequency and check for a SINAD meter reading of 12dB or greater, at 0.42uV.

### Discriminator Tuning

1. Set the RF level to 1.0mV .
2. Adjust T103 for a maximum audio output and on the oscilloscope monitor the sinewave distortion. Adjust T101 and T102 for lowest distortion as observed on a distortion analyzer. This is normally less than 3%.

# MAXON SM-2000 MOBILE

## SM-2150/VHF ALIGNMENT PROCEDURE

### Squelch Adjustment

1. Select a receiver channel that is programmed for narrow band (12.5 kHz) operation.
2. Set the RF signal generator to the receiver frequency. Set the AF modulation signal to 1 kHz at 1.5k deviation.
3. Adjust the RF output level of the RF signal generator until the 1 kHz signal is heard.
4. Adjust the RF signal to the level desired for squelch sensitivity as you monitor SINAD. This is usually 8dB to 12dB SINAD.
5. On the main board adjust RV103 until the squelch is just unmuted (open)
6. Switch off the RF generator (squelch should close).
7. Switch on the RF generator. Squelch should open at the SINAD point where RV103 was adjusted. This completes the narrow band adjustment.
8. Select a receiver channel that is programmed for wide band operation (25 kHz).
9. Set the RF signal generator to the receiver frequency. Set the AF modulation signal to 1 kHz at 3k deviation.
10. Adjust the RF output level of the RF signal generator until the 1 kHz signal is heard.
11. Adjust the RF signal to the level desired for squelch sensitivity as you monitor SINAD. This is usually 8dB to 12dB SINAD.
12. On the main board adjust RV102 until the squelch is just unmuted (open).
13. Switch off the RF generator (squelch should close).
14. Switch on the RF generator. Squelch should open at the SINAD point where RV102 was adjusted.
15. Disconnect the test equipment.

### Automatic Power Adjustment

- ***Continuous transmit periods longer than 5 minutes are to be avoided.***
1. Connect the antenna output to a RF power meter or service monitor.
  2. Set the PTT switch to the ON position.
  3. Adjust the variable resistor RV104 to give the appropriate transmit power. Normally this is 25watts.
  4. Set the PTT switch to the OFF position.
  5. Select a channel programmed to low transmit power.
  6. Set PTT to ON and adjust RV105 for desired low power.
  7. Set PTT to OFF.

# MAXON SM-2000 MOBILE

## SM-2150/VHF ALIGNMENT PROCEDURE

### CTCSS/DCS Deviation Adjustment

- **Note:** *The following adjustment should be preset with factory alignment. If an adjustment must be made the following procedures must be followed:*
  1. Program the radio with a 67.0Hz tone on one channel and 250.3Hz on another channel.
  2. Connect a power meter and modulation meter to the radio antenna jack.
  3. Adjust RV101 to the center of its adjustment.
- **Note:** *Release the PTT button when changing channels.*
  4. Alternately select the channel with tone 250.3Hz and the channel with tone 67Hz. Key up and note the level for each. If necessary, adjust RV101 until a balance occurs between tone 250.3Hz and tone 67Hz.
- **Note:** *This adjustment also sets DCS balance even if a DCS tone is not programmed at this time.*
  5. Select tone 250.3Hz or tone 67Hz and adjust RV403 for the tone level, typically between 500Hz to 1kHz.
  6. Release the PTT button.

### Modulation Deviation Adjustment

1. Connect a power meter and a coupler to the radio.
2. Connect an AF generator to the test box.
3. Set the audio output to 30mV and the audio frequency to 1kHz .
4. Using the channel switch, select the highest transmit channel that does not have CTCSS or DCS programmed.
5. Press and hold the PTT switch.
6. Adjust RV402 for 90% of maximum, system deviation.
- 6a. Adjust RV402 for 2.25kHz for narrow band (12.5kHz).
- 6b. Adjust RV402 for 4.5kHz for wide band (25kHz).
7. Using the channel switch, select the lowest transmit channel that does not have CTCSS or DCS programmed.
8. Press and hold the PTT switch.
9. Measure and check that the deviation is not below 3.8k . If the deviation is below 3.8k, adjust RV402 to 3.8k .
10. Return to highest transmit channel having a sub- audible tone and verify deviation does not exceed 5k.
11. At the channel that highest deviation is found, sweep the audio frequency between 300kHz and 3kHz . Adjust RV402 to ensure deviation is below peak system deviation at all frequencies.
12. Set the PTT switch to the OFF position.

# MAXON SM-2000 MOBILE

## ALIGNMENT POINTS DIAGRAM (SM-2150/VHF)

### ALIGNMENT POINTS DIAGRAM (SM-2150/VHF)

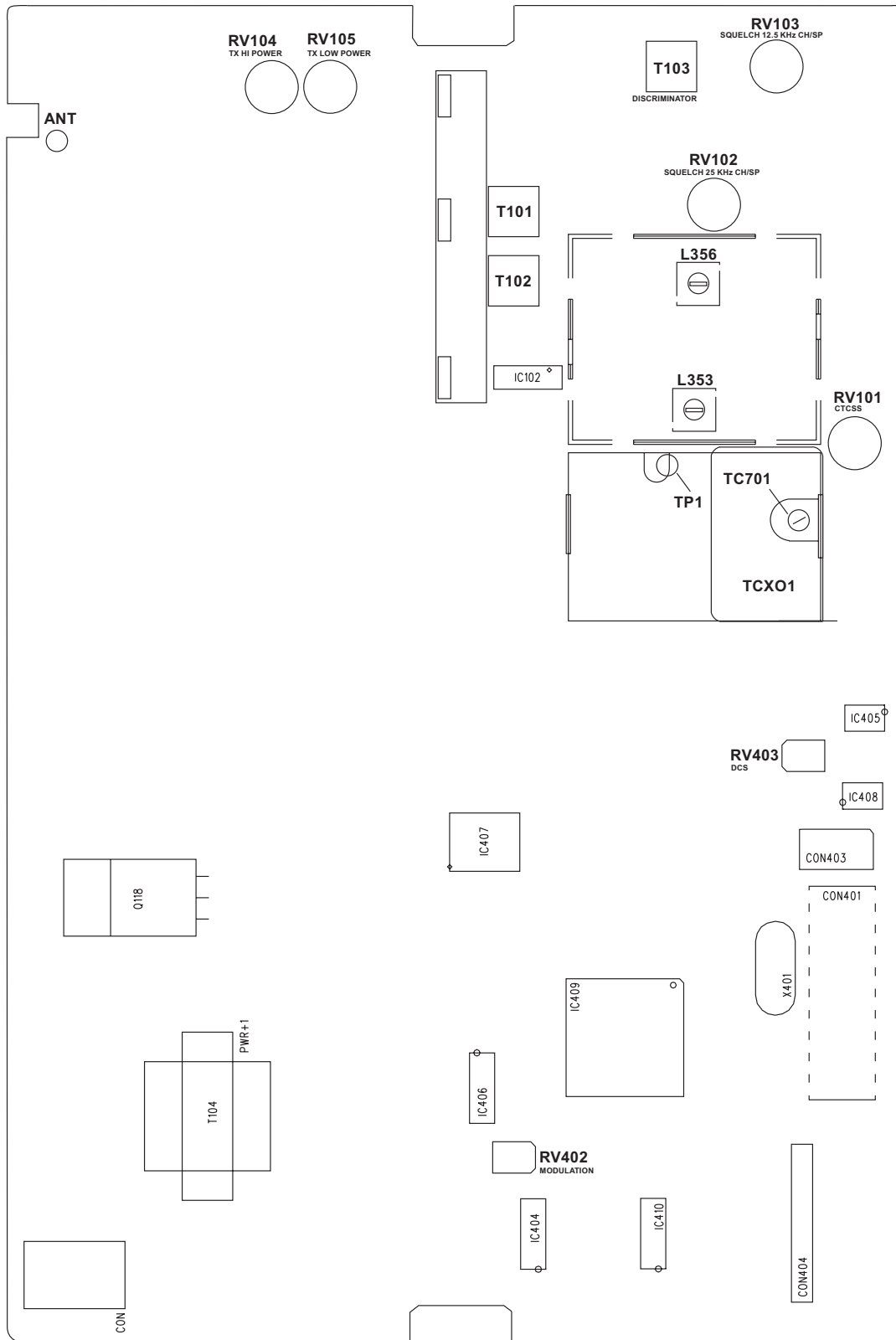

# MAXON SM-2000 MOBILE

## SM-2450/UHF ALIGNMENT PROCEDURE

### SM-2450/UHF ALIGNMENT PROCEDURE

It is important that the TCXO be on the correct frequency before performing a complete alignment of the radio. An incorrect TCXO frequency can impair the performance and even cause mis-alignments.

Normally the transmitter is monitored with a frequency counter or service monitor while the transmitter is keyed at its highest frequency. The TCXO is adjusted for the least frequency error. Typically the frequency is 470MHz with a frequency error of +/- 750Hz or less. TC701 adjusts the center frequency if necessary.

#### PLL Alignment

- **NOTE: If the PLL is out- of- lock, an audible warning will be heard and the front panel red LED will flash.**
1. Connect an RF power meter to the ANT jack.
  2. Using the channel switch, select the channel with the highest transmit frequency.
  3. Connect a DC voltmeter to test point 1 ( TP1 ), accessed via the hole in the VCO cover.
  4. Set the PTT switch to transmit.
  5. Adjusting TC101 , set the voltage measured at TP1 to 12.0 (+/- 0.05) volts.
  6. Release the PTT switch.
  7. Using the channel switch, select the channel with the lowest receive frequency.
  8. At TP1 measure and check that the voltage is 1.4 volts or more. If the voltage is below 1.4 volts the VCO may not lock because the lowest RX frequency is programmed too far below the TX frequency.

#### Receiver Alignment RF

- **NOTE: The Receiver front end is a pre-aligned module. There are no available field adjustments.**
1. Connect an RF signal generator to the ANT socket and a SINAD meter to the external speaker jack ( J1 ) located at the rear panel.
  2. Adjust RV103 to the fully open position to hear receiver noise.
  3. Adjust the VOLUME control to mid position.
  4. Using the channel switch, select the programmed middle receive frequency.
  5. Set the RF signal generator to the same receive channel frequency.
  6. Set the audio frequency to 1kHz at 3K deviation for wide band (25kHz).
  - 6B. Set the audio frequency to 1kHz at 1.5K deviation for narrow band (12.5kHz).
  7. Adjust the RF output voltage level of the RF signal generator until the 1kHz signal is heard.
- **NOTE: The RF output voltage level and the SINAD reading.**
8. Adjust T102 for an improvement in SINAD.
  9. Adjust the RF output voltage level of the RF signal generator keeping the SINAD meter readings between 6dB and 12dB .
  10. Adjust T101 for an improvement in SINAD.

# MAXON SM-2000 MOBILE

## SM-2450/UHF ALIGNMENT PROCEDURE

11. Adjust the RF output voltage level of the RF signal generator keeping the SINAD meter readings between 6dB and 12dB .
12. Check for an RF voltage signal level of 0.31uV and a SINAD meter reading of 12dB or greater.
13. Select the highest receive frequency and check for a SINAD meter reading of 12dB or greater, at 0.42uV . (Sensitivity at the operational band edge).
14. Select the lowest receive frequency and check for a SINAD meter reading of 12dB or greater, at 0.42uV.

### Discriminator Tuning

1. Set the RF level to 1.0mV .
2. Adjust T103 for a maximum audio output and on the oscilloscope monitor the sinewave distortion. Adjust T101 and T102 for lowest distortion as observed on a distortion analyzer. This is normally less than 3%.

### Squelch Adjustment

1. Select a receiver channel that is programmed for narrow band (12.5 kHz) operation.
2. Set the RF signal generator to the receiver frequency. Set the AF modulation signal to 1 kHz at 1.5k deviation.
3. Adjust the RF output level of the RF signal generator until the 1 kHz signal is heard.
4. Adjust the RF signal to the level desired for squelch sensitivity as you monitor SINAD. This is usually 8dB to 12dB SINAD.
5. On the main board adjust RV103 until the squelch is just unmuted (open)
6. Switch off the RF generator (squelch should close).
7. Switch on the RF generator. Squelch should open at the SINAD point where RV103 was adjusted. This completes the narrow band adjustment.
8. Select a receiver channel that is programmed for wide band operation (25 kHz).
9. Set the RF signal generator to the receiver frequency. Set the AF modulation signal to 1 kHz at 3k deviation.
10. Adjust the RF output level of the RF signal generator until the 1 kHz signal is heard.
11. Adjust the RF signal to the level desired for squelch sensitivity as you monitor SINAD. This is usually 8dB to 12dB SINAD.
12. On the main board adjust RV102 until the squelch is just unmuted (open).
13. Switch off the RF generator (squelch should close).
14. Switch on the RF generator. Squelch should open at the SINAD point where RV102 was adjusted.
15. Disconnect the test equipment.



# MAXON SM-2000 MOBILE

## SM-2450/UHF ALIGNMENT PROCEDURE

### Automatic Power Adjustment

- **NOTE: Continuous transmit periods longer than 5 minutes are to be avoided.**
- 1. Connect the antenna output to an RF power meter or service monitor.
- 2. Set the PTT switch to the ON position.
- 3. Adjust the Variable resistor RV104 to give the appropriate transmit power. Nominally this is 25watts .
- 4. Set the PTT switch to the OFF position.
- 5. Select a channel programmed to low transmit power.
- 6. Set PTT to ON and adjust RV105 for desired low power .
- 7. Set PTT to OFF.

### CTCSS/DCS Deviation Adjustment

- **NOTE: The following adjustment should be preset with factory alignment. If an adjustment must be made the following procedures must be followed:**
- 1. Program the radio with a 67.0Hz tone on one channel and 250.3Hz on another channel.
- 2. Connect a power meter and modulation meter to the radio antenna jack.
- 3. Adjust RV101 to the center of its adjustment.
- **Note: Release the PTT button when changing channels.**
- 4. Alternately select the channel with tone 250.3Hz and the channel with tone 67Hz . Key up and note the level for each. If necessary, adjust RV101 until a balance occurs between tone 250.3Hz and tone 67Hz .
- **Note: This adjustment also sets DCS balance even if a DCS tone is not programmed at this time.**
- 5. Select tone 250.3Hz or tone 67Hz and adjust RV403 for the tone level, typically between 500Hz to 1kHz.
- 6. Release the PTT button.

# MAXON SM-2000 MOBILE

## SM-2450/UHF ALIGNMENT PROCEDURE

### Modulation Deviation Adjustment

1. Connect a power meter and a coupler to the radio.
2. Connect an AF generator to the test box.
3. Set the audio output to 30mV and the audio frequency to 1kHz .
4. Using the channel switch, select the highest transmit channel that does not have CTCSS or DCS programmed.
5. Press and hold the PTT switch.
6. Adjust RV402 for 90% of maximum, system deviation.
- 6a. Adjust RV402 for 2.25kHz for narrow band (12.5kHz).
- 6b. Adjust RV402 for 4.5kHz for wide band (25kHz).
7. Using the channel switch, select the lowest transmit channel that does not have CTCSS or DCS programmed.
8. Press and hold the PTT switch.
9. Measure and check that the deviation is not below 3.8k . If the deviation is below 3.8k, adjust RV402 to 3.8k .
10. Return to highest transmit channel having a sub- audible tone and verify deviation does not exceed 5k.
11. At the channel that highest deviation is found, sweep the audio frequency between 300kHz and 3kHz . Adjust RV402 to ensure deviation is below peak system deviation at all frequencies.
12. Set the PTT switch to the OFF position.

# MAXON SM-2000 MOBILE ALIGNMENT POINTS DIAGRAM (SM-2450/UHF)

## ALIGNMENT POINTS DIAGRAM (SM-2450/UHF)

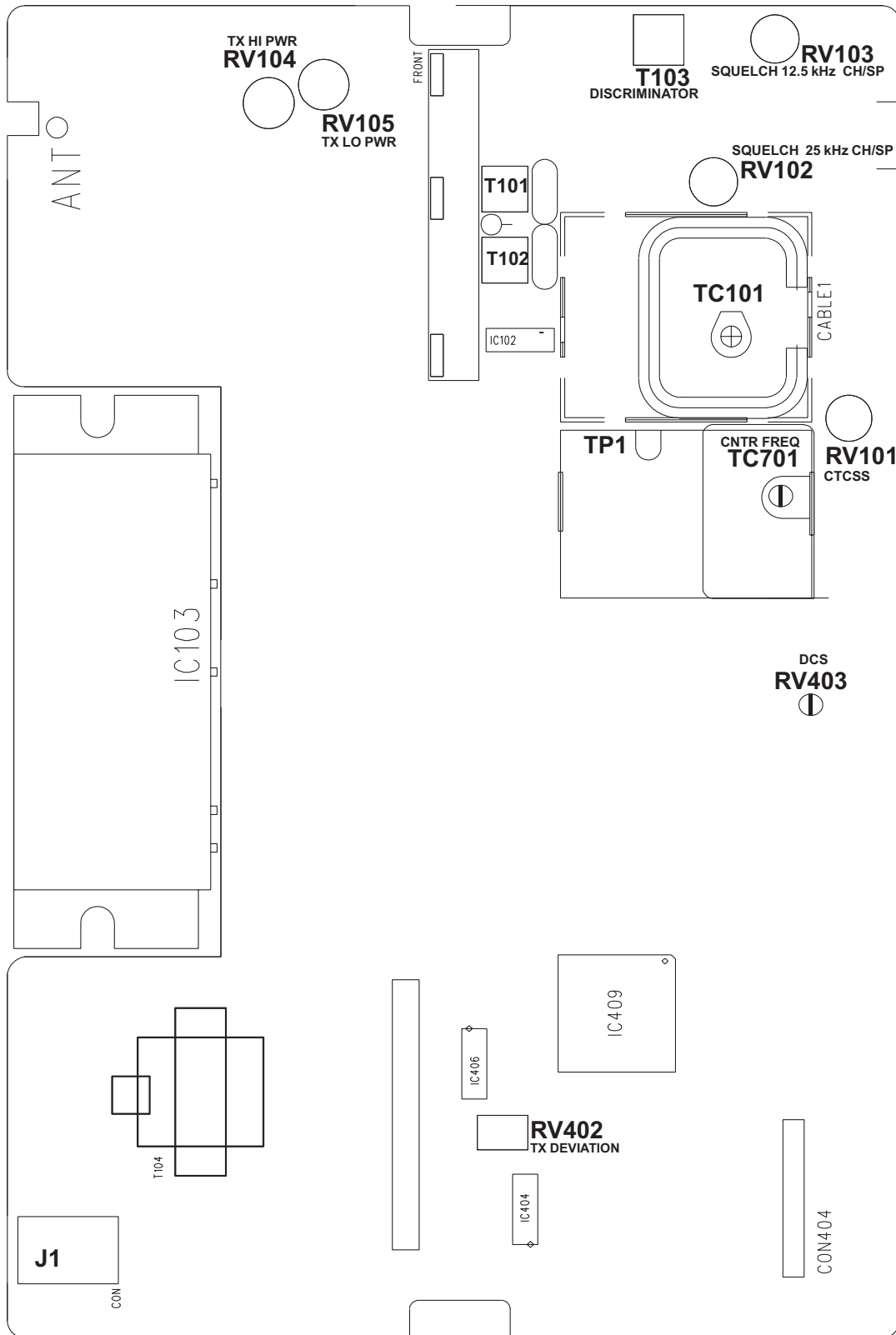

# MAXON SM-2000 MOBILE

## COMPONENT REPLACEMENT

### COMPONENT REPLACEMENT

#### SURFACE MOUNT COMPONENTS

Surface mount components should always be replaced using a temperature controlled soldering system. The soldering tools may be either a temperature controlled soldering iron or a temperature controlled hot-air soldering station. A hot-air system is recommended for the removal of components on these boards. With either soldering system, a temperature of 700° F (371° C) should be maintained.

The following procedures outline the removal and replacement of surface mount components. If a hot-air soldering system is employed, see the manufacturer's operating instructions for detailed information on the use of your system.

- **CAUTION:** Avoid applying heat to the body of any surface mount component using standard soldering methods. Heat should be applied only to the metalized terminals of the components. Hot-air systems do not damage the components since the heat is quickly and evenly distributed to the external surface of the component.
- **CAUTION:** The CMOS Integrated Circuit devices used in this equipment can be destroyed by static discharges. Before handling one of these devices, service technicians should discharge themselves by touching the case of a bench test instrument that has a 3-prong power cord connected to an outlet with a known good earth ground. When soldering or desoldering a CMOS device, the soldering equipment should have a known good earth ground.

#### SURFACE MOUNT REMOVAL

1. Grip the component with tweezers or small needle nose pliers.
2. Alternately heat the metalized terminal ends of the surface mount component with the soldering iron. If a hot-air system is used, direct the heat to the terminals of the component. Use extreme care with the soldering equipment to prevent damage to the printed circuit board (PCB) and the surrounding components.
3. When the solder on all terminals is liquefied, gently remove the component. Excessive force may cause the PCB pads to separate from the board if all solder is not completely liquefied.
4. It may be necessary to remove excess solder using a vacuum de-soldering tool or Solder wick . Again, use great care when de-soldering or soldering on the printed circuit boards. It may also be necessary to remove the epoxy adhesive that was under the surface mount component and any flux on the printed circuit board.

# MAXON SM-2000 MOBILE COMPONENT REPLACEMENT

## SURFACE MOUNT COMPONENT REPLACEMENT

1. "Tin" one terminal end of the new component and the corresponding pad of the PCB. Use as little solder as possible.
2. Place the component on the PCB pads, observing proper polarity for capacitors, diodes, transistors, etc.
3. Simultaneously touch the "tinned" terminal end and the "tinned" pad with the soldering iron. Slightly press the component down on the board as the solder liquefies. Solder all terminals, allowing the component time to cool between each application of heat. Do not apply heat for an excessive length of time and do not use excessive solder.

With a hot-air system, apply hot air until all "tinned" areas are melted and the component is seated in place. It may be necessary to slightly press the component down on the board. Touch-up the soldered connections with a standard soldering iron if needed. Do not use excessive solder.

- CAUTION: Some chemicals may damage the internal and external plastic parts of the radio.
4. Allow the component and the board to cool and then remove all flux from the area using alcohol or another approved flux remover.

## SURFACE MOUNTED INTEGRATED CIRCUIT REPLACEMENT

Soldering and de-soldering techniques of the surface mounted IC's are similar to the above outlined procedures for the surface mounted chip components. Use extreme care and observe static precautions when removing or replacing the defective (or suspect) IC's. This will prevent any damage to the printed circuit board or the surrounding circuitry.

The hot-air soldering system is the best method of replacing surface mount IC's. The IC's can easily be removed and installed using the hot-air system. See the manufacturer's instructions for complete details on tip selection and other operating instructions unique to your system.

If a hot-air system is not available, the service technician may wish to clip the pins near the body of the defective IC and remove it. The pins can then be removed from the PCB with a standard soldering iron and tweezers, and the new IC installed following the Surface Mount Component Replacement procedures. It may not be necessary to "tin" all (or any) of the IC pins before the installation process.

# MAXON SM-2000 MOBILE

## PARTS LIST COMMON TO SM-2000

### PARTS LIST COMMON TO SM-2000

REF #	DESCRIPTION	PART #	REF #	DESCRIPTION	PART #
650-100-0002	TCXO PCB ASSY. (SEE NOTE 1)		650-050-0003	CONTROL HEAD PCB ASSY.	
650-090-0003	MA-4472 MIC ASSY. (SEE NOTE 1)				
			CON1	HEADER PIN	Z422-492-1
			CON801	JACK MODULAR	420-709-9
			C801	CHIP CERAMIC 47PF	134-722-1Z
			C802	CHIP CERAMIC 47PF	134-722-1Z
			C803	CHIP CERAMIC 47PF	134-722-1Z
			C804	CHIP CERAMIC 47PF	134-722-1Z
			C805	CHIP CERAMIC 47PF	134-722-1Z
			C806	CHIP CERAMIC 47PF	134-722-1Z
			C807	CHIP CERAMIC 47PF	134-722-1Z
			C808	CHIP CERAMIC 47PF	134-722-1Z
			C809	CHIP CERAMIC 47PF	134-722-1Z
			C815	DISK CERAMIC (FOR SP1) 470PF	134-710-8
			C821	CHIP CERAMIC 0.001UF	130-A17-6Z
			C823	ELECT CAPACITOR 10UF	101-025-9
			D801	DIODE SI CHIP KDS193	243-052-6
			D802	DIODE SI CHIP KDS193	243-052-6
			D803	DIODE SI CHIP KDS193	243-052-6
			D804	DIODE SI CHIP KDS184S	243-051-5
			D807	DIODE ZENER	241-099-9
			D808	DIODE ZENER	241-099-9
			D810	DIODE ZENER	241-099-9
			D811	DIODE ZENER	241-099-9
			LED1	LED LAMP GRN 3 V 75MW	251-160-3
			LED2	LED LAMP GRN 3 V 75MW	251-160-3
			LED3	LED LAMP GRN 3 V 75MW	251-160-3
			LED4	LED LAMP GRN 3 V 75MW	251-160-3
			LED5	LED LAMP RED/GRN 3 V	251-168-1
			Q821	TRANSISTOR	202-106-5
			Q822	TRANSISTOR	202-106-5
			R801	CHIP RESISTOR 470 OHM	060-471-0Z
			R821	CHIP RESISTOR 22 OHM	060-220-0Z
			R822	CHIP RESISTOR 4.7K	060-472-1Z
			SP1	SPEAKER 4 OHM	420-108-4A
			SW3	SW PUSH	432-063-7
			SW4	TACT SWITCH	436-038-8
			SW405	SW ROTARY	430-070-5
			VR801	VR 20KA	450-523-5
				HOLDER(LED)	892-390
				HOLDER(LED)	892-540
				P.C.B. CONTROL HEAD	416-988-C

**NOTES:**

1. Components are not available, assembly is non-repairable.

# MAXON SM-2000 MOBILE

## 650-000-0001 SM-2150/VHF MAIN BOARD

### 650-000-0001 SM-2150/VHF MAIN BOARD

#### DIGITAL SECTION

#### *Digital Parts Common on Both VHF & UHF*

<u>REF #</u>	<u>DESCRIPTION</u>	<u>PART #</u>	<u>REF #</u>	<u>DESCRIPTION</u>	<u>PART #</u>
C401	CHIP CERAMIC 0.001UF	130-A17-6Z	C450	CHIP CERAMIC 0.047UF	130-424-0Z
C402	CHIP CERAMIC 0.22UF	130-270-7Y	C452	CHIP TANTALUM 1UF	141-036-1Z
C403	CHIP CERAMIC 0.01UF	130-172-2Z	C453	CHIP CERAMIC 0.01UF	130-172-2Z
C404	ELECT CAPACITOR 10UF	101-025-9	C454	CHIP TANTALUM 1UF	141-036-1Z
C405	CHIP CERAMIC 220PF	132-220-2Z	C455	CHIP CERAMIC 0.033UF	130-314-5Z
C406	CHIP CERAMIC 220PF	132-220-2Z	C456	CHIP CERAMIC 0.001UF	130-A17-6Z
C407	ELECT CAPACITOR 10UF	101-025-9	C457	CHIP CERAMIC 0.047UF	130-424-0Z
C408	CHIP CERAMIC 0.033UF	130-314-5Z	C458	CHIP CERAMIC 0.01UF	130-172-2Z
C409	CHIP CERAMIC 0.0068UF	130-602-4Y	C460	CHIP CERAMIC 0.1UF	130-170-0Y
C410	CHIP CERAMIC 47PF	134-722-1Z	C464	CHIP CERAMIC 0.033UF	130-314-5Z
C411	CHIP CERAMIC 0.1UF	130-170-0Y	C550	CHIP CERAMIC 18PF	131-816-6Z
C412	CHIP CERAMIC 0.015UF	130-A44-0Y	C551	CHIP CERAMIC 18PF	131-816-6Z
C413	CHIP CERAMIC 47PF	134-722-1Z	C552	CHIP CERAMIC 0.01UF	130-172-2Z
C414	CHIP CERAMIC 0.047UF	130-424-0Z	C553	CHIP CERAMIC 0.01UF	130-172-2Z
C415	CHIP CERAMIC 220PF	132-220-2Z	C554	CHIP CERAMIC 0.01UF	130-172-2Z
C416	CHIP CERAMIC 0.01UF	130-172-2Z	C555	CHIP CERAMIC 0.01UF	130-172-2Z
C417	CHIP CERAMIC 0.0047UF	134-719-7Z	C558	ELECT CAPACITOR 10UF	101-025-9
C418	CHIP CERAMIC 0.022UF	130-263-1Z	C559	CHIP CERAMIC 0.01UF	130-172-2Z
C419	CHIP CERAMIC 0.0018UF	130-A22-0Z	CON403	PROG CONNECTOR	421-677-7
C420	CHIP CERAMIC 470PF	134-761-4Z	CON404	OPTION BOARD CONNECTOR	422-746-1
C421	CHIP CERAMIC 470PF	134-761-4Z	D401	DIODE SI CHIP	243-051-5
C422	CHIP CERAMIC 220PF	132-220-2Z	D402	DIODE SWITCHING	243-063-6
C423	CHIP CERAMIC 220PF	132-220-2Z	D551	DIODE SI CHIP	243-049-4
C424	CHIP CERAMIC 220PF	132-220-2Z	D552	DIODE SI CHIP	243-049-4
C425	CHIP CERAMIC 0.1UF	130-A60-4Y	IC401	I.C.	223-224-9
C426	CHIP CERAMIC 0.022UF	130-263-1Z	IC402	I.C. REGULATOR	220-378-0
C428	CHIP CERAMIC 0.01UF	130-172-2Z	IC404	I.C. OP AMP	222-018-5
C429	CHIP CERAMIC 47PF	134-722-1Z	IC405	I.C. OP AMP	231-064-4
C430	CHIP CERAMIC 0.1UF	130-A60-4Y	IC406	I.C. OP AMP	222-018-5
C431	CHIP CERAMIC 0.0033UF	130-315-6Z	IC407	I.C.	231-073-3
C432	CHIP CERAMIC 0.68UF	130-624-4	IC408	I.C. EEPROM	229-463-8A
C433	CHIP CERAMIC 0.082UF	130-808-4Y	IC409	I.C.	220-130-2
C434	CHIP CERAMIC 120PF	131-107-9Z	IC410	I.C. OP AMP	222-018-5
C435	ELECT CAPACITOR 1UF	101-006-2	IC411	I.C.	223-261-2
C436	CHIP CERAMIC 0.1UF	130-170-0Y	IC412	I.C.	223-261-2
C437	CHIP CERAMIC 0.1UF	130-A60-4Y	Q131	TRANSISTOR	202-095-8Z
C438	ELECT CAPACITOR 10UF	101-025-9	Q401	TRANSISTOR	202-095-8Z
C440	CHIP CERAMIC 15PF	131-511-0Z	Q402	TRANSISTOR	202-095-8Z
C441	CHIP CERAMIC 15PF	131-511-0Z	Q403	TRANSISTOR	202-095-8Z
C442	CHIP CERAMIC 0.047UF	130-424-0Z	Q404	TRANSISTOR	202-095-8Z
C443	CHIP CERAMIC 0.047UF	130-424-0Z	Q405	TRANSISTOR	202-095-8Z
C445	CHIP CERAMIC 0.033UF	130-314-5Z	Q406	TRANSISTOR	202-095-8Z
C446	CHIP CERAMIC 0.033UF	130-314-5Z	Q407	BRT	202-091-4
C447	CHIP CERAMIC 0.033UF	130-314-5Z	Q409	TRANSISTOR	202-095-8Z
C448	CHIP CERAMIC 0.033UF	130-314-5Z	Q504	TRANSISTOR	202-106-5

# MAXON SM-2000 MOBILE

## 650-000-0001 SM-2150/VHF MAIN BOARD

### DIGITAL SECTION (continued)

#### Digital Parts Common on Both VHF & UHF

REF #	DESCRIPTION	PART #	REF #	DESCRIPTION	PART #
Q550	TRANSISTOR	202-113-1	R447	CHIP RESISTOR 120K	060-124-6Z
Q551	TRANSISTOR	202-113-1	R448	CHIP RESISTOR 220K	060-224-4Z
Q552	TRANSISTOR	202-113-1	R449	CHIP RESISTOR 820	060-821-3Z
Q553	TRANSISTOR	202-113-1	R450	CHIP RESISTOR 22K	060-223-3Z
R186	CHIP RESISTOR 47K	060-473-2Z	R451	CHIP RESISTOR 2.2K	060-222-2Z
R401	CHIP RESISTOR 680K	060-684-6Z	R452	CHIP RESISTOR 1M	060-105-0Z
R402	CHIP RESISTOR 47K	060-473-2Z	R453	CHIP RESISTOR 3K	060-302-1Z
R403	CHIP RESISTOR 10K	060-103-8Z	R454	CHIP RESISTOR 4.7K	060-472-1Z
R404	CHIP RESISTOR 56K	060-563-0Z	R455	CHIP RESISTOR 3.6K	060-362-5Z
R405	CHIP RESISTOR 7.5K	060-752-4Z	R456	CHIP RESISTOR 27K	060-273-8Z
R406	CHIP RESISTOR 18K	060-183-0Z	R457	CHIP RESISTOR 47K	060-473-2Z
R407	CHIP RESISTOR 330K	060-334-0Z	R458	CHIP RESISTOR 47K	060-473-2Z
R408	CHIP RESISTOR 3.3K	060-332-8Z	R459	CHIP RESISTOR 2.4K	060-242-0
R410	CHIP RESISTOR 220K	060-224-4Z	R460	CHIP RESISTOR 470	060-471-0Z
R411	CHIP RESISTOR 100K	060-104-9Z	R461	CHIP RESISTOR 470	060-471-0Z
R412	CHIP RESISTOR 39K	060-393-3Z	R462	CHIP RESISTOR 47K	060-473-2Z
R414	CHIP RESISTOR 8.2K	060-822-4Z	R463	CHIP RESISTOR 47K	060-473-2Z
R415	CHIP RESISTOR 8.2K	060-822-4Z	R464	CHIP RESISTOR 47K	060-473-2Z
R416	CHIP RESISTOR 220K	060-224-4Z	R465	CHIP RESISTOR 47K	060-473-2Z
R417	CHIP RESISTOR 8.2K	060-822-4Z	R466	CHIP RESISTOR 100K	060-104-9Z
R418	CHIP RESISTOR 8.2K	060-822-4Z	R469	CHIP RESISTOR 10K	060-103-8Z
R419	CHIP RESISTOR 47K	060-473-2Z	R470	CHIP RESISTOR 30K	060-303-2Z
R420	CHIP RESISTOR 10K	060-103-8Z	R471	CHIP RESISTOR 36K	060-363-6Z
R421	CHIP RESISTOR 10K	060-103-8Z	R472	CHIP RESISTOR 30K	060-303-2Z
R422	CHIP RESISTOR 43K	060-433-6Z	R473	CHIP RESISTOR 4.7K	060-472-1Z
R423	CHIP RESISTOR 47K	060-473-2Z	R474	CHIP RESISTOR 360K	060-364-7
R424	CHIP RESISTOR 560	060-561-8Z	R490	CHIP RESISTOR 47K	060-473-2Z
R425	CHIP RESISTOR 10K	060-103-8Z	R550	CHIP RESISTOR 7.5K	060-752-4Z
R426	CHIP RESISTOR 47K	060-473-2Z	R551	CHIP RESISTOR 27K	060-273-8Z
R427	CHIP RESISTOR 39K	060-393-3Z	R552	CHIP RESISTOR 27K	060-273-8Z
R428	CHIP RESISTOR 20K	060-203-5Z	R553	CHIP RESISTOR 7.5K	060-752-4Z
R429	CHIP RESISTOR 100K	060-104-9Z	R554	CHIP RESISTOR 2.2K	060-222-2Z
R430	CHIP RESISTOR 10K	060-103-8Z	R555	CHIP RESISTOR 4.7K	060-472-1Z
R431	CHIP RESISTOR 22K	060-223-3Z	R556	CHIP RESISTOR 2.2K	060-222-2Z
R433	CHIP RESISTOR 47K	060-473-2Z	R559	CHIP RESISTOR 470	060-471-0Z
R434	CHIP RESISTOR 47K	060-473-2Z	RLK3	CHIP RESISTOR 0	060-000-8Z
R435	CHIP RESISTOR 47K	060-473-2Z	RLK4	CHIP RESISTOR 0	060-000-8Z
R436	CHIP RESISTOR 22K	060-223-3Z	RLK5	CHIP RESISTOR 0	060-000-8Z
R437	CHIP RESISTOR 4.7K	060-472-1Z	RLK7	CHIP RESISTOR 0	060-000-8Z
R438	CHIP RESISTOR 4.7K	060-472-1Z	RLK8	CHIP RESISTOR 0	060-000-8Z
R439	CHIP RESISTOR 47K	060-473-2Z	RLK10	CHIP RESISTOR 0	060-000-8Z
R440	CHIP RESISTOR 1M	060-105-0Z	RLK11	CHIP RESISTOR 0	060-000-8Z
R441	CHIP RESISTOR 43K	060-433-6Z	RLK12	CHIP RESISTOR 0	060-000-8Z
R442	CHIP RESISTOR 33K	060-333-9Z	RLK13	CHIP RESISTOR 0	060-000-8Z
R443	CHIP RESISTOR 20K	060-203-5Z	RLK14	CHIP RESISTOR 0	060-000-8Z
R444	CHIP RESISTOR 220K	060-224-4Z	RV402	RES.CHIP SEMIFIXED 22K	067-223-8Y
R445	CHIP RESISTOR 120K	060-124-6Z	RV403	RES.CHIP SEMIFIXED 47K	067-473-7Y
R446	CHIP RESISTOR 82K	060-823-5Z	X401	CRYSTAL	262-228-0Z



# MAXON SM-2000 MOBILE

## 650-000-0001 SM-2150/VHF MAIN BOARD

### BAND CHART

<b>SM-2150L VHF BAND 1 (136-162 MHz)</b>			<b>SM-2150H VHF BAND 2 (148-174 MHz)</b>		
<u>REF #</u>	<u>DESCRIPTION</u>	<u>PART #</u>	<u>REF #</u>	<u>DESCRIPTION</u>	<u>PART #</u>
FRONT-END PCB ASSEMBLY		650-110-0011	FRONT-END PCB ASSEMBLY		650-110-0002
<b><u>MAIN BOARD PARTS</u></b>			<b><u>MAIN BOARD PARTS</u></b>		
<b>C155</b>	CHIP CERAMIC 4PF	134-007-7Y	<b>C155</b>	CHIP CERAMIC 11PF	131-103-5Y
<b>C160</b>	CHIP CERAMIC 24PF	132-407-5Y	<b>C160</b>	CHIP CERAMIC 24PF	132-407-5Y
<b>C164</b>	CHIP CERAMIC 18pF	131-816-6Y	<b>C164</b>	CHIP CERAMIC 24PF	132-407-5Y
<b>C165</b>	CHIP CERAMIC 9pF	139-003-8Y	<b>C165</b>	CHIP CERAMIC 16PF	131-603-0
<b>C245</b>	CHIP CERAMIC 5PF	135-010-4Y	<b>C245</b>	CHIP CERAMIC 8PF	138-004-4Y
<b>C248</b>	CHIP CERAMIC 27PF	132-714-2Y	<b>C248</b>	CHIP CERAMIC 27PF	132-714-2Y
<b>C249</b>	CHIP CERAMIC 20PF	132-012-1Y	<b>C249</b>	CHIP CERAMIC 18PF	131-816-6Y
<b>C253</b>	CHIP CERAMIC 75PF	137-504-4Y	<b>C253</b>	CHIP CERAMIC 75PF	137-504-4Y
<b>C254</b>	CHIP CERAMIC 33PF	133-336-9Y	<b>C254</b>	CHIP CERAMIC 43PF	134-302-2Y
<b>C269</b>	CHIP CERAMIC 9PF	139-003-8Y	<b>C269</b>	CHIP CERAMIC 2.7PF	132-725-2Y
<b>C270</b>	CHIP CERAMIC 4PF	134-013-2Y	<b>C270</b>	CHIP CERAMIC 6PF	136-015-4Y
<b>C273</b>	CHIP CERAMIC 43PF	134-302-2Y	<b>C273</b>	CHIP CERAMIC 51PF	135-106-8Y
<b>C275</b>	CHIP CERAMIC 47PF	134-773-5Y	<b>C275</b>	CHIP CERAMIC 56PF	135-639-1Y
<b>C277</b>	CHIP CERAMIC 43PF	134-302-2Y	<b>C277</b>	CHIP CERAMIC 47PF	134-773-5Y
<b>C278</b>	CHIP CERAMIC 82PF	138-216-9Z	<b>C278</b>	CHIP CERAMIC 75PF	137-512-1Z
<b>C280</b>	CHIP CERAMIC 24PF	132-408-6Y	<b>C280</b>	CHIP CERAMIC 20PF	132-021-9
<b>C281</b>	CHIP CERAMIC 36pF	133-611-7Y	<b>C281</b>	CHIP CERAMIC 56PF	135-613-9Y
<b>C283</b>	CHIP CERAMIC 18PF	131-829-8Y	<b>C283</b>	CHIP CERAMIC 27PF	132-723-0Y
<b>C354</b>	CHIP CERAMIC 39PF	133-932-7Y	<b>C354</b>	CHIP CERAMIC 30PF	133-010-4Y
<b>C356</b>	CHIP CERAMIC 4PF	134-007-7Y	<b>C356</b>	NOT USED	NOT USED
<b>C357</b>	CHIP CERAMIC 4.7PF	134-767-0Y	<b>C357</b>	CHIP CERAMIC 5.6PF	135-627-2Y
<b>C358</b>	CHIP CERAMIC 4.7PF	134-767-0Y	<b>C358</b>	CHIP CERAMIC 5.6PF	135-627-2Y
<b>C365</b>	CHIP CERAMIC 16PF	131-603-0	<b>C365</b>	CHIP CERAMIC 18PF	131-816-6Y
<b>C367</b>	CHIP CERAMIC 3.3PF	133-321-5Y	<b>C367</b>	CHIP CERAMIC 4.7PF	134-767-0Y
<b>C368</b>	CHIP CERAMIC 3.3PF	133-321-5Y	<b>C368</b>	CHIP CERAMIC 4.7PF	134-767-0Y
<b>L353</b>	COIL CORE CHIP	311-117-4	<b>L353</b>	COIL CORE CHIP	320-859-9
<b>L356</b>	COIL CORE CHIP	311-117-4	<b>L356</b>	COIL CORE CHIP	311-117-4
<b>R182</b>	CHIP RESISTOR 120 OHM	060-121-4Z	<b>R182</b>	CHIP RESISTOR 150 OHM	060-151-1Z

# MAXON SM-2000 MOBILE

## 650-000-0001 SM-2150/VHF MAIN BOARD

REF #	DESCRIPTION	PART #	REF #	DESCRIPTION	PART #
<b>FRONT-END PCB ASSEMBLY (REFER TO BAND CHART)</b>					
C1	CHIP CERAMIC 470PF	134-761-4Y	C183	CHIP CERAMIC 47PF	134-722-1Y
C101	CHIP CERAMIC 220PF	132-220-2Y	C184	CHIP CERAMIC 33PF	133-306-2Y
C102	CHIP CERAMIC 220PF	132-220-2Y	C185	CHIP CERAMIC 20PF	132-012-1Y
C103	CHIP CERAMIC 220PF	132-220-2Y	C186	CHIP CERAMIC 0.1UF	130-A60-4Y
C104	CHIP CERAMIC 220PF	132-220-2Y	C187	CHIP CERAMIC 0.1UF	130-A60-4Y
C105	CHIP CERAMIC 5PF	135-010-4Y	C188	CHIP CERAMIC 220PF	132-220-2Y
C106	CHIP CERAMIC 470PF	134-761-4Y	C189	CHIP CERAMIC 0.68UF	130-624-4
C107	CHIP CERAMIC 0.1UF	130-170-0Y	C190	CHIP CERAMIC 0.033UF	130-314-5Y
C108	CHIP CERAMIC 1UF	131-089-7Y	C191	CHIP CERAMIC 0.1UF	130-A60-4Y
C109	CHIP CERAMIC 220PF	132-220-2Y	C192	CHIP CERAMIC 0.033UF	130-314-5Y
C110	CHIP CERAMIC 0.001UF	130-A17-6Y	C193	CHIP CERAMIC 0.1UF	130-A60-4Y
C113	CHIP TANTALUM 1UF	141-036-1Z	C194	CHIP CERAMIC 0.0033UF	130-315-6Y
C114	MYLAR CAPACITOR 0.1UF	111-022-9	C195	CHIP CERAMIC 10PF	131-039-1Y
C115	CHIP CERAMIC 0.1UF	130-170-0Y	C196	CHIP CERAMIC 0.01UF	130-172-2Y
C119	CHIP CERAMIC 10PF	131-039-1Y	C197	CHIP CERAMIC 47PF	134-722-1Y
C120	MYLAR CAPACITOR 0.01UF	111-008-7Z	C198	CHIP CERAMIC 0.001UF	130-A17-6Y
C121	CHIP CERAMIC 470PF	134-761-4Y	C200	CHIP CERAMIC 0.1UF	130-A60-4Y
C122	CHIP CERAMIC 0.1UF	130-A60-4Y	C201	CHIP CERAMIC 0.01UF	130-172-2Y
C129	CHIP CERAMIC 0.001UF	131-025-8Y	C202	CHIP CERAMIC 0.01UF	130-172-2Y
C139	CHIP CERAMIC 220PF	132-220-2Y	C203	CHIP CERAMIC 0.001UF	130-A17-6Y
C144	CHIP CERAMIC 1.5PF	131-559-4Y	C207	CHIP CERAMIC 0.001UF	130-A17-6Y
C145	CHIP CERAMIC 0.001UF	130-A17-6Y	C209	CHIP CERAMIC 0.1UF	130-A60-4Y
C147	ELECT CAPACITOR 47UF	104-713-2	C211	CHIP CERAMIC 0.01UF	130-172-2Y
C148	CHIP CERAMIC 220PF	132-220-2Y	C212	CHIP CERAMIC 0.01UF	130-172-2Y
C149	CHIP CERAMIC 220PF	132-220-2Y	C214	CHIP CERAMIC 220PF	132-220-2Y
C150	CHIP CERAMIC 220PF	132-220-2Y	C216	CHIP CERAMIC 220PF	132-220-2Y
C151	CHIP CERAMIC 470PF	134-761-4Y	C217	CHIP CERAMIC 220PF	132-220-2Y
C152	ELECT CAPACITOR 2200UF	102-278-6	C219	CHIP CERAMIC 220PF	132-220-2Y
C156	CHIP CERAMIC 0.001UF	130-A17-6Y	C220	CHIP CERAMIC 220PF	132-220-2Y
C157	CHIP CERAMIC 15PF	131-511-0Y	C221	DIP TANTALUM 1UF	141-008-6Z
C158	CHIP CERAMIC 0.001UF	130-A17-6Y	C222	DIP TANTALUM 10UF	141-012-9Z
C159	CHIP CERAMIC 0.001UF	130-A17-6Y	C223	CHIP CERAMIC 220PF	132-220-2Y
C161	CHIP CERAMIC 0.1UF	130-170-0Y	C224	ELECT CAPACITOR 1000UF	101-A02-8
C162	CHIP CERAMIC 220PF	132-220-2Y	C225	CHIP CERAMIC 0.1UF	130-A60-4Y
C167	CHIP CERAMIC 82PF	138-210-3Y	C226	ELECT CAPACITOR 1000UF	101-048-0R
C168	CHIP CERAMIC 0.001UF	130-A17-6Y	C227	CHIP CERAMIC 0.001UF	130-A17-6Y
C169	CHIP CERAMIC 0.01UF	130-172-2Y	C228	CHIP CERAMIC 0.001UF	130-A17-6Y
C170	CHIP CERAMIC 220PF	132-220-2Y	C230	CHIP CERAMIC 0.001UF	130-A17-6Y
C172	CHIP CERAMIC 15PF	131-511-0Y	C232	ELECT CAPACITOR 100UF	101-023-7
C173	CHIP CERAMIC 56PF	135-613-9Y	C233	ELECT CAPACITOR 220UF	102-224-7
C174	CHIP CERAMIC 3.3PF	133-321-5Y	C234	CHIP CERAMIC 220PF	132-220-2Y
C175	CHIP CERAMIC 20PF	132-012-1Y	C235	CHIP CERAMIC 0.001UF	130-A17-6Y
C176	CHIP CERAMIC 39PF	133-932-7Y	C236	CHIP CERAMIC 220PF	132-220-2Y
C177	CHIP CERAMIC 0.001UF	130-A17-6Y	C237	CHIP CERAMIC 0.001UF	130-A17-6Y
C178	CHIP CERAMIC 0.001UF	130-A17-6Y	C238	ELECT CAPACITOR 2200UF	102-278-6
C179	CHIP CERAMIC 82PF	138-210-3Y	C239	ELECT CAPACITOR 10UF	101-025-9
C180	CHIP CERAMIC 0.01UF	130-172-2Y	C240	CHIP CERAMIC 39PF	133-932-7Y
C181	DIP TANTALUM 10UF	141-012-9Z	C241	CHIP CERAMIC 82PF	138-210-3Y
C182	CHIP CERAMIC 0.001UF	130-A17-6Y	C244	CHIP CERAMIC 0.001UF	130-A17-6Y
			C247	CHIP CERAMIC 220PF	132-220-2Y

# MAXON SM-2000 MOBILE

## 650-000-0001 SM-2150/VHF MAIN BOARD

REF #	DESCRIPTION	PART #	REF #	DESCRIPTION	PART #
C247	CHIP CERAMIC 220PF	132-220-2Y	C355	CHIP CERAMIC 1.2PF	131-216-4Y
C248	CHIP CERAMIC 27PF	132-714-2Y	C356	CHIP CERAMIC 4PF	134-007-7Y
C250	ELECT CAPACITOR 47UF	104-713-2	C359	CHIP CERAMIC 0.001UF	130-A17-6Y
C251	CHIP CERAMIC 470PF	134-761-4Y	C360	CHIP CERAMIC 2PF	132-011-0Y
C252	CHIP CERAMIC 0.001UF	130-A17-6Y	C361	CHIP CERAMIC 0.001UF	130-A17-6Y
C253	CHIP CERAMIC 75PF	137-504-4Y	C362	CHIP CERAMIC 0.001UF	130-A17-6Y
C255	CHIP CERAMIC 470PF	134-761-4Y	C363	CHIP CERAMIC 0.001UF	130-A17-6Y
C256	CHIP CERAMIC 75PF	137-504-4Y	C364	CHIP CERAMIC 0.001UF	130-A17-6Y
C257	CHIP CERAMIC 0.01UF	130-172-2Y	C369	CHIP CERAMIC 1PF	131-030-2Y
C258	CHIP CERAMIC 470PF	134-761-4Y	C370	CHIP CERAMIC 0.001UF	130-A17-6Y
C259	CHIP CERAMIC 0.01UF	130-172-2Y	C371	CHIP CERAMIC 0.1UF	130-A60-4Y
C260	CHIP CERAMIC 0.01UF	130-172-2Y	C372	CHIP CERAMIC 0.01UF	130-172-2Y
C261	CHIP CERAMIC 39PF	133-937-2Y	C373	CHIP TANTALUM 3.3UF	143-312-0Z
C262	CHIP CERAMIC 75PF	137-512-1Z	C374	CHIP CERAMIC 0.001UF	130-A17-6Y
C263	CHIP CERAMIC 0.001UF	130-A17-6Y	C375	CHIP CERAMIC 0.001UF	130-A17-6Y
C264	CHIP CERAMIC 0.1UF	130-A60-4Y	C376	CHIP CERAMIC 0.1UF	130-A60-4Y
C265	CHIP CERAMIC 0.001UF	130-A17-6Y	CF101	FILTER CRYSTAL	271-053-6
C266	CHIP CERAMIC 0.001UF	130-A17-6Y	CF103	FILTER CERAMIC	270-007-0Z
C267	CHIP CERAMIC 0.001UF	130-A17-6Y	CF104	FILTER CERAMIC	270-027-8Z
C268	CHIP CERAMIC 22PF	132-225-7Z	D102	DIODE SI CHIP	243-051-5
C271	CHIP CERAMIC 0.001UF	131-025-8Y	D103	DIODE	243-012-0
C272	CHIP CERAMIC 15PF	131-539-6Z	D104	DIODE	243-012-0
C274	CHIP CERAMIC 0.001UF	131-025-8Y	D106	DIODE SI CHIP	243-052-6
C279	ELECT CAPACITOR 10UF	101-025-9	D107	DIODE SCHOTTKY CHIP	249-005-4
C282	CHIP CERAMIC 470PF	134-761-4Y	D108	DIODE CHIP	243-081-2
C285	CHIP CERAMIC 0.001UF	130-A17-6Y	D120	DIODE CHIP	243-087-8
C286	CHIP CERAMIC 0.001UF	130-A17-6Y	D124	DIODE RECTIFIER	245-008-7Z
C287	CHIP CERAMIC 0.001UF	130-A17-6Y	D125	DIODE SI CHIP	243-052-6
C288	CHIP CERAMIC 220PF	132-220-2Y	D126	DIODE SWITCHING	243-063-6
C289	CHIP CERAMIC 82PF	138-210-3Y	D127	DIODE PIN	243-073-5
C290	CHIP CERAMIC 0.047UF	130-424-0Y	D128	DIODE SWITCHING	243-063-6
C292	CHIP CERAMIC 220PF	132-220-2Y	D129	DIODE SI CHIP	243-052-6
C295	CHIP CERAMIC 0.01UF	130-172-2Y	D351	DIODE	243-054-8
C296	CHIP CERAMIC 47PF	134-722-1Y	D352	DIODE	243-054-8
C297	CHIP CERAMIC 47PF	134-722-1Y	D353	DIODE	243-054-8
C298	CHIP CERAMIC 22PF	132-216-9Y	FB101	FERRITE BEAD	320-423-8
C299	CHIP CERAMIC 47PF	134-722-1Y	IC101	I.C PLL	220-131-3
C300	CHIP CERAMIC 470PF	134-761-4Y	IC102	DBM MIXER MODULE	220-375-7
C301	CHIP CERAMIC 220PF	132-220-2Y	IC104	I.C OP AMP	231-064-4
C302	CHIP CERAMIC 0.1UF	130-170-0Y	IC105	I.C REGULATOR	220-378-0
C310	CHIP CERAMIC 30PF	133-010-4Y	IC107	I.C REGULATOR	222-013-0A
C311	CHIP CERAMIC 0.001UF	131-025-8Y	IC108	I.C	229-289-8
C312	CHIP CERAMIC 7PF	137-011-5Y	IC109	I.C POWER FM IF	223-421-0
C313	CHIP CERAMIC 180PF	131-847-4Y	IC113	I.C OP AMP	231-064-4
C314	CHIP CERAMIC 180PF	131-847-4Y	J1	JACK MINIATURE	420-728-5
C315	CHIP CERAMIC 15PF	131-539-6Z	L107	COIL CHIP 1UH	310-657-0
C351	CHIP CERAMIC 0.001UF	130-A17-6Y	L108	COIL CHIP 1.0UH	311-079-3
C352	CHIP CERAMIC 7PF	137-007-1Y	L110	COIL CHIP 47NH	310-861-7
C353	CHIP CERAMIC 9PF	139-003-8Y	L111	COIL CHIP 0.15UH	310-706-1

# MAXON SM-2000 MOBILE

## 650-000-0001 SM-2150/VHF MAIN BOARD

REF #	DESCRIPTION	PART #	REF #	DESCRIPTION	PART #
L113	COIL SPRING	310-794-0	Q127	TRANSISTOR	202-095-8Z
L115	COIL SPRING	310-793-9	Q128	BRT	202-092-5
L116	COIL SPRING	310-224-2	Q130	TRANSISTOR	200-003-5
L117	COIL SPRING	310-368-9	Q132	TRANSISTOR	202-113-1
L118	COIL CHOKE 1K	310-218-7	Q133	TRANSISTOR	202-113-1
L119	COIL CHIP 0.15UH	310-706-1	Q134	TRANSISTOR	202-095-8Z
L120	COIL CHOKE 1K	310-218-7	Q135	TRANSISTOR	202-095-8Z
L121	COIL SPRING	310-275-8	Q137	TRANSISTOR	202-095-8Z
L122	COIL ASS'Y	509-772	Q139	BRT	202-092-5
L123	COIL CHIP 47NH	310-861-7	Q140	TRANSISTOR	202-095-8Z
L124	COIL CHIP 0.68UH	310-711-5	Q219	TRANSISTOR	202-095-8Z
L125	COIL SPRING	310-368-9	Q351	TRANSISTOR	203-116-9
L126	COIL SPRING	310-627-3	Q352	TRANSISTOR	203-116-9
L127	COIL SPRING	311-224-7	Q353	TRANSISTOR	202-099-2Z
L128	COIL SPRING	311-214-8	Q354	TRANSISTOR	202-098-1
L129	COIL SPRING	310-536-4	Q360	TRANSISTOR	202-113-1
L130	COIL SPRING	311-214-8	R100	CHIP RESISTOR 2.2K	060-222-2Z
L131	COIL SPRING	311-214-8	R1001	CHIP RESISTOR 470	060-471-0Z
L132	COIL SPRING	311-305-7	R101	CHIP RESISTOR 1.8K	060-182-9Z
L134	COIL ASS'Y	509-772	R102	CHIP RESISTOR 0	060-000-8Z
L135	COIL ASS'Y	509-013	R103	CHIP RESISTOR 0	060-000-8Z
L225	COIL AXIAL 2.2UH	310-378-7	R104	CHIP RESISTOR 1.8K	060-182-9Z
L226	COIL CHIP 1UH	310-657-0	R105	CHIP RESISTOR 470	060-471-0Z
L227	COIL CHIP 220UH	310-862-8Y	R106	CHIP RESISTOR 1.8K	060-182-9Z
L228	COIL AXIAL 1MH	310-381-0	R107	CHIP RESISTOR 470	060-471-0Z
L229	COIL AXIAL 1MH	310-381-0	R108	CHIP RESISTOR 0	060-000-8Z
L351	COIL CHIP 1.0UH	311-079-3	R110	CHIP RESISTOR 1.2K	060-122-5Z
L352	COIL CHIP 0.82UH	311-078-2	R111	CHIP RESISTOR 2.7K	060-272-7Z
L354	COIL CHIP 2.2UH	311-083-6	R112	CHIP RESISTOR 7.5K	060-752-4Z
L356	COIL CHIP	311-117-4	R113	CHIP RESISTOR 100K	060-104-9Z
L357	COIL CHIP 2.2UH	311-083-6	R114	CHIP RESISTOR 10K	060-103-8Z
L358	COIL CHIP 1.0UH	311-079-3	R116	CHIP RESISTOR 10K	060-103-8Z
Q101	TRANSISTOR	202-113-1	R117	CHIP RESISTOR 24K	060-243-1Z
Q102	TRANSISTOR	202-106-5	R118	CHIP RESISTOR 10K	060-103-8Z
Q103	TRANSISTOR	202-106-5	R119	CHIP RESISTOR 10K	060-103-8Z
Q104	TRANSISTOR	202-113-1	R130	CHIP RESISTOR 1.2K	060-122-5Z
Q105	TRANSISTOR	218-057-7Z	R131	CHIP RESISTOR 91K	060-913-3Z
Q106	TRANSISTOR	203-096-4	R132	CHIP RESISTOR 4.7K	060-472-1Z
Q108	TRANSISTOR	202-095-8Z	R133	CHIP RESISTOR 20K	060-203-5Z
Q113	TRANSISTOR	200-003-5	R134	CHIP RESISTOR 6.8K	060-682-4Z
Q114	TRANSISTOR	200-003-5	R135	CHIP RESISTOR 39	060-390-8Z
Q116	TRANSISTOR	203-181-7	R136	CHIP RESISTOR 2.7K	060-272-7Z
Q117	TRANSISTOR	200-045-3	R137	CHIP RESISTOR 2.7K	060-272-7Z
Q118	TRANSISTOR	203-043-6Z	R138	CHIP RESISTOR 470	060-471-0Z
Q120	TRANSISTOR	203-087-6	R139	CHIP RESISTOR 22K	060-223-3Z
Q121	TRANSISTOR	202-095-8Z	R140	CHIP RESISTOR 10	060-100-5Z
Q122	TRANSISTOR	203-111-4	R141	CHIP RESISTOR 470	060-471-0Z
Q123	TRANSISTOR	202-095-8Z	R142	CHIP RESISTOR 10K	060-103-8Z
Q124	TRANSISTOR	202-113-1	R143	CHIP RESISTOR 1.8K	060-182-9Z
Q125	TRANSISTOR	202-066-2	R144	CHIP RESISTOR 51	060-510-2

# MAXON SM-2000 MOBILE

## 650-000-0001 SM-2150/VHF MAIN BOARD

REF #	DESCRIPTION	PART #	REF #	DESCRIPTION	PART #
R146	CHIP RESISTOR 15K	060-153-3Z	R206	CHIP RESISTOR 2.7K	060-272-7Z
R147	CHIP RESISTOR 560K	060-564-1Z	R207	CHIP RESISTOR 100	060-101-6Z
R148	CHIP RESISTOR 15K	060-153-3Z	R210	CHIP RESISTOR 100	060-101-6Z
R149	CHIP RESISTOR 10	060-100-5Z	R211	CHIP RESISTOR 68K	060-683-5Z
R150	CHIP RESISTOR 560K	060-564-1Z	R213	CHIP RESISTOR 22K	060-223-3Z
R151	CHIP RESISTOR 22K	060-223-3Z	R214	CHIP RESISTOR 22K	060-223-3Z
R152	CHIP RESISTOR 47	060-470-9Z	R215	CHIP RESISTOR 10K	060-103-8Z
R153	CHIP RESISTOR 3.9K	060-392-2Z	R217	CHIP RESISTOR 10K	060-103-8Z
R154	CHIP RESISTOR 2.2	060-229-9Z	R218	CHIP RESISTOR 10K	060-103-8Z
R156	CHIP RESISTOR 6.8K	060-682-4Z	R219	CHIP RESISTOR 39K	060-393-3Z
R157	CHIP RESISTOR 300	060-301-8Z	R220	CHIP RESISTOR 56K	060-563-0Z
R158	CHIP RESISTOR 3.3K	060-332-8Z	R221	CHIP RESISTOR 22K	060-223-3Z
R159	CHIP RESISTOR 4.7	060-479-8Z	R222	CHIP RESISTOR 22K	060-223-3Z
R160	CHIP RESISTOR 22	060-220-0Z	R223	CHIP RESISTOR 2.2K	060-222-2Z
R161	CHIP RESISTOR 1.8K	060-182-9Z	R224	CHIP RESISTOR 0	060-000-8Z
R162	CHIP RESISTOR 6.8	060-689-5Z	R250	CHIP RESISTOR 12K	060-123-6Z
R163	CHIP RESISTOR 47	060-470-9Z	R251	CHIP RESISTOR 2K	060-202-4Z
R164	CHIP RESISTOR 150	060-151-1Z	R252	CHIP RESISTOR 1K	060-102-7Z
R168	CHIP RESISTOR 10K	060-103-8Z	R253	CHIP RESISTOR 1.8K	060-182-9Z
R170	CHIP RESISTOR 470	060-471-0Z	R351	CHIP RESISTOR 10K	060-103-8Z
R172	CHIP RESISTOR 3.3K	060-332-8Z	R352	CHIP RESISTOR 330	060-331-7Z
R173	CHIP RESISTOR 3.3K	060-332-8Z	R353	CHIP RESISTOR 47	060-470-9Z
R174	CHIP RESISTOR 10	060-100-5Z	R354	CHIP RESISTOR 10K	060-103-8Z
R175	FILM RESISTOR 330	030-331-8Z	R355	CHIP RESISTOR 330	060-331-7Z
R176	FILM RESISTOR 120	030-121-5Z	R356	CHIP RESISTOR 47	060-470-9Z
R177	CHIP RESISTOR 1.2K	060-122-5Z	R357	CHIP RESISTOR 1.2K	060-122-5Z
R178	CHIP RESISTOR 1.2K	060-122-5Z	R358	CHIP RESISTOR 10K	060-103-8Z
R180	CHIP RESISTOR 10K	060-103-8Z	RV101	RESISTOR SEMIFIXED 22KB	071-223-1
R181	FILM RESISTOR 120	030-121-5Z	RV102	RESISTOR SEMIFIXED 1KB	071-102-5
R182	CHIP RESISTOR 120	060-121-4Z	RV103	RESISTOR SEMIFIXED 10KB	071-103-6
R182	CHIP RESISTOR 150	060-151-1Z	RV104	RESISTOR SEMIFIXED 10KB	071-103-6
R183	CHIP RESISTOR 470K	060-474-3Z	RV105	RESISTOR SEMIFIXED 4.7KB	071-472-9
R184	CHIP RESISTOR 10	060-100-5Z	T101	COIL IFT 600NH 45MHZ	321-014-7
R185	CHIP RESISTOR 47K	060-473-2Z	T102	COIL IFT 600NH 45MHZ	321-014-7
R187	CHIP RESISTOR 10K	060-103-8Z	T103	COIL 455KHZ DETECTOR	320-232-2
R190	CHIP RESISTOR 22K	060-223-3Z	T104	TRANSFORMER CHOKE	300-008-1
R191	CHIP RESISTOR 2.7K	060-272-7Z	TH101	THERMISTOR CHIP 33K	098-333-8
R192	CHIP RESISTOR 22K	060-223-3Z	X101	CRYSTAL NR2B 44.545M	261-932-7Z
R193	CHIP RESISTOR 2.7K	060-272-7Z			
R194	CHIP RESISTOR 10K	060-103-8Z			
R195	CHIP RESISTOR 18K	060-183-0Z			
R196	CHIP RESISTOR 82K	060-823-5Z			
R197	CHIP RESISTOR 100K	060-104-9Z			
R198	CHIP RESISTOR 1K	060-102-7Z			
R200	CHIP RESISTOR 47K	060-473-2Z			
R201	CHIP RESISTOR 330K	060-334-0Z			
R202	CHIP RESISTOR 2.7K	060-272-7Z			
R203	CHIP RESISTOR 150K	060-154-4Z			
R204	CHIP RESISTOR 1K	060-102-7Z			
R205	CHIP RESISTOR 100	060-101-6Z			

# MAXON SM-2000 MOBILE

## 650-000-0002 SM-2450/UHF MAIN BOARD

### 650-000-0002 SM-2450/UHF MAIN BOARD

#### BAND CHART

<b>SM-2450A UHF BAND 1 (400-430 MHz)</b>			<b>SM-2450C UHF BAND 2 (420-450 MHz)</b>			<b>SM-2450D UHF BAND 3 (440-470 MHz)</b>		
REF #	PART #	VALUE	REF #	PART #	VALUE	REF #	PART #	VALUE
<b>FRONT-END PCB ASSEMBLY 650-110-0007</b>			<b>FRONT-END PCB ASSEMBLY 650-110-0008</b>			<b>FRONT-END PCB ASSEMBLY 650-110-0001</b>		
<b>MAIN BOARD PARTS</b>			<b>MAIN BOARD PARTS</b>			<b>MAIN BOARD PARTS</b>		
<b>C130</b>	133-932-7Y	39pF	<b>C130</b>	133-932-7Y	39pF	<b>C130</b>	132-714-2Y	27pF
<b>C133</b>	131-039-1Y	10pF	<b>C133</b>	138-004-4Y	8pF	<b>C133</b>	136-833-6Y	6.8pF
<b>C134</b>	134-767-0Y	4.7pF	<b>C134</b>	134-767-0Y	4.7pF	<b>C134</b>	134-007-7Y	4pF
<b>C135</b>	139-003-8Y	9pF	<b>C135</b>	138-004-4Y	8pF	<b>C135</b>	138-004-4Y	8pF
<b>C136</b>	139-003-8Y	9pF	<b>C136</b>	138-004-4Y	8pF	<b>C136</b>	131-208-7Y	12pF
<b>C158</b>	131-039-1Y	10pF	<b>C158</b>	135-010-4Y	5pF	<b>C158</b>	135-010-4Y	5pF
<b>C242</b>	131-039-1Y	10pF	<b>C242</b>	138-004-4Y	8pF	<b>C242</b>	138-004-4Y	8pF
<b>C243</b>	131-039-1Y	10pF	<b>C243</b>	134-767-0Y	4.7pF	<b>C243</b>	134-767-0Y	4.7pF
<b>C272</b>	136-015-4Y	6pF	<b>C272</b>	135-019-3Y	5pF	<b>C272</b>	135-019-3Y	5pF
<b>C273</b>	131-029-2Y	10PF	<b>C273</b>	131-029-2Y	10PF	<b>C273</b>	137-011-5Y	7PF
<b>C275</b>	131-029-2Y	10PF	<b>C275</b>	131-029-2Y	10PF	<b>C275</b>	139-006-1Y	9PF
<b>C277</b>	131-029-2Y	10PF	<b>C277</b>	131-029-2Y	10PF	<b>C277</b>	131-029-2Y	10PF
<b>C281</b>	131-039-1Y	10pF	<b>C281</b>	137-007-1Y	7pF	<b>C281</b>	137-007-1Y	7pF
<b>C283</b>	137-011-5Y	7pF	<b>C283</b>	136-015-4Y	6pF	<b>C283</b>	136-015-4Y	6pF
<b>IC103</b>	220-347-2	M57729L	<b>IC103</b>	220-348-3	M57729	<b>IC103</b>	220-350-5	M57729H
<b>R180</b>	060-472-1Z	4.7K	<b>R180</b>	060-472-1Z	4.7K	<b>R180</b>	060-392-2Z	3.9K
<b>R182</b>	060-221-1Z	220 OHM	<b>R182</b>	060-221-1Z	220 OHM	<b>R182</b>	060-101-6Z	100 OHM
<b>R210</b>	060-470-9Z	47 OHM	<b>R210</b>	060-470-9Z	47 OHM	<b>R210</b>	060-470-9Z	47 OHM

# MAXON SM-2000 MOBILE

## 650-000-0002 SM-2450/UHF MAIN BOARD

### BAND CHART(continued)

<b>SM-2450E UHF BAND 4</b>			<b>SM-2450B UHF BAND 5</b>		
<b>(470-490 MHz)</b>			<b>(490-512 MHz)</b>		
<b>REF #</b>	<b>PART #</b>	<b>VALUE</b>	<b>REF #</b>	<b>PART #</b>	<b>VALUE</b>
<b>FRONT-END PCB ASSEMBLY</b>			<b>FRONT-END PCB ASSEMBLY</b>		
650-110-0009			650-110-0010		
<b>MAIN BOARD PARTS</b>			<b>MAIN BOARD PARTS</b>		
<b>C130</b>	131-829-8Y	18pF	<b>C130</b>	132-407-5Y	24pF
<b>C133</b>	136-015-4Y	6pF	<b>C133</b>	134-007-7Y	4pF
<b>C134</b>	133-321-5Y	3.3pF	<b>C134</b>	133-321-5Y	3.3pF
<b>C135</b>	135-019-3Y	5pF	<b>C135</b>	135-019-3Y	5pF
<b>C136</b>	137-007-1Y	7pF	<b>C136</b>	138-004-4Y	8pF
<b>C158</b>	133-321-5Y	3.3pF	<b>C158</b>	134-007-7Y	4pF
<b>C242</b>	137-007-1Y	7pF	<b>C242</b>	135-019-3Y	5pF
<b>C243</b>	133-321-5Y	3.3pF	<b>C243</b>	133-321-5Y	3.3pF
<b>C272</b>	134-007-7Y	4pF	<b>C272</b>	135-019-3Y	5pF
<b>C273</b>	137-011-5Y	7PF	<b>C273</b>	131-029-2Y	10PF
<b>C275</b>	139-006-1Y	9PF	<b>C275</b>	131-029-2Y	10PF
<b>C277</b>	138-230-1Y	8PF	<b>C277</b>	131-029-2Y	10PF
<b>C281</b>	131-039-1Y	10pF	<b>C281</b>	131-039-1Y	10pF
<b>C283</b>	135-019-3Y	5pF	<b>C283</b>	134-007-7Y	4pF
<b>IC103</b>	220-349-4	M57729UH	<b>IC103</b>	220-346-1	M57729SH
<b>R180</b>	060-272-7Z	2.7K	<b>R180</b>	060-472-1Z	4.7K
<b>R182</b>	060-101-6Z	100 OHM	<b>R182</b>	060-221-1Z	220 OHM
<b>R210</b>	060-470-9Z	47 OHM	<b>R210</b>	060-470-9Z	47 OHM

# MAXON SM-2000 MOBILE

## 650-000-0002 SM-2450/UHF MAIN BOARD

REF #	DESCRIPTION	PART #	REF #	DESCRIPTION	PART #
<b>FRONT-END PCB ASSEMBLY (REFER TO BAND CHART)</b>			<b>C163</b>	CHIP CERAMIC 6PF	136-005-5Y
<b>ANT1</b>	CONNECTOR ANT	422-907-0	<b>C164</b>	CHIP CERAMIC 12PF	131-208-7Y
<b>ANT1</b>	CONNECTOR SW-1456(BNC-R)	421-655-7	<b>C165</b>	CHIP CERAMIC 6PF	136-005-5Y
<b>ANT1</b>	PIN CU &1.1X13(101-01)	860-129	<b>C167</b>	CHIP CERAMIC 82PF	138-210-3Y
<b>C101</b>	CHIP CERAMIC 220PF	132-220-2Y	<b>C168</b>	CHIP CERAMIC 0.001UF	130-A17-6Y
<b>C102</b>	CHIP CERAMIC 220PF	132-220-2Y	<b>C169</b>	CHIP CERAMIC 47PF	134-722-1Y
<b>C103</b>	CHIP CERAMIC 220PF	132-220-2Y	<b>C172</b>	CHIP CERAMIC 15PF	131-511-0Y
<b>C104</b>	CHIP CERAMIC 220PF	132-220-2Y	<b>C173</b>	CHIP CERAMIC 56PF	135-613-9Y
<b>C105</b>	CHIP CERAMIC 5PF	135-010-4Y	<b>C174</b>	CHIP CERAMIC 3.3PF	133-321-5Y
<b>C106</b>	CHIP CERAMIC 470PF	134-761-4Y	<b>C175</b>	CHIP CERAMIC 20PF	132-012-1Y
<b>C107</b>	CHIP CERAMIC 0.1UF	130-170-0Y	<b>C176</b>	CHIP CERAMIC 39PF	133-932-7Y
<b>C108</b>	CHIP CERAMIC 220PF	132-220-2Y	<b>C177</b>	CHIP CERAMIC 0.001UF	130-A17-6Y
<b>C109</b>	CHIP CERAMIC 220PF	132-220-2Y	<b>C178</b>	CHIP CERAMIC 0.001UF	130-A17-6Y
<b>C110</b>	CHIP CERAMIC 0.001UF	130-A17-6Y	<b>C179</b>	CHIP CERAMIC 82PF	138-210-3Y
<b>C113A</b>	POLY CAPACITOR 0.33UF	120-313-6	<b>C180</b>	CHIP CERAMIC 0.01UF	130-172-2Y
<b>C114</b>	MYLAR CAPACITOR 0.01UF	111-008-7Z	<b>C181</b>	DIP TANTALUM 10UF	141-012-9Z
<b>C115</b>	CHIP CERAMIC 220PF	132-220-2Y	<b>C182</b>	CHIP CERAMIC 0.001UF	130-A17-6Y
<b>C118</b>	CHIP CERAMIC 4.7PF	134-767-0Y	<b>C183</b>	CHIP CERAMIC 47PF	134-722-1Y
<b>C119</b>	CHIP CERAMIC 15PF	131-511-0Y	<b>C184</b>	CHIP CERAMIC 30PF	133-010-4Y
<b>C120</b>	MYLAR CAPACITOR 0.01UF	111-008-7Z	<b>C185</b>	CHIP CERAMIC 15PF	131-511-0Y
<b>C121</b>	CHIP CERAMIC 220PF	132-220-2Y	<b>C186</b>	CHIP CERAMIC 0.1UF	130-A60-4Y
<b>C122</b>	CHIP CERAMIC 0.1UF	130-170-0Y	<b>C187</b>	CHIP CERAMIC 0.1UF	130-A60-4Y
<b>C125</b>	CHIP TANTALUM 1UF	141-036-1Z	<b>C188</b>	CHIP CERAMIC 220PF	132-220-2Y
<b>C126</b>	CHIP CERAMIC 220PF	132-220-2Y	<b>C189</b>	CHIP CERAMIC 0.1UF	130-170-0Y
<b>C127</b>	CHIP CERAMIC 470PF	134-761-4Y	<b>C190</b>	CHIP CERAMIC 0.033UF	130-314-5Y
<b>C128</b>	CHIP CERAMIC 0.001UF	130-A17-6Y	<b>C191</b>	CHIP CERAMIC 0.1UF	130-A60-4Y
<b>C129</b>	CHIP CERAMIC 0.1UF	130-170-0Y	<b>C192</b>	CHIP CERAMIC 0.033UF	130-314-5Y
<b>C131</b>	CHIP CERAMIC 220PF	132-220-2Y	<b>C193</b>	CHIP CERAMIC 0.1UF	130-A60-4Y
<b>C137</b>	CHIP CERAMIC 68PF	136-816-5Y	<b>C194</b>	CHIP CERAMIC 0.0033UF	130-315-6Y
<b>C138</b>	CHIP CERAMIC 2.2PF	132-266-4Y	<b>C195</b>	CHIP CERAMIC 10PF	131-039-1Y
<b>C139</b>	CHIP CERAMIC 220PF	132-220-2Y	<b>C196</b>	CHIP CERAMIC 0.01UF	130-172-2Y
<b>C140</b>	CHIP CERAMIC 47PF	134-722-1Y	<b>C197</b>	CHIP CERAMIC 47PF	134-722-1Y
<b>C141</b>	CHIP CERAMIC 5PF	135-010-4Y	<b>C198</b>	CHIP CERAMIC 0.001UF	130-A17-6Y
<b>C142</b>	CHIP CERAMIC 12PF	131-208-7Y	<b>C199</b>	CHIP CERAMIC 12PF	131-208-7Y
<b>C143</b>	CHIP CERAMIC 220PF	132-220-2Y	<b>C200</b>	CHIP CERAMIC 0.1UF	130-A60-4Y
<b>C144</b>	CHIP CERAMIC 0.5PF	130-504-9Y	<b>C201</b>	CHIP CERAMIC 0.01UF	130-172-2Y
<b>C145</b>	CHIP CERAMIC 0.001UF	130-A17-6Y	<b>C202</b>	CHIP CERAMIC 0.01UF	130-172-2Y
<b>C146</b>	CHIP CERAMIC 12PF	131-208-7Y	<b>C203</b>	CHIP CERAMIC 0.001UF	130-A17-6Y
<b>C147</b>	ELECT CAPACITOR 47UF	104-713-2	<b>C204</b>	CHIP CERAMIC 6PF	136-005-5Y
<b>C148</b>	CHIP CERAMIC 220PF	132-220-2Y	<b>C207</b>	CHIP CERAMIC 0.001UF	130-A17-6Y
<b>C149</b>	CHIP CERAMIC 220PF	132-220-2Y	<b>C209</b>	CHIP CERAMIC 0.1UF	130-A60-4Y
<b>C150</b>	CHIP CERAMIC 220PF	132-220-2Y	<b>C210</b>	MYLAR CAPACITOR 0.022UF	112-211-8Z
<b>C151</b>	CHIP CERAMIC 470PF	134-761-4Y	<b>C211</b>	CHIP CERAMIC 0.01UF	130-172-2Y
<b>C152</b>	ELECT CAPACITOR 2200UF	102-278-6	<b>C212</b>	CHIP CERAMIC 0.01UF	130-172-2Y
<b>C155</b>	CHIP CERAMIC 2.2PF	132-266-4Y	<b>C214</b>	CHIP CERAMIC 220PF	132-220-2Y
<b>C156</b>	CHIP CERAMIC 47PF	134-722-1Y	<b>C216</b>	CHIP CERAMIC 220PF	132-220-2Y
<b>C157</b>	CHIP CERAMIC 5.6PF	135-627-2Y	<b>C217</b>	CHIP CERAMIC 220PF	132-220-2Y
<b>C159</b>	CHIP CERAMIC 6PF	136-005-5Y	<b>C218</b>	ELECT CAPACITOR 10UF	101-025-9
<b>C160</b>	CHIP CERAMIC 0.001UF	130-A17-6Y	<b>C218</b>	ELECT CAPACITOR 10UF	101-025-9
<b>C162</b>	CHIP CERAMIC 3.3PF	133-321-5Y	<b>C219</b>	CHIP CERAMIC 220PF	132-220-2Y



# MAXON SM-2000 MOBILE

## 650-000-0002 SM-2450/UHF MAIN BOARD

REF #	DESCRIPTION	PART #	REF #	DESCRIPTION	PART #
C219	CHIP CERAMIC 220PF	132-220-2Y	C288	CHIP CERAMIC 220PF	132-220-2Y
C220	CHIP CERAMIC 220PF	132-220-2Y	C289	CHIP CERAMIC 82PF	138-210-3Y
C221	DIP TANTALUM 1UF	141-008-6Z	C290	CHIP CERAMIC 0.047UF	130-424-0Y
C222	DIP TANTALUM 10UF	141-012-9Z	C292	CHIP CERAMIC 220PF	132-220-2Y
C223	CHIP CERAMIC 220PF	132-220-2Y	C294	CHIP CERAMIC 220PF	132-220-2Y
C224	ELECT CAPACITOR 1000UF	101-A02-8	C295	CHIP CERAMIC 0.01UF	130-172-2Y
C225	CHIP CERAMIC 0.1UF	130-A60-4Y	C296	CHIP CERAMIC 47PF	134-722-1Y
C226	ELECT CAPACITOR 1000UF	101-048-0	C297	CHIP CERAMIC 12PF	131-208-7Y
C227	CHIP CERAMIC 0.001UF	130-A17-6Y	C298	CHIP CERAMIC 22PF	132-216-9Y
C230	CHIP CERAMIC 0.001UF	130-A17-6Y	C299	CHIP CERAMIC 47PF	134-722-1Y
C231	CHIP CERAMIC 220PF	132-220-2Y	C300	CHIP CERAMIC 470PF	134-761-4Y
C232	ELECT CAPACITOR 100UF	101-023-7	C301	CHIP CERAMIC 220PF	132-220-2Y
C233	ELECT CAPACITOR 220UF	102-224-7	C303	CHIP CERAMIC 220PF	132-220-2Y
C234	CHIP CERAMIC 220PF	132-220-2Y	C407	ELECT CAPACITOR 10UF	101-025-9
C235	CHIP CERAMIC 0.001UF	130-A17-6Y	C435	ELECT CAPACITOR 1UF	101-006-2
C236	CHIP CERAMIC 220PF	132-220-2Y	C438	ELECT CAPACITOR 10UF	101-025-9
C237	CHIP CERAMIC 0.001UF	130-A17-6Y	C558	ELECT CAPACITOR 10UF	101-025-9
C238	ELECT CAPACITOR 2200UF	102-278-6	CABLE1	COAXIAL UT85 SEMI-RIGID	427-335-8
C239	ELECT CAPACITOR 10UF	101-025-9	CF1	FEED THROUGH CAP 0.001UF	181-005-5
C240	CHIP CERAMIC 10PF	131-039-1Y	CF101	FILTER CRYSTAL	271-054-7
C247	CHIP CERAMIC 470PF	134-761-4Y	CF103	FILTER CERAMIC	270-007-0Z
C249	CHIP CERAMIC 220PF	132-220-2Y	CF104	FILTER CERAMIC	270-027-8Z
C250	ELECT CAPACITOR 47UF	104-713-2	CON405	CONNECTOR BOX SOCKET	421-677-7
C251	CHIP CERAMIC 470PF	134-761-4Y	D101	DIODE VARICAP CHIP	242-022-4
C252	CHIP CERAMIC 220PF	132-220-2Y	D102	DIODE VARICAP CHIP	242-022-4
C253	CHIP CERAMIC 33PF	133-306-2Y	D103	DIODE	243-012-0
C255	CHIP CERAMIC 470PF	134-761-4Y	D104	DIODE	243-012-0
C256	CHIP CERAMIC 220PF	132-220-2Y	D105	DIODE SI CHIP	243-051-5
C257	CHIP CERAMIC 0.001UF	130-A17-6Y	D106	DIODE SI CHIP	243-052-6
C258	CHIP CERAMIC 220PF	132-220-2Y	D107	DIODE SCHOTTKY CHIP	249-005-4
C259	CHIP CERAMIC 220PF	132-220-2Y	D108	DIODE PIN	243-081-2
C260	CHIP CERAMIC 0.001UF	130-A17-6Y	D120	DIODE	243-058-2
C261	CHIP CERAMIC 220PF	132-220-2Y	D121	DIODE	243-012-0
C262	CHIP CERAMIC 0.001UF	130-A17-6Y	D124	DIODE RECTIFIER	245-008-7Z
C263	CHIP CERAMIC 0.001UF	131-025-8Y	D125	DIODE SI CHIP	243-052-6
C264	CHIP CERAMIC 220PF	132-220-2Y	D126	DIODE SWITCHING	243-063-6
C265	CHIP CERAMIC 220PF	132-220-2Y	D127	DIODE PIN	243-073-5
C266	CHIP CERAMIC 220PF	132-220-2Y	D128	DIODE SWITCHING	243-063-6
C267	CHIP CERAMIC 220PF	132-220-2Y	D129	DIODE SI CHIP	243-052-6
C269	CHIP CERAMIC 4PF	134-007-7Y	FB	CORE BEAD	320-536-5
C271	CHIP CERAMIC 0.001UF	131-025-8Y	IC101	I.C PLL	220-131-3
C273	CHIP CERAMIC 10PF	131-029-2Y	IC102	DBM MIXER MODULE	220-375-7
C279	ELECT CAPACITOR 47UF	104-713-2	IC104	I.C OP AMP	231-064-4
C280	CHIP CERAMIC 5PF	135-019-3Y	IC105	I.C REGULATOR	220-378-0
C282	CHIP CERAMIC 470PF	134-761-4Y	IC107	I.C REGULATOR	222-013-0A
C284	CHIP CERAMIC 470PF	134-761-4Y	IC108	I.C	229-289-8
C285	CHIP CERAMIC 220PF	132-220-2Y	IC109	I.C POWER FM IF	223-421-0
C286	CHIP CERAMIC 220PF	132-220-2Y	IC401	I.C	223-224-9
C287	CHIP CERAMIC 220PF	132-220-2Y	J1	JACK MINIATURE	420-728-5

# MAXON SM-2000 MOBILE

## 650-000-0002 SM-2450/UHF MAIN BOARD

REF #	DESCRIPTION	PART #	REF #	DESCRIPTION	PART #
L101	COIL CHIP 0.68UH	310-711-5	Q132	TRANSISTOR	202-113-1
L102	COIL CHIP 0.68UH	310-711-5	Q133	TRANSISTOR	202-113-1
L103	COIL CHIP 47NH	310-861-7	Q134	TRANSISTOR	202-095-8Z
L104	COIL CHIP 27NH	310-860-6	Q135	TRANSISTOR	202-095-8Z
L106	COIL CHIP 27NH	310-860-6	Q137	TRANSISTOR	202-095-8Z
L107	COIL SPRING	310-304-1	Q140	TRANSISTOR	202-095-8Z
L108	COIL CHIP 18NH	310-859-6	Q219	TRANSISTOR	202-095-8Z
L110	COIL CHIP 18NH	310-859-6	R100	CHIP RESISTOR 2.2K	060-222-2Z
L111	COIL CHIP 0.15UH	310-706-1	R101	CHIP RESISTOR 1.8K	060-182-9Z
L113	COIL SPRING	311-158-1	R102	CHIP RESISTOR 0	060-000-8Z
L114	COIL CHIP 0.15UH	310-706-1	R103	CHIP RESISTOR 0	060-000-8Z
L115	COIL SPRING	311-158-1	R104	CHIP RESISTOR 910	060-911-1Z
L116	COIL SPRING	311-178-9	R105	CHIP RESISTOR 100	060-101-6Z
L118	COIL SPRING	311-180-1	R106	CHIP RESISTOR 910	060-911-1Z
L119	COIL CHIP 0.15UH	310-706-1	R107	CHIP RESISTOR 100	060-101-6Z
L120	COIL SPRING	311-180-1	R108	CHIP RESISTOR 0	060-000-8Z
L121	COIL SPRING	311-180-1	R109	CHIP RESISTOR 10K	060-103-8Z
L122	COIL SPRING	311-179-0	R110	CHIP RESISTOR 3K	060-302-1Z
L123	COIL CHIP 18NH	310-859-6	R111	CHIP RESISTOR 2.7K	060-272-7Z
L124	COIL CHIP 18NH	310-859-6	R112	CHIP RESISTOR 2.7K	060-272-7Z
L125	COIL SPRING	311-180-1	R113	CHIP RESISTOR 100K	060-104-9Z
L225	COIL AXIAL 2.2UH	310-378-7	R114	CHIP RESISTOR 10K	060-103-8Z
L226	COIL CHIP 1UH	310-657-0	R115	CHIP RESISTOR 100	060-101-6Z
L227	COIL CHIP 220UH	310-862-8Y	R116	CHIP RESISTOR 22	060-220-0Z
L228	COIL AXIAL 1MH	310-381-0	R117	CHIP RESISTOR 5.6K	060-562-9Z
L229	COIL AXIAL 1MH	310-381-0	R118	CHIP RESISTOR 3.3K	060-332-8Z
Q101	TRANSISTOR	202-113-1	R119	CHIP RESISTOR 100	060-101-6Z
Q102	TRANSISTOR	202-106-5	R120	CHIP RESISTOR 47	060-470-9Z
Q103	TRANSISTOR	202-106-5	R121	CHIP RESISTOR 10	060-100-5Z
Q104	TRANSISTOR	202-113-1	R122	CHIP RESISTOR 150	060-151-1Z
Q105	TRANSISTOR	218-057-7Z	R123	CHIP RESISTOR 6.8K	060-682-4Z
Q106	TRANSISTOR	203-096-4	R124	CHIP RESISTOR 10	060-100-5Z
Q107	TRANSISTOR	202-113-1	R125	CHIP RESISTOR 220	060-221-1Z
Q108	TRANSISTOR	203-104-8	R126	CHIP RESISTOR 12K	060-123-6Z
Q110	TRANSISTOR	200-003-5	R127	CHIP RESISTOR 3.9K	060-392-2Z
Q111	TRANSISTOR	200-003-5	R128	CHIP RESISTOR 1.2K	060-122-5Z
Q113	TRANSISTOR	200-003-5	R130	CHIP RESISTOR 270K	060-274-9Z
Q114	TRANSISTOR	200-003-5	R131	CHIP RESISTOR 1.2K	060-122-5Z
Q116	TRANSISTOR	200-003-5	R132	CHIP RESISTOR 7.5K	060-752-4Z
Q117	TRANSISTOR	200-045-3	R133	CHIP RESISTOR 12K	060-123-6Z
Q119	BRT	202-092-5	R134	CHIP RESISTOR 3.9K	060-392-2Z
Q121	TRANSISTOR	202-095-8Z	R135	CHIP RESISTOR 1.2K	060-122-5Z
Q122	TRANSISTOR	203-111-4	R136	CHIP RESISTOR 2.7K	060-272-7Z
Q123	TRANSISTOR	202-095-8Z	R137	CHIP RESISTOR 2.7K	060-272-7Z
Q124	TRANSISTOR	202-113-1	R138	CHIP RESISTOR 470	060-471-0Z
Q125	TRANSISTOR	202-066-2	R139	CHIP RESISTOR 22K	060-223-3Z
Q127	TRANSISTOR	202-095-8Z	R140	CHIP RESISTOR 10	060-100-5Z
Q128	BRT	202-092-5	R141	CHIP RESISTOR 470	060-471-0Z
Q130	TRANSISTOR	200-003-5	R142	CHIP RESISTOR 10K	060-103-8Z

# MAXON SM-2000 MOBILE

## 650-000-0002 SM-2450/UHF MAIN BOARD

REF #	DESCRIPTION	PART #	REF #	DESCRIPTION	PART #
R140	CHIP RESISTOR 10	060-100-5Z	R202	CHIP RESISTOR 2.7K	060-272-7Z
R141	CHIP RESISTOR 470	060-471-0Z	R203	CHIP RESISTOR 150K	060-154-4Z
R142	CHIP RESISTOR 10K	060-103-8Z	R204	CHIP RESISTOR 1K	060-102-7Z
R143	CHIP RESISTOR 1.8K	060-182-9Z	R205	CHIP RESISTOR 100	060-101-6Z
R144	CHIP RESISTOR 51	060-510-2	R206	CHIP RESISTOR 2.7K	060-272-7Z
R146	CHIP RESISTOR 15K	060-153-3Z	R207	CHIP RESISTOR 100	060-101-6Z
R147	CHIP RESISTOR 560K	060-564-1Z	R211	CHIP RESISTOR 68K	060-683-5Z
R148	CHIP RESISTOR 15K	060-153-3Z	R213	CHIP RESISTOR 22K	060-223-3Z
R149	CHIP RESISTOR 10	060-100-5Z	R214	CHIP RESISTOR 22K	060-223-3Z
R150	CHIP RESISTOR 560K	060-564-1Z	R215	CHIP RESISTOR 10K	060-103-8Z
R151	CHIP RESISTOR 22K	060-223-3Z	R217	CHIP RESISTOR 10K	060-103-8Z
R152	CHIP RESISTOR 47	060-470-9Z	R218	CHIP RESISTOR 10K	060-103-8Z
R153	CHIP RESISTOR 3.9K	060-392-2Z	R219	CHIP RESISTOR 39K	060-393-3Z
R154	CHIP RESISTOR 2.2	060-229-9Z	R220	CHIP RESISTOR 56K	060-563-0Z
R156	CHIP RESISTOR 15K	060-153-3Z	R221	CHIP RESISTOR 22K	060-223-3Z
R157	CHIP RESISTOR 300	060-301-8Z	R222	CHIP RESISTOR 22K	060-223-3Z
R158	CHIP RESISTOR 10K	060-103-8Z	R223	CHIP RESISTOR 2.2K	060-222-2Z
R159	CHIP RESISTOR 68	060-680-2Z	R225	CHIP RESISTOR 470	060-471-0Z
R160	CHIP RESISTOR 10	060-100-5Z	R250	CHIP RESISTOR 12K	060-123-6Z
R161	CHIP RESISTOR 560	060-561-8Z	R251	CHIP RESISTOR 2K	060-202-4Z
R162	CHIP RESISTOR 2.2K	060-222-2Z	R252	CHIP RESISTOR 1K	060-102-7Z
R163	CHIP RESISTOR 470	060-471-0Z	R253	CHIP RESISTOR 1.8K	060-182-9Z
R164	CHIP RESISTOR 10	060-100-5Z	R458	CHIP RESISTOR 47K	060-473-2Z
R165	CHIP RESISTOR 470	060-471-0Z	R601	CHIP RESISTOR 56K	05B-563-7Z
R166	CHIP RESISTOR 0	060-000-8Z	R602	CHIP RESISTOR 100	05B-101-3Z
R168	CHIP RESISTOR 10K	060-103-8Z	RV101	RESISTOR SEMIFIXED 22KB	071-223-1
R170	CHIP RESISTOR 470	060-471-0Z	RV102	RESISTOR SEMIFIXED 1KB	071-102-5
R172	CHIP RESISTOR 3.3K	060-332-8Z	RV103	RESISTOR SEMIFIXED 10KB	071-103-6
R173	CHIP RESISTOR 3.3K	060-332-8Z	RV104	RESISTOR SEMIFIXED 10KB	071-103-6
R175	FILM RESISTOR 330	030-331-8Z	RV105	RESISTOR SEMIFIXED 4.7KB	071-472-9
R176	FILM RESISTOR 120	030-121-5Z	T101	COIL IFT 600NH 45MHZ	321-014-7
R177	CHIP RESISTOR 1.2K	060-122-5Z	T102	COIL IFT 600NH 45MHZ	321-014-7
R178	CHIP RESISTOR 1.2K	060-122-5Z	T103	COIL 455KHZ DETECTOR	320-232-2
R181	FILM RESISTOR 120	030-121-5Z	T104	TRANSFORMER CHOKE	300-008-1
R183	CHIP RESISTOR 470K	060-474-3Z	TC101	DIP TRIMMER 10PF	171-013-9
R184	CHIP RESISTOR 10	060-100-5Z	TH101	THERMISTOR CHIP 33K	098-333-8
R185	CHIP RESISTOR 47K	060-473-2Z	TP1	PIN CU	860-129
R187	CHIP RESISTOR 10K	060-103-8Z	X101	CRYSTAL	261-932-7Z
R190	CHIP RESISTOR 22K	060-223-3Z		P.C.B. MAIN (SM-2450)	406-194-C
R191	CHIP RESISTOR 2.7K	060-272-7Z			
R192	CHIP RESISTOR 22K	060-223-3Z			
R193	CHIP RESISTOR 2.7K	060-272-7Z			
R194	CHIP RESISTOR 10K	060-103-8Z			
R195	CHIP RESISTOR 18K	060-183-0Z			
R196	CHIP RESISTOR 82K	060-823-5Z			
R197	CHIP RESISTOR 100K	060-104-9Z			
R198	CHIP RESISTOR 1K	060-102-7Z			
R200	CHIP RESISTOR 47K	060-473-2Z			
R201	CHIP RESISTOR 330K	060-334-0Z			

# MAXON SM-2000 MOBILE



## COMPONENT PINOUT

### COMPONENT PINOUT

\* = SM-2150/VHF

Unless otherwise indicated all parts are common to the SM-2000 Series Radio.

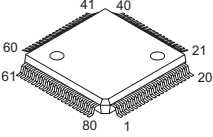
\*\* = SM-2450/UHF

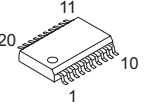
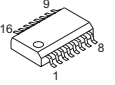
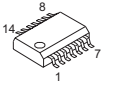
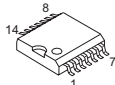
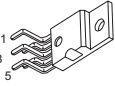
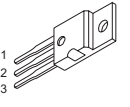
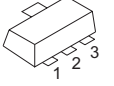
BASE DIAGRAM	MANUFACTURER'S PART NUMBER	REFERENCE NO.	TYPE
	HD4074818	IC409	CPU
	LM358M	IC104, IC105	OP Amp
	AT93C56-10S1	IC408	EEPROM
	MC14519IF	IC101	PLL
	MC14053	IC411,412	Analog SW IC
	MC14066	IC401	Analog SW IC
	MC3371D	IC109	IF IC
	KIA324F	IC404,406,410	OP Amp
	MF6CWM-100	IC407	Switched Cap Filter
	TDA2003V	IC108	Audio AMP
 <p>1:IN 2:GND 3:OUT</p>	KIA7808PI	IC107	Regulator
 <p>1:OUT 2:GND 3:IN</p>	KIA78L05F	IC105,402	Regulator

# MAXON SM-2000 MOBILE COMPONENT PINOUT

\* = SM-2150/VHF

Unless otherwise indicated all parts are common to the SM-2000 Series Radio.

\*\* = SM-2450/UHF

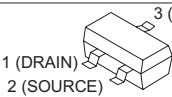
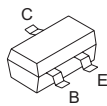
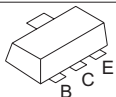
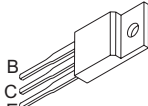
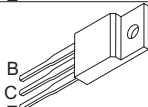
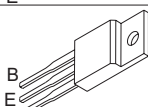
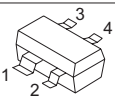
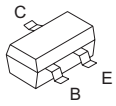
BASE DIAGRAM	MANUFACTURER'S PART NUMBER	REFERENCE NO.
	MMBFJ309LT1	*Q351,*352
	KTA1504S(ASG)	Q102,103,504,821,822
	BCX-18LT1	*Q122
	MMBC1321(Q4)	**Q130
	MMBC1321	*Q106
	KTC3875S(ALG)	Q101,104,360,550-553
	KRA110S(PK)	**Q119,*139,128
	KRC111S	*Q353
	KRA104S	*Q105,*407
	MMBR951	*Q116
KRC104S(ND)	Q121,123,127,131,134,135 Q137,140,219,401-406,409 *Q108,*Q354, **Q105,**Q407	
	BFG35	Q117
	KTB1367	**Q125,135
	KTA1658	*Q125
	C1971	*Q118
	MRF5711	**Q108
	BFR92A	Q113,114, *Q130, **Q110,**Q111,**Q116
	MMBR951	*Q800
	2SC5084	**Q601
	MMBR9426	Q701,702

# MAXON SM-2000 MOBILE

## COMPONENT PINOUT

\* = SM-2150/VHF

Unless otherwise indicated all parts are common to the SM-2000 Series Radio.

\*\* = SM-2450/UHF

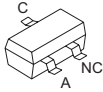
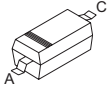
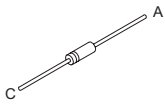
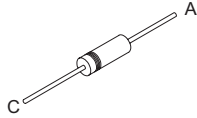
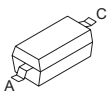
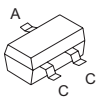
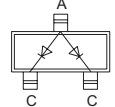
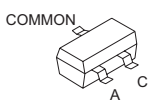
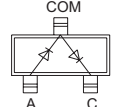
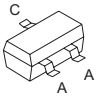
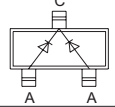
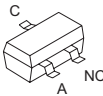
BASE DIAGRAM	MANUFACTURER'S PART NUMBER	REFERENCE NO.	Schematic
	MMBV3401(4D)	D103-105,121	
	KRS193S(F3)	D106,125,129,801,803 D805	
	1SS241(TY)	D127	ZENER
	BZX84C-5V	D807,808,810,811	
	MI402	**D108	
	MI301	**D120	
	IN5404	D124	
	1SV229	D101,102	Varicap Diode
	KDS181(A3)	D402,*126,*128	Diode Switching 
	KDS226(C3)	D551,552 *D800 **D601	
	KDS184S(B3)	D401	
	MMBV105	D701	
	MMBD101	D107	
	MMBD101	D702	

# MAXON SM-2000 MOBILE VOLTAGE CHARTS (SM-2150/VHF)

## VOLTAGE CHARTS (SM-2150/VHF)

IC409								
PIN	DESCRIPTION	TX	RX		PIN	DESCRIPTION	TX	RX
1	DATA	0	0		21	CH-4		
2	EEPROM ENABLE	0	0		22	CH-8		
3	PLL ENABLE	5	5		23	MONITOR	5	5/0
4	CHANNEL SPACING	5/0	5/0		24	PTT	0	3.9
5	DATA IN	0	0		25	PROG. ENABLE	5	5
6	RED L.E.D.	5	0		26	TX ENABLE	5	0
7	BUSY	5/0	0		27	ALERT TONE	0	0
8	EXT OPTION	5	5		28	MF6 CLK	CL	CL
9	HOOK SW	0/3.7	0/3.7		29	CALL DETECT	0	0
10	LOCK DET	0	0		30	SEND UP CONTROL	0	0
11	TEST	5	5		72	GND	0	0
12	X1	5	5		73	VCC	5	5
13	X2 (OPEN)	0	0		74	OSC1	2.3	2.3
14	GND	0	0		75	OSC2	2.3	2.3
15	D TO A	5/0	0		76	RESET	0	0
16	D TO A	5/0	0		77	AUDIO ENABLE	5	5/0
17	TONE ENABLE	5/0	0		78	GREEN L.E.D.	0	5
18	D TO A	5/0	0		79	RX ENABLE	0	5
19	CH-1				80	CLK		
20	CH-2							

IC411									
PIN	1	2	3	4	5	6	7	8	
RX VOLTAGE	0	4	1.9	1.9	0	0	0	0	0
TX VOLTAGE	0	1.2	1.9	2.75	2.75	0	0	2	2
PIN	9	10	11	12	13	14	15	16	
RX VOLTAGE	5	5	0	1.9	3.7	1.9	0.5	5	5
TX VOLTAGE	0	0	0	1.9	4	1.9	1.2	5	5

IC412			
PIN	TX	RX	PROGRAM
1		0	0
2		0	0
3	3.7	3.7	0
4	3.7	3.7	0
5		0	0
6		GND	GND
7		GND	GND
8		GND	GND
9		5	0
10		5	0
11		5	0
12		0	0
13	0	3.8	3.6
14	0	3.8	3.6
15	0	0	0
16		5	5

IC401		
PIN	TX	RX
1	0	0
2	0	0
3	2	1.8
4	2	2
5	5	0
6	0	0
7	0	0
8	SAT 1.9	2
9	SAT 1.9	2
10	0	0
11	0	0
12	0	5
13	5	5
14	5	5

# MAXON SM-2000 MOBILE

## VOLTAGE CHARTS (SM-2150/VHF)

IC404		
PIN	TX UNMODE	RX MODE
1	1.9	VOICE 1.9
2	1.9	VOICE 1.9
3	1.9	VOICE 1.9
4	5	5
5	1.9	VOICE 1.9
6	1.9	VOICE 1.9
7	1.9	VOICE 1.9
8	1.9	VOICE 1.9
9	1.9	VOICE 1.9
10	1.9	VOICE 1.9
11	GND	GND
12	1.9	VOICE 1.9
13	1.9	VOICE 1.9
14	1.9	VOICE 1.9

IC405		
PIN	TX	RX
1	1.93	2.00
2	1.93	2.00
3	1.8	2.00
4	0	0
5	1.92	2.00
6	1.92	2.00
7	1.92	2.10
8	5.00	5.00

IC406		
PIN	TX	RX
1	3.05	AF 1.05
2	1.9	1.9
3	1.9	1.9
4	5	5
5	1.9	1.9
6	1.9	1.9
7	1.9	1.9
8	1.9	1.9
9	1.9	1.9
10	1.9	1.9
11	GND	GND
12	1.9	1.9
13	1.9	1.9
14	1.9	1.9

IC407		
PIN	NORMAL	OPTION
1	1.9	XT2
2	0	XT2
3	3.6	XT2
4	0	XT2
5	2	1.9
6	5	5
7	1.9	1.9
8	1.05	XT2
9	5	CLK
10	GND	GND
11	5	CLK
12	0	0
13	2	1.9
14	2	1.9

IC410		
PIN	BUSY	RX
1	AUDIO	1.9
2	AUDIO	1.9
3	AUDIO	1.9
4	5	5
5	AUDIO	1.9
6	AUDIO	1.9
7	AUDIO	1.9
8	AUDIO	1.9
9	AUDIO	1.9
10	AUDIO	1.9
11	GND	GND
12	AUDIO	1.9
13	AUDIO	1.9
14	AUDIO	1.9

IC107 IC105 IC402			
PIN	1	2	3
IC107	13.7	0	8
IC105/402	8	0	5



# MAXON SM-2000 MOBILE VOLTAGE CHARTS (SM-2150/VHF)

IC109								
PIN	1	2	3	4	5	6	7	8
BUSY	7	OSC	6	7.2	6	6	6	7.2
RX (MUTE)	7	OSC	6	7.2	6	6	6	7.2
PIN	9	10	11	12	13	14	15	16
BUSY	AUDIO	0.8	NOISE	2.5	7	4.5	GND	2
RX (MUTE)	AUDIO	0.8	NOISE	0	7	0	GND	2

IC101								
PIN	1	2	3	4	5	6	7	8
RX VOLTAGE	0	5	5	5	5	PD	GND	0
TX VOLTAGE		2.5	5	5	5	0	0	2
PIN	9	10	11	12	13	14	15	16
RX VOLTAGE	5	2	2.7	5	3.5	5	0	0
TX VOLTAGE	2.7	3	2.7	5	3.5	5	0	0
PIN	17	18	19	20				
RX VOLTAGE	5	0	0	OSC				
TX VOLTAGE	5	0	0	2.3				

TRANSISTOR VOLTAGE CHART						
REF.NO	RX			TX		
	B	C	E	B	C	E
Q108	7.5	3.5	GND	0	3.5	GND
Q113	0.7	2.5	1.5	0.7	2.5	1.3
Q114	3.1	5	2.3	3.1	5	2.3
Q116	0	0	0	2	7	1.2
Q117	0	0	0	0.7	7.2	GND
Q125	12	13.72	13.7	12	12.5	13.2
Q106	7	2.5	GND	1	1.5	GND
Q140	0	7.5	GND	5	0	GND
Q130	0.7	5	0	0	2.5	0
Q122	8	0	8	7.3	8	8
Q121	0	8.1	0	5	0	GND
Q127	5	0	GND			
Q128	0	8	8			
Q120	0	13.8	GND	0	13.8	GND
Q118	0	9.5	GND	0	6	GND
Q139	7.5	0	8	0	8	8

# MAXON SM-2000 MOBILE

## VOLTAGE CHARTS (SM-2450/UHF)

### VOLTAGE CHARTS (SM-2450/UHF)

IC409								
PIN	DESCRIPTION	TX	RX		PIN	DESCRIPTION	TX	RX
1	DATA	0	0		21	CH-4		
2	EEPROM ENABLE	0	0		22	CH-8		
3	PLL ENABLE	5	5		23	MONITOR	5	5/0
4	CHANNEL SPACING	5/0	5/0		24	PTT	0	3.9
5	DATA IN	0	0		25	PROG. ENABLE	5	5
6	RED L.E.D.	5	0		26	TX ENABLE	5	0
7	BUSY	5/0	0		27	ALERT TONE	0	0
8	EXT OPTION	5	5		28	MF6 CLK	CL	CL
9	HOOK SW	0/3.7	0/3.7		29	CALL DETECT	0	0
10	LOCK DET	0	0		30	SEND UP CONTROL	0	0
11	TEST	5	5		72	GND	0	0
12	X1	5	5		73	VCC	5	5
13	X2 (OPEN)	0	0		74	OSC1	2.3	2.3
14	GND	0	0		75	OSC2	2.3	2.3
15	D TO A	5/0	0		76	RESET	0	0
16	D TO A	5/0	0		77	AUDIO ENABLE	5	5/0
17	tone ENABLE	5/0	0		78	GREEN L.E.D.	0	5
18	D TO A	5/0	0		79	RX ENABLE	0	5
19	CH-1				80	CLK		
20	CH-2							

IC411								
PIN	1	2	3	4	5	6	7	8
RX VOLTAGE	0	4	1.9	1.9	0	0	0	0
TX VOLTAGE	0	1.2	1.9	2.75	2.75	0	0	2
PIN	9	10	11	12	13	14	15	16
RX VOLTAGE	5	2	2.7	5	3.5	5	0	
TX VOLTAGE	0	3	2.7	5	3.5	5	0	0

IC412		
PIN	NORMAL	PROGRAM
1	0	0
2	0	0
3	0	0
4	0	0
5	0	0
6	GND	GND
7	GND	GND
8	GND	GND
9	5	0
10	5	0
11	5	0
12	0	0
13	3.6	3.6
14	3.6	3.6
15	0	0
16	5	5

IC401		
PIN	TX	RX
1	0	0
2	0	0
3	2	1
4	2	2
5	5	0
6	5	5
7	0	0
8	SAT	2
9	SAT	2
10	0	0
11	0	0
12	0	0
13	5	5
14	5	5

# MAXON SM-2000 MOBILE VOLTAGE CHARTS (SM-2450/UHF)

IC404		
PIN	TX UNMODE	RX MODE
1	1.9	VOICE
2	1.9	VOICE
3	1.9	VOICE
4	5	5
5	1.9	VOICE
6	1.9	VOICE
7	1.9	VOICE
8	1.9	VOICE
9	1.9	VOICE
10	1.9	VOICE
11	GND	GND
12	1.9	VOICE
13	1.9	VOICE
14	1.9	VOICE
IC405		
PIN	TX	RX
1	1.93	2.00
2	1.93	2.00
3	1.8	2.00
4	0	0
5	1.92	2.00
6	1.92	2.00
7	1.92	2.10
8	5.00	5.00
IC406		
PIN	TX	RX
1		AF
2	1.9	1.9
3	1.9	1.9
4	5	1.9
5	1.9	1.9
6	1.9	1.9
7	1.9	1.9
8		1.9
9		1.9
10	1.9	1.9
11	GND	GND
12	1.9	1.9
13	1.9	1.9
14	1.9	1.9

IC407		
PIN	NORMAL	OPTION
1	1.9	XT2
2	0	XT2
3	0	XT2
4	3	XT2
5	2	1.9
6	5	5
7	1.9	1.9
8	0	XT2
9	5	CLK
10	GND	GND
11	5	CLK
12	0	0
13	2	1.9
14	2	1.9
IC410		
PIN	BUSY	RX
1	AUDIO	1.9
2	AUDIO	1.9
3	AUDIO	1.9
4	5	5
5	AUDIO	1.9
6	AUDIO	1.9
7	AUDIO	1.9
8	AUDIO	1.9
9	AUDIO	1.9
10	AUDIO	1.9
11	GND	GND
12	AUDIO	1.9
13	AUDIO	1.9
14	AUDIO	1.9

IC107 IC105 IC402			
PIN	1	2	3
IC107	13.2	0	8
IC105/402	5	0	8

# MAXON SM-2000 MOBILE

## VOLTAGE CHARTS (SM-2450/UHF)

IC109								
PIN	1	2	3	4	5	6	7	8
BUSY	7	OSC	6	7.2	6	6	6	7.2
RX (MUTE)	7	OSC	6	7.2	6	6	6	7.2
PIN	9	10	11	12	13	14	15	16
BUSY	AUDIO	0.8	NOISE	0.6	7	0	GND	2
RX (MUTE)	AUDIO	0.8	NOISE	1.8	7	8	GND	2

IC101								
PIN	1	2	3	4	5	6	7	8
VOLTAGE	0	5	5	5	5	PD	GND	0
PIN	9	10	11	12	13	14	15	16
VOLTAGE	TEST	2	2	5	OSC	5	0	0
PIN	17	18	19	20				
VOLTAGE	5	0	0	OSC				

TRANSISTOR VOLTAGE CHART						
REF.NO	RX			TX		
	B	C	E	B	C	E
Q108	1.2	3.5	0.6	1.2	3.5	0.6
Q110	0.6	1.8	GND	0.6	1.8	GND
Q111	3.6	4.3	2	3.6	4.3	2
Q113	0.7	2.5	GND	0.7	2.5	GND
Q114	3.1	5	2.3	3.1	5	2.3
Q116				1.5	7.5	1.2
Q117				0.7	7.5	GND
Q125				12	12.5	13.2
Q106	2	5	1.4	2	5	1.4
Q140				5	0	GND
Q119				0	8	8
Q130	0.5	5	0			
Q122				7	6.7	6.8
Q121				5	0	GND
Q127	5	0	GND			
Q128	0	8	8			

# MAXON SM-2000 MOBILE TROUBLE SHOOTING CHART (SM-2000)

## TROUBLE SHOOTING CHART (SM-2000)

### Status Indications & Audible Tones

STATUS	DESCRIPTION	LED COLOR	AUDIBLE TONE
NORMAL	Power on ready	N/A	Melody
	Busy	Yellow	N/A
	Correct Tone	Green	N/A
	Transmit	Red	N/A
	Scan	Green, Flashing	N/A
	Busy Lock	Yellow, Flashing	Single Tone
WARNING	Time Out Timer	N/A	Single Tone
	Battery Low	Red, Flashing	Four Tone, Repeated
ERROR	<b>EEPROM Error</b>	Red, Flashing	Single Tone Repeated
	<b>PLL Error</b>	Red, Flashing	Double Tone Repeated
	<b>Filtering Error</b>	Red, Flashing	Three Tone Repeated

#### Unit Does Not Program

1. Defective Programming Lead
2. Wrong Programming Mode
3. Defective MIC Connector
4. Defective IC412

#### Unit Does Not Work

1. Open DC fuse in Power Cable
2. Defective Volume Switch
3. Defective Regulator IC107, 105, 402
4. Broken DC Cable

#### No Output from Speaker

1. Defective internal speaker and external jack
2. Defective IC108
3. Defective VR801

#### Squelch Does Not Work

1. Wrong alignment of squelch resistor RV103
2. Defective IC109
3. Defective CPU IC409

#### No Sub Audio Decode

##### CTCSS/DCS

1. Wrong Programming
2. Defective Switch Filter IC406 (MF-6)
3. Defective CPU IC409

# MAXON SM-2000 MOBILE

## TROUBLE SHOOTING CHART (SM-2000)

No TX

1. Defective MIC
2. Defective CPU IC409
3. Defective IC412

No TX Power

1. Defective TX enable Q122
2. Defective APC Control Circuit Q125
3. Defective TX Power Buffer AMP Q116 and Q117
4. Defective TX Power Amp (SM-2150) Q118,Q120
5. Defective TX Power Module (SM-2450) IC103
6. Defective ANT SW D108 and D120
7. Defective ANT Connector

Over Power

1. Programming
2. Q125 Short
3. Defective D107 and APC Circuit

Low TX Power Output

1. Wrong Programming
2. Defective TX AMP (SM-2150) Q116 , Q117 , Q118, Q120 and D108
3. Defective TX AMP (SM-2450) Q116 , Q117 , IC103 , and D108
4. Defective Antenna Connector

No Modulation

1. Defective MIC
2. Defective Analog SW IC412 and IC411
3. Defective 300Hz HPF IC410
4. Defective MIC AMP and Splatter Filter IC404
5. Defective Audio Buffer IC405
6. Wrong Alignment of RV402
7. Defective Analog IC401

No Encode of CTCSS/DCS

1. Wrong Programming
2. Defective CPU IC409
3. Defective IC407 and IC411

No Sensitivity

1. Defective Antenna Switch D108 , D120 , and D121
2. Defective Front-End Module
3. Defective DBM IC102
4. Defective 45MHz IF Filter CF101
5. Defective IF IC109

Wrong Frequency

1. Wrong Alignment of 12.8MHz TCXO
2. Wrong Programming

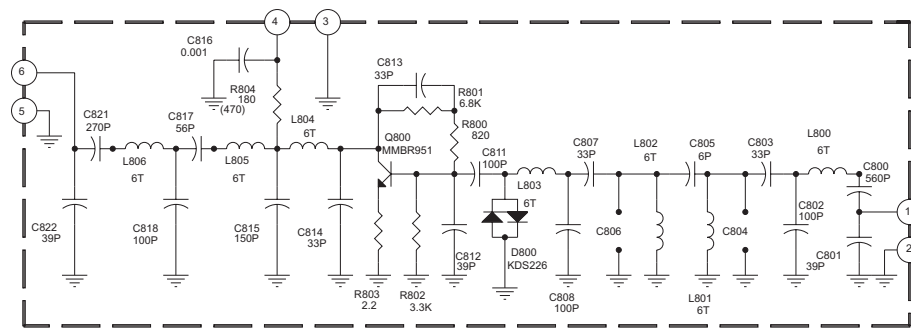

**SM-2150/VHF FRONT-END**

770-110-0002 Rev. B

(VHF Band 2 shown)

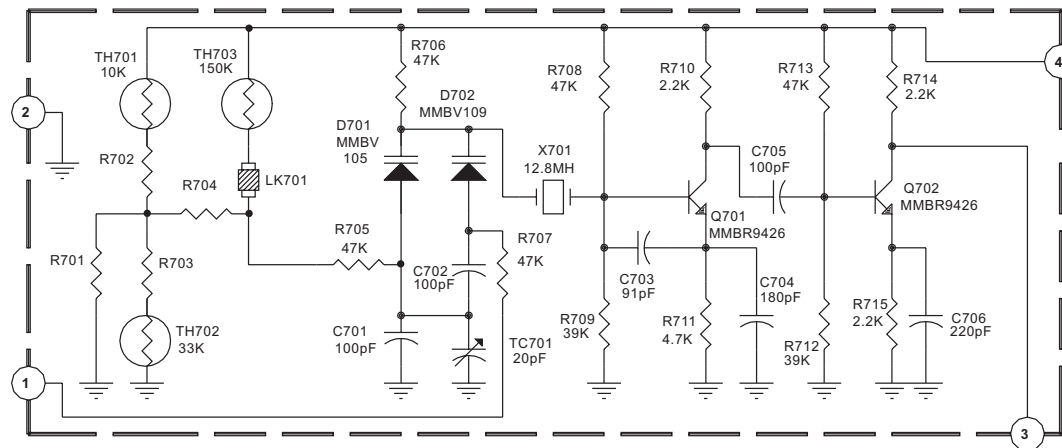

**SM-2000 TCXO**

770-100-0002 Rev. C

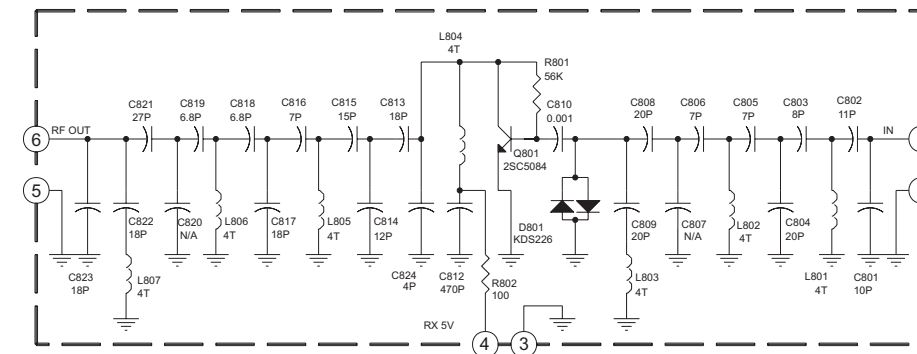

**SM-2450/UHF FRONT-END**

770-110-0001 Rev. B

(UHF Band 2 shown)

*Note 1: Schematics are for reference only. Reference designators and part values may not reflect product configuration.*

*Note 2: Refer to band chart for specific Front-End PCB assemblies.*

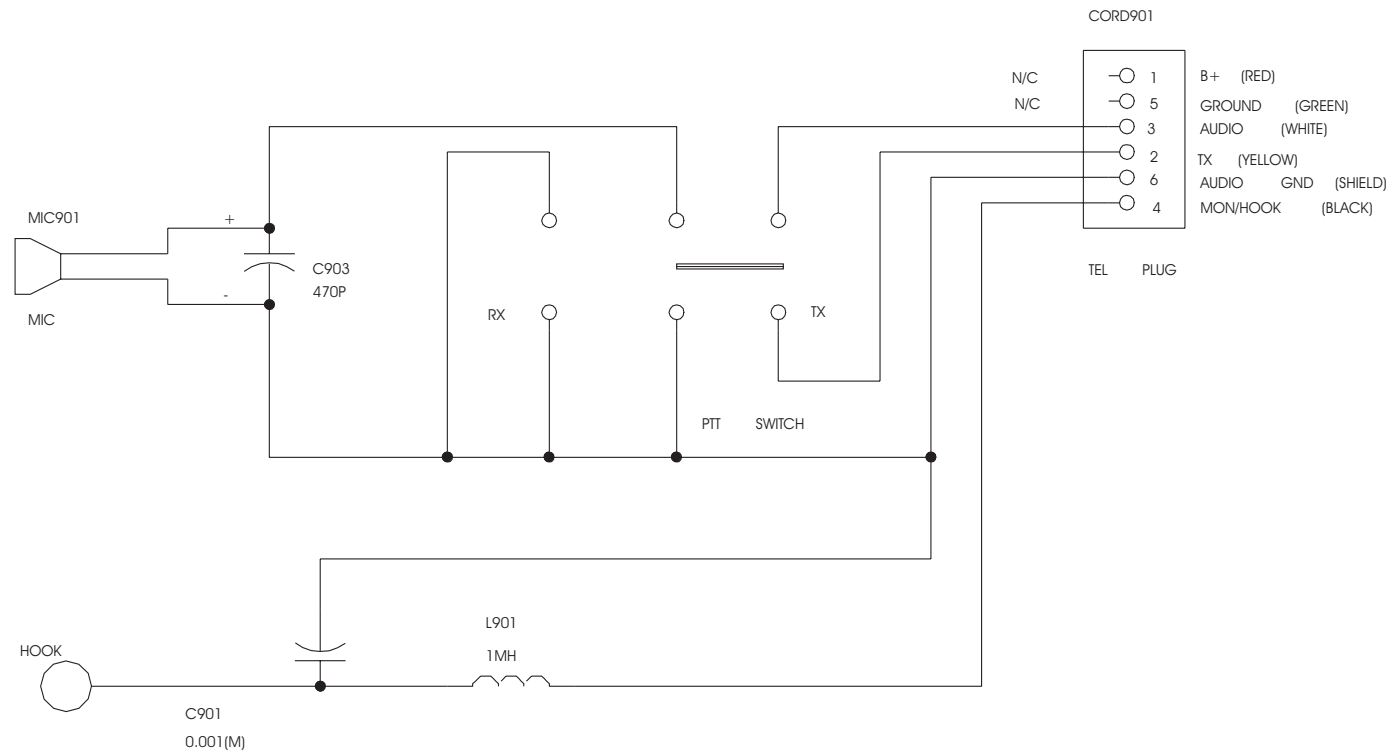

**SM-2000**  
**MA-4472 MICROPHONE SCHEMATIC**  
 770-090-0003

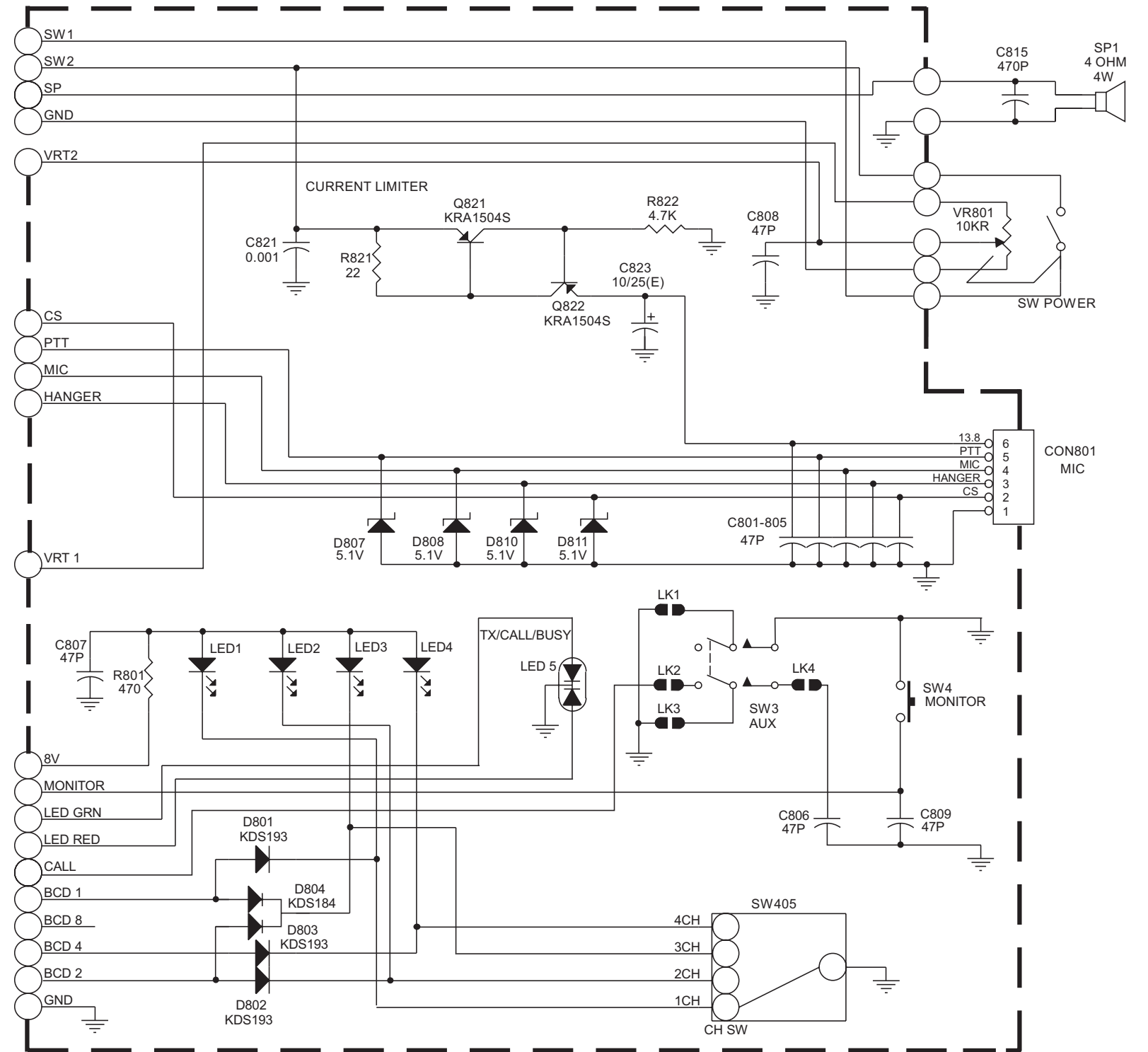

**SM-2000**  
**CONTROL HEAD SCHEMATIC**  
 770-050-0003 Rev. B



REVISIONS		
REV	DESCRIPTION	DATE
A	RELEASED TO MANUFACTURING	JPW 09/96

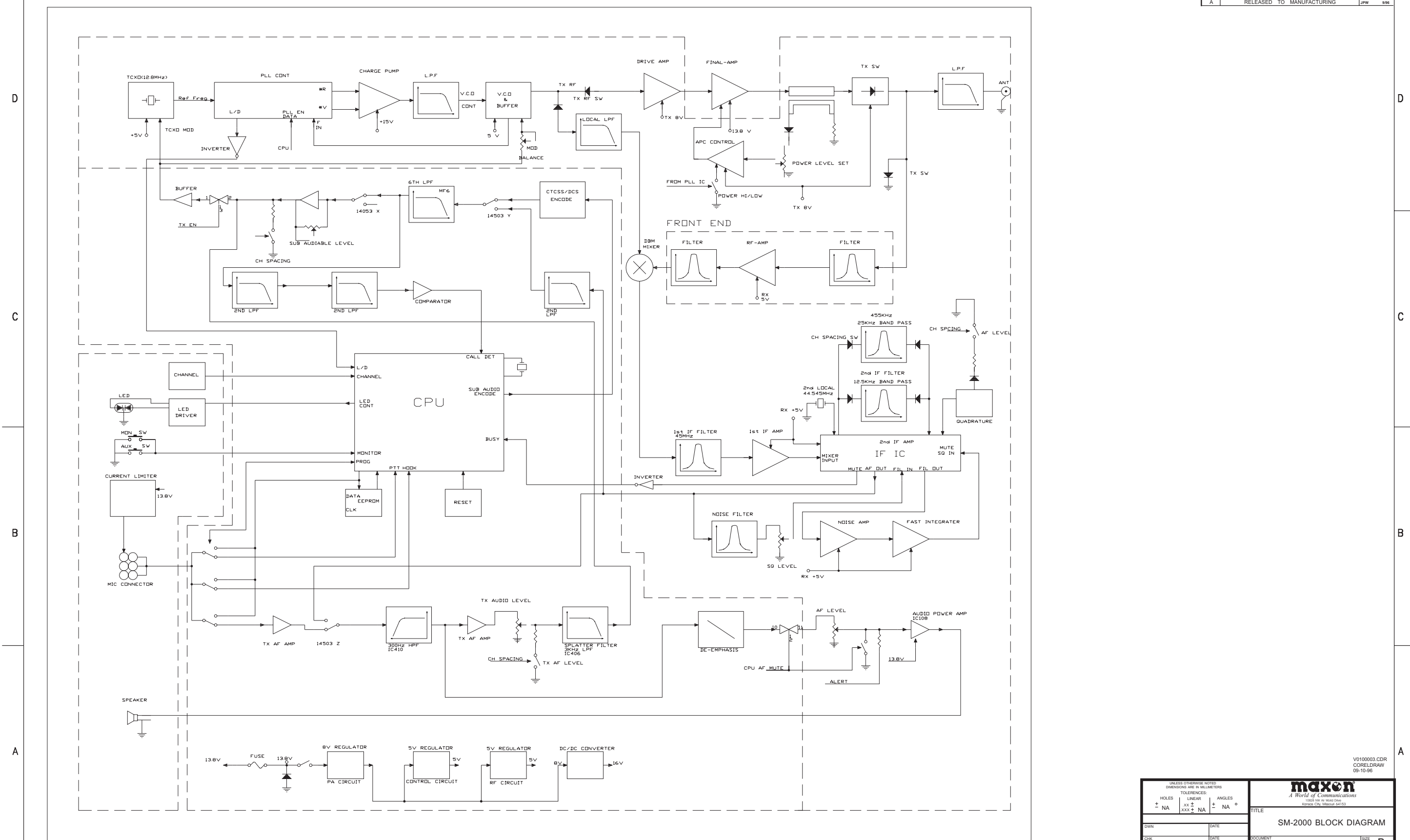

UNLESS OTHERWISE NOTED DIMENSIONS ARE IN MILLIMETERS		TOLERANCES:	
HOLES	± NA	LINEAR	± .xx XXX ± NA
ANGLES	± NA °		
TITLE		SM-2000 BLOCK DIAGRAM	
OWN	DATE	DOCUMENT NUMBER	060-010-0003
CHK	DATE	SCALE	NA
PROD ENGR	DATE	SHEET	1 OF 1

V0100003.CDR  
CORELDRAW  
09-10-96

REVISIONS		DATE
REV	DESCRIPTION	
A	RELEASED TO MANUFACTURING	JPW 9/96
B	ECO 97014 Change to Sheet 1, Digital Section Onl	JPW 4/97
C	ECO 97025	4/97
D	ECO 98017 Change to Sheet 2, RF Section Onl	JPW 11/98

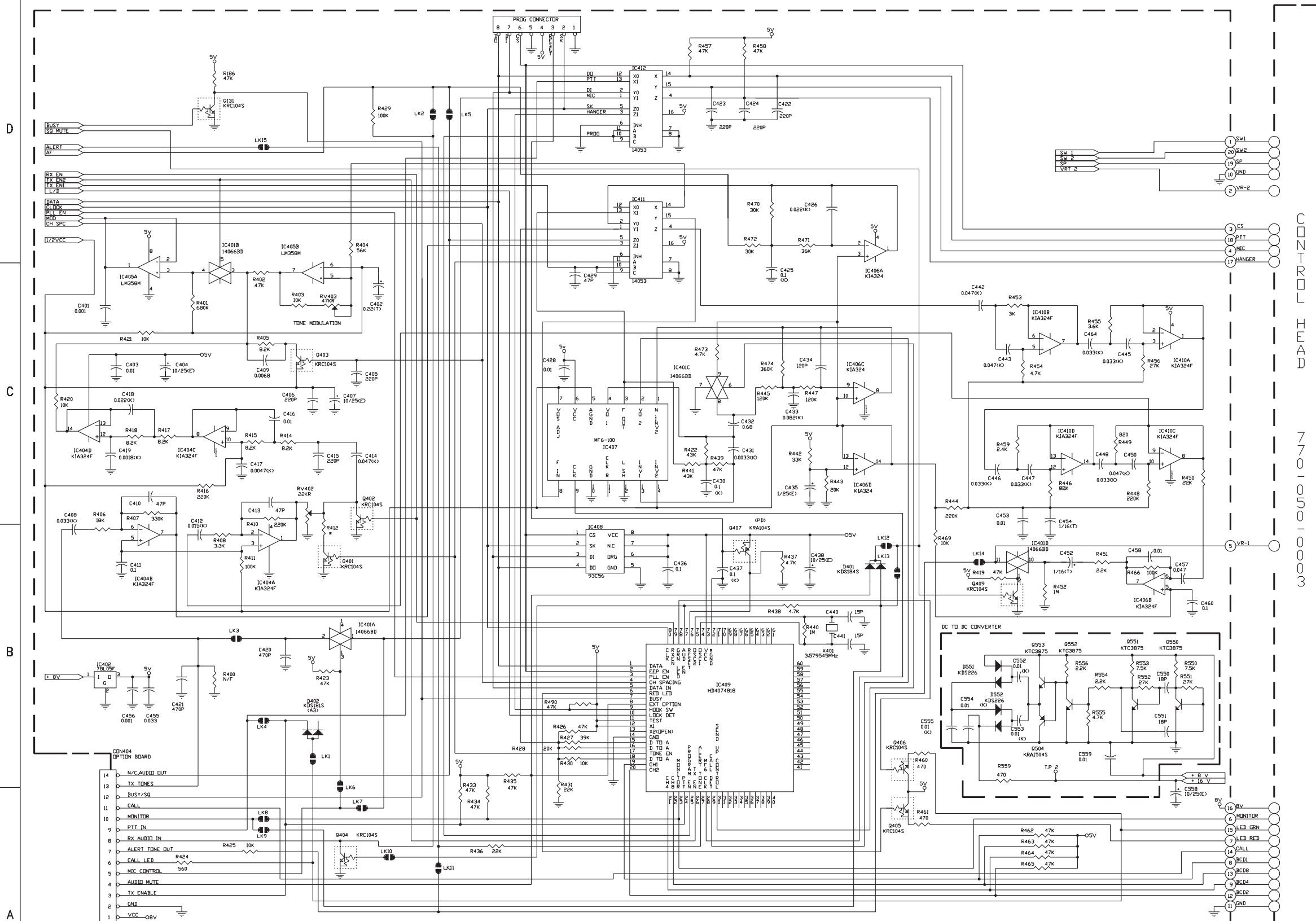

- NOTES:
- ALL VALUES ARE IN OHMS, MICROHENRIES OR MICROFARADS UNLESS OTHERWISE SPECIFIED.
  - ALL RESISTORS ARE 1/10W 5% UNLESS OTHERWISE SPECIFIED.
  - FOR CONTROL HEAD SCHEMATIC REFER TO P/N770-050-0003.

DIGITAL SECTION DIGITAL2.SCH COMMON FOR BOTH SM2150 AND SM2450

**SM-2000 (DIGITAL SECTION)**

MAIN BRD SCHEMATIC SHEET 1, DIGITAL SECTION

SCHEMATIC P/N770-000-0001  
SCHEMATIC P/N770-000-0002

DIGITAL2.SCH (SHEET 1) DIGITAL SECT. PER ECO 98017  
S0000001.SCH (SHEET 2) RF SECTION  
S0000002.SCH (SHEET 2) RF SECTION

LIBRARY SM2000.LIB

PCB P/N610-000-0001 SM-2150 VHF  
PCB P/N610-000-0002 SM-2450 UHF

SM2150 MAIN BRD ASSY P/N650-000-0001  
SM2450 MAIN BRD ASSY P/N650-000-0002

PADS FILE  
SM-2150-P0000001.JOB  
SM-2450-P0000002.JOB

DIGITAL.DWG  
AUTOCAD R13c4  
11-18-98

\* TONE DEVIATION

REF	MODEL	VALUE
R412		22K
SM-2150		39K
DSM-401/99		

LINK TABLE

REF NO	LK1	LK2	LK3	LK4	LK5	LK6	LK7	LK8	LK9	LK10	LK11	LK12	LK13	LK14	LK15
NDRM4L	N/F	N/F	FIT	FIT	FIT	N/F	N/F	N/F	N/F	N/F	FIT	N/F	FIT	FIT	N/F
CA-1133	N/F	N/F	FIT	N/F	FIT	N/F	FIT	FIT	N/F	FIT	N/F	FIT	N/F	N/F	N/F

UNLESS OTHERWISE NOTED  
DIMENSIONS ARE IN MILLIMETERS

TOLERANCES:  
HOLES .XX ± NA  
LINEAR .XX ± NA  
ANGLES ± NA °

**maxon**  
A World of Communications  
1825 St. Asaph Drive  
Riverside, CA, USA 92504

TITLE: SM-2000  
MAIN BOARD SCHEMATIC (DIGITAL SECTION)

DWN: DATE: DOCUMENT NUMBER: 770-000-0001 VHF 770-000-0002 UHF SIZE: B

CHK: DATE: SCALE: NA SHEET: 1 OF 2

PROD ENGR: DATE:

REVISIONS		
REV	DESCRIPTION	DATE
A	RELEASED TO MANUFACTURING	12/98
B	ECO 97014 Change to Sheet 1, Digital Section Onl	12/97
C	ECO 97020	12/97
D	ECO 98017 Change to Sheet 2, RF Section Onl	11/98

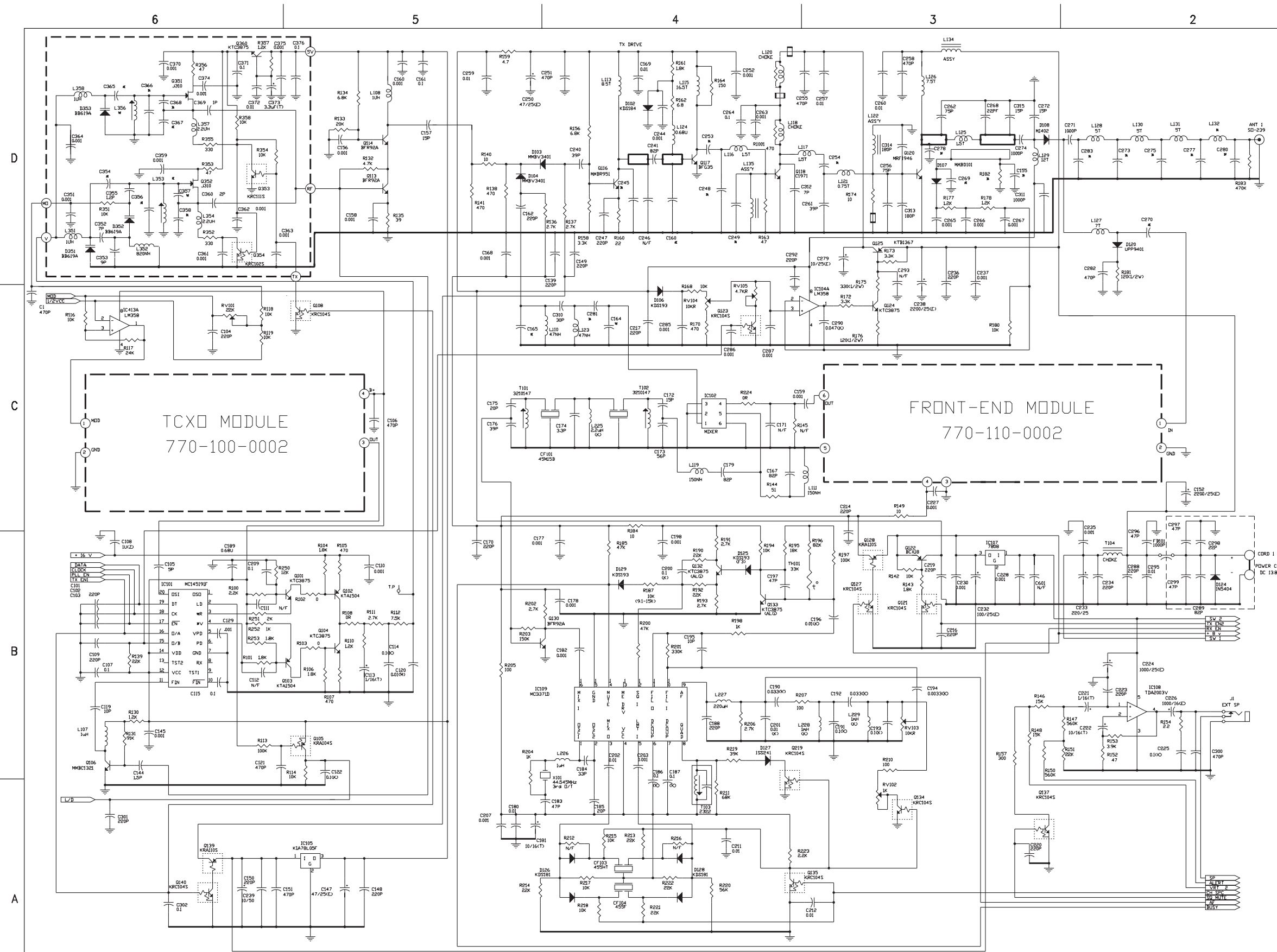

NOTES:  
 1. ALL VALUES ARE IN OHMS, MICROHENRIES OR MICROFARADS UNLESS OTHERWISE SPECIFIED.  
 2. ALL RESISTORS ARE 1/10W 5% UNLESS OTHERWISE SPECIFIED.  
 3. REFER TO VHF FRONT-END SCHEMATIC (P/N: 770-110-0002) FOR BANDING CHART

DIGITAL SECTION DIGITAL.SCH COMMON FOR BOTH SM2150 AND SM2450

SM-2150/VHF (RF SECTION)  
 MAIN BRD SCHEMATIC, SHEET 2, RF SECTION  
 SCHEMATIC P/N:770-000-0001  
 DIGITAL.SCH (SHEET 1) DIGITAL SECTION (WAS 67280T-D.SCH)  
 S000001.SCH (SHEET 2) RF SECTION PER ECO'S 97014, 97020, 98017

LIBRARY SM2000.LIB

PCB P/N:610-000-0001  
 SM2150 MAIN BRD ASSY P/N:650-000-0001

PADS FILE P0000001.JOB

VCO BAND OPTION

REF ID	C354	C356	C357	C358	C365	C366	C367	C368	L353	L356
BAND 1 136-162MHz	39P	4P	5.6P	5.6P	18P	4	4.7P	4.7P	4.5T	3.5T
BAND 2 148-174MHz	39P	4P	4.7P	4.7P	16P	4	3.3P	3.3P	3.5T	3.5T

MAIN BOARD BAND OPTION

REF ID	C195	C160	C241	C245	C248	C249	C253	C254	C256	C261	C262	C268	C269	C270	C273	C275	C277	C278	C280	C281	C283	C312	C313	C314	C315	R182	L132
BAND 1 136-162MHz	11P	24P	82P	8P	27P	18P	75P	43P	75P	39P	75P	22P	0.3P	6P	51P	56P	47P	75P	20P	26P	27P	7P	180P	180P	4	150ohm	5T
BAND 2 148-174MHz	4P	24P	82P	5P	27P	20P	75P	33P	75P	39P	75P	22P	9P	4P	43P	47P	43P	82P	24P	56P	18P	7P	180P	180P	4	120ohm	6T

UNLESS OTHERWISE NOTED DIMENSIONS ARE IN MILLIMETERS

HOLES		LINEAR		ANGLES	
±	NA	±	NA	±	NA
±	NA	±	NA	±	NA

TITLE: SM-2150/VHF RF SCHEMATIC DIAGRAM

DOCUMENT NUMBER: 770-000-0001 SIZE: B

SCALE: NA SHEET: 2 OF 2

770-000-0001re D.DWG  
 AUTOCAD R13c4  
 12-05-98

REVISIONS			
REV	DESCRIPTION	DATE	BY
A	RELEASED TO MANUFACTURING		

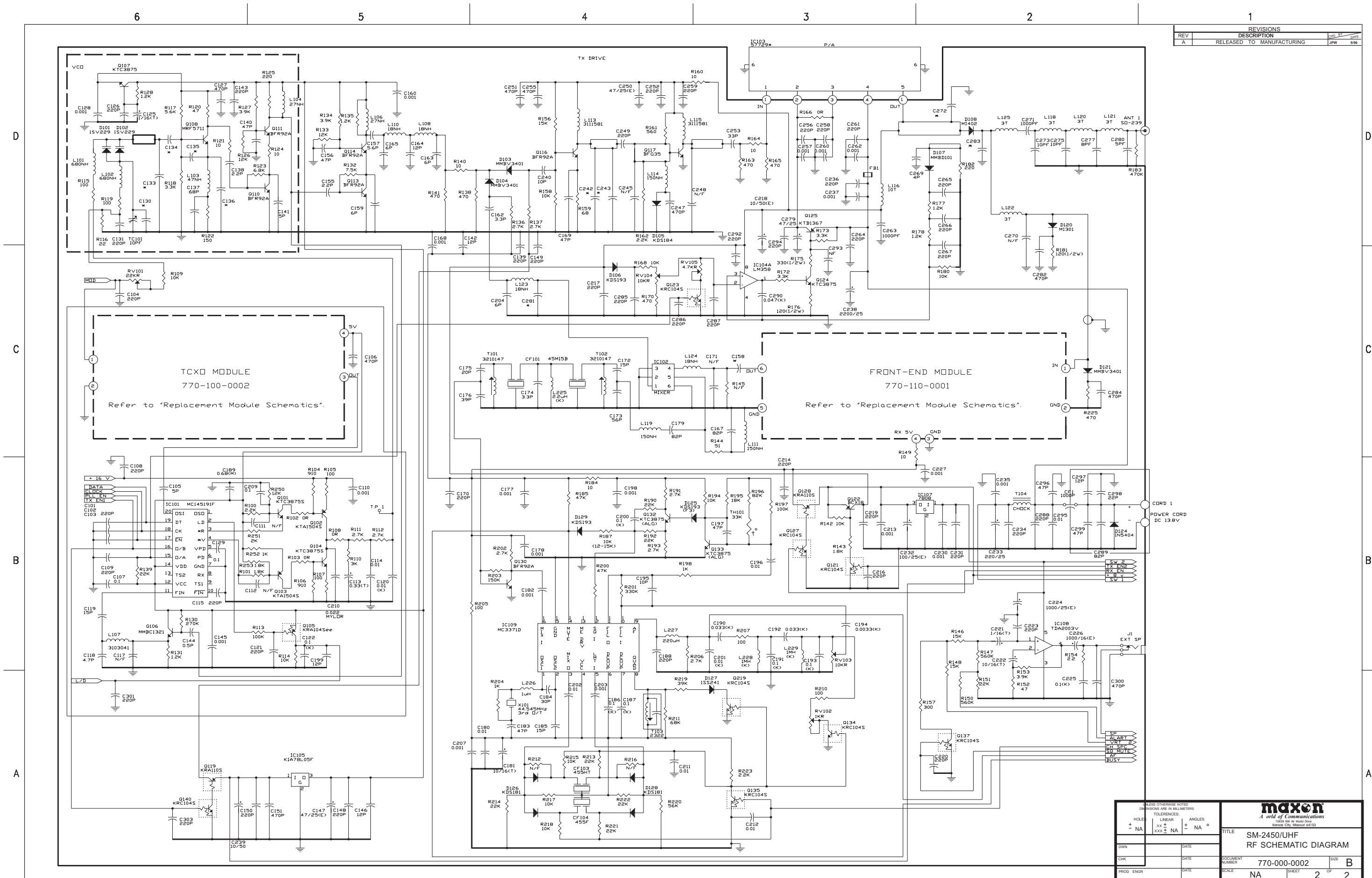

HOLDERS		TOLERANCES		ANGLES	
± NA	± NA	± NA	± NA	± NA	± NA
<p>maxon A world of Communications 10225 W. North Drive Kansas City, Missouri 64155</p>					
TITLE: SM-2450/UHF RF SCHEMATIC DIAGRAM					
DOCUMENT NUMBER: 770-000-0002			SIZE: B		
SCALE: NA			SHEET 2 OF 2		

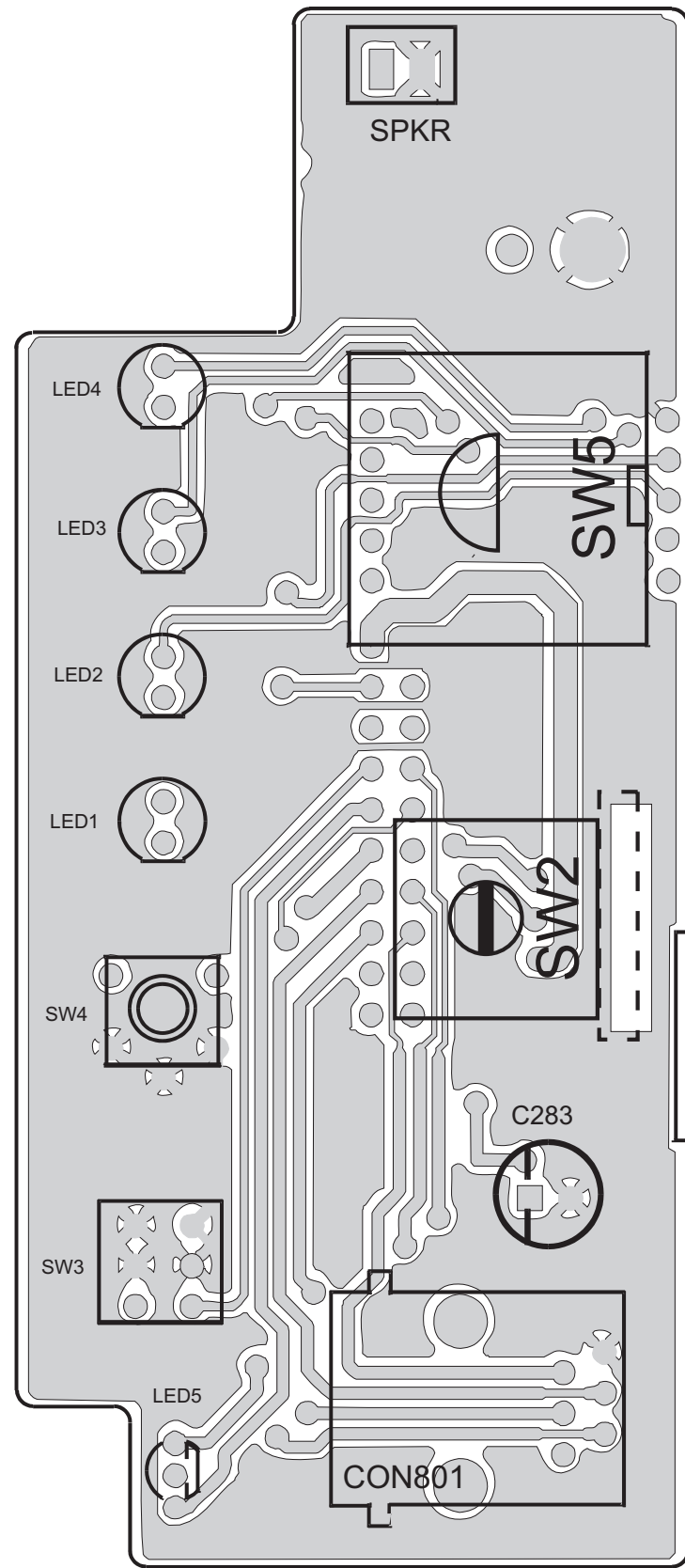

**SM-2000 CONTROL HEAD**

650-050-0003

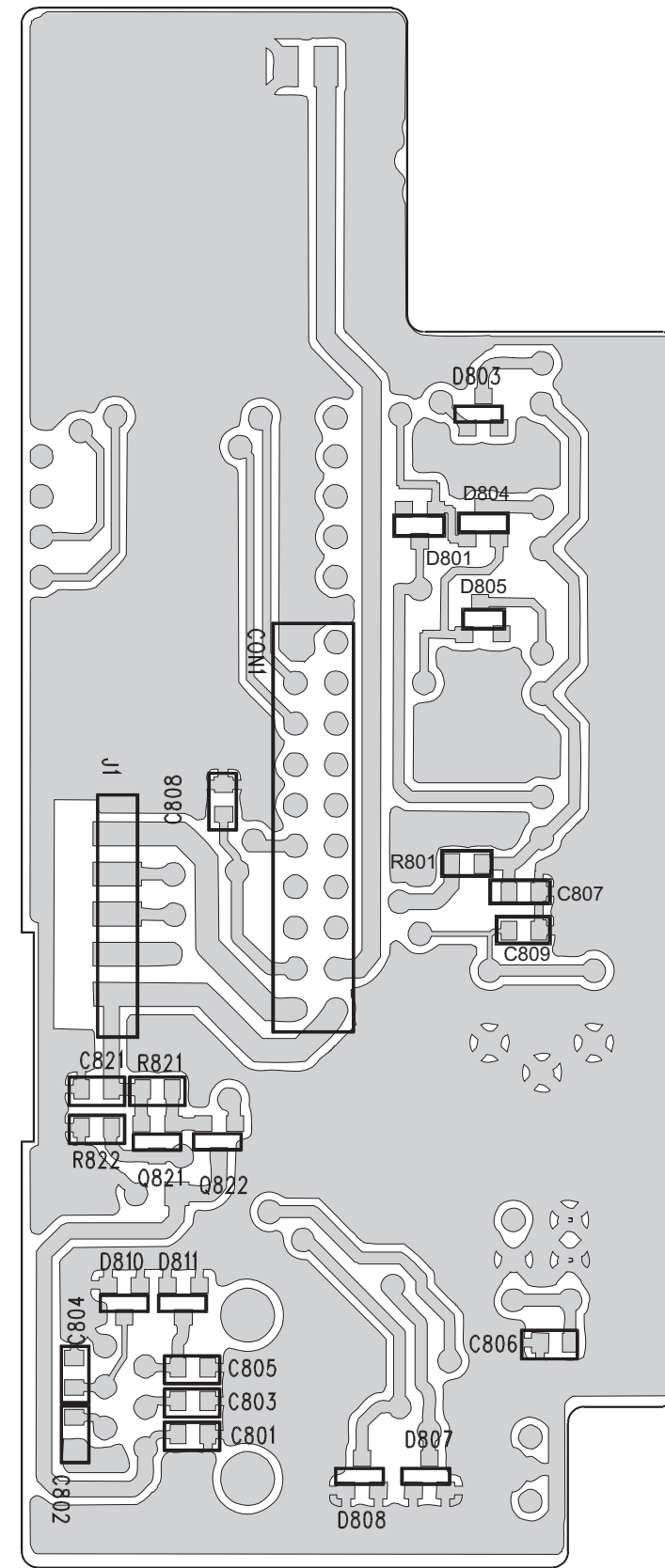

**SM-2000 CONTROL HEAD**

650-050-0003

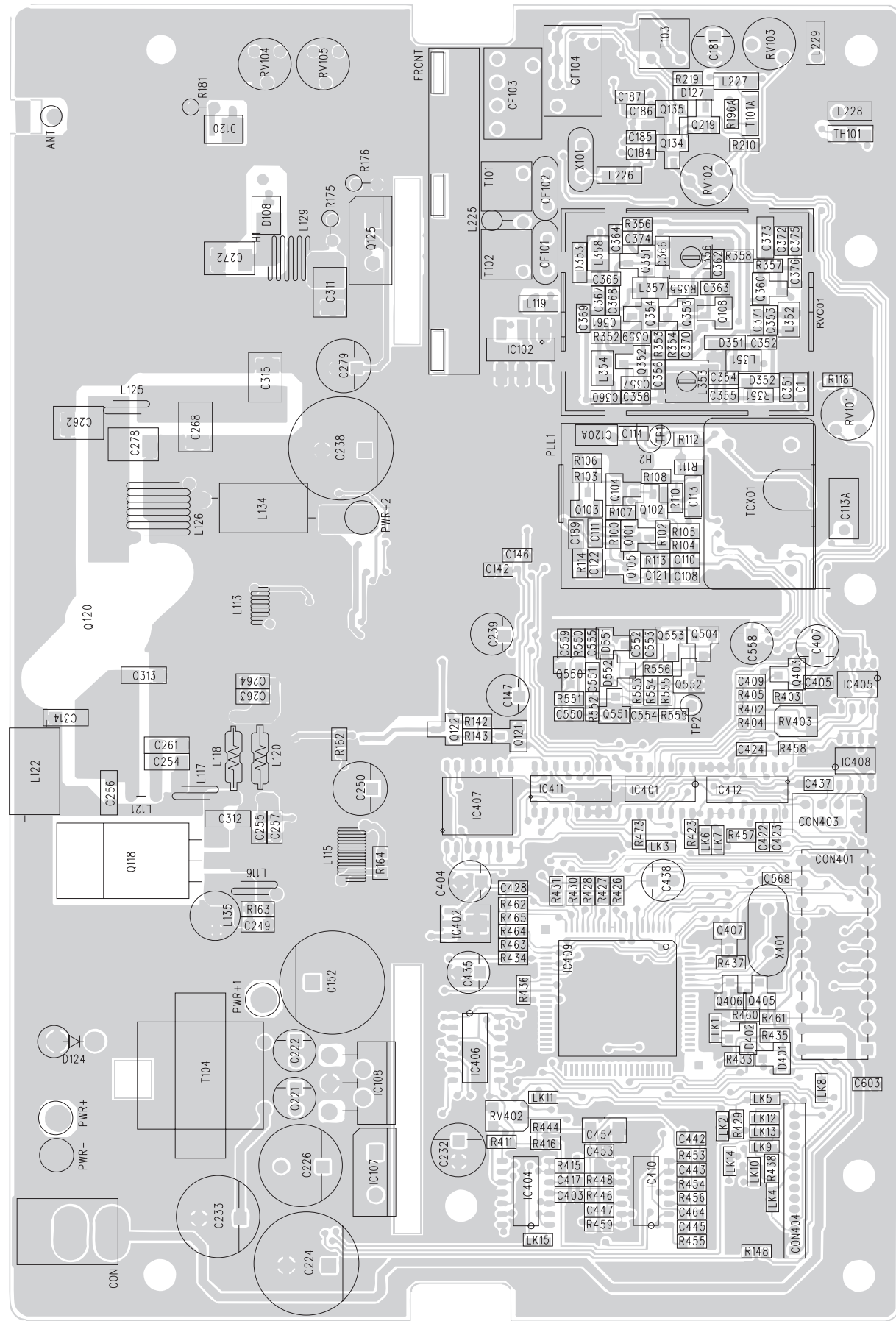

SM-2150/VHF MAIN BOARD ASSY.

650-000-0001

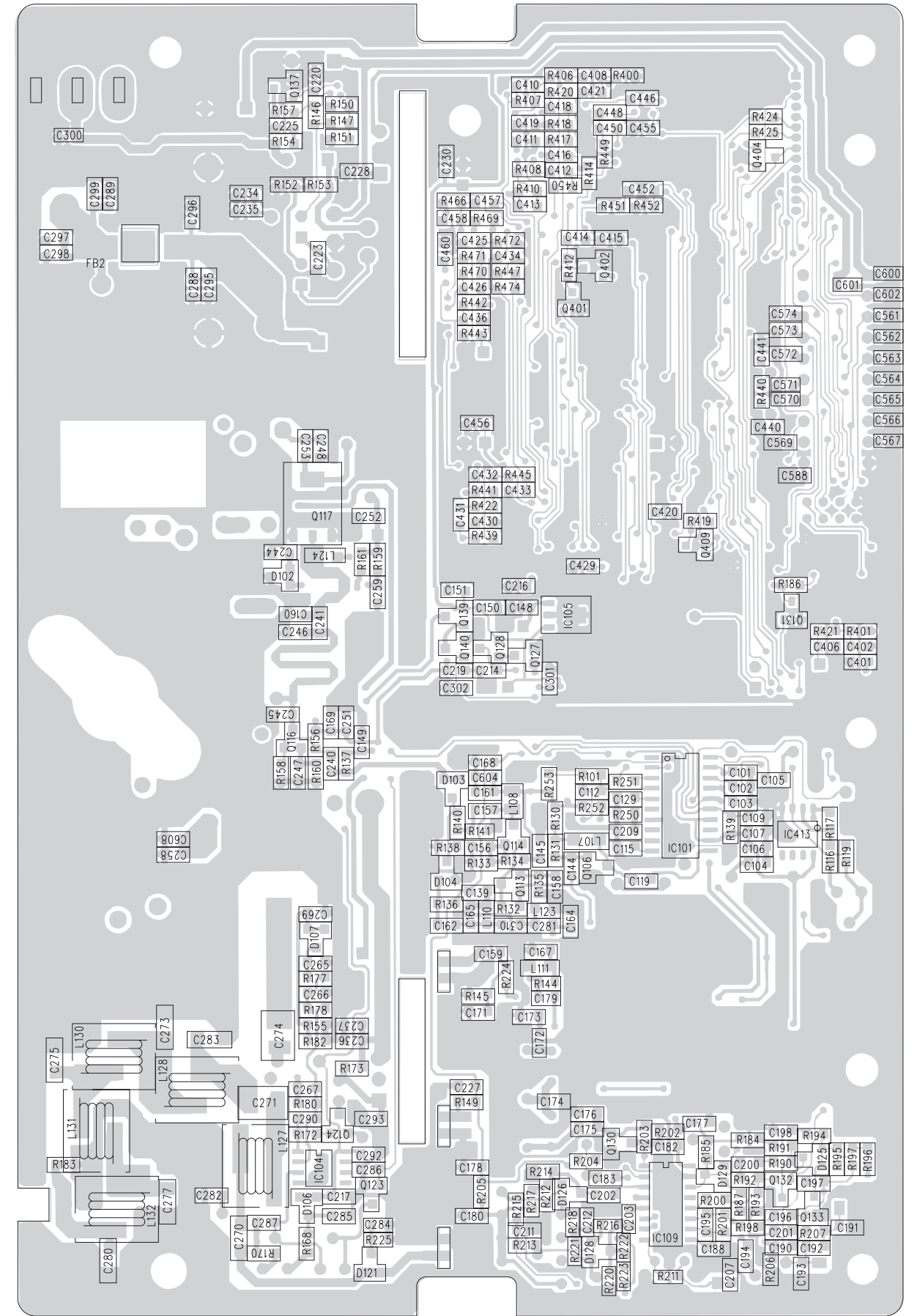

SM-2150/VHF MAIN BOARD ASSY.

650-000-0001

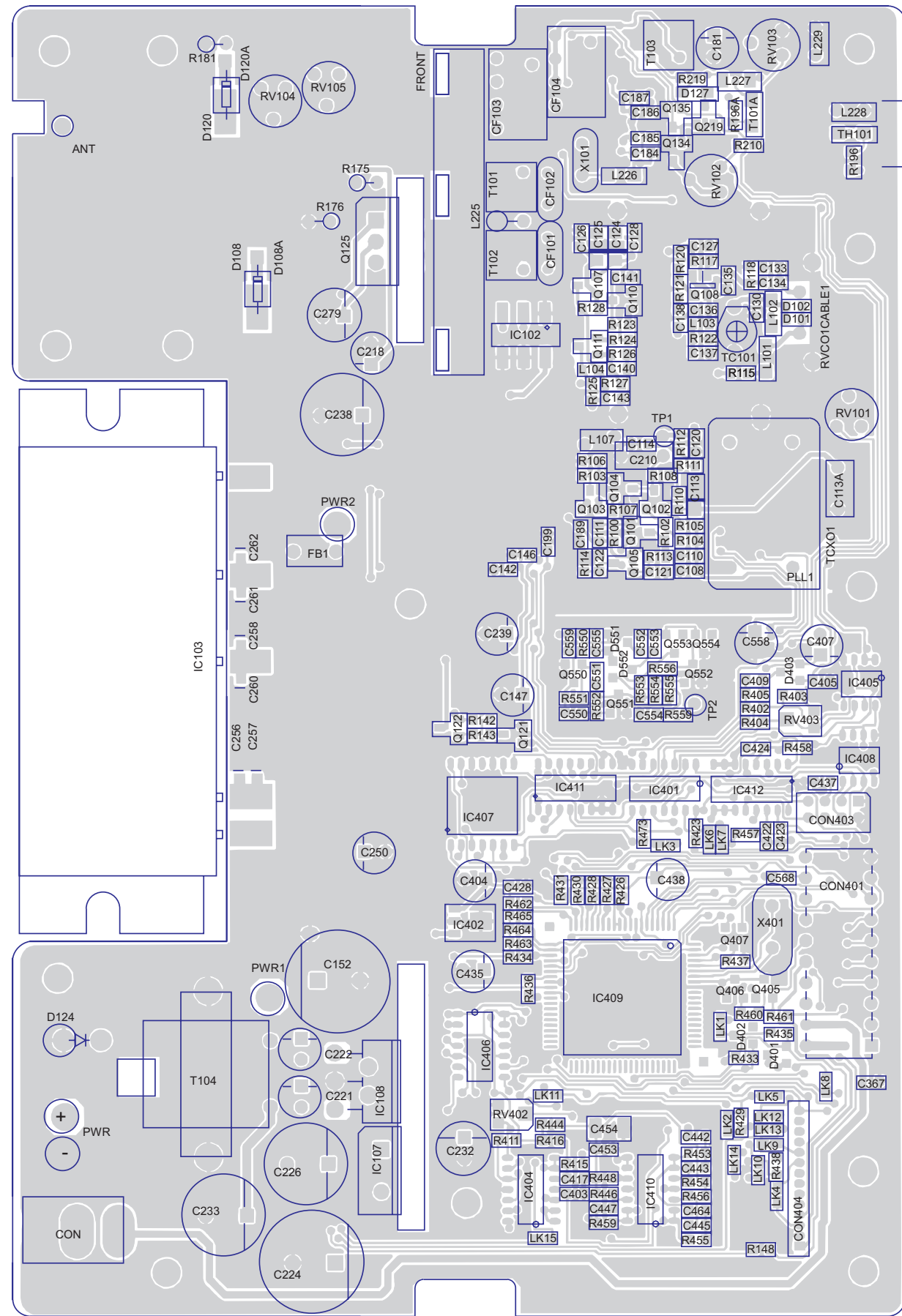

SM-245/UHF MAIN BOARD ASSY.

650-000-0002 Rev. C

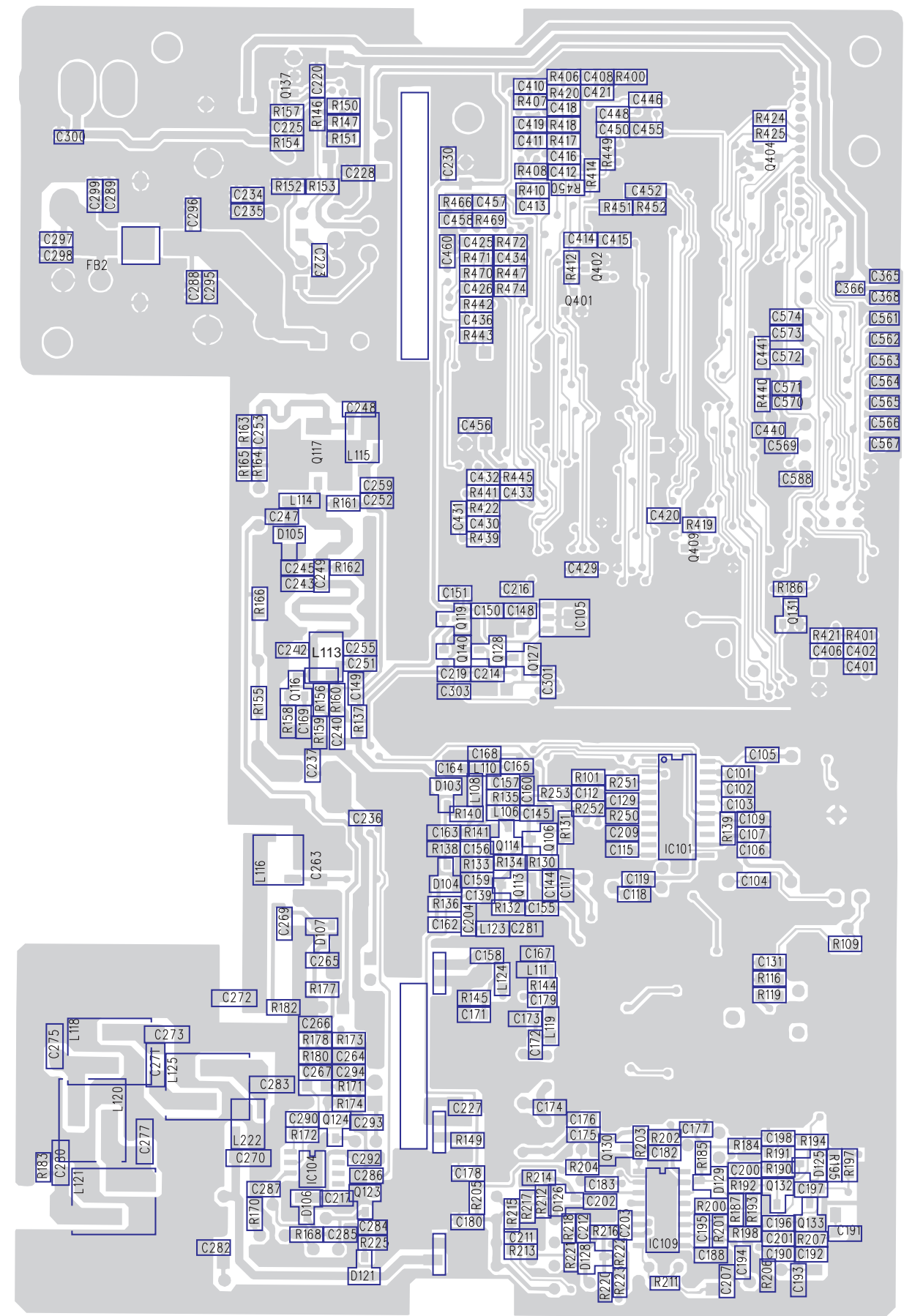

SM-245/UHF MAIN BOARD ASSY.

650-000-0002 Rev. C

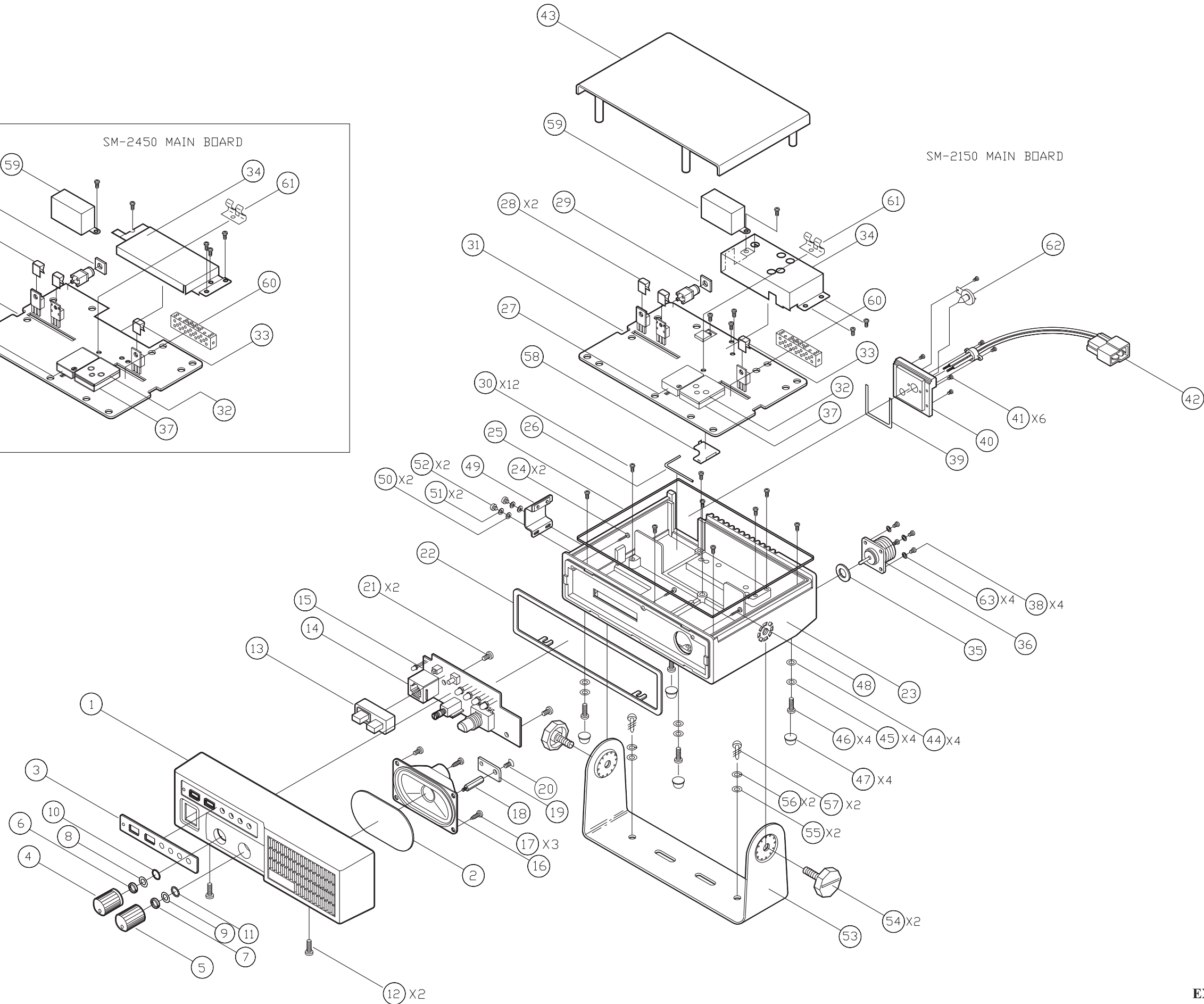
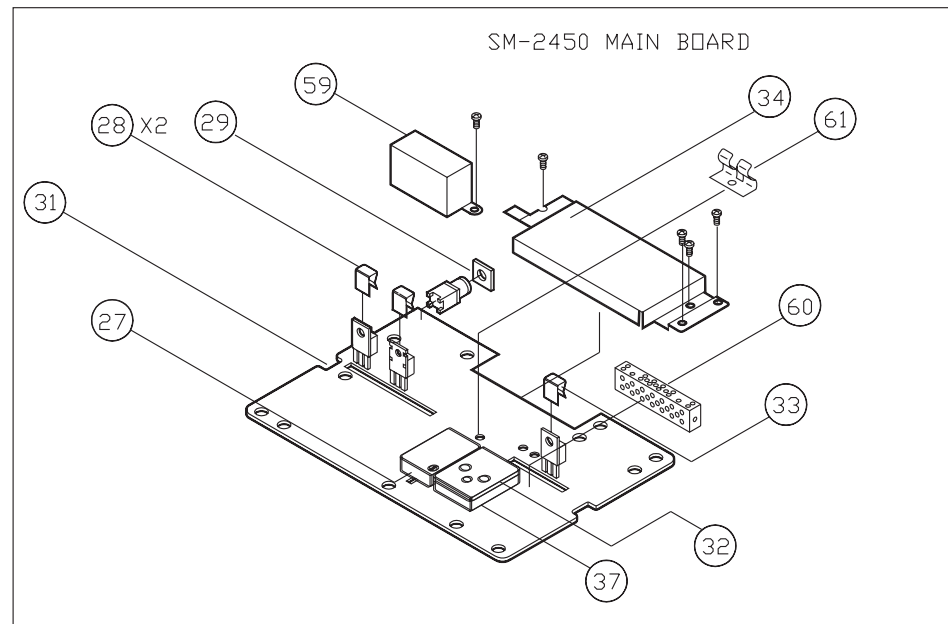

**SM-2000**  
**EXPLODED VIEW**



## SM-2150/VHF EXPLODED VIEW PARTS LIST

REF #	PART #	DESCRIPTION	QTY
1	801-282-A	E.S.C NORYL N190J-7002	1
2	905-510	FELT 30-R16.5 (2) XT0.3 FELT BLK	1
3	795-654	OVERLAY LEXAN T0.5	1
4	826-137	KNOB (FOR VOL) ABS 94HB BLK	1
5	826-120	KNOB (FOR CH) ABS 94HB BLK	1
6	650-346	NUT RING (FOR VOL) M7X0.75 (P) &9.9 BSBM	1
7	650-335	NUT RING (FOR CH) M9X0.75 (P) &11 BSBM	1
8	661-701	WASHER (FOR VOL) T0.5 SPC	1
9	662-901	WASHER (FOR CH) 13X9.3XT0.5 SPC	1
10	894-650	RING (FOR VOL) &10X&6.9XT0.8 SILL.RUBB BLK	1
11	895-095	RING (FOR CH) &9.3X&12.5 CR BLK	1
12	611-388	(+) MACHINE SCREW (FH) M3X8 (+) FH BLK	2
13	895-040	KEY PAD SILICONE RUBBER	1
14	420-709-9	JACK MODULAR 1130-662	1
15	650-050-0003	CONTROL HEAD P.C.B. ASSY.	1
16	420-108-4A	SPEAKER 4 OHM 5.0W 71MM PB7401A3Y26	1
17	623-034	(+) TAPPING SCREW (PH) T3X6-1S (+) PH ZN-PLAT	3
18	853-078	POST BSBM NI-PLAT	1
19	752-732	PLATE (ESC MTG) SPC T2	1
20	613-174	(+) MACHINE SCREW (FH) M3X5 (+) FH NI-PLAT	1
21	622-039	(+) TAPPING SCREW (BH) T2X6-1S (+) BH ZN-PLAT	2
22	895-044	GASKET (ESC) CR BLK	1
23	702-416-AB	FRAME ALDC12 (SM-2450)	1
24	623-760	(+) TAPPING SCREW (BH) T3X18-2S (+) BH NI-PLAT	2
25	427-411-4	WIRE EMI GASKET 43SM15 (SM-2450)	1
26	427-411-4A	WIRE EMI GASKET 43SM20 (SM-2450)	1
27	772-181	SHIELD CAN SPTE T0.3	1
28	723-844	BRACKET TR SK5 T0.5 NI-PLAT	2
29	895-047	GASKET (EXT JACT) CR BLK	1
30	613-040-S	(+) MACHINE SCREW (PH) M3X6 (+) PH ZN-PLAT 1	12
31	650-000-0001	MAIN P.C.B. ASSY. SM-2150/VHF	1
32	772-298	SHIELD COVER SPTE T0.5	1
33	752-729	CLIP (FOR TR) SUS304 T0.5	1
34	772-243	SHIELD CAN NSP T0.3	1
35	895-041	RING CR BLK	1
36	421-677-7	CONNECTOR BOX SOCKETBCS-110-P-D-HE	1
37	772-179	SHIELD CASE (FOR VCO)	1
38	613-755-SF	(+) MACHINE SCREW (PH) M3X7 (+) PH NI-PLAT	4
39	895-043	GASKET (BRKT) CR BLK	1
40	723-823	BRACKET ALDC12	1
41	612-289	(+) MACHINE SCREW (BH) M2X5 (+) BH BLK	6
42	504-367-B	2P PLUG ASS'Y SH-50101 (SM-2450)	1
43	719-020	COVER TOP ALDC12	1
44	895-075	RUBBER WASHER &6.2X&3.1XT0.5 N.B.R BLK	4
45	660-449	WASHER 6X3.2X0.5T SPC NI-PLAT	4
46	613-764	(+) MECHINE SCREW (PH) M3X20 (+) PH SUS	4
47	893-700	FOOT &11X5 RUBB.STIC.	4
48	613-369	(+) MACHINE SCREW (BH) M3X15 (+) BH ZN-PLAT	1
49	508-085-A	MIC BRACKET ASS'Y	1
50	660-449	WASHER 6X3.2X0.5T SPC NI-PLAT	2
51	662-310	WASHER SPRING M3 NI-PLAT	2
52	613-299	(+) MACHINE SCREW (BH) M3X6 (+) BH NI-PLAT	2
53	723-834	BRACKET SPC T2.0	1
54	600-051	SECURING SCREW M6X9 (P:1) BLK	2
55	661-605	WASHER FLAT M6 ZN-PLAT	2
56	662-606	WASHER SPRING M6 ZN-PLAT	2
57	625-007	(+) TAPPING SCREW (TH) T5X12-1S (+) TH ZN-PLAT	2
58	772-241	SHIELD PLATE SPTE T0.3	1
59	772-242	SHIELD CAN SPTE T0.5	1
60	772-132-A	SHIELD CAN (FR-P) NSP T0.2	1
61	752-769	FINGER STRIP SUS304 T0.3	1
62	895-247	CAP (FOR EXT. JACK)	1
63	662-305	WASHER SPRING M3 ZN-PLAT	4

## SM-2450/UHF EXPLODED VIEW PARTS LIST

REF #	PART #	DESCRIPTION	QTY
1	801-282-A	E.S.C NORYL N190J-7002	1
2	905-510	FELT 30-R16.5 (2) XT0.3 FELT BLK	1
3	795-654	OVERLAY LEXAN T0.5	1
4	826-137	KNOB (FOR VOL) ABS 94HB BLK	1
5	826-120	KNOB (FOR CH) ABS 94HB BLK	1
6	650-346	NUT RING (FOR VOL) M7X0.75 (P) &9.9 BSBM	1
7	650-335	NUT RING (FOR CH) M9X0.75 (P) &11 BSBM	1
8	661-701	WASHER (FOR VOL) T0.5 SPC	1
9	662-901	WASHER (FOR CH) 13X9.3XT0.5 SPC	1
10	894-650	RING (FOR VOL) &10X&6.9XT0.8 SILL.RUBB BLK	1
11	895-095	RING (FOR CH) &9.3X&12.5 CR BLK	1
12	611-388	(+) MACHINE SCREW (FH) M3X8 (+) FH BLK	2
13	895-040	KEY PAD SILICONE RUBBER	1
14	420-709-9	JACK MODULAR 1130-662	1
15	650-050-0003	CONTROL HEAD P.C.B. ASSY.	1
16	420-108-4A	SPEAKER 4 OHM 5.0W 71MM PB7401A3Y26	1
17	623-034	(+) TAPPING SCREW (PH) T3X6-1S (+) PH ZN-PLAT	3
18	853-078	POST BSBM NI-PLAT	1
19	752-732	PLATE (ESC MTG) SPC T2	1
20	613-174	(+) MACHINE SCREW (FH) M3X5 (+) FH NI-PLAT	1
21	622-039	(+) TAPPING SCREW (BH) T2X6-1S (+) BH ZN-PLAT	2
22	895-044	GASKET (ESC) CR BLK	1
23	702-416-AB	FRAME ALDC12 (SM-2450)	1
24	623-760	(+) TAPPING SCREW (BH) T3X18-2S (+) BH NI-PLAT	2
25	427-411-4	WIRE EMI GASKET 43SM15 (SM-2450)	1
26	427-411-4A	WIRE EMI GASKET 43SM20 (SM-2450)	1
27	772-181	SHIELD CAN SPTE T0.3	1
28	723-844	BRACKET TR SK5 T0.5 NI-PLAT	2
29	895-047	GASKET (EXT JACT) CR BLK	1
30	613-040-S	(+) MACHINE SCREW (PH) M3X6 (+) PH ZN-PLAT 1	11
31	650-000-0002	MAIN P.C.B. ASSY. SM-2450/UHF	1
32	771-989	SHIELD COVER SPTE T0.5	1
33	752-729	CLIP (FOR TR) SUS304 T0.5	1
34	772-243	SHIELD CAN NSP T0.3	1
35	895-041	RING CR BLK	1
36	421-677-7	CONNECTOR BOX SOCKETBCS-110-P-D-HE	1
37	772-179	SHIELD CASE (FOR VCO)	1
38	613-755-SF	(+) MACHINE SCREW (PH) M3X7 (+) PH NI-PLAT	4
39	895-043	GASKET (BRKT) CR BLK	1
40	723-823	BRACKET ALDC12	1
41	612-289	(+) MACHINE SCREW (BH) M2X5 (+) BH BLK	6
42	504-367-B	2P PLUG ASS'Y SH-50101 (SM-2450)	1
43	719-020	COVER TOP ALDC12	1
44	895-075	RUBBER WASHER &6.2X&3.1XT0.5 N.B.R BLK	4
45	660-449	WASHER 6X3.2X0.5T SPC NI-PLAT	4
46	613-764	(+) MECHINE SCREW (PH) M3X20 (+) PH SUS	4
47	893-700	FOOT &11X5 RUBB.STIC.	4
48	613-369	(+) MACHINE SCREW (BH) M3X15 (+) BH ZN-PLAT	1
49	508-085-A	MIC BRACKET ASS'Y	1
50	660-449	WASHER 6X3.2X0.5T SPC NI-PLAT	2
51	662-310	WASHER SPRING M3 NI-PLAT	2
52	613-299	(+) MACHINE SCREW (BH) M3X6 (+) BH NI-PLAT	2
53	723-834	BRACKET SPC T2.0	1
54	600-051	SECURING SCREW M6X9 (P:1) BLK	2
55	661-605	WASHER FLAT M6 ZN-PLAT	2
56	662-606	WASHER SPRING M6 ZN-PLAT	2
57	625-007	(+) TAPPING SCREW (TH) T5X12-1S (+) TH ZN-PLAT	2
58	772-241	SHIELD PLATE SPTE T0.3	1
59	772-242	SHIELD CAN SPTE T0.5	1
60	772-132-A	SHIELD CAN (FR-P) NSP T0.2	1
61	752-769	FINGER STRIP SUS304 T0.3	1
62	895-247	CAP (FOR EXT. JACK)	1
63	662-305	WASHER SPRING M3 ZN-PLAT	4

*Intentionally Left Blank*

## Free Manuals Download Website

<http://myh66.com>

<http://usermanuals.us>

<http://www.somanuals.com>

<http://www.4manuals.cc>

<http://www.manual-lib.com>

<http://www.404manual.com>

<http://www.luxmanual.com>

<http://aubethermostatmanual.com>

Golf course search by state

<http://golfingnear.com>

Email search by domain

<http://emailbydomain.com>

Auto manuals search

<http://auto.somanuals.com>

TV manuals search

<http://tv.somanuals.com>