

# USER'S MANUAL



Digital Satellite Receiver

□ HTS 2100S<sup>+</sup>

**MAX***plus*<sup>+</sup>

# Contents

<b>1. Introduction</b> .....	<b>2</b>
1.1 Overview	
1.2 Main Features	
<b>2. Safety/Precautions</b> .....	<b>3</b>
2.1 Safety	
2.2 Precautions	
<b>3. Points to Check before Use</b> .....	<b>5</b>
3.1 Accessories	
<b>4. Controls/Functions</b> .....	<b>6</b>
4.1 Front Panel	
4.2 Rear Panel	
4.3 Remote controller	
<b>5. How to Connect</b> .....	<b>10</b>
<b>6. Operation</b> .....	<b>11</b>
6.1 Getting Started	
6.2 System Setting	
6.3 Channels	
6.4 Electronic Program Guide	
6.5 Games	
6.6 System Information	
6.7 Common Interface	
<b>7. Troubleshooting</b> .....	<b>37</b>
<b>8. Specifications</b> .....	<b>38</b>

# Introduction

## 1.1 Overview

This satellite receiver is designed for the reception of free-to-air and encrypted channels. Depending on your location, enjoy the rich choice of up to 5,000 different channels broadcasting a large range of programs: culture, sports, cinema, news, events, etc. This receiver is assembled with highly qualified electronic parts.

## 1.2 Main Features

- ▶ MPEG-II Digital & fully DVB compliant.
- ▶ Supports 1 CAM of DVB Common Interface standard (Conax, Cryptoworks, Irdeto, NagraVision, SECA, Viaccess, BetaCrypt and etc)
- ▶ On-screen display with 256 color resolution.
- ▶ DiSEqC control Version 1.0, 1.1, 1.2 and USALS compatible.
- ▶ Renameable 8 favorite channel groups.
- ▶ Fast channel change less than 1 second.
- ▶ Advanced Blind search function.
- ▶ Powerful channel control by Favorites, Lock, Skip, Move and Delete.
- ▶ Channel sorting by Alphabet, Transponder and Scrambled.
- ▶ Multilingual language OSD & menu: English, Italian, Turkish, Arabic, Parsi, German, French, Russian, Spanish, Portuguese, Dutch.
- ▶ Extended EPG and program reservation through EPG.
- ▶ Teletext by OSD/ VBI
- ▶ Supports multilingual subtitle
- ▶ Supports multilingual audio language
- ▶ Last channel memory function.
- ▶ Total 5,000 channels programmable.
- ▶ Advanced channel list menu
- ▶ Multi satellite search
- ▶ Games with stereo sounds
- ▶ Software & channel database upgrade via RS-232C: PC to STB/ STB to STB
- ▶ Parental lock/ Installation Lock / Receiver Lock / Channel Lock / Lock Channel Confirm.
- ▶ Digital audio output [S/PDIF]
- ▶ Multi picture display
- ▶ Zoom function.
- ▶ Color adjustment function

DiSEqC is a trademark of EUTELSAT

# Safety/Precautions

## 2.1 Safety

Be sure to read this user's manual before starting the operation of the unit.

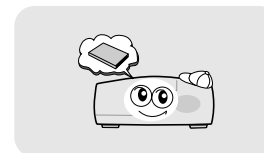

Do not touch the power cord with wet hands as it may cause electric shock.

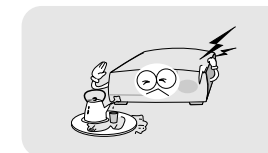

Never open the cover. It is very dangerous to touch the inside of the unit due to possible electric shock.

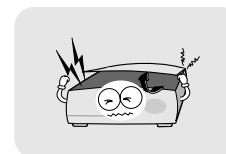

Place the unit in a well ventilated and no-heat environment.

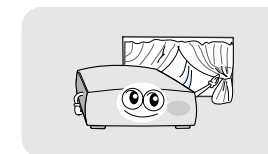

When you do not use this unit for a long time, make sure that power cord is pulled out from the outlet. Also do not use a damaged power cord as it may cause fire or electric shock.

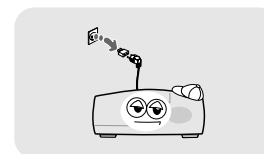

A professional installation is required. If reception is interrupted, contact your local service centre.

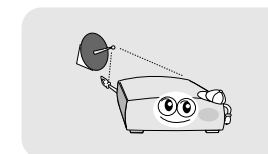

## 2.2 Precautions

### When installing the unit

Install the unit horizontally. An uneven installation may cause the unit to be damaged.

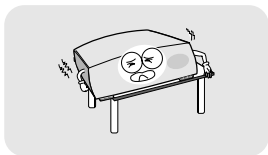

Do not put heavy items such as a TV set on the unit. That may damage the unit.

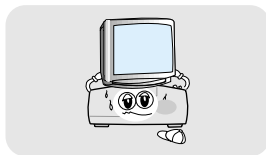

Do not leave the unit where the water drops or splashes.



Do not put water holding items such as vases on the unit.

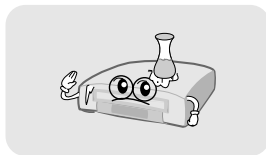

Do not install the unit:

- Where it is subject to vibrations
- Where it is exposed to direct sunlight
- Where there is humidity
- Where the temperature is too high or too low.
- Where there is no ventilation

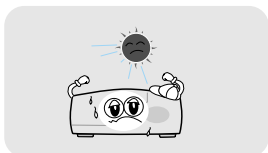

Moving the unit to a hot area from a cold one will cause condensation. Do not operate the unit for one or two hours or until it has dried completely.

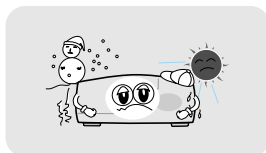

## Points to Check before Use

### 3.1 Accessories

The accessories below are included with this receiver:

User's manual : 1

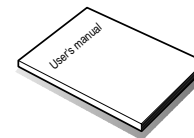

Remote control : 1



Batteries (AAA type) : 2

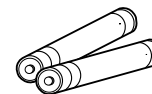

► If any of the above-listed accessories is missing, contact your sales representative.

### 3.2 The Satellite dish

Your dish should be properly installed and azimuth and elevation must be precisely set up.

► This unit supports DiSEqC 1.2 and can work with a compatible antenna positioner.

Ask your dealer for information.

# Controls/Functions

## 4.1 Front Panel

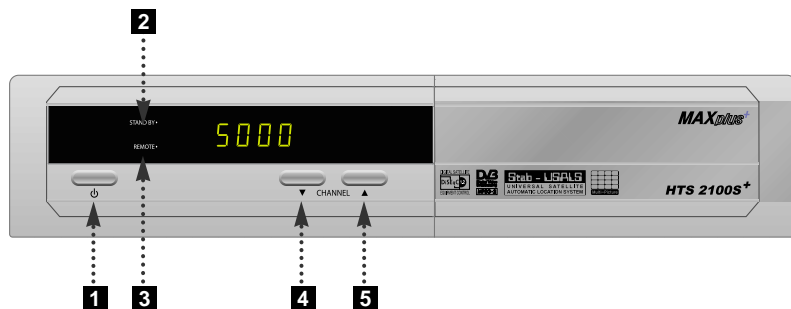

- 1 Power** : Switches the receiver between 'Standby' and 'Power ON' modes.
- 2 Standby/Power on Indications Lamp** : Flashes red light in 'Standby' mode and shows no light in 'Power ON' mode.
- 3 Indication Light** : Flashes when a key on the Remote Control Unit (RCU) is pressed.
- 4 - 5 CH.** (▲▼): To switch channels or change the cursor position on the application screen.

## 4.2 Rear Panel

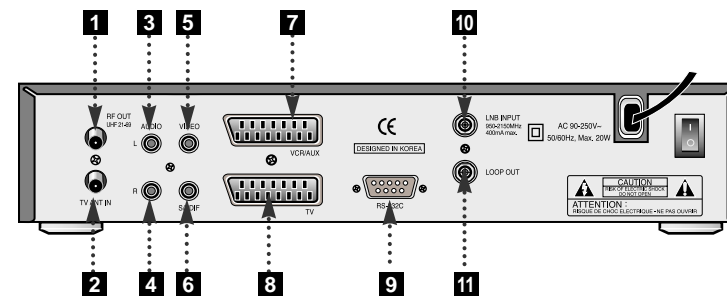

No.	Name	Connector	Function
1	RF OUT UHF	21-69 IEC 169-2 male	Output to TV
2	TV ANT IN	IEC 169-2 female	Input from terrestrial antenna
3	AUDIO L	RCA cinch	Left audio output
4	AUDIO R	RCA cinch	Right audio output
5	VIDEO	RCA cinch	Composite video output
6	S/PDIF	RCA cinch	Digital audio output
7	VCR/AUX SCART	SCART	CVBS Video Output CVBS, RGB Video Input Audio Output
8	TV SCART	SCART	CVBS, RGB Video Output Audio Output
9	RS-232C	DB-9	Low speed serial port
10	LNB INPUT	IEC 169-24 female	IF input from LNB to digital tuner
11	LOOP OUT	IEC 169-24 female	IF loop-through output from digital tuner

## 4.3 Remote controller

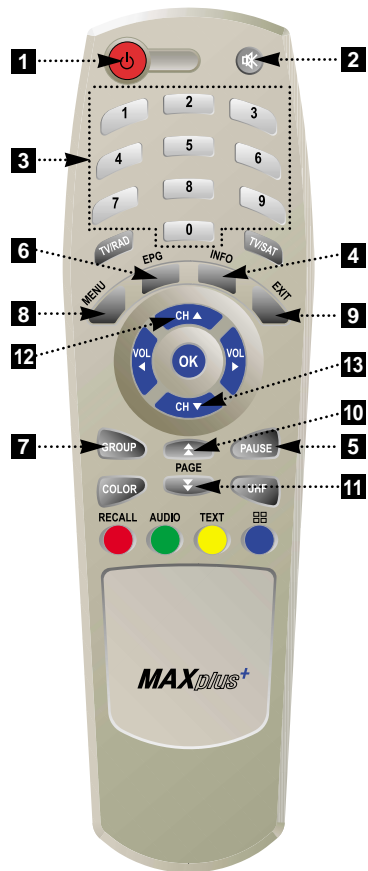

- 1 POWER** : To turn the receiver On/Off.
- 2 MUTE** : To turn the sound On/Off.
- 3 Numeric Keys (0-9)** : To enter numerical settings (such as channel numbers) directly.
- 4 INFO** : To show information about the current program. Press twice to show detail.
- 5 PAUSE** : To pause the video. Press again to resume the video.
- 6 EPG** : To show the TV/Radio program guide.
- 7 GROUP** : To change the channel groups(Satellites or favorite groups).
- 8 MENU** : To enter or exit the main menu.
- 9 EXIT** : To exit from the present menu and move to the previous menu.
- 10 - 11 Double arrow UP/DOWN** : To move to the next or previous page when many pages are available.
- 12 - 13 Up & Down** : To switch channels in non-menu mode and move the cursor up/down in menu mode.

## 4.3 Remote controller

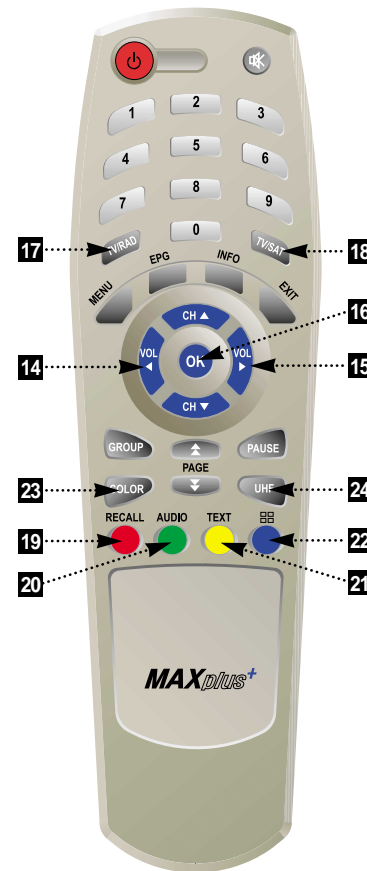

- 14 - 15 Left & Right** : To change the volume level in non-menu mode and modify a setting in menu mode.
- 16 OK** : To show the Channel List in non-menu mode and select an item or confirm in menu mode.
- 17 TV/RADIO** : To switch between TV and Radio.
- 18 TV/SAT** : To switch the TV output source between the satellite input and the UHF/VHF antenna input.
- 19 RECALL(RED)** : To move to the previous channel. Used for special functions in menu mode.
- 20 AUDIO(GREEN)** : To show the Multi-language audio track, the stereo-mono mode and subtitle information. Used for special functions in menu mode.
- 21 TEXT(YELLOW)** : To show the teletext contents if teletext is transmitted. Used for special functions in menu mode.
- 22 BLUE** : To display multiple pictures.
- 23 COLOR** : To control the brightness, contrast and color of a picture.
- 24 UHF** : To adjust UHF channel.

# How to Connect

## When Connecting the Receiver to a TV with RF connectors

- 1 Connect the TV antenna to TV ANT IN
- 2 Connect the RF-IN of the TV to RF-OUT
- 3 Connect the Video and Audio of the TV to Video and Audio: connect the red and white connectors to Audio R and Audio L, and the yellow connector to Video
- 4 Connect your satellite dish

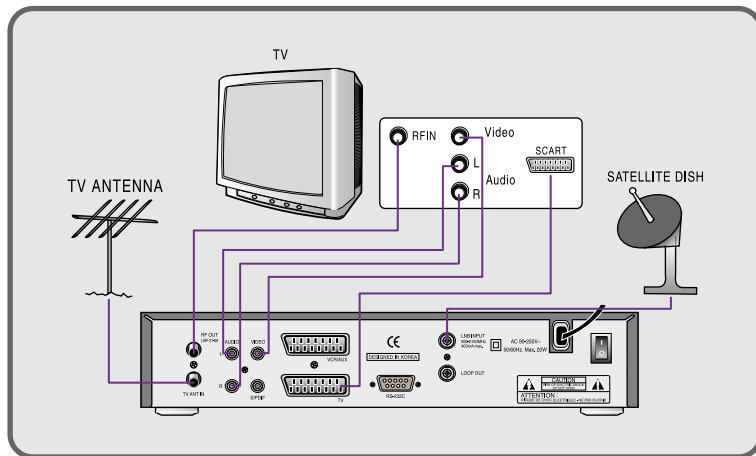

# Operation

## 6.1 Getting Started

After your receiver is powered on, proceed with installation as follows :







### 1) Menu Language Setting

- 1 Turn on your TV and receiver.
- 2 The pop-up menu for language selection will appear. <Figure 6-1>  
Select one language and press  to proceed.



<Figure 6-1>

## 2) Antenna Setup

- 1 Press the MENU button to display the main menu.
- 2 Use  /  and  /  to move in the menu.
- 3 Press  on 'Dish Setting'. The following window will appear. <Figure 6-2>  
If you have a motorized dish, press  on 'Motorized Setting'. < Figure 6-3>

\* **Note** : Enter a 4-Digit password if need arise. The default password is '0000'.





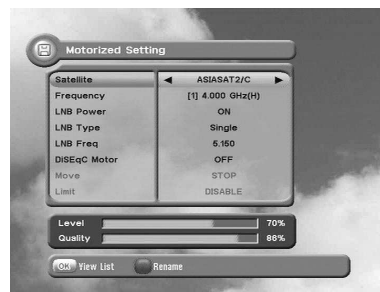

&lt;Figure 6-2&gt;



&lt;Figure 6-3&gt;

- 4 Select the item that you want to edit, and set its parameters as desired. <Dish Setting>
  - **LNB Power** : Select among ON/OFF/13V/18V.
  - **LNB Type** : Select among Single/Universal/OCS.
  - **LNB Freq** : Set the frequency of the LNB oscillator.
  - **22KHz** : When not AUTO, set the signal path from LNB or switch by selecting a control signal among 0/22KHz.
  - **DiSEqC switch** : Select DiSEqC protocol among OFF/1.0/1.1 as appropriate for your configuration.
  - **Committed/Uncommitted** : Select the DiSEqC port.
- 5 Select the item that you want to edit and set its parameters as desired. <Motorized Setting>
  - **Frequency** : If the default TP frequency is not appropriate, you can select another TP frequency at which to check for signal.
  - **DiSEqC Motor** : Select DiSEqC protocol among OFF/1.2/USALS as appropriate for your Motor.

(When the DiSEqC Motor parameter is set as 1.2)

- **Move** : You can move the dish to the West/East.
- **Limit** : If you want to set limits, press .
- **Disable Limit** : You can disable the East and West limits.
- **Goto Center** : Move the dish to the initial 0 position.
- **Set East / West Limit** : Move the dish East or West using  / . Press  to set East or West limit.

(When the DiSEqC Motor parameter is set as USALS)

- **Sat Degree** : Satellite location.
- **Antenna Position** : Press .
- **Goto Reference** : Move the dish to the reference 0 position.
- **Antenna Longitude** : Your longitude at present.
- **Antenna Latitude** : Your latitude at present.
- \* **Note** : You need to know what LNB you are using to correctly set the L.O. (local oscillator) frequency.
- \* **Note** : You need to understand how your receiver is connected to properly set the 22KHz and DiSEqC.





- 6 When you are done, press the EXIT button.



### 3) Satellite Scan

Through this function, the receiver searches for all the available channels and saves them in memory.

#### ► Auto Scan <Figure 6-4>

- ① To select more than one satellite, press the RED button when the selection bar is positioned on the satellite.
- ② Press  on the names of the satellites that you want to scan under 'Satellite List'. Press the EXIT button to close the 'Satellite List'.
- ③ Press  /  and set the 'Search Type' and 'Network Search' parameters.
  - **Search Type** : Decide for which channels to search (All channels/ Free channels only/ TV channels only).
  - **Network Search** : Set ON to find more transponders (frequencies) through a Network Information Table (NIT) scan. That is, when the broadcaster is sending a NIT through a given transponder, the receiver will also scan for transponders listed in the NIT and not otherwise recognized. (this can happen when a transponder is new)
- ④ Press  under 'SCAN' to scan the selected satellites. <Figure 6-5>





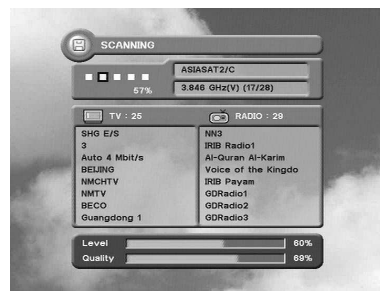



<Figure 6-4>



<Figure 6-5>

#### ► Blind Search <Figure 6-6>

- ① Select the satellite you want to search by pressing  /  buttons on the remote. You can select more satellites by pressing RED button on the remote.
- ② Select the options by pressing  /  /  buttons on the remote.
  - Symbol Rate : Select FULL / 7.5M Over / 7.5M Under / 3.7M Under / DETAIL
  - Polarization : Select ALL / Vertical / Horizontal
  - Scan Mode : Select ALL / FREE / TV
- \* **Note** : 'FULL' is meaning of full range of S/R. It performs blind search in full range of SR. It searches all range of SR.
- \* **Note** : 'DETAIL' performs blind search in full range of SR with enhanced way, it searches all the SR in double especially for the low SR such as 3Mhz below. Detail option performs blind search by 2 pass way, therefore it is able to detect more channels by this option. Detail blind search takes more time than other options because of the above reason.
- \* **Note** : If users do not mind that it takes more time on 'detail' option, we recommend that users should use detail blind search especially on low SR.
- ③ Press  button on the remote to begin blind scan of all of the satellite in the satellite list.





<Figure 6-6>

## 6.1 Getting Started

### ► Manual Scan <Figure 6-7>

- ❶ Select a transponder.
- ❷ To change a transponder's information (Frequency, Symbol Rate), use the **NUMERIC** buttons.
- ❸ To add a new transponder, press the **GREEN** button.
- ❹ To delete a transponder, press the **YELLOW** button with the cursor next to the Frequency parameter.
- ❺ To search a transponder, set its different parameters and press .

### ► Package Identifier (PID) Scan <Figure 6-8>

- ❶ Select a transponder.
- ❷ To change a transponder's information (Frequency, Symbol Rate), use the **NUMERIC** buttons.
- ❸ To add a new transponder, press the **GREEN** button.
- ❹ To delete a transponder, press the **YELLOW** button with the cursor next to the Frequency parameter.
- ❺ To search a transponder, set its different parameters and press  / . You can search a specific channel of the transponder by setting its PID data (Video, Audio and PCR).

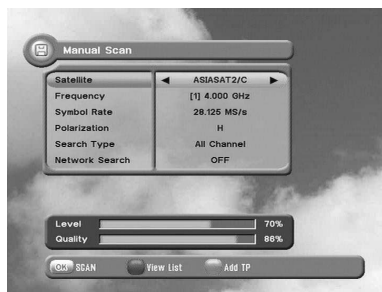

<Figure 6-7>

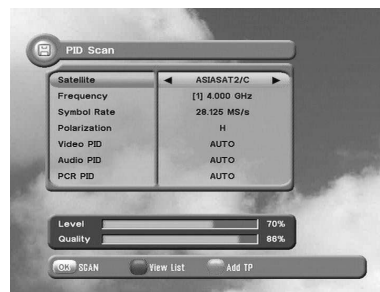



<Figure 6-8>

**\* Note :** If you cannot access programs after correctly completing a scan procedure, please contact your seller or your installer.

## 6.1 Getting Started





### 4) Channel Selection

You can use  /  to navigate between channels until you find the channel you want.

- If you know the channel number, you can enter it with the **NUMERIC** buttons and wait 2 seconds until the channel is changed.
- If you know the channel name or transponder or CAS, you can press  to display the channel list <Figure 6-9>





<Figure 6-9>

- ❶ In the left side of screen, detailed information about the selected channel will be displayed. (Satellite Name, Frequency(Polar) and Channel Name)
- ❷ You can use the following buttons to navigate between channels:
  -  /  : Moves one channel up/ down.
  -  /  : Moves one page up / one page down.
  - **RED** : Shows all channels in the current group.
  - **GREEN** : Shows all channels sorted alphabetically.
  - **YELLOW** : Shows all channels sorted by Transponder.
  - **BLUE** : Shows all channels sorted by CAS system.
- ❸ Press  when the selection bar is positioned on the desired channel.

### 5) Other Functions of the Remote Control

#### ► Volume Control

- ① While watching a program, press  or  to control the volume.
- ② You can press the **MUTE** button to remove the sound of the program: the mute icon will be displayed. Press the **MUTE** button again to turn the sound back on.

#### ► Channel Information

- ① You can press the **INFO** button to display the information banner for a few seconds.
- ② If you then press the **INFO** button again, a detailed banner will be displayed.

#### ► TV/ SAT switching

You can press TV/SAT to select the source of the signal to receive:

- **TV Mode** : Signal from TV ANT INPUT will be out. (Front will display 'TV')
- **VCR Mode** : Signal from VCR SCART INPUT will be out. (Front will display 'VCR')
- **SAT Mode** : Signal from Satellite will be out. (Front will display the channel number)

#### ► TV/ RADIO switching

You can press this key to change from a TV channel to a Radio channel or vice versa.

#### ► RECALL(RED)

Press to return to the previous channel.

#### ► Subtitle / Audio (GREEN)

Press to adjust the subtitle and/or audio status of the current channel:

- **Audio Mode** : Select between, Stereo → Mono-Left → Mono-Right
- **Audio Track** : Select between tracks available in this program

**\* Note : These subtitle and audio parameters are workable only when the desired channel supports these functions.**

#### ► Teletext(YELLOW)

The Teletext service is a text data service sometimes available from the Service Provider.

#### ► PAUSE

You can press this key to pause the video. Press it again to resume the video. When video is paused, you can zoom in sections of it.

- ① Select a section using  /  /  / .
- ② Press  to zoom in. Press  again to zoom out.

#### ► GROUP

When watching TV or listening to Radio, you can press this button to view the list of satellites and/or favorite channel groups.

Only registered satellites and favorite groups are displayed.

#### ► Multi Picture Display <Figure 6-10>

You can press the BLUE button to display multiple pictures; you can choose the number of pictures such as 1X2, 2X2, 2X3 or 3X3.





<Figure 6-10>

## 6.2 System Setting

### 1) Time Settings

This submenu allows you to set your local time, wake up time, wake up channel and sleep time. <Figure 6-11>

- **GMT Usage** : Set this ON for the local time to be determined by adjusting the time difference with the GMT (Greenwich Meantime) according to your location.
- **Current Date** : If GMT Usage is OFF, you can modify the date by pressing .
- **Current Time** : If GMT Usage is OFF, you can modify the time using the **NUMERIC** buttons.
- **Local Offset** : If GMT Usage is ON, Local time is GMT time + Local Offset.
- **Wake Up Mode** : Select the wake up frequency. (Off/Once/Daily)
- **Wake Up Time** : Set the wake up time using the **NUMERIC** buttons.
- **Wake Up Channel** : Press  to set the wake up channel.
- **Sleep Mode** : Select the Sleep frequency. (Off/Once/Daily)
- **Sleep Time** : Set the sleep time using the **NUMERIC** buttons.



<Figure 6-11>

## 6.2 System Setting

### 2) A/V Output Settings

This submenu allows you to specify the audio/video output. <Figure 6-12>

- **Audio Language** : Set the default audio language when selecting a channel.
- **Subtitle Language** : Set the default subtitle language.
- **Video Format** : Select the video output format. (AUTO/PAL/NTSC)
- **Output Select** : Select the TV SCART output format.(CVBS/RGB)
- **Screen Format** : Select the TV aspect ratio. (16:9 / 4:3 Letter-Box / 4:3 Pan Scan)
- **RF Type** : If the Video Format is set to PAL, select among supported PAL standards. (PAL B/G, PAL I, PAL D/K).
- **RF Channel** : Set the RF channel to which to display the audio and video signals on your TV set (21 to 69) ; if you select 40, they will be displayed at channel 40 on your TV set.
- **SPDIF** : Set this ON to enable digital audio output.

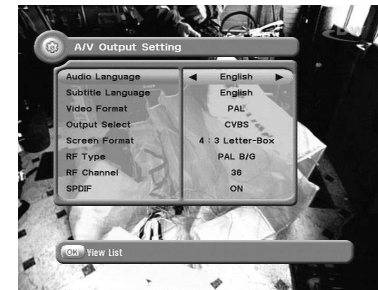

<Figure 6-12>

### 3) OSD Settings

This submenu allows you to set the menu language, OSD transparency and Information and Volume timeouts. <Figure 6-13>

- **Menu Language** : Select the desired language for the menu.
- **Transparency** : Set the OSD transparency of the menu. (1% ~ 100%)
- **Information Timeout** : Select the display duration of the information banner. (1, 2, 3, 5 or 10 seconds)
- **Volume Timeout** : Select the display duration of the volume box. (1, 2, 3, 5 or 10 seconds)



<Figure 6-13>

### 4) Security Settings

This submenu allows you to set password options and to lock or unlock access to menus (Note: PIN code and password are the same). <Figure 6-14>

- **Receiver Lock** : Set ON to require entering a PIN code at powering on.
- **Install Lock** : Set ON to require entering a PIN code to access the installation menu.
- **Channel Lock** : Set ON to require entering a PIN code to access the channels menu.
- **Lock Channel Confirm** : Set ON to require entering a PIN code to access a locked channel.
- **Age Limit** : Set to prevent children or unauthorized people from watching programs. Select among (Free/ 8 above/12 above/15 above/18 above). When program information (age limit) is available from broadcaster and this age limit exceeds the selection, a PIN code is required to access the channel/program.
- **Current Password** : To change your password, first enter your current password.
- **New Password** : Enter the new password that you want to set.
- **Verify Password** : Enter the new password again for confirmation.

**\* Note : The default password is '0000'.**



<Figure 6-14>

### 5) Database Reset

This submenu allows you to restore the factory set values (useful when encountering problems after changing settings). <Figure 6-15>

- **Delete Radio Channels** : Erase all radio channels in the database.
- **Delete Scramble Channels** : Erase all scramble channels in the database.
- **Delete All Channels** : Erase all channels.
- **Factory Set** : Erase all channels and restore the factory default settings.

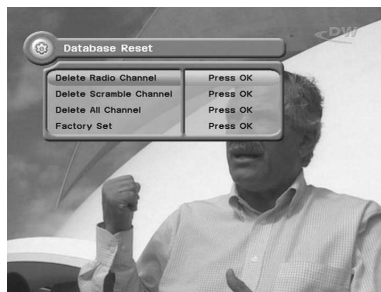

<Figure 6-15>

### 6) Calculator

This submenu allows you to use a calculator on the screen. <Figure 6-16>

- You can switch between Hex (Hexadecimal) and Dec (Decimal) basis for arithmetic with the **RED** button of the remote control unit.
- Use the Numerical and the  $\frac{1}{x}$  /  $\frac{1}{y}$  /  $\frac{1}{z}$  buttons on the remote control unit.

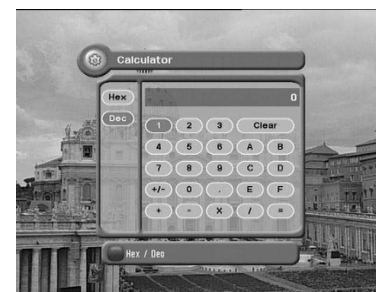

<Figure 6-16>

### 7) Data Transfer

This submenu allows you to transfer the software from a receiver to another receiver. You can select and transfer Firmware/ Channel Data/ Games. <Figure 6-17>

- **Firmware** : Transfer the firmware of a receiver to another receiver.
- **Channel Data** : Transfer the channel data of a receiver to another receiver.
- **Games** : Transfer the game data of a receiver to another receiver.



<Figure 6-17>

### 1) Set Favorites

This submenu allows you to set up favorite groups of channels. You can select **TV** or **Radio** channels in an alternative way by pressing the **TV/RADIO** button. The receiver supports 8 favorite groups.

- 1 Press on 'Set Favorites'. The list of groups will be displayed. <Figure 6-18>
- 2 Press / and to choose a group. The following menu will be displayed. <Figure 6-19>  
If you want to change the name of a favorite group, press the **RED** button.
- 3 Press to add (or remove if previously added) the selected channel to/from the favorite channel group.
- 4 Press the **EXIT** button to return to the previous menu.



&lt;Figure 6-18&gt;

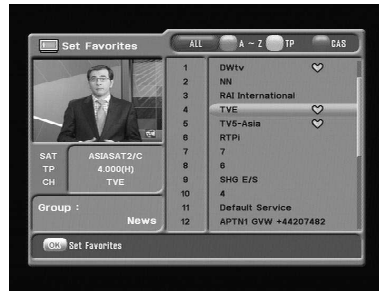

&lt;Figure 6-19&gt;

### 2) Edit Channels

This submenu allows you to rename channels and input user PID. You can select **TV** or **Radio** channels in an alternative way by pressing the **TV/RADIO** button. You can choose a channel list group by pressing the **GROUP** button.

- 1 Press on 'Edit Channels'. The following menu will be displayed. <Figure 6-20>
- 2 Press on the channel that you want to edit.
- 3 Press on 'Edit Name' to rename the channel; the keypad will be displayed.
- 4 Similarly, you can edit the PID data using the **NUMERIC** keys.

**\* Note :** *The VIDEO PID, AUDIO PID and PCR PID are very important for optimal satellite signal reception. We recommend you get professional advice where available.*



&lt;Figure 6-20&gt;

### 3) Move Channels

This submenu allows you to move channels.

You can select **TV** or **Radio** channels in an alternative way by pressing the **TV/RADIO** button. You can choose a channel list group by pressing the **GROUP** button.

- 1 Press on 'Move Channels'. The following menu will be displayed. <Figure 6-21>
- 2 Press on the channel that you want to move; a 'move' icon will be displayed.
- 3 Use the / / / / **NUMERIC** buttons to move the selected channel.
- 4 Press again to place the channel.
- 5 Press the **EXIT** button to return to the previous menu.





&lt;Figure 6-21&gt;

#### 4) Lock Channels

This submenu allows you to lock channels to control access to them. Once a channel is locked, you will be asked to enter a password whenever you try to watch it. You can select TV or Radio channels in an alternative way by pressing the **TV/RADIO** button. You can choose a channel list group by pressing the **GROUP** button.



**\* If you set 'Lock Channel Confirm' (refer to <6.2>security setting) to OFF, you will not be asked to enter a password even if the channel is locked.**

- 1 Press  on 'Lock Channels'. The following menu will be displayed. <Figure 6-22>
- 2 Press  on the channel that you want to lock/unlock; the lock icon will be displayed/removed.
- 3 Press the **EXIT** button to return to the previous menu.





<Figure 6-22>

#### 5) Skip Channels

This submenu allows you to skip channels. Once a channel is set to be skipped, it will be whenever you navigate channels using  /  in non-menu mode. You can select TV or Radio channels in an alternative way by pressing the **TV/RADIO** button. You can choose a channel list group by pressing the **GROUP** button.

**\* Note : You can still access a 'skipped' channel if you enter its number using the NUMERIC buttons in non-menu mode.**

- 1 Press  on 'Skip Channels'. The following menu will be displayed. <Figure 6-23>
- 2 Press  on the channel that you want to skip/un-skip; the skip icon will be displayed / removed.
- 3 Press the **EXIT** button to return to the previous menu.





<Figure 6-23>



### 6) Delete Channels

This submenu allows you to delete channels. You can select TV or Radio channels in an alternative way by pressing the **TV/RADIO** button. You can choose a channel list group by pressing the **GROUP** button.

**\* Note : Be careful! If you delete a channel, you will not be able to access it again until you rescan.**









- 1 Press  on 'Delete Channels'. The following menu will be displayed. <Figure 6-24>
- 2 Press  on the channel that you want to set/unset for deletion; the delete icon will be displayed/removed.
- 3 Press the **INFO** button to delete all channels in the current list; you will be asked to enter your password.
- 4 Press the **EXIT** button to return to the previous menu and confirm deletion.



<Figure 6-24>

### 1) EPG

This submenu allows you to access the electronic program guide when available.

- 1 Press the **EPG** button to display the guide menu. <Figure 6-25>
- 2 Press  /  to see the previous/next guide.
- 3 Press  /  /  /  to select another channel. <Figure 6-25>
- 4 Press  to watch the selected channel and access its EPG data.  
If you press  in the right side of the screen (Event display list).  
- If the current time EPG is selected, you will return to the previous menu and get signal from the selected channel.  
- If a future time (next) EPG is selected, the selected program will be reserved and the event color will change.
- 5 You can select TV or Radio channels by pressing the **TV/RADIO** button
- 6 You can choose a channel list group by pressing the **GROUP** button.
- 7 You can access the timer menu by pressing the **RED** button. <Figure 6-26>

### 2) Timer

This sub menu allows you to set the on/off time of your receiver.

- ① This submenu allows you to set on/off times of your receiver. To display the timer menu, press the **RED** button while in the guide menu. <Figure 6-26>
- ② Press to select a timer's parameter.
- ③ Press / to change the parameter.
  - **Timer No** : Select the timer that you want to modify. (1- 8)
  - **State** : Select the timer frequency. (off/once/daily/weekly)
  - **Date** : Press to display a Calendar pop-up; Select a date
  - **Start Time** : Input the time for your receiver power-on; use the **NUMERIC** buttons
  - **End Time** : Input the time for your receiver power-off; use the **NUMERIC** buttons
  - **Channel** : Press to display a Channel list pop-up; Select a channel

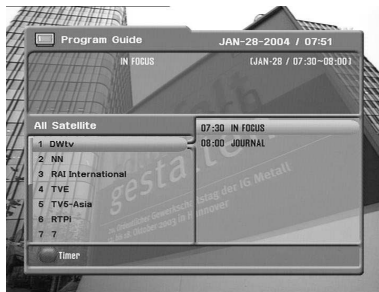

<Figure 6-25>

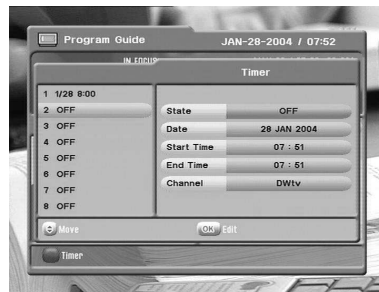

<Figure 6-26>

### 1) Tetris

- ① Press on 'Tetris'. The following menu will be displayed. <Figure 6-27>
- ② You can choose a skill level using / .
- ③ Press to start the game <Figure 6-28>, or press the **EXIT** button to return to the previous menu.
- ④ Press to rotate a block.
- ⑤ Press / to move a block.
- ⑥ Press to drop a block.
- ⑦ You can see the next block in the top-right small window.
- ⑧ Press the **EXIT** button to quit the game.



<Figure 6-27>



<Figure 6-28>

### 2) Sokoban

How to play Sokoban: you have to push the balls to their correct positions. The balls can only be pushed, never pulled, so you have to be careful not to push them into a corner where you can't get them out from. You can only push one ball at a time.

- ① Press on 'Sokoban'. The following menu will be displayed. <Figure 6-29>
- ② You can choose a skill level using / .
- ③ Press to start the game <Figure 6-30>, or press the **EXIT** button to return to the previous menu.
- ④ Press / / to move.
- ⑤ Press the **RED** button to undo the previous move. You can undo only one step.
- ⑥ Press the **GREEN** button to restart the game.
- ⑦ Press the **YELLOW/BLUE** buttons to jump to the previous/ next level. You can jump only between completed levels.

## 6.5 Games

- Press the EXIT button to quit the game.



<Figure 6-29>



<Figure 6-30>

### 3) Snake

- Press on 'Snake'. The following menu will be displayed. <Figure 6-31>
- You can choose a skill level using / .
- Press to start the game <Figure 6-28>, or press the EXIT button to return to the previous menu.
- Press / / / to move.
- Pass through the GREEN icon to increase your score; the length of the snake increases.
- Pass through the RED icon to decrease the snake's length.
- Avoid the BLACK icons. If you hit a BLACK icon (block), the game ends.
- Press the EXIT button to quit the game.

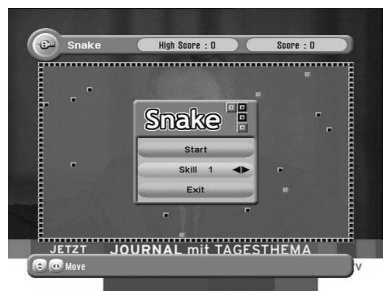

<Figure 6-31>



<Figure 6-32>

## 6.6 System Information

You can check the current information about your receiver such as receiver model name, S/W (software) version, H/W (hardware) version, manufacturing date, etc. <Figure 6-33>

- \* **Note** : This information is useful to download new software and/or repair the receiver.

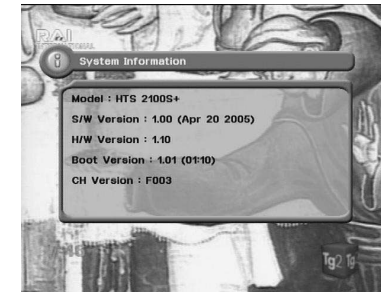

<Figure 6-33>

## 6.7 Common Interface

### 1) CAM Initializing

To enjoy scrambled channels, you will need a Common Interface Conditional Access Module (CAM) and a Smart Card from the service provider (program distributor). If you are subscribing to services from more than one service provider, you will need a Smart Card from each one, and may even need different CAMs (depending on the DVB Common Interface standard each uses). Since a Smart Card is connected to a single service provider, a limited range of channels will be available via it.



- \* **Note** : Without the CAM and the smart card, you can watch only Free-to-Air programs.

- Insert a CAM into a receiver's slot designed for it, and a Smart Card into the CAM.
- The message 'CAM Initializing' will appear on the screen. <Figure 6-34>
- After the message 'CAM Initializing' has disappeared, you can select the channel that you want to watch.



<Figure 6-34>

### 2) The Status of the CAM

- ① You can access detailed information about the CAM using the  /  keys in the Main Menu to select 'CI' and pressing . <Figure 6-35>
- ② Proceed with further instructions displayed on the screen to check more detailed information depending on the CAM in use.

**\* Note : Further detailed information is not mentioned in this manual since the information depends on the CAM in use.**

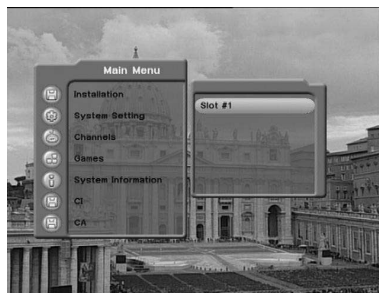

<Figure 6-35>

## Troubleshooting

There may be various reasons for the abnormal operation of the unit. Therefore, if the unit does not work properly, check it according to the procedures shown in the table below:

Problem	Possible causes	Remedy
The LED light on the front panel does not light.	The AC power cord is disconnected.	Connect the power cord properly into the power socket.
No Picture or sound.	Wrong connection of the video/audio output to the TV input terminal.	Connect the two terminals correctly with RCA or RF cable(s).
	Wrong connection of the satellite antenna cable.	Connect the antenna cable correctly.
	Wrong direction of the satellite antenna.	Adjust the direction of the antenna.
	No signal or weak signal.	Check the cable connections, the LNB and other equipment connected between the LNB and the receiver, or adjust the antenna.
Black-and-white screen or V-Hold.	Wrong setting of channel information in the MENU screen.	Type the setting values correctly.
	Your TV mode (PAL/NTSC) is different from the satellite broadcasting mode.	Use a TV of the same mode.  Connect a NTSC/PAL converter between the receiver and the TV.
The remote controller is not working.	Batteries are exhausted.	Change the batteries.
	Fluorescent light is interfering with the remote controller.	Switch off the light.
	Remote controller is incorrectly aimed.	Aim the remote control at the receiver.

# Specifications

<b>System capabilities</b>	Fully DVB compliant	
<b>LNB/Tuner input</b>	Connector	IEC 169-24, female
	Frequency range	950MHz ~ 2150MHz
	Signal level	-65dBm ~ -25dBm
	LNB supply	14/18V, max 400mA
	LNB switch control	22KHz
	DiSEqC	Ver 1.0/1.1/1.2/USALS Compatible
<b>Demodulator</b>	Front end	QPSK
	Symbol rate	2Msps ~ 45Msps
	SCPC and MCPC Capable	
	Spectral inversion	Auto conversion
<b>System resource</b>	Processor	32bit processor (133MHz)
	SDRAM	8Mbyte
	FLASH	2Mbyte
	EEPROM	32Kbyte
<b>Video decoder</b>	MPEG 2	Main Profile @Main Level
	Data Rate	up to 15M bits/s
	Resolution	720 X 576, 720 X 480
	Video format	NTSC, PAL
	Aspec Ratio	4:3,16:9
<b>Teletext</b>	DVB compliant	
<b>MPEG Audio</b>	MPEG 1 layer 1 &2	
	Type	Mono,Dual mono,Stereo,Joint Stereo
	Sampling rates	32, 44.1 and 48 KHz
<b>Serial data interface</b>	Connector	9pin D-sub male, Max 115K bps
<b>Remote control</b>	Code	NEC-IR
	Operating condition	up to 7 Meter

<b>Power supply</b>	Power consumption	max 20W
	Supply voltage	90V ~ 250V
	Supply frequency	50Hz ~ 60Hz
<b>Rear Panel connectors</b>	TV SCART	Video Out(CVBS, RGB)
		Audio Out
	VCR SCART	Video Out(CVBS)
		Video In(CVBS, RGB)
		Audio Out
	Video	1 X RCA cinch
	Audio L/R	2 X RCA cinch
	Serial data	9pin D-sub
	Digital tuner input	IEC 169 - 24
	Loop-through Digital tuner	IEC 169 - 24
Terrestrial ant input	IEC 169 - 2	
RF modulator output	IEC 169 - 2	

<b>RF modulator PAL G/I/K TV Type</b>	Connector	IEC 169-2, female/male
	Frequency	470 ~ 860MHz
	Output channel number	21 ~ 69
<b>Physical Specification</b>	Size (W X H X D)	260 X 54 X 232(mm)
	Weight (Net)	1.8 Kg

## Free Manuals Download Website

<http://myh66.com>

<http://usermanuals.us>

<http://www.somanuals.com>

<http://www.4manuals.cc>

<http://www.manual-lib.com>

<http://www.404manual.com>

<http://www.luxmanual.com>

<http://aubethermostatmanual.com>

Golf course search by state

<http://golfingnear.com>

Email search by domain

<http://emailbydomain.com>

Auto manuals search

<http://auto.somanuals.com>

TV manuals search

<http://tv.somanuals.com>