

Digital Video Recorder

User Manual

CBC V 0.4

Table of Contents

1. Introduction

1-1 Safety Warning	3
1-2 Features	4
1-3 Specifications	5

2. Installation

2-1 Package contents	6
2-2 Connection	6
2-3 RS232 Remote protocol	7

3. Configuration

3-1 Install HDD	8
3-2 Front panel keypad	10
3-3 Back panel connection	11
3-4 Menu setup	15
3-5 System setup	15
3-6 Schedule Time-Lapse record mode setup	19
3-7 Record mode setup	21
3-8 Alarm mode setup	23
3-9 Remote protocol setup	24
3-10 Event	26

4. Operation

4-1 Power on	28
4-2 Recording	28
4-3 Play	30
4-3-1 F.F. (Fast Forward) & F.R. (Fast Rewind)	30
4-3-2 S.F. (Slow Forward) & S.R. (Slow Rewind)	30
4-3-3 Pause	30
4-3-4 Stop	30
4-3-5 Image jog dial	30
4-4 Search	31
4-5 Video loss	32
4-6 Key lock	32

5. Trouble shouting & appendix

5-1 Trouble shouting	33
5-2 Compatible multiplexer brands	34
5-3 Compatible HDD brands	35

1. Introduction

We thank you for choosing this high quality Digital Video Recorder. The DVR converts analog NTSC or PAL video to digital images and records them on a removable hard disk drive. Digitally recorded video has several advantages over analog video recorded on tape. There is no need to adjust tracking. Digital video can be indexed by time schedule or events, and you can instantly view video after selecting the time or event. You can freeze frames, fast-forward, fast-reverse, slow-forward, and slow-reverse without image streaking or tearing. It can be used as a replacement for a time-lapse VCR in a security installation.

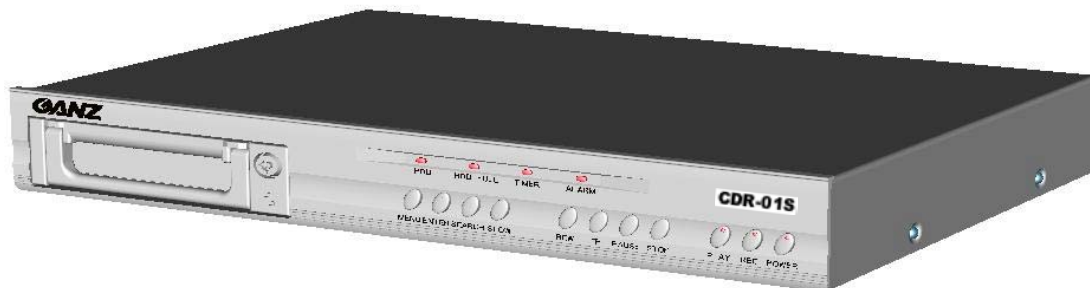

1.1 Safety Warning

All the safety and operating instructions should be read before the appliance is operated. The improper operation may permanently irreparable damage the appliance.

- 1.1.1 Please lift and place this equipment gently.
- 1.1.2 Do not expose this equipment under straight sunlight environment.
- 1.1.3 Do not use this equipment near water or in contact with water.
- 1.1.4 Do not spill liquid of any kind on the equipment.
- 1.1.5 Do not unplug the power connector before turn the power off correctly.
- 1.1.6 This equipment should be operated only power source from standard package.
- 1.1.7 Unauthorized repair or parts substitutions may result in fire, electric shock or other hazards.
- 1.1.8 Do not switch the Power On & Off within short period (within 3 seconds).
- 1.1.9 Do not attempt to service this equipment by yourself. Refer all servicing to qualified service personnel.
- 1.1.10 This unit should be operated only from the type of power source indicated on the manufacturer's label.
- 1.1.11 This installation should be made by a qualified service person and should conform to all local codes.

1.2 Features

1.2.1 Replace traditional Time-Lapse VCR.

Compatible with most multiplexer and quad processors.

1.2.2 Compatible with NTSC / PAL

1.2.3 Record speed options:

NTSC : Maximum 60 Images / second, minimum 1 Image / second

PAL : Maximum 50 Images / second, Minimum 1 Image / second

1.2.4 Recording quality selection

Recording video quality and resolution for Best / High / Normal / Basic

1.2.5 Quick search modes

Search video by Last Record, Full List, Alarm List & Time Search

1.2.6 Fast forward or reverse from 2X up to 32X, and slow forward or reverse from 1/2X to 1/32X.

1.2.7 Time display format set up

1.2.8 Password protection

1.2.9 Alarm input enable record mode

➡ 1 set of alarm input to activate recording

➡ Auto detection for video loss

1.2.10 Alarm output

➡ 1 set of alarm output

1.2.11 Time – scheduled recording

1.2.12 Power off protection

During recording period, recorded video will store in HDD memory without interruption of accidentally power off, and system will be back to the Record Mode when Power ON again

1.2.13 RS232C Control Port

It can be linking with external devices through RS-232C or RS-485 interface

1.2.14 Auto stop recording when HDD Full, and continuous recording in HDD overwrite mode.

1.3 Specifications

VIDEO FORMAT	NTSC / EIA or PAL / CCIR
HDD STORAGE	IDE type, UTMA 66 above, 1 removable HDD supported
RECORD MODE	Manual / Alarm / External / Timer
PLAYBACK SEARCHING	Date & Time / Event / Alarm searching
RS232	Yes
O.S.D. (On Screen Display)	Yes
SECURITY	Password protection
VIDEO INPUT	1 video input, composite 1 Vp-p / 75ohm (BNC)
VIDEO OUTPUT	1 video output , composite 1 Vp-p/75ohm (BNC)
VIDEO RESOLUTION	720 x 576 (PAL), 720 x 486 (NTSC)
VIDEO COMPRESSION	Wavelet
DISPLAY REFRESH RATE	60 ips (NTSC), 50 ips (PAL)
RECORD REFRESH RATE	60 ips (NTSC), 50 ips (PAL)
ALARM INPUT	TTL input, High (5V), Low (GND)
ALARM OUTPUT	COM, NO, NC
VIDEO LOSS DETECTION	Yes
TIME DISPLAY FORMAT	Yes
POWER SOURCE	AC90~240V switching adaptor
POWER CONSUMPTION	< 27W
DIMENSION	432 x 311x 76mm (W x L x H)
WEIGHT	5.2 kgs
OPERATION TEMPERATURE	10 ~ 40°C

Specifications are subject to change without notice.

2. Installation

2.1 Package contents

The package contents including the following items.

- Single channel Digital Video Recorder
- HDD cartridge
- Key for cartridge (In HDD cartridge)
- Power cord
- User manual
- Rack mounting kit

2.2 Connection

2.2.1 Connect with single camera

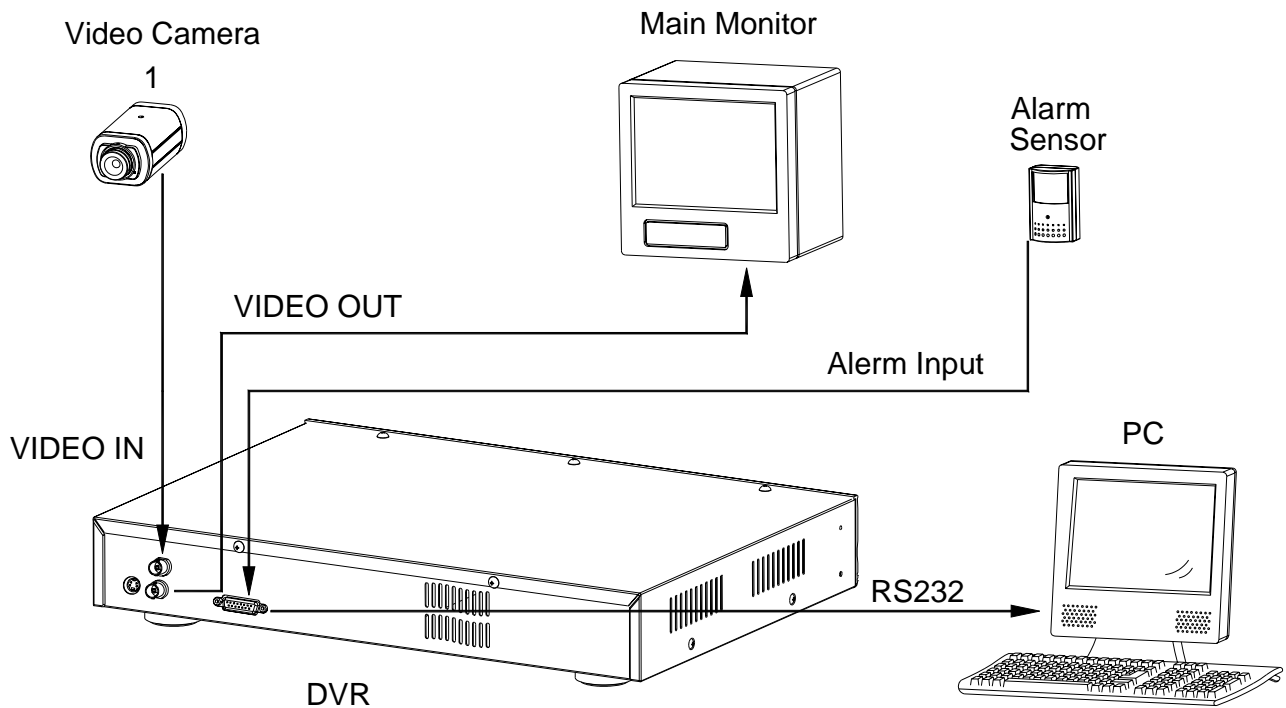

2.2.2 Connect with Multiplexer

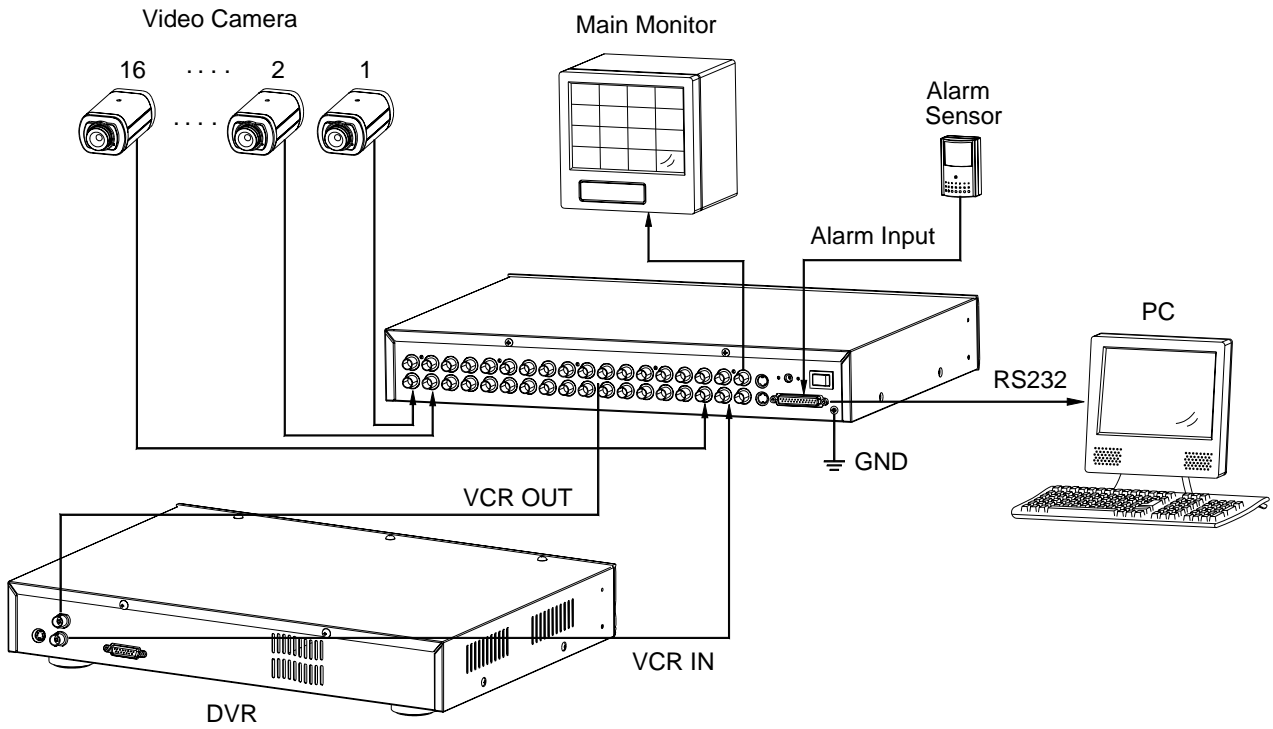

2.3 RS232 Remote Protocol

You can use the PC key board to simulate DVR key pad.

DATA: REMOTE PROTOCOL using 8 bit data · 1 start bit · 1 stop bit

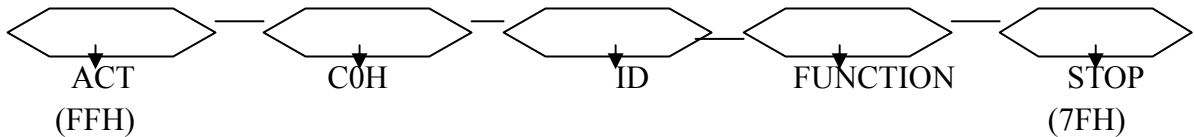

FUNCTION	CODE	ASCII	FUNCTION	CODE	ASCII
MENU	0x4D	M	DOWN / STOP	0x4E	N
ENTER	0x0D	ENTER	LEFT / F.F.	0x4C	L
SEARCH	0x48	H	RIGHT / F.R.	0x52	R
SLOW	0x53	S	PLAY	0x50	P
UP / PAUSE	0x55	U	RECORD	0x72	r

3. Configuration

3.1 Install HDD

3.1.1 Installing Hard Drive into Cartridge

- 3.1.1.1. Please find the Key in the Cartridge.
- 3.1.1.2. Pull the active-handle outwards and use the miniature key provided and insert into the key hole, turning the key anti-clockwise, then the handle will auto-eject for pulling out. °
- 3.1.1.3. Pull the handle outwards to remove the carrier body away from the cartridge frame.
- 3.1.1.4. Push the open button to slide the top cover backwards and remove.
- 3.1.1.5. Insert the DC power cable and IDE cable on the HDD.
- 3.1.1.6. Position the HDD into carrier body and secure the HDD using the four 6#-32 screws provided.
- 3.1.1.7. Slide the top cover back to the carrier body by sliding forward to secure.
- 3.1.1.8. Slide the carrier body back into the cartridge frame.

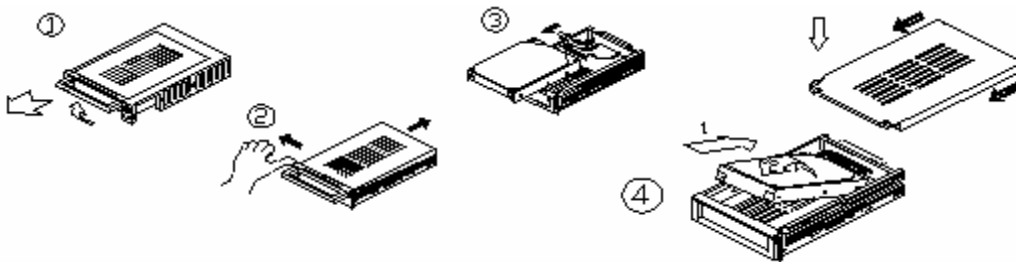

3.1.2 Function Settings and Operation

3.1.2.1 Power Indicator and HDD Access indicator

When power is turned on, the indicator will displays the following :

Item	Indicator
Power Indicator	Green LED
HDD Access Indicator	Yellow LED

3.1.3 Key lock

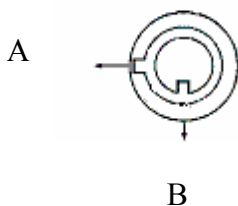

Status Segment	Power status	Security status
A	ON	Locked (Irremovable)
B	OFF	Unlocked (Removable)

You must turn key lock at “A” location before power on. Otherwise HDD cannot be operated normally.

3.1.3 The Record Time is different based on Record Speed and Record Quality. Please refer to following table.

PAL/NTSC SYSTEM (Unit : hours)

Fields Delay	1	2	4	6	8	12	16	20	24	32	40	48	56	64	
Record Quality	Best	12	24	48	72	96	144	192	240	288	384	480	576	672	768
	High	15	30	60	90	120	180	240	300	360	480	600	720	840	960
	Normal	24	48	96	144	192	288	384	480	576	768	960	1152	1344	1536
	Basic	40	80	160	240	320	480	640	800	960	1280	1600	1920	2240	2560
HDD Type	120GB														

Note: Above data is from actual test by recording normal TV program. (Reference only)

3.2 Front panel keypad

Please follow following descriptions to operate this device.

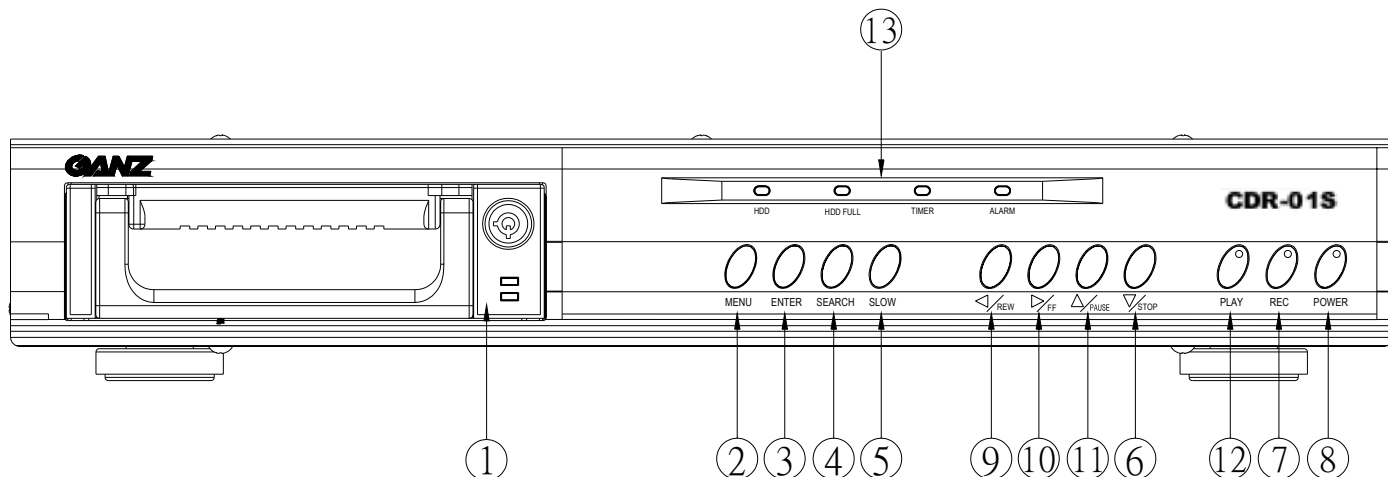

1. Install HDD

This device comes with a removable hard disk drive tray. Before turning on this device, you must install hard disk drive (not including in standard (package), and make it ready to operate.

2. MENU

Press **MENU** to enter main menu operation mode, and press administrator password (default:0000) to access main menu.

3. ENTER

Press **ENTER** for confirmation.

4. SEARCH

Press **SEARCH** for period recording video searching.

5. SLOW

To press **SLOW** to slow down speed of play mode.

6. ▽/STOP

Press **▽/STOP** to stop recording or playing

7. REC

Press **REC** to start recording, when the Timer Enable is No. When the Timer Enable is Yes, then the manual recording is disable.

If you have interrupted the Timer recording to playback, you simply press **REC** and this reinitiates the Timer record mode.

8. POWER

Press **POWER** to power on, and press again to power off.

9. </REW

Press **</REW** to play video backward at high speed, and press **</REW** again to adjust speed from 1, 2, 4, 8, 16, 32 times

10. >/FF

Press **>/FF** to play video forward at high speed, and press **>/FF** again to adjust speed from 1, 2, 4, 8, 16, 32 times.

11. △/PAUSE

Press **△/PAUSE** to pause video.

12. PLAY

Press **PLAY** to play recorded video.

13. LED Light: Under following condition, the led light is ON.

- (1) HDD : HDD is activated
- (2) HDD FULL : HDD is full
- (3) ALARM : When Alarm Enable : Yes (when alarm is triggered, the led is flashing)
- (4) TIMER : When Timer Enable : Yes
- (5) PLAY : Play operation
- (6) REC : Recording operation
- (7) POWER : Power On/Off

3.3 Back panel connection

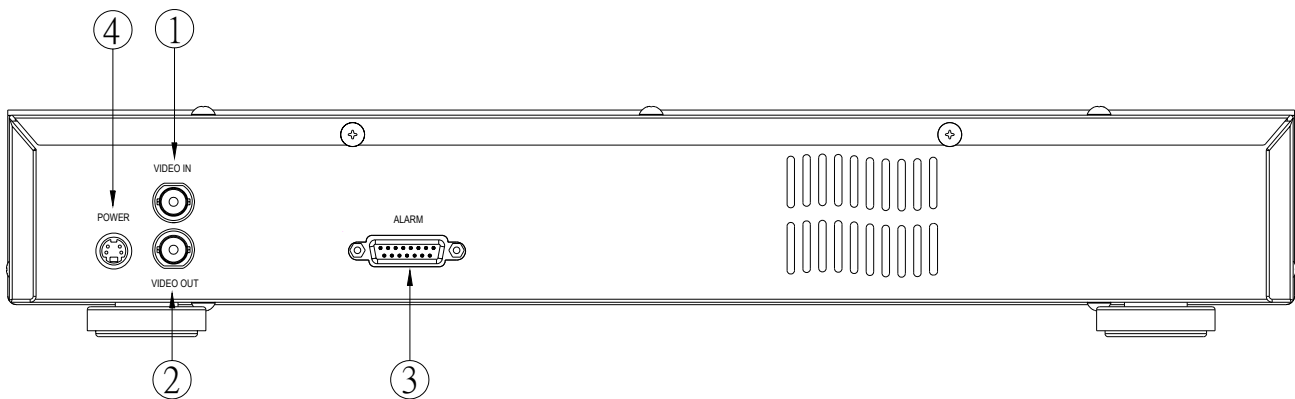

1. VIDEO IN

Connect to video source, such as quad, multiplexer, or camera.

2. VIDEO OUT

Connect to monitor, if no operation with quad or multiplexex, as Fig. 2.2.1

Connect to video input of quad, multiplexer, as Fig. 2.2.2

3. Alarm : RS232 / Alarm input

Controlled remotely by an external device or control system.

Alarm input, external I/O explanation.

16 pin External Interface PCB

25 pin com port

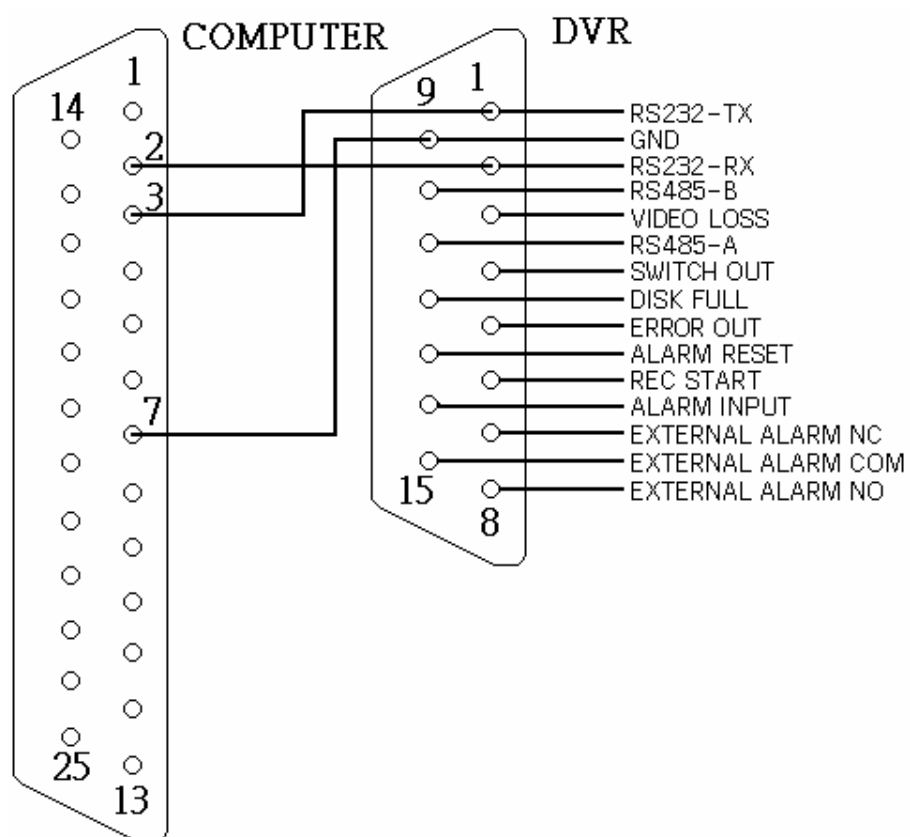

9 pin com port

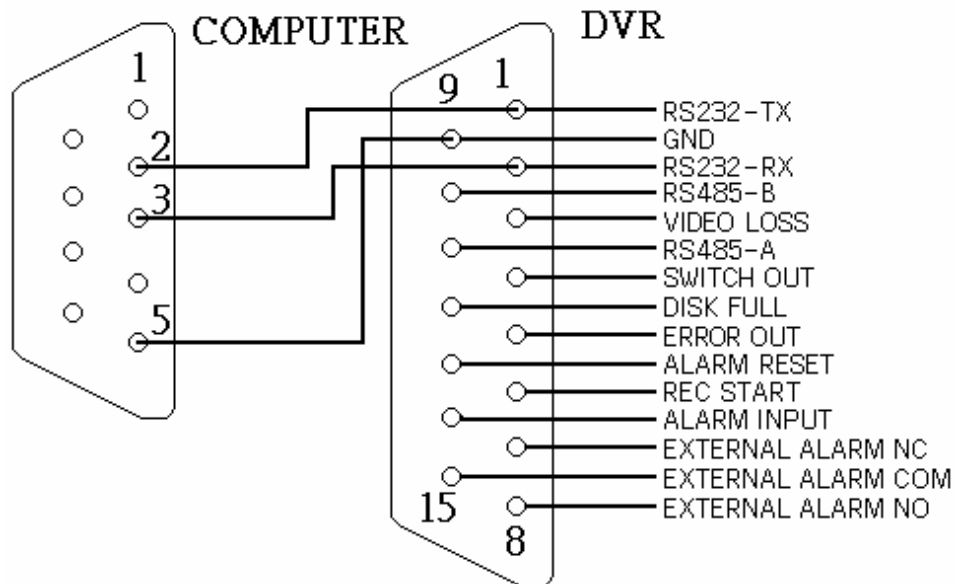

PIN 1. RS232-TX : RS-232

DVR can be controlled remotely by an external device or control system, such as a control keyboard, using RS-232 serial communications signals.

PIN 2. RS232-RX : RS-232

DVR can be controlled remotely by an external device or control system, such as a control keyboard, using RS-232 serial communications signals.

PIN 3. VIDEO LOSS

When video loss happen, it will send a signal to trigger another accessory.

This pin output becomes “Low” when video loss, and normal operation remains “High”

PIN 4. SWITCH OUT

Connect to VCR trigger recording terminal of multiplexer, in order to synchronize recording signals. The default mode is falling (Negative) Edge.

PIN 5. ERROR OUT

When HDD errors happen, this pin will send a signal out.

This pin becomes “Low” when HDD errors happen. The normal operation remains “High”

PIN 6. REC START

This pin can accept the external trigger signal to activate record mode from external device. When the external signal turn to “Low”, it will trigger DVR record mode. When the external signal back to “High”, it will stop recording action.

The default normal operation remains “High”.

PIN 7. EXTERNAL ALARM NC

Under normal operation COM connect with NC and disconnect with NO. But when

alarm triggered, COM disconnect with NC, and connect with NO.

PIN 8. EXTERNAL ALARM NO

Under normal operation COM connect with NC and disconnect with NO. But when Alarm triggered, COM disconnect with NC, and connect with NO.

PIN 9. GND

GROUND

PIN 10. RS485-B

DVR can be controlled remotely by an external device or control system, such as a control keyboard, using RS485 serial communications signals.

PIN 11. RS485-A

DVR can be controlled remotely by an external device or control system, such as a control keyboard, using RS485 serial communications signals.

PIN 12. DISK FULL

When HDD is full, it sends a signal to trigger next DVR record mode, if you install another DVR. Under normal operation, the signal remains "High". But when disk full, DVR will send the "Low" signal.

PIN 13. ALARM RESET

To connect wire from **ALARM RESET (PIN 13)** to **GND (PIN 9)** connector, it can disable ALARM. An external signal to **ALARM RESET (PIN 13)** can be used to reset both **ALARM OUTPUT** signal and DVR's internal buzzer. When alarm has been triggered, signal becomes "Low", and it will stop all alarm activities. Under normal operation, signal remains "High".

PIN 14. ALARM INPUT

To connect wire from **ALARM INPUT (PIN 14)** to **GND (PIN 9)** connector, DVR will start recording and buzzer will be on. When alarm has been triggered, signal becomes "Low", and it will stop all alarm activities. Under normal operation, signal remains "High".

PIN 15. COM

Under normal operation COM connect with NC and disconnect with NO. But when alarm triggered, COM disconnect with NC, and connect with NO.

4. Power input

Connect to power cord (standard package attached).

3.4 Menu setup

To press **"MENU"** to enter main menu. You will need to enter password to access main menu. To press "**◀**" "**▶**" to move digit, and to press **▲**" "**▼**" to select number. To press **"ENTER"** button to confirm password.

Ex.: Password : 0000 (Default : 0000)

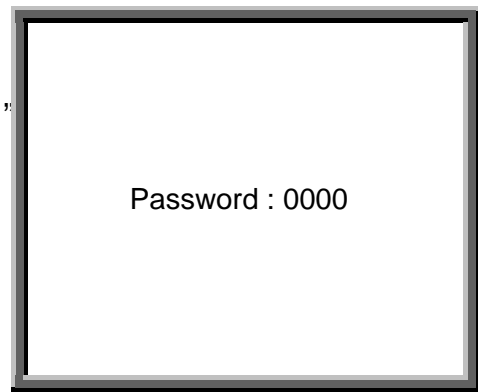

After keying in correct password, and confirm by pressing **"ENTER"** button, screen will show following options.

Timer ----- Scheduling Record
Record ----- Record Mode Setup
Alarm ----- Alarm Mode Setup
Remote ----- Remote Control Setup
System ----- System Setup
Event ----- Event List

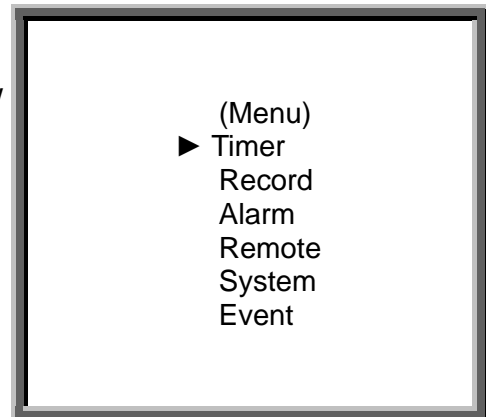

3.5 System setup

To press **"MENU"** to enter main menu. You will need to enter password to access main menu. To press "**◀**" "**▶**" to move digit, and to press **▲**" "**▼**" to select number. To press **"ENTER"** button to confirm password.

Ex.: Password : 0000 (Default : 0000)

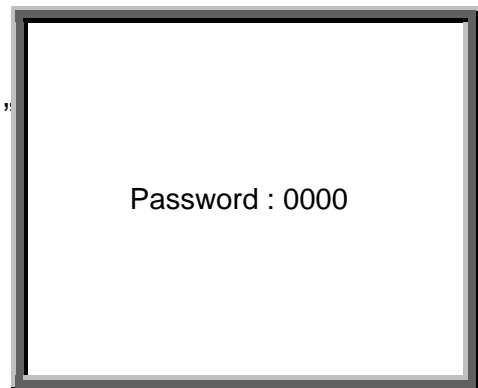

After keying in correct password, and confirm by pressing **"ENTER"** button, screen will show following options.

Timer ----- Scheduling Record
Record ----- Record Mode Setup
Alarm ----- Alarm Mode Setup
Remote ----- Remote Control Setup
System ----- System Setup
Event ----- Event List

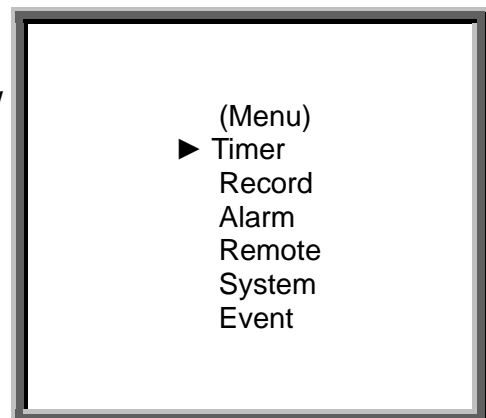

To press "▲" "▼" to choose item.

Timer
Record
Alarm
Remote
▶ System
Event

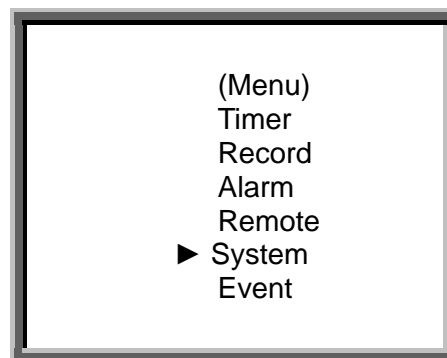

To choose System item, and press "ENTER" button to enter System Setup mode. It will be shown as right screen

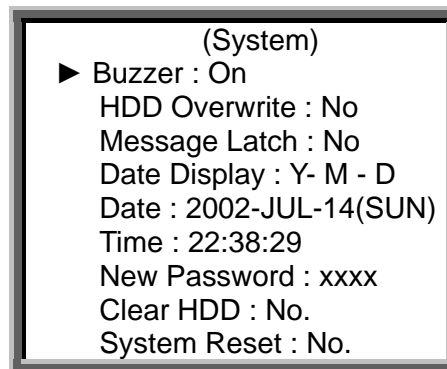

3.5.1 Internal Alarm Buzzer ON/OFF setup:

3.5.1.1 Press "▲" "▼" to choose Buzzer

3.5.1.2 Press "**Enter**" button to confirm alarm buzzer

3.5.1.3 Press "▲" "▼" to choose the Alarm Buzzer ON/OFF

On : Buzzer On

Off : Buzzer Off

3.5.1.4 Press **Menu** to exit and confirm current operation.

3.5.1.5 Press again **Menu** to exit and close **System Setup** mode.

3.5.2 HDD Overwrite setup

3.5.2.1 Press "▲" "▼" to choose HDD Overwrite

3.5.2.2 Press "**Enter**" to confirm HDD Overwrite.

3.5.2.3 Press "▲" "▼" to choose HDD Overwrite : Yes / No

Yes : Turn HDD Overwrite on. When Disk Full, DVR will over write Disk.

No : Turn HDD Overwrite off . When Disk Full, DVR will stop recording.

3.5.2.4 Press **Menu** to exit and confirm the current operation.

3.5.2.5 Press again **Menu** to exit and close **System Setup** mode

3.5.3 Message Latch setup

3.5.2.1 Press "▲" "▼" to choose Message Latch

3.5.2.2 Press "**Enter**" to confirm Message Latch

3.5.2.3 Press "▲" "▼" to choose Message Latch : Yes / No

Yes : Turn Message Latch on, the message will show in the screen.

No : Turn Message Latch off, the message will retain only 10 seconds.

3.5.2.4 Press **Menu** to exit and confirm the current operation.

3.5.2.5 Press again **Menu** to exit and close **System Setup** mode

3.5.4 On Screen Display (date display) format : Y-M-D, M-D-Y, D-M-Y, and OFF

3.5.4.1 Press "▲" "▼" to choose date display

3.5.4.2 Press "**Enter**" to confirm date display format.

3.5.4.3 Press "▲" "▼" to choose date display format.

Y-M-D : Year - Month - Day

M-D-Y : Month – Day -Year

D-M-Y : Day -Month-Year

Off : Not Show date time on screen

3.5.4.4 Press **Menu to** exit and confirm current operation.

3.5.4.5 Press again **Menu** to exit and close **System Setup** mode

3.5.5 System Date (Date :2002-JUL-14 (SUN)) setup

3.5.5.1 Press "▲" "▼" to choose System Date :2002-JUL-14 (SUN) setup.

3.5.5.2 Press "**Enter**" to confirm system Date :2002-JUL-14(SUN) setup.

3.5.5.3 Press "▲" "▼" to choose number, and press "◀" "▶" to move the digit location of
2002-JUL-14(SUN), YY-MM-DD (Day)

3.5.5.4 Press **Menu** to exit and confirm current operation.

3.5.5.5 Press again **Menu** to exit and close **System Setup** mode

3.5.6 System Time (Time : 22:38:29) setup :

3.5.6.1 Press "▲" "▼" to choose Time: 22:38:29 display

3.5.6.2 Press "**Enter**" to confirm system Time: 22:38:29 setup.

3.5.6.3 Press "▲" "▼" to choose number, and press "◀" "▶" to move digit location

Time: 22:38:29 HH:MM:SS; Hour, Minute, Second

3.5.6.4 Press **Menu** to exit and confirm current operation.

3.5.6.5 Press again **Menu** to exit and close **System Setup** mode

3.5.7 New Password : xxxx setup: (Default password : 0000)

3.5.7.1 Press "▲" "▼" to choose new password : xxxx setup.

3.5.7.2 Press "Enter" to confirm new password : xxxx setup.

3.5.7.3 Press "▲" "▼" to choose number, and press "◀" "▶" to move digit location.

3.5.7.4 Press **Menu** to exit and confirm current operation.

3.5.7.5 Press again **Menu** to exit and close **System Setup** mode

3.5.8 Clear HDD Yes / No setup

3.5.8.1 Press "▲" "▼" to choose clear HDD setup.

3.5.8.2 Press "Enter" to confirm clear HDD setup.

3.5.8.3 Press "▲" "▼" to choose clear HDD setup Yes or No.

Yes : Confirm to clear HDD, and screen will show followings.

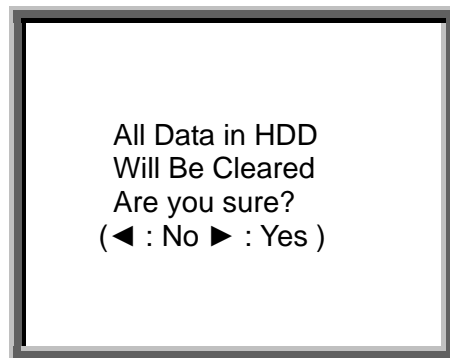

Press "▶" to clear HDD

No : Confirm not to clear HDD.

3.5.8.4 Press **Menu** to exit and confirm current operation.

3.5.8.5 Press again **Menu** to exit and close **System Setup** mode.

3.5.9 System Reset Yes / No setup

3.5.9.1 Press "▲" "▼" to choose System Reset setup.

3.5.9.2 Press "Enter" to confirm System Reset setup.

3.5.9.3 Press "▲" "▼" to choose System Reset setup Yes or No

Yes : To confirm System Reset (load default system reset)

But Date / Time & Password setup will not be changed.

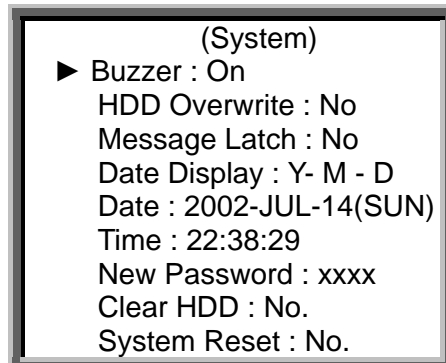

No : Confirm not to System Reset

3.5.9.4 Press **Menu** to exit and confirm current operation.

3.5.9.5 Press again **Menu** to exit and close **System Setup** mode.

Note: If operation without any action until 60 seconds, it will close the setup mode.

3.6 Schedule Time-Lapse record mode setup (Timer)

3.6.1 Enter "Timer" setup

To press "MENU" to enter main menu. You will need to enter password to access main menu. To press "◀" "▶" to move digit, and to press "▲" "▼" to select number. To press "ENTER" button to confirm password.

Ex.: Password : 0000 (Default : 0000)

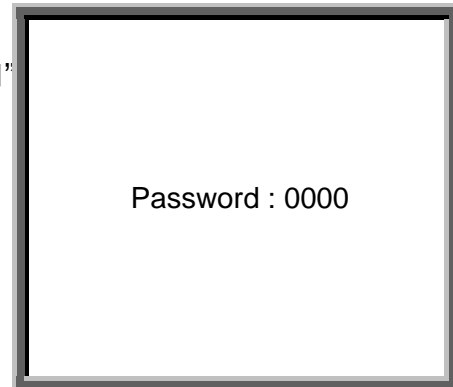

After keying in correct password, and confirm by pressing "ENTER" button, screen will show following options.

Timer ----- Scheduling Record
Record ----- Record Mode Setup
Alarm ----- Alarm Mode Setup
Remote ----- Remote Control Setup
System ----- System Setup
Event ----- Event List

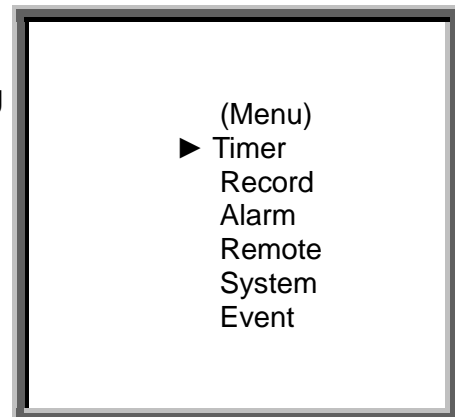

Press "▲" "▼" to choose item.

▶ Timer
Record
Alarm
Remote
System
Event

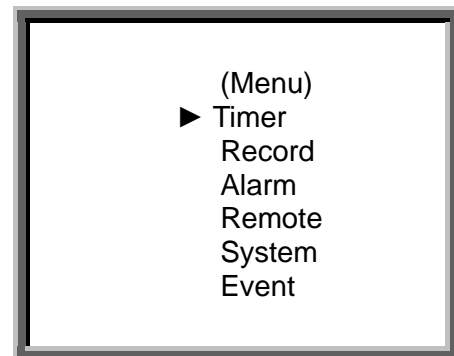

To choose Timer item, and press “ENTER” button to confirm Timer Record setup mode. It will be shown as right screen

(Timer)			
Day	Start	End	F-D
Daily	00:00	00:00	Off
Daily	00:00	00:00	Off
Daily	00:00	00:00	Off
Daily	00:00	00:00	Off
Daily	00:00	00:00	Off
Daily	00:00	00:00	Off
Daily	00:00	00:00	Off
Timer Enable: No			

3.6.2 Timer Record Setup:

3.6.2.1 Press “**Enter**” to confirm Timer Record day setup.

3.6.2.2 Press “▲” “▼” to choose the Timer Record day

Daily : Everyday

SUN : Sunday

MON : Monday

TUE : Tuesday

WED : Wednesday

THU : Thursday

FRI : Friday

SAT : Saturday

MO~FR : Monday to Friday

SA~SU : Saturday & Sunday

JAN-01 : Special Date

3.6.2.3 Press “◀” “▶” move to **Start** record time 00:00 (HH:MM)

Press “▲” “▼” to change **Start** record time numerical digit

3.6.2.4 Press “◀” “▶” move to **End** record time 00:00 (HH:MM)

Press “▲” “▼” to change **End** record time numerical digit

3.6.2.5 Press “◀” “▶” move to Fields Delay (**F-D**)

Press “▲” “▼” to choose options of PAL/NTSC : 1, 2, 4, 6, 8, 12, 16, 20, 24, 32, 40, 48, 56, 64/ off: for not activated.

* Record Quality : Best / High / Normal / Basic according Menu Record setup.

* Record format : Fields / Frames according Menu Record setup.

3.6.2.6 Press **Menu** to confirm current operation, and enter to next Timer Record setup.

3.6.2.7 Press “▲” “▼” move location to Timer Enable : Yes or No setup

Yes : To confirm Timer Enable : Scheduling Timer Record function

No : To confirm no Timer Enable : No Scheduling Timer Record function

3.6.2.8 Press **Menu** to exit and confirm current operation.

3.6.2.9 Press again **Menu** to exit and close **System Setup** mode.

3.7 Record mode setup

3.7.1 Enter "Record" setup

To press "**MENU**" to enter main menu. You will need to enter password to access main menu. To press "◀" "▶" to move digit, and to press "▲" "▼" to select number. To press "**ENTER**" button to confirm password.

Ex.: Password : 0000 (Default : 0000)

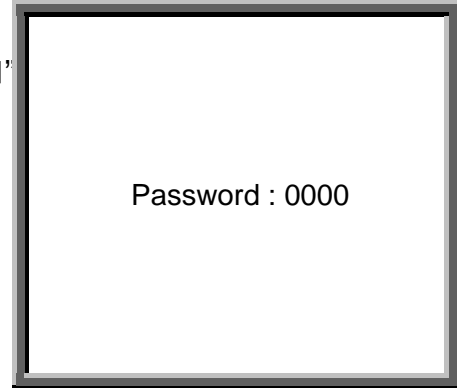

After keying in correct password, and confirm by pressing "**ENTER**" button, screen will show following options.

Timer ----- Scheduling Record
Record ----- Record Mode Setup
Alarm ----- Alarm Mode Setup
Remote ----- Remote Control Setup
System ----- System Setup
Event ----- Event List

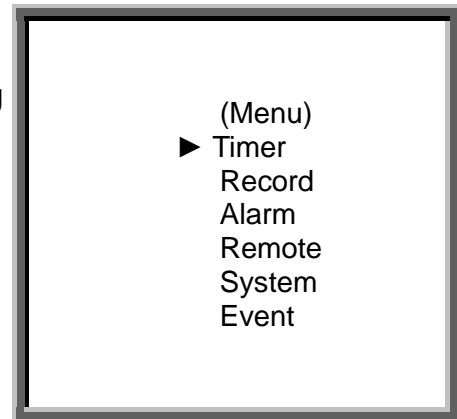

Press "▲" "▼" to choose Record item.

Timer
▶ Record
Alarm
Remote
System
Event

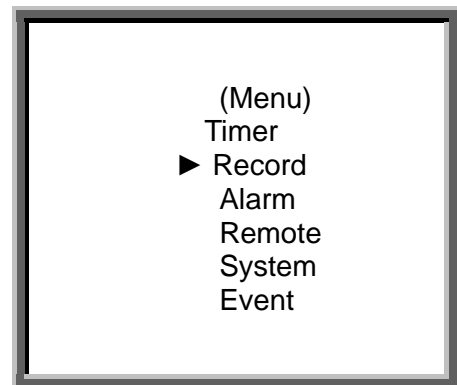

To choose Record item, and press “ENTER” to enter Record mode. It will be shown as right screen



3.7.2 Fields Delay :

3.7.2.1 Press “**Enter**” to confirm “Fields Delay” setup .

3.7.2.2 Press “▲” “▼” to choose “Fields Delay” setup.

PAL/NTSC—1, 2, 4, 6, 8, 12, 16, 20, 24, 32, 40, 48, 56, 64

3.7.2.3 Press **Menu** to exit and confirm current operation.

3.7.2.4 Press again **Menu** to exit and close **System Setup** mode.

3.7.3 Record Quality setup

3.7.3.1 Press “**Enter**” to confirm Record Quality setup.

3.7.3.2 Press “▲” “▼” to choose Record Quality level.

Best 、 High 、 Normal 、 Basic

3.7.3.3 Press **Menu** to exit and confirm current operation.

3.7.3.4 Press again **Menu** to exit and close **System Setup** mode.

3.7.4 Record Mode setup

3.7.4.1 Press “**Enter**” to confirm Record Mode setup.

3.7.4.2 Press “▲” “▼” to choose Record Mode : Frame 、 Field.

3.7.4.3 Press **Menu** to exit and confirm current operation.

3.7.4.4 Press again **Menu** to exit and close **System Setup** mode.

3.8 Alarm mode setup

3.8.1 Enter “ Alarm “ setup

To press **"MENU"** to enter main menu. You will need to enter password to access main menu. To press "**◀**" "**▶**" to move digit, and to press "**▲**" "**▼**" to select number. To press **"ENTER"** button to confirm password.

Ex.: Password : 0000 (Default : 0000)

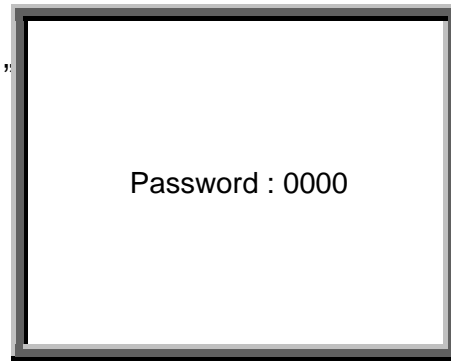

After keying in correct password, and confirm by pressing **"ENTER"** button, screen will show following options.

Timer ----- Scheduling Record
 Record ----- Record Mode Setup
 Alarm ----- Alarm Mode Setup
 Remote ----- Remote Control Setup
 System ----- System Setup
 Event ----- Event List

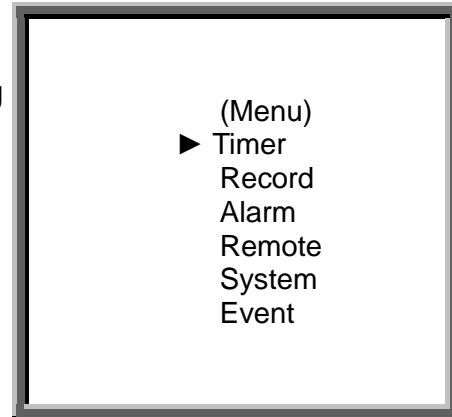

Press "**▲**" "**▼**" to choose Alarm setup item.

Timer
 Record
 ▶ Alarm
 Remote
 System
 Event

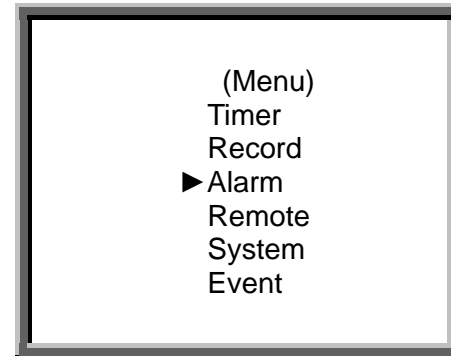

Press **"ENTER"** to confirm Alarm setup, and the screen will be as right displayed.

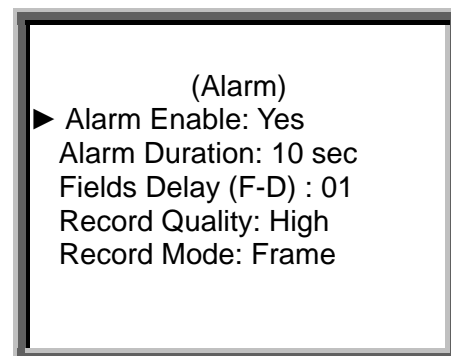

3.8.2 Alarm Enable ON / OFF setup

3.8.2.1 Press **"Enter"** to confirm Alarm Enable setup.

3.8.2.2 Press "**▲**" "**▼**" to choose Alarm setup **ON** or **OFF**

On: Turn on Alarm Enable (Alarm Enable)

Off: Turn off Alarm Enable (Alarm Disable)

3.8.2.3 Press **Menu** to exit and confirm current operation.

3.8.2.4 Press again **Menu** to exit and close **System Setup** mode.

3.8.3 Alarm Duration Setup option:

3.8.3.1 Press "**Enter**" to confirm Alarm Duration setup.

3.8.3.2 Press "▲" "▼" to choose Alarm Duration

10 Sec, 15 Sec, 20 Sec, 30 Sec, 1 Min, 2 Min, 3 Min, 5 Min 、 10 Min 、 15 Min,
30 Min, Always ◦

3.8.3.3 Press **Menu** to exit and confirm current operation.

3.8.3.4 Press again **Menu** to exit and close **System Setup** mode.

3.8.4 Alarm Record Speed (Fields Delay) setup.

3.8.4.1 Press "**Enter**" to confirm Record Speed (Fields Delay) setup.

3.8.4.2 Press "▲" "▼" to choose Record Speed :

PAL/NTSC – 01, 02, 04, 06, 08, 12, 16, 20, 24, 32, 40, 48, 56, 64

3.8.4.3 Press **Menu** to exit and confirm current operation.

3.8.4.4 Press again **Menu** to exit and close **System Setup** mode.

3.8.5 Alarm Record Quality setup

3.8.5.1 Press "**Enter**" to confirm Record Quality (Alarm Record Quality)

3.8.5.2 Press "▲" "▼" to choose Record Quality level

Best 、 High 、 Normal 、 Basic

3.8.5.3 Press **Menu** to exit and confirm current operation.

3.8.5.4 Press again **Menu** to exit and close **System Setup** mode.

3.8.6 Alarm Record Mode setup

3.8.6.1 Press "**Enter**" to confirm Record Mode setup.

3.8.6.2 Press "▲" "▼" to choose Record Mode

Frame 、 Field ◦

3.8.6.3 Press **Menu** to exit and confirm current operation.

3.8.6.4 Press again **Menu** to exit and close **System Setup** mode.

3.9 Remote protocol setup

3.9.1 Enter "Alarm" setup

To press **"MENU"** to enter main menu. You will need to enter password to access main menu. To press "**◀**" "**▶**" to move digit, and to press "**▲**" "**▼**" to select number. To press **"ENTER"** button to confirm password.

Ex.: Password : 0000 (Default : 0000)

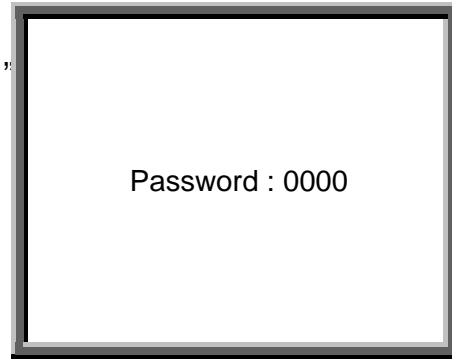

After keying in correct password, and confirm by pressing **"ENTER"** button, screen will show following options.

Timer ----- Scheduling Record
Record ----- Record Mode Setup
Alarm ----- Alarm Mode Setup
Remote ----- Remote Control Setup
System ----- System Setup
Event ----- Event List

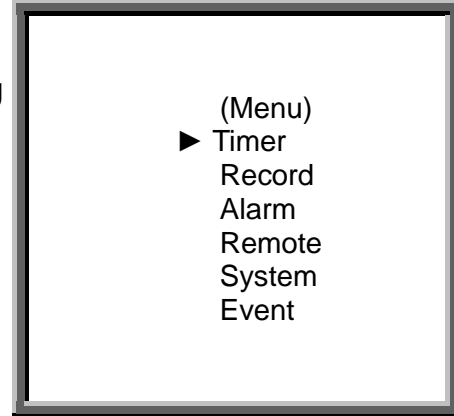

Press "**▲**" "**▼**" to choose Remote setup item.

Timer
Record
Alarm
▶ Remote
System
Event

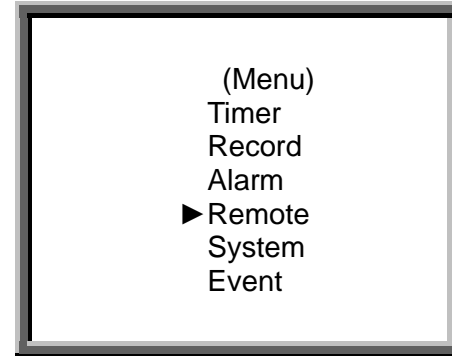

Press **"ENTER"** to confirm Remote setup, and screen will be as right displayed.

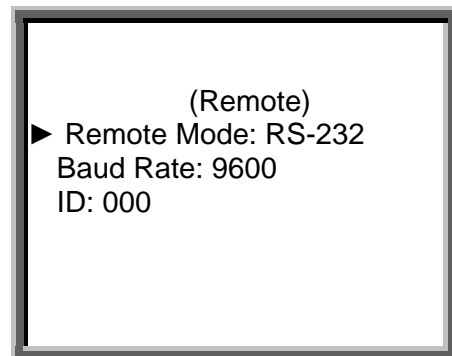

3.9.2 Remote protocol Interface setup :

3.9.2.1 Press **"Enter"** to confirm Remote Mode setup.

3.9.2.2 Press "**▲**" "**▼**" to choose Interface for Remote protocol setup

RS-232: Use RS-232 interface

RS-485: Use RS-485 interface

3.9.2.3 Press **Menu** to exit and confirm current operation.

3.9.2.4 Press again **Menu** to exit and close **System Setup** mode.

3.9.3 Remote protocol Transmitting Baud Rate setup

3.9.3.1 Press "**Enter**" to confirm Baud Rate setup.

3.9.3.2 Press "▲" "▼" to choose the Baud Rate

115200 、 57600 、 19200 、 9600 、 4800 、 3600 、 2400 、 1200 ◦

3.9.3.3 Press **Menu** to exit and confirm current operation.

3.9.3.4 Press again **Menu** to exit and close **System Setup** mode.

3.9.4 Remote protocol ID setup :

You can use RS232 remote protocol to control different DVR. ID number can be set from 000 to be 999.

3.9.4.1 Press "**Enter**" to confirm ID setup

3.9.4.2 Press "▲" "▼" to set numerical number, and press "◀" "▶" to move digit location x x x (3 digits)

3.9.4.3 Press **Menu** to exit and confirm current operation.

3.9.4.4 Press again **Menu** to exit and close **System Setup** mode.

3.10 Event

3.9.1 Enter "Event" list

To press "**MENU**" to enter main menu. You will need to enter password to access main menu. To press "◀" "▶" to move digit, and to press "▲" "▼" to select number. To press "**ENTER**" button to confirm password.

Ex.: Password : 0000 (Default : 0000)

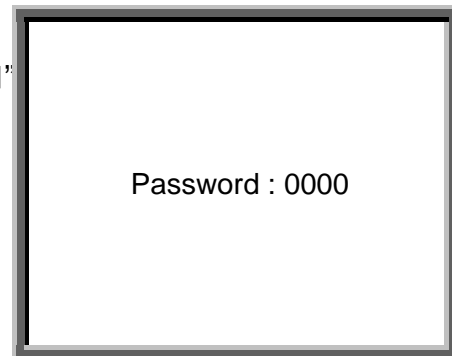

After keying in correct password, and confirm by pressing "**ENTER**" button, screen will show following options.

Timer ----- Scheduling Record
Record ----- Record Mode Setup
Alarm ----- Alarm Mode Setup
Remote ----- Remote Control Setup
System ----- System Setup
Event ----- Event List

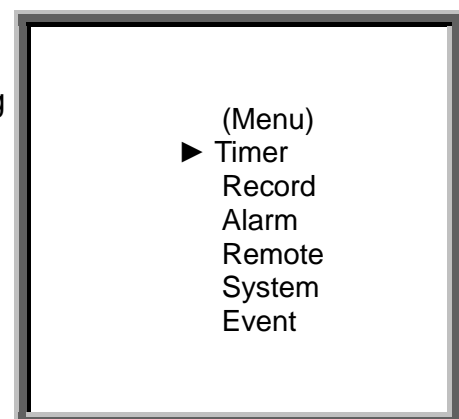

Press "▲" "▼" to choose Event item.

Timer
Record
Alarm
Remote
System
▶ Event

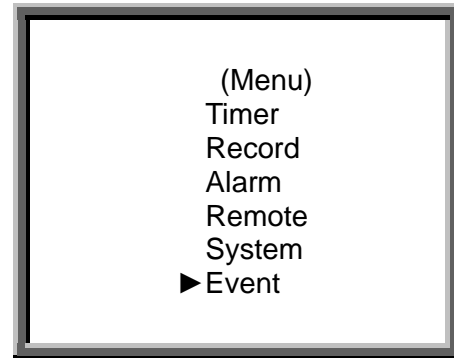

Press "ENTER" to confirm Full List, and the screen will be as right displayed.

Press "▲" "▼" to choose wanted recorded event (There will be shown only 8 list in one page.), and Press "◀" "▶" to change the pages.

Press "ENTER" to Play selected recorded video

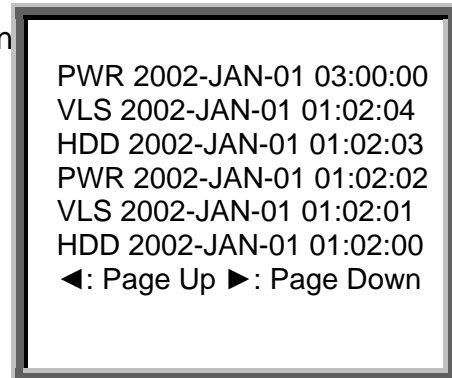

PWR : Recovery time after power shut down

(For example, power shut at 01:00 and power recover at 03:00. It will display to let user knows that there is power shut down before 03:00.)

HDD : HDD error time

VLS : Video loss time

4. Operation

4.1 Power on

Before turning power on make sure the HDD has been locked, and the POWER LED is red color now. After pressing POWER button, POWER LED will turn to orange color, then all other LED light will turn to RED color except the LED for HDD. OSD screen will display "HDD Detecting", Power on period will be running approximately 5 to 15 seconds. If HDD is

set as Master, and screen will display as “HDD Master Connect”. If HDD is set as Slave, and screen will display as “HDD Slave Connect”. In order to shorten the power on running time, we suggest set the HDD as Master. After set DVR power on, POWER LED will turn to green color. (You can set up HDD to be Master or Slave by jumper setting on HDD.)

4.2 Recording

Your DVR offers a variety of flexible recording modes. You can set it up to record all the time, scheduling time, or to only record events, and you can also set up record speed and resolution. You can set those options by selecting MENU and System before recording. Under the recording status, if power is stopped accidentally, recorded video will still store in the HDD after power on. DVR will continue original recording setup after power turning on again.

There are 4 record modes for DVR: Alarm Record, External Trigger Record, Scheduling Timer Record, and Manual Record. All record Modes descriptions in followings.

4.2.1 Alarm Record

When DVR be triggered by alarm input, it will start to record immediately. The recording speed & quality will be followed alarm recording mode setup in main menu.

The screen will be as right displayed.

A : Alarm trigger

 : Recording

OW : HDD Over Write

32GB : If the OW location shows 32GB, it means that HDD left 32 GB capacity for video recording.

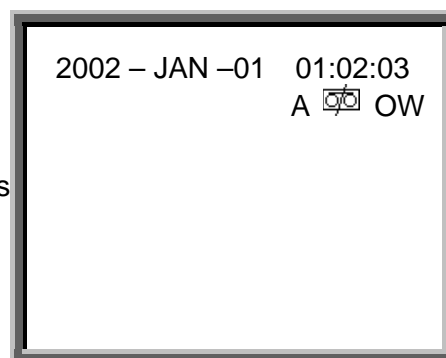

4.2.2 External Trigger Record

DVR can be programmed to record by external device. When external trigger REC START (RS232 pin 6), it will start recording. The recording speed and quality will be followed recording mode setup in main menu.

The screen will be as right displayed.

E : External trigger record

 : Recording

OW : HDD Over Write

32GB : If the OW location shows 32GB, it means that HDD left 32 GB capacity for video recording.

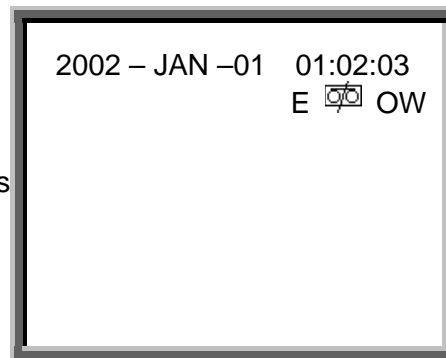

4.2.3 Timer Record

DVR will follow Timer setup to record, and the recording speed and quality will be followed TIMER recording mode setup in main menu.

The screen will be as right displayed.

T : Timer record

 : Recording

OW : HDD Over Write

32GB : If the OW location shows 32GB, it means that HDD left 32 GB capacity for video recording.

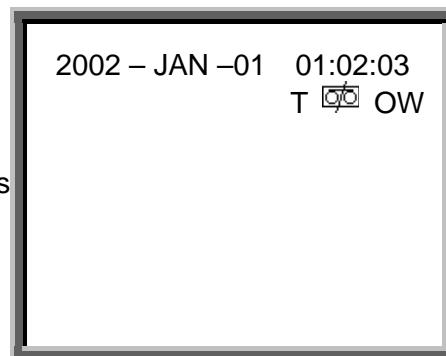

4.2.4 Manual Record

You can press "REC" to start recording immediately. The recording speed & quality will be followed "Record" recording mode setup in main menu.

The screen will be as right displayed.

M : Manual record

 : Recording

OW : HDD Over Write

32GB : If the OW location shows 32GB, it means that HDD left 32 GB capacity for video recording.

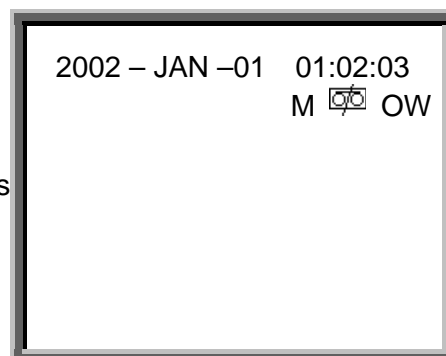

4.3 Play

Press "PLAY" then DVR will into the Play mode, it will show the last record.

4.3.1 Fast Forward (F.F.) & Fast Rewind (F.R.)

4.3.1.1 Press "PLAY" then press "▶▶" for fast forward searching screen. To press once "▶▶" to get speed for 2X. To press twice "▶▶" to get speed for 4X, ...and the maximum speed can be 32X.

4.3.1.2 Press "PLAY" then Press "◀◀" for fast rewind searching screen. To press once "◀◀" to get speed for 2X. To press twice "◀◀" to get speed for 4X, ... and the maximum speed can be 32X.

4.3.2 Slow Forward (S.F.) & Slow Rewind (S.R.)

4.3.2.1 Press "PLAY" then press "SLOW" for slow play, To press once "▶▶" for slow forward speed 1/2X, and press twice "▶▶" speed for 1/4X,the minimum slow speed can be 1/32X.

4.3.2.2 Press "PLAY" then press "SLOW" for slow forward, To press once "◀◀" for slow rewind speed 1/2X, and press twice "◀◀" speed for 1/4X,the minimum slow speed can be 1/32X.

4.3.3 Pause

Press "PLAY" then press "PAUSE", it will pause the screen

4.3.4 Stop

Press "STOP" under any circumstance, it will return DVR to live monitoring mode, and stop all actions.

4.3.5 Image jog dial

4.3.5.1 Press "PLAY" then press "PAUSE", it will pause the screen. Then press ▶▶ for single image play, it will show recorded image one by one when continuously pressing the ▶▶.

4.3.5.2 Press "PLAY" then press "PAUSE", it will pause the screen. Then press ◀◀ for single image play, it will show recorded image one by one when continuously pressing the ◀◀.

4.4 Search

4.4.1 Press "SEARCH" to find recorded list

Last Record - The last recorded video
 Full List - Recorded video full list sorting by time
 Alarm List - Alarm recorded list sorting by time
 Time Search - Find indicated time for recorded video



4.4.2 Search and play Last Record video

Press "▲" "▼" Button to choose Last Record item.
 Screen will be as right displayed.
 Press "Enter" to play the last recorded video



4.4.3 Full List for recorded video

Press "▲" "▼" to choose Full List item.
 Screen will be as right displayed.



Press "ENTER" to confirm Full List, and the screen will be as right displayed.

Press "▲" "▼" to choose wanted recorded event (There will be shown only 8 list in one page.), and Press "◀" "▶" to change the pages.

Press "ENTER" to Play selected recorded video

M : Manual Record time
 A : Alarm Record time
 T : Timer Record time
 E : External Record time

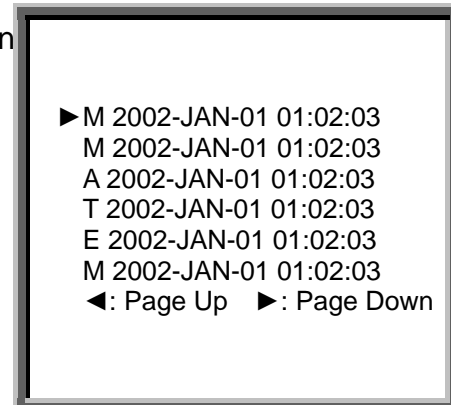

4.4.4 Recorded video in Alarm List

Press "▲" "▼" to choose Alarm List.
Screen will be as right displayed.



Press "ENTER" to confirm Full List, and the screen will be as right displayed.
Press "▲" "▼" to choose wanted recorded event (There will be shown only 8 list in one page.), and Press "◀" "▶" to change the pages.
Press "ENTER" to Play selected recorded video

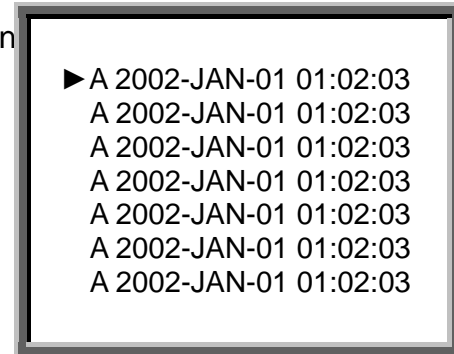

4.4.5 Time Search for recorded video

Press "▲" "▼" to choose Time Search item.
The screen will be as right displayed.



Press "ENTER" to confirm Full List, and the screen will be as right displayed.
Press "▲" "▼" to choose the wanted date & hour for recorded event , and press "◀" "▶" to change the location.
Press "ENTER" to play select time recorded video.
If there is no record in the database, the screen will display "Time Not Found".

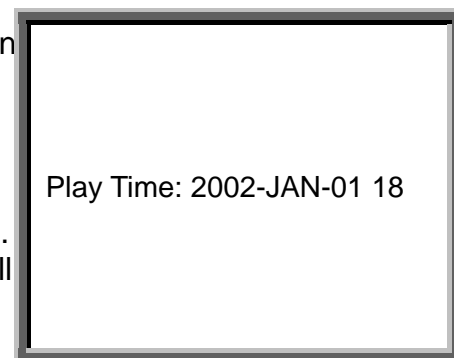

4.5 Video loss

Screen will display "Video Loss" if the connection of video input is not connected normally.

4.6 Key lock

Press "MENU" and "ENTER" key at same time, it will be go to the Key Lock function.

Press "MENU" and "ENTER" key at same time again, it will cancel the Key Lock function.

5. Trouble shouting & Appendix

5.1 Trouble shouting

What DVR appears a malfunction, it may be not serious and can be corrected. The table below describes some typical problems and their remedies. Check them before calling your DVR dealer:

PROBLEM	REMEDY
No power	<ul style="list-style-type: none">● Check power source cord connections.● Confirm that there is power at the outlet.
Not working when press any button	<ul style="list-style-type: none">● Check if it is under Key Lock mode.● Press “MENU” & “ENTER” at same time to skip Key Lock mode.
No recorded video	Check if the HDD has been installed properly.
Record enable does not working	Check if the Record Enable is set to YES
No live video	<ul style="list-style-type: none">● Check camera video cable and connections.● Check monitor video cable and connections.● Confirm that the camera has power offered.● Check camera lens setting.
REC LED is on but DVR does not record	It is set in Timer mode. It will only record during assigned time.

5.2 Compatible Multiplexer brands (Appendix A)

Manufacturer	Model	System	Test Result
AV TECH	AVC707N	NTSC	OK
AV TECH	AVC707P	PAL	OK
AV TECH	AVC706N	NTSC	OK
AV TECH	AVC706P	PAL	OK
CBC	DPLEX-16-ECO	PAL	OK
CBC	DPLEX-16-II	PAL	OK
CBC	DPLEX-9-II	PAL	OK
CBC	DPLEX-4-II	PAL	OK
CBC	DPLEX-16M-II	PAL	OK
CBC	DPLEX-9M-II	PAL	OK
ATV	DPX16	NTSC	OK
CAPTURE	CPT-CD16	PAL	OK
Dedicated Micros	SLDX9C	NTSC	OK
Dedicated Micros	SLDX16C	PAL	OK
PELCO	MX4016	NTSC	OK
SONY	VS-DX504	NTSC	OK
ROBOT	MX99e	NTSC	OK
ULTRAK	KX1610CN	NTSC	OK
FVS	FVX	NTSC	OK

5.3 Compatible HDD brands (Appendix B)

Manufacturer	Model	Capacity	Rotation
IBM	Deskstar 120GXP (40GB)	40GB	7200 rpm
IBM	Deskstar 60GXP IC35I060	60GB	7200 rpm
IBM	Deskstar 120GXP (80GB)	80GB	7200 rpm
IBM	Deskstar 120GXP (120GB)	120GB	7200 rpm
Maxtor	DiamondMax 536DX(60GB) 4W060H4	60GB	5400 rpm
Seagate	Barracuda ATA IV ST340016A	40GB	7200 rpm
Western Digital	Caviar WD400BB-00BSA0	40GB	7200 rpm
Western Digital	Caviar WD400EB-00CPF0	40GB	5400 rpm

Note 1 :

The above brands and models of HDD have been tested and they are compatible with this appliance. Please do not use other use other model HDD which is not listed.

Note 2 :

Please remove HDD after power off 60 seconds. This action could protect HDD not to damage.

Free Manuals Download Website

<http://myh66.com>

<http://usermanuals.us>

<http://www.somanuals.com>

<http://www.4manuals.cc>

<http://www.manual-lib.com>

<http://www.404manual.com>

<http://www.luxmanual.com>

<http://aubethermostatmanual.com>

Golf course search by state

<http://golfingnear.com>

Email search by domain

<http://emailbydomain.com>

Auto manuals search

<http://auto.somanuals.com>

TV manuals search

<http://tv.somanuals.com>