

POWERONE

CRUNCH[®]
SUBWOOFERS

P1-12D2 / P1-12D4

CRUNCH

POWERONE SERIES

CAR AUDIO SUBWOOFERS

Congratulations on your purchase of the new Crunch PowerOne subwoofer system. The PowerOne subwoofer series are a bargain with good build quality and accurate bass reproduction.

- **12-Inch DVC Subwoofer**
- **Dual 2-Ohm and Dual 4-Ohm Voice Coils**
- **High Energy Magnet With ABS Motor Cap**
- **Paper Cone**
- **Ultra Rigid Stamped Steel Basket**
- **Multi-Layer High-Temp VC**
- **Front-Plate & Voice-Coil Cooling**
- **Stitched And Glued Bond For Surround To Cone**
- **Foam Surround**

As with all high quality car audio products, we recommend professional installation by an authorised Autotek dealer. Your dealers knowledge and experience can ensure a problem free and cosmetically integrated installation. If you choose to install the subwoofers yourself, please read the entire manual very carefully.

For product videos and great tutorials, check out www.youtube.com/maxxsonicsusainc

SUBWOOFER INSTALLATION AND WIRING DIRECTIONS

Enclosure Materials

Typically, 5/8" or 3/4" MDF (Medium Density Fiber Board) is best for most applications. 3/4" MDF is recommended.

Enclosure Build Materials

Connecting joints need to be glued and screwed to ensure no air escapes and joints do not separate under high pressure. Mitered and rabbit joints also help to ensure the enclosure joints are secure.

Bracing

Internal bracing is also recommended to prevent flexing and to strengthen the enclosure.

Note: The volume taken up by the bracing should be added to the total enclosure interior volume.

There are two common bracing methods.

1. **Corner Bracing:** These help prevent the connection joints from separating under heavy vibration and air pressure.

Use 1' x 1" MDF at all interior joints

2. **Diagonal Bracing:** These internal braces connect the top side to the bottom side as well front side to back side. This prevents the wood from bowing or pushing outwards.

Use 1" x 2" with 1" surface contact that is glued and screwed.

Wiring

Wiring Parallel, Series or Parallel/Series will affect the final impedance at the amp and great care must be taken to ensure the amp is not driven below its intended impedance capabilities.

CRUNCH POWERONE SERIES SUBWOOFERS

Parameters	P1-12D2	P1-12D4	
Wiring	Series	Series	Coils
NomZ	4.38	8.688	Ohm
Sd	0.051	0.051	sqM
Revc	3.65	7.24	Ohm
BL	8.264	10.47	TxM
Vas	122.2	124.9	Liter
Cms	329.8	337.3	uM/N
Mms	87.21	75.93	Grams
Fs	29.71	31.45	Hz
Qms	5.57	6.714	
Qes	0.87	0.991	
Qts	0.75	0.863	
no	0.355	0.379	%
SPL@1W	87.52	87.8	dB
Xmax	10.25	10.25	mm
Rms	350	350	Watts
Maxx	700	700	Watts

CLOSED BOX DESIGNS (SEALED)

Standard Tight Bass			
Box Volume	1.5	1.5	Cubic Feet
Qtc	1.4	1.61	
F3	42	44	Hz

Optimal Sound Quality-Flat Response			
Box Volume	2	2	Cubic Feet
Qtc	1.26	1.45	
F3	38	40	Hz

VENTED BOX DESIGNS (ROUND PORT)

Standard Tight Bass			
Box Volume	2	2	Cubic Feet
Fb	40	41	Hz
Port Size (inside diameter)	3	3	Inches
Port Length	3.8	3.5	Inches
F3	39	41	Hz

Optimal Sound Quality-Flat Response			
Box Volume	2.5	2.5	Cubic Feet
Fb	39	40	Hz
Port Size (inside diameter)	4	4	Inches
Port Length	6.2	5.7	Inches
F3	36	38	Hz

FEATURES ARE SUBJECT TO CHANGE WITHOUT NOTICE

NOTE: All above box volumes are internal values and already include subwoofer and port displacement.

The F3 value represents the .3db cut off of the enclosure in Hz.

The above designs use .75" MDF.

Glossary of Terms

- Q The energy losses of relative damping (ratio of stored to dissipated energy or ratio of reactive to resistive energy).
- F_s Free air resonance of driver in Hz.
- Q_{ms} Mechanical Q.
- V_{as} Volume of air equivalent to driver from the rest position.
- C_{ms} Mechanical compliance of a loud speaker piston.
- M_{ms} Moving mass of total loud speaker piston assembly.
- X_{max} The maximum linear excursion of a loud speaker.
- S_d Surface area of the cone.
- D_{ia} The piston diameter of a loud speaker.
- Q_{es} Electrical Q of a system.
- R_e DC resistance.
- L_e VC inductance.
- P_e Maximum input power.
- Q_{ts} Total Q of the system.
- Sens Sensitivity. An efficiency measurement in dB's.
- V_c Volume of a closed or sealed enclosure
- V_b Volume of a vented enclosure.
- F_c The resonant frequency of a closed or sealed system
- F_b The resonant frequency of a vented system
- F₃ The half-power (-3dB) frequency of a loud speaker enclosure
- Q_{tc} The Q of a loud speaker at F_c in a closed box, considering both it's electrical and mechanical resistance.
- Q_L The Q of a vented box, resulting from all box losses.
- D_V Diameter of vent.
- L_V Length of vent.
- H Height.
- W Width.
- D Depth

P1-12D2

DVC 2-Ohms

PARALLEL

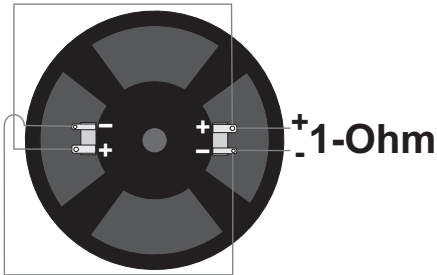

SERIES

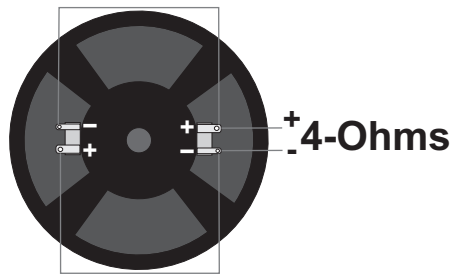

PARALLEL COILS / PARALLEL SUBS

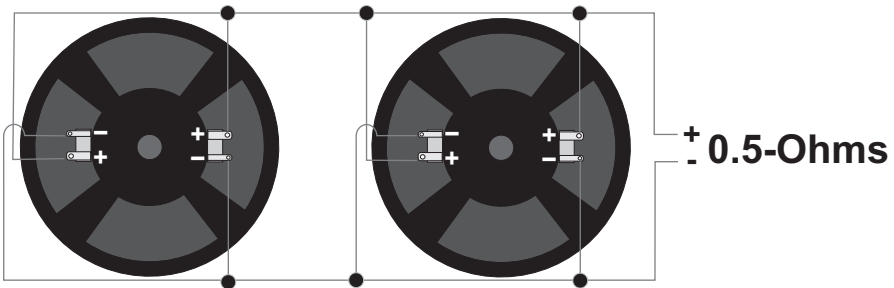

SERIES COILS / PARALLEL SUBS

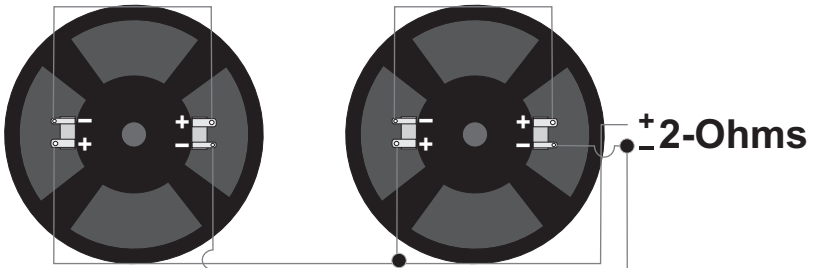

P1-12D4

DVC 4-Ohms

PARALLEL

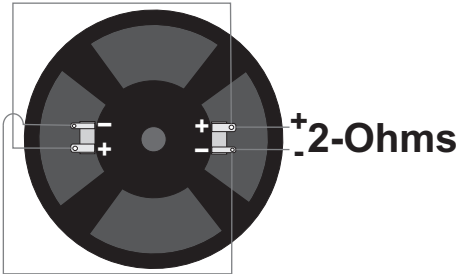

SERIES

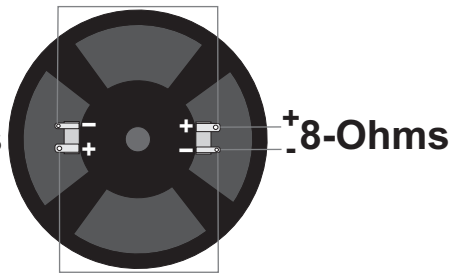

PARALLEL COILS / PARALLEL SUBS

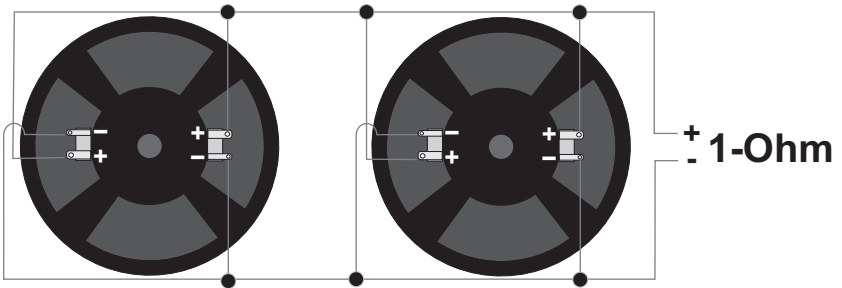

SERIES COILS / PARALLEL SUBS

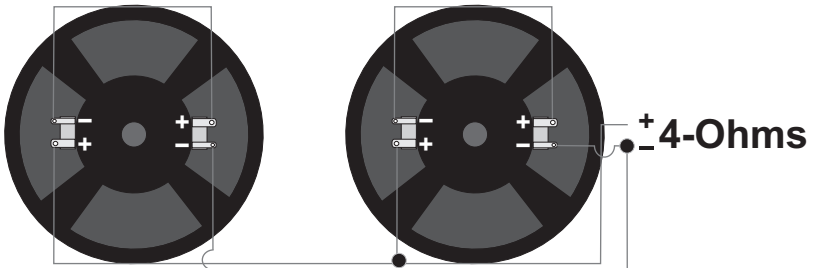

SUBWOOFER DIMENSIONS

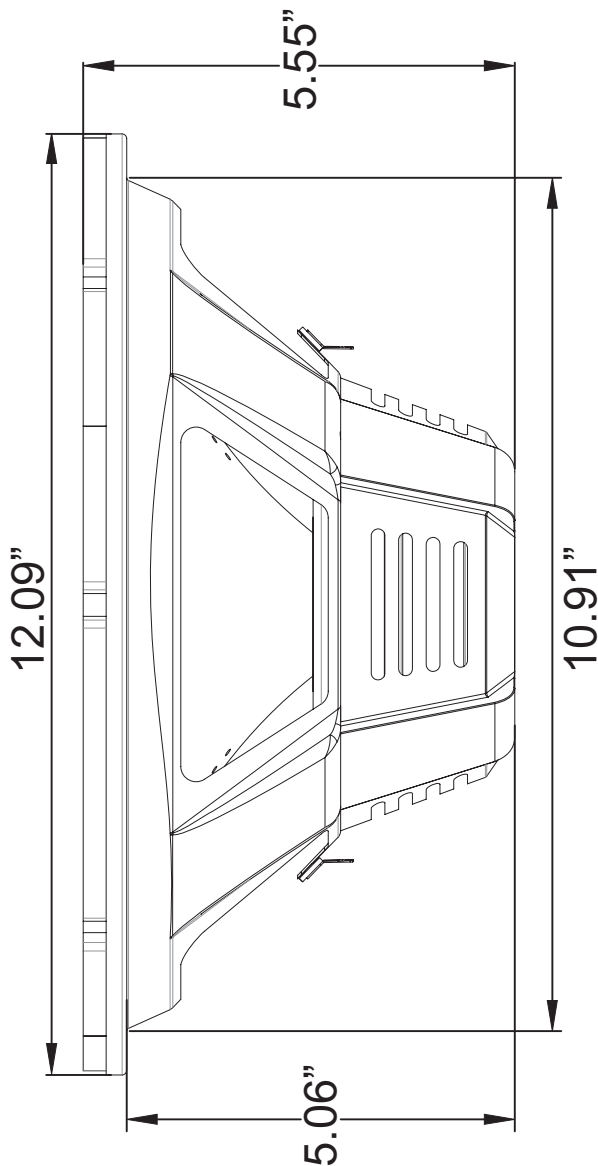

When designing an enclosure for this subwoofer, please ensure to leave at least 2" of clearance from the back of the motor to the back of the enclosure.

Maxxsonics Limited Warranty

As the manufacturer of Maxxsonics, MB Quart, Autotek, Crunch and Hifonics car audio products, Maxxsonics USA Inc. Warrants to the original consumer purchaser the amplifier to be free from defects in material and workmanship for one (1) Year from date of purchase.

All other parts and accessories of the system are warrantied to be free from defects in material and workmanship for one (1) year from date of purchase. Maxxsonics will repair or replace at it's option and free of charge during the warranty period, any system component that proves defective in materials and workmanship under normal installation, use and service provided that the product is returned to the authorized Maxxsonics dealer from where it was purchased. A photo copy of the original receipt must accompany the product being returned.

Valid purchase receipts will contain the name and address of the authorized reseller.

Any damage to the product as a result of misuse, abuse, accident, incorrect wiring, improper installation, alteration of date code or bar code labels, revolution, natural disaster, or any sneaky stuff because someone messed up, repair or alteration out side of our factory or authorized service centers and any thing else you have done that you should not have done is not covered.

This warranty is limited to defective parts and specifically excludes any incidental or consequential damages connected therewith. This warranty is not to be construed as an insurance policy.

Warranty on installation labor, removal, re-installation and freight charges are not the responsibility of Maxxsonics USA Inc.

Warranty products damaged as a result of insufficient or improper packing materials are not covered by this limited warranty and such damaged product will be returned "as is" at the expense of the owner.



MAXXSONICS™
Designed and Engineered in the USA
www.maxxsonics.com



MAXXSONICS®

MBQUARTI®

autOTEK®

HIFONDICS®

CRUNCH®

WWW.MAXXSONICS.COM

PART#: F2/11

Free Manuals Download Website

<http://myh66.com>

<http://usermanuals.us>

<http://www.somanuals.com>

<http://www.4manuals.cc>

<http://www.manual-lib.com>

<http://www.404manual.com>

<http://www.luxmanual.com>

<http://aubethermostatmanual.com>

Golf course search by state

<http://golfingnear.com>

Email search by domain

<http://emailbydomain.com>

Auto manuals search

<http://auto.somanuals.com>

TV manuals search

<http://tv.somanuals.com>