

USER'S GUIDE

Welcome	1
Safety Instructions	1-3
Range at a Glance	4
Controls at a Glance	5-6
Surface Cooking	7-8
Surface Controls	7
Coil Element Surface	8
Oven Operation	9-12
Oven Controls	9-10
Oven Vent & Light	10
Oven Racks	11
Broiling	12
Care and Cleaning	13-14
Maintenance	15-16
Before You Call for Service	17-18
Warranty	19

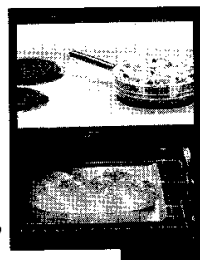

KEEP THESE INSTRUCTIONS FOR FUTURE REFERENCE

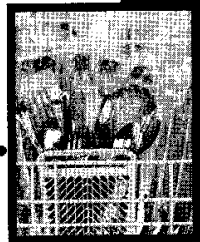
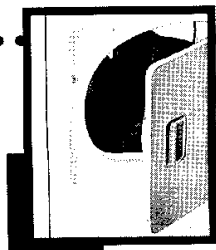
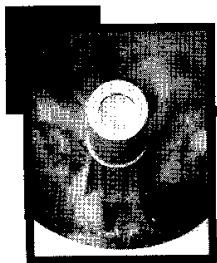

General Instructions

WARNING: NEVER use appliance door, or drawer, if equipped, as a step stool or seat as this may result in possible tipping of the appliance, damage to the appliance, and serious injuries.



If appliance is installed near a window, proper precautions should be taken to prevent curtains from blowing over surface elements.

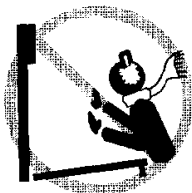

NEVER use appliance to warm or heat the room. Failure to follow this instruction can lead to possible burns, injury, fire, or damage to the appliance.



NEVER wear loose-fitting or hanging garments while using the appliance. Clothing could catch utensil handles or ignite and cause burns if garment comes in contact with hot heating elements.

To ensure proper operation and to avoid damage to the appliance or possible injury, do not adjust, service, repair or replace any part of the appliance unless specifically recommended in this guide. Refer all other servicing to a qualified technician.

NEVER store or use gasoline or other combustible or flammable materials in the oven, near surface units or in the vicinity of this appliance as fumes could create a fire hazard or an explosion.

To prevent grease fires, do not let cooking grease or other flammable materials accumulate in or near the appliance.

Use only dry potholders. Moist or damp potholders on hot surfaces may result in a steam burn. Do not let potholders touch hot heating elements. Do not use a towel or other bulky cloth which could easily touch hot heating elements and ignite.

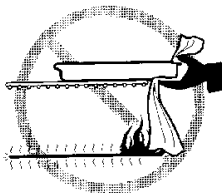

Always turn off all controls when cooking is completed.

NEVER heat unopened containers on the surface unit or in the oven. Pressure build-up in the container may cause container to burst resulting in burns, injury or damage to the appliance.

NEVER use aluminum foil to line drip bowls, or to cover an oven rack or oven bottom. Misuse could result in risk of electric shock, fire, or damage to the appliance. Use foil only as directed in this guide.

Cooktop

NEVER leave surface units unattended especially when using high heat settings. An unattended boilover could cause smoking and a greasy spillover can cause a fire.



This appliance is equipped with different size surface elements. Select pans having flat bottoms large enough to cover element. Proper relationship of pan to element will improve cooking efficiency.

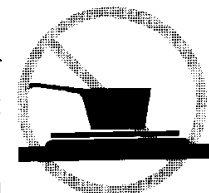

If pan is smaller than element, a portion of the element will be exposed to direct contact and could ignite clothing or potholder.

Only certain types of glass, glass/ceramic, ceramic, earthenware, or other glazed utensils are suitable for cooktop or oven service without breaking due to the sudden change in temperature. Follow utensil manufacturer's instructions when using glass.

Turn pan handle toward center of cooktop, not out into the room or over another surface element. This reduces the risk of burns, ignition of flammable materials, or spillage if pan is accidentally bumped or reached by small children.

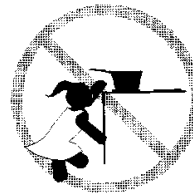

To prevent damage to removable heating elements, do not immerse, soak or clean in a dishwasher or self-clean oven. A damaged element could short resulting in a fire or shock hazard.

Make sure drip bowls are in place as absence of these bowls during cooking could damage wiring.

Deep Fat Fryers

Use extreme caution when moving the grease pan or disposing of hot grease. Allow grease to cool before attempting to move pan.

Safety Instructions (continued).....

Oven

Use care when opening door. Let hot air or steam escape before removing or replacing food.

For proper oven operation and performance, do not block or obstruct oven vent duct.

Always place oven racks in desired locations while oven is cool. If rack must be moved while oven is hot, do not let potholder contact hot heating element in oven.

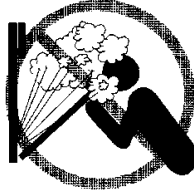

Heating Elements

NEVER touch surface or oven heating elements, areas near elements, or interior surfaces of oven.

Heating elements may be hot even though they are dark in color. Areas near surface elements and interior surfaces of an oven may become hot enough to cause burns. During and after use, do not touch or let clothing or other flammable materials contact heating elements, areas near elements, or interior surfaces of oven until they have had sufficient time to cool.

Other potentially hot surfaces include: Cooktop, areas facing the cooktop, oven vent, and surfaces near the vent opening, oven door, areas around the door and oven window.

Child Safety

NEVER leave children alone or unsupervised in area where appliance is in use or is still hot.

NEVER allow children to sit or stand on any part of the appliance as they could be injured or burned.

CAUTION: NEVER store items of interest to children in cabinets above an appliance or on backguard of a range. Children climbing on appliance, door or drawer to reach items could damage the appliance or be burned or seriously injured.

Children must be taught that the appliance and utensils in or on it can be hot. Let hot utensils cool in a safe place, out of reach of small children. Children should be taught that an appliance is not a toy. Children should not be allowed to play with controls or other parts of the unit.



Ventilating Hoods

Clean range hood and filters frequently to prevent grease or other flammable materials from accumulating on hood or filter and to avoid grease fires.

Turn the fan off when flambéing foods (such as Cherry Jubilee) under the hood. The fan, if operating, may spread the flame.

Save These Instructions for Future Reference

Range at a Glance

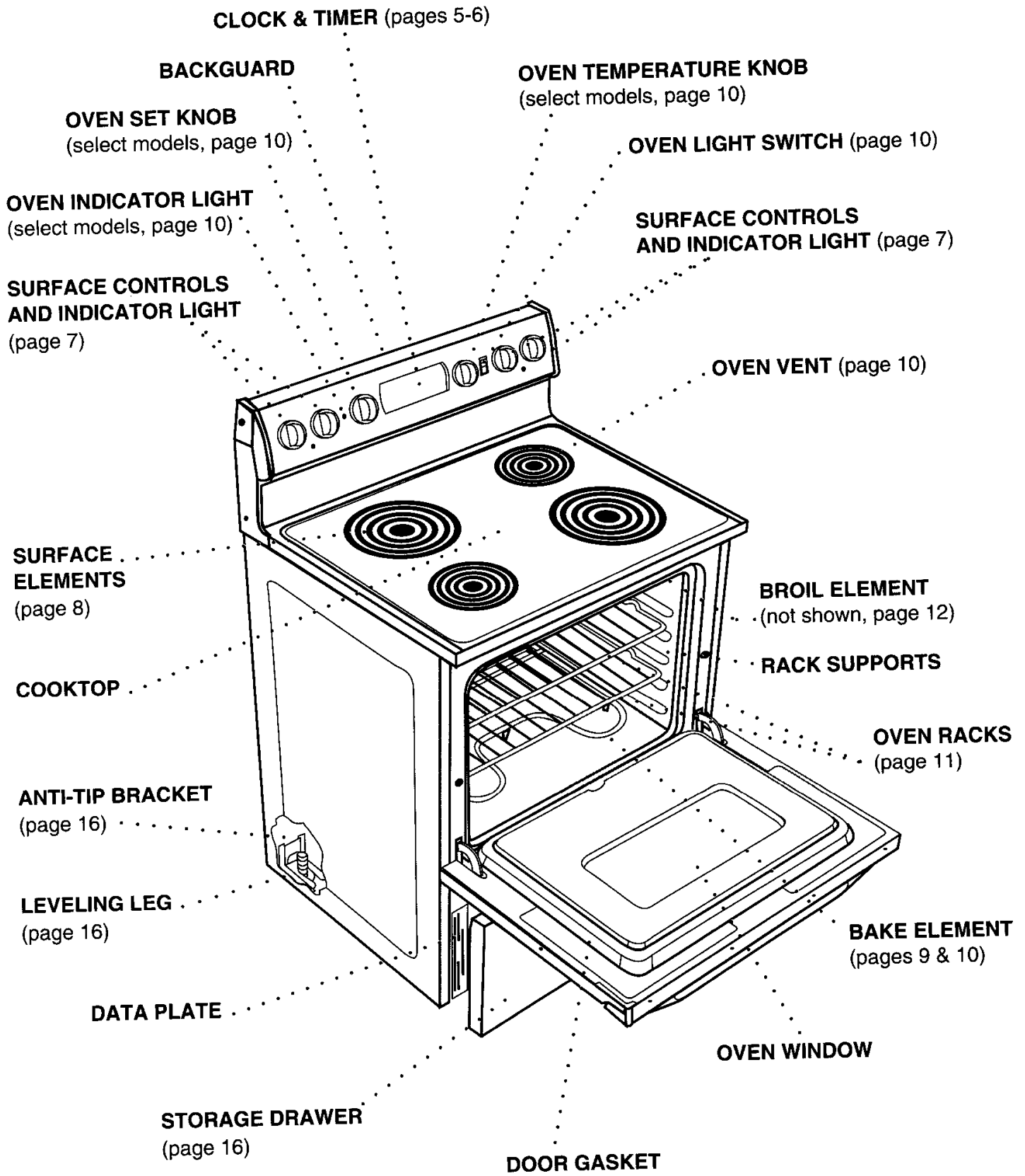

Electronic Clock and Oven Control (select models)

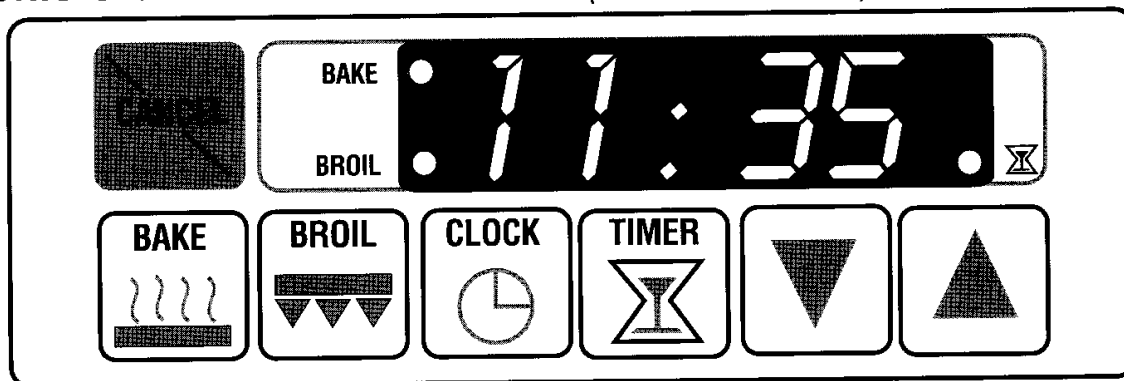

NOTE: The display will flash when the appliance is first connected to power or if power is interrupted. The display will stop flashing once the time-of-day clock has been set. The BAKE, BROIL and TIMER indicators light when the function pad is pressed.

CANCEL Pad

Press this pad to cancel all operations except the clock and timer.

▲ and ▼ Pads

Press and tap, or press and hold, these pads to enter the desired time, temperature, or to select HI or LO broil.

BAKE Pad

Use for baking or roasting.

1. Press **BAKE** pad.
2. Press ▲ or ▼ pad to set the oven temperature.

See page 9 for additional information.

BROIL Pad

Use for top browning and broiling.

1. Press **BROIL** pad.
2. Press ▲ or ▼ pad for HI or LO broil.

See page 12 for additional information.

Setting the Clock

1. If the display is flashing, press the **CLOCK** pad to stop the flashing, then press the **CLOCK** pad again.
 - If the colon is not flashing, press the **CLOCK** pad.
 - The clock time cannot be set if the control is programmed for a bake, broil or timing operation.
2. Set the correct time of day using the ▲ and ▼ pads. If the ▲ or ▼ pad is not pressed within 30 seconds, the program will cancel. Press the **CLOCK** pad and begin again.

Setting the Timer

The timer can be set from one minute (:01) up to 9 hours and 50 minutes (9:50). Time will be displayed in minutes and not in seconds. **THE TIMER DOES NOT CONTROL THE OVEN.**

1. Press the **TIMER** pad.
 - :00 and the **TIMER** indicator light will appear in the display. The colon will flash.
2. Press the ▲ or ▼ pad until the desired time is displayed.
 - The timer will begin as soon as the time is set.
 - The flashing colon indicates that a timing operation is in progress. The colon will not flash if the time of day or oven temperature is displayed.
 - The timer countdown will be displayed unless another function is programmed after setting the timer.
 - A single beep signals the end of the operation. "END" will appear in the display. If the time of day or oven temperature is displayed "END" will not appear.
 - A short beep will sound every 30 seconds for five minutes to remind you that the operation has completed.
3. If desired, press the **TIMER** pad and the time of day will reappear in the display during a timing operation.

To cancel the timer operation: Press and hold the **TIMER** pad for three seconds.

Additional Information

- A beep will sound each time a function pad is pressed. There is no beep for the ▲ or ▼ pad.
- If a fault code (example: F2) is displayed and beeps sound, press the **CANCEL** pad. If the fault code continues, see page 17.

Clock and Timer Control (select models)

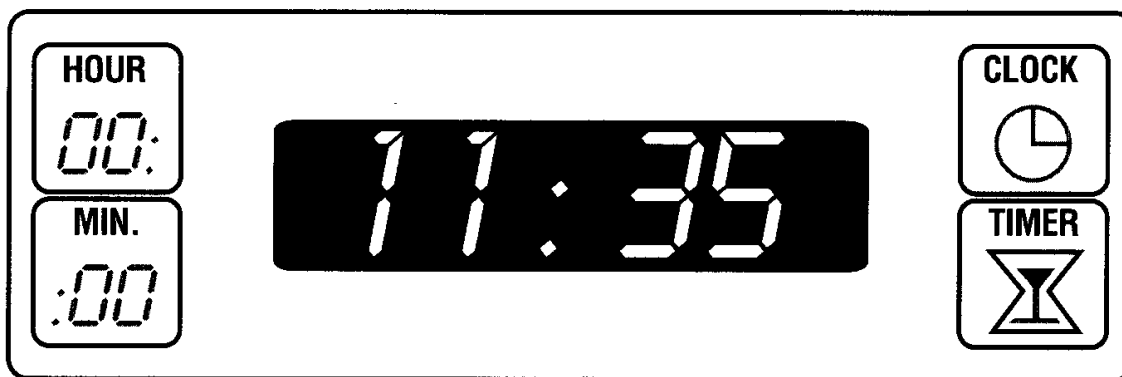

NOTE: The display will flash when the appliance is first connected to power or if power is interrupted. The display will stop flashing once the time-of-day clock has been set.

Setting the Clock

1. Press the **CLOCK** pad.
2. Press and hold the **HOUR** pad to set the correct hours. To change the time by a single hour, give the pad a short tap.
3. Press and hold the **MIN.** pad to set correct minutes. To change the time by a single minute, give the pad a short tap.

For example: To set the clock for 3:15, press and hold the **HOUR** pad until 3 appears in the display. Then press and hold the **MIN.** pad until 15 appears in the display.

Setting the Timer

The timer can be set from one minute (:01) up to 1 hour and 59 minutes (1:59). Time will be displayed in minutes and not in seconds.

1. Press the **TIMER** pad.
 - :59 (or one hour) will appear in the display.
 - The timer will automatically begin counting down in increments of one minute. The colon will flash.

2. To set timer for less time, press the **TIMER** pad, then press and hold the **MIN.** pad until the desired time appears in the display.
3. To set the timer for more than one hour, press the **TIMER** pad, then press the **HOUR** pad. 1:59 will appear in the display.
 - Press the **MIN.** pad until the desired minutes appear in the display.

When the time has elapsed, 0:00 will appear in the display and continuous beeps will sound.

Press the **CLOCK** pad to cancel the beeps. The current time of day will reappear in the display.

To cancel the timer: Press the **CLOCK** pad and the display will return to the current time of day.



Surface Cooking



Surface Cooking CAUTIONS:

Before Cooking

- Always place a pan on the surface unit before you turn it on. To prevent damage to range, never operate surface unit without a pan in place.
- Do not use the cooktop as a storage area for food or cookware.

During Cooking

- Be sure you know which knob controls which surface unit. Make sure you turned on the correct surface unit.
- Begin cooking on a higher heat setting then reduce to a lower setting to complete the operation. Never use a high heat setting for extended cooking.
- Never allow a pan to boil dry. This could damage the pan and the appliance.
- Never touch cooktop until it has cooled. Expect some parts of the cooktop, especially around the surface units, to become warm or hot during cooking. Use potholders to protect hands.

After Cooking

- Be sure surface element and surface indicator light are off after cooking.
- Clean up messy spills as soon as possible.

Other Tips

- To eliminate the hazard of reaching over hot surface elements do not install cabinet storage directly above a unit.

If storage is provided, limit it to items that are infrequently used and can be safely stored in an area subjected to heat.

Temperatures may be unsafe for items such as volatile liquids, cleaners or aerosol sprays.

- Aerosol-type spray cans are **EXPLOSIVE** or highly flammable when exposed to heat. Avoid their use or storage near an appliance.
- Do not leave any items, especially plastic items, on the cooktop. The hot air from the vent may ignite flammable items, melt or soften plastics, or increase pressure in closed containers causing them to burst.
- Do not allow aluminum foil, meat probes or any other metal object, other than a pan on a surface element, to contact heating elements.

Surface Controls

Use to turn on the surface elements. An infinite choice of heat settings is available from **LOW** to **HIGH**. The knobs can be set on or between any of the numbered settings.

Setting the Controls

1. Place pan on surface element.
2. Push in and turn the knob in either direction to the desired heat setting.
 - The backguard is marked to identify which element the knob controls. For example,  indicates right front element.

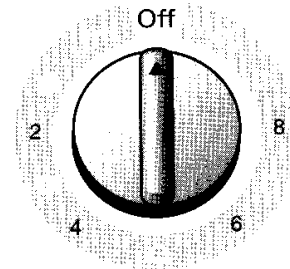

Suggested Heat Settings

The size and type of cookware will affect the heat setting. For information on cookware and other factors affecting heat settings, refer to “Cooking Made Simple” booklet.

Setting	Uses
HIGH	Use to bring liquid to a boil, blanch, or reach pressure in a pressure cooker. Always reduce setting to a lower heat when liquids begin to boil or foods begin to cook.
8 Med. Hi	Use to brown meat, heat oil for deep fat frying, saute or fry. Maintain fast boil for large amounts of liquids.
4-6 Med.	Use to maintain moderate to slow boil for large amounts of liquids and for most frying operations.
2 Med. Lo	Use to continue cooking covered foods and to maintain pressure in most pressure cookers and stew or steam operations.
LOW	Use to keep foods warm and melt chocolate and butter.

Surface Indicator Lights

There is an indicator light under each pair of control knobs. When one or both of the surface control knobs is turned on, the light will turn on. The light will turn off when the surface element(s) is turned off.

Coil Element Surface

Lift-up Porcelain Cooktop

To prevent the cooktop from discoloring or staining:

- Clean cooktop after each use.
- Wipe acid or sugar spills as soon as the cooktop has cooled as these spills may discolor or etch the porcelain.

Your range features an upswept porcelain cooktop that can be lifted up for convenient access to the area under the cooktop.

To lift cooktop: When cool, grasp the front edge of the cooktop. Gently lift up until the two support rods at the front of the cooktop snap into place.

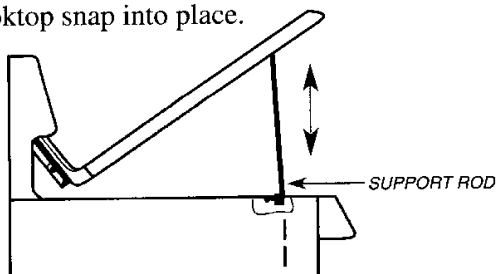

To lower cooktop: Hold the front edge of the cooktop and carefully push back on each support rod to release. Then gently lower the top into place. The support rods will slide into the range frame.

Coil Elements

- When an element is turned on, it will cycle on and off to maintain the heat setting.
- Coil elements are self-cleaning.
- Do not immerse in water.

To remove: When cool, raise element. Carefully pull out and away from receptacle.

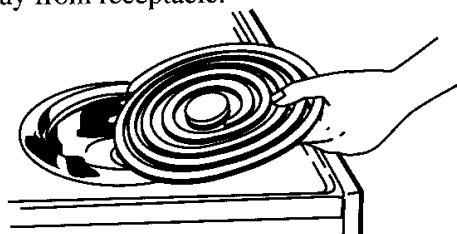

To replace: Insert terminals on the element into receptacle. Guide the element into place. Gently press down on the outer edge of the element until it sits level on the drip bowl.

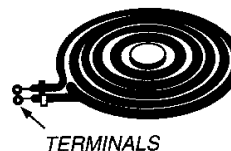

Drip Bowls

The drip bowls, located under each surface element, are designed to catch boilovers and must always be used. Absence of these bowls during cooking may damage wiring or other parts underneath the cooktop.

To prevent the risk of electric shock or fire, never line drip bowls with aluminum foil.

Drip bowls will craze over time, if overheated. This is permanent. However, it will not affect cooking performance.

To protect drip bowl finish:

- Avoid using high heat settings for long periods of time.
- Do not use oversized cookware. Pans should not extend more than 1-2 inches beyond the element.
- When home canning, use the Canning Element (Model CE1). Contact your Maytag dealer for details.
- Clean frequently. (See cleaning section, page 13.)



Oven Operation

Oven Operation CAUTIONS:

- Be sure all packing material is removed from oven before turning on.
- Do not use oven for storing food or cookware.
- Many aerosol-type spray cans are **EXPLOSIVE** when exposed to heat and may be highly flammable. Avoid their use or storage near the oven.
- **Prepared Food Warning:** Follow food manufacturer's instructions. If a plastic frozen food container and/or its cover distorts, warps, or is otherwise damaged during cooking, immediately discard the food and its container. The food could be contaminated.
- Follow the manufacturer's directions when using oven cooking bags.
- When oven is in use, the area near the oven vent may feel hot to the touch.
- Allow steam and hot air to escape before reaching into the oven to check, add or remove food.

Baking and Roasting

For additional baking and roasting tips, see "Cooking Made Simple" booklet.

Setting the Electronic Oven Controls for Baking and Roasting (select models)

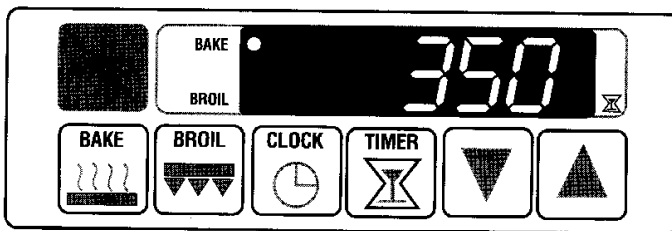

1. Press **BAKE** pad.
 - 000 and the **BAKE** indicator light will appear in the display.
 - If you press the **BAKE** pad and do not set an oven temperature within 30 seconds, the program will automatically cancel and the time of day will reappear in the display.
2. Press the **▲** or **▼** pad until the desired oven temperature is displayed.
 - The oven temperature can be set from 170° to 550° F.
 - 350° will appear in the display when either **▲** or **▼** pad is pressed once.
 - Press and tap the **▲** or **▼** pad to change the oven temperature by 5° increments or press and **hold** the **▲** or **▼** pad to change the oven temperature by 10° increments.
3. Place the food in the oven. Check food for doneness at the minimum cooking time.
4. At the end of cooking, press the **CANCEL** pad to turn the oven off and remove the food from the oven.
 - The oven features an automatic shut-off. If the oven is left on for 12 hours it will automatically turn off and 000 will appear in the display. Press the **CANCEL** pad and the time of day will reappear in the display.

Setting the Knob Control(s) for Baking and Roasting (select models)

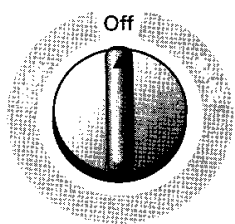

OVEN SET
(Canadian Models)

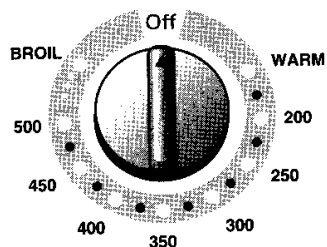

OVEN TEMP

The **OVEN TEMP** knob is used to select and maintain the oven temperature. Always turn this knob just TO the desired temperature. Do not turn to a higher temperature and then back.

The **OVEN SET** (Canadian Models) knob determines the type of oven operation. Turn this knob to the desired setting. Each setting is identified by an indent (stop) and a “click” sound. The oven will not operate if the **OVEN SET** knob is left in the OFF position.

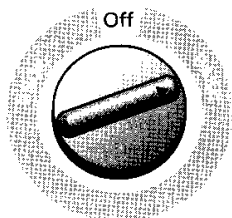

OVEN SET
(Canadian Models)

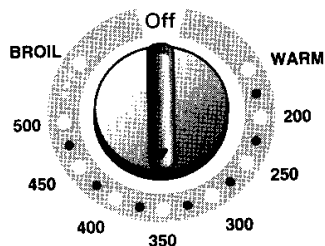

OVEN TEMP

1. When cool, position rack in oven.
2. Turn **OVEN TEMP** knob to desired temperature.
3. Turn **OVEN SET** knob to BAKE (Canadian Models).
4. Place food in center of oven.
5. Check food for doneness at minimum time in recipe. Cook longer if necessary.
6. Remove food from the oven and turn the **OVEN SET** (Canadian Models) and **OVEN TEMP** knob(s) to OFF.

Oven Indicator Light (select models)

The oven indicator light, located on the backguard, turns on whenever the oven turns on.

When the oven reaches the preset temperature, the indicator light turns off. The oven indicator light will then turn off and on as the oven elements cycle off and on.

Oven Vent

When the oven is in use, the area near the oven vent opening may feel warm or hot to the touch. Never block the vent opening.

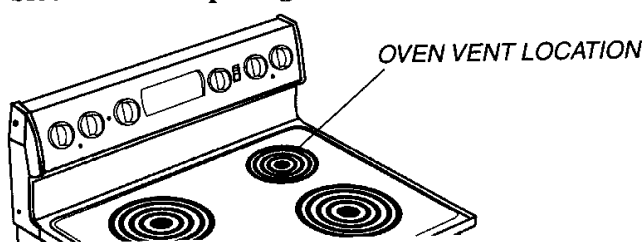

- On a coil element surface, be sure the drip bowl in the vent location has a hole in the center. Do not cover the drip bowl with aluminum foil.

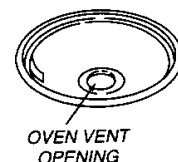

Oven Light



Push the switch on the backguard to turn the oven light on and off.

Oven Operation (continued).....

Oven Racks

CAUTION: Do not attempt to change the rack position when the oven is hot.

Your oven has two racks. They are designed with a lock-stop edge.

To remove: Pull rack straight out until it stops at the lock-stop position; lift up on the front of the rack and pull out.

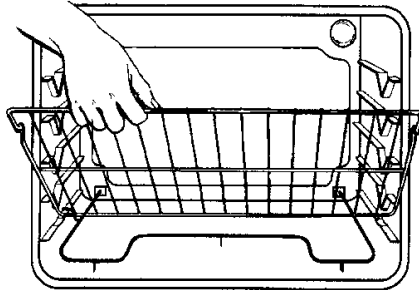

To replace: Place rack on the rack support in the oven; tilt the front end up slightly; slide rack back until it clears the lock-stop position; lower front and slide back into the oven.

Do not cover an entire rack with aluminum foil or place foil on the oven bottom. Baking results will be affected and damage may occur to the oven bottom.

Half Rack Accessory

A half rack, to increase oven capacity, is available as an accessory. It fits in the left, upper portion of the oven and provides space for a vegetable dish when a large roaster is on the lower rack. Contact your Maytag dealer for the "HALFRACK" Accessory Kit.

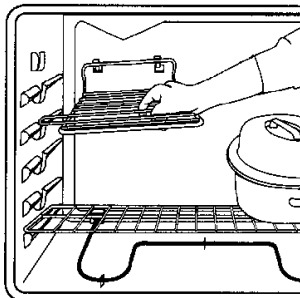

Rack Positions

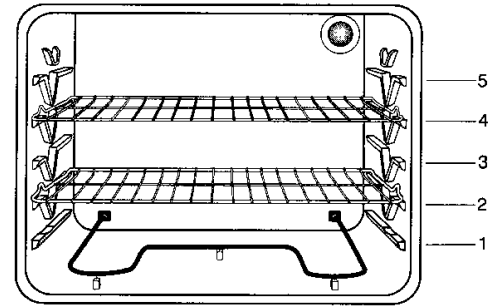

RACK 5 (highest position):

Used for toasting bread or broiling thin non-fatty foods.

RACK 4:

Used for most broiling.

RACK 3:

Used for most baked goods on a cookie sheet or jelly roll pan, layer cakes, fruit pies, or frozen convenience foods.

RACK 2:

Used for roasting small cuts of meat, casseroles, baking loaves of bread, bundt cakes or custard pies.

RACK 1:

Used for roasting large cuts of meat and poultry, frozen pies, dessert souffles or angel food cake.

Multiple Rack Cooking:

Two rack: Use rack positions 2 and 4, or 1 and 4.

Broiling

For best results, use a pan designed for broiling. For additional broiling tips, refer to the "Cooking Made Simple" booklet.

Setting the Electronic Oven Controls for Broiling (select models)

- Place the broiler pan on the recommended rack position shown in the broiling chart.
- Press the **BROIL** pad.
 - 000 and the BROIL indicator light will appear in the display.
- Press the **▲** pad to select **HI** (high) broil or the **▼** pad to set **LO** (low) broil.
 - Select HI broil for normal broiling.
 - Select LO broil for low temperature broiling to avoid excessive browning of longer cooking foods such as poultry.
 - If you do not select HI or LO Broil within 30 seconds, the program will automatically cancel and the time of day will reappear in the display.
- Preheat broil element for three minutes.
- Broil with the oven door open about four inches.
- Follow the suggested times in the broiling chart below. Meat should be turned once about halfway through its cooking time.
- Check the doneness by cutting a slit in the meat near the center to check the color.
- After broiling, press the **CANCEL** pad to turn the oven off and remove the broiler pan from the oven. The current time of day will reappear in the display.

Setting the Knob Control(s) for Broiling (select models)

- Place the oven rack on the recommended rack position shown in the broiling chart.
- Turn **OVEN TEMP** knob to **BROIL** or, for lower temperature broiling, to 450°.
 - Lower temperature broiling is used to avoid excessive browning of longer cooking foods such as poultry.
- Turn **OVEN SET** knob to **BROIL** (Canadian Models).
 - NOTE:** Oven will not operate if the **OVEN SET** knob is left in the **OFF** position.
- Preheat broil element for three minutes.
- Broil with the oven door open about four inches.
- Follow the suggested times in the broiling chart below. Meat should be turned once about halfway through its cooking time.
- Check the doneness by cutting a slit in the meat near the center to check the color.
- After broiling, turn the **OVEN TEMP** and **OVEN SET** (Canadian Models) knob(s) to **OFF**.

Broiling Chart

Type of Meat	Rack Position*	Doneness	Total Cook Time (Minutes)**
Bacon	4	Well Done	6-10 min.
Beef Steaks -- 1" thick	4	Medium	15-18 min.
	4	Well Done	19-23 min.
Chicken -- Pieces	3 or 4	Well Done	(LO Broil/450°) 30-45 min.
Fish -- Fillets Steaks, 1" thick	4	Flaky	8-12 min.
	4	Flaky	10-15 min.
Ground Beef -- Patties, 3/4" thick	4	Well Done	15-18 min.
Ham -- Precooked Slice, 1/2" thick	4	Warm	8-12 min.
Pork Chops -- 1" thick	4	Well Done	22-26 min.

* The top rack position is #5.

** Broiling times are approximate and may vary depending on the meat.



Care & Cleaning

! Cleaning CAUTIONS:

- Be sure appliance is off and all parts are cool before handling or cleaning. This is to avoid damage and possible burns.
- To prevent staining or discoloration, clean appliance after each use.
- If a part is removed, be sure it is correctly replaced.

Cleaning Chart

Parts	Cleaning Procedure
Backguard & Cooktop, porcelain enamel	<p>Porcelain enamel is glass fused on metal and may crack or chip with misuse. It is acid resistant, not acid proof. All spillovers, especially acid or sugar spillovers, should be wiped up immediately with a dry cloth.</p> <ul style="list-style-type: none"> • When cool, wash with soapy water, rinse and dry. • Never wipe off a warm or hot surface with a damp cloth. This may cause cracking or chipping. • Never use oven cleaners, abrasive or caustic cleaning agents on exterior finish of range.
Broiler Pan and Insert	<p><i>Never cover insert with aluminum foil as this prevents the fat from draining to the pan below.</i></p> <ul style="list-style-type: none"> • Place soapy cloth over insert and pan; let soak to loosen soil. • Wash in warm soapy water. Use soap filled scouring pad to remove stubborn soil. • Broiler pan and insert can be cleaned in dishwasher.
Clock & Control Pad Area	<ul style="list-style-type: none"> • Wipe with a damp cloth and dry. • Glass cleaners may be used if sprayed on a cloth first. DO NOT spray directly on control pad and display area.
Control Knobs	<ul style="list-style-type: none"> • Remove knobs in the OFF position by pulling forward. • Wash, rinse and dry. Do not use abrasive cleaning agents as they may scratch the finish. • Turn on each element to be sure the knobs have been correctly replaced.
Drip Bowls, porcelain	<p>Porcelain may craze if overheated. This is normal and will not affect cooking performance.</p> <ul style="list-style-type: none"> • When cool, wash after each use, rinse and dry to prevent staining or discoloration. May be washed in the dishwasher. • To clean heavy soil, soak in hot sudsy water, then use mild abrasive cleaner such as Soft Scrub and a plastic scouring pad. • For burned on soil, remove from range, place on newspapers and carefully spray with commercial oven cleaner. (<i>Do not spray surrounding surfaces.</i>) Place in plastic bag and allow to soak several hours. Wearing rubber gloves, remove from bag, wash, rinse and dry.
Enamel, painted Side panels Storage drawer Door (select models)	<ul style="list-style-type: none"> • When cool, wash with warm soapy water, rinse and dry. Never wipe a warm or hot surface with a damp cloth as this may damage the surface and may cause a steam burn. • For stubborn soil, use mildly abrasive cleaning agents such as baking soda paste or Bon Ami. Do not use abrasive, caustic or harsh cleaning agents such as steel wool pads or oven cleaners. These products will scratch or permanently damage the surface. <p>NOTE: Use dry towel or cloth to wipe up spills, especially acid or sugary spills. Surface may discolor or dull if soil is not immediately removed. This is especially important for white surfaces.</p>

Cleaning Chart -- continued

Parts	Cleaning Procedure
<p>Glass Oven window Oven door (select models)</p>	<ul style="list-style-type: none"> • Avoid using excessive amounts of water which may seep under or behind glass. • Wash with soap and water or glass cleaner. Remove stubborn soil with a nonabrasive cleaner such as Bon Ami and water. Rinse with clear water and dry. • Do not use abrasive materials such as scouring pads, steel wool or powdered cleaning agents. They will damage glass.
<p>Metal Finishes Trim parts</p>	<ul style="list-style-type: none"> • Wash with soap and water, a glass cleaner, or mild liquid sprays. • To prevent scratching or dulling of the finish, do not use mildly abrasive, abrasive, harsh or caustic cleaners such as oven cleaners.
<p>Oven Interior</p>	<ul style="list-style-type: none"> • Clean frequently using mild abrasive cleaners and a plastic pad. • Do not use metallic scouring pads because they will scratch the surface. • When using commercial oven cleaners follow the manufacturer's instructions. • Wipe up acid spills (tomato or milk based foods) as soon as possible with soap and water. If the spill is not wiped up, it may discolor the porcelain. <p>To make cleaning easier, remove the oven door, if desired (see Maintenance section, page 15).</p>
<p>Oven Racks</p>	<ul style="list-style-type: none"> • Clean with soapy water. • Remove stubborn soil with cleansing powder or soap-filled scouring pad. Rinse and dry.
<p>Plastic Finishes Door handles Backguard trim End caps</p>	<ul style="list-style-type: none"> • When cool, clean with soap and water, rinse and dry. • Use a glass cleaner and a soft cloth. <p><i>NOTE: Never use oven cleaners, abrasive or caustic liquid or powdered cleansers on plastic finishes. These cleaning agents will scratch or mar finish.</i></p> <p><i>NOTE: To prevent staining or discoloration, wipe up fat, grease or acid (tomato, lemon, vinegar, milk, fruit juice, marinade) immediately with a dry paper towel or cloth.</i></p>



Maintenance.....

Cleaning Products

Because of the many new cleaning products introduced in the marketplace each year, it is not possible to list all products that can be safely used to clean this appliance. Listed below are just a few examples of recommended products.

READ THE MANUFACTURER'S INSTRUCTIONS to be sure the cleaner can be safely used on this appliance.

To determine if a cleaning product is safe, test a small inconspicuous area using a very light pressure to see if the surface may scratch or discolor. This is particularly important for porcelain enamel, highly polished, shiny, painted, or plastic surfaces.

The following brands may help you to make an appropriate selection:

- **Glass Cleaners** - Cinch, Glass Plus, Windex.
- **Dishwashing Liquid Detergents** - Dawn, Ivory, Joy.
- **Mild Liquid Spray Cleaners** - Fantastik, Formula 409.
- **Multi-Surface Cleaners** - Formula 409 Glass & Surface, Windex Glass & Surface.
- **Nonabrasive Cleaners** - Bon Ami, paste of baking soda and water.
- **Mildly Abrasive Powder or Liquid Cleaners** - Ajax, Barkeepers Friend, Cameo, Soft Scrub, Smart Cleanser. (Note: If the cleaner is recommended for use on plastic, glass, or porcelain finishes, it can be used on the same type of appliance finish.)
- **Nonabrasive or Scratchless Plastic or Nylon Scouring Pads or Sponges** - Chore Boy Plastic Cleaning Puff, Scrunge Scrub Sponges, Scotch-Brite No Scratch Pads.
- **Abrasive Scouring Pads** - S.O.S., Brillo Steel Wool Soap, Scotch-Brite Wool Soap Pads.

(Brand names for the above cleaning products are registered trademarks of the respective manufacturers.)

Oven Door

! CAUTIONS:

- Do not place excessive weight on or stand on an open oven door. This could cause the range to tip over, break the door, or injure the user.
- Do not attempt to open or close door or operate oven until door is properly replaced.
- Never place fingers between hinge and front oven frame. Hinge arms are spring mounted. If accidentally hit, the hinge will slam shut against oven frame and could injure your fingers.

To remove:

1. When cool, open the oven door to the broil stop position (opened about four inches).
2. Grasp door at each side. Do not use the door handle to lift door.
3. Lift up evenly until door clears hinge arms.

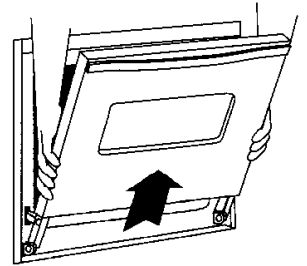

To replace:

1. Grasp door at each side.
2. Align slots in the door with the hinge arms on the range.
3. Slide the door down onto the hinge arms until the door is completely seated on the hinges. Push down on the top corners of the door to completely seat door on hinges. Door should not appear crooked.

NOTE: The oven door on a new range may feel "spongy" when it is closed. This is normal and will decrease with use.

Oven Light

⚠ CAUTIONS:

- Disconnect power to range before replacing light bulb.
- Use a dry potholder to prevent possible harm to hands when replacing bulb.
- Be sure bulb is cool before touching bulb.
- Do not touch hot bulb with a damp cloth as this may cause the bulb to break.

To replace oven light bulb:

1. Remove light bulb.
2. Replace with a 40 watt appliance bulb.
3. Reconnect power to range. Reset clock.

Leveling Legs

⚠ CAUTION:

- Be sure the anti-tip bracket secures one of the rear leveling legs to the floor to prevent the range from accidentally tipping.

The range should be leveled when installed. If the range is not level, turn the plastic leveling legs, located at each corner of the range, until range is level.

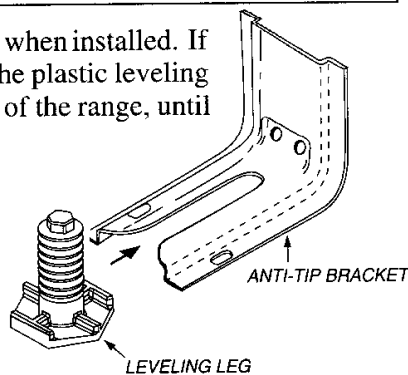

Storage Drawer

⚠ CAUTION:

- Do not store plastic, paper products, food or flammable materials in this drawer. The drawer may become too warm for these items when the oven is in use.

The storage drawer can be removed to allow you to clean under the range.

To remove:

1. Empty drawer and pull out to the first stop position.
2. Lift up the front of the drawer.
3. Pull out to the second stop position.
4. Grasp sides and lift drawer up and out.

To replace:

1. Fit the ends of the drawer glides into the rails in the range.
2. Lift up front of drawer and gently push in to the first stop position.
3. Lift drawer up again and push until drawer is closed.

Convenience Outlet (Canadian models only)

The convenience outlet is located on the lower left side of the backguard. It is useful for small appliances such as waffle irons.

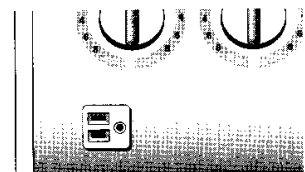

When using the outlet be sure the appliance cord does not rest on or near the surface element. If the surface element is turned on, the cord and outlet will be damaged.

The convenience outlet circuit breaker may trip if the small appliance plugged into it exceeds 10 amps. To reset the circuit breaker, press the switch located on the lower edge of the backguard. (See illustration.)



Before You Call for Service.....

Check these points if . . .

Part or all of the appliance does not work.

- Check to be sure plug is securely inserted into receptacle.
- Check or re-set circuit breaker. Check or replace fuse.
- Check power supply.
- Check if surface and/or oven controls have been properly set. See pages 7, 9 and 10.

Surface or oven elements fail to operate or heat food.

- Check to be sure plug is securely inserted into receptacle.
- Check or re-set circuit breaker. Check or replace fuse.
- Check power supply.
- Check if surface and/or oven controls have been properly set. See pages 7, 9 and 10.
- Check if coil element is properly installed. See page 8.
- Check to see if coil elements need to be replaced.

Baking results are not what you expected.

- Check the oven temperature selected. Make sure oven is preheated when recipe or directions recommend preheat.
- Check rack positions. See page 11.
- Use correct pan. Dark pans produce dark browning. Shiny pans produce light browning. See **“Cooking Made Simple”** booklet for more information on bakeware.
- Check the use of foil in the oven. Never use foil to cover an entire oven rack. Place a small piece of foil on the rack below the pan to catch spillovers.
- Check pan placement. Stagger pans when using two racks. Allow 1–2 inches between pans and oven walls.
- Make sure the oven vent has not been blocked. See page 10 for location.
- Check to make sure range is level.

Baking results differ from previous oven.

- Temperatures often vary between a new oven and an old one. As ovens age, the oven temperature often “drifts” and may become hotter or cooler.

Food is not broiling properly.

- Check oven setting. See page 12.
- Check oven rack positions. See page 12.
- Broil element was not preheated.
- Aluminum foil was incorrectly used. Never line the broiler insert with foil.
- Oven door was closed during broiling. Leave the door open to the first stop position (about 4–inches).

Oven smokes excessively during broiling.

- Food too close to element. See page 12 for more information.
- Broiler insert covered with aluminum foil.
- Trim excess fat from meat prior to broiling.
- A soiled broiler pan was used.

Moisture collects on oven window.

- This is normal when cooking food high in moisture.
- Excessive moisture was used when cleaning the window.

There is a strong odor when oven is turned on.

- This is normal for a new range and will disappear after a few uses.
- Excessive food soils on the oven bottom.

“F” plus a number appears in display.
(select models)

- This is called a fault code. If a fault code appears in the display and beeps sound, press the **CANCEL** pad. If the fault code and beeps continue, disconnect power to the appliance and call an authorized servicer.

If You Need Service

- Call the dealer from whom your appliance was purchased or call Maytag Customer Assistance at 1-800-688-9900, USA or 1-800-688-2002, CANADA to locate an authorized servicer.
- Be sure to retain proof of purchase to verify warranty status. Refer to WARRANTY (next page) for further information of owner's responsibilities for warranty service.
- If the dealer or service company cannot resolve the problem, write to Maytag Customer Assistance c/o Maytag Customer Service, P.O. Box 2370, Cleveland, TN 37320-2370, or call **1-800-688-9900, USA or 1-800-688-2002, CANADA**. When contacting Customer Assistance be sure to provide the model and serial numbers of your appliance, the name and address of the dealer from whom you purchased the appliance, and the date of purchase.
- Should you still have a problem, write to the Major Appliance Consumer Action Program, 20 North Wacker Drive, Chicago, IL 60606. MACAP is an industry sponsored but independent group of consumer experts who receive and act on complaints from appliance owners.

NOTE: When writing about an unresolved service problem, please include the following information:

- a. Your name, address and telephone number;
 - b. Model number and serial number;
 - c. Name and address of your dealer and date the appliance was bought;
 - d. A clear description of the problem you are having.
- User's guides, service manuals and parts catalogs are available from Maytag Customer Assistance.



Maytag Range Warranty.....

Full One Year Warranty

For **one (1) year** from the date of original retail purchase, any part which fails in normal home use will be repaired or replaced free of charge.

Limited Warranty

Second Year - After the first year from the date of original purchase through the second year, parts which fail in normal home use will be repaired or replaced free of charge for the part itself, with the owner paying all other costs, including labor, mileage and transportation.

Third Through Fifth Year - After the second year from the date of original purchase through the fifth year, all of the following components which fail in normal home use will be repaired or replaced free of charge for the part itself, with the owner paying all other costs, including labor, mileage and transportation. These components include:

- **All Electronic Clocks:** on electric and gas ranges.
- **Electric Heating Elements:** includes all surface elements, broil and bake elements.
- **Glass-ceramic Cooktop:** which cracks or breaks during normal home use.

Third Through Tenth Year - After the first year from the date of original purchase through the tenth year, sealed gas burners which fail in normal home use will be repaired or replaced free of charge for the part itself, with the owner paying all other costs, including labor, mileage and transportation.

Canadian Residents

This warranty covers only an appliance installed in Canada that has been certified to a National Standard of Canada unless the appliance is brought into Canada due to transfer of residence from the United States to Canada.

Limited Parts Warranty Outside the United States and Canada

For appliances located outside the United States and Canada, the only warranty provided with the appliance is as follows: For two (2) years from the date of original retail purchase, any part which fails in normal home use will be repaired or replaced free of charge for the part itself, with the owner paying all other costs, including labor, mileage and transportation.

The specific warranties expressed above are the **ONLY** warranties provided by the manufacturer. These warranties give you specific legal rights, and you may also have other rights which vary from state to state.

MAYTAG • 403 West Fourth Street North • Newton, Iowa 50208

Free Manuals Download Website

<http://myh66.com>

<http://usermanuals.us>

<http://www.somanuals.com>

<http://www.4manuals.cc>

<http://www.manual-lib.com>

<http://www.404manual.com>

<http://www.luxmanual.com>

<http://aubethermostatmanual.com>

Golf course search by state

<http://golfingnear.com>

Email search by domain

<http://emailbydomain.com>

Auto manuals search

<http://auto.somanuals.com>

TV manuals search

<http://tv.somanuals.com>