

Revised October 27, 2000

MAINTENANCE SCHEDULE

NORMAL SERVICE INTERVALS

5,000 miles*	A
7,500 miles	A
15,000 miles	A
22,500 miles	A
30,000 miles	A B
37,500 miles	A
45,000 miles	A
52,500 miles	A
60,000 miles	A B C D
67,500 miles	A
75,000 miles	A
82,500 miles	A
95,000 miles	A B

 **Tip:** For additional service intervals and complete details, see Owner's Manual

Maintenance notes:

Rotate tires every 3,750 miles

- A.** Change: Engine oil/replace filter
- B.** Inspect: Drive belts, fuel lines and hoses, idle speed, brake lines and hoses, disc and drum brakes, steering operation and linkages, front suspension ball joints, driveshaft dust boots, chassis and body bolts, exhaust system and heat shields
- Replace: Air filter, spark plugs (2.0L)
- C.** Inspect: Engine valve clearance, hoses and tubes for emission system
- Replace: Spark plugs (2.5L)
- D.** Inspect: Engine timing belt

* Special operating conditions

† See Owner's Manual

This Quick Tips® guide is provided by MazdaTown to make your Mazda ownership experience more convenient. It is not intended to replace your Owner's Manual.

If you have any questions about your vehicle, you are invited to contact your local dealer.

Or if you need additional help, feel free to call our

Customer Assistance Center at 1-800-222-5500

Monday through Friday,
9 am-4:45 pm, Pacific
9 am-5:45 pm, Eastern/Central



©2000 Calcar. Quick Tips® is a trademark of Calcar, made in USA. 7/00 46.8M GL Mazda North American Operations reserves the right to change product specifications at any time without incurring obligations.



2001

626

Quick Tips®

Reference
Guide for
Controls and
Functions

mazda
Get In. Be moved.

Revised October 27, 2000

DRIVER'S VIEW

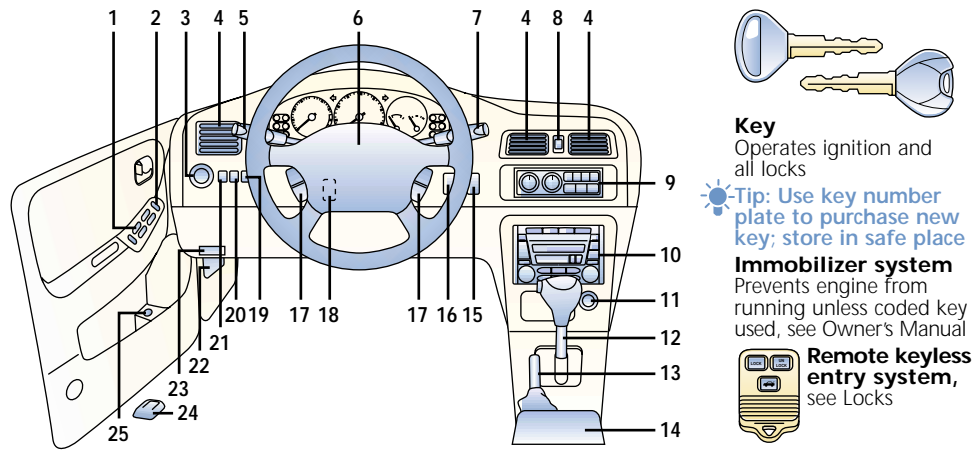
**Key**

Operates ignition and all locks

Tip: Use key number plate to purchase new key; store in safe place

Immobilizer system
Prevents engine from running unless coded key used, see Owner's Manual

Remote keyless entry system,
see Locks

1. Power window switches,
see Switches

2. Power door locks,
see Locks

3. Dual power mirrors,
see Switches

4. Air vents

5. Turn signal/lighting control lever,
see Driver Controls

6. Horn/Air bag

7. Wiper/washer control lever,
see Driver Controls

8. Swing
Press to activate/deactivate center air vent oscillation

9. Climate control panel,
see Climate Controls

10. Audio system,
see Audio System

11. Accessory socket*

12. Gearshift lever (A/T)*,
see Transmission

13. Parking brake lever,
see Console/Trunk

14. Console,
see Console/Trunk

15. Rear window defogger*

Press on/off; shuts off with ignition; also operates heated side mirrors*

16. Hazard warning switch

Press on/off

17. Cruise control,

see Driver Controls

18. Tilt steering wheel lever

Pull lever down to unlock column, position wheel, push lever up to lock

Tip: If lever does not lock move wheel up/down slightly until lever clicks into recess

19. Traction Control System*,

see Under Hood

20. Instrument panel lighting

To brighten/dim turn thumb-wheel up/down

21. Fog lights*

Press on/off

22. Fuse panel

23. Hood release handle

24. Remote fuel-door release

25. Remote trunk-lid release

Push to open trunk

*Denotes optional equipment

Always check the Owner's Manual for more operating information and safety features

Driver's View

Revised October 27, 2000

Instrument
Cluster

INSTRUMENT CLUSTER

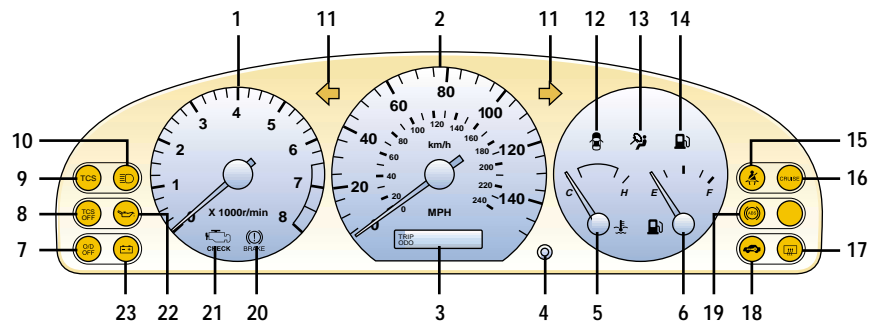

*Denotes optional equipment

GAUGES

1. **Tachometer**
2. **Speedometer**
3. **Odometer/trip odometer**
4. **Odometer/trip odometer selector**
Press to select among trip A, trip B, and odometer
Press and hold to reset selected trip meter
5. **Engine coolant temperature gauge**
If above normal range, stop vehicle and turn off engine, check coolant level when safe
6. **Fuel gauge**

WARNING LIGHTS

7. **Overdrive off indicator***, see Transmission
8. **Traction Control System* off**, System turned off manually or malfunctioning, dealer inspection required
9. **TCS Traction Control System***, Light flashes when in use; dealer inspection required if light remains on
10. **High beams on**
11. **Turn signals/hazard warning on**
12. **Door ajar**
13. **Air bag readiness**
Air bag malfunction, dealer inspection required
14. **Low fuel**
15. **Always fasten safety belts**
16. **Cruise control on**
17. **Rear window defogger on**
18. **Immobilizer system on**, see Driver's View
19. **Anti-lock Brake System (ABS)***
ABS malfunction, normal brakes only, dealer inspection required
20. **Brake system**
Parking brake on/low fluid level
21. **Check engine**
Dealer inspection required
22. **Engine oil pressure warning light**
23. **Charging system warning light**
Dealer inspection required

Always check the Owner's Manual for more operating information and safety features

Instrument
Cluster

Revised October 27, 2000

Driver Controls

DRIVER CONTROLS

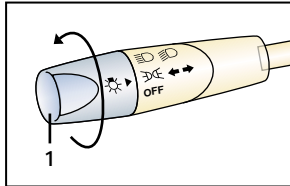
**Turn signal/lighting control lever****OFF** = Lights off

D = Tail, parking and dashboard lights on: Rotate knob (1) to first notch

D = Tail, parking, dashboard and headlights on: Rotate knob (1) to second notch

High beams on/off: Push forward/ pull back to detent

To flash high beams: Pull back slightly and release

Turn signals right/left: move lever up/down

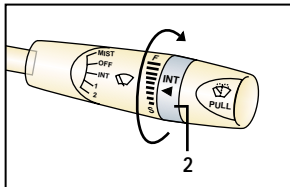
**Wiper/washer control lever**

Intermittent wiper: One click down

To change interval speed: Rotate inner ring (2)

Normal wiper speed: Two clicks down

Fast wiper speed: Three clicks down

Single wipe: Push stalk up

Washer: Pull stalk back

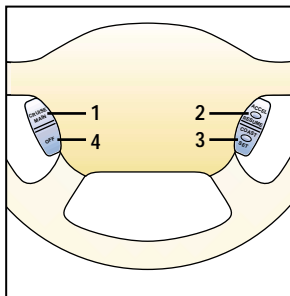
**Cruise control**

Operates above 25 mph

To activate: Press and release CRUISE MAIN (1)

To set speed: Press and release SET/COAST (3) at desired

To accelerate: Press and hold RESUME/ACCEL (2); incremental acceleration: Press and release (2), each tap = plus 1mph

To decelerate: Press and hold SET/COAST (3), release at desired speed; or tap brake pedal, press and release (3) at desired speed; incremental deceleration: Press and release (3), each tap = minus 1 mph

To cancel: Tap brake pedal, clutch pedal (manual transaxle) or press OFF button (4)

Return to preset speed (after braking): Press and release RESUME/ACCEL button (2)

Always check the Owner's Manual for more operating information and safety features

Cruise Control

Revised October 27, 2000

Switches

SWITCHES

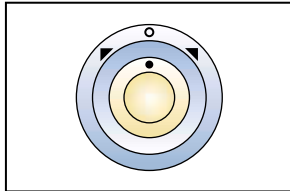
**Dual power mirrors**

Ignition switch must be in ACC or ON position

Switch is on left side of dash

To adjust left/right mirror:
Rotate dash knob left/right,
tilt knob in direction of desired
mirror movement

Tip: To lock mirrors in place, rotate knob to center position

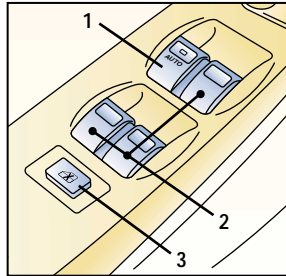
**Power window switches**

Ignition switch must be in ON position

All windows controlled from the driver's armrest; passenger doors have separate switches

1. Driver's window

One-touch-down: Push down firmly and release, window goes down all the way; pull switch back briefly to stop; press lightly and hold for normal operation

2. Passenger window switches

Push down and hold to open, pull back and hold to close

3. Power window lockout switch

Press down until click, only driver's window operates; press again and passenger windows function again

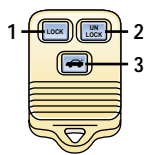
**Remote keyless entry system**

Functions only with ignition in OFF position

To lock doors:

Press LOCK (1); pressing again within 5 seconds causes doors to relock and horn to beep

To unlock: Press UNLOCK (2) for driver's door; press again within 5 seconds to unlock other doors

To open trunk: Press (3)

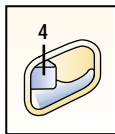
**Manual door locks****4. Lock tabs**

To lock: Press front of tab toward door handle

To unlock: Pull front of tab away from door handle

**Power door locks****5. Master front door lock switches**

To lock/unlock all doors:

Press left/right side of switch

To lock doors without key:
With door open, press left side of door switch, exit car, close doors

To unlock: Use key to unlock driver's front door, open door and press right side of switch to unlock other three doors

Tip: Doors can be locked with key in ignition (chime sounds to alert you to key in ignition)

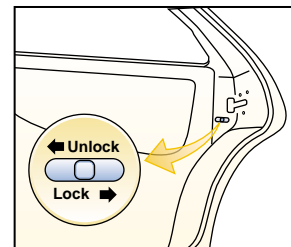
**Childproof locks**

Located at the edge of rear doors

To activate: Push tab toward LOCK; door opens from outside only

To cancel: Push tab toward UNLOCK

*Denotes optional equipment

Always check the Owner's Manual for more operating information and safety features

Locks

Revised October 27, 2000

Interior
Lights

INTERIOR LIGHTS

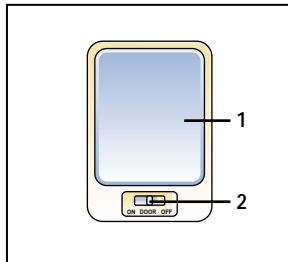

1. Interior light
2. Interior light switch

ON = light always on
DOOR = light on when door open
OFF = light always off

Illuminated visor mirrors

Mirrors lighted when covers open, off when closed

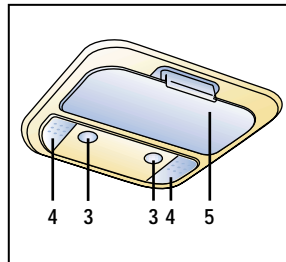

3. Map/reading light
4. Map/reading light switch
Press on/off
5. Storage
Press lip forward to open

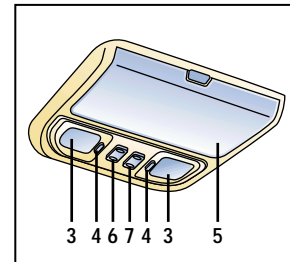

6. Sunroof tilt switch*
Press rear of switch to tilt rear of sunroof
Press front of switch to close
7. Sunroof slide switch*
Press rear of switch to open sunroof
Press front of switch to close

*Denotes optional equipment

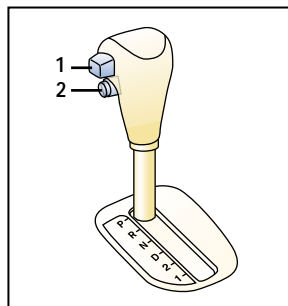
**Automatic transmission*****P = Park**

To move gearshift from Park: Press firmly on brake pedal, then press release button (1) on gearshift

R = Reverse

N = Neutral No gear engaged

D (Overdrive)

For normal driving: Shifts through four forward gears automatically

 **Tip: Torque converter lock-up improves fuel economy and can feel like an additional gear change**

D (Overdrive Off)

Press (2) to disengage/engage overdrive

Provides extra power and increased engine braking, stops 3rd-4th gear cycling

2 = Second

Provides extra power and increased engine braking
Use to reduce wheel spin when starting on slippery surfaces

1 = Low

Use for engine braking when second gear is not sufficient

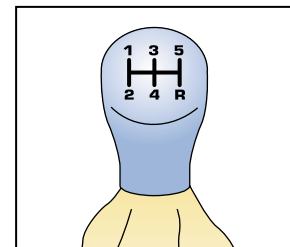
**Manual transmission***

Depress clutch pedal to start engine and change gears

 **WARNINGS: Do not shift into 1st above 20 mph or clutch failure could occur**

Resting your foot on clutch pedal while driving and using the clutch to hold your vehicle at a stand still while waiting on a hill may reduce clutch life

Always check the Owner's Manual for more operating information and safety features

Transmission

Revised October 27, 2000

Seats

SEATS

Manual controls**1. Fore-aft adjustment**

Lift lever and hold, slide seat, release lever

2. Raise/lower front of seat

Rotate knob

3. Seat back angle

To adjust: Lift and hold lever, lean forward or backward, release lever

4. Head restraint

To raise/lower: Pull up/push in release button (5) and push down

⚠ WARNINGS: Always wear your safety belt and properly secure children 12 and under in the rear seat

If you choose to install a forward-facing child safety seat in the front seating positions, move vehicle seat as far back as possible

Air bag is supplemental and does not replace safety belt usage

Do not adjust seat while driving

**Power driver's seat*****6. Raise/lower front of seat**

Pull/push front of switch vertically

Fore/aft adjustment

Slide switch horizontally

Raise/lower rear of seat

Pull/push rear of switch vertically

Raise/lower seat cushion

Pull/push center of switch vertically

☀ Tip: Side-impact air bags* deploy from outboard side of driver and front passenger seat backs

Folding rear seat backs, see Console/Trunk

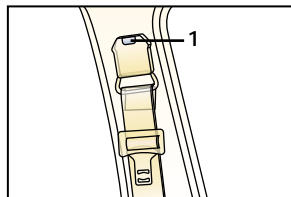
**Shoulder belt height adjustment**

To raise/lower belt: Push release button (1) and slide to desired location

⚠ WARNING: Make sure adjuster locks in one of its positions

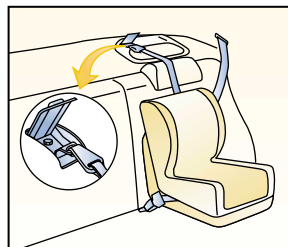
**Child-restraint seat**

Use dual locking mode retractor safety belt; see Owner's Manual for proper installation and child-restraint seat tether instructions

⚠ WARNINGS: Children less than 4 years old and under 40 pounds should always use a child safety seat

Do not place rear-facing child safety seat in front seat

Dual locking mode lap/shoulder belt retractor (front passenger and rear safety belts only)

Emergency locking mode: Belt locks only on hard braking/cornering or impacts of about 5 mph or more

Automatic locking mode: Must be used when installing child-restraint seat

To activate: Pull webbing fully out of retractor until click is heard; belt will only tighten

To disengage: Unbuckle belt and allow webbing to retract fully

*Denotes optional equipment

Always check the Owner's Manual for more operating information and safety features

Seats

Revised October 27, 2000

Climate Controls







CLIMATE CONTROLS

1. Fan control

Rotate knob between ○ (OFF) and 4 (HIGH)

2. Temperature control

Cooler/warmer = rotate knob counterclockwise/clockwise

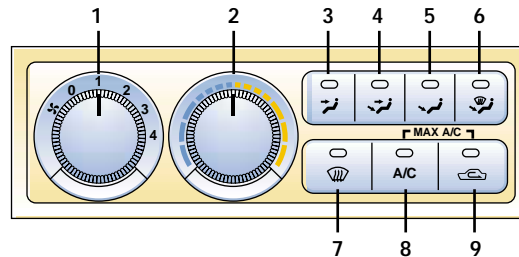
3.  = air to dash**4.**  = air to dash and floor**5.**  = air to floor**6.**  = air to floor and windshield**7.**  = air to windshield (defrost)**8. A/C*** = air conditioner
Press to turn on/off**9.**  = recirculated air
Press on/off; use for maximum heating/cooling or to keep outside odors out

Warning: Do not use  position in cold weather, windows may fog and hamper vision

Oscillating center air vents, see Driver's View

Control positions for maximum defrost

Fan to maximum, temperature to maximum hot,  selected

Tips: To help prevent windshield fogging in humid weather, select  before starting engine

To prevent moisture buildup, never drive with system off
Objects placed under the front seats may interfere with air flow to the rear

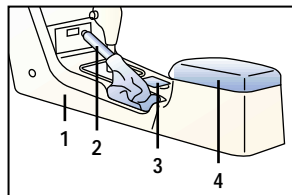
**1. Console****2. Parking-brake lever**

To engage: Pull up

To release: Pull up slightly while depressing button at front of lever, lower hand brake lever

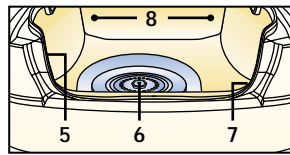
3. Cup holder**4. Storage bin****Trunk**

To open: Use key or remote keyless entry fob

Remote trunk release, see Driver's View**5. Trunk security switch**

OFF = trunk only opens with primary key

 = trunk unlocked; normal operation

6. Spare tire

Stored under panel in trunk

Temporary spare tire

Do not exceed 50 mph

To change flat tire: Follow instructions in Owner's Manual

7. Jack

Stored behind right rear panel

8. Rear seatback lock

To disable/enable folding seats move knob to lock/unlock

Split rear folding seatback*

To fold: unfasten the lap portion of the rear center seat belt pull release knob, push seat back down

To return and lock: Push seat back firmly until latched, re-attach center belt

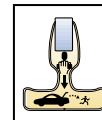
**Interior luggage compartment release***

Allows you to escape should you become locked in trunk

To open: Pull "T" handle; "T" handle will glow if it has been exposed to light

*Denotes optional equipment

Always check the Owner's Manual for more operating information and safety features

Console/
Trunk

Revised October 27, 2000

Audio
System

AM/FM/CASSETTE/CD STEREO

1. Power/Volume

Press to turn on/off; rotate to increase/decrease volume

2. Memory preset buttons

To set: Tune to station, press and hold until beep is heard

3. SEEK/TRACK/APC

Radio: Press \wedge/\vee to automatically seek higher/lower frequency

CD: Press \wedge/\vee to select next/previous track

Tape: Press APC button \wedge/\vee to automatically advance tape to beginning of next selection/replay selection, to stop this operation; press button again

4. Load*

Single CD loading: Press button, WAIT will appear; when IN appears and CD door opens, load CD

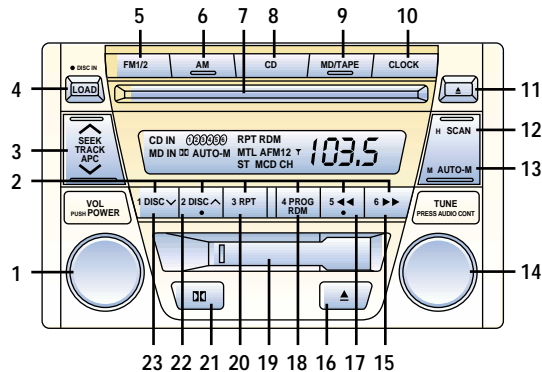

AM/FM Radio with Cassette Tape*/Mini-disc* and Compact Disc Player/Changer*

Multiple CD loading: Press and hold LOAD until beep is heard; when IN is displayed load CD; when IN displays again load next CD

5. FM1/2

Press to select between FM1/FM2 station preset buttons (2)

6. AM

Press to select AM frequency band

7. CD Slot**8. CD**

Press to play CD

9. MD/Tape

Press to play Mini-disc Player*/cassette tape

10. Clock

To set: Press (10) and hold until display blinks and then press Minutes (13)/Hours (12) to advance; press (10) again to set

11. CD eject**12. Scan**

Press to briefly sample next listenable selections; functions in all modes

13. Auto-Memory

Radio: Press and hold until it beeps, system automatically scans and temporarily stores 6 strong stations in each band; press again to cancel

14. Tuning/Audio Control

Tune: Rotate counterclockwise/clockwise for lower frequency/higher frequency
Audio control: Press to select BASS/MID/TREBLE/FADE/BALANCE: rotate right/left to adjust selected feature

15. Fast forward/Rewind

Press to fast forward

16. Eject Cassette Tape**17. Reverse/Rewind**

Press to rewind tape

18. Program Random

Press to enable/cancel random play

19. Cassette*/Mini-disc* door**20. Repeat**

Press to replay current CD/tape selection

21. Dolby®

Reduces tape noise/hiss
Press to activate/deactivate

22. Disc up \wedge

Press to skip forward to beginning of next CD

23. Disc down \vee

Press to skip back to beginning of previous CD

*Denotes optional equipment

Always check the Owner's Manual for more operating information and safety features

Audio
System

Revised October 27, 2000

Under Hood

UNDER HOOD

1. Windshield washer reservoir

Fill with windshield washer fluid

2. Power steering fluid reservoir

Check with engine off and at normal temperature, fill to MAX mark

3. Engine oil dipstick

Check with engine off and at operating temperature; fluid level should be between F and L marks on dipstick

4. Engine oil filler cap

SAE 5W-30/10W-30 depending on temperature

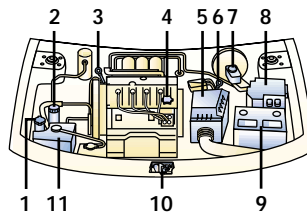
5. Air filter

2.0-liter 4-cylinder

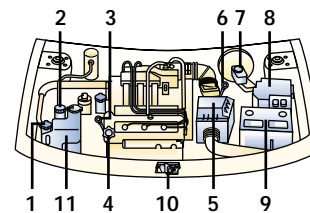

2.5-liter V6

6. Automatic transmission fluid dipstick*

Check with engine on at operating temperature; fluid level should be within cross-hatched area/between top two notches on dipstick

7. Brake/Clutch* fluid reservoir

Fill to MAX mark with DOT 3 fluid; check with cap on

8. Fuse block**9. Battery****10. Hood latch**

Push hood latch to the left, open hood

11. Engine coolant reservoir

Level should be between F and L lines when cold

⚠ WARNING: Never remove coolant reserve tank cap while engine is running or hot; remove only when safe

Break-in period

First 600 miles: Drive at varying road and engine speeds; avoid full throttle, rapid acceleration or kick-down of transmission. Do not use special "break-in" oils

⚡ Tip: Follow same procedures with overhauled engine or when brakes are replaced

Anti-lock Braking System (ABS)*

ABS automatically reduces hydraulic pressure to any wheel on the verge of locking up. You may feel a slight pulsing of the brake pedal and hear a clicking noise; this tells you the ABS is functioning properly; increase pressure on pedal for maximum braking

⚡ Tips: Maintain constant pressure on the brake pedal. Do not pump the brakes

ABS self test*

A self-diagnostic test is performed when starting; you may feel some brake pedal pulsation and hear some noise, this is normal

Traction Control System*

Automatically applies and releases brakes to prevent excessive wheel spin at all speeds, especially when accelerating on slippery surfaces

Tire economy and tips

Check pressure at least monthly when tires are cold. Maintain correct front-end alignment and tire balance; rotate tires at the mileage shown in the Maintenance Guide; see Owner's Manual for rotation chart

Tire pressure

Decal on the edge of the driver's door provides tire pressure information

Snow chains

Install only on front tires; install as tightly as possible and retighten periodically

⚠ WARNING: Use only SAE Class "S" chains

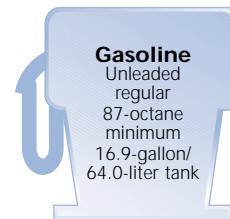

*Denotes optional equipment

Always check the Owner's Manual for more operating information and safety features

Free Manuals Download Website

<http://myh66.com>

<http://usermanuals.us>

<http://www.somanuals.com>

<http://www.4manuals.cc>

<http://www.manual-lib.com>

<http://www.404manual.com>

<http://www.luxmanual.com>

<http://aubethermostatmanual.com>

Golf course search by state

<http://golfingnear.com>

Email search by domain

<http://emailbydomain.com>

Auto manuals search

<http://auto.somanuals.com>

TV manuals search

<http://tv.somanuals.com>