

Revised January 9, 2001

## MAINTENANCE SCHEDULE

### NORMAL SERVICE INTERVALS

5,000 miles*	A
7,500 miles	A
15,000 miles	A
22,500 miles	A
30,000 miles	A B
37,500 miles	A
45,000 miles	A C
52,500 miles	A
60,000 miles	A B D
67,500 miles	A
75,000 miles	A C
82,500 miles	A
90,000 miles	A B

 **Tip:** For additional service intervals and complete details, see Owner's Manual

### Maintenance notes:

Rotate tires every 3,750 miles  
Replace cabin air filter<sup>†</sup> once a year or every 12,000 miles<sup>†</sup>

**A.** Change: Engine oil/replace filter

**B.** Inspect: Drive belts, fuel lines and hoses, idle speed, brake lines, hoses and connections, disc brakes, steering operation and linkages, front and rear suspension ball joints, driveshaft dust boots, chassis and body bolts, exhaust system and heat shields, automatic transaxle fluid level

Replace: Air filter, spark plugs (2.5L)

**C.** Change: Engine coolant

**D.** Inspect: Engine valve clearance (2.3L), hoses and tubes for emission system

Inspect (2.5L)/replace (2.3L):

Engine timing belt<sup>†</sup>

Replace: Spark plugs (2.3L)

\* Special operating conditions

<sup>†</sup> See Owner's Manual

<sup>‡</sup> Denotes optional equipment

This Quick Tips® guide is provided by MazdaTown to make your Mazda ownership experience more convenient. It is not intended to replace your Owner's Manual.

If you have any questions about your vehicle, you are invited to contact your local dealer. Or if you need additional help, feel free to call our

**Customer Assistance Center  
at 1-800-222-5500**

Monday through Friday,  
8 am-5 pm



©2001 Calcar. Quick Tips® is a trademark of Calcar, made in USA. 7/00 46M GL. Mazda North American Operations reserves the right to change product specifications at any time without incurring obligations.

2001



# millenia

Quick Tips®

Reference  
Guide for  
Controls and  
Functions



Revised January 9, 2001

## DRIVER'S VIEW

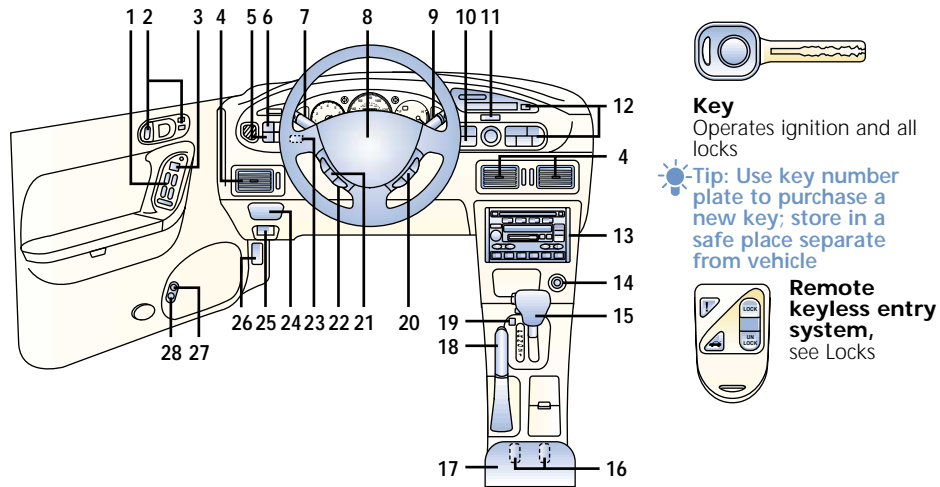

- |  |   |  |
|--|---|--|
| 1. Power window switches, see Switches   | 11.  Hazard warning switch<br>Press on/off                                | 21. Steering wheel audio controls, see Audio System  |
| 2. Power door locks, see Locks   | 12. Climate control panel, see Climate Controls                           | 22. Auto-tilt steering column<br>To raise/lower wheel; press switch up/down<br>Press AUTO to raise wheel when key is removed from ignition |
| 3. Power outside mirror switch, see Switches   | 13. Audio system, see Audio System  | 23.  Instrument panel lighting<br>To brighten/dim: Turn thumb-wheel right/left   |
| 4. Air vents   | 14. Cigarette lighter   | 24. Coin holder  |
| 5. Cruise control main switch, see Driver Controls   | 15. Gearshift lever, see Transmission                                     | 25.  Hood release handle   |
| 6. Fog lights<br>Press on/off  | 16. Left/right seat warmer*<br>To turn on/off: press top/bottom of switch | 26. Fuse panel   |
| 7. Turn signal/lighting control lever, see Driver Controls   | 17. Console, see Console/Trunk  | 27.  Remote trunk release<br>Press to open trunk   |
| 8. Horn/air bag<br>Press for horn  | 18. Parking brake lever, see Console/Trunk                                | 28.  Remote fuel door release  |
| 9. Wiper/washer lever, see Driver Controls   | 19. Traction control system*, see Transmission                            |  |
| 10.  Rear window defogger<br>Press on/off; shuts off with ignition, also operates side mirror defroster* | 20. Cruise control switches, see Driver Controls                          |  |

\*Denotes optional equipment

Always check the Owner's Manual for more operating information and safety features

Driver's  
View

Revised January 9, 2001

## Instrument Cluster

## INSTRUMENT CLUSTER

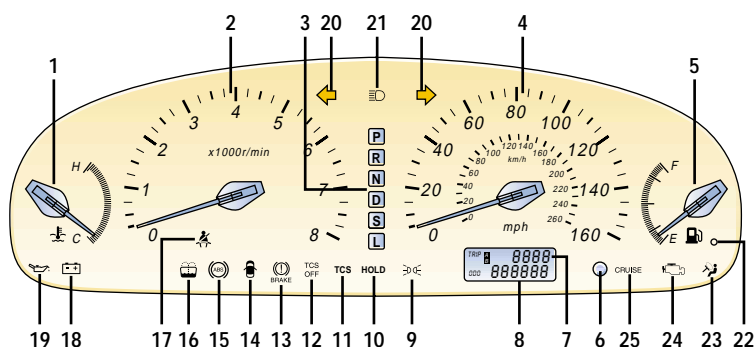

## GAUGES

1. **Coolant temperature gauge**  
If above normal range, stop vehicle and turn off engine; check coolant level when safe
2. **Tachometer**
3. **Gear indicator**
4. **Speedometer**
5. **Fuel gauge**  
18-gallon/68-liter tank
6. **Trip odometer reset button**
7. **Trip odometer**
8. **Odometer**

## WARNING LIGHTS

9. **Lights on**
10. **Hold mode on**, see Transmission

11. **TCS Traction control system\***, Light flashes when in use; dealer inspection required if light remains on
12. **Traction control off\***, see Transmission
13. **Brake system**  
Parking brake on/low fluid level
14. **Door ajar**
15. **Anti-lock Brake System (ABS)**  
ABS malfunction, normal brakes only, dealer inspection required
16. **Low washer fluid\***
17. **Always fasten safety belts**

18. **Charging system warning light**  
Dealer inspection required
19. **Low engine oil pressure warning light**  
Stop vehicle and turn off engine; check oil level
20. **Turn signals/hazard warning on**
21. **High beams on**
22. **Low fuel**
23. **Air bag readiness**  
Air bag malfunction, dealer inspection required
24. **Check engine**  
Dealer inspection required
25. **Cruise control on**

\*Denotes optional equipment

Always check the Owner's Manual for more operating information and safety features

## Instrument Cluster

Revised January 9, 2001

## Driver Controls

## DRIVER CONTROLS

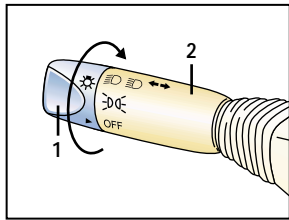
**Turn signal/lighting control lever**

OFF = Lights off

☰☑ = Tail, parking and dashboard lights on: Rotate knob (1) to first notch

☰☑☑ = Tail, parking, dashboard and head lights on: Rotate knob (1) to second notch

High beams on/off: Push lever (2) forward to detent/pull back  
To flash high beams: Pull lever (2) toward you and release

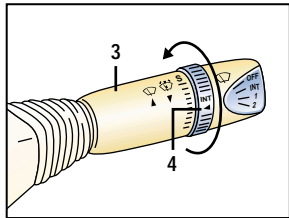
**Wiper/washer control lever**

To activate interval wipers: Push lever (3) down to first detent and rotate ring (4) to desired speed

To activate normal speed: Push lever (3) down to second detent

To activate high speed: Push lever (3) down to third detent

To activate washer: Pull lever (3) toward you  
Single wipe: Push lever (3) forward and release

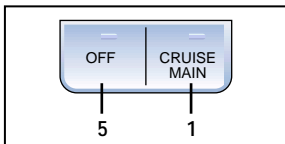
**Cruise control**

Operates above 25 mph

Press and release CRUISE MAIN (1)

To set speed: Accelerate to desired speed, press and release SET/COAST (2)

To decelerate: Press and hold SET/COAST (2)

To increase speed: Press and hold RESUME/ACCEL (3)

To cancel: Press CANCEL (4), tap brake pedal or press OFF (5)

To resume preset speed after CANCEL or braking: Press RESUME/ACCEL (3)

**Steering-wheel audio controls**

To increase volume: Press (6)

To advance AM/FM stations, cassette selections or CD tracks: Press (7)

To decrease volume: Press (8)

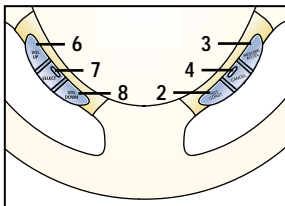

*Always check the Owner's Manual for more operating information and safety features*

Driver Controls

Revised January 9, 2001

## Switches

## SWITCHES

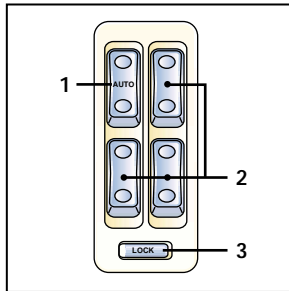
**Power window switches**

Operates only with ignition ON  
All windows controlled from driver's door; passenger doors have separate switches

Driver's window (1): "One-touch-down," press bottom of switch and release, window goes down all the way; tap top of switch to stop; press and hold top of switch to close

Passenger window switches (2): Press bottom/top of switch to open/close

Power window lock switch: Press LOCK (3): Only driver's window switches function; push (3) again; all window switches function again

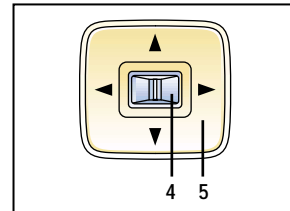
**Dual power mirrors**

Operates only with ignition on

To adjust left/right mirror: Slide selector switch (4) left/right, press perimeter switch (5) in direction of desired mirror movement

 **Tip:** To lock mirrors in place, move switch to center position

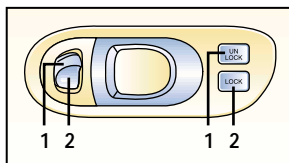
**Master front door lock switches**

To unlock all doors: Press UNLOCK (1) on either switch, turn key counterclockwise in driver's/front passenger's door

To lock all doors: Press LOCK (2) on either switch, manually lock driver's door, or lock either front door with key

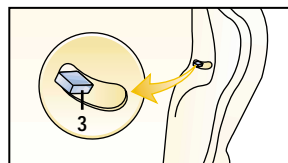
**Childproof locks**

Located at the edge of rear doors

To activate: Push tab (3) right; door opens from outside only

To cancel: Push tab (3) left

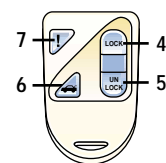
**Remote keyless entry system**

Functions only with ignition in OFF position

To lock doors: Press LOCK button (4); pressing again within 5 seconds causes doors to relock and horn to beep

To unlock: Press UNLOCK (5) for driver's door; press again within 5 seconds to unlock other doors

To open trunk: Press  (6)

Panic alarm: Press ! (7); horn sounds, headlights/taillights flash; to stop, press (7) again or turn ignition to ON position

**Always check the Owner's Manual for more operating information and safety features**

## Locks

Revised January 9, 2001

## Interior Lights

### INTERIOR LIGHTS

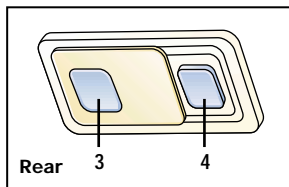
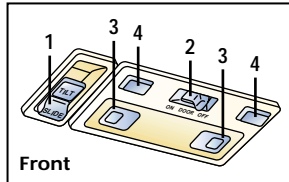

#### 1. Sunroof switch

To open: Pull switch rearward until panel is in desired position

To close: Push switch forward

To tilt (panel closed)/to close: Push/pull TILT

#### 2. Dome light

On = Light always on

Off = Light always off

Door = Light on when a door is open

#### 3. Map/reading lights

On/off: Press switch (4)

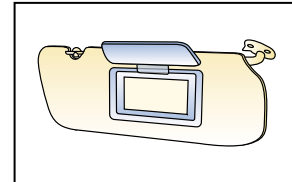

#### Illuminated vanity mirrors

Mirror lighted when cover opened, off when closed

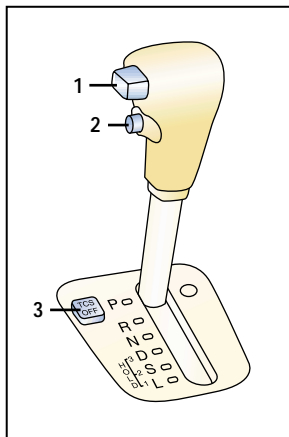

#### Automatic transmission

##### P = Park

To move gearshift from Park: Press firmly on brake pedal, then press release button (1) on gearshift

Never put moving vehicle in Park

Always apply parking brake when exiting the vehicle

##### R = Reverse

Always bring vehicle to a complete stop before engaging or disengaging reverse gear

##### N = Neutral

No gear is engaged; vehicle can roll freely, even on a slight incline, unless brakes are applied

##### D = Drive

For normal driving: Shifts through four forward gears automatically

##### S = Second

Provides extra power and increased engine braking

##### L = Low

Use for engine braking when second gear is not sufficient

##### Hold mode

Keeps transmission in selected gear, prevents automatic transmission from shifting to another gear

Press (2) to activate/deactivate

##### Traction control system\*

Regulates engine torque to optimize traction on slippery road surfaces

Press (3) to activate/deactivate

\*Denotes optional equipment

Always check the Owner's Manual for more operating information and safety features

## Transmission

Revised January 9, 2001

## Seats

## SEATS

**1. Head restraint**

To raise/lower: Press release button (4) and pull up/push down

To move forward/aft: Rotate (driver's seat only)

**Power seats****2. Raise/lower front of seat**

Move front of switch vertically

**Fore/aft adjustment**

Move switch horizontally

**Raise/lower rear of seat**

Move rear of switch vertically

**Raise/lower seat cushion**

Move center of switch vertically

**3. Seatback angle**

Rotate fore/aft for desired angle

**⚠ WARNINGS: Always wear your safety belt and properly secure children 12 and under in the rear seat**

**If you choose to install a forward-facing child restraint seat, move vehicle seat as far back as possible**

**Air bag is supplemental and does not replace safety belt usage**

**Do not adjust seat while driving**

**Lumbar support**

(driver's seat only)  
Located at front of center console

Press top/bottom of switch to increase/decrease firmness

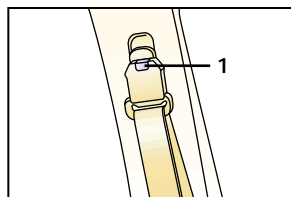
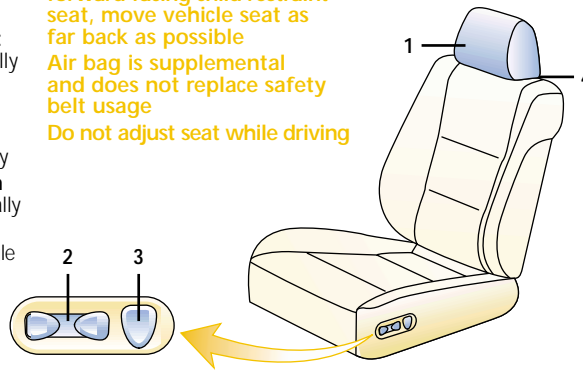
**Shoulder belt height adjustment**

To raise/lower belt, press button (1) and move up/down

**⚠ WARNING: Make sure adjuster locks in position**

**⚠ WARNINGS: Children less than 4 years old and under 40 pounds should always use a safety seat**

**Never place rear-facing child restraint seat in front seat**

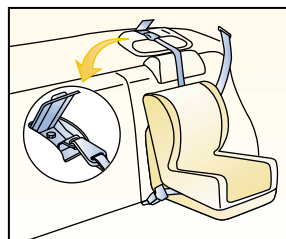
**Child restraint seat**

Some child restraint systems are equipped with tethers that must be installed on one of the three anchors on the rear seats

To install in rear outboard seats: Use dual locking mode retractor safety belt; see Owner's Manual for proper installation and child seat tether instructions

**⚠ WARNING: Read all information and warnings in Owner's Manual and attached to seat before using child safety seat**

**Dual locking mode lap/shoulder belt retractor (front passenger and rear outboard safety belts only)**

Emergency locking mode: Belt locks only on hard braking/cornering or impacts of about 5 mph or more

Automatic locking mode: Must be used when installing child safety seat

To activate: Pull webbing fully out of retractor until click is heard; belt will only tighten

To disengage: Unbuckle belt and allow webbing to retract fully

**Always check the Owner's Manual for more operating information and safety features**

## Seats

Revised January 9, 2001

## Climate Controls

## CLIMATE CONTROLS

**Automatic climate control****1. Auto**

Press to select automatic system operation

**2. Temperature control**

Rotate left/right for colder/warmer

**3. Mode**

Press to select

 = air to dash

 = air to dash and floor

 = air to floor

 = air to floor and windshield

**4. Off**

Press to turn off climate control system

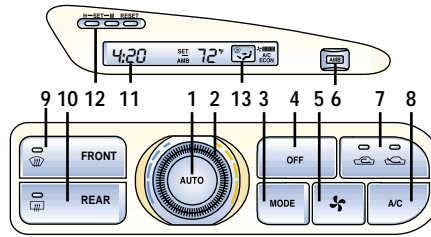

**5. Fan control**

Press to cycle through four speed settings

**6. Ambient temperature**

Press to display outside temperature

**7. Air intake control**

Press / for recirculated/outside air

**8. Air Conditioning**

Press to manually select normal, economical or off

**9. Defrost**

Press to direct air to windshield

**10. Rear window defogger**

Press to turn on/off

**11. Clock****12. Clock controls**

To set: Press (H) hour/ (M) minutes; press RESET to clear minutes

 **Tip: Fan speed, A/C selection and mode selection are indicated in display (13)**

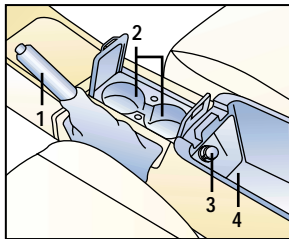
**Center console****1. Parking brake**

To engage: Pull up

To release: Pull up slightly while depressing button at front of lever, lower parking-brake lever

**2. Cup holders****3. Accessory socket**

For accessories only

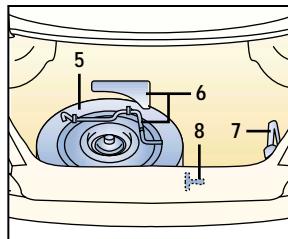
**4. Storage bin****Trunk**

To open: Use key or remote keyless entry fob

**Remote trunk release,** see Driver's View

**Remote trunk release lock-out**

To enable/disable: Press left/right side of switch (located in glovebox)

**5. Temporary spare tire**

To change flat tire: Follow instructions in Owner's Manual

 **WARNING: Do not exceed 50 mph with temporary spare**

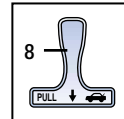
**6. Lugwrench and jack handle****7. Jack****Interior luggage compartment release**

Allows you to escape should you become locked in trunk

To open: Pull "T" handle; "T" handle will glow if it has been exposed to light

*Always check the Owner's Manual for more operating information and safety features*

Console/  
Trunk



Revised January 9, 2001

Audio  
System

## AM/FM STEREO/CASSETTE/CD

**1. Power/Volume**

Press to turn on/off; rotate to increase/decrease volume

**2. Memory preset buttons**

To set: Tune to station, press and hold until beep is heard

**3. SEEK/TRACK/APC**

Radio: Press  $\wedge$  /  $\vee$  to automatically seek higher/lower frequency

CD: Press  $\wedge$  /  $\vee$  to select next/previous track

Tape: Press  $\wedge$  /  $\vee$  to automatically advance tape to beginning of next selection/replay selection; to stop this operation, press button again

**4. Load\***

Single CD loading: Press button, WAIT will appear; when IN appears and CD door opens, load CD

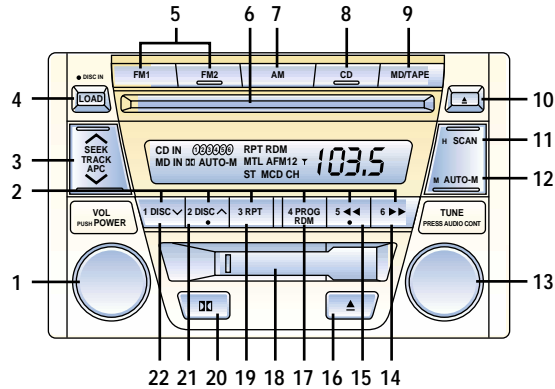

AM/FM/Radio with Cassette and CD/6-disc in-dash  
Compact Disc Changer\*

Multiple CD loading: Press and hold LOAD until beep is heard; when IN is displayed load CD; when IN displays again load next CD

**5. FM1/2**

Press to select between FM1/FM2 station preset buttons (2)

**6. CD Slot****7. AM**

Press to select AM frequency band

**8. CD**

Press to play CD

**9. MD/Tape**

Press to play Mini-disc Player\*/cassette tape

**10. CD eject**

**11. Scan**  
Press to briefly sample next listenable selections; functions in all modes

**12. Auto-Memory**

Radio: Press and hold until beep is heard, system automatically scans and temporarily stores 6 strong stations in each band; press again to cancel

**13. Tuning/Audio Control**

Tune: Rotate counterclockwise/clockwise for lower frequency/higher frequency  
Audio control: Press to select BASS/MID/TREBLE/FADE/BALANCE; rotate right/left to adjust selected feature

**14. Fast forward  $\blacktriangleright\blacktriangleright$** 

Press to fast forward tape

**15. Rewind  $\blacktriangleleft\blacktriangleleft$** 

Press to rewind tape

**16. Eject Cassette Tape****17. Program Random**

Press to enable/cancel random play

**18. Cassette/Mini-disc\* door****19. Repeat**

Press to replay current CD/tape selection

**20.  $\square\square$  Dolby®**

Reduces tape noise/hiss  
Press to activate/deactivate

**21. Disc up  $\wedge$** 

Press to skip forward to beginning of next CD

**22. Disc down  $\vee$** 

Press to skip back to beginning of previous CD

\*Denotes optional equipment

Always check the Owner's Manual for more operating information and safety features

Audio  
System

Revised January 9, 2001

Under  
Hood

## UNDER HOOD

**1. Engine oil dipstick**

Engine oil should be between F and L marks on dipstick

**2. Coolant filler cap**

Remove cap only when safe and engine is cool

**3. Automatic transmission fluid dipstick**

Check with engine on at operating temperature; fluid level should be within v-notches on dipstick

**4. Brake fluid reservoir**

Level should be kept at the MAX mark on reservoir; fill with DOT 3 fluid from a sealed container

**5. Battery**

**6. Fuse block**  
(fuses and relays)

**7. Air filter**

**8. Engine coolant reservoir**  
Level should be between FULL and LOW lines when cold

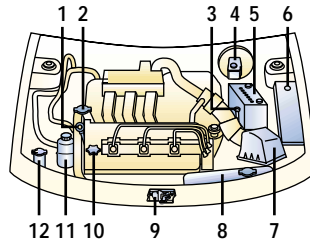

2.5L DOHC V6

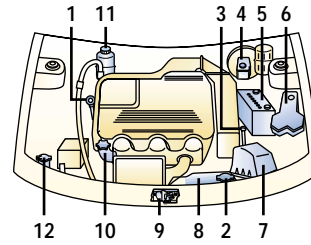

Miller Cycle 2.3L DOHC V6

**WARNING:** Never remove coolant filler or reservoir cap while engine is running or hot; remove only when safe

**9. Hood latch**

Pull hood latch up to open

**10. Engine oil filler cap,**  
see Owner's Manual for recommended viscosity

**11. Power steering fluid reservoir**

Level should be between MIN and MAX

**12. Windshield washer reservoir**

Fill with windshield washer fluid

**Break-in period**

First 600 miles: Avoid heavy braking and acceleration; drive at varying road and engine speeds

**Tip:** Follow same procedures with overhauled engine or when brakes are replaced

**Anti-lock Braking System (ABS)**

When brake pedal is pressed, ABS automatically reduces hydraulic pressure to any wheel on the verge of locking up

You may feel a slight pulsing of the brake pedal and hear a clicking noise; this tells you the ABS is functioning properly; increase pressure on pedal for maximum braking

**Tips:** Maintain constant pressure on the brake pedal  
Do not pump the brakes

**Traction Control System\***

Automatically applies and releases brakes to prevent excessive wheel spin at all speeds, especially when accelerating on slippery surfaces

**Tire economy and tips**

Check pressure at least monthly when tires are cold

Maintain correct front-end alignment and tire balance; rotate tires at 3,750-mile intervals; see Owner's Manual for rotation chart

**Tire pressure**

Decal on the edge of the driver's door provides tire pressure information

**Tire chains\***

Install only on front tires; install as tightly as possible and retighten periodically

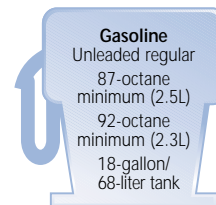

\*Denotes optional equipment

**Always check the Owner's Manual for more operating information and safety features**

## Free Manuals Download Website

<http://myh66.com>

<http://usermanuals.us>

<http://www.somanuals.com>

<http://www.4manuals.cc>

<http://www.manual-lib.com>

<http://www.404manual.com>

<http://www.luxmanual.com>

<http://aubethermostatmanual.com>

Golf course search by state

<http://golfingnear.com>

Email search by domain

<http://emailbydomain.com>

Auto manuals search

<http://auto.somanuals.com>

TV manuals search

<http://tv.somanuals.com>