

Table of Contents

Introduction	4
---------------------	----------

Instrument Cluster	12
---------------------------	-----------

Warning lights and chimes	12
Gauges	17

Entertainment Systems	19
------------------------------	-----------

AM/FM stereo	19
AM/FM stereo with single CD	21
AM/FM stereo with CDX6/MP3	26
Auxiliary input jack (Line in)	32
Satellite radio information	35

Climate Controls	39
-------------------------	-----------

Heater only	39
Manual heating and air conditioning	40

Lights	42
---------------	-----------

Headlamps	42
Turn signal control	46
Bulb replacement	46

Driver Controls	53
------------------------	-----------

Windshield wiper/washer control	53
Steering wheel adjustment	54
Power windows	55
Mirrors	56
Speed control	57

Locks and Security	62
---------------------------	-----------

Keys	62
Locks	62
Anti-theft system	66

Table of Contents

Seating and Safety Restraints 69

Seating	69
Safety restraints	71
Airbags	86
Child restraints	94

Tires, Wheels and Loading 106

Tire information	109
Tire inflation	110
Tire Pressure Monitoring System (TPMS)	124
Vehicle loading	129
Trailer towing	135
Recreational towing	144

Driving 146

Starting	146
Brakes	151
Transmission operation	156

Roadside Emergencies 168

Hazard flasher switch	168
Fuel pump shut-off switch	168
Fuses and relays	169
Changing tires	179
Lug nut torque	187
Overheating	188
Jump starting	189
Wrecker towing	195

Customer Assistance 196

Reporting safety defects (U.S. only)	206
Reporting safety defects (Canada only)	206

Cleaning 207

Table of Contents

Maintenance and Specifications 213

Engine compartment	223
Engine oil	227
Battery	233
Engine coolant	235
Fuel information	241
Air filter(s)	258
Maintenance product specifications and capacities	260
Engine data	264

Accessories 268

Index 269

All rights reserved. Reproduction by any means, electronic or mechanical including photocopying, recording or by any information storage and retrieval system or translation in whole or part is not permitted without written authorization from MNAO. MNAO may change the contents without notice and without incurring obligation.

Copyright © 2007 MNAO

Introduction

CALIFORNIA Proposition 65 Warning

WARNING: Engine exhaust, some of its constituents, and certain vehicle components contain or emit chemicals known to the State of California to cause cancer and birth defects or other reproductive harm. In addition, certain fluids contained in vehicles and certain products of component wear contain or emit chemicals known to the State of California to cause cancer and birth defects or other reproductive harm.

PERCHLORATE MATERIAL

Certain components of this vehicle such as airbag modules, seat belt pretensioners, and button cell batteries may contain Perchlorate Material – Special handling may apply for service or vehicle end of life disposal. See www.dtsc.ca.gov/hazardouswaste/perchlorate.

CONGRATULATIONS

Congratulations on acquiring your new Mazda product. Please take the time to get well acquainted with your vehicle by reading this handbook. The more you know and understand about your vehicle, the greater the safety and pleasure you will derive from driving it.

For more information on Mazda and its products visit the following website:

- In the United States: www.mazdausa.com
- In Canada: www.mazda.ca

Additional owner information is given in separate publications or refer to the *Mazda importers/distributors* section in the *Customer Assistance* chapter.

This Owner's Manual describes every option and model variant available and therefore some of the items covered may not apply to your particular vehicle. Furthermore, due to printing cycles it may describe options before they are generally available.

Remember to pass on the Owner's Manual when reselling the vehicle. It is an integral part of the vehicle.

WARNING: In the event of an accident the Fuel pump shut-off switch will automatically cut off the fuel supply to the engine. The switch can also be activated through sudden vibration (e.g. collision when parking). To reset the switch, refer to the *Fuel pump shut-off switch* in the *Roadside Emergencies* chapter.

SAFETY AND ENVIRONMENT PROTECTION

Warning symbols in this guide

How can you reduce the risk of personal injury to yourself or others? In this guide, answers to such questions are contained in comments highlighted by a bold

WARNING statement. These comments should be read and observed.



Warning symbols on your vehicle

When you see this symbol, it is imperative that you consult the relevant section of this guide before touching or attempting adjustment of any kind.



Protecting the environment

We must all play our part in protecting the environment. Correct vehicle usage and the authorized disposal of waste, cleaning and lubrication materials are significant steps towards this aim. Information in this respect is highlighted in this guide with the tree symbol.



Always dispose of used automotive fluids in a responsible manner. Follow your community's regulations and standards for recycling and disposing of automotive fluids.

BREAKING-IN YOUR VEHICLE

There are no particular breaking-in rules for your vehicle. During the first 1,000 miles (1,600 km) of driving, vary speeds frequently. This is necessary to give the moving parts a chance to break in.

SPECIAL NOTICES

Emission warranty

The New Vehicle Limited Warranty includes Bumper to Bumper Coverage, Safety Restraint Coverage and Corrosion Coverage. In addition, your vehicle is eligible for Emissions Defect and Emissions Performance Warranties. For a detailed description of what is covered and what is not covered, refer to the *Warranty Information Booklet* that is provided to you along with your *Owner's Manual*.

Event Data Recorder

The computer in your vehicle is capable of recording detailed data potentially including but not limited to information such as:

- the use of restraint systems including seat belts by the driver and passengers,
- information about the performance of various systems and modules in the vehicle, and
- information related to engine, throttle, steering, brake or other system status potentially including information related to how the driver operates the vehicle including but not limited to vehicle speed.

This information may be stored during regular operation or in a crash or near crash event. This stored information may be read out and used by:

- service and repair facilities.
- law enforcement or government agencies.
- the Manufacturer and Distributor.

Special instructions

For your added safety, your vehicle is fitted with sophisticated electronic controls.

WARNING: Please read the section *Airbag supplemental restraint system (SRS)* in the *Seating and Safety Restraints* chapter. Failure to follow the specific warnings and instructions could result in personal injury.

WARNING: Front seat mounted rear-facing child or infant seats should NEVER be placed in front of an active passenger airbag.

Notice to owners of pickup trucks and utility type vehicles

WARNING: Utility vehicles have a significantly higher rollover rate than other types of vehicles.

Before you drive your vehicle, please read this *Owner's Manual* carefully. Your vehicle is not a passenger car. As with other vehicles of this type, failure to operate this vehicle correctly may result in loss of vehicle control, vehicle rollover, personal injury or death.

Using your vehicle with a snowplow

WARNING: Do not use this vehicle for snowplowing.

Your vehicle is not equipped with a snowplowing package.

Using your vehicle as an ambulance

WARNING: Do not use this vehicle as an ambulance.

Your vehicle is not equipped with an ambulance preparation package.





















Introduction

These are some of the symbols you may see on your vehicle.

Vehicle Symbol Glossary

Safety Alert		See Owner's Manual	
Protecting the Environment		Fasten Seat Belt	
Airbag - Front		Airbag - Side	
Child Seat Lower Anchor		Child Seat Tether Anchor	
Brake System		Anti-Lock Brake System	
Parking Brake System		Brake Fluid - Non-Petroleum Based	
Parking Aid System		Stability Control System	
Master Lighting Switch		Hazard Warning Flasher	
Fog Lamps-Front		Fuse Compartment	
Fuel Pump Reset		Windshield Wash/Wipe	
Windshield Defrost/Demist		Rear Window Defrost/Demist	

Vehicle Symbol Glossary

Power Windows		Power Window Lockout	
Personal Alarm System Feature		Engine Oil	
Engine Coolant		Engine Coolant Temperature	
Do Not Open When Hot		Battery	
Avoid Smoking, Flames, or Sparks		Battery Acid	
Explosive Gas		Fan Warning	
Power Steering Fluid		Maintain Correct Fluid Level	
Service Engine Soon		Engine Air Filter	
Passenger Compartment Air Filter		Jack	
Check fuel cap		Speed Control	
Low Tire Pressure Warning			

INFORMATION ABOUT THIS GUIDE

The information found in this guide was accurate at the time of printing. Mazda may change the contents without notice.

Instrument Cluster

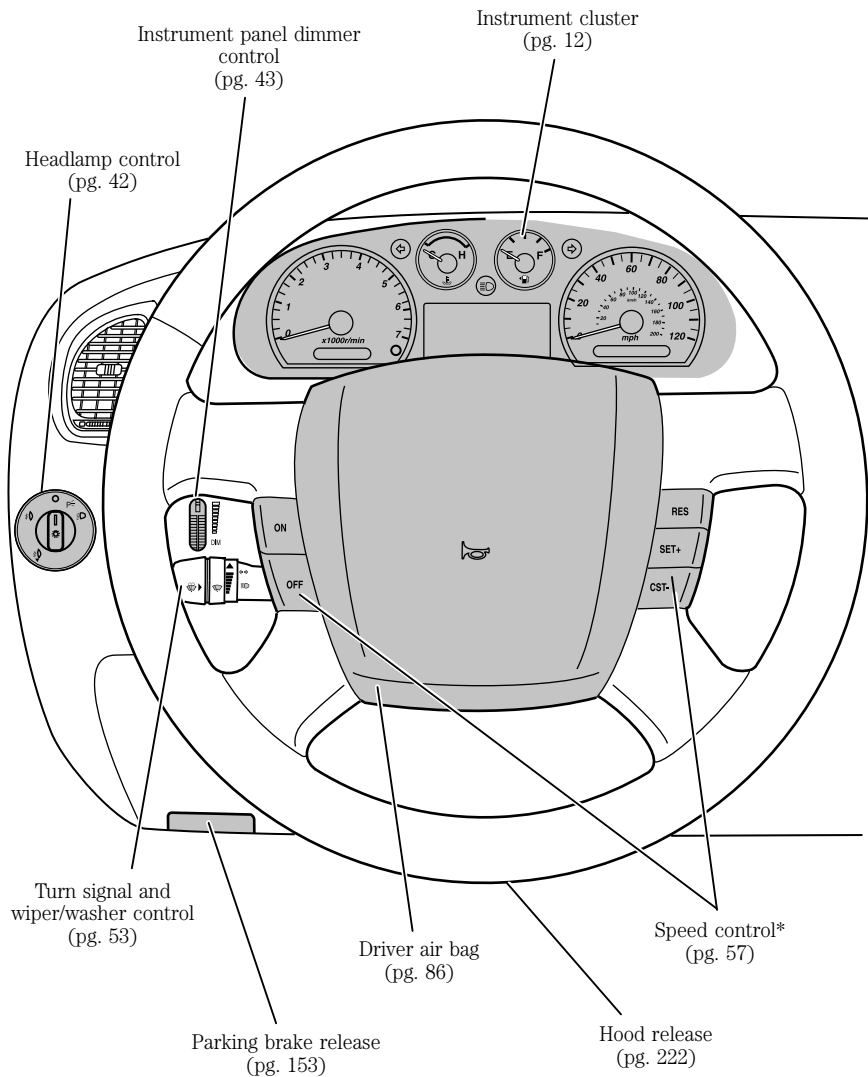

* If equipped

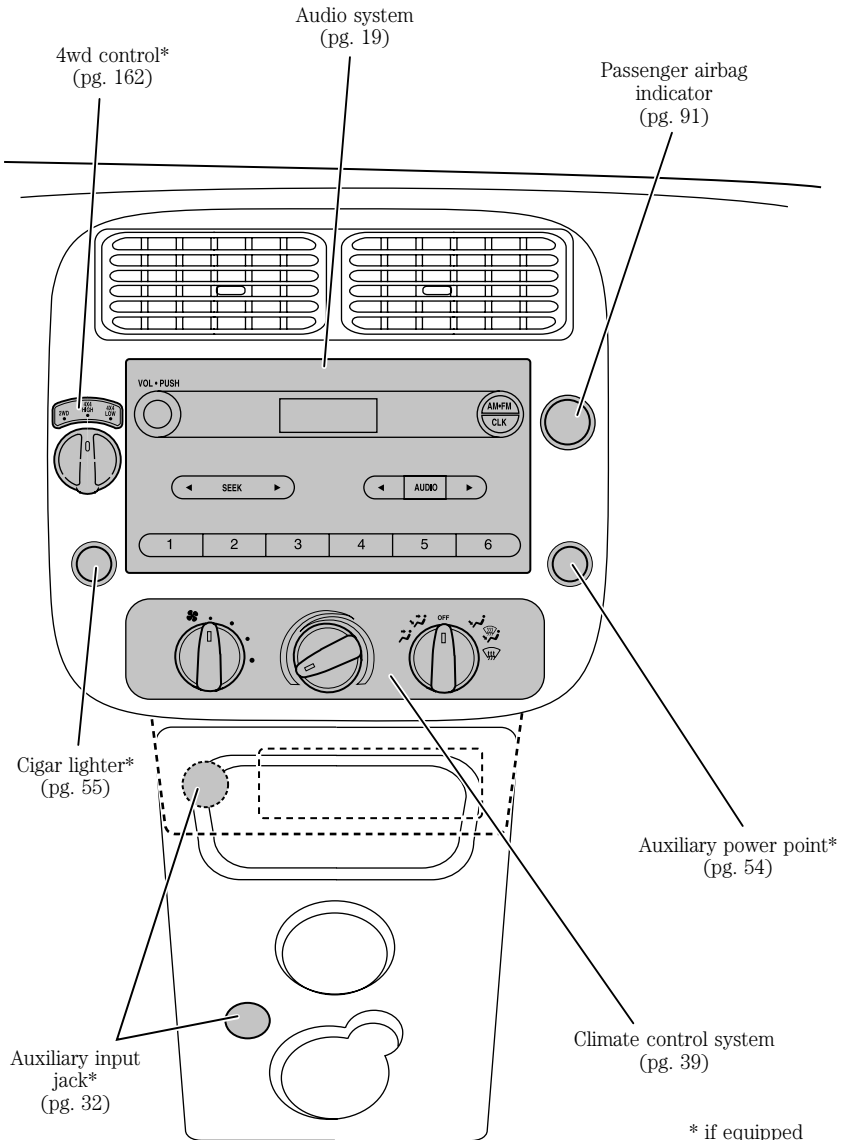

Instrument Cluster

WARNING LIGHTS AND CHIMES

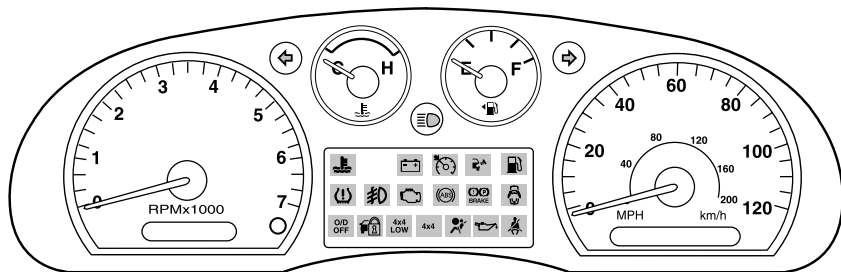

Warning lights and gauges can alert you to a vehicle condition that may become serious enough to cause expensive repairs. A warning light may illuminate when a problem exists with one of your vehicle's functions. Many lights will illuminate when you start your vehicle to make sure the bulb works. If any light remains on after starting the vehicle, refer to the respective system warning light for additional information.

Service engine soon: The *Service engine soon* indicator light

illuminates when the ignition is first turned to the ON position to check

the bulb and to indicate whether the vehicle is ready for Inspection/Maintenance (I/M) testing. Normally, the "Service engine soon" light will stay on until the engine is cranked, then turn itself off if no malfunctions are present. However, if after 15 seconds the "Service engine soon" light blinks eight times, it means that the vehicle is not ready for I/M testing. See the *Readiness for Inspection/Maintenance (I/M) testing* in the *Maintenance and Specifications* chapter.

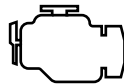

Solid illumination after the engine is started indicates the On Board Diagnostics System (OBD-II) has detected a malfunction. Refer to *On board diagnostics (OBD-II)* in the *Maintenance and Specifications* chapter. If the light is blinking, engine misfire is occurring which could damage your catalytic converter. Drive in a moderate fashion (avoid heavy acceleration and deceleration) and have your vehicle serviced immediately by your authorized dealer.

WARNING: Under engine misfire conditions, excessive exhaust temperatures could damage the catalytic converter, the fuel system, interior floor coverings or other vehicle components, possibly causing a fire.

Check fuel cap: Illuminates when the fuel cap may not be properly installed. Check the fuel filler cap if this light remains on. Continued driving with this light on may cause the Service engine soon warning light to come on.



It may take a long period of time for the system to detect an improperly installed or properly re-installed fuel filler cap depending on driving and fuel tank level conditions. Refer to *Fuel filler cap* in the *Maintenance and Specifications* chapter.

Brake system warning light: To confirm the brake system warning light is functional, it will momentarily illuminate when the ignition is turned to the ON position



when the engine is not running, or in a position between ON and START, or by applying the parking brake when the ignition is turned to the ON position. If the brake system warning light does not illuminate at this time, seek service immediately from your authorized dealer. Illumination after releasing the parking brake indicates low brake fluid level or a failure to brake proportioning and the brake system should be inspected immediately by your authorized dealer.

WARNING: Driving a vehicle with the brake system warning light on is dangerous. A significant decrease in braking performance may occur. It will take you longer to stop the vehicle. Have the vehicle checked by your authorized dealer. Driving extended distances with the parking brake engaged can cause brake failure and the risk of personal injury.

Instrument Cluster

Anti-lock brake system: If the ABS light stays illuminated or continues to flash, a malfunction has been detected; have the system serviced immediately by your authorized dealer. Normal braking is still functional unless the brake warning light also is illuminated.



Airbag readiness: If this light fails to illuminate when the ignition is turned to ON, continues to flash or remains on, have the system serviced immediately by your authorized dealer. A chime will also sound when a malfunction in the supplemental restraint system has been detected.



Seat belt: Reminds you to fasten your seat belt. A Belt-Minder® chime will also sound to remind you to fasten your seat belt. Refer to the *Seating and safety restraints* chapter to activate/deactivate the Belt-Minder® chime feature.



Low tire pressure warning: Illuminates when your tire pressure is low. If the light remains on at start up or while driving, the tire pressure should be checked. Refer to *Inflating Your Tires* in the *Tires, Wheels and Loading* chapter. When the ignition is first turned to ON, the light will illuminate for 3 seconds to ensure the bulb is working. If the light does not turn ON, have the system inspected by your authorized dealer. For more information on this system, refer to *Understanding Your Tire Pressure Monitoring System* in the *Tires, Wheels and Loading* chapter.

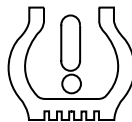

Charging system: Illuminates when the battery is not charging properly.



Engine oil pressure: Illuminates when the oil pressure falls below the normal range. Refer to *Engine oil* in the *Maintenance and Specifications* chapter.

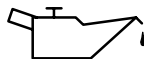

Engine coolant temperature:

Illuminates when the engine coolant temperature is high. Stop the vehicle as soon as possible, switch off the engine and let cool. Refer to *Engine coolant* in the *Maintenance and Specifications* chapter.



WARNING: Never remove the coolant reservoir cap while the engine is running or hot.

Foglamps: Illuminates when the foglamps are turned on. Refer to *Foglamp control* in the *Lights* chapter.



Low fuel: Illuminates when the fuel level in the fuel tank is at or near empty. Refer to *Fuel gauge* in this chapter.



Door ajar: Illuminates when the ignition is in the ON position and any door is open.



Overdrive off (if equipped):

Illuminates when the overdrive function of the transmission has been turned off. Refer to the *Driving* chapter. **If the light flashes steadily or does not come on, have your vehicle serviced as soon as possible, damage to the transmission could occur.**



Four wheel drive low (if equipped): Illuminates when four-wheel drive low is engaged.



NOTE: If the light continues to flash have the system serviced.

Four wheel drive high (if equipped): Illuminates when four-wheel drive high is engaged. It may also illuminate when the 4WD LOW is engaged. Refer to the *Driving* chapter for more information.



Instrument Cluster

NOTE: If the light continues to flash have the system serviced.

Anti-theft system: Flashes when the SecuriLock™ Passive Anti-theft System has been activated.



Speed control (if equipped):

Illuminates when the speed control is engaged. Turns off when the speed control system is disengaged.



Turn signal: Illuminates when the left or right turn signal or the hazard lights are turned on. If the indicators stay on or flash faster, check for a burned out bulb.

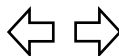

High beams: Illuminates when the high beam headlamps are turned on.



Key-in-ignition warning chime: Sounds when the key is left in the ignition in the OFF/LOCK or ACCESSORY position and the driver's door is opened.

Headlamps on warning chime: Sounds when the headlamps or parking lamps are on, the ignition is off (the key is not in the ignition) and the driver's door is opened.

Door ajar warning chime: Sounds when any door is opened (or not fully closed).

Parking brake ON warning chime: Sounds when the parking brake is set, the engine is running and the vehicle is driven more than 3 mph (5 km/h).

GAUGES

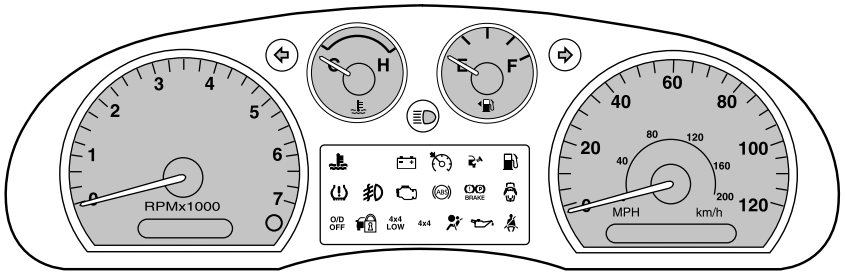

Speedometer: Indicates the current vehicle speed.

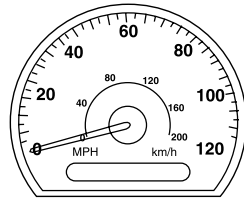

Engine coolant temperature gauge: Indicates engine coolant temperature. At normal operating temperature, the needle will be in the normal range (between “H” and “C”). **If it enters the red section, the engine is overheating. Stop the vehicle as soon as safely possible, switch off the engine and let the engine cool.**

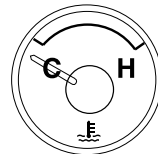

Refer to *Engine coolant* in the *Maintenance and specifications* chapter.

WARNING: Never remove the coolant reservoir cap and/or the radiator cap while the engine is running or hot, this may result in serious burns.

Odometer: Registers the total miles (kilometers) of the vehicle.

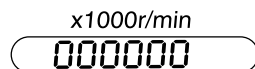

Instrument Cluster

Trip odometer: Registers the miles (kilometers) of individual journeys. Press the button once until “TRIP” appears in the display (this represents the trip mode). To reset the trip, press and hold the control again for approximately 2 seconds, until the trip reading is 0.0 miles (kilometers). To toggle between trip and odometer, press and release the control.

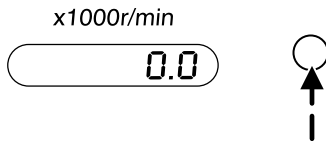

Tachometer: Indicates the engine speed in revolutions per minute. Driving with your tachometer pointer continuously at the top of the scale may damage the engine.

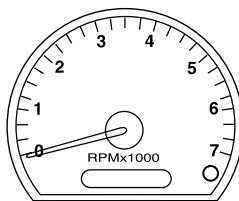

Fuel gauge: Indicates approximately how much fuel is left in the fuel tank (when the ignition is in the ON position). The fuel gauge may vary slightly when the vehicle is in motion or on a grade.

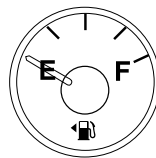

Proper gauge indication requires the ignition to be in the OFF or ACCESSORY position during refueling, otherwise correct fuel indication after refueling can be slow to update. Also, a minimum of 3 gallons (11 liters) is needed for correct indication after refueling.

NOTE: The FUEL icon and arrow indicates which side of the vehicle the fuel filler door is located.

Refer to *Filling the tank* in the *Maintenance and Specifications* chapter for more information.

AUDIO SYSTEMS

AM/FM stereo (if equipped)

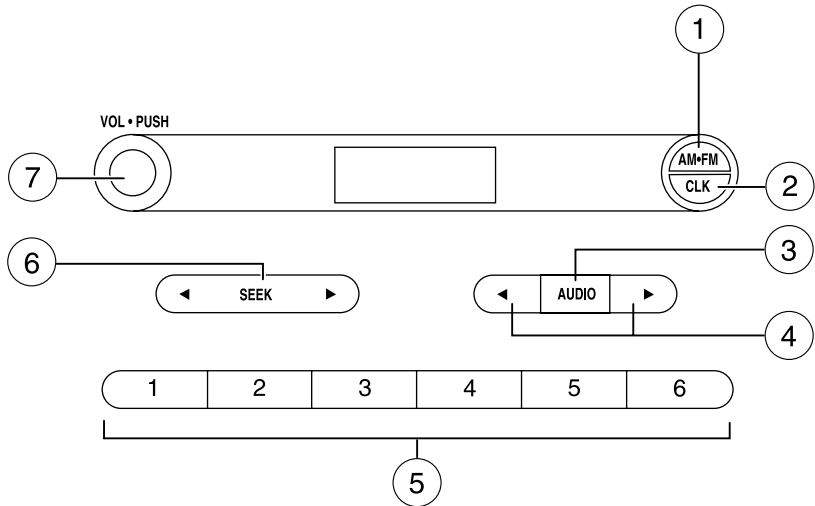

WARNING: Driving while distracted can result in loss of vehicle control, accident and injury. Mazda strongly recommends that drivers use extreme caution when using any device that may take their focus off the road. The drivers primary responsibility is the safe operation of their vehicle. Only use cell phones and other devices not essential to the driving task when it is safe to do so.

Display preference: You can select Clock mode, which displays the time, or Frequency mode, which displays the current radio frequency, to appear in the radio display. Press CLK repeatedly to toggle between Clock and Frequency modes. If clock mode is selected and a radio function is pressed (i.e. SEEK, TUNE, Memory Presets), the radio information will display momentarily and then again display the time.

1. **AM/FM:** Press to select AM/FM1/FM2 frequency bands.



Entertainment Systems

2. **CLK** —To set the time:

Ensure that your audio system is turned off. Press and hold CLK until the hours flash in the display. Press ◀ AUDIO ▶ to adjust the hours. Press and hold CLK again until the minutes flash. Press ◀ AUDIO ▶ to adjust the minutes.



To set the display mode: Press repeatedly to toggle between Clock mode and frequency mode.

3. **AUDIO:** Press AUDIO repeatedly to toggle through the following modes and use ◀ / ▶ to make adjustments in those modes.



Bass: Press ◀ AUDIO ▶ to decrease/increase the bass setting.

Treble: Press ◀ AUDIO ▶ to decrease/increase the treble setting.

Balance: Press ◀ AUDIO ▶ to adjust the audio between the left and right speakers.

Hours: Press ◀ AUDIO ▶ to decrease/increase the hours.

Minute: Press ◀ AUDIO ▶ to decrease/increase the minutes.

4. **Tune:** Press to manually go down/up (◀ / ▶) the radio frequency and in audio mode to select various settings.

5. **Memory presets:** To set a station: Select frequency band AM/FM; tune to a station, press and hold a preset button until sound returns. To tune a preset station, press the desired memory preset.



6. **SEEK:** Press ◀ SEEK ▶ to access the previous or next radio station.

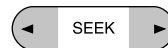

7. **ON/OFF/Volume:** Press to turn the system ON/OFF. Turn to adjust the volume levels. If the volume is set above a certain level, and the ignition is turned off, the volume will come back to a “nominal” listening level when the ignition is turned back on.

VOL - PUSH



AM/FM stereo single CD/MP3 Satellite Compatible system (if equipped)

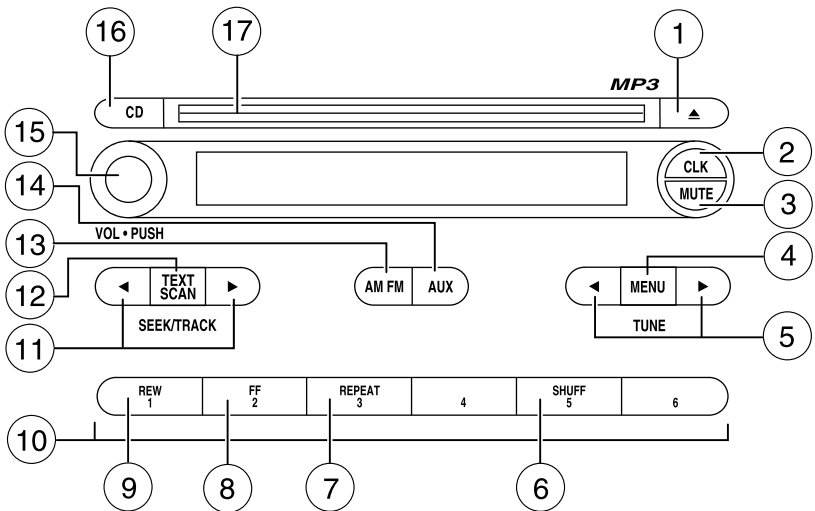

1. **CD eject:** Press to eject the CD/MP3.



2. **CLK (Clock):** Press CLK until SELECT HOUR or SELECT MINS is displayed. Press ◀ MENU ▶ to adjust the hours/minutes. Press CLK to display the time when the ignition is off.



Entertainment Systems

3. **MUTE:** Press to mute the playing media. Press again to return to the playing media.



4. **MENU:** Press MENU repeatedly to scroll through the following modes and use ◀/▶ to make an adjustment in those modes.



SATELLITE RADIO MENU (if equipped): Press MENU when satellite radio mode is active to access. Press SEEK ▶ to enter into the satellite radio menu. Press ◀/▶ to cycle through the following options:

- **CATEGORY:** Press SEEK ▶ to enter category mode. Press ◀ MENU ▶ to scroll through the list of available SIRIUS channel Categories (Pop, Rock, News, etc.) Press SEEK ▶ when the desired category appears in the display. After a category is selected, press SEEK to search for that specific category of channels only (i.e. ROCK). You may also select CATEGORY ALL to seek all available SIRIUS categories and channels. Press SEEK ▶ to close and return to the main menu.
- **SAVE SONG:** Press SEEK ▶ to save the currently playing song in the system's memory. (If you try to save something other than a song, CANT SAVE will appear in the display.) When the chosen song is playing on any satellite radio channel, the system will alert you with an audible prompt. Press SEEK ▶ while SONG ALERT is in the display and the system will take you to the channel playing the desired song. You can save up to 20 songs. If you attempt to save a song when the system is full, the display will read REPLACE SONG? Press SEEK ▶ to access the saved songs and press ◀ MENU ▶ to cycle through the saved songs. When the song appears in the display that you would like to replace, press SEEK ▶ . SONG REPLACED will appear in the display.
- **DELETE SONG:** Press SEEK ▶ to delete a song from the system's memory. Press ◀ MENU ▶ to cycle through the saved songs. When the song appears in the display that you would like to delete, press SEEK ▶ . The song will appear in the display for confirmation. Press SEEK ▶ again and the display will read SONG DELETED. If you do not want to delete the currently listed song, press ◀ MENU ▶ to

select either RETURN or CANCEL.

Note: If there are no songs presently saved, the display will read NO SONGS.

- **DELETE ALL SONGS:** Press SEEK ► to delete all song's from the system's memory. The display will read ARE YOU SURE ? Press SEEK ► to confirm deletion of all saved songs and the display will read ALL DELETED.

Note: If there are no songs presently saved, the display will read NO SONGS.

- **ENABLE ALERTS / DISABLE ALERTS:** Press SEEK ► to enable/disable the satellite alert status which alerts you when your selected songs are playing on a satellite radio channel. (The system default is disabled.) SONG ALERTS ENABLED/DISABLED will appear in the display. The menu listing will display the opposite state. For example, if you have chosen to enable the song alerts, the menu listing will read DISABLE as the alerts are currently on, so your other option is to turn them off.

Satellite radio is available only with a valid SIRIUS radio subscription. Check with your authorized dealer for availability.

AUTOSET: Press ◀ MENU ► to set the strongest local radio stations for AM/FM1/FM2 without losing your original manually set preset stations.

When the six strongest stations are filled, the station stored in preset 1 will begin playing. If there are less than six strong stations, the system will store the last one in the remaining presets.

BASS: Press ◀ MENU ► to decrease/increase the bass setting.

TREBLE: Press ◀ MENU ► to decrease/increase the treble setting.

BALANCE: Press ◀ MENU ► to adjust the audio between the left and right speakers.







FADE: Press ◀ MENU ► to adjust the audio between the front and rear speakers.

Next/previous directory: In MP3 mode, press ◀ MENU ► to go to the previous/next directory.

Flat file/directory mode: In MP3 mode, use ◀ MENU ► to select flat file mode or directory mode.

Normal / Track title/ File name: Use ◀ / ► to scroll through MP3 display options (track #, normal music name or file name).

Entertainment Systems

5. **TUNE:** Press to manually go down/up (◀/▶) the radio frequency and also to select various settings in menu mode.
- 
6. **SHUFF (Shuffle):** Press to play the current CD/MP3 tracks in random order. In MP3 directory mode, press to play the tracks within the current directory in random order.
- 
7. **REPEAT:** Press to repeat the current CD/MP3 track. The selection will repeat continuously until deactivated. Press REPEAT again to deactivate.
- 
8. **FF (Fast forward):** Press to manually advance in a CD/MP3 track.
- 
9. **REW (Rewind):** Press to manually reverse in a CD/MP3 track.
- 
10. **Memory presets:** To set a station: Select frequency band AM/FM; tune to a station, press and hold a preset button until sound returns. To recall a previously set station, press the desired memory preset button briefly. You can save up to 18 stations, six in AM, six in FM1 and FM2.
- 

In satellite radio mode (if equipped), there are 18 available presets, six each for SAT1, SAT2 and SAT3. To save satellite channels in your memory presets, tune to the desired channel then press and hold a preset control until sound returns.

Satellite radio is available only with a valid SIRIUS subscription. Check with your authorized dealer for availability.

11. **SEEK/TRACK:** Press to access the previous/next (◀/▶) strong station. In CD/MP3 mode, press to advance to the previous/next (◀/▶) track.



In satellite radio mode (if equipped), press ◀ SEEK ▶ to seek to the previous/next channel.

In **CATEGORY MODE**, press ◀ SEEK ▶ to select a channel within that category. Press ◀ SEEK ▶ to seek to the previous/next channel in the selected category. Press and hold ◀ SEEK ▶ to fast seek through the previous /next channels.

In **TEXT MODE**, press ◀ SEEK ▶ to view the previous/additional display text.

Satellite radio is available only with a valid SIRIUS subscription. Check with your authorized dealer for availability.

12. **TEXT/SCAN:In radio and CD mode**, press for a brief sampling of radio stations or CD tracks. Press again to stop.



In **MP3 mode**, Press and release to view the next 12 characters in the MP3 music name/file name of the current MP3 track and directory. Press and hold to hear a brief sampling of MP3 tracks. In MP3 directory mode, press and hold to hear a brief sampling of all tracks in the current directory. Press and hold again to stop.

In **satellite radio mode (if equipped)**, press and release to view the Satellite text message. Press and hold to hear a brief sampling of the next channels. Press and hold again to stop.

Satellite radio is available only with a valid SIRIUS subscription. Check with your authorized dealer for availability.

13. **AM/FM**: Press to select AM/FM1/FM2 frequency band.



14. **AUX**: Press to access AUX modes.



If equipped with Satellite Radio, press AUX to cycle through SAT1, SAT2 SAT3 (Satellite Radio mode, if available) and LINE IN (Auxiliary audio mode, if equipped).

Satellite radio is available only with a valid SIRIUS subscription. Check with your authorized dealer for availability.

Entertainment Systems

15. **ON/OFF/Volume:** Press to turn ON/OFF. Turn to increase/decrease volume. If the volume is set above a certain level and the ignition is turned off, the volume will come back on at a “nominal” listening level when the ignition switch is turned back on.



VOL - PUSH
16. **CD:** Press to enter CD/MP3 mode. If a CD/MP3 is already present in the system, the disc will begin to play.



17. **CD slot:** Insert a CD/MP3 label side up.

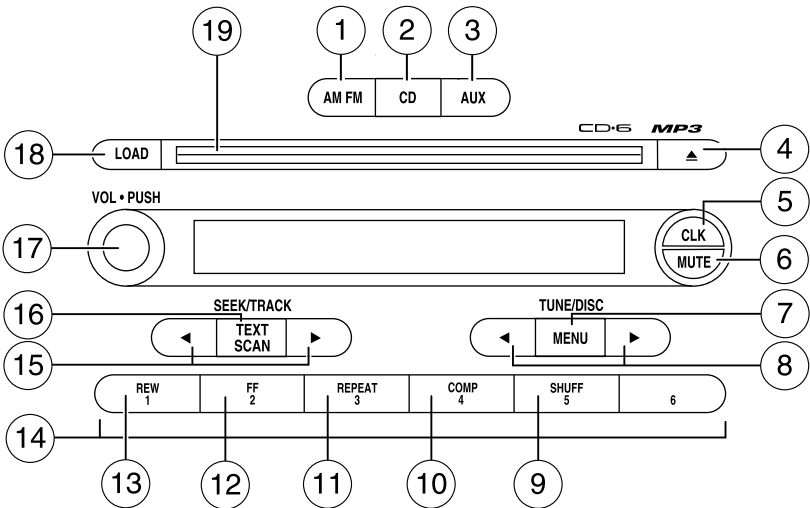

Premium and Audiophile In-dash CD6/MP3 disc Satellite Compatible audio systems (if equipped)

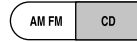
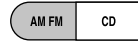

1. **AM/FM:** Press to select AM/FM1/FM2 frequency bands.
2. **CD:** Press to enter CD/MP3 mode. If a CD/MP3 is already in the system, the disc will start playing.
3. **AUX:** Press to access AUX modes. To return to radio mode, press AM/FM.



If equipped with Satellite

Radio, press AUX to cycle through SAT1, SAT2 SAT3 (Satellite Radio mode, if available) and LINE IN (Auxiliary audio mode, if equipped).

Satellite radio is available only with a valid SIRIUS subscription. Check with your authorized dealer for availability.

4. **EJ** (CD eject): To eject an individual CD/MP3, press the eject control and select the correct slot number by pressing the corresponding memory preset. Press and hold to eject all loaded CDs.
5. **CLK (Clock):** Press CLK until SELECT HOUR or SELECT MINS is displayed. Press ◀ MENU ▶ to adjust the hours/minutes. Press CLK to display the time when the ignition is off.
6. **MUTE:** Press to mute the playing media. Press again to return to the playing media.
7. **MENU:** Press MENU repeatedly to toggle through the following modes and use ◀ / ▶ to make adjustment in those modes.



SATELLITE RADIO MENU (if

equipped): Press MENU when satellite radio mode is active to access. Press SEEK ► to enter

into the satellite radio menu. Press ◀ / ► to cycle through the following options:

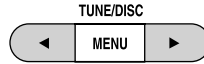

- **CATEGORY:** Press SEEK ► to enter category mode. Press ◀ MENU ► to scroll through the list of available SIRIUS channel Categories (Pop, Rock, News, etc.) Press SEEK ► when the desired category appears in the display. After a category is selected, press SEEK to search for that specific category of channels only (i.e. ROCK). You may also select CATEGORY ALL to seek all available SIRIUS categories and channels. Press SEEK ► to close and return to the main menu.
- **SAVE SONG:** Press SEEK ► to save the currently playing song in the system's memory. (If you try to save something other than a song, CANT SAVE will appear in the display.) When the chosen song is playing on any satellite radio channel, the system will alert you with an audible prompt. Press SEEK ► while SONG ALERT is in the display and the system will take you to the channel playing the desired song. You can save up to 20 songs. If you attempt to save a song when the system is full, the display will read REPLACE SONG? Press SEEK ► to access the saved songs and press ◀ MENU ► to cycle through the saved songs. When the song appears in the display that you would like to replace, press SEEK ► . SONG REPLACED will appear in the display.
- **DELETE SONG:** Press SEEK ► to delete a song from the system's memory. Press ◀ MENU ► to cycle through the saved songs. When the song appears in the display that you would like to delete, press SEEK ► . The song will appear in the display for confirmation. Press SEEK ► again and the display will read SONG DELETED. If you do not want to delete the currently listed song, press ◀ MENU ► to select either RETURN or CANCEL.

Note: If there are no songs presently saved, the display will read NO SONGS.

- **DELETE ALL SONGS:** Press SEEK ► to delete all song's from the system's memory. The display will read ARE YOU SURE ? Press SEEK ► to confirm deletion of all saved songs and the display will read ALL DELETED.
Note: If there are no songs presently saved, the display will read NO SONGS.
- **ENABLE ALERTS / DISABLE ALERTS:** Press SEEK ► to enable/disable the satellite alert status which alerts you when your selected songs are playing on a satellite radio channel. (The system default is disabled.) SONG ALERTS ENABLED/DISABLED will appear in the display. The menu listing will display the opposite state. For example, if you have chosen to enable the song alerts, the menu listing will read DISABLE as the alerts are currently on, so your other option is to turn them off.

Satellite radio is available only with a valid SIRIUS radio subscription. Check with your authorized dealer for availability.

AUTOSET: Allows you to set the strongest local radio stations without losing your original manually set preset stations for AM/FM1/FM2 . Press MENU to access. Use ◀ MENU ▶ to set.

When the six strongest stations are filled, the station stored in preset 1 will begin playing. If there are less than six strong stations, the system will store the last one in the remaining presets.

BASS: Press ◀ MENU ▶ to decrease/increase the bass setting.

TREBLE: Press ◀ MENU ▶ to decrease/increase the treble setting.

BALANCE: Press ◀ MENU ▶ to adjust the audio between the left and right speakers.







FADE: Press ◀ MENU ▶ to adjust the audio between the front and rear speakers.

Next/previous directory: In MP3 mode, press MENU ◀ / ▶ to go to the previous/next directory.

Flat file/directory mode: In MP3 mode, press MENU to access this feature. Use ◀ MENU ▶ to select flat file mode or directory mode.

Track #/ normal music name/file name: Press MENU to access and use ◀ / ▶ to scroll through MP3 display options (track #, normal music name or file name).

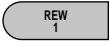
Entertainment Systems

8. **TUNE/DISC:**In radio mode, press to manually go down/up (◀/▶) the radio frequency, or to access another CD/MP3. Also use in menu mode to select various settings.
- 
9. **SHUFF (Shuffle):** Press to play the tracks on the current CD/MP3 in random order. In MP3 directory mode, press to play the tracks within the current directory in random order.
- 
10. **COMP (Compression):** In CD/MP3 modes, press to bring loud and soft passages together for a more consistent listening level.
- 
11. **REPEAT:** Press to repeat the current CD/MP3 track. The selection will repeat continuously until deactivated. Press REPEAT again to deactivate.
- 
12. **FF (Fast forward):** Press to manually advance in a CD/MP3 track.
- 
13. **REW (Rewind):** Press to manually reverse in a CD/MP3 track.
- 
14. **Memory presets:** To set a station: Select frequency band AM/FM; tune to a station, press and hold a preset button until sound returns. To select a preset station, press the desired memory preset. You can save up to 18 stations, six in AM, six in FM1 and FM2.
- 

In satellite radio mode (if equipped), there are 18 available presets, six each for SAT1, SAT2 and SAT3. To save satellite channels in your memory presets, tune to the desired channel then press and hold a preset control until sound returns.

Satellite radio is available only with a valid SIRIUS subscription. Check with your authorized dealer for availability.

15. **SEEK/TRACK: In radio, CD and MP3 flat file mode,**

press ◀ / ▶ to access the

previous/next strong station or

track. In MP3 directory mode, press to select the next/previous track in the current directory.

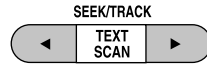

In satellite radio mode (if equipped), press ◀ SEEK ▶ to seek to the previous/next channel.

In CATEGORY MODE, press ◀ SEEK ▶ to select a channel within that category. Press and hold ◀ SEEK ▶ to fast seek through the previous /next channels.

In TEXT MODE, press ◀ SEEK ▶ to view the previous/additional display text.

Satellite radio is available only with a valid SIRIUS subscription. Check with your authorized dealer for availability.

16. **TEXT/SCAN: In radio and**

CD mode, press for a brief sampling of radio stations or CD tracks. Press and hold again to stop.



In MP3 mode, Press and release to view the next 12 characters in the MP3 music name/file name of the current MP3 track and directory.

Press and hold to hear a brief sampling of MP3 tracks.

In MP3 directory mode, press and hold to hear a brief sampling of all tracks in the current directory. Press again to stop.

In satellite radio mode (if equipped), press and release to view the Satellite text message.

Press and hold to hear a brief sampling of the next channels. Press and hold again to stop.

Satellite radio is available only with a valid SIRIUS subscription. Check with your authorized dealer for availability.

17. **ON/OFF/Volume:** Press to turn ON/OFF. Turn to increase/decrease volume.

If the volume is set above a

certain level and the ignition is

turned off, the volume will come

back on at a “nominal” listening level when the ignition switch is turned back on.

VOL - PUSH



Entertainment Systems

18. **LOAD:** Press to load a CD/MP3.

To load a CD/MP3 disc to a specific slot, press LOAD and select the slot number by pressing the memory preset buttons. Press and hold LOAD to autoloading up to six discs.



19. **CD slot:** Insert a CD/MP3, label side up.



Auxiliary input jack (Line in)

Your vehicle may be equipped with an Auxiliary Input Jack (AIJ). The Auxiliary Input Jack provides a way to connect your portable music player to the in-vehicle audio system. This allows the audio from a portable music player to be played through the vehicle speakers with high fidelity. To achieve optimal performance, please observe the following instructions when attaching your portable music device to the audio system.

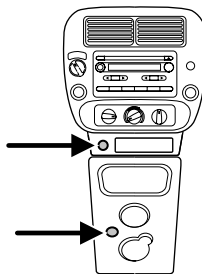

Required equipment:

1. Any portable music player designed to be used with headphones
2. An audio extension cable with stereo male 1/8 in. (3.5 mm) connectors at each end

To play your portable music player using the auxiliary input jack:

1. Begin with the vehicle parked and the radio turned off.
2. Ensure that the battery in your portable music player is new or fully charged and that the device is turned off.
3. Attach one end of the audio extension cable to the headphone output of your player and the other end of the audio extension cable to the AIJ in your vehicle.
4. Turn the radio on, using either a tuned FM station or a CD loaded into the system. Adjust the volume to a comfortable listening level.
5. Turn the portable music player on and adjust the volume to 1/2 the volume.

6. Press AUX on the vehicle radio repeatedly until LINE IN appears in the display.
You should hear audio from your portable music player although it may be low.
7. Adjust the sound on your portable music player until it reaches the level of the FM station or CD by switching back and forth between the AUX and FM or CD controls.

Troubleshooting:

1. Do not connect the audio input jack to a line level output. Line level outputs are intended for connection to a home stereo and are not compatible with the AIJ. The AIJ will only work correctly with devices that have a headphone output with a volume control.
2. Do not set the portable music player's volume level higher than is necessary to match the volume of the CD or FM radio in your audio system as this will cause distortion and will reduce sound quality. Many portable music players have different output levels, so not all players should be set at the same levels. Some players will sound best at full volume and others will need to be set at a lower volume.
3. If the music sounds distorted at lower listening levels, turn the portable music player volume down. If the problems persists, replace or recharge the batteries in the portable music player.
4. The portable music player must be controlled in the same manner when it is used with headphones as the AIJ does not provide control (play, pause, etc.) over the attached portable music player.
5. For safety reasons, connecting or adjusting the settings on your portable music player should not be attempted while the vehicle is moving. Also, the portable music player should be stored in a secure location, such as the center console or the glove box, when the vehicle is in motion. The audio extension cable must be long enough to allow the portable music player to be safely stored while the vehicle is in motion.

GENERAL AUDIO INFORMATION

Radio frequencies:

AM and FM frequencies are established by the Federal Communications Commission (FCC) and the Canadian Radio and Telecommunications Commission (CRTC). Those frequencies are:

AM: 530, 540–1700, 1710 kHz

FM: 87.7, 87.9–107.7, 107.9 MHz

Entertainment Systems

Radio reception factors:

There are three factors that can affect radio reception:

- Distance/strength: The further you travel from an FM station, the weaker the signal and the weaker the reception.
- Terrain: Hills, mountains, tall buildings, power lines, electric fences, traffic lights and thunderstorms can interfere with your reception.
- Station overload: When you pass a broadcast tower, a stronger signal may overtake a weaker one and play while the weak station frequency is displayed.

CD/CD player care

Do:

- Handle discs by their edges only. (Never touch the playing surface).
- Inspect discs before playing.
- Clean only with an approved CD cleaner.
- Wipe discs from the center out.



Don't:

- Expose discs to direct sunlight or heat sources for extended periods of time.
- Clean using a circular motion.

CD units are designed to play commercially pressed 4.75 in (12 cm) audio compact discs only. Due to technical incompatibility, certain recordable and re-recordable compact discs may not function correctly when used in Mazda CD players.

Do not use any irregular shaped CDs or discs with a scratch protection film attached.



CDs with homemade paper (adhesive) labels should not be inserted into the CD player as the label may peel and cause the CD to become jammed. It is recommended that homemade CDs be identified with permanent felt tip marker rather than adhesive labels. Ballpoint pens may damage CDs. Please contact your authorized dealer for further information.



Audio system warranty and service

Refer to the *Warranty Information Booklet* for audio system warranty information. If service is necessary, see your authorized Mazda dealership.

Satellite radio information (if equipped)

Satellite radio channels: SIRIUS broadcasts a variety of music, news, sports, weather, traffic and entertainment satellite radio channels. For more information and a complete list of SIRIUS satellite radio channels, visit www.sirius.com in the United States, www.sirius-canada.ca in Canada, or call SIRIUS at 1-888-539-7474.

Satellite radio reception factors: To receive the satellite signal, your vehicle has been equipped with a satellite radio antenna located on the roof of your vehicle. The vehicle roof provides the best location for an unobstructed, open view of the sky, a requirement of a satellite radio system. Like AM/FM, there are several factors that can affect satellite radio reception performance:

- **Antenna obstructions:** For optimal reception performance, keep the antenna clear of snow and ice build-up and keep luggage and other material as far away from the antenna as possible.
- **Terrain:** Hills, mountains, tall buildings, bridges, tunnels, freeway overpasses, parking garages, dense tree foliage and thunderstorms can interfere with your reception.

Entertainment Systems

- **Station overload:** When you pass a ground based broadcast repeating tower, a stronger signal may overtake a weaker one and result in an audio mute.

Unlike AM/FM audible static, you will hear an audio mute when there is a satellite radio signal interference. Your radio display may display NO SIGNAL to indicate the interference.

SIRIUS satellite radio service: SIRIUS Satellite Radio is a subscription based satellite radio service that broadcasts music, sports, news and entertainment programming. A service fee is required in order to receive SIRIUS service. Vehicles that are equipped with a factory installed SIRIUS Satellite Radio system include:

- Hardware and limited subscription term, which begins on the date of sale or lease of the vehicle.
- Online media player providing access to all 65 SIRIUS music channels over the internet (U.S. customers only).

For information on extended subscription terms, contact SIRIUS at 1-888-539-7474.

Note: SIRIUS reserves the unrestricted right to change, rearrange, add or delete programming including canceling, moving or adding particular channels, and its prices, at any time, with or without notice to you. Mazda Motor Corporation shall not be responsible for any such programming changes.

Satellite Radio Electronic Serial Number (ESN): This 12-digit Satellite Serial Number is needed to activate, modify or track your satellite radio account. You will need this number when communicating with SIRIUS. While in Satellite Radio mode, you can view this number on the radio display by pressing AUX and Preset 1 control simultaneously.

Entertainment Systems

Radio Display	Condition	Action Required
ACQUIRING	Radio requires more than two seconds to produce audio for the selected channel.	No action required. This message should disappear shortly.
SAT FAULT	Internal module or system failure present.	If this message does not clear within a short period of time, or with an ignition key cycle, your receiver may have a fault. See your authorized dealer for service.
INVALID CHNL	Channel no longer available.	This previously available channel is no longer available. Tune to another channel. If the channel was one of your presets, you may choose another channel for that preset button.
UNSUBSCRIBED	Subscription not available for this channel.	Contact SIRIUS at 1-888-539-7474 to subscribe to the channel or tune to another channel.
NO TEXT	Artist information not available.	Artist information not available at this time on this channel. The system is working properly.

Entertainment Systems

Radio Display	Condition	Action Required
NO TEXT	Song title information not available.	Song title information not available at this time on this channel. The system is working properly.
NO TEXT	Category information not available.	Category information not available at this time on this channel. The system is working properly.
NO SIGNAL	Loss of signal from the SIRIUS satellite or SIRIUS tower to the vehicle antenna.	You are in a location that is blocking the SIRIUS signal (i.e., tunnel, under an overpass, dense foliage, etc). The system is working properly. When you move into an open area, the signal should return.
UPDATING	Update of channel programming in progress.	No action required. The process may take up to three minutes.
CALL SIRIUS 1-888-539-7474	Satellite service has been deactivated by SIRIUS Satellite Radio.	Call SIRIUS at 1-888-539-7474 to re-activate or resolve subscription issues.

HEATER ONLY SYSTEM (IF EQUIPPED)

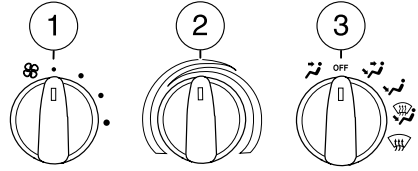

1. **Fan speed adjustment:**

Controls the volume of air circulated in the vehicle.

2. **Temperature selection:**

Controls the temperature of the airflow in the vehicle.

3. **Air flow selections:** Controls the direction of the airflow in the vehicle. See the following for a brief description on each control.

 : Distributes outside air through the instrument panel vents.

OFF: Outside air is shut out and the fan will not operate.

 : Distributes outside air through the instrument panel vents and the floor vents.

 : Distributes outside air through the floor vents.

 : Distributes outside air through the windshield defroster vents and floor vents.

 : Distributes outside air through the windshield defroster vents.

Operating tips

- To reduce fog build up on the windshield during humid weather, place the air flow selector in the  position.
- To reduce humidity build up inside the vehicle during cold or warm weather, do not drive with the air flow selector in the OFF position.
- Under normal weather conditions, do not leave the air flow selector in OFF when the vehicle is parked. This allows the vehicle to “breathe” using the outside air inlet vents.
- Do not put objects under the front seats that will interfere with the air flow to the back seats.
- Remove any snow, ice or leaves from the air intake area at the base of the windshield.

To aid in side window defogging/demisting in cold weather:

1. Select  .
2. Adjust the temperature control to maintain comfort.
3. Set the fan speed to the highest setting.

Climate Controls

4. Direct the outer instrument panel vents towards the side windows. To increase airflow to the outer instrument panel vents, close the vents located in the middle of the instrument panel.

WARNING: Do not place objects on top of the instrument panel as these objects may become projectiles in a collision or sudden stop.

MANUAL HEATING AND AIR CONDITIONING SYSTEM (IF EQUIPPED)

- Fan speed adjustment:**
Controls the volume of air circulated in the vehicle.
- Temperature selection:**
Controls the temperature of the airflow in the vehicle.
- Air flow selections:** Controls the direction of the airflow in the vehicle. See the following for a brief description on each control.

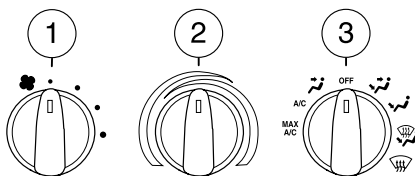



MAX A/C: Uses recirculated air to cool the vehicle. Air flows from the instrument panel vents only. Temperature of airflow not adjustable.

A/C: Uses outside air to cool the vehicle. Air flows from the instrument panel vents only.

 : Distributes outside air through the instrument panel vents.

OFF: Outside air is shut out and the fan will not operate.

 : Distributes outside air through the instrument panel vents and the floor vents.

 : Distributes outside air through the floor vents.

 : Distributes outside air through the windshield defroster vents and floor vents.

 : Distributes outside air through the windshield defroster vents.

Operating tips

- To reduce fog build up on the windshield during humid weather, place the air flow selector in the  position.
- To reduce humidity build up inside the vehicle: do not drive with the air flow selector in the OFF position.

- Under normal weather conditions, do not leave the air flow selector in MAX A/C or OFF when the vehicle is parked. This allows the vehicle to “breathe” using the outside air inlet vents.
- Do not put objects under the front seats that will interfere with the airflow to the back seats.
- Remove any snow, ice or leaves from the air intake area at the base of the windshield.

To aid in side window defogging/demisting in cold weather:

1. Select .
2. Adjust the temperature control to maintain comfort.
3. Set the highest fan speed.
4. Direct the outer instrument panel vents towards the side windows.

To increase airflow to the outer instrument panel vents, close the vents located in the middle of the instrument panel.

WARNING: Do not place objects on top of the instrument panel as these objects may become projectiles in a collision or sudden stop.

Lights

HEADLAMP CONTROL ☀

- Turns the lamps off.
- P☀ Turns on the parking lamps, instrument panel lamps, license plate lamps and tail lamps.
- ☀☀☀ Turns the headlamps on.

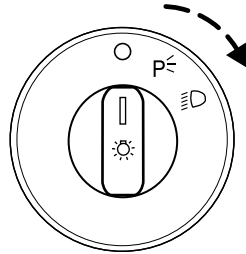

Foglamp control (if equipped) ☀☀

The foglamps can be turned on when the headlamp control is in the ☀☀ or P☀ position and the high beams are not turned on.

Pull headlamp control towards you to turn foglamps on. The foglamp indicator light ☀☀ on the headlamp control and in the instrument cluster will illuminate.

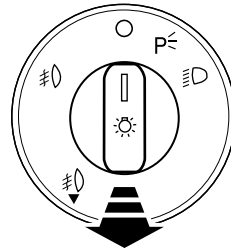

High beams ☀☀☀

After turning the headlamps on, push the lever toward the instrument panel to activate. Pull the lever towards you to deactivate.

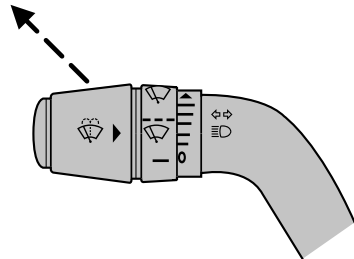

Flash to pass

Pull toward you slightly to activate and release to deactivate.

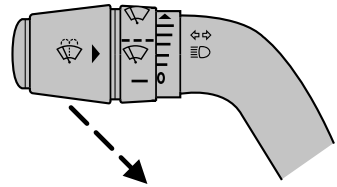

Daytime running lamps (DRL) (if equipped)

Turns the headlamps on with a reduced output.

To activate:

- the ignition must be in the ON position and
- the headlamp control is in the OFF or parking lamp.

WARNING: Always remember to turn on your headlamps at dusk or during inclement weather. The Daytime Running Lamp (DRL) (if equipped) system does not activate the parking lights or side marker lights and generally may not provide adequate lighting during these conditions. Failure to activate your headlamps under these conditions may result in a collision.

PANEL DIMMER CONTROL

Use to adjust the brightness of the instrument panel and all applicable switches in the vehicle during headlamp and parklamp operation.

Move the control up or down to adjust the intensity of the panel lighting.

Move the control to the full upright position, past detent, to turn on the interior lamps.

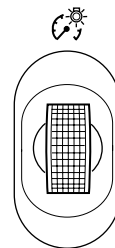

Note: If the battery is disconnected, discharged, or a new battery is installed, the dimmer switch requires re-calibration. Rotate the dimmer

Lights

switch from the full dim position to the full Dome/ON position to reset. This will ensure that your displays are visible under all lighting conditions.

AIMING THE HEADLAMPS

The headlamps on your vehicle are properly aimed before leaving the assembly plant. If your vehicle is involved in an accident or if you have problems fixing the alignment of your headlamps, have them checked by a qualified service technician.

Headlamp aim adjustment

The headlamps are designed to be mechanically aimed, but can also be aimed visually by doing the following:

1. Park your vehicle on a level surface about 25 feet (7.6 meters) away from a vertical plain surface (3). Check your headlamp alignment at night or in a dark area so that you can see the headlamp beam pattern.
 - (1) 8 feet (2.4 meters)
 - (2) Center height of lamp to ground
 - (3) 25 feet (7.6 meters)
 - (4) Horizontal reference line
 - (5) Center of headlamps
 - (6) Center line of the vehicle
2. The center of the headlamp is marked either on the lens (a circle or cross marker) or on the bulb shield, internal to the lamp (mark or feature). Measure the height from the center of your headlamp to the ground (2) and mark an 8 foot (2.4 meter) long horizontal line on the wall or screen (1) at this height (masking tape works well).

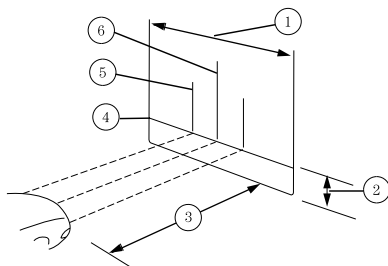

3. Turn on the low beam headlamps and open the hood.
4. Locate the high intensity area of the beam pattern and place the top edge of the intensity zone even with the horizontal reference line (4). If the top edge of the high intensity area is not even with the horizontal line, follow the next step to adjust it.

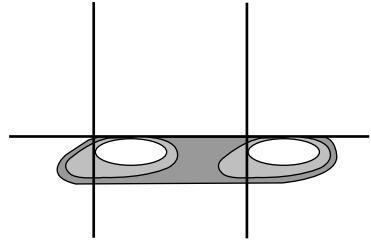

5. Locate the vertical adjuster for each headlamp. Adjust the aim by using a 4 mm wrench to turn the adjuster control either clockwise (to adjust down) or counterclockwise (to adjust up).
6. In addition to the horizontal line marked in step 2, a pair of vertical lines (5) must be marked at the center line of the headlamps on the wall or screen.

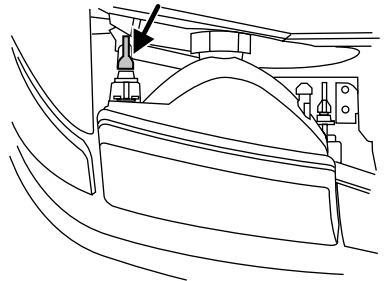

7. On the wall or screen, locate the high intensity area of the beam pattern. The left edge of the high intensity area should be even with the vertical line corresponding to the headlamp under adjustment. If the left edge of the high intensity area is not even with the vertical line, follow the next step to adjust it.

8. Locate the horizontal adjuster for each headlamp. Use a 4 mm wrench, turning it clockwise or counterclockwise, to place the left edge of the high intensity area even with the vertical line corresponding to the headlamp under adjustment.

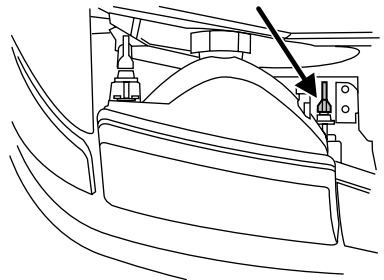

Lights

TURN SIGNAL CONTROL ↵↶

- Push down to activate the left turn signal.
- Push up to activate the right turn signal.

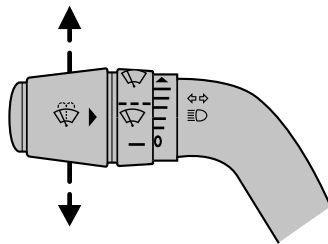

INTERIOR LAMPS

Courtesy/reading lamps (if equipped)

The courtesy lamp lights when:

- any door is opened.
- the instrument panel dimmer switch is held up until the courtesy lamps come on.
- the remote entry controls are pressed and the ignition is OFF.

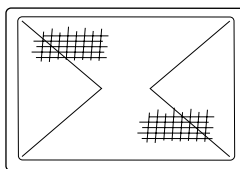

BULB REPLACEMENT

Headlamp Condensation

The headlamps are vented to equalize pressure. When moist air enters the headlamp(s) through the vents, there is a possibility that condensation can occur. This condensation is normal and will clear within 45 minutes of headlamp operation.

Using the right bulbs

Replacement bulbs are specified in the chart below. Headlamp bulbs must be marked with an authorized “D.O.T.” for North America and an “E” for Europe to ensure lamp performance, light brightness and pattern and safe visibility.

NOTE: The correct bulbs will not damage the lamp assembly or void the lamp assembly warranty and will provide quality bulb burn time.

Function	Number of bulbs	Trade number
Park/turn/side marker lamps (front)	2	3157 A (amber)
Headlamps	2	9007
Fog lamps (if equipped)	2	9006
Hi-mount brake lamp	1	922
Rear stop/tail lamps	2	4157K or 3157K
Rear turn lamps	2	3156
Rear license plate lamps	2	194
Backup lamps	2	3155
Dome lamp	1	912
Map/dome-SuperCab (if equipped)	2	904
Map/dome-Regular Cab (if equipped)	1	904
All replacement bulbs are clear in color except where noted.		
To replace all instrument panel lights - see your authorized dealer.		

Replacing the interior bulbs

Check the operation of the following interior bulbs frequently:

- Courtesy/Reading lamp

For bulb replacement, see an authorized Mazda dealer.

Replacing exterior bulbs

Check the operation of all the bulbs frequently.

Replacing headlamp bulbs

NOTE: The procedure can be difficult. Your Mazda dealer has the proper tools, training and parts to perform this task. If you have difficulty with this, visit your local Mazda dealer.

WARNING: Handling Halogen Bulbs: When a halogen bulb breaks, it is dangerous. These bulbs contain pressurized gas. If one is broken, it will explode and serious injuries could be caused by the flying glass. If the glass portion of the bulb is touched with bare hands, body oil could cause the bulb to overheat and explode when lit. Never touch the glass portion of the bulb with your bare hands and always wear eye protection when handling or working around halogen bulbs.

Lights

WARNING: Children and Halogen Bulbs: Playing with a halogen bulb is dangerous. Serious injuries could be caused by dropping a halogen bulb or breaking in some other way. Always keep halogen bulbs out of the reach of children.

To remove the headlamp bulb:

1. Make sure headlamp switch is in OFF position, then open the hood.
2. Reach behind the lamp assembly for access and disconnect the electrical connector.
3. Locate the bulb retaining ring behind the headlamp assembly.

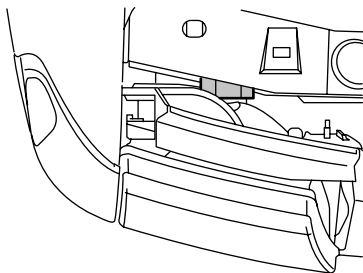

4. Remove the bulb retaining ring by turning it counterclockwise and remove the old bulb by gently pulling it straight back out of the lamp assembly. Keep the retaining ring to retain the new bulb.

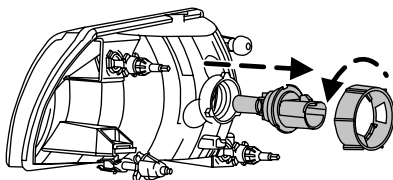

To install the new bulb:

Handle a halogen headlamp bulb carefully and keep out of children's reach. Grasp the bulb only by its plastic base and do not touch the glass. The oil from your hands could cause the bulb to break the next time the headlamps are operated. Always wear safety glasses while handling bulbs.

NOTE: If the bulb is accidentally touched, it should be cleaned with rubbing alcohol before being used.

1. With the flat side of the bulb's plastic base facing upward, insert the glass end of the bulb into the lamp assembly. You may need to turn the bulb left or right to align the grooves in the plastic base with the

tabs in the lamp assembly. When the grooves are aligned, push the bulb into the lamp assembly until the plastic base contacts the rear of the lamp assembly.

2. Install the bulb retaining ring over the plastic base until it contacts the rear of the socket by rotating clockwise until you feel a “stop.”
3. Install the electrical connector into the plastic base until it snaps, locking it into position.
4. Turn the headlamps on and make sure they work properly. If the headlamp was correctly aligned before you changed the bulb, you should not need to align it again.

Replacing front park/turn side marker bulbs

1. Make sure headlamp switch is in OFF position, then open the hood.
2. Remove the screw from lamp assembly.
3. Disengage lamp assembly by pulling it straight forward. It has a snap fit.

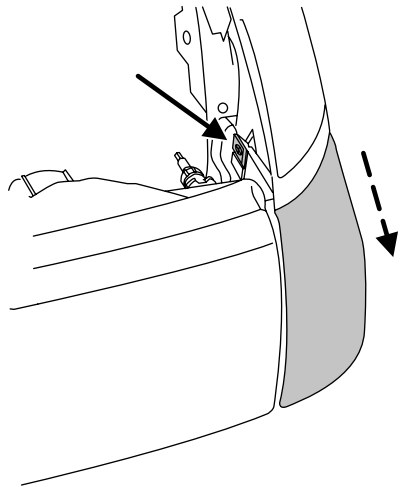

4. Rotate bulb socket counterclockwise and remove from lamp assembly.

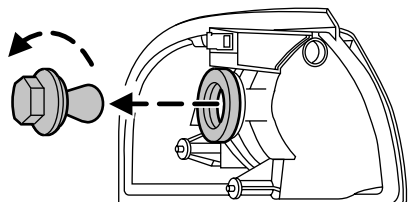

Lights

- Carefully pull bulb straight out of socket and push in the new bulb.
- Install the bulb socket in lamp assembly by turning clockwise.
- Align the lamp on the vehicle and push to snap in place.
- Install the screw on lamp assembly.

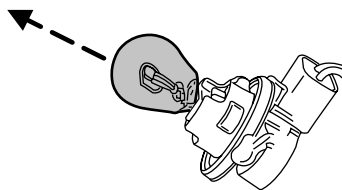

Replacing stop lamp/tail lamp/sidemarkers lamp/turn lamp/backup lamp bulbs

These bulbs are located in the same portion of the tail lamp assembly, one just below the other. Follow the same steps to replace either bulb:

- Open the tailgate to expose the lamp assemblies.
- Remove the four screws and the lamp assembly from vehicle.

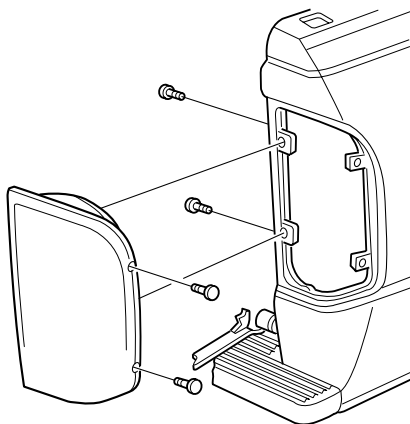

- Rotate the bulb socket counterclockwise and remove from lamp assembly.
- Carefully pull the bulb straight out of the socket and push in the new bulb.
- Install the bulb socket in lamp assembly by turning clockwise.
- Install the lamp assembly and secure with four screws.

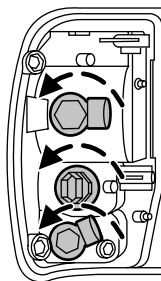

Replacing fog lamp bulbs

WARNING: Handling Halogen Bulbs: When a halogen bulb breaks, it is dangerous. These bulbs contain pressurized gas. If one is broken, it will explode and serious injuries could be caused by the flying glass. If the glass portion of the bulb is touched with bare hands, body oil could cause the bulb to overheat and explode when lit. Never touch the glass portion of the bulb with your bare hands and always wear eye protection when handling or working around halogen bulbs.

WARNING: Children and Halogen Bulbs: Playing with a halogen bulb is dangerous. Serious injuries could be caused by dropping a halogen bulb or breaking in some other way. Always keep halogen bulbs out of the reach of children.

NOTE: If the bulb is accidentally touched, it should be cleaned with rubbing alcohol before being used.

1. Remove the bulb socket from the fog lamp by turning counterclockwise.
2. Disconnect the electrical connector from the fog lamp bulb.
3. Connect the electrical connector to the new fog lamp bulb.
4. Install the bulb socket in the fog lamp turning clockwise.

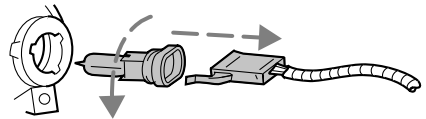

Replacing high-mount brake lamp

To remove the brake lamp assembly:

1. Remove the two screws and lamp assembly from vehicle.
2. Remove the bulb socket from lamp assembly by rotating it counterclockwise.
3. Carefully pull bulb straight out of socket and push in the new bulb.



To install the brake lamp assembly:

1. Install the bulb socket into the lamp assembly by rotating clockwise.
2. Install the lamp assembly on the vehicle and secure with two screws.

Lights

Replacing license plate lamp bulbs

The license plate bulbs are located behind the rear bumper. To change the license plate lamp bulbs:

1. Reach behind the rear bumper to locate the bulb socket.
2. Twist the socket counterclockwise and remove.
3. Pull out the old bulb from socket and push in the new bulb.
4. Install the bulb socket in lamp assembly by turning it clockwise.

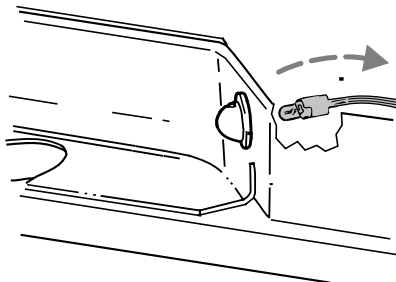

MULTI-FUNCTION LEVER

Windshield wiper: Rotate the end of the control away from you to increase the speed of the wipers (from desired interval to low or high speed position); rotate towards you to decrease the speed of the wipers.

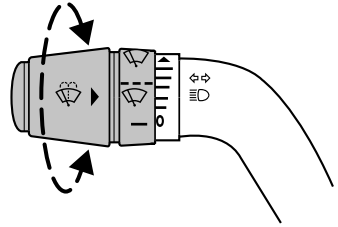

Windshield washer: Push the end of the stalk:

- briefly: causes a single swipe of the wipers without washer fluid.
- a quick push and hold: the wipers will swipe several times with washer fluid.
- a long push and hold: the wipers and washer fluid will be activated for up to ten seconds.

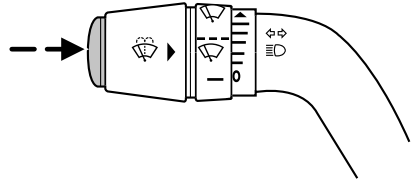

Courtesy wipe feature: One extra wipe will happen a few seconds after washing the front window to clear any water that is dripping down from the top of the windshield caused by the washing.

Note: Do not operate the washer when the washer reservoir is empty. This may cause the washer pump to overheat. Check the washer fluid level frequently. Do not operate the wipers when the windshield is dry. This may scratch the glass, damage the wiper blades and cause the wiper motor to burn out. Before operating the wiper on a dry windshield, always use the windshield washer. In freezing weather, be sure the wiper blades are not frozen to the windshield before operating the wipers.

Driver Controls

TILT STEERING WHEEL (IF EQUIPPED)

To adjust the steering wheel:

1. Pull and hold the steering wheel release control toward you.
2. Move the steering wheel up or down until you find the desired location.
3. Release the steering wheel release control. This will lock the steering wheel in position.

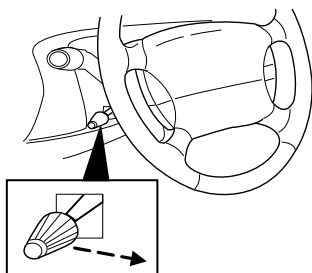

WARNING: Adjusting the steering wheel while the vehicle is moving is dangerous. Moving it can very easily cause the driver to abruptly turn to the left or right. This can lead to loss of control or an accident. Never adjust the steering wheel while the vehicle is moving.

CENTER CONSOLE (IF EQUIPPED)

Your vehicle may be equipped with a variety of console features. These include:

- Utility compartment with cassette/compact disc storage
- Cupholders
- Flip up armrest

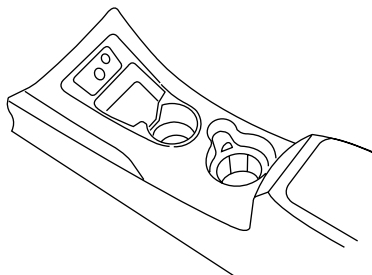

WARNING: Use only soft cups in the cupholder. Hard objects can injure you in a collision.

AUXILIARY POWER POINT (12VDC)

Power outlets are designed for accessory plugs only. Do not insert any other object in the power outlet as this will damage the outlet and blow the fuse. Do not hang any type of accessory or accessory bracket from the plug. Improper use of the power outlet can cause damage not covered by your warranty.

The auxiliary power points are located on the instrument panel.

Do not use the power point for operating the cigarette lighter element (if equipped).

To prevent the fuse from being blown, do not use the power point(s) over the vehicle capacity of 12 VDC/180W. If the power point or cigar lighter socket is not working, a fuse may have blown. Refer to *Passenger Compartment Fuse Panel* and *Fuses and relays* in the *Roadside Emergencies* chapter for fuse ratings and information on checking and replacing fuses.

To prevent the battery from being discharged, do not use the power point longer than necessary when the engine is not running.

Always keep the power point caps closed when not being used.

Cigar/Cigarette lighter (if equipped)

Do not plug optional electrical accessories into the cigarette lighter socket.

Do not hold the lighter in with your hand while it is heating, this will damage the lighter element and socket. The lighter will be released from its heating position when it is ready to be used.

Improper use of the lighter can cause damage not covered by your warranty.

POWER WINDOWS (IF EQUIPPED)

WARNING: Do not leave children unattended in the vehicle and do not let children play with the power windows. They may seriously injure themselves.

WARNING: When closing the power windows, you should verify they are free of obstructions and ensure that children and/or pets are not in the proximity of the window openings.

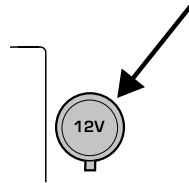

Driver Controls

Press and pull the window switches to open and close windows.

- Push down (to the first detent) and hold the switch to open.
- Pull up and hold the switch to close.

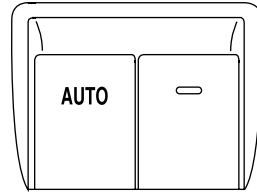

One touch down

Allows the driver's window to open fully without holding the control down. Push the switch completely down to the second detent and release quickly. The window will open fully. Momentarily press the switch to any position to stop the window operation.

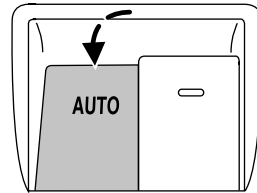

INTERIOR MIRROR

The interior rear view mirror has two pivot points on the support arm which lets you adjust the mirror UP or DOWN and from SIDE to SIDE.

WARNING: Do not adjust the mirror while the vehicle is in motion.

EXTERIOR MIRRORS

Power mirror control (if equipped)

To adjust your mirrors:

1. Rotate the control clockwise to adjust the right mirror and rotate the control counterclockwise to adjust the left mirror.
2. Move the control in the direction you wish to tilt the mirror.
3. Return to the center position to lock mirrors in place.

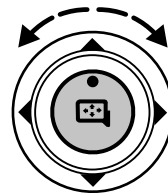

Fold-away mirrors

Pull the side mirrors in carefully when driving through a narrow space, like an automatic car wash.

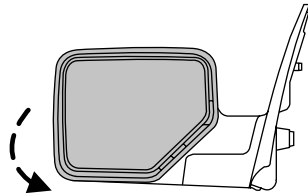

SPEED CONTROL (IF EQUIPPED)

With speed control set, you can maintain a set speed without keeping your foot on the accelerator pedal.

WARNING: Do not use the speed control in heavy traffic or on roads that are winding, slippery, or unpaved. You may lose control of the vehicle.

WARNING: Do not shift the gearshift lever into N (Neutral) with the speed control on. You may lose control of the vehicle or cause engine system damage.

Setting speed control

The controls for using your speed control are located on the steering wheel for your convenience.

1. Press the ON control and release it.
2. Accelerate to the desired speed.
3. Press the SET + control and release it.
4. Take your foot off the accelerator pedal.
5. The indicator light  on the instrument cluster will turn on.

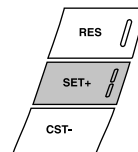
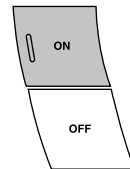

Note:

- Vehicle speed may vary momentarily when driving up and down a steep hill.

Driver Controls

- If the vehicle speed increases above the set speed on a downhill, you may want to apply the brakes to reduce the speed.
- If the vehicle speed decreases more than 10 mph (16 km/h) below your set speed on an uphill, your speed control will disengage.

Disengaging speed control

To disengage the speed control:

- Depress the brake pedal or
- Depress the clutch pedal (if equipped).

Disengaging the speed control will not erase previous set speed.

Note: When you use the clutch pedal to disengage the speed control, the engine speed may briefly increase, this is normal.

Resuming a set speed

Press the RES (resume) control and release it. This will automatically return the vehicle to the previously set speed.

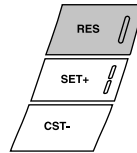

Increasing speed while using speed control

There are three ways to set a higher speed:

- Press and hold the SET + control until you get to the desired speed, then release the control.
- Press and release the SET + control to operate the Tap-Up function. Each tap will increase the set speed by 1 mph (1.6 km/h).
- Use the accelerator pedal to get to the desired speed. When the vehicle reaches that speed press and release the SET + control.

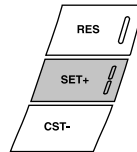

Reducing speed while using speed control

There are three ways to reduce a set speed:

- Press and hold the CST - control until you get to the desired speed, then release the control.
- Press and release the CST - control to operate the Tap-Down function. Each tap will decrease the set speed by 1 mph (1.6 km/h).
- Depress the brake pedal or the clutch pedal (if equipped) until the desired vehicle speed is reached, press the SET + control.

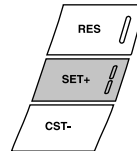
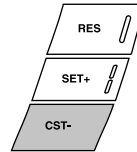

Turning off speed control

There are three ways to turn off the speed control:

- Depress the brake pedal or the clutch pedal (if equipped). This will not erase your vehicle's previously set speed.
- Press the speed control OFF control.
- Turn OFF the ignition.

Note: When you turn off the speed control or the ignition, your speed control set speed memory is erased.

Note: Fully depressing the clutch pedal may cause a flare in engine RPM as the throttle is returned to idle. This is normal.

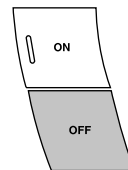

OVERDRIVE CONTROL (IF EQUIPPED)

Activating overdrive

D (Overdrive) is the normal drive position for the best fuel economy.

The overdrive function allows automatic upshifts and downshifts through all available gears.

Driver Controls

Deactivating overdrive

Press the Transmission Control Switch (TCS) located on the end of the gearshift lever. The O/D Off indicator light will illuminate on the instrument cluster. The transmission will operate in all gears except overdrive.

To return to normal overdrive mode, press the Transmission Control Switch again. The O/D Off indicator light will no longer be illuminated.

When you shut off and re-start your vehicle, the transmission will automatically return to normal **D** (Overdrive) mode.

For additional information about the gearshift lever and the transmission control switch operation refer to the *Automatic Transmission Operation* section of the *Driving* chapter.

BED EXTENDER (IF EQUIPPED)

Your vehicle may be equipped with a bed extender designed to extend the pickup box for larger loads.

To extend the bed extender:

1. Lower tailgate.
2. Pull the lever on each side of the bed extender to release it from the pickup box.
3. Lift the bed extender over onto the tailgate.
4. Evenly push down on the bed extender and push the lever in on each side locking it in place.

To stow the bed extender, follow steps one through four in reverse order.

The bed extender may be used to secure a load of up to 100 lb. (46 kg) on the tailgate.

The bed extender should always be kept in the stowed position with the tailgate closed when not in use.

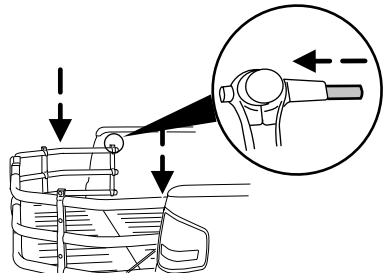
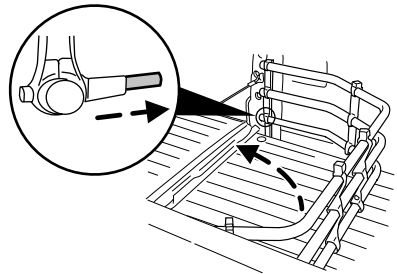
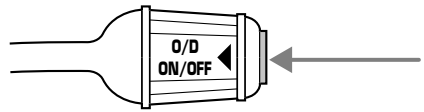

Activating bed extender Theft Deterrent Device:

The following procedure can be done with the bed extender in the stowed or extended position.

1. Locate the Phillips head screw in the middle of the vertical brace in front of the locking clip.
2. Turn the screw counterclockwise until you hear an audible click.
3. To deactivate, turn the screw clockwise until the locking clip moves freely.

To remove the bed extender:

1. Extend the bed extender.
2. Pull the lever on each side of the bed extender to unlock it.

Make sure the locking clip screws are loose before removing the bed extender.

3. Press the locking clips below the middle bar and lift the bed extender out of the channels on the "D" pillar.

To install the bed extender, follow the removal procedure in reverse order.

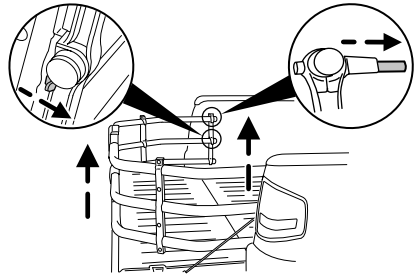
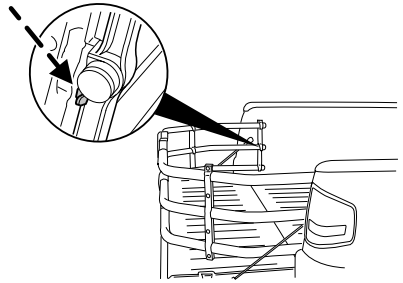

Locks and Security

KEYS

The key operates all locks on your vehicle. You should always carry a second key with you in a safe place in case you require it in an emergency.

If your vehicle is equipped with the SecuriLock™ Passive Anti-theft system, your keys are coded to your vehicle; using a non-coded key will not permit your vehicle to start. If you lose your dealer supplied keys, replacement keys are available through your authorized dealer.

POWER DOOR LOCKS (IF EQUIPPED)

Press the control to unlock or lock all the doors.



REMOTE ENTRY SYSTEM (IF EQUIPPED)

This device complies with part 15 of the FCC rules and with RS-210 of Industry Canada. Operation is subject to the following two conditions: (1) This device may not cause harmful interference, and (2) This device must accept any interference received, including interference that may cause undesired operation.

Changes or modifications not expressly approved by the party responsible for compliance could void the user's authority to operate the equipment.

The typical operating range for your remote entry transmitter is approximately 33 feet (10 meters). A decrease in operating range could be caused by:

- weather conditions,
- nearby radio towers,
- structures around the vehicle, or
- other vehicles parked next to your vehicle.

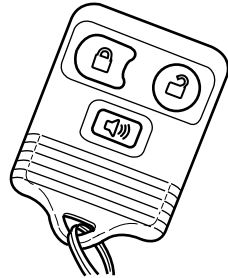

Your vehicle is equipped with a remote entry system which allows you to:

- unlock the vehicle doors without a key.
- lock all the vehicle doors without a key.
- activate the personal alarm.





If there are problems with the remote entry system, make sure to take **ALL remote entry transmitters** with you to your authorized dealer in order to aid in troubleshooting the problem.

Unlocking the doors

1. Press  and release to unlock the driver's door. **Note:** The interior lamps will illuminate.
2. Press  and release again within three seconds to unlock all the doors.

Locking the doors

- Press  and release to lock all the doors. The park lamps will flash once to confirm lock; if any of the doors are not properly closed, the lamps will not flash.
- If  is pressed a second time within three seconds, the lamps will flash again and the horn will chirp to confirm all doors are locked and closed. If either door is ajar the lamps will not flash and the horn will chirp twice.

Car finder

Press  twice within 3 seconds. The horn will chirp and the turn lamps will flash. It is recommended that this method be used to locate your vehicle, rather than using the panic alarm.

Sounding a panic alarm

Press  to activate the alarm. The horn will sound and the parklamps will flash for approximately 3 minutes. Press again or turn the ignition to the 4 (ON) position to deactivate, or wait for the alarm to timeout in 3 minutes.

Locks and Security

Note: The panic alarm will only operate when the ignition is in the 2 (LOCK) or 3 (OFF) position.

Replacing the battery

The remote entry transmitter uses one coin type three-volt lithium battery CR2032 or equivalent.

To replace the battery:

1. Twist a thin coin between the two halves of the remote entry transmitter near the key ring. **DO NOT TAKE THE RUBBER COVER AND CIRCUIT BOARD OFF THE FRONT HOUSING OF THE REMOTE ENTRY TRANSMITTER.**

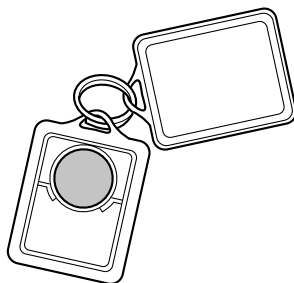

2. Do not wipe off any grease on the battery terminals on the back surface of the circuit board.

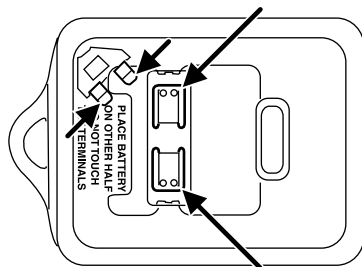

3. Remove the old battery. **Note:** Please refer to local regulations when disposing of transmitter batteries.
4. Insert the new battery. Refer to the diagram inside the remote entry transmitter for the correct orientation of the battery. Press the battery down to ensure that the battery is fully seated in the battery housing cavity.
5. Snap the two halves back together.

Note: Replacement of the battery will **not** cause the remote transmitter to become deprogrammed from your vehicle. The remote transmitter should operate normally after battery replacement.

Replacing lost remote entry transmitters

If you would like to have your remote entry transmitter reprogrammed because you lost one, or would like to buy additional remote entry

transmitters, you can either reprogram them yourself, or take **all remote entry transmitters** to your authorized dealer for reprogramming.

How to reprogram your remote entry transmitters

You must have **all remote entry transmitters** (maximum of four) available before beginning this procedure.

Note: Ensure the brake pedal is not depressed during this sequence.

To reprogram the remote entry transmitters:

1. Ensure the vehicle is electronically unlocked.
2. Put the key in the ignition.
3. Turn the key from the 2 (LOCK) position to 3 (OFF).
4. Cycle eight times rapidly (within 10 seconds) between the 3 (OFF) position and 4 (ON). **Note:** The eighth turn must end in the 4 (ON) position.
5. The doors will lock, then unlock, to confirm that the programming mode has been activated.
6. Within 20 seconds press any button on the remote entry transmitter. **Note:** If more than 20 seconds have passed you will need to start the procedure over again.
7. The doors will lock, then unlock, to confirm that this remote entry transmitter has been programmed.
8. Repeat Step 6 to program each additional remote entry transmitter.
9. Turn the ignition to the 3 (OFF) position after you have finished programming all of the remote entry transmitters. **Note:** After 20 seconds, you will automatically exit the programming mode.
10. The doors will lock, then unlock, to confirm that the programming mode has been exited.

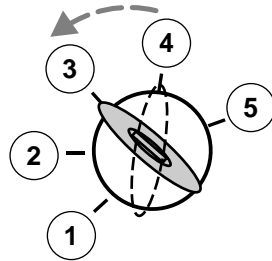

Illuminated entry

The interior lamps illuminate when the remote entry system is used to unlock the door(s) or sound the personal alarm.

Locks and Security

The illuminated entry system will turn off the interior lights if:

- the ignition switch is turned to the ON position, or
- the remote transmitter lock control is pressed, or
- after 25 seconds of illumination.

The inside lights will not turn off if:

- they have been turned on with the dimmer control, or
- any door is open.

The battery saver will shut off the interior lamps after several minutes if they are left on accidentally.

SECURILOCK™ PASSIVE ANTI-THEFT SYSTEM (IF EQUIPPED)

SecuriLock™ passive anti-theft system is an engine immobilization system. This system is designed to help prevent the engine from being started unless a **coded key programmed to your vehicle** is used. The use of the wrong type of coded key may lead to a “no-start” condition.

Your vehicle comes with two coded keys; additional coded keys may be purchased from your authorized dealer. The authorized dealer can program your spare keys to your vehicle or you can program the keys yourself. Refer to *Programming spare keys* for instructions on how to program the coded key.

Note: The SecuriLock™ passive anti-theft system is not compatible with non-Mazda aftermarket remote start systems. Use of these systems may result in vehicle starting problems and a loss of security protection.

Note: Large metallic objects, electronic devices that are used to purchase gasoline or similar items, or a second coded key on the same key chain may cause vehicle starting issues. You need to prevent these objects from touching the coded key while starting the engine. These objects will not cause damage to the coded key, but may cause a momentary issue if they are too close to the key when starting the engine. If a problem occurs, turn the ignition off, remove all objects on the key chain away from the coded key and restart the engine.

Anti-theft indicator

The anti-theft indicator is located in the instrument cluster.



Vehicles equipped with the SecuriLock™ Passive Anti-theft system behave as follows:

- When the ignition is in the 1(OFF/LOCK) position, the indicator will flash once every 2 seconds for a total of 10 seconds to indicate the SecuriLock™ system is functioning as a theft deterrent.
- When the ignition is in the 3 (ON) position, the indicator will glow for 3 seconds to indicate a programmed key has been validated and the SecuriLock™ Passive Anti-theft system has enabled the engine.

Vehicles without the SecuriLock™ Passive Anti-theft system behave as follows:

- When the ignition is in the 1 (OFF/LOCK) position, the indicator will not flash.
- When the ignition is in the 3 (ON) position, the indicator will glow for 3 seconds to indicate the engine is enabled.

Replacement keys

If your keys are lost or stolen and you don't have an extra coded key, you will need to have your vehicle towed to an authorized dealer. The key codes need to be erased from your vehicle and new coded keys will need to be programmed.

Replacing coded keys can be very costly. Store an extra programmed key away from the vehicle in a safe place to help prevent any inconveniences. Please visit an authorized dealer to purchase additional spare or replacement keys.

Programming spare keys

You can program your own coded keys to your vehicle. Please read and understand the entire procedure before you begin.

Tips:

- A maximum of eight keys can be coded to your vehicle.
- Only use SecuriLock™ keys.
- You must have two previously programmed coded keys (keys that already operate your vehicle's engine) and the new unprogrammed key(s) readily accessible.
- If no previously programmed coded keys are available, you must take your vehicle to your authorized dealer to have the spare key(s) programmed.

Locks and Security

1. Insert a previously programmed coded key into the ignition.
2. Turn the ignition from the 3 (OFF) position to the 4 (ON) position. Keep the ignition in the 4 (ON) position for at least one second, but no more than 10 seconds.
3. Turn the ignition to the 3 (OFF) position, and remove the coded key from the ignition.
4. Within ten seconds of removing the previously programmed coded key, insert the other previously programmed coded key into the ignition.
5. Turn the ignition from the 3 (OFF) position to the 4 (ON) position. Keep the ignition in the 4 (ON) position for at least one second but not more than 10 seconds.
6. Turn the ignition to the 3 (OFF) position, and remove the second key from the ignition.
7. Within twenty seconds of removing the previously programmed coded key, insert the unprogrammed key (new/valet key) into the ignition.
8. Turn the ignition from the 3 (OFF) position to the 4 (ON) position. Keep the ignition in the 4 (ON) position for at least one second.
9. Your new unprogrammed key is now programmed.

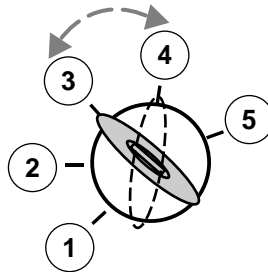

If the key has been successfully programmed it will start the vehicle's engine and the theft indicator light will illuminate for three seconds and then go out. If the key was not successfully programmed, it will not start your vehicle's engine and the theft indicator light will flash on and off rapidly. If failure repeats, bring your vehicle to your authorized dealer to have the new key(s) programmed.

To program additional new unprogrammed key(s), repeat this procedure from Step 1 for each additional key.

Seating and Safety Restraints

SEATING

Adjusting the front manual seat (if equipped)

WARNING: Never adjust the driver's seat or seatback when the vehicle is moving. The seat could slide too far leaving you unable to operate vital controls just when you need them.

WARNING: Always drive and ride with your seatback upright and the lap belt snug and low across the hips. Sitting in a reclined position while the vehicle is moving is dangerous because you cannot get the full protection from seat belts. During sudden braking or a collision, you can slide under the lap belt and suffer serious internal injuries. For maximum protection, sit well back and upright. The lap portion of the seat belt worn too high is dangerous. In a collision, this would concentrate the impact force directly on the abdominal area, causing serious injury. Wear the lap portion of the belt snugly and as low as possible.

WARNING: The passenger sitting improperly out of position or with the seat back reclined too far can take off weight from the seat cushion and affect the decision of the front passenger sensing system, resulting in serious injury or death in a crash. Always sit upright against your seatback, with your feet on the floor.

Lift the release bar to move seat forward or backward. Ensure that the seat is locked into place.

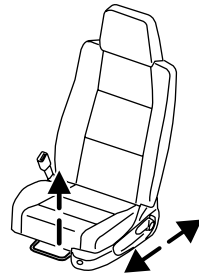

Seating and Safety Restraints

Pull lever located at the side of the seat cushion up to adjust seatback.

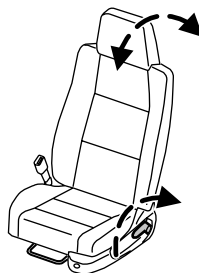

60/40 seat (if equipped)

To gain access to the storage compartment in your armrest (if equipped), lift the latch to open lid.

The 60/40 seat cupholder (if equipped) is detachable for cleaning.

- Firmly grasp the bottom of the cup holder and pull up.

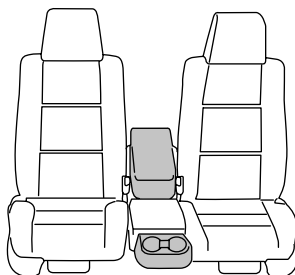

To re-attach:

- Slide the cupholder over the two pins located on the front of the 60% driver's seat.
- Press down until it is firmly latched into place.

Passenger side rear access (if equipped)

Pull up on the recliner handle. The seat will lean forward. Lift the release bar to move the seat forward to access the rear area of the cab.

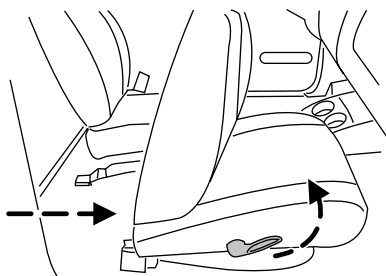

Seating and Safety Restraints

To return seat to original position, slide the seat bottom back, then push the seatback up to lock it in place. The seat will lock, and you will have to use the release bar to move the seat back to the original position.

REAR SEATS

Center facing jump seat (four-door Cab Plus 4) (if equipped)

To open, pull seat assembly down, then raise seatback.

To stow the seat, fold seat back down and raise seat assembly to the fully upright position.

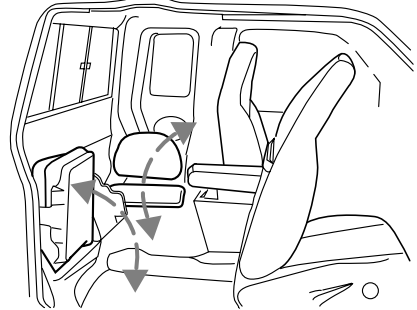

WARNING: Do not install a child seat in the center facing jump seats as there are no child restraints recommended for use in this seating position.

WARNING: Booster seats must be installed only in seating positions equipped with a combination lap/shoulder belt.

SAFETY RESTRAINTS

Personal Safety System™

The Personal Safety System™ provides an improved overall level of frontal crash protection to front seat occupants and is designed to help further reduce the risk of airbag-related injuries. The system is able to analyze different occupant classifications and conditions and crash severity before activating the appropriate safety devices to help better protect a range of occupants in a variety of frontal crash situations.

Your vehicle's Personal Safety System™ consists of:

- Driver and passenger dual-stage airbag supplemental restraints.
- Front outboard seat belts with pretensioners, energy management retractors, and seat belt usage sensors.
- Driver's seat position sensor.
- Front crash severity sensor.

Seating and Safety Restraints

- Front passenger sensing system
- Passenger Airbag Off indicator light.
- Restraints Control Module (RCM) with impact and safing sensors.
- Restraint system warning light and back-up tone.
- The electrical wiring for the airbags, crash sensor(s), seat belt pretensioners, front seat belt usage sensors, driver seat position sensor, and indicator lights.

How does the Personal Safety System™ work?

The Personal Safety System™ can adapt the deployment strategy of your vehicle's safety devices according to crash severity and occupant classification and conditions. A collection of crash and occupant sensors provides information to the Restraints Control Module (RCM). During a crash, the RCM activates the seat belt pretensioners and/or either none, one, or both stages of the dual-stage airbag supplemental restraints based on crash severity and occupant classification and conditions.

The fact that the pretensioners or airbags did not activate for both front seat occupants in a collision does not mean that something is wrong with the system. Rather, it means the Personal Safety System™ determined the accident conditions (crash severity, belt usage, etc.) were not appropriate to activate these safety devices. Front airbags and pretensioners are designed to activate only in frontal and near-frontal collisions, not rollovers, side-impacts, or rear-impacts unless the collision causes sufficient longitudinal deceleration.

Driver and passenger dual-stage airbag supplemental restraints

The dual-stage airbags offer the capability to tailor the level of airbag inflation energy. A lower, less forceful energy level is provided for more common, moderate-severity impacts. A higher energy level is used for the most severe impacts. Refer to *Airbag Supplemental Restraints* section in this chapter.

Front crash severity sensor

The front crash severity sensor enhances the ability to detect the severity of an impact. Positioned up front, it provides valuable information early in the crash event on the severity of the impact. This allows your Personal Safety System™ to distinguish between different levels of crash severity and modify the deployment strategy of the dual-stage airbags and seat belt pretensioners.

Seating and Safety Restraints

Driver's seat position sensor

The driver's seat position sensor allows your Personal Safety System™ to tailor the deployment level of the driver dual-stage airbag based on seat position. The system is designed to help protect smaller drivers sitting close to the driver airbag by providing a lower airbag output level.

Front passenger sensing system

For airbags to do their job they must inflate with great force, and this force can pose a potentially deadly risk to occupants that are very close to the airbag when it begins to inflate. For some occupants, like infants in rear-facing child seats, this occurs because they are initially sitting very close to the airbag. For other occupants, this occurs when the occupant is not properly restrained by seat belts or child safety seats and they move forward during pre-crash braking. The most effective way to reduce the risk of unnecessary injuries is to make sure all occupants are properly restrained. Accident statistics suggest that children are much safer when properly restrained in the rear seating positions than in the front.

WARNING: Air bags can kill or injure a child in a child seat. NEVER place a rear-facing child seat in front of an active air bag. If you must use a forward-facing child seat in the front seat, move the seat all the way back.

WARNING: Always transport children 12 years old and under in the back seat and always properly use appropriate child restraints.

The front passenger sensing system can automatically turn off the passenger front airbag when a rear facing child seat, a forward-facing child restraint, or a booster seat is detected. Even with this technology, parents are **STRONGLY** encouraged to always properly restrain children in the rear seat. The sensor also turns off the airbag when the passenger seat is empty to prevent unnecessary replacement of the airbag(s) after a collision.

When the front passenger seat is occupied and the sensing system has turned off the passenger's frontal airbag, the "pass airbag off" indicator will light and stay lit to remind you that the front passenger frontal airbag is off. See *Front passenger sensing system* in the *Airbag supplemental restraint system (SRS)* section of this chapter.

Seating and Safety Restraints

Front seat belt usage sensors

The front seat belt usage sensors detect whether or not the driver and front outboard passenger seat belts are fastened. This information allows your Personal Safety System™ to tailor the airbag deployment and seat belt pretensioner activation depending upon seat belt usage. Refer to *Seat belt usage sensors* later in this chapter.

Front outboard seat belt pretensioners

The seat belt pretensioners at the front outboard seating positions are designed to tighten the seat belts firmly against the occupant's body during frontal collisions. This helps increase the effectiveness of the seat belts. In frontal collisions, the seat belt pretensioners can be activated alone or, if the collision is of sufficient severity, together with the front airbags.

Front outboard seat belt energy management retractors

The front seat belt energy management retractors allow webbing to be pulled out of the retractor in a gradual and controlled manner in response to the occupant's forward momentum. This helps reduce the risk of force-related injuries to the occupant's chest by limiting the load on the occupant. Refer to *Energy management retractors* section in this chapter.

Determining if the Personal Safety System™ is operational

The Personal Safety System™ uses a warning light in the instrument cluster or a back-up tone to indicate the condition of the system. Refer to the *Warning lights and chimes* section in the *Instrument Cluster* chapter. Routine maintenance of the Personal Safety System™ is not required.

The Restraints Control Module (RCM) monitors its own internal circuits and the circuits for the airbag supplemental restraints, crash sensor(s), seat belt pretensioners, front seat belt buckle sensors, front passenger sensing system, and the driver seat position sensor. In addition, the RCM also monitors the restraints warning light in the instrument cluster. A difficulty with the system is indicated by one or more of the following.

- The warning light will either flash or stay lit.
- The warning light will not illuminate immediately after ignition is turned on.
- A series of five beeps will be heard. The tone pattern will repeat periodically until the problem and warning light are repaired.

Seating and Safety Restraints

If any of these things happen, even intermittently, have the Personal Safety System™ serviced at an authorized dealer immediately. Unless serviced, the system may not function properly in the event of a collision.

Safety restraints precautions

WARNING: Always drive and ride with your seatback upright and the lap belt snug and low across the hips.

WARNING: To reduce the risk of injury, make sure children sit where they can be properly restrained.

WARNING: Never let a passenger hold a child on his or her lap while the vehicle is moving. The passenger cannot protect the child from injury in a collision.

WARNING: Never adjust the driver's seat or seatback when the vehicle is moving. Adjusting the driver's seat while the vehicle is moving is dangerous. The driver could lose control of the vehicle and have an accident. Adjust the driver's seat only when the vehicle is stopped.

WARNING: It is extremely dangerous to ride in a cargo area, inside or outside of a vehicle. In a collision, people riding in these areas are more likely to be seriously injured or killed. Do not allow people to ride in any area of your vehicle that is not equipped with seats and seat belts. Be sure everyone in your vehicle is in a seat and using a seat belt properly.

WARNING: In a rollover crash, an unbelted person is significantly more likely to die than a person wearing a seat belt.

Seating and Safety Restraints

WARNING: Each seating position in your vehicle has a specific seat belt assembly which is made up of one buckle and one tongue that are designed to be used as a pair. 1) Use the shoulder belt on the outside shoulder only. Never wear the shoulder belt under the arm. 2) Never swing the seat belt around your neck over the inside shoulder. 3) Never use a single belt for more than one person.

WARNING: On Cab Plus 4 vehicles, do not open the rear door when the rear seat belt is still buckled.

Combination lap and shoulder belts

1. Insert the belt tongue into the proper buckle (the buckle closest to the direction the tongue is coming from) until you hear a snap and feel it latch. Make sure the tongue is securely fastened in the buckle.

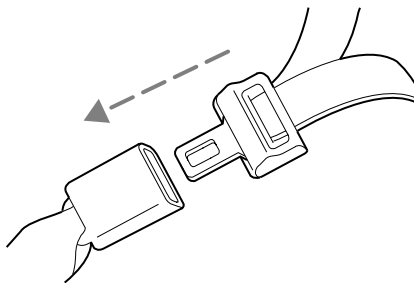

2. To unfasten, push the release button and remove the tongue from the buckle.

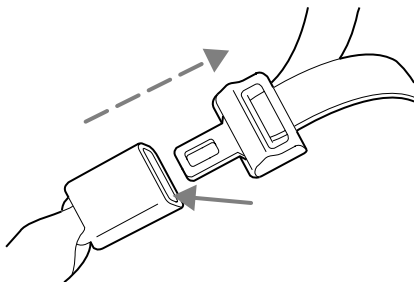

Adjusting the center and rear center facing jump seat lap belts

The lap belt does not adjust automatically.

Seating and Safety Restraints

WARNING: The lap belts should fit snugly and as low as possible around the hips, not around the waist. Failure to position the lap belt correctly may cause serious injury in an accident.

Insert the tongue into the correct buckle (the buckle closest to the direction the tongue is coming from). To lengthen the belt, turn the tongue at a right angle to the belt and pull across your lap until it reaches the buckle.

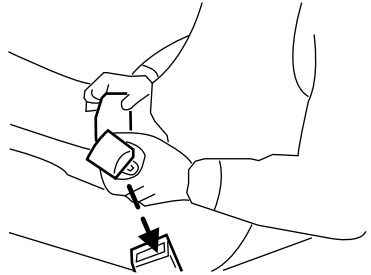

To tighten the belt, pull the loose end of the belt through the tongue until it fits snugly across the hips.

Shorten and fasten the belt when not in use to keep the belt away from door openings and available after unfolding the seats.

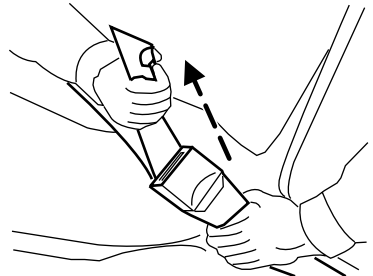

For the rear jump seat, shorten and fold the belt into the seat when not in use.

Energy Management Feature

- This vehicle has a seat belt system with an energy management feature at the front outboard seating positions to help further reduce the risk of injury in the event of a head-on collision.
- This energy management system has a retractor assembly that is designed to pay out webbing in a controlled manner. This feature is designed to help reduce the belt force acting on the occupant's chest.

The front outboard safety restraints in the vehicle are combination lap and shoulder belts. The front passenger outboard seat belt has two types of locking modes described below:

Vehicle sensitive mode

This is the normal retractor mode, which allows free shoulder belt length adjustment to your movements and locking in response to vehicle

Seating and Safety Restraints

movement. For example, if the driver brakes suddenly or turns a corner sharply, or the vehicle receives an impact of approximately 5 mph (8 km/h) or more, the combination seat belts will lock to help reduce forward movement of the driver and passengers.

Automatic locking mode (outboard front passenger seating position only) for use with child safety seats

In this mode, the shoulder belt is automatically pre-locked. The belt will still retract to remove any slack in the shoulder belt.

The automatic locking mode is not available on the driver seat belt.

When to use the automatic locking mode

- **Any time** a child safety seat is installed in a passenger front seat. Refer to *Safety Restraints for Children* or *Safety Seats for Children* later in this chapter.

How to use the automatic locking mode (Outboard front passenger seating position only) for use with child safety seats

- Buckle the combination lap and shoulder belt.

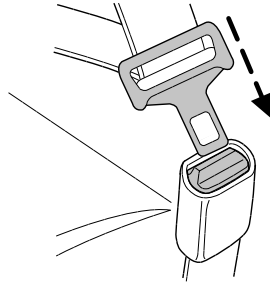

- Grasp the shoulder portion and pull downward until the entire belt is pulled out.



- Allow the belt to retract. As the belt retracts, you will hear a clicking sound. This indicates the seat belt is now in the automatic locking mode.

Seating and Safety Restraints

How to disengage the automatic locking mode

Disconnect the combination lap/shoulder belt and allow it to retract completely to disengage the automatic locking mode and activate the vehicle sensitive (emergency) locking mode.

WARNING: After any vehicle collision, the entire seat belt system should be checked for proper operation by an authorized dealer. Verify that the "automatic locking retractors" in all outboard seating positions are functioning properly. Additionally check that the "automatic locking mode" feature for child safety seat in the passenger outboard seating position is functioning properly.

WARNING: BELT AND RETRACTOR ASSEMBLY MUST BE REPLACED if the seat belt assembly "automatic locking retractor" feature or any other seat belt function is not operating properly when checked according to the procedures in Workshop Manual.

WARNING: Failure to replace the Belt and Retractor assembly could increase the risk of injury in collisions.

Seat belt pretensioner

Your vehicle is equipped with seat belt pretensioners at the driver and front outboard passenger seating positions.

The seat belt pretensioner is a device which removes excess webbing from the seat belt system. The seat belt pretensioner uses the same crash sensor system as the front airbag supplemental restraint system (SRS). When the seat belt pretensioner deploys, webbing from the lap and shoulder belt is tightened. Refer to the *Seat belt maintenance* section in this chapter.

WARNING: The driver and front passenger seat belt system (including retractors, buckles and height adjusters) must be replaced if the vehicle is involved in a collision that results in deployment of front airbags and seat belt pretensioners.

Front seat belt height adjustment

Your vehicle has seat belt height adjustments for the driver and front passenger. Adjust the height of the shoulder belt so the belt rests across the middle of your shoulder.

Seating and Safety Restraints

- Regular Cab and four-door Cab Plus 4

To lower the shoulder belt height, push the button and slide the height adjuster down. To raise the height of the shoulder belt, slide the height adjuster up. Pull down on the height adjuster to make sure it is locked in place.

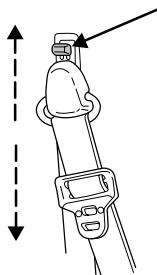

WARNING: Position the seat belt height adjusters so that the belt rests across the middle of your shoulder. Failure to adjust the seat belt properly could reduce the effectiveness of the seat belt and increase the risk of injury in a collision.

Seat belt extension assembly

If the seat belt is too short when fully extended, a 9 inch (23 cm) or 12 inch (31 cm) seat belt extension assembly can be added (part numbers 611C22-A and 611C22-B respectively). Seat belt extension assemblies can be obtained from your authorized Mazda dealership.

Use only extensions manufactured by the same supplier as the seat belt. Manufacturer identification is located at the end of the webbing on the label. Also, use the seat belt extension only if the seat belt is too short for you when fully extended.

When you are not using the extensions store them in another location so that no one will accidentally use them.

NOTE: Do not use extensions to change the fit of the shoulder belt across the torso.

Seat belt maintenance

Inspect the seat belt systems periodically to make sure they work properly and are not damaged.

NOTE: If unsure about the proper procedures, bring your vehicle to an authorized Mazda dealership for inspection. Inspect the seat belts to make sure there are no nicks, tears or cuts, replacing if necessary. Check the automatic locking retractor on the passenger outboard seating position. All seat belt assemblies, including retractors, buckles, front seat belt buckle assemblies, buckle support assemblies (slide bar-if equipped),

Seating and Safety Restraints

shoulder belt height adjusters (if equipped), shoulder belt guide on seatback (if equipped), child safety seat tether bracket assemblies (if equipped), and attaching hardware, should be inspected after a collision. Mazda recommends that all seat belt assemblies used in vehicles involved in a collision be replaced. However, if the collision was minor and an authorized Mazda technician finds that the belts do not show damage and continue to operate properly, they do not need to be replaced. Seat belt assemblies not in use during a collision should also be inspected and replaced if either damage or improper operation is noted.

The energy absorbing functions may have been activated in a collision so the restraints should be examined; if the front airbags have deployed, the pretensioners have also deployed and must be replaced — regardless of whether there was an occupant in the passenger seat or not.

WARNING: Failure to inspect and if necessary replace the seat belt assembly under the above conditions could result in severe personal injuries in the event of a collision.

Refer to *Interior* in the *Cleaning* chapter.

Seat belt warning light and indicator chime

The seat belt warning light illuminates in the instrument cluster and a chime sounds to remind the occupants to fasten their seat belts.

Conditions of operation

If...	Then...
The driver's seat belt is not buckled before the ignition switch is turned to the ON position...	The seat belt warning light illuminates 1-2 minutes and the warning chime sounds 4-8 seconds.
The driver's seat belt is buckled while the indicator light is illuminated and the warning chime is sounding...	The seat belt warning light and warning chime turn off.
The driver's seat belt is buckled before the ignition switch is turned to the ON position...	The seat belt warning light and indicator chime remain off.

Seating and Safety Restraints

Belt-Minder®

The Belt-Minder® feature is a supplemental warning to the seat belt warning function. This feature provides additional reminders by intermittently sounding a chime and illuminating the seat belt warning light in the instrument cluster when the driver's and front passenger's seat belt is unbuckled.

The Belt-Minder® feature uses information from the front passenger sensing system to determine if a front seat passenger is present and therefore potentially in need of a warning. To avoid activating the Belt-Minder® feature for objects placed in the front passenger seat, warnings will only be given to large front seat occupants as determined by the front passenger sensing system.

Both the driver's and passenger's seat belt usages are monitored and either may activate the Belt-Minder® feature. The warnings are the same for the driver and the front passenger. If the Belt-Minder® warnings have expired (warnings for approximately 5 minutes) for one occupant (driver or front passenger), the other occupant can still activate the Belt-Minder® feature.

If...	Then...
The driver's and front passenger's seat belts are buckled before the ignition switch is turned to the ON position or less than 1-2 minutes have elapsed since the ignition switch has been turned ON...	The Belt-Minder® feature will not activate.
The driver's or front passenger's seat belt is not buckled when the vehicle has reached at least 3 mph (5 km/h) and 1-2 minutes have elapsed since the ignition switch has been turned to ON...	The Belt-Minder® feature is activated - the seat belt warning light illuminates and the warning chime sounds for 6 seconds every 30 seconds, repeating for approximately 5 minutes or until the seat belts are buckled.

Seating and Safety Restraints

If...	Then...
The driver's or front passenger's seat belt becomes unbuckled for approximately 1 minute while the vehicle is traveling at least 3 mph (5 km/h) and more than 1-2 minutes have elapsed since the ignition switch has been turned to ON...	The Belt-Minder® feature is activated - the seat belt warning light illuminates and the warning chime sounds for 6 seconds every 30 seconds, repeating for approximately 5 minutes or until the seat belts are buckled.

The following are reasons most often given for not wearing seat belts (All statistics based on U.S. data):

Reasons given...	Consider...
"Crashes are rare events"	36,700 crashes occur every day. The more we drive, the more we are exposed to "rare" events, even for good drivers. <i>1 in 4 of us will be seriously injured in a crash during our lifetime.</i>
"I'm not going far"	3 of 4 fatal crashes occur within 25 miles of home.
"Belts are uncomfortable"	Seat belts are designed to enhance comfort. If you are uncomfortable - try different positions for the seat belt upper anchorage and seatback which should be as upright as possible; this can improve comfort.
"I was in a hurry"	Prime time for an accident. Seat Belt Warning Chime reminds us to take a few seconds to buckle up.
"Seat belts don't work"	Seat belts , when used properly, reduce risk of death to front seat occupants by 45% in cars , and by 60% in light trucks .
"Traffic is light"	Nearly 1 of 2 deaths occur in single-vehicle crashes , many when no other vehicles are around.
"Belts wrinkle my clothes"	Possibly, but a serious crash can do much more than wrinkle your clothes, particularly if you are unbelted.

Seating and Safety Restraints

Reasons given...	Consider...
"The people I'm with don't wear belts"	Set the example, teen deaths occur 4 times more often in vehicles with TWO or MORE people. Children and younger brothers/sisters imitate behavior they see.
"I have an airbag"	Airbags offer greater protection when used with seat belts. Frontal airbags are not designed to inflate in rear and side crashes or rollovers.
"I'd rather be thrown clear"	Not a good idea. People who are ejected are 40 times more likely to DIE. Seat belts help prevent ejection, WE CAN'T "PICK OUR CRASH".

WARNING: Always wear the seat belt. Do not be tempted to sit on top of the belt to fool police or to defeat the warning system. The seat belt and seat belt warning system are there to protect your life.

One time disable

If at any time the driver/front passenger quickly buckles then unbuckles the seat belt for that seating position, the Belt-Minder® is disabled for the current ignition cycle. The Belt-Minder® feature will enable during the same ignition cycle if the occupant buckles and remains buckled for approximately 30 seconds. Confirmation is not given for the one time disable.

Deactivating/activating the Belt-Minder® feature

The driver and front passenger Belt-Minder® are deactivated/activated independently. When deactivating/activating one seating position, do not buckle the other position as this will terminate the process.

Read Steps 1 - 4 thoroughly before proceeding with the deactivation/activation programming procedure.

Note: The driver and front passenger Belt-Minder® features must be disabled/enabled separately. Both cannot be disabled/enabled during the same key cycle.

The driver and front passenger Belt-Minder® features can be deactivated/activated by performing the following procedure:

Before following the procedure, make sure that:

Seating and Safety Restraints

- The parking brake is set
- The gearshift is in P (Park) (automatic transmission)
- The ignition switch is in the OFF position
- The driver and front passenger seat belts are unbuckled

WARNING: While the design allows you to deactivate your Belt-Minder®, this system is designed to improve your chances of being safely belted and surviving an accident. We recommend you leave the Belt-Minder® system activated for yourself and others who may use the vehicle. To reduce the risk of injury, do not deactivate/activate the Belt-Minder® feature while driving the vehicle.

1. Turn the ignition switch to the RUN (or ON) position. (DO NOT START THE ENGINE)
 2. Wait until the seat belt warning light turns off. (Approximately 1 minute)
- Step 3 must be completed within 50 seconds after the seat belt warning light turns off.
 - 3. For the seating position being disabled, at a moderate speed, buckle then unbuckle the seat belt 9 times, ending in the unbuckled state. (Step 3 must be completed within 50 seconds after the seat belt warning light turns off.)
 - After Step 3, the seat belt warning light will be turned on for three seconds.
 - 4. Within approximately 7 seconds of the light turning off, buckle then unbuckle the seat belt.
 - This will disable the Belt-Minder® feature for that seating position if it is currently enabled. As confirmation, the seat belt warning light will flash 4 times per second for 3 seconds.
 - This will enable the Belt-Minder® feature for that seating position if it is currently disabled. As confirmation, the seat belt warning light will flash 4 times per second for 3 seconds, followed by 3 seconds with the light off, then followed by the seat belt warning light flashing 4 times per second for 3 seconds again.

Seating and Safety Restraints

AIRBAG SUPPLEMENTAL RESTRAINT SYSTEM (SRS)

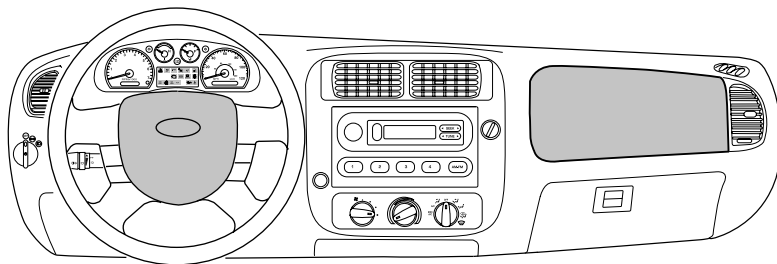

The airbag supplemental restraint system is designed to work in conjunction with the seat belts to help protect the driver and front outboard passenger from certain upper body injuries. The term “supplemental restraint” means the airbags are intended as a supplement to the seat belts. Airbags alone cannot protect as well as airbags plus seat belts in impacts for which the airbags are designed to deploy, and airbags do not offer any protection in crashes for which they do not deploy.

The airbag supplemental restraint system consists of:

- driver and passenger dual stage airbag modules (which include the inflators and airbags).
- one or more impact and safing sensors.
- the same indicator light, RCM (restraints control module) and diagnostic unit used for the Personal safety system.
- Front passenger sensing system
- Passenger airbag off indicator light.

The airbag supplemental restraints are an integral part of the Personal Safety System. They are designed to be deployed in cases where the Personal Safety System has determined the occupant conditions and crash severity are appropriate to activate these devices. Refer to the *Personal Safety System* section in this chapter.

Important supplemental restraint system (SRS) precautions

The supplemental restraint system is designed to work with the seat belt to help protect the driver and right front passenger from certain upper body injuries.

Seating and Safety Restraints

WARNING: Airbags DO NOT inflate slowly or gently and the risk of injury from a deploying airbag is greatest close to the trim covering the airbag module. Always wear your seat belt.

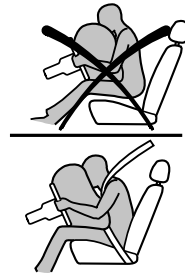

WARNING: Airbags have been known to kill or injure a child in front facing child restraints. When placing a child safety seat in a front seating position including the center (if equipped), you should make sure that the passenger airbag is off. If the child safety seat is in the outboard seating position, slide the seat all the way back.

WARNING: Do not install a child seat in a center facing jump seat.

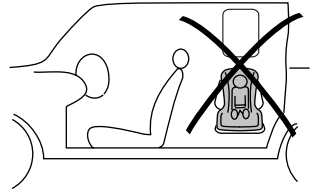

WARNING: Rear facing child seats should NEVER be placed in front of an active airbag.



WARNING: All occupants of the vehicle, including the driver, should always properly wear their seat belts, even when an air bag supplemental restraint system (SRS) is provided.

Seating and Safety Restraints

WARNING: National Highway Traffic Safety Administration (NHTSA) recommends a minimum distance of at least 25 cm (10 inches) between an occupant's chest and the driver air bag module.

WARNING: Never place your arm or feet over the airbag module as a deploying airbag can result in serious arm fractures or other injuries.

Steps you can take to properly position yourself away from the airbag:

- Move your seat to the rear as far as you can while still reaching the pedals comfortably.
- Recline the seat slightly (one or two degrees) from the upright position.

WARNING: Do not put anything on or over the airbag module including hands or feet. Placing objects on or over the airbag inflation area may cause those objects to be propelled by the airbag into your face and torso causing serious injury.

WARNING: Do not attempt to service, repair, or modify the Airbag Supplemental Restraint System or its fuses. See your authorized Mazda dealership.

WARNING: Modifications to the front end of the vehicle, including frame, bumper, front end body structure, tow hooks and snow plows may effect the performance of the airbag sensors increasing the risk of injury. Do not modify the front end of the vehicle.

WARNING: Additional equipment may effect the performance of the airbag sensors increasing the risk of injury. Consult your authorized Mazda dealership before installation of additional equipment.

WARNING: The front passenger airbag is not designed to offer protection to an occupant in the center front seating position.

Seating and Safety Restraints

Children and airbags

For additional important safety information, read all information on safety restraints in this guide.

WARNING: Do not install a child seat in a center facing jump seat.

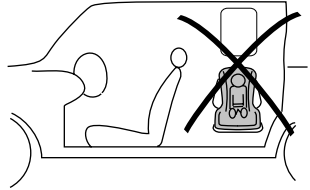

WARNING: Airbags can kill or injure a child in a child seat. NEVER place a rear-facing child seat in front of an active airbag. If you must use a forward-facing child seat in the front seat, move the seat all the way back.

WARNING: Booster seats must be installed only in seating positions equipped with a combination lap/shoulder belt.

WARNING: To reduce the risk of injury, make sure children sit where they can be properly restrained.

How does the airbag supplemental restraint system work?

The airbag SRS is designed to activate when the vehicle sustains sufficient longitudinal deceleration.

The fact that the airbags did not inflate in a collision does not mean that something is wrong with the system. Rather, it means the forces were not of the type sufficient to cause activation. Airbags are designed to inflate in frontal and near-frontal collisions, not rollover, side-impact, or rear-impacts.

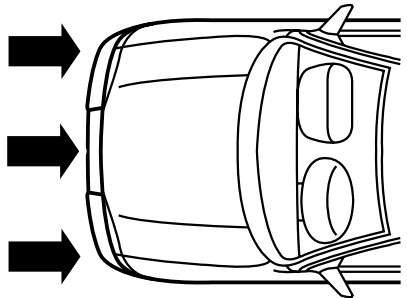

Seating and Safety Restraints

The airbags inflate and deflate rapidly upon activation. After airbag deployment, it is normal to notice a smoke-like, powdery residue or smell the burnt propellant. This may consist of cornstarch, talcum powder (to lubricate the bag) or sodium compounds (e.g., baking soda) that result from the combustion process that inflates the airbag. Small amounts of sodium hydroxide may be present which may irritate the skin and eyes, but none of the residue is toxic.



While the system is designed to help reduce serious injuries, it may also cause minor abrasions, swelling or temporary hearing loss. Because airbags must inflate rapidly and with considerable force, there is the risk of death or serious injuries such as fractures, facial and eye injuries or internal injuries, particularly to occupants who are not properly restrained or are otherwise out of position at the time of airbag deployment. Thus, it is extremely important that occupants be properly restrained as far away from the airbag module as possible while maintaining vehicle control.

WARNING: Several airbag system components get hot after inflation. Do not touch them after inflation or you may be burned.

WARNING: If the air bag has deployed, the air bag will not function again and must be replaced immediately. If the air bag is not replaced, the unrepaired area will increase the risk of injury in a collision.

Determining if the system is operational

The SRS uses readiness lights in the instrument cluster or a tone to indicate the condition of the system. Refer to the *Airbag readiness* section in the *Instrumentation* chapter. Routine maintenance of the airbag is not required.

Seating and Safety Restraints

A difficulty with the system is indicated by one or more of the following:

- The readiness lights will either flash or stay lit.
- The readiness lights will not illuminate immediately after ignition is turned on.
- A series of five beeps will be heard. The tone pattern will repeat periodically until the problem and/or light are repaired.



If any of these things happen, even intermittently, have the SRS serviced at your authorized Mazda dealership immediately.

WARNING: Unless serviced, the system may not function properly in the event of a collision.

Disposal of airbags and airbag equipped vehicles (including seat belt pretensioners)

For disposal of seat belt pretensioners, airbags, or airbag equipped vehicles, see your authorized Mazda dealership or qualified technician. Airbags **MUST BE** disposed of by qualified personnel.

Front passenger sensing system

The front passenger sensing system will turn off the front passenger's frontal air bag under certain conditions. The driver's frontal air bag is not part of the front passenger sensing system. The front passenger sensing system works with sensors that are part of the front passenger's seat and seat belt. The sensors are designed to detect the presence of a properly seated occupant and determine if the front passenger's frontal air bag should be enabled (may inflate) or not.

The front passenger sensing system is designed to meet the regulatory requirements of Federal Motor Vehicle Safety Standard (FMVSS) 208 and is designed to turn off the front passenger's frontal air bag if:

- the front passenger seat is unoccupied, or has small/medium objects in the front seat,
- the system determines that a small child is present in a rear-facing child seat that is installed according to the manufacturer's instructions.
- the system determines that a small child is present in a forward-facing child restraint that is installed according to the manufacturer's instructions,

Seating and Safety Restraints

- the system determines that a small child is present in a booster seat,
- a front passenger takes his/her weight off of the seat for a period of time,

WARNING: Even with Advanced Restraints Systems, children 12 and under should be properly restrained in the back seat (if equipped).

When the front passenger seat is occupied and the sensing system has turned off the passenger's frontal air bag, the "passenger air bag off" or "pass air bag off" indicator will light and stay lit to remind you that the front passenger frontal air bag is off. When the front passenger seat is not occupied (empty seat) or in the event that the front passenger frontal air bag is enabled (may inflate), the indicator light will be unlit.

The indicator light is located in the center stack of the instrument panel. To confirm the "pass airbag light" is functional, it will momentarily illuminate when the ignition is turned to the ON position.



The front passenger sensing system is designed to turn off the front passenger's frontal air bag when a rear facing child seat, a forward-facing child restraint, or a booster seat is detected. If the child restraint has been installed and the indicator is not lit, then turn the vehicle off, remove the child restraint from the vehicle and reinstall the restraint following the child restraint manufacturer's directions.

The front passenger sensing system is designed to enable (may inflate) the right front passenger's frontal air bag anytime the system senses that a person of adult size is sitting properly in the front passenger seat. When the passenger sensing system has allowed the air bag to be enabled, the indicator will be unlit and stay unlit to remind you that the air bag is enabled (may inflate).

If a person of adult-size is sitting in the front passenger's seat, but the "passenger air bag off" or "pass air bag off" indicator is lit, it could be that the person isn't sitting properly in the seat. If this happens, turn the vehicle off and ask the person to place the seatback in the full upright position, then sit upright in the seat, centered on the seat cushion, with the person's legs comfortably extended. Restart the vehicle and have the person remain in this position for about two minutes. This will allow the system to detect that person and then enable the passenger's air bag. If

Seating and Safety Restraints

the indicator lamp remains lit even after this, then the occupant should be advised to ride in the back seat.

Occupant	Pass Airbag Off Indicator Lamp	Passenger Airbag
Empty seat	Unlit	Disabled
Small child in child safety seat or booster	Lit	Disabled
Small child with seat belt buckled or unbuckled	Lit	Disabled
Adult	Unlit	Enabled

After all occupants have adjusted their seats and put on seat belts, it's very important that they continue to sit upright, with their back against the seatback, with their feet comfortably extended on the floor while the vehicle is still in motion. Sitting improperly can increase the chance of injury in a crash event. For example, if an occupant slouches, lies down, turns sideways, sits forward, leans forward or sideways, or puts one or both feet up, the chance of injury during a crash is greatly increased.

WARNING: Sitting improperly out of position or with the seat back reclined too far can take off weight from the seat cushion and affect the decision of the front passenger sensing system, resulting in serious injury or death in a crash. Always sit upright against your seatback, with your feet on the floor.

In case there is a problem with the passenger sensing system, the airbag readiness lamp in the instrument cluster will stay lit. Do



NOT attempt to repair or service the system; take your vehicle immediately to the dealer.

WARNING: The front passenger airbag is not designed to offer protection to an occupant in the center seating position.

WARNING: An out of position front center occupant could affect the decision of the front passenger sensing system.

Seating and Safety Restraints

If it is necessary to modify an advanced front airbag system to accommodate a person with disabilities, contact the Mazda Customer Relationship Center at the phone number shown in the Customer Assistance section of this Owner's Manual.

The front passenger sensing system may detect small or medium objects placed on the seat cushion. For most objects that are in the front passenger seat, the passenger airbag will be disabled. Even though the passenger airbag is disabled, the "pass airbag off" light may or may not be illuminated according to the table below.

Objects	Pass Airbag Off Indicator Lamp	Passenger Airbag
Small (i.e. 3 ring binder, small purse, bottled water)	Unlit	Disabled
Medium (i.e. heavy briefcase, fully packed luggage)	Lit	Disabled
Empty seat, or small to medium object with seat belt buckled	Lit	Disabled

WARNING: Any alteration/modification to the front passenger seat may affect the performance of the front passenger sensing system.

SAFETY RESTRAINTS FOR CHILDREN

See the following sections for directions on how to properly use safety restraints for children. Also see *Airbag supplemental restraint system (SRS)* in this chapter for special instructions about using airbags.

Important child restraint precautions

NOTE: You are required by law to use a child-restraint system in the U.S. and Canada. Many states require that children use approved booster seats until they are eight years old. Check your local and state or provincial laws for specific requirements regarding the safety of children in your vehicle.

WARNING: Never let a passenger hold a child on his or her lap while the vehicle is moving. The passenger cannot protect the child from injury in a collision.

Seating and Safety Restraints

NOTE: Always follow the instructions and warnings that come with any infant or child restraint you might use.

WARNING: Do not install a child seat in a center facing jump seat.

Children and seat belts

If the child is the proper size, restrain the child in a safety seat.

Children who are too large for child safety seats (as specified by your child safety seat manufacturer) should always wear seat belts.

Follow all the important safety restraint and airbag precautions that apply to adult passengers in your vehicle.

If the shoulder belt portion of a combination lap and shoulder belt can be positioned so it does not cross or rest in front of the child's face or neck, the child should wear the lap and shoulder belt. Moving the child closer to the center of the vehicle may help provide a good shoulder belt fit.

WARNING: Do not leave children, unreliable adults, or pets unattended in your vehicle. Leaving a child or an animal unattended in a parked vehicle is dangerous. In hot weather, temperatures inside a vehicle can become high enough to cause brain damage or even death. Always take all children and animals with you or leave a responsible person with them. Leaving children in a vehicle with the ignition key is dangerous. This could result in someone being badly injured or even killed. They could play with power windows or other controls, or even make the vehicle move. Don't leave the keys in your vehicle with children.

Seating and Safety Restraints

Child booster seats

Children outgrow a typical convertible or toddler seat when they weigh 40 pounds and are around 4 years of age. Although the lap/shoulder belt will provide some protection, these children are still too small for lap/shoulder belts to fit properly, which could increase the risk of serious injury.

To improve the fit of both the lap and shoulder belt on children who have outgrown child safety seats, Mazda recommends use of a belt-positioning booster seat.

Booster seats position a child so that seat belts fit better. They lift the child up so that the lap belt rests low across the hips and the knees bend comfortably. Booster seats also make the shoulder belt fit better and more comfortably for growing children.

When children should use booster seats

Children need to use booster seats from the time they outgrow the toddler seat until they are big enough for the vehicle seat and lap/shoulder belt to fit properly. Generally this is when they weigh about 80 lb. (about 8 to 12 years old).

Booster seats should be used until you can answer YES to ALL of these questions:

- Can the child sit all the way back against the vehicle seat back with knees bent comfortably at the edge of the seat without slouching?

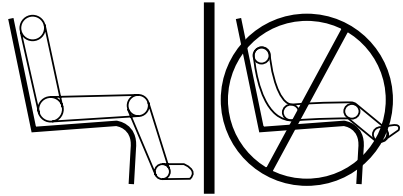

- Does the lap belt rest low across the hips?
- Is the shoulder belt centered on the shoulder and chest?
- Can the child stay seated like this for the whole trip?

WARNING: Booster seats must be installed only in seating positions equipped with a combination lap/shoulder belt.

Types of booster seats

There are two types of belt-positioning booster seats:

- Those that are backless.

If your backless booster seat has a removable shield, remove the shield and use the lap/shoulder belt. If a seating position has a low seat back and no head restraint, a backless booster seat may place your child's head (top of ear level) above the top of the seat. In this case, use a high-backed booster seat.



- Those with a high back.

If, with a backless booster seat, you cannot find a seating position that adequately supports your child's head, a high back booster seat would be a better choice.



Both can be used in any vehicle in a seating position equipped with lap/shoulder belts if your child is over 40 lb..

Seating and Safety Restraints

Children and booster seats vary widely in size and shape. Choose a booster that keeps the lap belt low and snug across the hips, never up across the stomach, and lets you adjust the shoulder belt to cross the chest and rest snugly near the center of the shoulder. The drawings below compare the ideal fit (center) to a shoulder belt uncomfortably close to the neck and a shoulder belt that could slip off the shoulder.

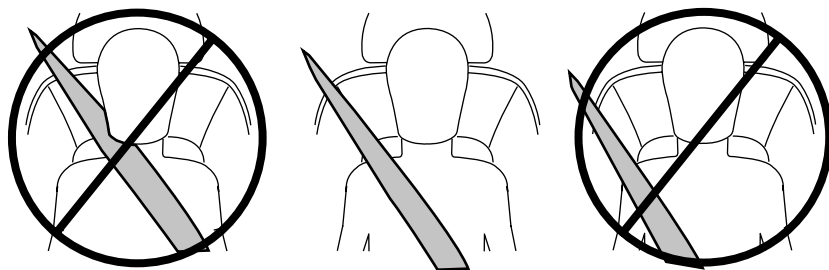

If the booster seat slides on the vehicle seat, placing a rubberized mesh sold as shelf or carpet liner under the booster seat may improve this condition.

The importance of shoulder belts

Using a booster without a shoulder belt increases the risk of a child's head hitting a hard surface in a collision. For this reason, you should never use a booster seat with a lap belt only. It is best to use a booster seat with combination lap/shoulder belts.

WARNING: Follow all instructions provided by the manufacturer of the booster seat.

WARNING: Never put the shoulder belt under a child's arm or behind the back because it eliminates the protection for the upper part of the body and may increase the risk of injury or death in a collision.

WARNING: Never use pillows, books, or towels to boost a child. They can slide around and increase the likelihood of injury or death in a collision.

SAFETY SEATS FOR CHILDREN

Child and infant or child safety seats

Use a safety seat that is recommended for the size and weight of the child. Carefully follow all of the manufacturer's instructions with the safety seat you put in your vehicle. If you do not install and use the safety seat properly, the child may be injured in a sudden stop or collision.

When installing a child safety seat:

- Review and follow the information presented in the *Airbag Supplemental Restraint System* section in this chapter.
- Use the correct seat belt buckle for that seating position (the buckle closest to the direction the tongue is coming from).
- Insert the belt tongue into the proper buckle until you hear a snap and feel it latch. Make sure the tongue is securely fastened in the buckle.

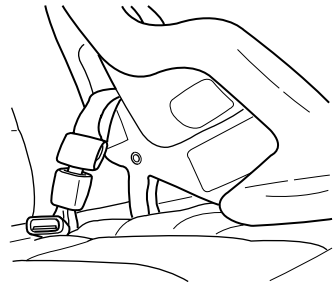

WARNING: Do not install a child seat in a center facing jump seat.

- Keep the buckle release button pointing up and away from the safety seat, with the tongue between the child seat and the release button, to prevent accidental unbuckling.
- Place seat back in upright position.
- Put the seat belt in the automatic locking mode. Refer to *Automatic locking mode* (passenger side front seat).
- Top tether anchors can be used for children up to 60 pounds (27 kg) in a child restraint, and to provide upper torso restraint for children up to 80 pounds (36 kg) using an upper torso harness and a belt-positioning booster.

Mazda recommends the use of a child safety seat having a top tether strap. Install the child safety seat in a seating position which is capable of providing a tether anchorage. For more information on top tether straps, refer to *Attaching child safety seats with tether straps*.

Seating and Safety Restraints

WARNING: Carefully follow all of the manufacturer's instructions included with the safety seat you put in your vehicle. If you do not install and use the safety seat properly, the child may be injured in a sudden stop or collision.

Installing child safety seats with combination lap and shoulder belts (front outboard passenger seat only)

1. Position the child safety seat in a seat with a combination lap and shoulder belt.

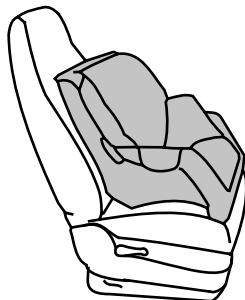

WARNING: If there is a tether on the child safety seat, attach it to the tether anchor point. Refer to *Attaching child safety seats with tether straps* in this chapter.

WARNING: Rear facing child seats should NEVER be placed in front of an active airbag.

2. Pull down on the shoulder belt and then grasp the shoulder belt and lap belt together.

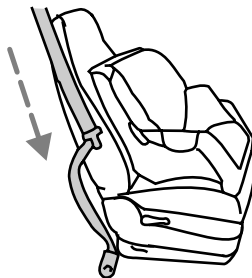

Seating and Safety Restraints

3. While holding the shoulder and lap belt portions together, route the tongue through the child seat according to the child seat manufacturer's instructions. Be sure the belt webbing is not twisted.

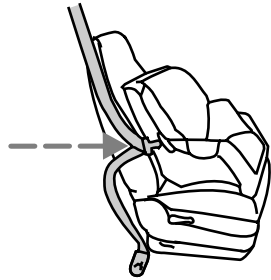

4. Insert the belt tongue into the proper buckle (the buckle closest to the direction the tongue is coming from) for that seating position until you hear and feel the latch engage. Make sure the tongue is latched securely by pulling on it.

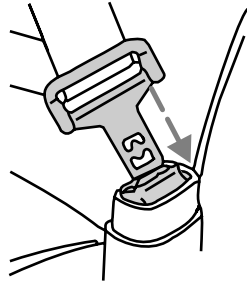

5. To put the retractor in the automatic locking mode, grasp the shoulder portion of the belt and pull downward until all of the belt is extracted and a click is heard.

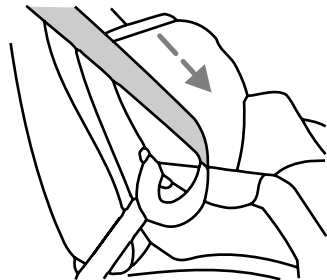

6. Allow the belt to retract. The belt will click as it retracts to indicate it is in the automatic locking mode.

Seating and Safety Restraints

7. Pull the lap belt portion across the child seat toward the buckle and pull up on the shoulder belt while pushing down with knee on the child seat.

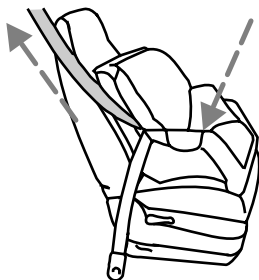

8. Allow the seat belt to retract to remove any slack in the belt.
9. Before placing the child in the seat, forcibly tilt the seat forward and back to make sure the seat is securely held in place. To check this, grab the seat at the belt path and attempt to move it side to side and forward. There should be no more than one inch of movement for proper installation.

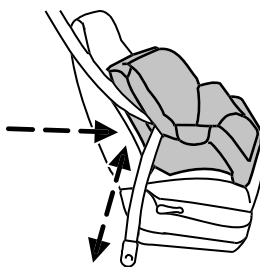

10. Try to pull the belt out of the retractor to make sure the retractor is in the automatic locking mode (you should not be able to pull more belt out). If the retractor is not locked, unbuckle the belt and repeat Steps two through nine.
11. See *Attaching child safety seats with tether straps* in this chapter. Check to make sure the child seat is properly secured before each use.

Attaching child safety seats with tether straps

Most new forward-facing child safety seats include a tether strap which goes over the back of the seat and hooks to an anchoring point. Tether straps are available as an accessory for many older safety seats. Contact the manufacturer of your child seat for information about ordering a tether strap.

The tether anchors in your vehicle are located on the back of the front seat cushion.

Seating and Safety Restraints

The tether strap anchors in your vehicle are in the following positions (shown from top view):

- **Bucket seats**

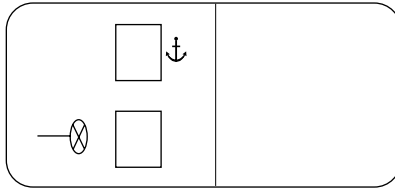

- **60/40 seats**

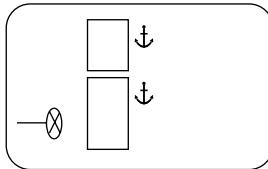

WARNING: Attach the tether strap only to the appropriate tether anchor as shown. The tether strap may not work properly if attached somewhere other than the correct tether anchor.

WARNING: Never attach two child safety seat tethers to a single tether anchor. In a crash, an anchor may not be strong enough to hold two child safety seat attachments and may break, causing serious injury or death.

1. Position the child safety seat on the front seat cushion.
2. Route the child safety seat tether strap over the back of the seat.

Seating and Safety Restraints

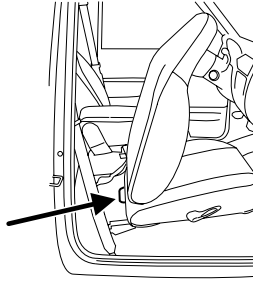

3. Locate the correct anchor for the selected seating position.

The tether anchor is located on the rear lower portion of the passenger seat.

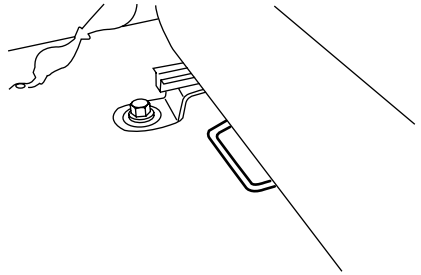

4. Clip the tether strap to the anchor.

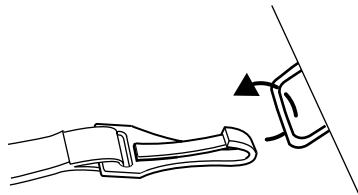

WARNING: If the tether strap is clipped incorrectly, the child safety seat may not be retained properly in the event of a collision.

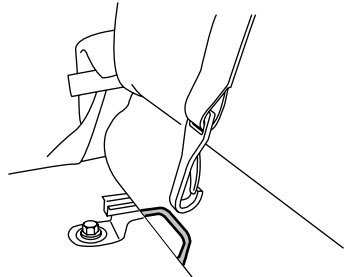

Seating and Safety Restraints

Center seating location 60/40 seats with folding armrest

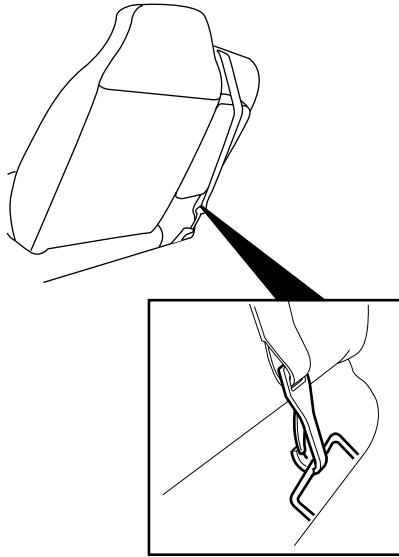

When installing a child safety seat in the center position, route the tether strap over the center arm rest and clip it to the center anchor.

WARNING: If the tether strap is clipped incorrectly, the child safety seat may not be retained properly in the event of a collision.

5. Refer to the *Installing child safety seats in combination lap and shoulder belt seating positions* section of this chapter for further instructions to secure the child safety seat.
6. Tighten the child safety seat tether strap according to the manufacturer's instructions.

WARNING: If the safety seat is not anchored properly, the risk of a child being injured in a collision greatly increases.

Tires, Wheels and Loading

NOTICE TO UTILITY VEHICLE AND TRUCK OWNERS

Utility vehicles and trucks handle differently than passenger cars in the various driving conditions that are encountered on streets, highways and off-road. Utility vehicles and trucks are not designed for cornering at speeds as high as passenger cars any more than low-slung sports cars are designed to perform satisfactorily under off-road conditions.

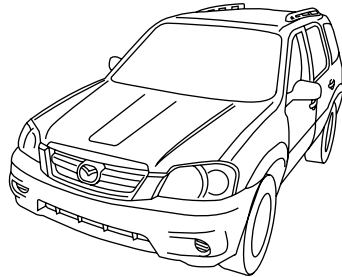

WARNING: Utility vehicles have a significantly higher rollover rate than other types of vehicles. To reduce the risk of serious injury or death from a rollover or other crash you must:

- Avoid sharp turns and abrupt maneuvers;
- Drive at safe speeds for the conditions;
- Keep tires properly inflated;
- Never overload or improperly load your vehicle; and
- Make sure every passenger is properly restrained.

WARNING: In a rollover crash, an unbelted person is significantly more likely to die than a person wearing a seat belt. All occupants must wear seat belts and children/infants must use appropriate restraints to minimize the risk of injury or ejection.

Study your *Owner's Manual* and any supplements for specific information about equipment features, instructions for safe driving and additional precautions to reduce the risk of an accident or serious injury.

VEHICLE CHARACTERISTICS

4WD and AWD Systems (if equipped)

A vehicle equipped with AWD or 4WD (when selected) has the ability to use all four wheels to power itself. This increases traction which may enable you to safely drive over terrain and road conditions that a conventional two-wheel drive vehicle cannot.

Tires, Wheels and Loading

Power is supplied to all four wheels through a transfer case or power transfer unit. 4WD vehicles allow you to select different drive modes as necessary. Information on transfer case operation and shifting procedures can be found in the *Driving* chapter. Information on transfer case maintenance can be found in the *Maintenance and Specifications* chapter. You should become thoroughly familiar with this information before you operate your vehicle.

On some 4WD models, the initial shift from two-wheel drive to 4WD while the vehicle is moving can cause a momentary clunk and ratcheting sound. These sounds are normal as the front drivetrain comes up to speed and is not cause for concern.

WARNING: Do not become overconfident in the ability of 4WD and AWD vehicles. Although a 4WD or AWD vehicle may accelerate better than two-wheel drive vehicle in low traction situations, it won't stop any faster than two-wheel drive vehicles. Always drive at a safe speed.

How your vehicle differs from other vehicles

SUV and trucks can differ from some other vehicles in a few noticeable ways. Your vehicle may be:

- Higher – to allow higher load carrying capacity and to allow it to travel over rough terrain without getting hung up or damaging underbody components.
- Shorter – to give it the capability to approach inclines and drive over the crest of a hill without getting hung up or damaging underbody components. All other things held equal, a shorter wheelbase may make your vehicle quicker to respond to steering inputs than a vehicle with a longer wheelbase.

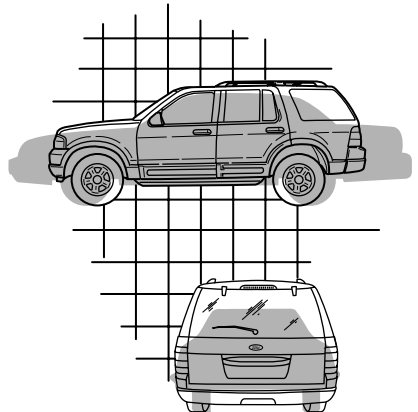

Tires, Wheels and Loading

- Narrower — to provide greater maneuverability in tight spaces, particularly in off-road use.

As a result of the above dimensional differences, SUV's and trucks often will have a higher center of gravity and a greater difference in center of gravity between the loaded and unloaded condition.

These differences that make your vehicle so versatile also make it handle differently than an ordinary passenger car.

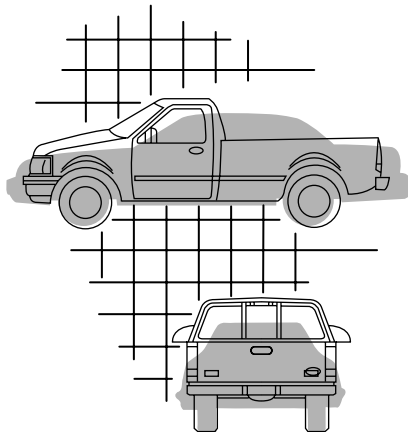

INFORMATION ABOUT UNIFORM TIRE QUALITY GRADING

New vehicles are fitted with tires that have a rating on them called Tire Quality Grades. The Quality grades can be found where applicable on the tire sidewall between tread shoulder and maximum section width. For example:

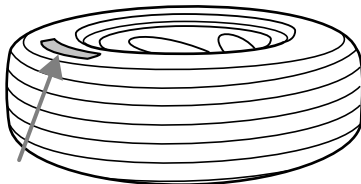

- **Treadwear 200 Traction AA Temperature A**

These Tire Quality Grades are determined by standards that the United States Department of Transportation has set.

Tire Quality Grades apply to new pneumatic tires for use on passenger cars. They do not apply to deep tread, winter-type snow tires, space-saver or temporary use spare tires, tires with nominal rim diameters of 10 to 12 inches or limited production tires as defined in Title 49 Code of Federal Regulations Part 575.104(c)(2).

U.S. Department of Transportation-Tire quality grades: The U.S. Department of Transportation requires Mazda to give you the following information about tire grades exactly as the government has written it.

Treadwear

The treadwear grade is a comparative rating based on the wear rate of the tire when tested under controlled conditions on a specified government test course. For example, a tire graded 150 would wear one and one-half (1 1/2) times as well on the government course as a tire graded 100. The relative performance of tires depends upon the actual conditions of their use, however, and may depart significantly from the norm due to variations in driving habits, service practices, and differences in road characteristics and climate.

Traction AA A B C

The traction grades, from highest to lowest are AA, A, B, and C. The grades represent the tire's ability to stop on wet pavement as measured under controlled conditions on specified government test surfaces of asphalt and concrete. A tire marked C may have poor traction performance.

NOTE: The traction grade assigned to this tire is based on straight-ahead braking traction tests, and does not include acceleration, cornering, hydroplaning or peak traction characteristics.

Temperature A B C

The temperature grades are A (the highest), B, and C, representing the tire's resistance to the generation of heat and its ability to dissipate heat when tested under controlled conditions on a specified indoor laboratory test wheel. Sustained high temperature can cause the material of the tire to degenerate and reduce tire life, and excessive temperature can lead to sudden tire failure. The grade C corresponds to a level of performance which all passenger car tires must meet under the Federal Motor Vehicle Safety Standard No. 139. Grades B and A represent higher levels of performance on the laboratory test wheel than the minimum required by law.

WARNING: The temperature grade for this tire is established for a tire that is properly inflated and not overloaded.

Excessive speed, underinflation, or excessive loading, either separately or in combination, can cause heat buildup and possible tire failure.

TIRES

Tires are designed to give many thousands of miles of service, but they must be maintained in order to get the maximum benefit from them.

Tires, Wheels and Loading

Glossary of tire terminology

- **Tire label:** A label showing the OE (Original Equipment) tire sizes, recommended inflation pressure and the maximum weight the vehicle can carry.
- **Tire Identification Number (TIN):** A number on the sidewall of each tire providing information about the tire brand and manufacturing plant, tire size and date of manufacture. Also referred to as DOT code.
- **Inflation pressure:** A measure of the amount of air in a tire.
- **Standard load:** A class of P-metric or Metric tires designed to carry a maximum load at 35 psi [37 psi (2.5 bar) for Metric tires]. Increasing the inflation pressure beyond this pressure will not increase the tire's load carrying capability.
- **Extra load:** A class of P-metric or Metric tires designed to carry a heavier maximum load at 41 psi [43 psi (2.9 bar) for Metric tires]. Increasing the inflation pressure beyond this pressure will not increase the tire's load carrying capability.
- **kPa:** Kilopascal, a metric unit of air pressure.
- **PSI:** Pounds per square inch, a standard unit of air pressure.
- **Cold inflation pressure:** The tire pressure when the vehicle has been stationary and out of direct sunlight for an hour or more and prior to the vehicle being driven for 1 mile (1.6 km).
- **Recommended inflation pressure:** The cold inflation pressure found on the Safety Compliance Certification Label or Tire Label located on the B-Pillar or the edge of the driver's door.
- **B-pillar:** The structural member at the side of the vehicle behind the front door.
- **Bead area of the tire:** Area of the tire next to the rim.
- **Sidewall of the tire:** Area between the bead area and the tread.
- **Tread area of the tire:** Area of the perimeter of the tire that contacts the road when mounted on the vehicle.
- **Rim:** The metal support (wheel) for a tire or a tire and tube assembly upon which the tire beads are seated.

INFLATING YOUR TIRES

Safe operation of your vehicle requires that your tires are properly inflated. Remember that a tire can lose up to half of its air pressure without appearing flat.

Tires, Wheels and Loading

Every day before you drive, check your tires. If one looks lower than the others, use a tire gauge to check pressure of all tires and adjust if required.

At least once a month and before long trips, inspect each tire and check the tire pressure with a tire gauge (including spare, if equipped). Inflate all tires to the inflation pressure recommended by Mazda.

Use a tire gauge to check the tire inflation pressure, including the spare (if equipped), at least monthly and before long trips. You are strongly urged to buy a reliable tire pressure gauge, as automatic service station gauges may be inaccurate. Mazda recommends the use of a digital or dial type tire pressure gauge rather than a stick type tire pressure gauge.

Use the recommended cold inflation pressure for optimum tire performance and wear. Under-inflation or over-inflation may cause uneven treadwear patterns.

NOTE: If you are driving the vehicle at its maximum weight load, make sure the tire inflation pressure is correct for the weight load on the tires.

WARNING: Under-inflation is the most common cause of tire failures and may result in severe tire cracking, tread separation or "blowout", with unexpected loss of vehicle control and increased risk of injury. Under-inflation increases sidewall flexing and rolling resistance, resulting in heat buildup and internal damage to the tire. It also may result in unnecessary tire stress, irregular wear, loss of vehicle control and accidents. A tire can lose up to half of its air pressure and not appear to be flat!

Always inflate your tires to the Mazda recommended inflation pressure even if it is less than the maximum inflation pressure information found on the tire. The Mazda recommended tire inflation pressure is found on the Safety Compliance Certification Label or Tire Label which is located on the B-Pillar or the edge of the driver's door. Failure to follow the tire pressure recommendations can cause uneven treadwear patterns and adversely affect the way your vehicle handles.

Maximum Permissible Inflation Pressure is the tire manufacturer's maximum permissible pressure and/or the pressure at which the maximum load can be carried by the tire. This pressure is normally higher than the manufacturer's recommended cold inflation pressure which can be found on either the Safety Compliance Certification Label or Tire Label which is located on the B-Pillar or the edge of the driver's

Tires, Wheels and Loading

door. The cold inflation pressure should never be set lower than the recommended pressure on the Safety Compliance Certification Label or Tire Label.

When weather temperature changes occur, tire inflation pressures also change. A 10° F (6° C) temperature drop can cause a corresponding drop of 1 psi (7 kPa) in inflation pressure. Check your tire pressures frequently and adjust them to the proper pressure which can be found on the Safety Compliance Certification Label or Tire Label.

If you are checking tire pressure when the tire is hot, (i.e. driven more than 1 mile [1.6 km]), never “bleed” or reduce air pressure. The tires are hot from driving and it is normal for pressures to increase above recommended cold pressures. A hot tire at or below recommended cold inflation pressure could be significantly under-inflated.

To check the pressure in your tire(s):

1. Make sure the tires are cool, meaning they are not hot from driving even a mile.

Note: If you have to drive a distance to get air for your tire(s), check and record the tire pressure first and add the appropriate air pressure when you get to the pump. It is normal for tires to heat up and the air pressure inside to go up as you drive. Never “bleed” or reduce air pressure when tires are hot.

2. Remove the cap from the valve on one tire, then firmly press the tire gauge onto the valve and measure the pressure.
3. Add enough air to reach the recommended air pressure

Note: If you overfill the tire, release air by pushing on the metal stem in the center of the valve. Then recheck the pressure with your tire gauge.

4. Replace the valve cap.
5. Repeat this procedure for each tire, including the spare.

Note: Some spare tires operate at a higher inflation pressure than the other tires. For T-type/mini-spare tires (see *T-Type/Mini-Spare Tire Information* section for description): Store and maintain at 60psi (4.15 bars). For Full Size and Dissimilar spare tires (see *Dissimilar Spare Tire/Wheel Information* section for description): Store and maintain at the higher of the front and rear inflation pressure as shown on the Safety Compliance Certification Label.

6. Visually inspect the tires to make sure there are no nails or other objects embedded that could poke a hole in the tire and cause an air leak.

7. Check the sidewalls to make sure there are no gouges, cuts or bulges.

TIRE CARE

Inspecting your tires

Periodically inspect the tire treads for uneven or excessive wear and remove objects such as stones, nails or glass that may be wedged in the tread grooves. Check for holes or cuts that may permit air leakage from the tire and make necessary repairs. Also inspect the tire sidewalls for cracking, cuts, bruises and other signs of damage or excessive wear. If internal damage to the tire is suspected, have the tire demounted and inspected in case it needs to be repaired or replaced. For your safety, tires that are damaged or show signs of excessive wear should not be used because they are more likely to blow out or fail.

Improper or inadequate vehicle maintenance can cause tires to wear abnormally. Inspect all your tires, including the spare, frequently, and replace them if one or more of the following conditions exist:

Tire wear

When the tread is worn down to 1/16th of an inch (2 mm), tires must be replaced to help prevent your vehicle from skidding and hydroplaning. Built-in treadwear indicators, or “wear bars”, which look like narrow strips of smooth rubber across the tread will appear on the tire when the tread is worn down to 1/16th of an inch (2 mm). When the tire tread wears down to the same height as these “wear bars”, the tire is worn out and must be replaced.

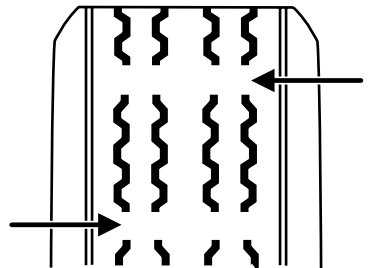

Damage

Periodically inspect the tire treads and sidewalls for damage (such as bulges in the tread or sidewalls, cracks in the tread groove and separation in the tread or sidewall). If damage is observed or suspected have the tire inspected by a tire professional. Tires can be damaged during off-road use, so inspection after off-road use is also recommended.

Tires, Wheels and Loading

WARNING: Age

Tires degrade over time depending on many factors such as weather, storage conditions, and conditions of use (load, speed, inflation pressure, etc.) the tires experience throughout their lives.

In general, tires should be replaced after six years regardless of tread wear. However, heat caused by hot climates or frequent high loading conditions can accelerate the aging process and may require tires to be replaced more frequently.

You should replace your spare tire when you replace the road tires or after six years due to aging even if it has not been used.

U.S. DOT Tire Identification Number (TIN)

Both U.S. and Canada Federal regulations require tire manufacturers to place standardized information on the sidewall of all tires. This information identifies and describes the fundamental characteristics of the tire and also provides a U.S. DOT Tire Identification Number for safety standard certification and in case of a recall.

This begins with the letters "DOT" and indicates that the tire meets all federal standards. The next two numbers or letters are the plant code designating where it was manufactured, the next two are the tire size code and the last four numbers represent the week and year the tire was built. For example, the numbers 317 mean the 31st week of 1997. After 2000 the numbers go to four digits. For example, 2501 means the 25th week of 2001. The numbers in between are identification codes used for traceability. This information is used to contact customers if a tire defect requires a recall.

Tire replacement requirements

Your vehicle is equipped with tires designed to provide a safe ride and handling capability.

Tires, Wheels and Loading

WARNING: Only use replacement tires and wheels that are the same size, load index, speed rating and type (such as P-metric versus LT-metric or all-season versus all-terrain) as those originally provided by Mazda. The recommended tire and wheel size may be found on either the Safety Compliance Certification Label or the Tire Label which is located on the B-Pillar or edge of the driver's door. If this information is not found on these labels then you should consult your Mazda dealer. Use of any tire or wheel not recommended by Mazda can affect the safety and performance of your vehicle, which could result in an increased risk of loss of vehicle control, vehicle rollover, personal injury and death. Additionally the use of non-recommended tires and wheels could cause steering, suspension, axle or transfer case/power transfer unit failure. If you have questions regarding tire replacement, see an authorized dealer.

WARNING: When mounting replacement tires and wheels, you should not exceed the maximum pressure indicated on the sidewall of the tire to set the beads without additional precautions listed below. If the beads do not seat at the maximum pressure indicated, re-lubricate and try again. When inflating the tire for mounting pressures up to 20 psi greater than the maximum pressure on the tire sidewall, the following precautions must be taken to protect the person mounting the tire:

1. Make sure that you have the correct tire and wheel size.
2. Lubricate the tire bead and wheel bead seat area again.
3. Stand at a minimum of 12 feet away from the tire wheel assembly.
4. Use both eye and ear protection.

For a mounting pressure more than 20 psi greater than the maximum pressure, a Mazda Dealer or other tire service professional should do the mounting.

Always inflate steel carcass tires with a remote air fill with the person inflating standing at a minimum of 12 ft. away from the tire wheel assembly.

Important: Remember to replace the wheel valve stems when the road tires are replaced on your vehicle.

Tires, Wheels and Loading

It is recommended that the two front tires or two rear tires generally be replaced as a pair.

The tire pressure sensors mounted in the wheels (originally installed on your vehicle) are not designed to be used in aftermarket wheels.

The use of wheels or tires not recommended by Mazda Motor Corporation may affect the operation of your Tire Pressure Monitoring System.

If the TPMS indicator is flashing, your TPMS is malfunctioning. Your replacement tire might be incompatible with your TPMS, or some component of the TPMS may be damaged.

Safety practices

Driving habits have a great deal to do with your tire mileage and safety.

- Observe posted speed limits
- Avoid fast starts, stops and turns
- Avoid potholes and objects on the road
- Do not run over curbs or hit the tire against a curb when parking

WARNING: If your vehicle is stuck in snow, mud, sand, etc., do not rapidly spin the tires; spinning the tires can tear the tire and cause an explosion. A tire can explode in as little as three to five seconds.

WARNING: Do not spin the wheels at over 35 mph (56 km/h). The tires may fail and injure a passenger or bystander.

Highway hazards

No matter how carefully you drive there's always the possibility that you may eventually have a flat tire on the highway. Drive slowly to the closest safe area out of traffic. This may further damage the flat tire, but your safety is more important.

If you feel a sudden vibration or ride disturbance while driving, or you suspect your tire or vehicle has been damaged, immediately reduce your speed. Drive with caution until you can safely pull off the road. Stop and inspect the tires for damage. If a tire is under-inflated or damaged, deflate it, remove wheel and replace it with your spare tire and wheel. If you cannot detect a cause, have the vehicle towed to the nearest repair facility or tire dealer to have the vehicle inspected.

Tire and wheel alignment

A bad jolt from hitting a curb or pothole can cause the front end of your vehicle to become misaligned or cause damage to your tires. If your vehicle seems to pull to one side, vibrate or shake when you're driving, the wheels may be out of alignment. Have a qualified technician at a Mazda dealer check the wheel alignment periodically.

Wheel misalignment in the front or the rear can cause uneven and rapid treadwear of your tires and should be corrected by a qualified technician at a Mazda dealer. Front wheel drive (FWD) vehicles and those with an independent rear suspension require alignment of all four wheels.

The tire should also be balanced periodically. An unbalanced tire and wheel assembly may result in irregular tire wear.

NOTE: When it is time to replace front tires with new ones, this is an ideal time to perform an alignment. New tires should be balanced at the time they are installed.

Tire rotation

Rotating your tires at the recommended interval (as indicated in the *Scheduled maintenance* section of the *Maintenance and Specifications* chapter) will help your tires wear more evenly, providing better tire performance and longer tire life.

Tires, Wheels and Loading

- Front Wheel Drive (FWD) vehicles (front tires at top of diagram)

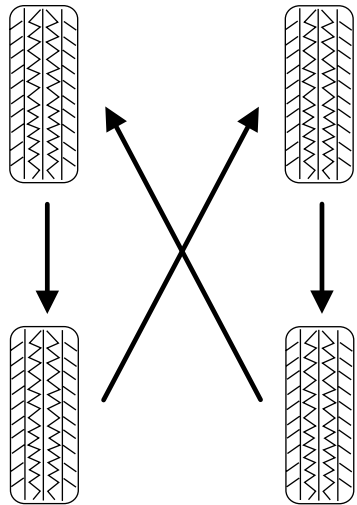

- Rear Wheel Drive (RWD) vehicles/Four Wheel Drive (4WD)/All Wheel Drive (AWD) vehicles (front tires at top of diagram)

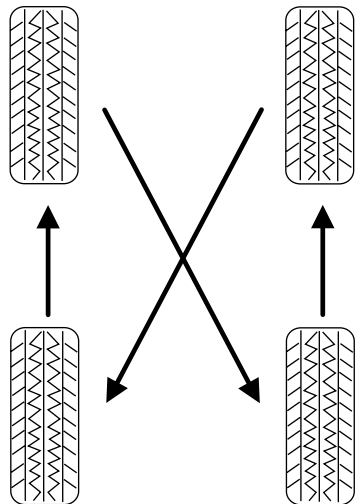

Sometimes irregular tire wear can be corrected by rotating the tires.

Tires, Wheels and Loading

Note: If your tires show uneven wear ask a qualified technician at a Mazda dealership to check for and correct any wheel misalignment, tire imbalance or mechanical problem involved before tire rotation.

Note: Your vehicle may be equipped with a dissimilar spare tire/wheel. A dissimilar spare tire/wheel is defined as a spare tire and/or wheel that is different in brand, size or appearance from the road tires and wheels. If you have a dissimilar spare tire/wheel it is intended for temporary use only and should not be used in a tire rotation.

Note: After having your tires rotated, inflation pressure must be checked and adjusted to the vehicle requirements.

INFORMATION CONTAINED ON THE TIRE SIDEWALL

Both U.S. and Canada Federal regulations require tire manufacturers to place standardized information on the sidewall of all tires. This information identifies and describes the fundamental characteristics of the tire and also provides a U.S. DOT Tire Identification Number for safety standard certification and in case of a recall.

Information on “P” type tires

P215/65R15 95H is an example of a tire size, load index and speed rating. The definitions of these items are listed below. (Note that the tire size, load index and speed rating for your vehicle may be different from this example.)

1. **P:** Indicates a tire, designated by the Tire and Rim Association (T&RA), that may be used for service on cars, SUVs, minivans and light trucks.

Note: If your tire size does not begin with a letter this may mean it is designated by either ETRTO (European Tire and Rim Technical Organization) or JATMA (Japan Tire Manufacturing Association).

2. **215:** Indicates the nominal width of the tire in millimeters from sidewall edge to sidewall edge. In general, the larger the number, the wider the tire.
3. **65:** Indicates the aspect ratio which gives the tire's ratio of height to width.



Tires, Wheels and Loading

- R:** Indicates a “radial” type tire.
- 15:** Indicates the wheel or rim diameter in inches. If you change your wheel size, you will have to purchase new tires to match the new wheel diameter.
- 95:** Indicates the tire’s load index. It is an index that relates to how much weight a tire can carry. You may find this information in your *Owner’s Manual*. If not, contact a local tire dealer.

Note: You may not find this information on all tires because it is not required by federal law.

- H:** Indicates the tire’s speed rating. The speed rating denotes the speed at which a tire is designed to be driven for extended periods of time under a standard condition of load and inflation pressure. The tires on your vehicle may operate at different conditions for load and inflation pressure. These speed ratings may need to be adjusted for the difference in conditions. The ratings range from 81 mph (130 km/h) to 186 mph (299 km/h). These ratings are listed in the following chart.

Note: You may not find this information on all tires because it is not required by federal law.

Letter rating	Speed rating - mph (km/h)
M	81 mph (130 km/h)
N	87 mph (140 km/h)
Q	99 mph (159 km/h)
R	106 mph (171 km/h)
S	112 mph (180 km/h)
T	118 mph (190 km/h)
U	124 mph (200 km/h)
H	130 mph (210 km/h)
V	149 mph (240 km/h)
W	168 mph (270 km/h)
Y	186 mph (299 km/h)

Note: For tires with a maximum speed capability over 149 mph (240 km/h), tire manufacturers sometimes use the letters ZR. For those with a maximum speed capability over 186 mph (299 km/h), tire manufacturers always use the letters ZR.

8. **U.S. DOT Tire Identification Number (TIN):** This begins with the letters “DOT” and indicates that the tire meets all federal standards. The next two numbers or letters are the plant code designating where it was manufactured, the next two are the tire size code and the last four numbers represent the week and year the tire was built. For example, the numbers 317 mean the 31st week of 1997. After 2000 the numbers go to four digits. For example, 2501 means the 25th week of 2001. The numbers in between are identification codes used for traceability. This information is used to contact customers if a tire defect requires a recall.
9. **M+S or M/S:** Mud and Snow, or
AT: All Terrain, or
AS: All Season.
10. **Tire Ply Composition and Material Used:** Indicates the number of plies or the number of layers of rubber-coated fabric in the tire tread and sidewall. Tire manufacturers also must indicate the ply materials in the tire and the sidewall, which include steel, nylon, polyester, and others.
11. **Maximum Load:** Indicates the maximum load in kilograms and pounds that can be carried by the tire. Refer to the Safety Compliance Certification Label, which is located on the B-Pillar or the edge of the driver’s door, for the correct tire pressure for your vehicle.
12. **Treadwear, Traction and Temperature Grades**
 - **Treadwear:** The treadwear grade is a comparative rating based on the wear rate of the tire when tested under controlled conditions on a specified government test course. For example, a tire graded 150 would wear one and one-half (1½) times as well on the government course as a tire graded 100.
 - **Traction:** The traction grades, from highest to lowest are AA, A, B, and C. The grades represent the tire’s ability to stop on wet pavement as measured under controlled conditions on specified government test surfaces of asphalt and concrete. A tire marked C may have poor traction performance.
 - **Temperature:** The temperature grades are A (the highest), B and C, representing the tire’s resistance to the generation of heat and its ability to dissipate heat when tested under controlled conditions on a specified indoor laboratory test wheel.

Tires, Wheels and Loading

- 13. Maximum Permissible Inflation Pressure:** Indicates the tire manufacturers' maximum permissible pressure and/or the pressure at which the maximum load can be carried by the tire. This pressure is normally higher than the manufacturer's recommended cold inflation pressure which can be found on the Safety Compliance Certification Label or Tire Label which is located on the B-Pillar or the edge of the driver's door. The cold inflation pressure should never be set lower than the recommended pressure on the vehicle label.

The tire suppliers may have additional markings, notes or warnings such as standard load, radial tubeless, etc.

Additional information contained on the tire sidewall for "LT" type tires

"LT" type tires have some additional information beyond those of "P" type tires; these differences are described below:

- 1. LT:** Indicates a tire, designated by the Tire and Rim Association (T&RA), that is intended for service on light trucks.
- 2. Load Range/Load Inflation Limits:** Indicates the tire's load-carrying capabilities and its inflation limits.
- 3. Maximum Load Dual lb. (kg) at psi (kPa) cold:** Indicates the maximum load and tire pressure when the tire is used as a dual; defined as four tires on the rear axle (a total of six or more tires on the vehicle).
- 4. Maximum Load Single lb. (kg) at psi (kPa) cold:** Indicates the maximum load and tire pressure when the tire is used as a single; defined as two tires (total) on the rear axle.



Information on “T” type tires

“T” type tires have some additional information beyond those of “P” type tires; these differences are described below:

T145/80D16 is an example of a tire size.

Note: The temporary tire size for your vehicle may be different from this example.

1. **T:** Indicates a type of tire, designated by the Tire and Rim Association (T&RA), that is intended for temporary service on cars, SUVs, minivans and light trucks.
2. **145:** Indicates the nominal width of the tire in millimeters from sidewall edge to sidewall edge. In general, the larger the number, the wider the tire.
3. **80:** Indicates the aspect ratio which gives the tire’s ratio of height to width. Numbers of 70 or lower indicate a short sidewall.
4. **D:** Indicates a “diagonal” type tire.
R: Indicates a “radial” type tire.
5. **16:** Indicates the wheel or rim diameter in inches. If you change your wheel size, you will have to purchase new tires to match the new wheel diameter.

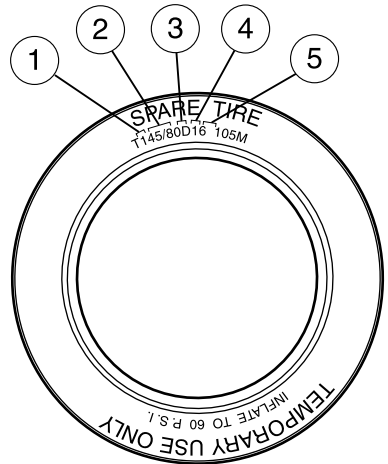

Location of the tire label

You will find a Tire Label containing tire inflation pressure by tire size and other important information located on the B-Pillar or the edge of the driver’s door. Refer to the payload description and graphic in the *Vehicle loading — with and without a trailer* section.

Tires, Wheels and Loading

TIRE PRESSURE MONITORING SYSTEM (TPMS)

Each tire, including the spare (if provided), should be checked monthly when cold and inflated to the inflation pressure recommended by the vehicle manufacturer on the

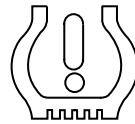

vehicle placard or tire inflation pressure label. (If your vehicle has tires of a different size than the size indicated on the vehicle placard or tire inflation pressure label, you should determine the proper tire inflation pressure for those tires.)

As an added safety feature, your vehicle has been equipped with a tire pressure monitoring system (TPMS) that illuminates a low tire pressure telltale when one or more of your tires is significantly under-inflated. Accordingly, when the low tire pressure telltale illuminates, you should stop and check your tires as soon as possible, and inflate them to the proper pressure. Driving on a significantly under-inflated tire causes the tire to overheat and can lead to tire failure. Under-inflation also reduces fuel efficiency and tire tread life, and may affect the vehicle's handling and stopping ability.

Please note that the TPMS is not a substitute for proper tire maintenance, and it is the driver's responsibility to maintain correct tire pressure, even if under-inflation has not reached the level to trigger illumination of the TPMS low tire pressure telltale.

Your vehicle has also been equipped with a TPMS malfunction indicator to indicate when the system is not operating properly. The TPMS malfunction indicator is combined with the low tire pressure telltale. When the system detects a malfunction, the telltale will flash for approximately one minute and then remain continuously illuminated. This sequence will continue upon subsequent vehicle start-ups as long as the malfunction exists.

When the malfunction indicator is illuminated, the system may not be able to detect or signal low tire pressure as intended. TPMS malfunctions may occur for a variety of reasons, including the installation of replacement or alternate tires or wheels on the vehicle that prevent the TPMS from functioning properly. Always check the TPMS malfunction telltale after replacing one or more tires or wheels on your vehicle to ensure that the replacement or alternate tires and wheels allow the TPMS to continue to function properly.

The Tire Pressure Monitoring System complies with part 15 of the FCC rules and with RSS-210 of Industry Canada. Operation is subject to the

following two conditions: (1) This device may not cause harmful interference, and (2) This device must accept any interference received, including interference that may cause undesired operation.

WARNING: The Tire Pressure Monitoring System is NOT a substitute for manually checking tire pressure. The tire pressure should be checked periodically (at least monthly) using a tire gauge, see *Inflating your tires* in this chapter. Failure to properly maintain your tire pressure could increase the risk of tire failure, loss of control, vehicle rollover and personal injury.

Changing tires with TPMS

Each road tire is equipped with a tire pressure sensor fastened to the inside rim of the wheel. The pressure sensor is covered by the tire and is not visible unless the tire is removed. The pressure sensor is located opposite (180 degrees) from the valve stem. Care must be taken when changing the tire to avoid damaging the sensor. It is recommended that you always have your tires serviced by an authorized dealer.

The tire pressure should be checked periodically (at least monthly) using an accurate tire gauge, refer to *Inflating your tires* in this chapter.

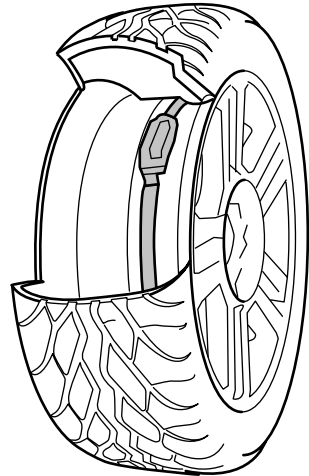

Understanding your Tire Pressure Monitoring System (TPMS)

The Tire Pressure Monitoring System measures pressure in your four road tires and sends the tire pressure readings to your vehicle. The Low Tire Pressure Warning Lamp will turn ON if the tire pressure is significantly low. Once the light is illuminated, your tires are under inflated and need to be inflated to the manufacturer's recommended tire pressure. Even if the light turns ON and a short time later turns OFF, your tire pressure still needs to be checked.

Tires, Wheels and Loading

When your temporary spare tire is installed

When one of your road tires needs to be replaced with the temporary spare, the TPMS system will continue to identify an issue to remind you that the damaged road wheel/tire needs to be repaired and put back on your vehicle.

To restore the full functionality of the Tire Pressure Monitoring System, have the damaged road wheel/tire repaired and remounted on your vehicle. For additional information, refer to *Changing tires with TPMS* in this section.

When you believe your system is not operating properly

The main function of the Tire Pressure Monitoring System is to warn you when your tires need air. It can also warn you in the event the system is no longer capable of functioning as intended. Please refer to the following chart for information concerning your Tire Pressure Monitoring System:

Tires, Wheels and Loading

Low Tire Pressure Warning Light	Possible cause	Customer Action Required
Solid Warning Light	Tire(s) under-inflated	<ol style="list-style-type: none"> 1. Check your tire pressure to ensure tires are properly inflated; refer to <i>Inflating your tires</i> in this chapter. 2. After inflating your tires to the manufacturer's recommended inflation pressure as shown on the Tire Label (located on the edge of driver's door or the B-Pillar), the vehicle must be driven for at least two minutes over 20 mph (32 km/h) before the light will turn OFF.
	Spare tire in use	Your temporary spare tire is in use. Repair the damaged road wheel/tire and reinstall it on the vehicle to restore system functionality. For a description on how the system functions, refer to <i>When your temporary spare tire is installed</i> in this section.
	TPMS malfunction	If your tires are properly inflated and your spare tire is not in use and the light remains ON, have the system inspected by your authorized dealer.

Tires, Wheels and Loading

Low Tire Pressure Warning Light	Possible cause	Customer Action Required
Flashing Warning Light	Spare tire in use	Your temporary spare tire is in use. Repair the damaged road wheel and re-mount it on the vehicle to restore system functionality. For a description of how the system functions under these conditions, refer to <i>When your temporary spare tire is installed</i> in this section.
	TPMS malfunction	If your tires are properly inflated and your spare tire is not in use and the TPMS warning light still flashes, have the system inspected by your authorized dealer.

When inflating your tires

When putting air into your tires (such as at a gas station or in your garage), the Tire Pressure Monitoring System may not respond immediately to the air added to your tires.

It may take up to two minutes of driving over 20 mph (32 km/h) for the light to turn OFF after you have filled your tires to the recommended inflation pressure.

How temperature affects your tire pressure

The Tire Pressure Monitoring System (TPMS) monitors tire pressure in each pneumatic tire. While driving in a normal manner, a typical passenger tire inflation pressure may increase approximately 2 to 4 psi (14 to 28 kPa) from a cold start situation. If the vehicle is stationary over night with the outside temperature significantly lower than the daytime temperature, the tire pressure may decrease approximately 3 psi (20.7 kPa) for a drop of 30° F (16.6°C) in ambient temperature. This lower pressure value may be detected by the TPMS as being significantly lower than the recommended inflation pressure and activate the TPMS warning for low tire pressure. If the low tire pressure warning light is ON, visually check each tire to verify that no tire is flat. (If one or more tires are flat, repair as necessary.) Check air pressure in the road tires. If

Tires, Wheels and Loading

any tire is under-inflated, carefully drive the vehicle to the nearest location where air can be added to the tires. Inflate all the tires to the recommended inflation pressure.

SNOW TIRES AND CHAINS

WARNING: Driving too fast for conditions creates the possibility of loss of vehicle control. Driving at very high speeds for extended periods of time may result in damage to vehicle components.

NOTE: Snow tires must be the same size and grade as the tires you currently have on your vehicle.

The tires on your vehicle have all weather treads to provide traction in rain and snow. However, in some climates, you may need to use snow tires and chains. If you need to use snow tires and chains, it is recommended that steel wheels are used of the same size and specifications as those originally installed.

Follow these guidelines when using snow tires and chains:

- Do not use tire chains on aluminum wheels. Chains may chip the wheels.
- Use only SAE Class S chains.
- Install chains securely, verifying that the chains do not touch any wiring, brake lines or fuel lines.

Drive cautiously. Ensure you obtain the proper cables or chains for you vehicle. Test fit the cables or chains before using them in snow and/or ice. If you hear the cables or chains rub or bang against the vehicle, stop and retighten them. If this does not work, remove the cables or chains to prevent vehicle damage. Have the cables or chains fitted by a professional before proceeding.

- If possible, avoid fully loading your vehicle.
- Remove the tire chains when they are no longer needed. Do not use tire chains on dry roads.
- The suspension insulation and bumpers will help prevent vehicle damage. Do not remove these components from your vehicle when using snow tires and chains.

VEHICLE LOADING – WITH AND WITHOUT A TRAILER

This section will guide you in the proper loading of your vehicle and/or trailer, to keep your loaded vehicle weight within its design rating capability, with or without a trailer. Properly loading your vehicle will

Tires, Wheels and Loading

provide maximum return of vehicle design performance. Before loading your vehicle, familiarize yourself with the following terms for determining your vehicle's weight ratings, with or without a trailer, from the vehicle's Tire Label or Safety Compliance Certification Label:

Base Curb Weight – is the weight of the vehicle including a full tank of fuel and all standard equipment. It does not include passengers, cargo, or optional equipment.

Vehicle Curb Weight – is the weight of your new vehicle when you picked it up from your authorized dealer plus any aftermarket equipment.

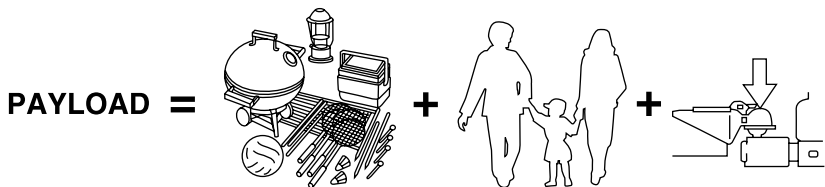

Payload – is the combined weight of cargo and passengers that the vehicle is carrying. The maximum payload for your vehicle can be found on the Tire Label on the B-Pillar or the edge of the driver's door (vehicles exported outside the US and Canada may not have a Tire Label). Look for **“THE COMBINED WEIGHT OF OCCUPANTS AND CARGO SHOULD NEVER EXCEED XXX kg OR XXX lb.”** for maximum payload. The payload listed on the Tire Label is the maximum payload for the vehicle as built by the assembly plant. If any aftermarket or authorized-dealer installed equipment has been installed on the vehicle, the weight of the equipment must be subtracted from the payload listed on the Tire Label in order to determine the new payload.

WARNING: The appropriate loading capacity of your vehicle can be limited either by volume capacity (how much space is available) or by payload capacity (how much weight the vehicle should carry). Once you have reached the maximum payload of your vehicle, do not add more cargo, even if there is space available. Overloading or improperly loading your vehicle can contribute to loss of vehicle control and vehicle rollover.

Tires, Wheels and Loading

Example only:





TIRE AND LOADING INFORMATION

SEATING CAPACITY	TOTAL 5	FRONT 2	REAR 3
------------------	---------	---------	--------

The combined weight of occupants : XXX kg or XXX lbs.
and cargo should never exceed

TIRE	SIZE	COLD TIRE PRESSURE	SEE OWNERS MANUAL FOR ADDITIONAL INFORMATION
FRONT	LT225/75R 16.5E	200 KPA, 29 PSI	
REAR	LT225/75R 16.5E	200 KPA, 29 PSI	
SPARE	T145/80D16 P225/60R17	420 KPA, 60 PSI 200 KPA, 29 PSI	





TIRE AND LOAD INFORMATION RENSEIGNEMENTS RELATIFS AUX PNEUS ET À LA CHARGE

SEATING CAPACITY NOMBRE DE PLACES	TOTAL 5	FRONT 2	REAR 3
--------------------------------------	---------	---------	--------

The combined weight of occupants and cargo should never exceed : XXX kg.
La charge du véhicule (occupants et bagages) ne doit jamais dépasser : XXX kg.

TIRE PNEUS	SIZE DIMENSIONS	COLD TIRE PRESSURE PRESSION À FROID	SEE OWNERS MANUAL FOR ADDITIONAL INFORMATION CONSULTER LE GUIDE DU PROPRIÉTAIRE POUR DE PLUS AMPLES RENSEIGNEMENTS
FRONT AVANT	LT225/75R 16.5E	200 KPA, 29 PSI	
REAR ARRIÈRE	LT225/75R 16.5E	200 KPA, 29 PSI	
SPARE PNEUS SECOURS	T145/80D16 P225/60R17	420 KPA, 60 PSI 200 KPA, 29 PSI	



CARGO

=



+

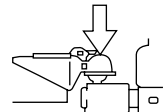

Cargo Weight – includes all weight added to the Base Curb Weight, including cargo and optional equipment. When towing, trailer tongue load or king pin weight is also part of cargo weight.

GAW (Gross Axle Weight) – is the total weight placed on each axle (front and rear) – including vehicle curb weight and all payload.

Tires, Wheels and Loading

GAWR (Gross Axle Weight Rating) – is the maximum allowable weight that can be carried by a single axle (front or rear). **These numbers are shown on the Safety Compliance Certification Label located on the B-Pillar or the edge of the driver's door. The total load on each axle must never exceed its GAWR.**

Note: For trailer towing information refer to *Trailer towing* found in this chapter or the *RV and Trailer Towing Guide* provided by your authorized dealer.

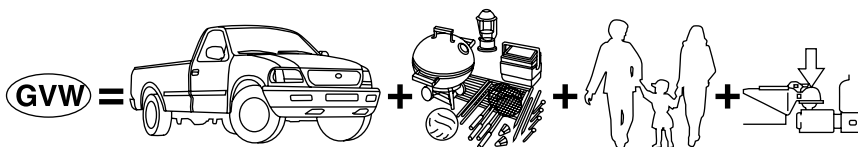

GVW (Gross Vehicle Weight) – is the Vehicle Curb Weight + cargo + passengers.

GVWR (Gross Vehicle Weight Rating) – is the maximum allowable weight of the fully loaded vehicle (including all options, equipment, passengers and cargo). **The GVWR is shown on the Safety Compliance Certification Label located on the B-Pillar or the edge of the driver's door. The GVW must never exceed the GVWR.**

MF.D. BY FORD MOTOR CO. IN U.S.A.							
FOR MAZDA MOTOR CORPORATION							
DATE: XX/XX	GVWR: XXXXLB/ XXXXXKG						
FRONT GAWR: XXXXL	WITH XXXXKG		REAR GAWR: XXXXLB	WITH XXXXKG		WITH XXXXLB	
XXXXXX	TIRES XXXX/XXXXXXX		XXXXXX	TIRES XXXX/XXXXXXX		TIRES XXXXLB	
XXXXXX	RIMS XXXX.XX		XXXXXX	RIMS XXXX.XX		RIMS XXXXLB	
AT XXX kPa/XX	PSI COLD		AT XXX kPa/XX	PSI COLD		AT XXX kPa/XX	
THIS VEHICLE CONFORMS TO ALL APPLICABLE FEDERAL MOTOR VEHICLE SAFETY AND THEFT PREVENTION STANDARDS IN EFFECT ON THE DATE OF MANUFACTURE SHOWN ABOVE.							
VIN: XXXXXXXXXXXXXXXXXXXX						XXXXXX	
TYPE: XXX						XXXXXX	
EXT PNT: XX	RC: XX			DSO:			
WB ¹ BRK	INT TR	TP/PS	TR	AXLE	TR	SPR	XXXXX
XXX X	XX		X	XX	X	XX	XXX
XXXXXXXXXXXXXXXX XXX XXXX-XXXXXXXX-XX							

WARNING: Exceeding the Safety Compliance Certification Label vehicle weight rating limits could result in substandard vehicle handling or performance, engine, transmission and/or structural damage, serious damage to the vehicle, loss of control and personal injury.

Tires, Wheels and Loading

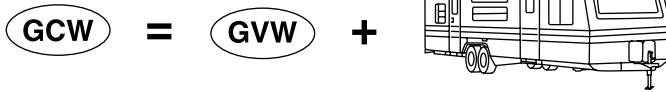

GCW (Gross Combined Weight) – is the weight of the loaded vehicle (GVW) plus the weight of the fully loaded trailer.

GCWR (Gross Combined Weight Rating) – is the maximum allowable weight of the vehicle and the loaded trailer – including all cargo and passengers – that the vehicle can handle without risking damage. (Important: The towing vehicle's braking system is rated for operation at GVWR, not at GCWR.) Separate functional brakes should be used for safe control of towed vehicles and for trailers where the GCW of the towing vehicle plus the trailer exceed the GVWR of the towing vehicle. **The GCW must never exceed the GCWR.**

Maximum Loaded Trailer Weight – is the highest possible weight of a fully loaded trailer the vehicle can tow. It assumes a vehicle with only mandatory options, no cargo (internal or external), a tongue load of 10–15% (conventional trailer) or king pin weight of 15–25% (fifth wheel trailer), and driver only (150 lb. [68 kg]). **Consult your authorized dealer (or the *RV and Trailer Towing Guide* provided by your authorized dealer) for more detailed information.**

Tongue Load or Fifth Wheel King Pin Weight – refers to the amount of the weight that a trailer pushes down on a trailer hitch.

Examples: For a 5,000 lb. (2,268 kg) conventional trailer, multiply 5,000 by 0.10 and 0.15 to obtain a proper tongue load range of 500 to 750 lb. (227 to 340 kg). For an 11,500 lb. (5,216 kg) fifth wheel trailer, multiply by 0.15 and 0.25 to obtain a proper king pin load range of 1,725 to 2,875 lb. (782 to 1,304 kg)

WARNING: Do not exceed the GVWR or the GAWR specified on the Safety Compliance Certification Label.

WARNING: Do not use replacement tires with lower load carrying capacities than the original tires because they may lower the vehicle's GVWR and GAWR limitations. Replacement tires with a higher limit than the original tires do not increase the GVWR and GAWR limitations.

Tires, Wheels and Loading

WARNING: Exceeding any vehicle weight rating limitation could result in serious damage to the vehicle and/or personal injury.

Steps for determining the correct load limit:

1. Locate the statement “The combined weight of occupants and cargo should never exceed XXX kg or XXX lbs.” on your vehicle’s placard.
2. Determine the combined weight of the driver and passengers that will be riding in your vehicle.
3. Subtract the combined weight of the driver and passengers from XXX kg or XXX lbs.
4. The resulting figure equals the available amount of cargo and luggage load capacity. For example, if the “XXX” amount equals 1,400 lbs. and there will be five 150 lb. passengers in your vehicle, the amount of available cargo and luggage load capacity is 650 lbs. $(1400 - 750 (5 \times 150) = 650 \text{ lb.})$. In metric units $(635 - 340 (5 \times 68) = 295 \text{ kg.})$
5. Determine the combined weight of luggage and cargo being loaded on the vehicle. That weight may not safely exceed the available cargo and luggage load capacity calculated in Step 4.
6. If your vehicle will be towing a trailer, load from your trailer will be transferred to your vehicle. Consult this manual to determine how this reduces the available cargo and luggage load capacity of your vehicle.

The following gives you a few examples on how to calculate the available amount of cargo and luggage load capacity:

- Another example for your vehicle with 1400 lb. (635 kg) of cargo and luggage capacity. You decide to go golfing. Is there enough load capacity to carry you, 4 of your friends and all the golf bags? You and four friends average 220 lb. (99 kg) each and the golf bags weigh approximately 30 lb. (13.5 kg) each. The calculation would be: $1400 - (5 \times 220) - (5 \times 30) = 1400 - 1100 - 150 = 150 \text{ lb.}$ Yes, you have enough load capacity in your vehicle to transport four friends and your golf bags. In metric units, the calculation would be: $635 \text{ kg} - (5 \times 99 \text{ kg}) - (5 \times 13.5 \text{ kg}) = 635 - 495 - 67.5 = 72.5 \text{ kg.}$
- A final example for your vehicle with 1400 lb. (635 kg) of cargo and luggage capacity. You and one of your friends decide to pick up cement from the local home improvement store to finish that patio you have been planning for the past 2 years. Measuring the inside of the vehicle with the rear seat folded down, you have room for 12-100 lb. (45 kg) bags of cement. Do you have enough load capacity

Tires, Wheels and Loading

to transport the cement to your home? If you and your friend each weigh 220 lb. (99 kg), the calculation would be: $1400 - (2 \times 220) - (12 \times 100) = 1400 - 440 - 1200 = -240$ lb. No, you do not have enough cargo capacity to carry that much weight. In metric units, the calculation would be: $635 \text{ kg} - (2 \times 99 \text{ kg}) - (12 \times 45 \text{ kg}) = 635 - 198 - 540 = -103$ kg. You will need to reduce the load weight by at least 240 lb. (104 kg). If you remove 3-100 lb. (45 kg) cement bags, then the load calculation would be:

$1400 - (2 \times 220) - (9 \times 100) = 1400 - 440 - 900 = 60$ lb. Now you have the load capacity to transport the cement and your friend home. In metric units, the calculation would be: $635 \text{ kg} - (2 \times 99 \text{ kg}) - (9 \times 45 \text{ kg}) = 635 - 198 - 405 = 32$ kg.

The above calculations also assume that the loads are positioned in your vehicle in a manner that does not overload the Front or the Rear Gross Axle Weight Rating specified for your vehicle on the Safety Compliance Certification Label found on the edge of the driver's door.

Special loading instructions for owners of pickup trucks and utility-type vehicles

WARNING: For important information regarding safe operation of this type of vehicle, see the *Preparing to drive your vehicle* section in the *Driving* chapter of this *Owner's Manual*.

WARNING: Loaded vehicles may handle differently than unloaded vehicles. Extra precautions, such as slower speeds and increased stopping distance, should be taken when driving a heavily loaded vehicle.

Your vehicle can haul more cargo and people than most passenger cars. Depending upon the type and placement of the load, hauling cargo and people may raise the center of gravity of the vehicle.

TRAILER TOWING

Your vehicle may tow a class I, II or III trailer provided the maximum trailer weight is less than or equal to the maximum trailer weight listed for your engine and rear axle ratio on the following charts.

Your vehicle's load capacity is designated by weight, not by volume, so you cannot necessarily use all available space when loading a vehicle.

Towing a trailer places an additional load on your vehicle's engine, transmission, axle, brakes, tires and suspension. Inspect these components carefully after any towing operation.

Tires, Wheels and Loading

4x2 w/manual transmission				
Engine	Rear axle ratio	Maximum GCWR - lb. (kg)	Maximum trailer weight - lb. (kg)	Maximum frontal area of trailer - ft² (m²)
Regular Cab				
2.3L	All	4,800 (2,177)	1,600 (725)	Equal to frontal area of vehicle
3.0L*	3.73	6,000 (2,722)	2,640 (1,197)	50 (4.64)
3.0L* Dual Sport	4.10	6,000 (2,722)	2,540 (1,152)	50 (4.64)
Cab Plus 4				
2.3L	All	4,800 (2,177)	1,440 (653)	Equal to frontal area of vehicle
3.0L*	3.73	6,000 (2,722)	2,540 (1,152)	50 (4.64)
3.0L* Dual Sport	4.10	6,000 (2,722)	2,320 (1,052)	50 (4.64)
4.0L	All	7,000 (3,175)	3,420 (1,551)	50 (4.64)
4.0L Dual Sport	All	7,000 (3,175)	3,260 (1,478)	50 (4.64)
For high altitude operation, reduce GCW by 2% per 1,000 ft. (300 meters) elevation.				
*When towing on roads with steep grades or moderate but long sustained grades (5 miles [8 km] or more), or when ambient temperatures exceed 100°F (37°C), vehicle speed should not exceed 45 mph (72 km/h) in both cases.				
For definition of terms used in this table see <i>Vehicle Loading</i> earlier in this chapter.				
To determine maximum trailer weight designed for your particular vehicle, see <i>Vehicle Loading</i> earlier in this chapter.				
Maximum trailer weight is shown. The combined weight of the completed towing vehicle (including hitch, passengers and cargo) and the loaded trailer must not exceed the Gross Combined Weight Rating (GCWR).				

Tires, Wheels and Loading

4x4 w/manual transmission				
Engine	Rear axle ratio	Maximum GCWR - lb. (kg)	Maximum trailer weight - lb. (kg)	Maximum frontal area of trailer - ft ² (m ²)
Regular Cab				
3.0L*	All	6,000 (2,722)	2,360 (1,070)	50 (4.64)
4.0L	All	7,000 (3,175)	3,300 (1,496)	50 (4.64)
Cab Plus 4				
4.0L	All	7,000 (3,175)	3,140 (1,424)	50 (4.64)
For high altitude operation, reduce GCW by 2% per 1,000 ft. (300 meters) of elevation.				
*When towing on roads with steep grades or moderate but long sustained grades (5 miles [8 km] or more), or when ambient temperatures exceed 100°F (37°C), vehicle speed should not exceed 45 mph (72 km/h) in both cases.				
For definition of terms used in this table, see <i>Vehicle loading</i> earlier in this chapter.				
To determine maximum trailer weight designed for your vehicle, see <i>Vehicle loading</i> earlier in this chapter.				
Maximum trailer weight is shown. The combined weight of the completed towing vehicle (including hitch, passengers and cargo) and the loaded trailer must not exceed the Gross Combined Weight Rating (GCWR).				
4x2 w/automatic transmission				
Engine	Rear axle ratio	Maximum GCWR - lb. (kg)	Maximum trailer weight - lb. (kg)	Maximum frontal area of trailer - ft ² (m ²)
Regular Cab				
2.3L	All	5,500 (2,495)	2,260 (1,025)	Equal to frontal area of vehicle
3.0L*	3.73	6,000 (2,722)	2,600 (1,179)	50 (4.64)
3.0L* Dual Sport	4.10	6,000 (2,722)	2,400 (1,088)	50 (4.64)

Tires, Wheels and Loading

4x2 w/automatic transmission				
Engine	Rear axle ratio	Maximum GCWR - lb. (kg)	Maximum trailer weight - lb. (kg)	Maximum frontal area of trailer - ft ² (m ²)
Cab Plus 4				
2.3L	4.10	5,500 (2,495)	2,100 (953)	Equal to frontal area of vehicle
3.0L*	3.73	6,000 (2,722)	2,440 (1,106)	50 (4.64)
3.0L* Dual Sport	4.10	6,000 (2,722)	2,280 (1,034)	50 (4.64)
4.0L	All	9,500 (4,309)	5,880 (2,667)	50 (4.64)
4.0L Dual Sport	All	9,500 (4,309)	5,720 (2,594)	50 (4.64)
For high altitude operation, reduce GCW by 2% per 1,000 ft. (300 meters) elevation.				
*When towing on roads with steep grades or moderate but long sustained grades (5 miles [8 km] or more), or when ambient temperatures exceed 100°F (37°C), vehicle speed should not exceed 45 mph (72 km/h) in both cases.				
For definition of terms used in this table see <i>Vehicle Loading</i> earlier in this chapter.				
To determine maximum trailer weight designed for your particular vehicle, see <i>Vehicle loading</i> earlier in this chapter.				
Maximum trailer weight is shown. The combined weight of the completed towing vehicle (including hitch, passengers and cargo) and the loaded trailer must not exceed the Gross Combined Weight Rating (GCWR).				

Tires, Wheels and Loading

4x4 w/automatic transmission				
Engine	Rear axle ratio	Maximum GCWR - lb. (kg)	Maximum trailer weight - lb. (kg)	Maximum frontal area of trailer - ft ² (m ²)
Regular Cab				
3.0L*	3.73	6,000 (2,722)	2,340 (1,061)	50 (4.64)
4.0L	All	9,500 (4,309)	5,760 (2,612)	50 (4.64)
Cab Plus 4				
4.0L	All	9,500 (4,309)	5,600 (2,540)	50 (4.64)
For high altitude operation, reduce GCW by 2% per 1,000 ft. (300 meters) of elevation.				
*When towing on roads with steep grades or moderate but long sustained grades (5 miles [8 km] or more), or when ambient temperatures exceed 100°F (37°C), vehicle speed should not exceed 45 mph (72 km/h) in both cases.				
For definition of terms used in this table, see <i>Vehicle loading</i> earlier in this chapter.				
To determine maximum trailer weight designed for your vehicle, see <i>Vehicle loading</i> earlier in this chapter.				
Maximum trailer weight is shown. The combined weight of the completed towing vehicle (including hitch, passengers and cargo) and the loaded trailer must not exceed the Gross Combined Weight Rating (GCWR).				

WARNING: Do not exceed the GVWR or the GAWR specified on the certification label.

The certification label is found on the driver's door latch pillar.

WARNING: Towing trailers beyond the maximum recommended gross trailer weight exceeds the limit of the vehicle and could result in engine damage, transmission damage, structural damage, loss of vehicle control, vehicle rollover and personal injury.

Tires, Wheels and Loading

Preparing to tow

Use the proper equipment for towing a trailer and make sure it is properly attached to your vehicle. See your authorized dealer or a reliable trailer dealer if you require assistance.

Hitches

For towing trailers up to 2,000 lb. (907 kg), use a weight carrying hitch and ball which uniformly distributes the trailer tongue loads through the underbody structure. Use a frame-mounted weight distributing hitch for trailers over 2,000 lb. (907 kg).

Do not install a single or multi-clamp type bumper hitch, or a hitch which attaches to the axle. Underbody mounted hitches are acceptable if they are installed properly. Follow the towing instructions of a reputable rental agency.

Whenever a trailer hitch and hardware are removed, make sure all mounting holes in the underbody are properly sealed to prevent noxious gases or water from entering.

Safety chains

Always connect the trailer's safety chains to the frame or hook retainers of the vehicle hitch. To connect the trailer's safety chains, cross the chains under the trailer tongue and allow slack for turning corners.

If you use a rental trailer, follow the instructions that the rental agency gives to you.

Do not attach safety chains to the bumper.

Trailer brakes

Electric brakes and manual, automatic or surge-type trailer brakes are safe if installed properly and adjusted to the manufacturer's specifications. The trailer brakes must meet local and Federal regulations.

WARNING: Do not connect a trailer's hydraulic brake system directly to your vehicle's brake system. Your vehicle may not have enough braking power and your chances of having a collision greatly increase.

The braking system of the tow vehicle is rated for operation at the GVWR not GCWR.

Trailer lamps

Trailer lamps are required on most towed vehicles. Make sure all running lights, brake lights, turn signals and hazard lights are working. See your authorized dealer or trailer rental agency for proper instructions and equipment for hooking up trailer lamps.

Using a step bumper

The optional step bumper is equipped with an integral hitch and requires only a ball with a 3/4 inch (19 mm) shank diameter. The bumper has a 2,000 lb. (907 kg) trailer weight and 200 lb. (91 kg) tongue weight capability.

The rated capacities (as shown in this guide) for trailer towing with the factory bumper are only valid when the trailer hitch ball is installed directly into the ball hole in the bumper. Addition of bracketry to either lower the ball hitch position or extend the ball hitch rearward will significantly increase the loads on the bumper and its attachments. This can result in the failure of the bumper or the bumper attachments. Use of any type of hitch extensions should be considered abuse.

Trailer tow connector

The trailer tow connector is located under the rear bumper, on the driver's side of the vehicle.

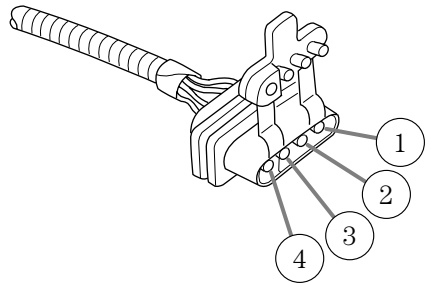

Tires, Wheels and Loading

Refer to the following chart for information regarding the factory-equipped trailer tow connector:

Trailer tow connector		
Color	Function	Comment
1. Dark Green	Trailer right-hand turn signal	Circuit activated when brake pedal is depressed or when ignition is on and right-hand turn signal is applied.
2. Yellow	Trailer left-hand turn signal	Circuit activated when brake pedal is depressed or when ignition is on and left-hand turn signal is applied.
3. Tan/White	Tail lamp	Relay controlled circuit activated when the park lamps/headlamps are on.
4. White	Ground	Matching vehicle circuit returns to battery's negative ground.

Driving while you tow

When towing a trailer:

- Keep your speed no faster than 70 mph (112 km/h) during the first 500 miles (800 km) of towing a trailer, and don't make full throttle starts.
- Turn off the speed control. The speed control may shut off automatically when you are towing on long, steep grades.
- Consult your local motor vehicle speed regulations for towing a trailer.
- To eliminate excessive shifting, use a lower gear. This will also assist in transmission cooling. (For additional information, refer to the *Driving with a 5-speed automatic transmission* section in the *Driving* chapter.)
- Under extreme conditions with large frontal trailers, high outside temperatures and highway speeds, the coolant gauge may indicate higher than normal coolant temperatures. If this occurs, reduce speed until the coolant temperature returns to the normal range. Refer to *Engine coolant temperature gauge* in the *Instrument Cluster* chapter.

- Anticipate stops and brake gradually.
- Do not exceed the GCWR rating or transmission damage may occur.

Servicing after towing

If you tow a trailer for long distances, your vehicle will require more frequent service intervals. Refer to your *scheduled maintenance information* for more information.

Trailer towing tips

- Practice turning, stopping and backing up before starting on a trip to get the feel of the vehicle trailer combination. When turning, make wider turns so the trailer wheels will clear curbs and other obstacles.
- Allow more distance for stopping with a trailer attached.
- The trailer tongue weight should be 10–15% of the loaded trailer weight.
- If you will be towing a trailer frequently in hot weather, hilly conditions, at GCWR, or any combination of these factors, consider refilling your rear axle with synthetic gear lube if not already so equipped. Refer to the *Maintenance and specifications* chapter for the lubricant specification. Remember that regardless of the rear axle lube used, do not tow a trailer for the first 500 miles (800 km) of a new vehicle, and that the first 500 miles (800 km) of towing be done at no faster than 70 mph (112 km/h) with no full throttle starts.
- After you have traveled 50 miles (80 km), thoroughly check your hitch, electrical connections and trailer wheel lug nuts.
- To aid in engine/transmission cooling and A/C efficiency during hot weather while stopped in traffic, place the gearshift lever in P (Park) (automatic transmission) or N (Neutral) (manual transmissions).
- Vehicles with trailers should not be parked on a grade. If you must park on a grade, place wheel chocks under the trailer's wheels.

Launching or retrieving a boat

Disconnect the wiring to the trailer before backing the trailer into the water. Reconnect the wiring to the trailer after the trailer is removed from the water.

When backing down a ramp during boat launching or retrieval:

- do not allow the static water level to rise above the bottom edge of the rear bumper.
- do not allow waves to break higher than 6 inches (15 cm) above the bottom edge of the rear bumper.

Tires, Wheels and Loading

Exceeding these limits may allow water to enter vehicle components:

- causing internal damage to the components.
- affecting driveability, emissions and reliability.

Replace the rear axle lubricant any time the axle has been submerged in water. Rear axle lubricant quantities are not to be checked or changed unless a leak is suspected or repair required.

RECREATIONAL TOWING

Follow these guidelines if you have a need for recreational towing. An example of recreational towing would be towing your vehicle behind a motorhome. These guidelines are designed to ensure that your transmission is not damaged.

Vehicles equipped with a manual transmission:

Note: 4x2 and 4x4 vehicles with a manual transmission follow these guidelines for recreational towing:

Before you have your vehicle towed:

- Release the parking brake.
- Move the gearshift to the neutral position.
- Turn the key in the ignition to the OFF/UNLOCKED position.
- The maximum recommended speed is 55 mph (88 km/h).
- The maximum recommended distance is unlimited.
- Put 4x4 switch in 2WD mode (4x4 only)
- The vehicle must be towed in the forward position to ensure no damage is done to the internal transmission components.

For 4x4 vehicles with a manual transmission, it is recommended that a Neutral Tow Kit be purchased and installed by an authorized dealer if the vehicle is towed frequently.

In addition, it is recommended that you follow the instructions provided by the aftermarket manufacturer of the towing apparatus if one has been installed.

Vehicles equipped with an automatic transmission

4x2 and 4x4 vehicles with an automatic transmission follow these guidelines for recreational towing:

- Release the parking brake.
- Turn the key in the ignition to the OFF/UNLOCKED position.

Tires, Wheels and Loading

- Place the transmission in N (Neutral).
- Do not exceed a distance of 50 miles (80 km).
- Do not exceed 35 mph (56 km/h) vehicle speed.
- Put 4x4 switch in 2WD mode (4x4 only)
- The vehicle must be towed in the forward position to ensure no damage is done to the internal transfer case components.

For 4x4 vehicles with an automatic transmission, a Neutral Tow Kit must be purchased and installed by an authorized dealer if a distance of 50 miles (80 km) or a speed of 35 mph (56 km/h) must be exceeded.

For 4x2 vehicles with an automatic transmission, if a distance of 50 miles (80 km) or a speed of 35 mph (56 km/h) must be exceeded, you must disconnect the rear driveshaft. It is recommended that the driveshaft be removed/installed only by an authorized dealer. See your authorized dealer for driveshaft removal/installation.

Improper removal/installation of the driveshaft can cause transmission fluid or transfer case fluid loss, damage to the driveshaft and internal transmission and transfer case components.

CAMPER BODIES

Your pickup is not recommended for slide-in camper bodies.

STARTING

Positions of the ignition

1. ACCESSORY, allows the electrical accessories such as the radio to operate while the engine is not running.
2. LOCK, locks the steering wheel, automatic transmission gearshift lever and allows key removal. For vehicles equipped with a manual transmission, you must depress the ignition release lever to release the key.
3. OFF, shuts off the engine and all accessories without locking the steering wheel. This position also allows the automatic transmission shift lever to be moved from the P (Park) position without the brake pedal being depressed.

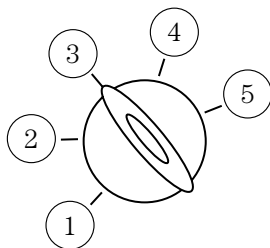

WARNING: When the key is in the ignition and in the OFF position, the automatic transmission shift lever can be moved from the P (Park) position without the brake pedal depressed. To avoid unwanted vehicle movement, always set the parking brake.

Note: On some vehicles, when the key is in the OFF position, the brake-shift interlock feature will prevent the automatic transmission shift lever from being moved out of the P (Park) position without the brake pedal being depressed.

4. ON, all electrical circuits operational. Warning lights illuminated. Key position when driving.
5. START, cranks the engine. Release the key as soon as the engine starts.

Preparing to start your vehicle

Engine starting is controlled by the powertrain control system.

Note: This system meets all Canadian Interference-Causing Equipment standard requirements regulating the impulse electrical field strength of radio noise.

When starting a fuel-injected engine, don't press the accelerator before or during starting. Only use the accelerator when you have difficulty starting the engine. For more information on starting the vehicle, refer to *Starting the engine* in this chapter.

WARNING: Extended idling at high engine speeds can produce very high temperatures in the engine and exhaust system, creating the risk of fire or other damage.

WARNING: Do not park, idle, or drive your vehicle in dry grass or other dry ground cover. The emission system heats up the engine compartment and exhaust system, which can start a fire.

WARNING: Do not start your vehicle in a closed garage or in other enclosed areas. Exhaust fumes can be toxic. Always open the garage door before you start the engine. See *Guarding against exhaust fumes* in this chapter for more instructions.

WARNING: If you smell exhaust fumes inside your vehicle, have your dealer inspect your vehicle immediately. Do not drive if you smell exhaust fumes.

Important safety precautions

When the engine starts, the idle RPM runs faster to warm the engine. If the engine idle speed does not slow down automatically, have the vehicle checked.

Before starting the vehicle:

1. Make sure all occupants buckle their seat belts. For more information on seat belts and their proper usage, refer to the *Seating and Safety Restraints* chapter.
2. Make sure the headlamps and electrical accessories are off.

Driving

If starting a vehicle with an automatic transmission:

- Make sure the parking brake is set.

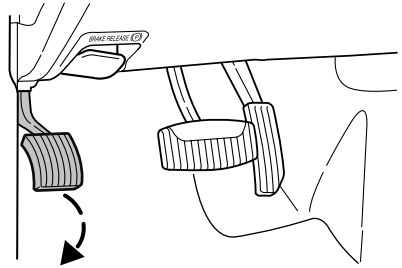

- Make sure the gearshift is in P (Park).

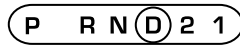

If starting a vehicle with a manual transmission:

1. Make sure the parking brake is set.
2. Push the clutch pedal to the floor.

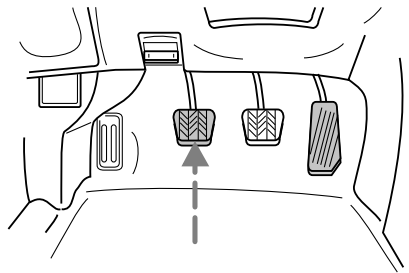

3. Turn the key to 4 (ON) without turning the key to 5 (START).

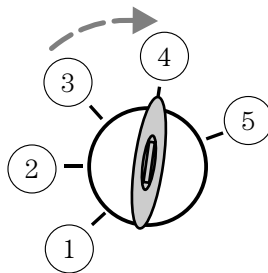

If there is difficulty in turning the key, firmly rotate the steering wheel left and right until the key turns freely. This condition may occur when:

- front wheels are turned
- front wheel is against the curb

- steering wheel is turned when getting in or out of the vehicle

Some warning lights will briefly illuminate. See *Warning lights and chimes* in the *Instrument Cluster* chapter for more information regarding the warning lights.

Starting the engine

Note: Whenever you start your vehicle, release the key as soon as the engine starts. Excessive cranking could damage the starter.

1. Turn the key to 4 (ON) without turning the key to 5 (START). If there is difficulty in turning the key, rotate the steering wheel until the key turns freely. This condition may occur when:

- the front wheels are turned
- a front wheel is against the curb

Turn the key to 5 (START), then release the key as soon as the engine starts. Excessive cranking could damage the starter.

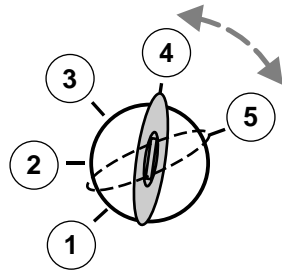

Note: If the engine does not start within five seconds on the first try, turn the key to OFF, wait 10 seconds and try again. If the engine still fails to start, press the accelerator to the floor and try again; this will allow the engine to crank with the fuel shut off in case the engine is flooded with fuel.

Guarding against exhaust fumes

Carbon monoxide is present in exhaust fumes. Take precautions to avoid its dangerous effects.

WARNING: If you smell exhaust fumes inside your vehicle, have your dealer inspect your vehicle immediately. Do not drive if you smell exhaust fumes.

Important ventilating information

If the engine is idling while the vehicle is stopped for a long period of time, open the windows at least one inch (2.5 cm) or adjust the heating or air conditioning to bring in fresh air.

ENGINE BLOCK HEATER (IF EQUIPPED)

An engine block heater warms the engine coolant which aids in starting and allows the heater/defroster system to respond quickly. If your vehicle is equipped with this system, your equipment includes a heater element which is installed in your engine block and a wire harness which allows the user to connect the system to a grounded 120 volt a/c electrical source. The block heater system is most effective when outdoor temperatures reach below 0°F (-17°C).

WARNING: Failure to follow engine block heater instructions could result in property damage or physical injury.

WARNING: To reduce the risk of electrical shock, do not use your heater with ungrounded electrical systems or two-pronged (cheater) adapters.

Prior to using the engine block heater, follow these recommendations for proper and safe operation:

- For your safety, use an outdoor extension cord that is product certified by Underwriter's laboratory (UL) or Canadian Standards Association (CSA). Use only an extension cord that can be used outdoors, in cold temperatures, and is clearly marked "Suitable for Use with Outdoor Appliances." Never use an indoor extension cord outdoors; it could result in an electric shock or fire hazard.
- Use a 16 gauge outdoor extension cord, minimum.
- Use as short an extension cord as possible.
- Do not use multiple extension cords. Instead, use one extension cord which is long enough to reach from the engine block heater cord to the outlet without stretching.
- Make certain that the extension cord is in excellent condition (not patched or spliced). Store your extension cord indoors at temperatures above 32°F (0°C). Outdoor conditions can deteriorate extension cords over a period of time.
- To reduce the risk of electrical shock, do not use your heater with ungrounded electrical systems or two pronged (cheater) adapters. Also ensure that the block heater, especially the cord, is in good condition before use.
- Make sure that when in operation, the extension cord plug /engine block heater cord plug connection is free and clear of water in order to prevent possible shock or fire.

- Be sure that areas where the vehicle is parked are clean and clear of all combustibles such as petroleum products, dust, rags, paper and similar items.
- Be sure that the engine block heater, heater cord and extension cord are solidly connected. A poor connection can cause the cord to become very hot and may result in an electrical shock or fire. Be sure to check for heat anywhere in the electrical hookup once the system has been operating for approximately a half hour.
- Finally, have the engine block heater system checked during your fall tune-up to be sure it's in good working order.

How to use the engine block heater

Ensure the receptacle terminals are clean and dry prior to use. To clean them, use a dry cloth.

Depending on the type of factory installed equipment, your engine block heater system may consume anywhere between 400 watts or 1000 watts of energy per hour. Your factory installed block heater system does not have a thermostat; however, maximum temperature is attained after approximately 3 hours of operation. Block heater operation longer than 3 hours will not improve system performance and will unnecessarily use additional electricity.

Make sure system is unplugged and properly stowed before driving the vehicle. While not in use, make sure the protective cover seals the prongs of the engine block heater cord plug.

BRAKES

Occasional brake noise is normal. If a metal-to-metal, continuous grinding or continuous squeal sound is present, the brake linings may be worn-out and should be inspected by an authorized dealer. If the vehicle has continuous vibration or shudder in the steering wheel while braking, the vehicle should be inspected by an authorized dealer.

Refer to *Brake system warning light* in the *Instrument Cluster* chapter for information on the brake system warning light.



Four-wheel anti-lock brake system (ABS)

This vehicle is equipped with an anti-lock braking system (ABS). A noise from the hydraulic pump motor and pulsation in the pedal may be observed during ABS braking events and the brake pedal may suddenly

Driving

travel a little farther as soon as ABS braking is done and normal brake operation resumes. Pedal pulsation coupled with noise while braking under panic conditions or on loose gravel, bumps, wet or snowy roads is normal and indicates proper functioning of the vehicle's anti-lock brake system.

NOTE: The ABS performs a self-check after you start the engine and begin to drive away.

A brief mechanical noise may be heard during this test. This is normal. If a malfunction is found, the ABS warning light will come on. If the vehicle has continuous vibration or shudder in the steering wheel while braking, the vehicle should be inspected by an authorized dealer.

The ABS operates by detecting the onset of wheel lockup during brake applications and compensates for this tendency. The wheels are prevented from locking even when the brakes are firmly applied. The accompanying illustration depicts the advantage of an ABS equipped vehicle (on bottom) to a non-ABS equipped vehicle (on top) during hard braking with loss of front braking traction.

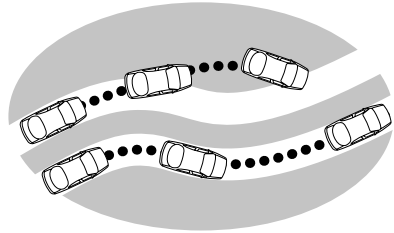

WARNING: The Anti-Lock system does not decrease the time necessary to apply the brakes or always reduce stopping distance. Always leave enough room between your vehicle and the vehicle in front of you to stop.

Using ABS

When hard braking is required, apply continuous force on the brake pedal; do not pump the brake pedal since this will reduce the effectiveness of the ABS and will increase your vehicle's stopping distance. The ABS will be activated immediately, allowing you to retain steering control during hard braking and on slippery surfaces. However, the ABS does not decrease stopping distance.

ABS warning lamp

The ABS lamp in the instrument cluster momentarily illuminates when the ignition is turned on. If the light does not illuminate during start up, remains on or flashes, the ABS may be disabled and may need to be serviced.

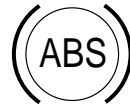

Even when the ABS is disabled, normal braking is still effective. (If your BRAKE warning lamp illuminates with the parking brake released, have your brake system serviced immediately by an authorized dealer.)



Parking brake

Apply the parking brake whenever the vehicle is parked. To set the parking brake, press the parking brake pedal down until the pedal stops.

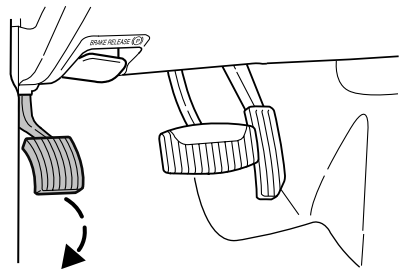

The BRAKE warning lamp in the instrument cluster illuminates and remains illuminated (when the ignition is turned ON) until the parking brake is released.



WARNING: Always set the parking brake fully and make sure that the gearshift is securely latched in P (Park) (automatic transmission) or in 1 (First) (manual transmission).

Note: The parking brake is not recommended to stop a moving vehicle. However, if the normal brakes fail, the parking brake can be used to stop your vehicle in an emergency. Since the parking brake applies only the

Driving

rear brakes, the vehicle's stopping distance will increase greatly and the handling of your vehicle will be adversely affected.

Pull the release lever to release the brake.

Driving with the parking brake on will cause the brakes to wear out quickly and reduce fuel economy.

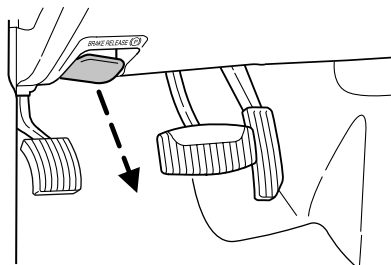

STEERING

Your vehicle is equipped with power steering. Power steering uses energy from the engine to decrease the driver's effort in steering the vehicle.

To help prevent damage to the power steering pump:

- Never hold the steering wheel to the extreme right or the extreme left for more than a few seconds when the engine is running.
- Do not operate the vehicle with the power steering pump fluid level below the MIN mark on the reservoir.
- Some noise is normal during operation. If the noise is excessive, check for low power steering pump fluid level before seeking service by your authorized dealer.
- Heavy or uneven steering efforts may be caused by low power steering pump fluid level. Check for low power steering pump fluid level before seeking service by your authorized dealer.
- Do not fill the power steering pump reservoir above the MAX mark on the reservoir, as this may result in leaks from the reservoir.

If the power steering system breaks down (or if the engine is turned off), you can steer the vehicle manually, but it takes more effort.

If the steering wanders or pulls, check for:

- Underinflated tire(s) on any wheel(s)
- Uneven vehicle loading
- High crown in center of road
- High crosswinds
- Wheels out of alignment

- Loose or worn suspension components

TRACTION-LOK AXLE (IF EQUIPPED)

This axle provides added traction on slippery surfaces, particularly when one wheel is on a poor traction surface. Under normal conditions, the Traction-Lok axle functions like a standard rear axle. The axle may exhibit a slight noise or vibration in tight turns with low vehicle speed. This is normal behavior and indicates the axle is working.

PREPARING TO DRIVE

WARNING: Utility vehicles have a significantly higher rollover rate than other types of vehicles.

WARNING: In a rollover crash, an unbelted person is significantly more likely to die than a person wearing a seat belt.

Utility vehicles and trucks have larger tires and increased ground clearance, giving the vehicle a higher center of gravity than a passenger car.

WARNING: Vehicles with a higher center of gravity such as utility vehicles and trucks handle differently than vehicles with a lower center of gravity. Utility vehicles and trucks are not designed for cornering at speeds as high as passenger cars any more than low-slung sports cars are designed to perform satisfactorily under off-road conditions. Avoid sharp turns, excessive speed or abrupt maneuvers in these vehicles. Failure to drive cautiously could result in an increased risk of loss of vehicle control, vehicle rollover, personal injury and death.

WARNING: Loaded vehicles, with a higher center of gravity, may handle differently than unloaded vehicles. Do not overload your vehicle and use extra precautions, such as driving at slower speeds, avoiding abrupt steering changes and allowing for increased stopping distance, when driving a heavily loaded vehicle. Over loading or loading the vehicle improperly can deteriorate handling capability and contribute to loss of vehicle control and vehicle rollover.

AUTOMATIC TRANSMISSION OPERATION (IF EQUIPPED)

Brake-shift interlock

This vehicle is equipped with a brake-shift interlock feature that prevents the gearshift lever from being moved from P (Park) when the ignition is in the ON position unless the brake pedal is depressed.

If you cannot move the gearshift lever out of P (Park) with ignition in the ON position and the brake pedal depressed:

1. Apply the parking brake, turn ignition key to LOCK, then remove the key.
2. Insert the key and turn it to OFF. **Apply the brake pedal and shift to N (Neutral).**

WARNING: When the key is in the ignition and in the OFF position, the automatic transmission shift lever can be moved from the P (Park) position without the brake pedal depressed. To avoid unwanted vehicle movement, always set the parking brake.

Note: On some vehicles, when the key is in the OFF position, the brake-shift interlock feature will prevent the automatic transmission shift lever from being moved out of the P (Park) position without the brake pedal being depressed.

3. Start the vehicle.

If it is necessary to use the above procedure to move the gearshift lever, it is possible that a fuse has blown or the vehicle's brakelamps are not operating properly. Refer to *Fuses and relays* in the *Roadside Emergencies* chapter.

WARNING: Do not drive your vehicle until you verify that the brakelamps are working.

WARNING: Always set the parking brake fully and make sure the gearshift is latched in P (Park). Turn the ignition to the LOCK position and remove the key whenever you leave your vehicle.

WARNING: If the parking brake is fully released, but the brake warning lamp remains illuminated, the brakes may not be working properly. See your authorized dealer.

Driving with a 5–speed automatic transmission (if equipped)

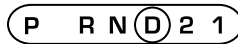

This vehicle is equipped with an adaptive Transmission Shift Strategy. Adaptive Shift Strategy offers the optimal transmission operation and shift quality. When the vehicle's battery has been disconnected for any type of service or repair, the transmission will need to relearn the normal shift strategy parameters, much like having to reset your radio stations when your vehicle battery has been disconnected. The Adaptive Transmission Strategy allows the transmission to relearn these operating parameters. This learning process could take several transmission upshifts and downshifts; during this learning process, slightly firmer shifts may occur. After this learning process, normal shift feel and shift scheduling will resume.

WARNING: Hold the brake pedal down while you move the gearshift lever from P (Park) to another position. If you do not hold the brake pedal down, your vehicle may move unexpectedly and injure someone.

P (Park)

This position locks the transmission and prevents the rear wheels from turning.

To put your vehicle in gear:

- Start the engine
- Depress the brake pedal
- Move the gearshift lever into the desired gear

To put your vehicle in P (Park):

- Come to a complete stop
- Move the gearshift lever and securely latch it in P (Park)

Driving

WARNING: Always set the parking brake fully and make sure the gearshift is latched in P (Park). Turn the ignition to the LOCK position and remove the key whenever you leave your vehicle.

R (Reverse)

With the gearshift lever in R (Reverse), the vehicle will move backward. Always come to a complete stop before shifting into and out of R (Reverse).

N (Neutral)

With the gearshift lever in N (Neutral), the vehicle can be started and is free to roll. Hold the brake pedal down while in this position.

D (Overdrive)

The normal driving position for the best fuel economy. Transmission operates in gears one through five.

D (Overdrive) can be deactivated by pressing the transmission control switch on the end of the gearshift lever.

This will illuminate the O/D OFF lamp and activate Drive.

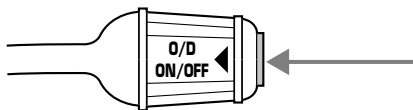

**O/D
OFF**

Drive (not shown)

Drive is activated when the transmission control switch is pressed.

- This position allows for all forward gears except overdrive.
- O/D OFF lamp is illuminated.
- Provides engine braking.
- Use when driving conditions cause excessive shifting from O/D to other gears. Examples: city traffic, hilly terrain, heavy loads, trailer towing and when engine braking is required.
- To return to O/D (overdrive mode), press the transmission control switch. The O/D OFF lamp will not be illuminated.
- O/D (Overdrive) is automatically returned each time the key is turned off.

2 (Second)

Use 2 (Second) to start-up on slippery roads or to provide additional engine braking on downgrades.

1 (First)

- Provides maximum engine braking.
- Allows upshifts by moving gearshift lever.
- Will not downshift into 1 (First) at high speeds; allows for 1 (First) when vehicle reaches slower speeds.

Forced downshifts

- Allowed in **D** (Overdrive) or Drive.
- Depress the accelerator to the floor.
- Allows transmission to select an appropriate gear.

MANUAL TRANSMISSION OPERATION (IF EQUIPPED)

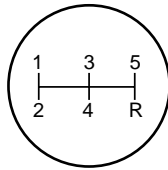

Using the clutch

The manual transmission has a starter interlock that prevents cranking the engine unless the clutch pedal is fully depressed.

To start the vehicle:

1. Make sure the parking brake is fully set.
2. Press the clutch pedal to the floor, then put the gearshift lever in the neutral position.
3. Start the engine.
4. Press the brake pedal and move the gearshift lever to the desired gear; 1 (First) or R (Reverse).
5. Release the parking brake, then slowly release the clutch pedal while slowly pressing on the accelerator.

During each shift, the clutch pedal must be fully depressed to the floor. Make sure the floor mat is properly positioned so it doesn't interfere with the full extension of the clutch pedal.

Failure to fully depress the clutch pedal to the floor may cause increased shift efforts, prematurely wear transmission components or damage the transmission.

Do not drive with your foot resting on the clutch pedal or use the clutch pedal to hold your vehicle at a standstill while waiting on a hill. These actions will reduce the life of the clutch.

Recommended shift speeds

Downshift according to the following charts for your specific engine/drivetrain combination:

Upshifts		
Shift from:	Transfer case position (if equipped)	
	2WD and 4H	4L
1 - 2	10 mph (16 km/h)	4 mph (6 km/h)
2 - 3	19 mph (26 km/h)	8 mph (10 km/h)
3 - 4	28 mph (43 km/h)	12 mph (16 km/h)
4 - 5 (Overdrive)	40 mph (68 km/h)	16 mph (26 km/h)
Maximum downshift speeds		
Shift from:	Transfer case position (if equipped)	
	2WD and 4H	4L
5 (Overdrive) - 4	55 mph (88 km/h)	22 mph (34 km/h)
4 - 3	45 mph (72 km/h)	18 mph (27 km/h)
3 - 2	35 mph (56 km/h)	14 mph (21 km/h)
2 - 1	20 mph (32 km/h)	8 mph (11 km/h)

Reverse

1. Make sure that your vehicle is at a complete stop before you shift into R (Reverse). Failure to do so may damage the transmission.
 2. Move the gearshift lever into the neutral position and wait at least three seconds before shifting into R (Reverse).
- The gearshift lever can only be moved into R (Reverse) by moving it from left of 3 (Third) and 4 (Fourth) before shifting into R (Reverse). This is a lockout feature that protects the transmission from accidentally being shifted into R (Reverse) from 5 (Overdrive).

Parking your vehicle

1. Apply the brake and shift into the neutral position.
2. Fully apply the parking brake, then shift into 1 (First).

3. Turn the ignition off.

WARNING: Do not park your vehicle in Neutral, it may move unexpectedly and injure someone. Use 1 (First) gear and set the parking brake fully.

Removing the key

Turn the ignition off, push the release lever (located above the ignition), then turn the key toward you and remove the key.



If your vehicle gets stuck in mud or snow

If your vehicle gets stuck in mud or snow, it may be rocked out by shifting between forward and reverse gears, stopping between shifts in a steady pattern. Press lightly on the accelerator in each gear.

Do not rock the vehicle if the engine is not at normal operating temperature or damage to the transmission may occur.

Do not rock the vehicle for more than a minute or damage to the transmission and tires may occur, or the engine may overheat.

FOUR-WHEEL DRIVE (4WD) OPERATION (IF EQUIPPED)

WARNING: For important information regarding safe operation of this type of vehicle, see Preparing to drive your vehicle in this chapter.

Four-wheel drive (4WD) supplies power to all four wheels. 4WD should not be operated on dry pavement; driveline damage may occur.

If equipped with the Electronic Shift 4WD System, and 4WD Low is selected while the vehicle is moving above 3 mph (5 km/h), the 4WD system will not engage. This is normal and should be no reason for concern. Refer to *Shifting to/from 4WD Low* for proper operation.

4WD system indicator lights

- **4x4** - Momentarily illuminates when the vehicle is started. Illuminates when 4H (4WD High) is engaged. **4x4**
- **4x4 LOW** – Momentarily illuminates when the vehicle is started. Illuminates when 4L (4WD Low) is engaged. **4x4 LOW**

Using the electronic shift 4WD system

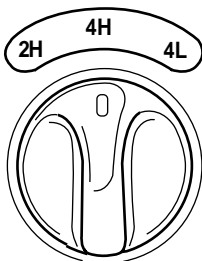

2H (2WD High) - Power to the rear wheels only; used for street and highway driving.

4H (4WD High) - Used for extra traction such as in snow or icy roads or in off-road situations. Not intended for use on dry pavement.

4L (4WD Low) - Uses extra gearing to provide maximum power to all four wheels. Intended only for off-road applications such as deep sand, steep grades or pulling heavy objects. 4L (4WD Low) will not engage while the vehicle is moving; this is normal and should be no reason for concern. Refer to *Shifting to/from 4L (4WD Low)* for proper operation.

Shifting between 2H (2WD High) and 4H (4WD High)

- Move the 4WD control between 2H and 4H at a stop or any forward speed.

Note: Do not perform this operation if the rear wheels are slipping.

Shifting to/from 4L (4WD Low)

Note: Some noise may be heard as the 4WD system shifts or engages. This is normal and should be no reason for concern.

1. Bring the vehicle to a complete stop

2. On vehicles equipped with an automatic transmission, place the transmission in N (Neutral); on vehicles equipped with a manual transmission, depress the clutch.
3. Move the 4WD control to the desired position.
 - If shifting into 4L (4WD Low), wait for the 4WD LOW light in the instrument cluster to turn **on** indicating the shift is complete.
 - If shifting out of 4L (4WD Low), wait for the 4WD LOW light in the instrument cluster to turn **off** indicating the shift is complete.

Driving off-road with 4WD

Your vehicle is specially equipped for driving on sand, snow, mud and rough terrain and has operating characteristics that are somewhat different from conventional vehicles, both on and off the road.

How your vehicle differs from other vehicles

Trucks and utility vehicles can differ from some other vehicles. Your vehicle may be higher to allow it to travel over rough terrain without getting hung up or damaging underbody components.

The differences that make your vehicle so versatile also make it handle differently than an ordinary passenger car.

Maintain steering wheel control at all times, especially in rough terrain. Since sudden changes in terrain can result in abrupt steering wheel motion, make sure you grip the steering wheel from the outside. Do not grip the spokes.

Drive cautiously to avoid vehicle damage from concealed objects such as rocks and stumps.

You should either know the terrain or examine maps of the area before driving. Map out your route before driving in the area. To maintain steering and braking control of your vehicle, you must have all four wheels on the ground and they must be rolling, not sliding or spinning.

Basic operating principles

- Do not use 4WD on dry, hard surfaced roads. Doing so will produce excessive noise, increase tire wear and may damage drive components. 4WD modes are only intended for consistently slippery or loose surfaces.
- Drive slower in strong crosswinds which can affect the normal steering characteristics of your vehicle.
- Be extremely careful when driving on pavement made slippery by loose sand, water, gravel, snow or ice.

If your vehicle goes off the edge of the pavement

- If your vehicle goes off the edge of the pavement, slow down, but avoid severe brake application, ease the vehicle back onto the pavement only after reducing your speed. Do not turn the steering wheel too sharply while returning to the road surface.
- It may be safer to stay on the apron or shoulder of the road and slow down gradually before returning to the pavement. You may lose control if you do not slow down or if you turn the steering wheel too sharply or abruptly.
- It often may be less risky to strike small objects, such as highway reflectors, with minor damage to your vehicle rather than attempt a sudden return to the pavement which could cause the vehicle to slide sideways out of control or roll over. Remember, your safety and the safety of others should be your primary concern.

WARNING: Vehicles with a higher center of gravity such as utility and four-wheel drive vehicles handle differently than vehicles with a lower center of gravity. Utility and four-wheel drive vehicles are not designed for cornering at speeds as high as passenger cars any more than low-slung sports cars are designed to perform satisfactorily under off-road conditions. Avoid sharp turns, excessive speed and abrupt maneuvers in these vehicles. Failure to drive cautiously could result in an increased risk of loss of vehicle control, vehicle rollover, personal injury and death.

If your vehicle gets stuck

If the vehicle is stuck it may be rocked out by shifting from forward and reverse gears, stopping between shifts, in a steady pattern. Press lightly on the accelerator in each gear.

Do not rock the vehicle if the engine is not at normal operating temperature or damage to the transmission may occur.

Do not rock the vehicle for more than a few minutes or damage to the transmission and tires may occur or the engine may overheat.

WARNING: Do not spin the wheels at over 35 mph (56 km/h). The tires may fail and injure a passenger or bystander.

Emergency maneuvers

- In an unavoidable emergency situation where a sudden sharp turn must be made, remember to avoid “over-driving” your vehicle, i.e., turn the steering wheel only as rapidly and as far as required to avoid the emergency. Excessive steering will result in less vehicle control, not more. Additionally, smooth variations of the accelerator and/or brake pedal pressure should be utilized if changes in vehicle speed are called for. Avoid abrupt steering, acceleration or braking which could result in an increased risk of loss of vehicle control, vehicle rollover and/or personal injury. Use all available road surface to return the vehicle to a safe direction of travel.
- In the event of an emergency stop, avoid skidding the tires and do not attempt any sharp steering wheel movements.

WARNING: Vehicles with a higher center of gravity such as utility and four-wheel drive vehicles handle differently than vehicles with a lower center of gravity. Utility and four-wheel drive vehicles are not designed for cornering at speeds as high as passenger cars any more than low-slung sports cars are designed to perform satisfactorily under off-road conditions. Avoid sharp turns, excessive speed and abrupt maneuvers in these vehicles. Failure to drive cautiously could result in an increased risk of loss of vehicle control, vehicle rollover, personal injury and death.

- If the vehicle goes from one type of surface to another (i.e., from concrete to gravel) there will be a change in the way the vehicle responds to a maneuver (steering, acceleration or braking). Again, avoid these abrupt inputs.

Sand

When driving over sand, try to keep all four wheels on the most solid area of the trail. Do not reduce the tire pressures but shift to a lower gear and drive steadily through the terrain. Apply the accelerator slowly and avoid spinning the wheels.

Note: The Tire Pressure Monitoring System (TPMS) indicator light may illuminate depending on how much air is released from your tires and/or how long you drive the vehicle under these conditions

Mud and water

If you must drive through high water, drive slowly. Traction or brake capability may be limited.

When driving through water, determine the depth; avoid water higher than the bottom of the hubs (if possible) and proceed slowly. If the ignition system gets wet, the vehicle may stall.

Once through water, always try the brakes. Wet brakes do not stop the vehicle as effectively as dry brakes. Drying can be improved by moving your vehicle slowly while applying light pressure on the brake pedal.

After driving through mud, clean off residue stuck to the driveshafts and tires. Excess mud stuck on tires and rotating driveshafts causes an imbalance that could damage drive components.

If the transmission, transfer case or front axle are submerged in water, their fluids should be checked and changed, if necessary.

Driving through deep water where the transmission vent tube is submerged may allow water into the transmission and cause internal transmission damage.

Replace rear axle lubricant any time the axle has been submerged in water. The rear axle does not normally require a lubricant change for the life of the vehicle. Rear axle lubricant quantities are not to be checked or changed unless a leak is suspected or repair is required.

Driving on hilly or sloping terrain

When driving on a hill, avoid driving crosswise or turning on steep slopes. You could lose traction and slip sideways. Drive straight up, straight down or avoid the hill completely. Know the conditions on the other side of a hill before driving over the crest.

When climbing a steep hill, start in a lower gear rather than downshifting to a lower gear from a higher gear once the ascent has started. This reduces strain on the engine and the possibility of stalling.

When descending a steep hill, avoid sudden braking. Shift to a lower gear when added engine braking is desired.

When speed control is on and you are driving uphill, your vehicle speed may drop considerably, especially if you are carrying a heavy load.

If vehicle speed drops more than 10 mph (16 km/h), the speed control will cancel automatically. Resume speed with accelerator pedal.

If speed control cancels after climbing the hill, reset speed by pressing and holding the SET ACCEL button (to resume speeds over 30 mph [50 km/h]).

Automatic transmissions may shift frequently while driving up steep grades. Eliminate frequent shifting by shifting out of **D** (Overdrive) into a lower gear.

Driving on snow and ice

A 4WD vehicle has advantages over 2WD vehicles in snow and ice but can skid like any other vehicle.

Avoid sudden applications of power and quick changes of direction on snow and ice. Apply the accelerator slowly and steadily when starting from a full stop.

When braking, apply the brakes as you normally would. In order to allow the anti-lock brake system (ABS) to operate properly, keep steady pressure on the brake pedal.

Make sure you allow sufficient distance between you and other vehicles for stopping. Drive slower than usual and consider using one of the lower gears.

DRIVING THROUGH WATER

If driving through deep or standing water is unavoidable, proceed very slowly especially when the depth is not known. Never drive through water that is higher than the bottom of the wheel rims (for cars) or the bottom of the hubs (for trucks).

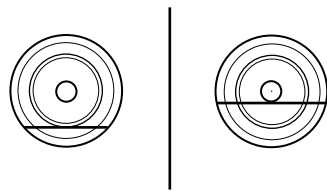

When driving through water, traction or brake capability may be limited. Also, water may enter your engine's air intake and severely damage your engine or your vehicle may stall. **Driving through deep water where the transmission vent tube is submerged may allow water into the transmission and cause internal transmission damage.**

Once through the water, always dry the brakes by moving your vehicle slowly while applying light pressure on the brake pedal. Wet brakes do not stop the vehicle as quickly as dry brakes.

Roadside Emergencies

HAZARD FLASHER CONTROL

The hazard flasher is located on the steering column, just behind the steering wheel. The hazard flashers will operate when the ignition is in any position or if the key is not in the ignition.

Push in the flasher control and all front and rear direction signals will flash. Press the flasher control again to turn them off. Use it when your vehicle is disabled and is creating a safety hazard for other motorists.

Note: With extended use, the flasher may run down your battery.

FUEL PUMP SHUT-OFF SWITCH

This device stops the electric fuel pump from sending fuel to the engine when your vehicle has had a substantial jolt.

After an accident, if the engine cranks but does not start, this switch may have been activated.

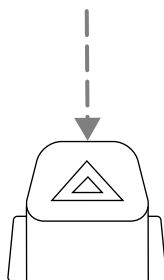

The fuel pump shut-off switch is located on the right side of the passenger footwell, behind the fuse panel door.

To reset the switch:

1. Turn the ignition OFF.
2. Check the fuel system for leaks.
3. If no leaks are apparent, reset the switch by pushing in on the reset button.
4. Turn the ignition ON.
5. Wait a few seconds and return the key to OFF.
6. Make another check for leaks.

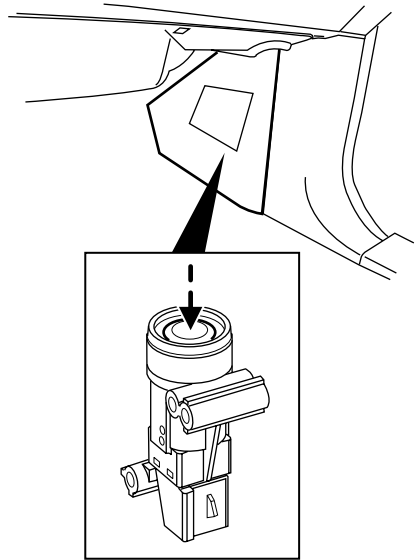

FUSES AND RELAYS

Fuses

If electrical components in the vehicle are not working, a fuse may have blown. Blown fuses are identified by a broken wire within the fuse. Check the appropriate fuses before replacing any electrical components.

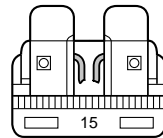

Note: Always replace a fuse with one that has the specified amperage rating. Using a fuse with a higher amperage rating can cause severe wire damage and could start a fire.

Roadside Emergencies

Standard fuse amperage rating and color

COLOR					
Fuse rating	Mini fuses	Standard fuses	Maxi fuses	Cartridge maxi fuses	Fuse link cartridge
2A	Grey	Grey	—	—	—
3A	Violet	Violet	—	—	—
4A	Pink	Pink	—	—	—
5A	Tan	Tan	—	—	—
7.5A	Brown	Brown	—	—	—
10A	Red	Red	—	—	—
15A	Blue	Blue	—	—	—
20A	Yellow	Yellow	Yellow	Blue	Blue
25A	Natural	Natural	—	—	—
30A	Green	Green	Green	Pink	Pink
40A	—	—	Orange	Green	Green
50A	—	—	Red	Red	Red
60A	—	—	Blue	Yellow	Yellow
70A	—	—	Tan	—	Brown
80A	—	—	Natural	Black	Black

Passenger compartment fuse panel

The fuse panel is located under the right-hand side of the instrument panel behind the kick panel. A fuse puller tool is located near the lower right corner of the fuse box; this tool will assist you in pulling the fuses out for inspection, if necessary.

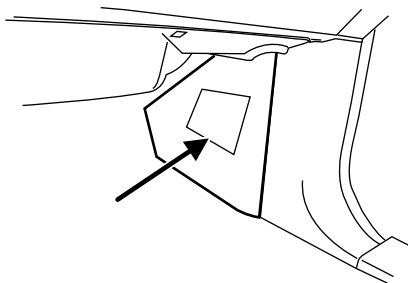

Roadside Emergencies

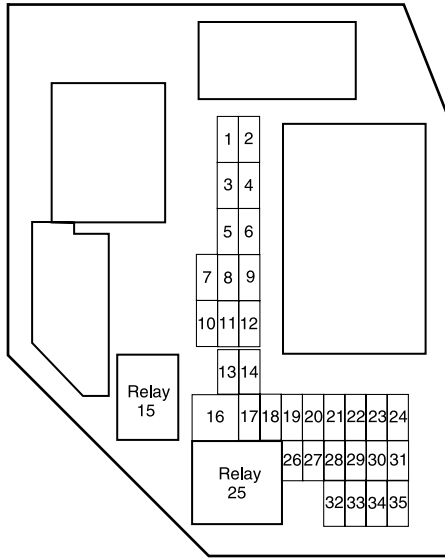

The fuses are coded as follows:

Fuse/Relay Location	Fuse Amp Rating	Passenger Compartment Fuse Panel Description
1	5A	Instrument panel dimmer switch
2	10A	Trailer tow park lamps
3	10A	Right low beam headlamp
4	10A	Left low beam headlamp
5	5A	Windshield wiper module (RUN/ACCY)
6	10A	Radio (RUN/ACCY), Door switch illumination
7	5A	Not used (spare)
8	10A	Restraints Control Module (RCM), PADI (Passenger Air bag Deactivation Indicator), Occupant Classification Sensor (OCS)
9	5A	Cluster air bag indicator

Roadside Emergencies

Fuse/Relay Location	Fuse Amp Rating	Passenger Compartment Fuse Panel Description
10	10A	Cluster (RUN/START), 4x4 module (RUN/START)
11	10A	Smart Junction Box (SJB) (Logic power)
12	15A	Audiophile subwoofer amplifier, Satellite radio
13	15A	Horn, Interior lamps
14	15A	High beam headlamp, High beam indicator (cluster)
15	—	Not used
16	30A cartridge fuse	Power windows
17	15A	Turn signals/Hazards
18	—	Not used
19	20A	Center High-Mounted Stop Lamp (CHMSL)/Stop lamps
20	10A	Anti-lock Brake System (ABS) module, Speed control module, Back-up lamps, Overdrive cancel switch, Electronic flasher (turn/hazard)
21	5A	Starter relay coil
22	5A	Radio (START)
23	30A	Headlamps (low and high beam)
24	20A	Radio battery feed (B+)
25	—	Accessory relay (power windows)
26	2A	Redundant cruise switch
27	10A	Climate control blower relay/blend doors
28	15A	4x4 module battery feed (B+)
29	20A	Cigar lighter, Diagnostic connector (OBD II)
30	5A	Power mirrors

Fuse/Relay Location	Fuse Amp Rating	Passenger Compartment Fuse Panel Description
31	20A	Front park lamps, Rear park lamps, License plate lamps, Dimmer switch, Trailer tow park lamps
32	5A	Brake switch (logic), Brake-shift interlock
33	5A	Instrument cluster battery feed (B+)
34	20A	Power point
35	15A	Power locks

Power distribution box

The power distribution box is located in the engine compartment. The power distribution box contains high-current fuses that protect your vehicle's main electrical systems from overloads.

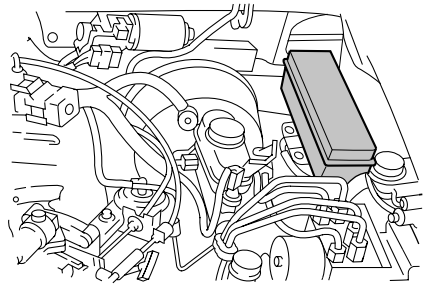

WARNING: Always disconnect the battery before servicing fuses.

WARNING: To reduce risk of electrical shock, always replace the cover to the Power Distribution Box before reconnecting the battery or refilling fluid reservoirs.

If the battery has been disconnected and reconnected, refer to the *Battery* section of the *Maintenance and specifications* chapter.

Roadside Emergencies

2.3L engine (if equipped)

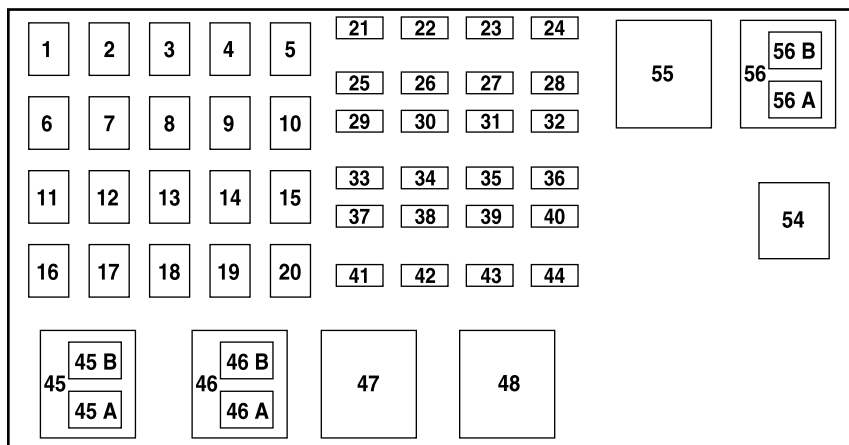

The high-current fuses are coded as follows:

Fuse/Relay Location	Fuse Amp Rating	Power Distribution Box Description
1	40A**	Passenger compartment fuse panel
2	—	Not used
3	40A**	Passenger compartment fuse panel
4	—	Not used
5	50A**	Passenger compartment fuse panel
6	—	Not used
7	30A**	Starter solenoid
8	—	Not used
9	40A**	Ignition switch
10	—	Not used
11	30A**	Powertrain Control Module (PCM) relay
12	—	Not used
13	30A**	Blower motor (climate control)
14	—	Not used

Roadside Emergencies

Fuse/Relay Location	Fuse Amp Rating	Power Distribution Box Description
15	—	Not used
16	—	Not used
17	40A**	Anti-lock Brake System (ABS) module
18	—	Not used
19	20A**	Engine fan
20	—	Not used
21	10A*	PCM keep alive power, Canister purge valve solenoid
22	—	Not used
23	30A*	Fuel pump motor, Fuel injectors
24	—	Not used
25	10A*	A/C clutch solenoid
26	—	Not used
27	—	Not used
28	—	Not used
29	30A*	Wipers/washer
30	—	Not used
31	—	Not used
32	—	Not used
33	30A*	Anti-lock Brake System (ABS) module
34	—	Not used
35	—	Not used
36	—	Not used
37	—	Not used
38	7.5A*	Trailer tow (right turn)
39	15A*	PCM power
40	—	Not used
41	10A*	Automatic transmission
42	7.5A*	Trailer tow (left turn)
43	20A*	Engine fan relay coil, A/C relay, Engine sensors, VMV solenoid

Roadside Emergencies

Fuse/Relay Location	Fuse Amp Rating	Power Distribution Box Description
44	15A*	Ignition coil, Capacitor
45A	—	Not used
45B	—	Not used
46A	—	Fuel pump relay, Fuel injectors relay
46B	—	Not used
47	—	Engine fan relay
48	—	Starter relay
49	—	Not used
50	—	Not used
51	—	Not used
52	—	Not used
53	—	Not used
54	—	PCM relay
55	—	Blower relay
56A	—	A/C clutch solenoid relay
56B	—	Not used
* Mini Fuses ** Maxi Fuses		

3.0L and 4.0L engines (if equipped)

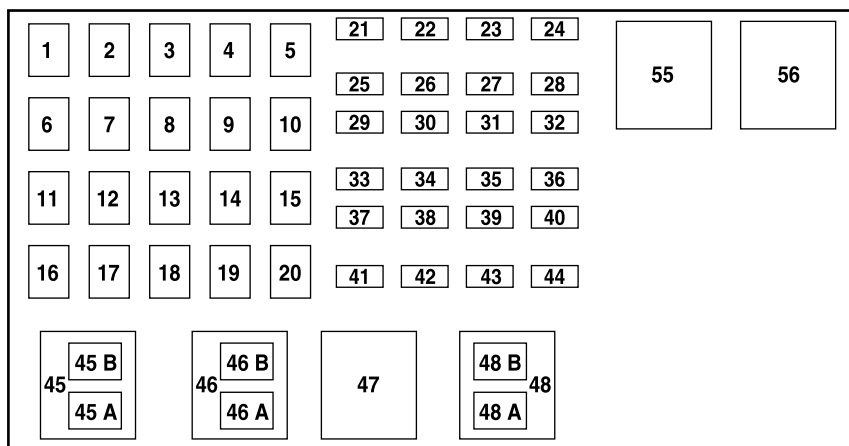

The high-current fuses are coded as follows:

Fuse/Relay Location	Fuse Amp Rating	Power Distribution Box Description
1	40A**	Passenger compartment fuse panel
2	—	Not used
3	40A**	Passenger compartment fuse panel
4	—	Not used
5	50A**	Passenger compartment fuse panel
6	—	Not used
7	30A**	Starter solenoid
8	—	Not used
9	40A**	Ignition switch
10	—	Not used
11	30A**	Powertrain Control Module (PCM) relay fuse
12	—	Not used
13	30A**	Blower motor (climate control)
14	—	Not used

Roadside Emergencies

Fuse/Relay Location	Fuse Amp Rating	Power Distribution Box Description
15	—	Not used
16	—	Not used
17	40A**	Anti-lock Brake System (ABS) module
18	—	Not used
19	—	Not used
20	—	Not used
21	10A*	PCM keep alive power, Canister purge valve solenoid
22	—	Not used
23	30A*	Fuel pump motor, Fuel injectors
24	—	Not used
25	10A*	A/C clutch solenoid
26	—	Not used
27	20A*	4x4 module
28	—	Not used
29	30A*	Wipers/washer
30	—	Not used
31	15A*	Foglamps
32	—	Not used
33	30A*	Anti-lock Brake System (ABS) module
34	—	Not used
35	—	Not used
36	—	Not used
37	—	Not used
38	7.5A*	Trailer tow (right turn)
39	15A*	PCM power
40	—	Not used
41	10A*	Automatic transmission
42	7.5A*	Trailer tow (left turn)
43	20A*	A/C relay coil, Engine sensors, VMV solenoid, EGR solenoid, Heated PCV

Fuse/Relay Location	Fuse Amp Rating	Power Distribution Box Description
44	15A*	Ignition coil, Capacitor
45A	—	Not used
45B	—	Not used
46A	—	A/C clutch solenoid
46B	—	Not used
47	—	PCM relay
48A	—	Fuel pump relay, Fuel injectors relay
48B	—	Fog lamp relay
51	—	Not used
52	—	Not used
53	—	Not used
54	—	Not used
55	—	Blower relay
56	—	Starter relay
* Mini Fuses ** Maxi Fuses		

CHANGING THE TIRES

If you get a flat tire while driving:

- do not brake heavily.
- gradually decrease the vehicle's speed.
- hold the steering wheel firmly.
- slowly move to a safe place on the side of the road.

Note: The tire pressure monitoring system (TPMS) indicator light will illuminate when the spare is in use. To restore the full functionality of the monitoring system, all road wheels equipped with tire pressure monitoring sensors must be mounted on the vehicle.

Have a flat serviced by an authorized dealer in order to prevent damage to the TPMS sensor, refer to *Changing tires with TPMS* in the *Tires, Wheels and Loading* chapter. Replace the spare tire with a road tire as soon as possible.

WARNING: The use of tire sealants may damage your Tire Pressure Monitoring System and should not be used.

Roadside Emergencies

WARNING: Refer to *Tire Pressure Monitoring System (TPMS)* in the *Tires, Wheels and Loading* chapter for important information. If the tire pressure monitor sensor becomes damaged, it will no longer function.

Dissimilar spare tire/wheel information

WARNING: Failure to follow these guidelines could result in an increased risk of loss of vehicle control, injury or death.

If you have a dissimilar spare tire/wheel, then it is intended for temporary use only. This means that if you need to use it, you should replace it as soon as possible with a road tire/wheel that is the same size and type as the road tires and wheels that were originally provided by Mazda. If the dissimilar spare tire or wheel is damaged, it should be replaced rather than repaired.

A dissimilar spare tire/wheel is defined as a spare tire and/or wheel that is different in brand, size or appearance from the road tires and wheels and can be one of three types:

1. **T-type mini-spare:** This spare tire begins with the letter “T” for tire size and may have “Temporary Use Only” molded in the sidewall
2. **Full-size dissimilar spare with label on wheel:** This spare tire has a label on the wheel that states: “THIS TIRE AND WHEEL FOR TEMPORARY USE ONLY”

When driving with one of the dissimilar spare tires listed above, **do not:**

- Exceed 50 mph (80 km/h)
- Load the vehicle beyond maximum vehicle load rating listed on the Safety Compliance Label
- Tow a trailer
- Use snow chains on the end of the vehicle with the dissimilar spare tire
- Use more than one dissimilar spare tire at a time
- Use commercial car washing equipment
- Try to repair the dissimilar spare tire

Use of one of the dissimilar spare tires listed above at any one wheel location can lead to impairment of the following:

- Handling, stability and braking performance

- Comfort and noise
- Ground clearance and parking at curbs
- Winter weather driving capability
- Wet weather driving capability

For vehicles equipped with 4WD, it is not recommended that the vehicle be operated in 4WD modes with a temporary emergency spare tire. If 4WD operation is necessary, do not operate above speeds of 10 mph (16 km/h) or for distances above 50 miles (80 km).

3. **Full-size dissimilar spare without label on wheel**

When driving with the full-size dissimilar spare tire/wheel, **do not:**

- Exceed 70 mph (113 km/h)
- Use more than one dissimilar spare tire/wheel at a time
- Use commercial car washing equipment
- Use snow chains on the end of the vehicle with the dissimilar spare tire/wheel

The usage of a full-size dissimilar spare tire/wheel can lead to impairment of the following:

- Handling, stability and braking performance
- Comfort and noise
- Ground clearance and parking at curbs
- Winter weather driving capability
- Wet weather driving capability
- All-Wheel driving capability (if applicable)
- Load leveling adjustment (if applicable)

When driving with the full-size dissimilar spare tire/wheel additional caution should be given to:

- Towing a trailer
- Driving vehicles equipped with a camper body
- Driving vehicles with a load on the cargo rack

Drive cautiously when using a full-size dissimilar spare tire/wheel and seek service as soon as possible.

Roadside Emergencies

Stopping and securing the vehicle

1. Park on a level surface, activate hazard flashers and place gearshift lever in P (Park) (automatic transmission) or 1 (First) (manual transmission).
2. Set the parking brake and turn engine OFF.

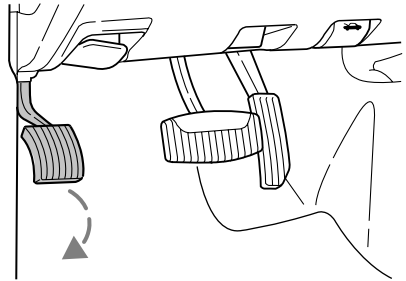

Location of the spare tire and tools

Note: The tire pressure monitoring system (TPMS) indicator light will illuminate when the spare is in use. To restore the full functionality of the TPMS system, all road wheels equipped with the tire pressure monitoring sensors must be mounted on the vehicle.

Have a flat tire serviced by an authorized dealer in order to prevent damage to the TPMS sensor, refer to *Tire Pressure Monitoring System (TPMS)* in the *Tires, Wheel and Loading* chapter. Replace the spare tire with a road tire as soon as possible.

The spare tire and tools for your vehicle are stowed in the following locations:

Tool	Location
Spare tire	Under the vehicle, just forward of the rear bumper
Jack, jack handle, wheel nut wrench	Regular Cab: behind seats and underneath the jack and tools cover Cab Plus 4-Door: stowed behind the front seats, between jump seats and underneath jack and tools cover. The lug wrench is held in place with a wingnut.
Key, spare tire lock (if equipped)	In the glove box

Removing the spare tire

1. Assemble the jack handle to the lug wrench as shown in the illustrations.

Roadside Emergencies

When connecting the jack handle, assemble the following:

- one handle extension and one typical extension. To assemble, slide parts together. To disconnect, depress button and pull apart.
- one wheel nut wrench. Depress button and slide together.

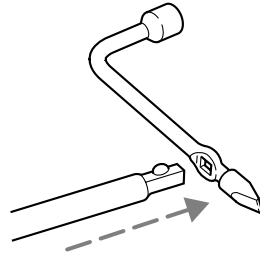
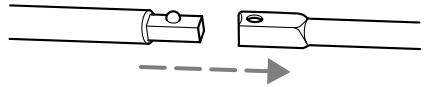

2. If equipped, unlock and remove the spare tire carrier lock from the rear access hole located just above the rear bumper and below the tailgate.

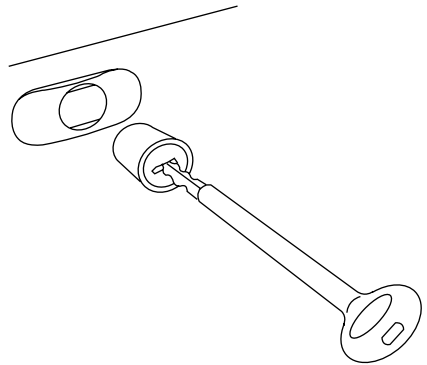

Roadside Emergencies

3. Insert the square end of the jack handle into the rear access hole located just above the rear bumper and below the tailgate.

Forward motion will stop and resistance to turning will be felt when properly engaged.

4. Turn the handle counterclockwise until tire is lowered to the ground and the cable is slightly slack.
5. Remove the retainer from the spare tire.

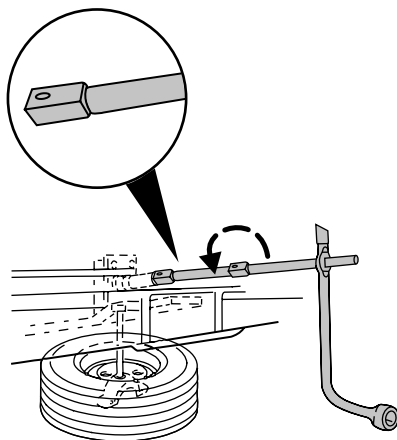

Tire change procedure

WARNING: When one of the front wheels is off the ground, the transmission alone will not prevent the vehicle from moving or slipping off the jack, even if the vehicle is in P (Park) (automatic transmission) or R (Reverse) (manual transmission).

WARNING: To help prevent the vehicle from moving when you change a tire, be sure the parking brake is set, then block (in both directions) the wheel that is diagonally opposite (other side and end of the vehicle) to the tire being changed.

WARNING: If the vehicle slips off the jack, you or someone else could be seriously injured.

WARNING: Do not attempt to change a tire on the side of the vehicle close to moving traffic. Pull far enough off the road to avoid the danger of being hit when operating the jack or changing the wheel.

Roadside Emergencies

1. Block the diagonally opposite wheel.

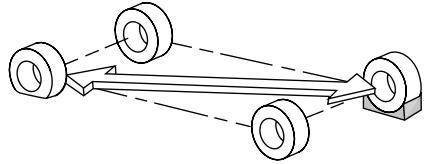

2. Insert tapered end of the lug wrench behind hub caps and twist them off.
3. Loosen each wheel lug nut one-half turn counterclockwise but do not remove them until the wheel is raised off the ground.
4. Position the jack according to the following guides and turn the jack handle clockwise until the tire is a maximum of 1 inch (25 mm) off the ground.

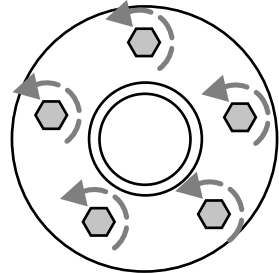

WARNING: To lessen the risk of personal injury, do not put any part of your body under the vehicle while changing a tire. Do not start the engine when your vehicle is on the jack. The jack is only meant for changing the tire.

WARNING: Do not let anyone stay in the vehicle when you are using the jack; have them stand in a safe place out of traffic lanes.

- Front

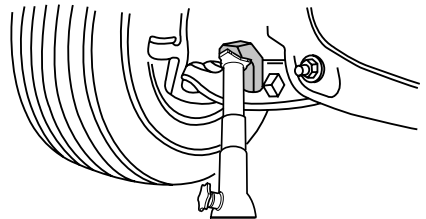

Roadside Emergencies

- Rear

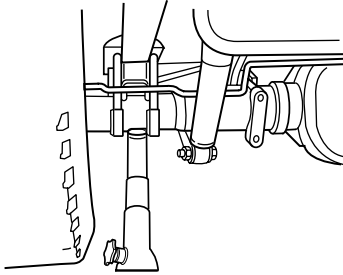

Never use the differential as a jacking point. It is too easy for the vehicle to tilt or fall and you can be injured.

5. Remove the wheel lug nuts with the lug wrench.
6. Replace the flat tire with the spare tire, making sure the valve stem is facing outward. Reinstall the lug nuts until the wheel is snug against the hub. Do not fully tighten the lug nuts until the wheel has been lowered.
7. Lower the wheel by turning the jack handle counterclockwise.
8. Remove the jack and fully tighten the lug nuts, in the order shown. Refer to *Wheel lug nut torque specifications* later in this chapter for the proper lug nut torque specification.
9. Stow the flat tire. Refer to *Stowing the spare tire*.
10. Stow the jack and lug wrench. Make sure the jack is fastened so it does not rattle when you drive.
11. Unblock the wheels.

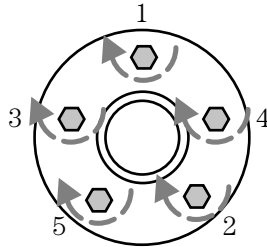
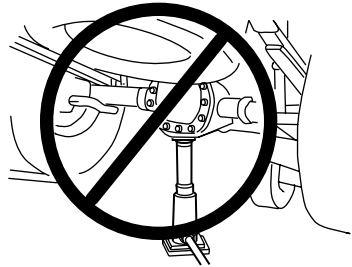

Stowing the flat/spare tire

Note: Failure to follow spare tire stowage instructions may result in failure of cable or loss of spare tire.

1. Lay the tire on the ground with the valve stem facing up.
2. Slide the wheel partially under the vehicle and install the wire and retainer through the center of the wheel.
3. Turn the jack handle clockwise until the tire is raised to its original position underneath the vehicle. The effort to turn the jack handle increases significantly as the tire contacts the frame. The spare tire carrier will ratchet when the tire is in the fully stowed position. The spare tire carrier has a built-in ratchet feature that will not allow you to overtighten. If the spare tire carrier ratchets with very little effort, take the vehicle to your authorized dealer for assistance at your earliest convenience.
4. Check that the tire lies flat against the frame assembly. Push against the tire to make sure it is tightly seated under the vehicle. Loosen and retighten, if necessary. Failure to properly stow the spare tire may result in failure of the winch cable and loss of the spare tire.
5. Repeat this tightness check procedure when servicing the spare tire pressure (every six months, per *Service Maintenance Section*), or at any time that the spare tire is disturbed through service of other components.
6. Install the spare tire lock (if equipped) into the access hole above the rear bumper with the spare tire lock key (if equipped) and jack handle.

WHEEL LUG NUT TORQUE SPECIFICATIONS

Retighten the lug nuts to the specified torque within 100 miles (160 km) after any wheel disturbance (rotation, flat tire, wheel removal, etc.).

Lug nut socket size/Bolt size	Wheel lug nut torque*	
	lb.ft.	N•m
Lug nut socket size: ¾ inch (19 mm) hex Bolt size: ½ x 20	100	135
* Torque specifications are for nut and bolt threads free of dirt and rust. Use only Mazda recommended replacement fasteners.		

Roadside Emergencies

WARNING: When a wheel is installed, always remove any corrosion, dirt or foreign materials present on the mounting surfaces of the wheel or the surface of the wheel hub, brake drum or brake disc that contacts the wheel. Ensure that any fasteners that attach the rotor to the hub are secured so they do not interfere with the mounting surfaces of the wheel. Installing wheels without correct metal-to-metal contact at the wheel mounting surfaces can cause the wheel nuts to loosen and the wheel to come off while the vehicle is in motion, resulting in loss of control.

Note: Inspect the wheel pilot hole prior to installation. If there is visible corrosion in wheel pilot hole, remove loose particles by wiping with clean rag and apply grease. Apply grease only to the wheel pilot hole surface by smearing a “dime” (1 square cm) sized glob of grease around the wheel pilot surface (1) with end of finger. DO NOT apply grease to lugnut/stud holes or wheel-to-brake surfaces.

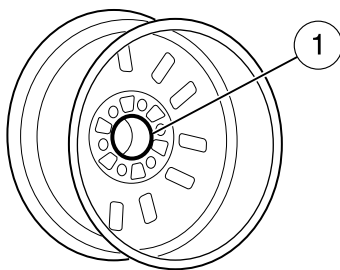

OVERHEATING

If the temperature gauge indicates overheating and you experience power loss, you hear a loud knocking or pinging noise, the engine is probably too hot.

If this happens:

1. Drive safely to the side of the road and park off the right-of-way.
2. Shift the automatic transmission into P (Park) or the manual transmission into the neutral position, and apply the parking brake.
3. Turn off the air conditioner.

WARNING: Steam from an overheated engine is dangerous. The escaping steam could seriously burn you. Open the hood ONLY after steam is no longer escaping from the engine.

4. Check whether coolant or steam is escaping from under the hood or from the engine compartment.

Roadside Emergencies

- **If steam is coming from the engine compartment:** do not go near the front of the vehicle. Stop the engine, then turn the ignition switch to the ON position without starting the engine. The radiator cooling fans will start to cool the engine.
 - **If neither coolant nor steam is escaping:** open the hood and idle the engine until it cools. If this does not lower the temperature, stop the engine and let it cool.
5. Check the coolant level. If it is low, look for leaks in the radiator hoses and connections, heater hoses and connections, radiator and water pump.

If you find a leak or other damage, or if coolant is still leaking, stop the engine and call an authorized dealer.

WARNING: When the engine and radiator are hot, scalding coolant and steam may shoot out under pressure and cause serious injury. Do not remove the cooling system cap when the engine and radiator are hot.

See *Adding coolant* in the *Maintenance and Specifications* section. If you find no problems, the engine is cool and no leaks are obvious, carefully add coolant as required.

Note: If the engine continues to overheat or frequently overheats, have the cooling system inspected. The engine could be seriously damaged unless repairs are made.

JUMP STARTING

WARNING: The gases around the battery can explode if exposed to flames, sparks, or lit cigarettes. An explosion could result in injury or vehicle damage.

WARNING: Batteries contain sulfuric acid which can burn skin, eyes and clothing, if contacted.

Do not attempt to push-start your automatic transmission vehicle. Automatic transmissions do not have push-start capability. Attempting to push-start a vehicle with an automatic transmission may cause transmission damage.

Preparing your vehicle

When the battery is disconnected or a new battery is installed, the automatic transmission must relearn its shift strategy. As a result, the

Roadside Emergencies

transmission may have firm and/or soft shifts. This operation is considered normal and will not affect function or durability of the transmission. Over time, the adaptive learning process will fully update transmission operation.

1. **Use only a 12-volt supply to start your vehicle.**
2. Do not disconnect the battery of the disabled vehicle as this could damage the vehicle's electrical system.
3. Park the booster vehicle close to the hood of the disabled vehicle making sure the two vehicles **do not** touch. Set the parking brake on both vehicles and stay clear of the engine cooling fan and other moving parts.
4. Check all battery terminals and remove any excessive corrosion before you attach the battery cables. Ensure that vent caps are tight and level.
5. Turn the heater fan on in both vehicles to protect from any electrical surges. Turn all other accessories off.

Connecting the jumper cables

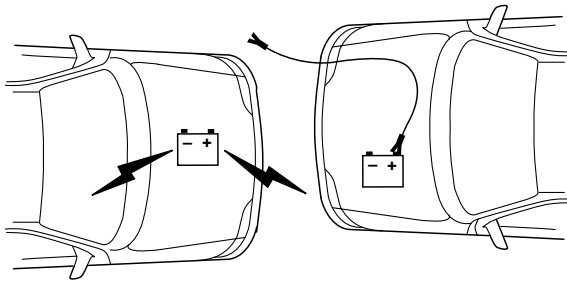

1. Connect the positive (+) jumper cable to the positive (+) terminal of the discharged battery.

Note: In the illustrations, *lightning bolts* are used to designate the assisting (boosting) battery.

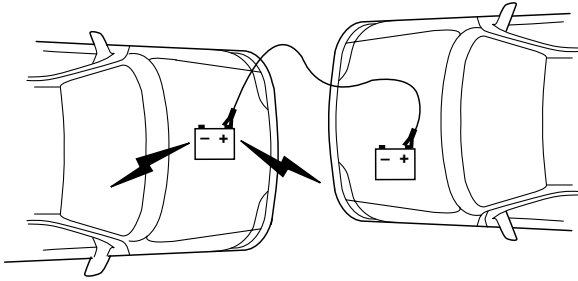

2. Connect the other end of the positive (+) cable to the positive (+) terminal of the assisting battery.

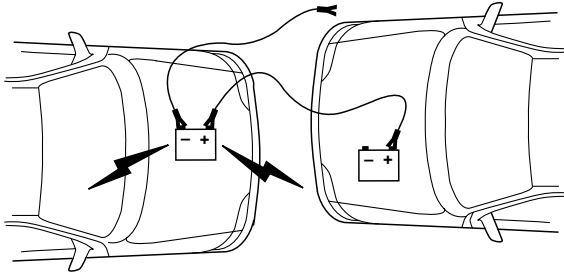

3. Connect the negative (-) cable to the negative (-) terminal of the assisting battery.

Roadside Emergencies

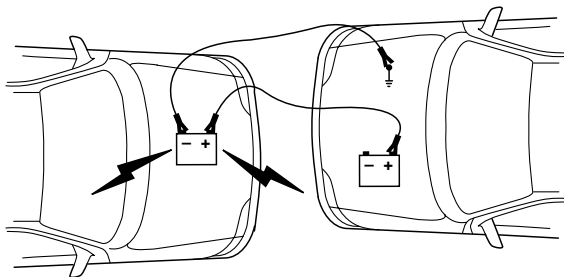

4. Make the final connection of the negative (-) cable to an exposed metal part of the stalled vehicle's engine, away from the battery and the fuel injection system. **Do not** use fuel lines, engine rocker covers or the intake manifold as *grounding* points.

WARNING: Do not connect the end of the second cable to the negative (-) terminal of the battery to be jumped. A spark may cause an explosion of the gases that surround the battery.

5. Ensure that the cables are clear of fan blades, belts, moving parts of both engines, or any fuel delivery system parts.

Jump starting

1. Start the engine of the booster vehicle and run the engine at moderately increased speed.
2. Start the engine of the disabled vehicle.
3. Once the disabled vehicle has been started, run both engines for an additional three minutes before disconnecting the jumper cables.

Removing the jumper cables

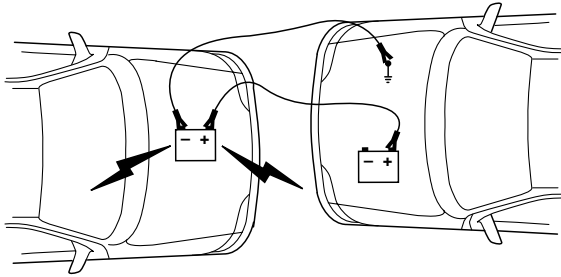

Remove the jumper cables in the reverse order that they were connected.

1. Remove the jumper cable from the *ground* metal surface.

Note: In the illustrations, *lightning bolts* are used to designate the assisting (boosting) battery.

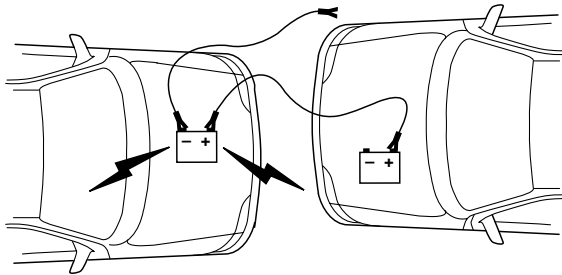

2. Remove the jumper cable on the negative (-) connection of the booster vehicle's battery.

Roadside Emergencies

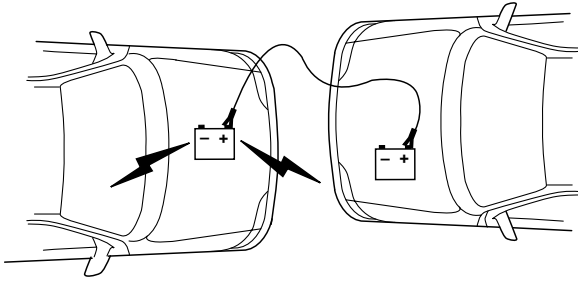

3. Remove the jumper cable from the positive (+) terminal of the booster vehicle's battery.

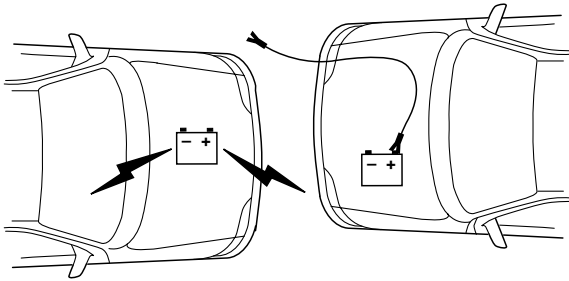

4. Remove the jumper cable from the positive (+) terminal of the disabled vehicle's battery.

After the disabled vehicle has been started and the jumper cables removed, allow it to idle for several minutes so the engine computer can *relearn* its idle conditions.

WRECKER TOWING

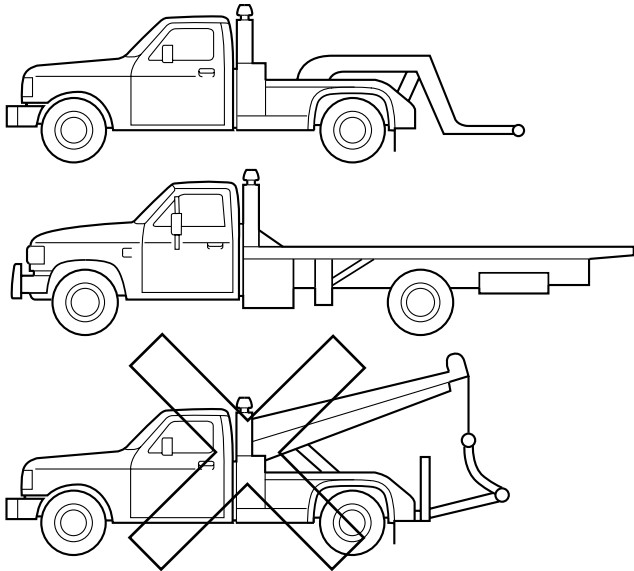

If you need to have your vehicle towed, contact a professional towing service or, if you are a member of a roadside assistance program, your roadside assistance service provider.

It is recommended that your vehicle be towed with a wheel lift or flatbed equipment. Do not tow with a slingbelt. Mazda has not approved a slingbelt towing procedure.

On 4x2 vehicles, it is acceptable to tow the vehicle with the front wheels on the ground and the rear wheels off the ground.

On 4x4 vehicles, it is recommended that your vehicle be towed with a wheel lift and dollies or flatbed equipment with all the wheels off the ground.

If the vehicle is towed by other means or incorrectly, vehicle damage may occur.

Customer Assistance

CUSTOMER ASSISTANCE (U.S.A. MAINLAND AND HAWAII)

Your complete and permanent satisfaction is our business. We are here to serve you. All Authorized Mazda Dealers have the knowledge and the tools to keep your Mazda vehicle in top condition.

If you have any questions or recommendations for improvement regarding the service of your Mazda vehicle or servicing by Authorized Mazda Dealer personnel, we recommend that you take the following steps:

STEP 1: Contact Your Authorized Mazda Dealer

Discuss the matter with an Authorized Mazda Dealer. This is the quickest and best way to address the issue. If your concern has not been resolved by the CUSTOMER RELATIONS, SALES, SERVICE, or PARTS MANAGER, then please contact the GENERAL MANAGER of the authorized dealer or the OWNER.

STEP 2: Contact Mazda North American Operations

If for any reason you feel the need for further assistance after contacting your authorized dealer management, you can reach Mazda North American Operations by one of the following ways:

Log on at: www.mazdaUSA.com.

Answers to many questions, including how to locate or contact a local Authorized Mazda Dealership in the U.S., can be found here.

By email at: www.mazdaUSA.com (Click on CONTACT US at the bottom of the home page).

By phone at: 1 (800) 222-5500

By letter at:

Attn: Customer Assistance
Mazda North American Operations
7755 Irvine Center Drive
Irvine, CA 92618-2922
P.O. Box 19734
Irvine, CA 92623-9734

Whatever way you contact us, please help us to serve you more efficiently and effectively by providing the following information:

1. Your name, address, and telephone number
2. Year and model of vehicle
3. Vehicle Identification Number (17 digits, noted on your registration or title or located on the upper driver's side corner of the dash)

4. Purchase date and current mileage
5. Your authorized dealer's name and location
6. Your question(s)

If you live outside the U.S.A., please contact your nearest Mazda Distributor.

CUSTOMER ASSISTANCE (CANADA)

Your complete and permanent satisfaction is our business. We are here to serve you. All Authorized Mazda Dealers have the knowledge and the tools to keep your Mazda vehicle in top condition.

In our experience, any questions, problems or complaints regarding the operation of your Mazda or any other general service transactions are most effectively resolved by your authorized dealer. If the cause of your dissatisfaction cannot adequately be addressed by normal authorized dealer procedures, we recommend that you take the following steps:

STEP 1: Contact Your Authorized Mazda Dealer

Discuss the matter with a member of authorized dealer management. If the Service Manager has already reviewed your concerns, contact the owner of the authorized dealer or its General Manager.

STEP 2: Call the Mazda Regional Office

If you feel that you still require assistance, ask the authorized dealer Service Manager to arrange for you to meet the local Mazda Service Representative. If more expedient, contact Mazda Canada Inc. Regional Office nearest you for such arrangements.

STEP 3: Contact the Mazda Customer Relations Department

If still not substantially satisfied, contact the Customer Relations Department, Mazda Canada Inc., 55 Vogell Road, Richmond Hill, Ontario L4B 3K5 Canada TEL: 1 (800) 263-4680.

Provide the Department with the following information:

1. Your name, address, and telephone number
2. Year and model of vehicle
3. Vehicle Identification Number (VIN). Refer to *Vehicle identification label* in the *Maintenance and Specifications* chapter of this manual for the location of the VIN.
4. Purchase date.
5. Present odometer reading.

Customer Assistance

6. Your authorized dealer's name and location
7. The nature of your problem and/or cause of dissatisfaction.

The Department, in cooperation with the local Mazda Service Representative, will review the case to determine if everything possible has been done to ensure your satisfaction.

Please recognize that the resolution of service problems in most cases requires the use of your authorized dealer's service facilities, personnel and equipment. We urge you to follow the above three steps in sequence therefore for most effective results.

Mediation/Arbitration Program

Occasionally a customer concern cannot be resolved through Mazda's Customer Satisfaction Program. If after exhausting procedures in this manual, your concern is still not resolved, you have another option.

Mazda Canada Inc. participates in an arbitration program administered by the Canadian Motor Vehicle Arbitration Plan (CAMVAP). CAMVAP will advise you about how your concern may be reviewed and resolved by an independent third party through binding arbitration.

Your complete satisfaction is the goal of Mazda Canada Inc. and our authorized dealers. Mazda's participation in CAMVAP makes a valuable contribution to our achieving that goal. There is no charge for using CAMVAP. CAMVAP results are fast, fair and final as the award is binding on both you and Mazda Canada Inc.

Canadian Motor Vehicle Arbitration Plan (CAMVAP)

For vehicles delivered to authorized Canadian dealerships. If a specific item of concern arises, where a solution cannot be reached between an owner, Mazda, and/or one of its authorized dealers (that all parties cannot agree upon), the owner may wish to use the services offered by the Canadian Motor Vehicle Arbitration Plan (CAMVAP).

CAMVAP uses the services of Provincial Administrators to assist consumers in scheduling and preparing for their arbitration hearings. However, before you can proceed with CAMVAP you must follow your Mazda dispute resolution process as outlined previously.

CAMVAP is fully implemented in all provinces and territories. Consumers wishing to obtain further information about the Program can obtain an information booklet from their authorized dealer, the Provincial Administrator at 1 (800) 207-0685, or by contacting the Canadian Motor Vehicle Arbitration Office At:
235 Yorkland Boulevard, Suite 407
North York, Ontario
M2J 4Y8
<http://camvap.ca>

Regional Offices

Regional Offices	Areas Covered
Mazda Canada Inc. Western Region 8171 Ackroyd Road Suite 2000 Richmond, B.C. V6X 3K1 (604) 303-5670	Alberta, British Columbia, Manitoba, Saskatchewan, Yukon
Mazda Canada Inc. Central Region 55 Vogell Road Richmond Hill, Ontario. L4B 3K5 1 (800) 263-4680	Ontario
Mazda Canada Inc. Quebec Region/Atlantic Region 6111 Route Trans Canadienne Pointe Claire, Quebec H9R 5A5 (514) 694-6390	Quebec, New Brunswick, Nova Scotia, Prince Edward Island, Newfoundland

CUSTOMER ASSISTANCE (PUERTO RICO & VIRGIN ISLANDS)

Your complete and permanent satisfaction is our business. That is why all Authorized Mazda Dealers have the knowledge and the tools to keep your Mazda vehicle in top condition.

Customer Assistance

If you have any questions or recommendations for improvement regarding the service of your Mazda vehicle or servicing by Authorized Mazda Dealer personnel, we recommend that you take the following steps:

STEP 1

Discuss the matter with an Authorized Mazda Dealer. This is the quickest and best way to address the issue. If your concern has not been resolved by the CUSTOMER RELATIONS, SALES, SERVICE, or PARTS MANAGER, then please contact the GENERAL MANAGER of the authorized dealer or the OWNER.

STEP 2

If, after following STEP 1, you feel the need for further assistance, please contact your area's Mazda representative (Indicated on the next page).

Please help us by providing the following information:

1. Your name, address, and telephone number
2. Year and model of vehicle
3. Vehicle Identification Number (17 digits, noted on your registration or title or located on the upper driver's side corner of the dash)
4. Purchase date and current mileage
5. Your authorized dealer's name and location
6. Your question(s)

If you would like to write a letter, please address it to the following,
Attn: Customer Assistance

Plaza Motors Corp.

Mazda de Puerto Rico

P.O. Box 362722

San Juan, Puerto Rico

00936-2722

Tel: (787) 788-9300

This way, we can be sure to respond to you as efficiently as possible.
That is our goal.

If you live outside the U.S.A., please contact your nearest Mazda Distributor.

IN CALIFORNIA (U.S. ONLY)

California Civil Code Section 1793.2(d) requires that, if a manufacturer or its representative is unable to repair a motor vehicle to conform to the vehicle's applicable express warranty after a reasonable number of attempts, the manufacturer shall be required to either replace the vehicle with one substantially identical or repurchase the vehicle and reimburse the buyer in an amount equal to the actual price paid or payable by the consumer (less a reasonable allowance for consumer use). The consumer has the right to choose whether to receive a refund or replacement vehicle.

California Civil Code Section 1793.22(b) presumes that the manufacturer has had a reasonable number of attempts to conform the vehicle to its applicable express warranties if, within the first 18 months of ownership of a new vehicle or the first 18,000 miles (29,000 km), whichever occurs first:

1. Two or more repair attempts are made on the same nonconformity likely to cause death or serious bodily injury OR
2. Four or more repair attempts are made on the same nonconformity (a defect or condition that substantially impairs the use, value or safety of the vehicle) OR
3. The vehicle is out of service for repair of nonconformities for a total of more than 30 calendar days (not necessarily all at one time).

In the case of 1 or 2 above, the consumer must also notify the manufacturer of the need for the repair of the nonconformity at the following address:

Mazda North American Operations
7755, Irvine Center Drive
Irvine, CA 92618-2922

MAZDA IMPORTERS/DISTRIBUTORS

U.S.A (Importer/Distributor)

Mazda North American Operations

7755 Irvine Center Drive
Irvine, CA 92618-2922
P.O. Box 19734
Irvine, CA 92623-9734
TEL: 1 (800) 222-5500 (in U.S.A.)
(949) 727-1990 (outside U.S.A.)

(Distributor in each area)

Customer Assistance

CANADA

Mazda Canada, Inc.

55 Vogell Road
Richmond Hill, Ontario L4B 3K5 Canada
TEL: 1 (800) 263-4680 (in Canada)
(416) 609-9909 (outside Canada)

PUERTO RICO & VIRGIN ISLANDS

Plaza Motors Corp. (Mazda de Puerto Rico)

P.O. Box 362722, San Juan, Puerto Rico 00936-2722
TEL: (787) 788-9300

GUAM

(d.b.a. Triple J. Enterprises, Inc.)

P.O. Box 6066 Tamuning, Guam
TEL: (671) 646-9216

SAIPAN

Pacific International Marianas, Inc.

(d.b.a. Midway Motors)
P.O. Box 887 Saipan, MP 96950
TEL: (670) 234-7524

Triple J Saipan, Inc. **(d.b.a. Triple J Motors)**

Beach Road
Chalan LauLau
Saipan, MP 96950
TEL: (670) 235-4868

AMERICAN SAMOA

Polynesia Motors, Inc.

P.O. Box 1120, Pago Pago, American Samoa 96799
TEL: (684) 699-1854

WARRANTIES FOR YOUR MAZDA

- New Vehicle Limited Warranty
- Safety Restraint System Limited Warranty
- Anti-perforation Limited Warranty
- Federal Emission Control Warranty
 - Emission Defect Warranty
 - Emission Performance Warranty

- California Emission Control Warranty (if applicable)
- Replacement Parts and Accessories Limited Warranty
- Tire Warranty

NOTE: Detailed warranty information is provided with your Mazda portfolio.

Outside the United States

Government regulations in the United States require that automobiles meet specific emission regulations and safety standards. Therefore, vehicles built for use in the United States, may differ from those sold in other countries.

The differences may make it difficult or even impossible for your vehicle to receive satisfactory servicing in other countries. We strongly recommend that you NOT take your Mazda outside the United States. However, in the event that you are moving to Canada permanently, Mazda vehicles built for use in the United States could be eligible for exportation to Canada with specific vehicle modifications to comply with the Canadian Motor Vehicle Safety requirements.

Special Note: The above is applicable for permanent import/export situations and not related to travelers on vacation.

You may have the following problems if you do take your vehicle outside of the United States:

- Recommended fuel may be unavailable. Any kind of leaded fuel or low-octane fuel will affect vehicle performance and damage the emission controls and engine.
- Proper repair facilities, tools, testing equipment, and replacement parts may not be available.

Please refer to your manufacturers warranty booklet for more information.

Outside Canada

Government regulations in Canada require that automobiles meet specific emission regulations and safety standards. Therefore, vehicles built for use in Canada, may differ from those sold in other countries.

The differences may make it difficult or even impossible for your vehicle to receive satisfactory servicing in other countries. We strongly recommend that you NOT take your Mazda outside Canada. However, in the event that you are moving to the United States permanently, Mazda

Customer Assistance

vehicles built for use in Canada could be eligible for exportation to the United States with specific vehicle modifications to comply with the United States Federal Motor Vehicle Safety requirements.

Special Note: The above is applicable for permanent import/export situations and not related to travelers on vacation.

You may have the following problems if you do take your vehicle outside of Canada:

- Recommended fuel may be unavailable. Any kind of leaded fuel or low-octane fuel will affect vehicle performance and damage the emission controls and engine.
- Proper repair facilities, tools, testing equipment, and replacement parts may not be available.

Please refer to your manufacturers warranty booklet for more information.

ADD-ON NON-GENUINE PARTS AND ACCESSORIES

Non-genuine parts and accessories for Mazda vehicles can be found in stores. These may fit your vehicle, but they are not approved by the manufacturer for use with Mazda vehicles. When you install non-genuine parts or accessories, they could affect your vehicle's performance or safety system; the manufacturer's warranty doesn't cover this. Before you install any non-genuine parts or accessories, consult an Authorized Mazda Dealer.

WARNING: Installation of Non-Genuine Parts or Accessories: Installation of non-genuine parts or accessories could be dangerous. Improperly designed parts or accessories could seriously affect your vehicle's performance or safety system. This could cause you to have an accident or increase your chances of injuries in an accident. Always consult an Authorized Mazda Dealer before you install non-genuine parts or accessories.

WARNING: Add-On Electrical and Electronic Equipment: Incorrectly choosing or installing improper add-on equipment or choosing an improper installer could be dangerous. Essential systems could be damaged, causing engine stalling, air-bag (SRS) activation, ABS inactivation, or a fire in the vehicle. Be very careful in choosing and installing add-on electrical equipment, such as mobile telephones, two-way radios, stereo systems, and car alarm systems.

Mazda assumes no responsibility for death, injury, or expenses that may result from the installation of add-on non-genuine parts or accessories.

SERVICE PUBLICATIONS

Factory-authorized Mazda service publications are available for owners who wish to do some of their own maintenance and repair.

When requesting any of our publications through an Authorized Mazda Dealer, refer to the chart below.

If they don't have what you need in stock, they can order it for you.

PUBLICATION ORDER NUMBER	PUBLICATION DESCRIPTION
9999 95 022B 06	WORKSHOP MANUAL
9999 95 020G 06	WIRING DIAGRAM
9999 95 023C 06	OWNER'S MANUAL

WORKSHOP MANUAL:

Covers recommended maintenance and repair procedures of the drive train, body and chassis.

WIRING DIAGRAM:

Provides electrical schematics as well as component location for the entire electrical system.

OWNER'S MANUAL:

This booklet contains information regarding the proper care and operation of your vehicle. This is not a technician's manual.

Please note that your Authorized Mazda Dealership has trained personnel and special service tools to correctly and safely maintain Mazda vehicles.

REPORTING SAFETY DEFECTS (U.S. ONLY)

If you believe that your vehicle has a defect that could cause a crash, or could cause injury or death, you should immediately inform the National Highway Traffic Safety Administration (NHTSA) in addition to notifying Mazda Corporation.

If NHTSA receives similar complaints, it may open an investigation, and if it finds that a safety defect exists in a group of vehicles, it may order a recall and remedy campaign. However, NHTSA cannot become involved in individual problems between you, your dealer or Mazda Corporation.

To contact NHTSA, you may call the Vehicle Safety Hotline toll-free at 1-888-327-4236 (TTY: 1-800-424-9153); go to <http://www.safercar.gov>; or write to:

Administrator
NHTSA
400 Seventh Street, SW
Washington, D.C. 20590

You can also obtain other information about motor vehicle safety from <http://www.safercar.gov>.

REPORTING SAFETY DEFECTS (CANADA ONLY)

If you believe that your vehicle has a defect which could cause a crash or could cause injury or death, you should immediately inform Transport Canada, using their toll-free number: 1-800-333-0510.

WASHING THE EXTERIOR

Wash your vehicle regularly with cool or lukewarm water and a neutral pH shampoo.

- Never use strong household detergents or soap, such as dish washing or laundry liquid. These products can discolor and spot painted surfaces.
- Never wash a vehicle that is “hot to the touch” or during exposure to strong, direct sunlight.
- Always use a clean sponge or car wash mitt with plenty of water for best results.
- Dry the vehicle with a chamois or soft terry cloth towel in order to eliminate water spotting.
- It is especially important to wash the vehicle regularly during the winter months, as dirt and road salt are difficult to remove and cause damage to the vehicle.
- Immediately remove items such as gasoline, diesel fuel, bird droppings and insect deposits because they can cause damage to the vehicle’s paintwork and trim over time.
- Remove any exterior accessories, such as antennas, before entering a car wash.
- **Suntan lotions and insect repellents can damage any painted surface; if these substances come in contact with your vehicle, wash off as soon as possible.**

WAXING

Applying a premium paint sealant to your vehicle every six months will assist in reducing minor scratches and paint damage.

- Wash the vehicle first. Refer to *Washing the exterior* for more detailed information.
- Do not use waxes that contain abrasives; use a premium liquid wax.
- Do not allow paint sealant to come in contact with any non-body (low-gloss black) colored trim, such as grained door handles, roof racks, bumpers, side moldings, mirror housings or the windshield cowl area. The paint sealant will “gray” or stain the parts over time.

PAINT CHIPS

Your dealer has touch-up paint to match your vehicle’s color. Touch-up paint can be used to repair minor scratches to painted surfaces.

Cleaning

- Remove particles such as bird droppings, tree sap, insect deposits, tar spots, road salt and industrial fallout before repairing paint chips.
- Always read the instructions before using the products.

ALUMINUM WHEELS AND COVERS

Aluminum wheel rims or covers are coated with a clearcoat paint finish. In order to maintain their shine:

- Clean with cool or lukewarm water and a neutral pH shampoo.
- Never apply any cleaning chemical to hot or warm wheel rims or covers.
- Some automatic car washes may cause damage to the finish on your wheel rims or covers. Chemical-strength cleaners, or cleaning chemicals, in combination with brush agitation to remove brake dust and dirt, could wear away the clearcoat finish over time.
- Do not use hydrofluoric acid-based or high caustic-based wheel cleaners, steel wool, fuels or strong household detergent.
- To remove tar and grease, use Extra Strength Tar and Road Oil Remover (0000-77-410E-01), available from your authorized Mazda dealer.

ENGINE

Engines are more efficient when they are clean because grease and dirt buildup keep the engine warmer than normal. When washing:

- Take care when using a power washer to clean the engine. The high-pressure fluid could penetrate the sealed parts and cause damage.
- Never spray the engine or other engine components with water. Water will damage the engine or other engine components.
- Spray Engine Shampoo and Degreaser (0000-77-410E-09), available at your authorized Mazda dealer, on all parts that require cleaning and pressure rinse clean.
- Cover the highlighted areas to prevent water damage when cleaning the engine.

- **2.3L Engine**

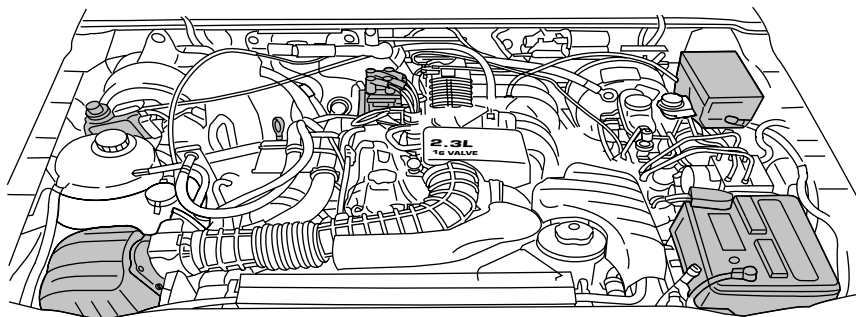

- **3.0L Engine**

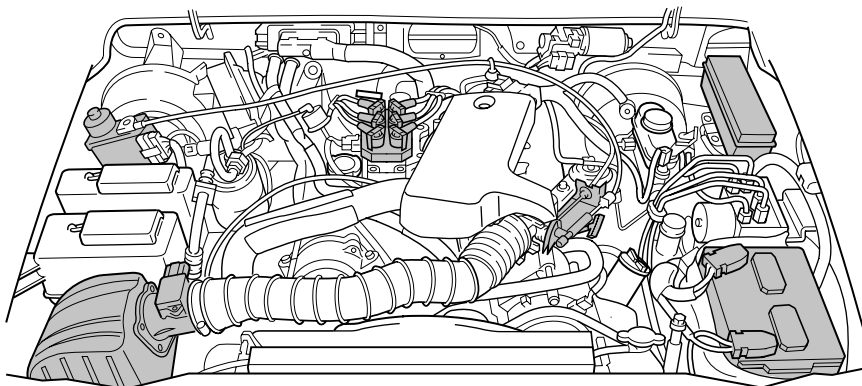

Cleaning

• 4.0L Engine

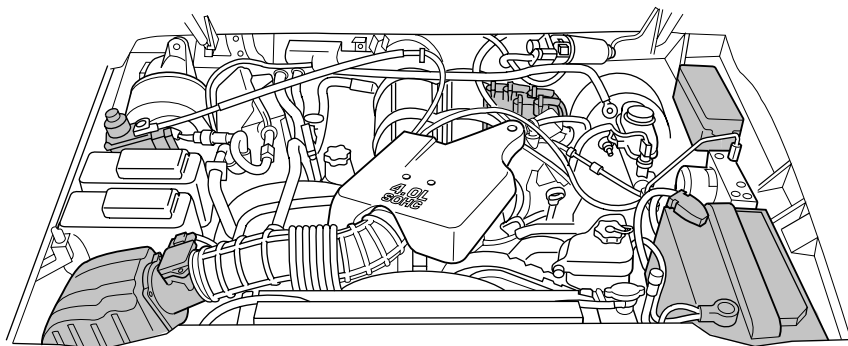

- Never wash or rinse the engine while it is running; water in the running engine may cause internal damage.

PLASTIC (NON-PAINTED) EXTERIOR PARTS

Use only approved products to clean plastic parts. These products are available from your dealer.

- For routine cleaning, use cool or lukewarm water with a neutral pH shampoo.
- If tar or grease spots are present, use Extra Strength Tar and Road Oil Remover (0000-77-410E-01), available at your authorized Mazda dealer.

WINDOWS AND WIPER BLADES

The windshield, rear and side windows and the wiper blades should be cleaned regularly. If the wipers do not wipe properly, substances on the vehicle's glass or the wiper blades may be the cause. These may include hot wax treatments used by commercial car washes, water repellent coatings, tree sap, or other organic contamination; these contaminants may cause squeaking or chatter noise from the blades, and streaking and smearing of the windshield. To clean these items, follow these tips:

- The windshield, rear windows and side windows may be cleaned with a non-abrasive cleaner such as Ultra-Clear Spray Glass Cleaner (0000-77-400E-01 and 0000-77-400E-02), available from your authorized Mazda dealer.
- The wiper blades can be cleaned with isopropyl (rubbing) alcohol or a windshield washer concentrate. This washer fluid concentrate contains

a special solution in addition to alcohol which helps to remove the hot wax deposited on the wiper blade and windshield from automated car wash facilities. Be sure to replace wiper blades when they appear worn or do not function properly.

- Do not use abrasives, as they may cause scratches.
- Do not use fuel, kerosene, or paint thinner to clean any parts.

INSTRUMENT PANEL / INTERIOR TRIM AND CLUSTER LENS

Clean the interior trim areas and instrument panel with a damp cloth, then with a clean, dry cloth, or use Mazda Deluxe Leather and Vinyl Cleaner (0000-77-430E-15).

- Avoid cleaners or polish that increase the gloss of the upper portion of the instrument panel. The dull finish in this area helps protect the driver from undesirable windshield reflection.
- Do not use household or glass cleaners, as these may damage the finish.

WARNING: Do not use chemical solvents or strong detergents when cleaning the steering wheel, instrument panel or interior trim areas to avoid contamination of the airbag systems.

- Be certain to wash or wipe your hands clean if you have been in contact with certain products such as insect repellent and suntan lotion in order to avoid possible damage to the interior painted surfaces.

INTERIOR

For fabric, carpets, cloth seats, and seat belts:

- Remove dust and loose dirt with a vacuum cleaner.
- Remove light stains and soil with Upholstery Cleaner and Spot Remover (0000-77-430E-01), available at your authorized Mazda dealer.
- If grease or tar is present on the material, spot-clean the area first with Spot and Stain Remover (0000-77-410E-01), available at your authorized Mazda dealer.
- If a solvent ring forms on the fabric after spot cleaning, clean the entire area immediately (but do not oversaturate) or the ring will set.
- Do not use household cleaning products or glass cleaners, which can stain and discolor the fabric and affect the flame retardant abilities of the seat materials.

UNDERBODY

Flush the complete underside of your vehicle frequently. Keep body and door drain holes free from packed dirt.

MAZDA CAR CARE PRODUCTS

Your Mazda dealer has many quality products available to clean your vehicle and protect its finishes. These quality products have been specifically engineered to fulfill your automotive needs; they are custom designed to complement the style and appearance of your vehicle. Each product is made from high quality materials that meet or exceed rigid specifications. For best results, use these products or products of equivalent quality. These products are available at your authorized Mazda dealer.

INTRODUCTION

Be extremely careful to prevent injury to yourself and others or damage to your vehicle when using this manual for inspection and maintenance.

If you're unsure about any procedure it describes, we strongly urge you to have a reliable and qualified service shop perform the work, preferably an authorized Mazda Dealer.

Factory-trained Mazda technicians and genuine Mazda parts are best for your vehicle. Without this expertise and the parts that have been designed and made especially for your Mazda, inadequate, incomplete, and insufficient servicing may result in problems. This could lead to vehicle damage or an accident and injuries.

For expert advice and quality service, consult an authorized Mazda Dealer.

The owner should retain evidence that proper maintenance has been performed as prescribed.

Claims against the warranty resulting from lack of maintenance, as opposed to defective materials or authorized Mazda workmanship, will not be honored.

Any auto repair shop using parts equivalent to your Mazda's original equipment may perform maintenance. **But we recommend that it always be done by an authorized Mazda Dealer using genuine Mazda parts.**

SCHEDULED MAINTENANCE

Schedule 1 — Normal Driving Conditions/Emission Control Systems

Follow Schedule 1 if the vehicle is operated mainly where none of the following conditions apply. If any do apply, follow Schedule 2.

- Repeated short-distance driving.
- Driving in dusty conditions.
- Towing a trailer.
- Operating in hot weather in stop-and-go “rush hour” traffic.
- Extended periods of idling or low-speed operation.
- High-speed operation with a fully loaded vehicle.
- Off-road operation.

NOTE: After the described period, continue to follow the described maintenance at the recommended intervals.

Maintenance and Specifications

CHART SYMBOLS

I: Inspect and if necessary, correct, clean or replace

A Adjust

R: Replace

L: Lubricate

Normal driving service intervals — perform at the months or distances shown, whichever occurs first.

Maintenance Item	Maintenance Interval (Number of months or Miles (km), whichever comes first)												
	Months	4	8	12	16	20	24	28	32	36	40	44	48
	x 1000 miles	5	10	15	20	25	30	35	40	45	50	55	60
	(x 1000 km)	(8)	(16)	(24)	(32)	(40)	(48)	(56)	(64)	(72)	(80)	(88)	(96)
ENGINE													
Engine oil	R	R	R	R	R	R	R	R	R	R	R	R	R
Oil filter	R	R	R	R	R	R	R	R	R	R	R	R	R
PCV valve	*3												
AIR CLEANER													
Air cleaner filter							R						R
IGNITION SYSTEM													
Spark plugs	*4												
COOLING SYSTEM													
Engine Coolant (yellow)	Replace at first 100,000 miles (160,000 km) or 72 months; after that, every 50,000 miles (80,000 km) or 36 months												
Coolant condition and protection, hoses and clamps — annually — prior to cold weather every 12 months			I			I			I				I
CHASSIS AND BODY													
Wheel lug nut torque	*1	I	I	I	I	I	I	I	I	I	I	I	I
Inspect tires for wear and rotate (X = recommended interval for optimal tire life)	I	X	I	X	X	I	X	X	I	X	X	X	I
Clutch reservoir fluid level	I		I		I		I		I		I		
Front wheel bearings (4x2)													L

Maintenance and Specifications

Maintenance Item	Maintenance Interval (Number of months or Miles (km), whichever comes first)												
	Months	4	8	12	16	20	24	28	32	36	40	44	48
	x 1000 miles	5	10	15	20	25	30	35	40	45	50	55	60
	(x 1000 km)	(8)	(16)	(24)	(32)	(40)	(48)	(56)	(64)	(72)	(80)	(88)	(96)
Disc brake system				I			I			I			I
Caliper slide rails				L			L			L			L
Drum brake system, lines and hoses				I			I			I			I
Exhaust system for leaks, damage, looseness							I						I
Manual transmission fluid													
Automatic transmission fluid	*2						I						I
Exhaust system shielding (for trapped material)							I						I
Propeller shaft U-joints (if equipped with grease fittings)		L		L		L		L		L		L	
Parking brake system (for damage and operation)				I			I			I			I
Ball joints (4x2)				I/L			I/L			I/L			I/L
Transfer case fluid (4x4)		Replace every 150,000 miles (240,000 km)											
Rear axle lubricant		Does not require replacement unless rear axle submerged in water											
Accessory drive belts													
Fuel filter	*5						R						R
Steering linkage, ball joints, suspension and driveshaft				I			I			I			I

*1 The wheel lug nuts must be retightened to the proper specifications at 500 miles (800 km) of new vehicle operation, at any wheel change, or at any other time the wheel lug nuts have been loosened. Refer to *Wheel Lug Nut Torque Specification* in the *Tires, Wheels and Loading* chapter for the proper lug nut torque specification.

*2 Replace every 150,000 miles (240,000 km) unless submerged in water.

*3 At 60,000 miles (96,000 km), the dealer will replace the PCV valve at no cost, except Canada and California vehicles.

*4 Refer to vehicle emission control information label for spark plug and gap specifications.

Maintenance and Specifications

*5 The California Air Resources Board has determined that the failure to perform this maintenance item will not nullify the emission warranty nor limit recall liability prior to completion of the vehicle's useful life.

Schedule 1 continued

Maintenance Item	Maintenance Interval (Number of months or Miles (km), whichever comes first)												
	Months	52	56	60	64	68	72	76	80	84	88	92	96
	x 1000 miles	65	70	75	80	85	90	95	100	105	110	115	120
	(x 1000 km)	(104)	(112)	(121)	(128)	(136)	(144)	(152)	(160)	(168)	(176)	(184)	(192)
ENGINE													
Engine oil	R	R	R	R	R	R	R	R	R	R	R	R	R
Oil filter	R	R	R	R	R	R	R	R	R	R	R	R	R
PCV valve	*3												
AIR CLEANER													
Air cleaner filter							R						R
IGNITION SYSTEM													
Spark plugs	*4								R				
COOLING SYSTEM													
Engine Coolant (yellow)	Replace at first 100,000 miles (160,000 km) or 72 months; after that, every 50,000 miles (80,000 km) or 36 months												
Coolant condition and protection, hoses and clamps — annually —prior to cold weather every 12 months			I				I			I			I
CHASSIS AND BODY													
Wheel lug nut torque	*1	I	I	I	I	I	I	I	I	I	I	I	I
Inspect tires for wear and rotate (X = recommended interval for optimal tire life)	X	X	I	X	X	I	X	X	I	X	X	X	I
Clutch reservoir fluid level	I		I			I		I		I		I	
Front wheel bearings (4x2)													L
Disc brake system			I				I			I			I
Caliper slide rails			L				L			L			L
Drum brake system, lines and hoses			I				I			I			I

Maintenance and Specifications

Maintenance Item	Maintenance Interval (Number of months or Miles (km), whichever comes first)												
	Months	52	56	60	64	68	72	76	80	84	88	92	96
	x 1000 miles	65	70	75	80	85	90	95	100	105	110	115	120
	(x 1000 km)	(104)	(112)	(121)	(128)	(136)	(144)	(152)	(160)	(168)	(176)	(184)	(192)
Exhaust system for leaks, damage, looseness							I						I
Manual transmission fluid								R					
Automatic transmission fluid	*2						I						I
Exhaust system shielding (for trapped material)							I						I
Propeller shaft U-joints (if equipped with grease fittings)	L		L		L		L		L		L		
Parking brake system (for damage and operation)			I				I		I				I
Ball joints (4x2)			I/L				I/L		I/L				I/L
Transfer case fluid (4x4)	Replace every 150,000 miles (240,000 km)												
Rear axle lubricant	Does not require replacement unless rear axle submerged in water												
Accessory drive belts									I				
Fuel filter	*5						R						R
Steering linkage, ball joints, suspension and driveshaft			I				I		I				I

*1 The wheel lug nuts must be retightened to the proper specifications at 500 miles (800 km) of new vehicle operation, at any wheel change, or at any other time the wheel lug nuts have been loosened. Refer to *Wheel Lug Nut Torque Specification* in the *Tires, Wheels and Loading* chapter for the proper lug nut torque specification.

*2 Replace every 150,000 miles (240,000 km) unless submerged in water.

*3 At 60,000 miles (96,000 km), the dealer will replace the PCV valve at no cost, except Canada and California vehicles.

*4 Refer to vehicle emission control information label for spark plug and gap specifications.

*5 The California Air Resources Board has determined that the failure to perform this maintenance item will not nullify the emission warranty nor limit recall liability prior to completion of the vehicle's useful life.

Maintenance and Specifications

SCHEDULE 2 — SPECIAL OPERATING CONDITIONS

If your driving habits **FREQUENTLY** include one or more of the following conditions:

- Short trips of less than 10 miles (16 km) when outside temperatures remain below freezing.
- Towing a trailer, or carrying maximum loads.
- Operating in severe dust conditions.
- Operating during **hot weather** in stop-and-go “rush hour” traffic.
- Extensive idling, such as police, taxi or door-to-door delivery service.
- High speed operation with a fully loaded vehicle (max. GVW).
- Off-road operation

Change ENGINE OIL AND OIL FILTER every 3 months or 3,000 miles (4,800 km) whichever occurs first.

NOTE: Idling the engine for extended periods will accumulate more hours of use on your vehicle than is actually indicated by the mileage odometer. Consequently, the odometer reading can be often misleading when determining the right time to change your engine oil and filter. If you are using your vehicle in a manner which allows it to remain stationary while the engine is running for long periods (door-to-door delivery, taxi, police, power/utility company trucks, or similar duty), then Mazda recommends you increase the frequency of oil and filter changes to an interval equivalent to 200 ENGINE HOURS or use. Since most vehicles are not equipped with hour-meters, it may be necessary for you to approximate your idle time and plan oil/filter changes accordingly.

Maintenance and Specifications

Special Operating Conditions	Replace Engine Oil and Filter	Inspect Brake System	Replace Fuel Filter	Change Automatic Transmission Fluid	Replace Spark Plugs	Replace Engine Air Filter	Change Manual Transmission Fluid	Inspect and Lubricate U-Joints	Lubricate Front Wheel Bearing (4x2)	Change Transfer Case Fluid (4x4)
Suggested Maintenance Interval	3,000 miles or 3 months	5,000 miles	15,000 miles	30,000 miles	60,000 miles	As required	As required	As required	30,000 miles	60,000 miles
Towing a trailer or using a camper or car top carrier	X			X		X	X			
Extensive idling or low-speed driving for long distances as in heavy commercial use such as delivery, taxi or patrol car	X	X	X	X	X				X	X
Operating in dusty conditions such as unpaved or dusty roads	X		X	X		X				
Off road operation				X				X		X

For specific recommendations see your authorized Mazda dealer or qualified service professional.

Maintenance and Specifications

OWNER MAINTENANCE

Owner Maintenance Schedule

The owner or a qualified service technician should make these vehicle inspections at the indicated intervals to ensure safe and dependable operation.

Bring any problem to the attention of an Authorized Mazda Dealer or qualified service technician as soon as possible.

While operating your vehicle

- Note any changes in the sound of the exhaust or any smell or exhaust fumes in the vehicle.
- Check for vibrations in the steering wheel. Notice any increased steering effort or looseness in the steering wheel, or change in the straight ahead position.
- Notice if your vehicle constantly turns slightly or “pulls” to one side when traveling on a smooth, level road.
- When stopping, listen and check for strange sounds, pulling to one side, increased brake pedal travel or “hard to push” brake pedal.
- If any slipping or changes in the operation of your transmission occur, check the transmission fluid level.
- Check automatic transmission Park function.
- Check parking brake.

At least monthly

- Check function of all interior and exterior lights.
- Check tires for wear and proper air pressure.
- Check engine oil level.
- Check coolant level in the coolant reservoir.
- Check washer fluid level.

At least twice a year (for example, every spring and fall)

- Check power steering fluid level.
- Check clutch fluid level (if equipped).
- Check and clean body and door drain holes.
- Check and lubricate all hinges, latches, and outside locks.
- Check and lubricate door rubber weather strips.
- Check parking brake for proper operation.

Maintenance and Specifications

- Check lap/shoulder belts and seat latches for wear and function.
- Check air pressure in spare tire.
- Check windshield washer spray and wiper operation. Clean wiper blades with clean cloth dampened with washer fluid.
- Check safety warning lamps (brake, ABS, air bag, seat belt) for operation.
- Check cooling system fluid level and verify coolant specific gravity is correct for summer or winter conditions.
- Check battery water level (non-maintenance free).
- Check battery connections and clean if necessary.

Retightening lug nuts

- Retighten the lug nuts to the specified torque at 500 miles (800 km) after any wheel disturbance (tire rotation, changing a flat tire, wheel removal, etc.).
- Refer to *Wheel Lug Nut Torque Specification* in the *Tires, Wheels and Loading* chapter for the proper lug nut torque specification.

SERVICE RECOMMENDATIONS

To help you service your vehicle, we provide *scheduled maintenance information* which makes tracking routine service easy.

If your vehicle requires professional service, your authorized dealer can provide necessary parts and service. Check your “Warranty Information” to find out which parts and services are covered.

Use only recommended fuels, lubricants, fluids and service parts conforming to specifications. Genuine Mazda parts are designed and built to provide the best performance in your vehicle.

PRECAUTIONS WHEN SERVICING YOUR VEHICLE

- Do not work on a hot engine.
- Make sure that nothing gets caught in moving parts.
- Do not work on a vehicle with the engine running in an enclosed space, unless you are sure you have enough ventilation.
- Keep all open flames and other burning (cigarettes) material away from the battery and all fuel related parts.

Working with the engine off

- Automatic transmission/transaxle:
 1. Set the parking brake and shift to P (Park).

Maintenance and Specifications

2. Turn off the engine and remove the key.
 3. Block the wheels.
- Manual transmission/transaxle:
 1. Set the parking brake, depress the clutch and place the gearshift in 1 (First).
 2. Turn off the engine and remove the key.
 3. Block the wheels.

Working with the engine on

- Automatic transmission:
 1. Set the parking brake and shift to P (Park).
 2. Block the wheels.
- Manual transmission:
 1. Set the parking brake, depress the clutch and place the gearshift in N (Neutral).
 2. Block the wheels.

WARNING: To reduce the risk of vehicle damage and/or personal burn injuries, do not start your engine with the air cleaner removed and do not remove it while the engine is running.

OPENING THE HOOD

1. Inside the vehicle, pull the hood release handle located under the bottom of the instrument panel near the steering column.
2. Go to the front of the vehicle and release the auxiliary latch that is located under the front center of the hood.
3. Lift the hood and support it with the prop rod.

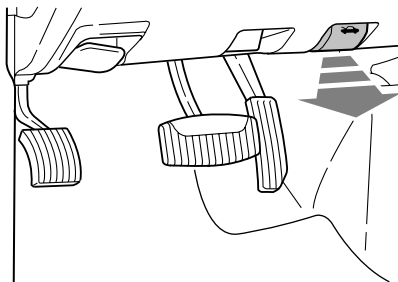

IDENTIFYING COMPONENTS IN THE ENGINE COMPARTMENT

2.3L I4 engine

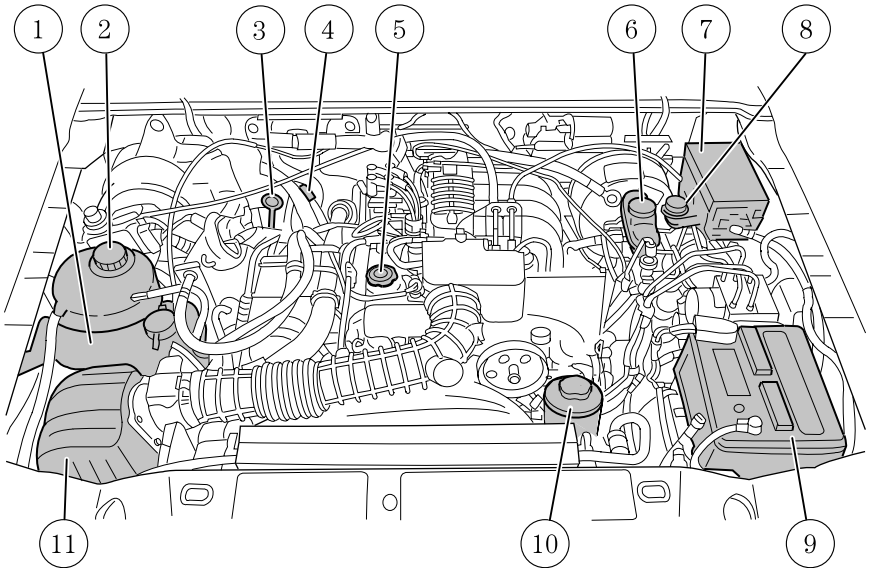

1. Windshield washer fluid reservoir
2. Engine coolant reservoir
3. Engine oil dipstick
4. Transmission fluid dipstick (automatic transmission)
5. Engine oil filler cap
6. Brake fluid reservoir
7. Power distribution box
8. Clutch fluid reservoir (manual transmission)
9. Battery
10. Power steering fluid reservoir
11. Air filter assembly

Maintenance and Specifications

3.0L V6 engine

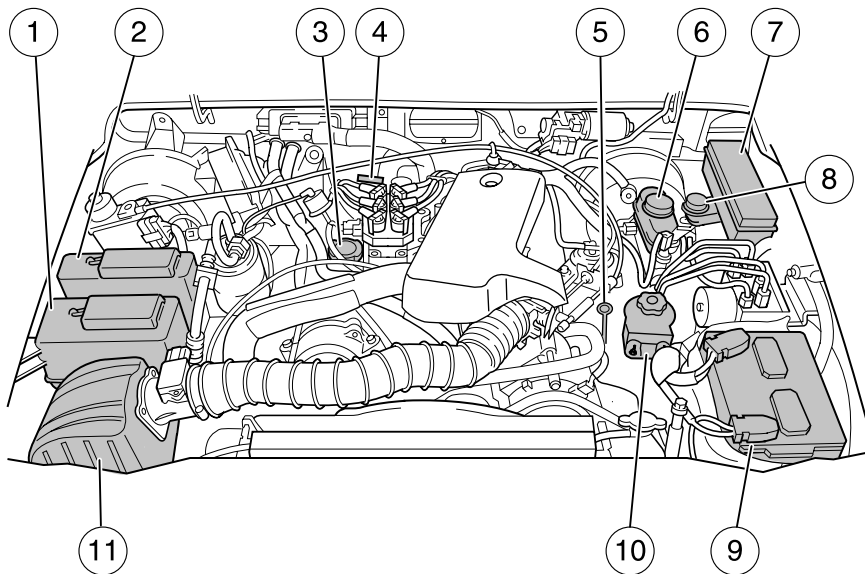

1. Engine coolant reservoir
2. Windshield washer fluid reservoir
3. Engine oil filler cap
4. Transmission fluid dipstick (automatic transmission)
5. Engine oil dipstick
6. Brake fluid reservoir
7. Power distribution box
8. Clutch fluid reservoir (manual transmission)
9. Battery
10. Power steering fluid reservoir
11. Air filter assembly

4.0L SOHC V6 engine

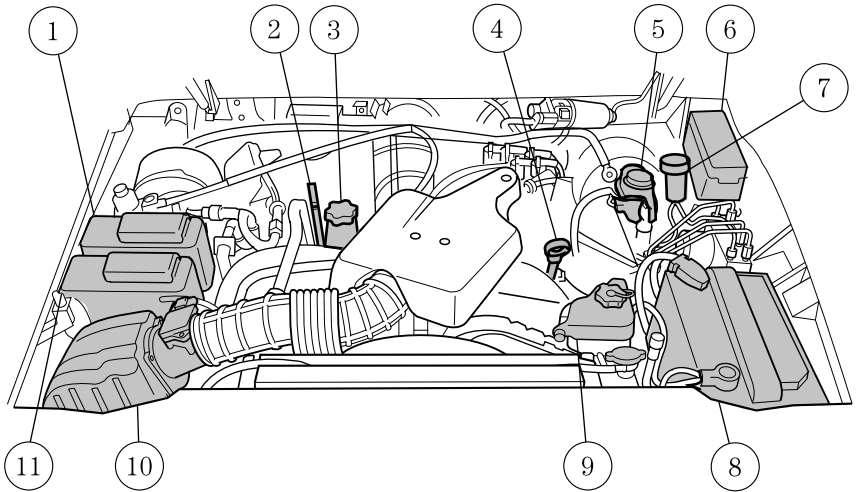

1. Windshield washer fluid reservoir
2. Transmission fluid dipstick (automatic transmission)
3. Engine oil filler cap
4. Engine oil dipstick
5. Brake fluid reservoir
6. Power distribution box
7. Clutch fluid reservoir (manual transmission)
8. Battery
9. Power steering fluid reservoir
10. Air filter assembly
11. Engine coolant reservoir

Maintenance and Specifications

WINDSHIELD WASHER FLUID

Add fluid to fill the reservoir if the level is low. In very cold weather, do not fill the reservoir completely.

Only use a washer fluid that meets Mazda specification . Do not use any special washer fluid such as windshield water repellent type fluid or bug wash. They may cause squeaking, chatter noise, streaking and smearing. Refer to *Refill capacities* in this chapter.

State or local regulations on volatile organic compounds may restrict the use of methanol, a common windshield washer antifreeze additive. Washer fluids containing non-methanol antifreeze agents should be used only if they provide cold weather protection without damaging the vehicle's paint finish, wiper blades or washer system.

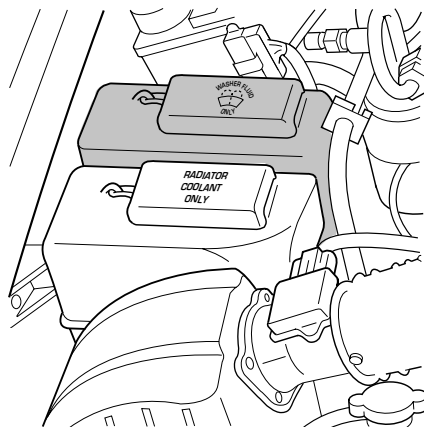

WARNING: If you operate your vehicle in temperatures below 40° F (4.5°C), use washer fluid with antifreeze protection. Failure to use washer fluid with antifreeze protection in cold weather could result in impaired windshield vision and increase the risk of injury or accident.

Note: Do not put washer fluid in the engine coolant reservoir. Washer fluid placed in the cooling system may harm engine and cooling system components.

WINDSHIELD WIPER BLADES

If the wiper blades do not wipe properly, clean both the windshield and wiper blades using undiluted windshield wiper solution or a mild detergent. Rinse thoroughly with clean water. To avoid damaging the blades, do not use fuel, kerosene, paint thinner or other solvents.

Check the wiper blades for wear at least twice a year or when they seem less effective. Substances such as tree sap and some hot wax treatments used by commercial car washes reduce the effectiveness of wiper blades.

Changing the wiper blades

1. Pull the wiper arm away from the vehicle. Turn the blade at an angle from the wiper arm. Push the lock pin manually to release the blade and pull the wiper blade down toward the windshield to remove it from the arm.
2. Attach the new wiper to the wiper arm and press it into place until a click is heard.

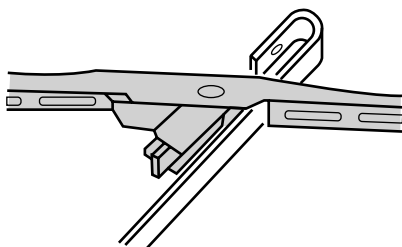

Replace wiper blades at least once per year for optimum performance.

Poor wiper quality can be improved by cleaning the wiper blades and the windshield, refer to *Windows and wiper blades* in the *Cleaning* chapter.

To prolong the life of the wiper blades, it is highly recommended to scrape off the ice on the windshield before turning on the wipers. The layer of ice has many sharp edges and can damage the micro edge of the wiper rubber element.

ENGINE OIL

Checking the engine oil

Refer to *scheduled maintenance* for the appropriate intervals for checking the engine oil.

1. Make sure the vehicle is on level ground.
2. Turn the engine off and wait a few minutes for the oil to drain into the oil pan.
3. Set the parking brake and ensure the gearshift is securely latched in P (Park) (automatic transmission) or 1 (First) (manual transmission).
4. Open the hood. Protect yourself from engine heat.
5. Locate and carefully remove the engine oil level dipstick.

Maintenance and Specifications

- 2.3L I4 engine

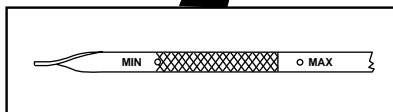
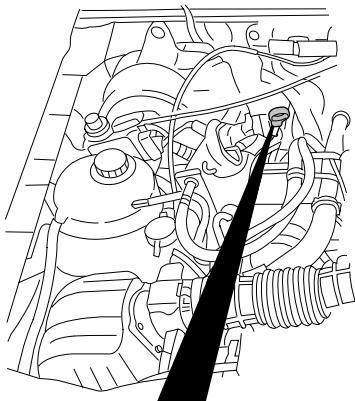

- 3.0L V6 engine

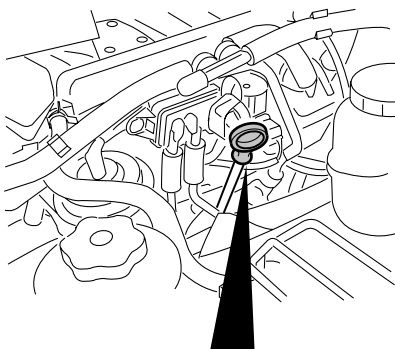

Maintenance and Specifications

- 4.0L SOHC V6 engine

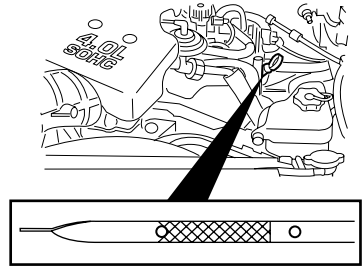

6. Wipe the dipstick clean. Insert the dipstick fully, then remove it again.
- If the oil level is **between the two holes or between the MIN and MAX marks (depending on application)**, the oil level is acceptable, **DO NOT ADD OIL.**
 - If the oil level is below the lower hole or the MIN mark, add enough oil to raise the level between the two holes or between the MIN-MAX range.
- 2.3L I4 engine
SAE 5W-20

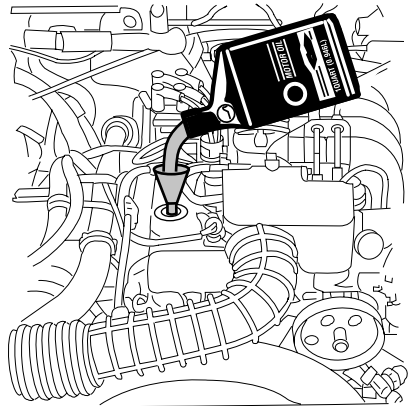

Maintenance and Specifications

- 3.0L V6 engine
SAE 5W-20

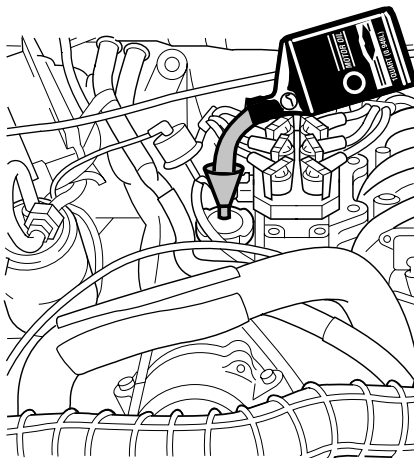

- 4.0L SOHC V6 engine
SAE 5W-30

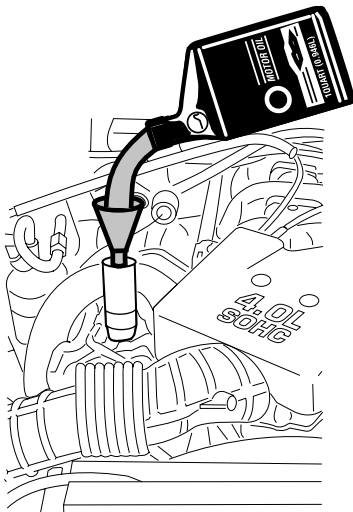

- Oil levels above the MAX mark or upper hole may cause engine damage. Some oil must be removed from the engine by an authorized dealer.

7. Put the dipstick back in and ensure it is fully seated.

Adding engine oil

1. Check the engine oil. For instructions, refer to *Checking the engine oil* in this chapter.
2. If the engine oil level is not within the normal range, add only certified engine oil of the recommended viscosity. Remove the engine oil filler cap and use a funnel to pour the engine oil into the opening.
3. Recheck the engine oil level. Make sure the oil level is within the normal range on the engine oil level dipstick.
4. Install the dipstick and ensure it is fully seated.
5. Fully install the engine oil filler cap by turning the filler cap 1/4 turn until it stops.

To avoid possible oil loss, DO NOT operate the vehicle with the engine oil level dipstick and/or the engine oil filler cap removed.

Engine Oil Recommendations

2.3L & 3.0L Engines

Look for this certification trademark.



SAE 5W-20 engine oil is recommended.

Only use oils “Certified For Gasoline Engines” by the American Petroleum Institute (API). An oil with this trademark symbol conforms to the current engine and emission system protection standards and fuel economy requirements of the International Lubricant Standardization and Approval Committee (ILSAC), comprised of U.S. and Japanese

Maintenance and Specifications

automobile manufacturers. Use an equivalent oil Mazda specification. **SAE 5W-20 oil provides optimum fuel economy and durability performance meeting all requirements for your vehicle's engine.**

Change your engine oil and filter according to the appropriate schedule listed in *scheduled maintenance*.

Do not use supplemental engine oil additives, oil treatments or engine treatments. They are unnecessary and could, under certain conditions, lead to engine damage which is not covered by your warranty.

4.0L Engine

Look for this certification trademark.



SAE 5W-30 engine oil is recommended.

Only use oils “Certified For Gasoline Engines” by the American Petroleum Institute (API). An oil with this trademark symbol conforms to the current engine and emission system protection standards and fuel economy requirements of the International Lubricant Standardization and Approval Committee (ILSAC), comprised of U.S. and Japanese automobile manufacturers. Use an equivalent Mazda Specification.

Do not use supplemental engine oil additives, oil treatments or engine treatments. They are unnecessary and could, under certain conditions, lead to engine damage which is not covered by your warranty.

Change your engine oil according to the appropriate schedule listed in *scheduled maintenance*.

Engine Oil Filter Recommendation

Change your engine oil filter according to the appropriate schedule listed in *scheduled maintenance*. Mazda production and aftermarket (Mazda)

Maintenance and Specifications

oil filters are designed for added engine protection and long life. If a replacement oil filter is used that does not meet Mazda Material and design specifications, start-up engine noises or knock may be experienced.

Mazda production and replacement oil filters are designed for added engine protection and long life. If a replacement oil filter is used that does not meet Mazda material and design specifications, start-up engine noises or knock may be experienced.

It is recommended you use the appropriate Mazda oil filter or another with equivalent performance for your engine application.

BATTERY

Your vehicle is equipped with a Mazda maintenance-free battery which normally does not require additional water during its life of service.

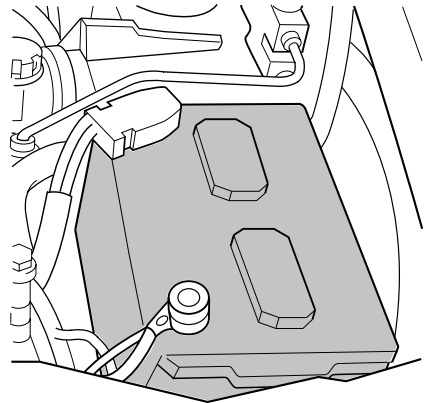

If your battery has a cover/shield, make sure it is reinstalled after the battery has been cleaned or replaced.

For longer, trouble-free operation, keep the top of the battery clean and dry. Also, make certain the battery cables are always tightly fastened to the battery terminals.

If you see any corrosion on the battery or terminals, remove the cables from the terminals and clean with a wire brush. You can neutralize the acid with a solution of baking soda and water.

Note: Electrical or electronic accessories or components added to the vehicle by the dealer or the owner may adversely affect battery performance and durability.

Maintenance and Specifications

It is recommended that the negative battery cable terminal be disconnected from the battery if you plan to store your vehicle for an extended period of time. This will minimize the discharge of your battery during storage.

WARNING: Batteries normally produce explosive gases which can cause personal injury. Therefore, do not allow flames, sparks or lighted substances to come near the battery. When working near the battery, always shield your face and protect your eyes. Always provide proper ventilation.

WARNING: When lifting a plastic-cased battery, excessive pressure on the end walls could cause acid to flow through the vent caps, resulting in personal injury and/or damage to the vehicle or battery. Lift the battery with a battery carrier or with your hands on opposite corners.

WARNING: Keep batteries out of reach of children. Batteries contain sulfuric acid. Avoid contact with skin, eyes or clothing. Shield your eyes when working near the battery to protect against possible splashing of acid solution. In case of acid contact with skin or eyes, flush immediately with water for a minimum of 15 minutes and get prompt medical attention. If acid is swallowed, call a physician immediately.

WARNING: Battery posts, terminals and related accessories contain lead and lead compounds. Wash hands after handling.

Because your vehicle's engine is electronically controlled by a computer, some control conditions are maintained by power from the battery. When the battery is disconnected or a new battery is installed, the engine must relearn its idle and fuel trim strategy for optimum driveability and performance. To begin this process:

1. With the vehicle at a complete stop, set the parking brake.
2. Put the gearshift in P (Park) (automatic transmission) or the neutral position (manual transmission), turn off all accessories and start the engine.
3. Run the engine until it reaches normal operating temperature.
4. Allow the engine to idle for at least one minute.

Maintenance and Specifications

5. Turn the A/C on and allow the engine to idle for at least one minute.
 6. Drive the vehicle to complete the relearning process.
- The vehicle may need to be driven 10 miles (16 km) or more to relearn the idle and fuel trim strategy.
 - **If you do not allow the engine to relearn its idle trim, the idle quality of your vehicle may be adversely affected until the idle trim is eventually relearned.**

When the battery is disconnected or a new battery installed, the transmission must relearn its adaptive strategy. As a result of this, the transmission may shift firmly. This operation is considered normal and will not affect function or durability of the transmission. Over time the adaptive learning process will fully update transmission operation to its optimum shift feel.

If the battery has been disconnected or a new battery has been installed, the clock and the preset radio stations must be reset once the battery is reconnected.

- Always dispose of automotive batteries in a responsible manner. Follow your local authorized standards for disposal. Call your local authorized recycling center to find out more about recycling automotive batteries.

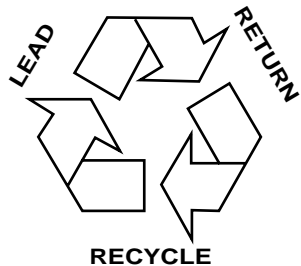

ENGINE COOLANT

Checking engine coolant

Your engine's cooling system has been factory-filled with a 50/50 mixture of distilled water and Mazda Genuine Engine Coolant, or an equivalent premium engine coolant that meets Mazda specification.

A **50/50 mixture** of distilled water and Mazda Genuine Engine Coolant provides:

- **maximum cooling system efficiency.**
- **freeze protection down to -34°F (-36°C).**
- **boiling protection up to 265°F (129°C).**
- **protection against rust and other forms of corrosion.**

Maintenance and Specifications

- an accurate temperature readout from the engine coolant gauge.

The engine coolant must be maintained at the correct fluid level and concentration to work properly. If the engine coolant fluid level and concentration is not maintained correctly, damage to the engine and cooling system may result.

- 2.3L engine

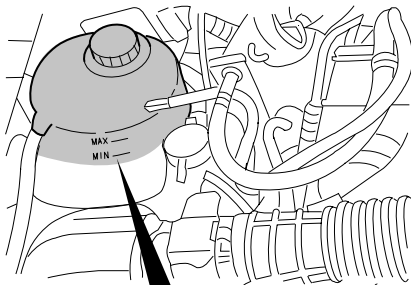

Maintenance and Specifications

- 3.0L & 4.0L engines

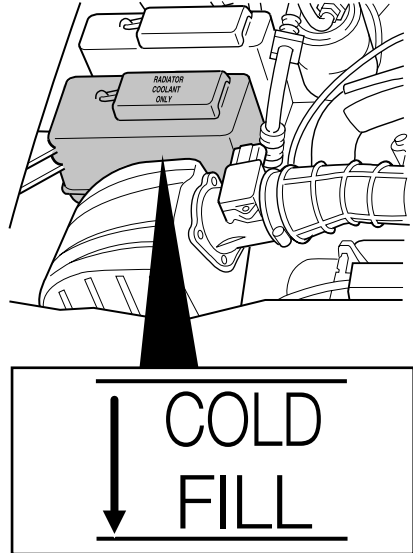

When the engine is cold, check the level of the engine coolant in the reservoir.

- The engine coolant should be at the “cold fill level” or within the “cold fill range” as listed on the engine coolant reservoir (depending upon application).
- Confirm the color and type of engine coolant before adding, to avoid mixing incompatible products.
- Refer to *scheduled maintenance* for service interval schedules.
- Be sure to read and understand *Precautions when servicing your vehicle* in this chapter.

If the engine coolant has not been checked at the recommended interval, the engine coolant reservoir may become low or empty. If the reservoir is low or empty, add engine coolant to the reservoir. Refer to *Adding engine coolant* in this chapter.

WARNING: Automotive fluids are not interchangeable; do not use engine coolant, antifreeze or windshield washer fluid outside of its specified function and vehicle location.

Maintenance and Specifications

Adding engine coolant

Use only Mazda Genuine Engine Coolant or a premium engine coolant that meets a Mazda specification.

- **DO NOT USE Extended Life Engine Coolant (orange in color).**
- **DO NOT USE a DEX-COOL® engine coolant or an equivalent engine coolant.**
- **DO NOT USE alcohol or methanol antifreeze or any engine coolants mixed with alcohol or methanol antifreeze.**
- **DO NOT USE supplemental coolant additives in your vehicle. These additives may harm your engine's cooling system.**
- **DO NOT MIX different colors or types of coolant in your vehicle. Make sure the correct coolant is used.**
- **DO NOT MIX recycled coolant and conventional coolant together in your vehicle. Mixing of engine coolants may harm your engine's cooling system.**
- **The use of an improper coolant may harm engine and cooling system components and may void the warranty of your vehicle's engine cooling system. If you are unsure which type of coolant your vehicle requires, contact your local authorized dealer.**

WARNING: Do not put engine coolant in the windshield washer fluid reservoir. If engine coolant is sprayed onto the windshield, it could make it difficult to see through the windshield.

When adding coolant, make sure it is a 50/50 mixture of engine coolant and distilled water. Add the mixture to the coolant reservoir, **when the engine is cool**, until the appropriate fill level is obtained.

- **NEVER increase the coolant concentration above 60%.**
- **NEVER decrease the coolant concentration below 40%.**
- **Engine coolant concentrations above 68% or below 40% will decrease the freeze protection characteristics of the engine coolant and may cause engine damage.**

A large amount of water without engine coolant may be added, in case of emergency, to reach a vehicle service location. In this instance, the cooling system must be drained and refilled with a 50/50 mixture of engine coolant and distilled water as soon as possible. Water alone (without engine coolant) can cause engine damage from corrosion, overheating or freezing.

Maintenance and Specifications

For vehicles with overflow coolant systems with a non-pressurized cap on the coolant recovery system, add coolant to the coolant recovery reservoir when the engine is cool. Add the proper mixture of coolant and water to the “FULL COLD” level. For all other vehicles, which have a coolant degas system with a pressurized cap, or if it is necessary to remove the coolant pressure relief cap on the radiator of a vehicle with an overflow system, follow these steps to add engine coolant.

Note: The 3.0L and 4.0L V6 engines use the overflow system, and the 2.3L I4 engines use the degas system.

WARNING: To avoid scalding hot steam or coolant from being released from the engine cooling system, never remove the reservoir cap while the engine is running or hot. Failure to follow this warning may result in possible severe personal injury and damage to the engine's cooling system.

Add the proper mixture of coolant and water to the cooling system by following these steps:

1. Before you remove the cap, turn the engine off and let it cool.
2. When the engine is cool, wrap a thick cloth around the cap. Slowly turn cap counterclockwise until pressure begins to release.
3. Step back while the pressure releases.
4. When you are sure that all the pressure has been released, use the cloth to turn it counterclockwise and remove the cap.
5. Fill the coolant reservoir slowly with the proper coolant mixture (see above), to within the “COLD FILL RANGE” or the “FULL COLD” level on the reservoir. If you removed the radiator cap in an overflow system, fill the radiator until the coolant is visible and radiator is almost full.
6. Replace the cap. Turn until tightly installed. Cap must be tightly installed to prevent coolant loss.

After any coolant has been added, check the coolant concentration, refer to *Checking engine coolant*. If the concentration is not 50/50 (protection to $-34^{\circ}\text{ F}/-36^{\circ}\text{ C}$), drain some coolant and adjust the concentration. It may take several drains and additions to obtain a 50/50 coolant concentration.

Whenever coolant has been added, the coolant level in the coolant reservoir should be checked the next few times you drive the vehicle. If necessary, add enough 50/50 concentration of engine coolant and distilled water to bring the liquid level to the proper level.

Maintenance and Specifications

If you have to add more than 1.0 quart (1.0 liter) of engine coolant per month, have your authorized dealer check the engine cooling system. Your cooling system may have a leak. Operating an engine with a low level of coolant can result in engine overheating and possible engine damage.

Recycled engine coolant

Not all coolant recycling processes produce coolant which meets Mazda specification. Use of a recycled engine coolant which does not meet Mazda specifications may harm engine and cooling system components.



Always dispose of used automotive fluids in a responsible manner. Follow your community's regulations and standards for recycling and disposing of automotive fluids.

Coolant refill capacity

To find out how much fluid your vehicle's cooling system can hold, refer to *Maintenance product specifications and capacities* in this chapter. Fill your engine coolant reservoir as outlined in *Adding engine coolant* in this section.

Severe climates

If you drive in extremely cold climates (less than -34°F [-36°C]):

- **It may be necessary to increase the coolant concentration above 50%.**
- **NEVER increase the coolant concentration above 60%.**
- **Increased engine coolant concentrations above 60% will decrease the overheat protection characteristics of the engine coolant and may cause engine damage.**
- **Refer to the chart on the coolant container to ensure the coolant concentration in your vehicle will provide adequate freeze protection at the temperatures in which you drive in the winter months.**

If you drive in extremely hot climates:

- **It is still necessary to maintain the coolant concentration above 40%.**
- **NEVER decrease the coolant concentration below 40%.**
- **Decreased engine coolant concentrations below 40% will decrease the corrosion protection characteristics of the engine coolant and may cause engine damage.**

Maintenance and Specifications

- **Decreased engine coolant concentrations below 40% will decrease the freeze protection characteristics of the engine coolant and may cause engine damage.**
- **Refer to the chart on the coolant container to ensure the coolant concentration in your vehicle will provide adequate protection at the temperatures in which you drive.**

Vehicles driven year-round in non-extreme climates should use a 50/50 mixture of engine coolant and distilled water for optimum cooling system and engine protection.

FUEL FILTER

For fuel filter replacement, see your authorized dealer. Refer to *scheduled maintenance information* for the appropriate intervals for changing the fuel filter.

Replace the fuel filter with an authorized Mazda part. The customer warranty may be void for any damage to the fuel system if an authorized Mazda fuel filter is not used.

WHAT YOU SHOULD KNOW ABOUT AUTOMOTIVE FUELS

Important safety precautions

WARNING: Do not overfill the fuel tank. The pressure in an overfilled tank may cause leakage and lead to fuel spray and fire.

WARNING: The fuel system may be under pressure. If the fuel filler cap is venting vapor or if you hear a hissing sound, wait until it stops before completely removing the fuel filler cap. Otherwise, fuel may spray out and injure you or others.

WARNING: If you do not use the proper fuel filler cap, excessive vacuum in the fuel tank may damage the fuel system or cause the fuel cap to disengage in a collision, which may result in possible personal injury.

WARNING: Automotive fuels can cause serious injury or death if misused or mishandled.

Maintenance and Specifications

WARNING: Gasoline may contain benzene, which is a cancer-causing agent.

Observe the following guidelines when handling automotive fuel:

- Extinguish all smoking materials and any open flames before fueling your vehicle.
- Always turn off the vehicle before fueling.
- Automotive fuels can be harmful or fatal if swallowed. Fuel such as gasoline is highly toxic and if swallowed can cause death or permanent injury. If fuel is swallowed, call a physician immediately, even if no symptoms are immediately apparent. The toxic effects of fuel may not be visible for hours.
- Avoid inhaling fuel vapors. Inhaling too much fuel vapor of any kind can lead to eye and respiratory tract irritation. In severe cases, excessive or prolonged breathing of fuel vapor can cause serious illness and permanent injury.
- Avoid getting fuel liquid in your eyes. If fuel is splashed in the eyes, remove contact lenses (if worn), flush with water for 15 minutes and seek medical attention. Failure to seek proper medical attention could lead to permanent injury.
- Fuels can also be harmful if absorbed through the skin. If fuel is splashed on the skin and/or clothing, promptly remove contaminated clothing and wash skin thoroughly with soap and water. Repeated or prolonged skin contact with fuel liquid or vapor causes skin irritation.
- Be particularly careful if you are taking “Antabuse” or other forms of disulfiram for the treatment of alcoholism. Breathing gasoline vapors, or skin contact could cause an adverse reaction. In sensitive individuals, serious personal injury or sickness may result. If fuel is splashed on the skin, promptly wash skin thoroughly with soap and water. Consult a physician immediately if you experience an adverse reaction.



WARNING: When refueling always shut the engine off and never allow sparks or open flames near the filler neck. Never smoke while refueling. Fuel vapor is extremely hazardous under certain conditions. Care should be taken to avoid inhaling excess fumes.

WARNING: The flow of fuel through a fuel pump nozzle can produce static electricity, which can cause a fire if fuel is pumped into an ungrounded fuel container.

Use the following guidelines to avoid electrostatic charge build-up when filling an ungrounded fuel container:

- Place approved fuel container on the ground.
- DO NOT fill a fuel container while it is in the vehicle (including the cargo area/pickup bed).
- Keep the fuel pump nozzle in contact with the fuel container while filling.
- DO NOT use a device that would hold the fuel pump handle in the fill position.





Fuel Filler Cap

Your fuel tank filler cap has an indexed design with a 1/4 turn on/off feature.



When fueling your vehicle:

1. Turn the engine off.
2. Carefully turn the filler cap counterclockwise 1/4 of a turn to remove it.
3. Pull to remove the cap from the fuel filler pipe.
4. To install the cap, align the tabs on the cap with the notches on the filler pipe.
5. Turn the filler cap clockwise 1/4 of a turn until it clicks at least once.

If the check fuel cap lamp  or a “check fuel cap” message comes on, the fuel filler cap may not be properly installed. The lamp or message can come on after several driving events after you’ve refueled your vehicle.

At the next opportunity, safely pull off of the road, remove the fuel filler cap, align the cap properly and reinstall it. The check fuel cap lamp  or “check fuel cap” message may not reset immediately; it may take several driving cycles for the check fuel cap lamp  or “check fuel cap” message to turn off. A driving cycle consists of an engine start-up (after four or more hours with the engine off) followed by city and highway driving.

Maintenance and Specifications

Continuing to drive with the check fuel cap lamp  or “check fuel cap” message on may cause the  lamp to turn on as well.

If you must replace the fuel filler cap, replace it with a fuel filler cap that is designed for your vehicle. The warranty may be void for any damage to the fuel tank or fuel system if the correct genuine Mazda fuel filler cap is not used.

WARNING: The fuel system may be under pressure. If the fuel filler cap is venting vapor or if you hear a hissing sound, wait until it stops before completely removing the fuel filler cap. Otherwise, fuel may spray out and injure you or others.

WARNING: If you do not use the proper fuel filler cap, excessive vacuum in the fuel tank may damage the fuel system or cause the fuel cap to disengage in a collision, which may result in personal injury.

Choosing the right fuel

Use only UNLEADED fuel or UNLEADED fuel blended with a maximum of 10% ethanol. Your vehicle was not designed to run on E85 fuels that are blended with a maximum of 85% ethanol. The use of leaded fuel is prohibited by law and could damage your vehicle. Do not use fuel containing methanol. It can damage critical fuel system components.

Your vehicle was not designed to use fuel or fuel additives with metallic compounds, including manganese-based additives. Studies indicate that these additives can cause your vehicle’s emission control system to deteriorate more rapidly.

Repairs to correct the effects of using a fuel for which your vehicle was not designed may not be covered by your warranty.

Cleaner air

Mazda endorses the use of reformulated “cleaner-burning” gasolines to improve air quality, per the recommendations in the *Choosing the Right Fuel* section.

Octane recommendations

Your vehicle is designed to use “Regular” unleaded gasoline with pump (R+M)/2 octane rating of 87.

We do not recommend the use of gasolines labeled as “Regular” that are sold with octane ratings of 86 or lower in high altitude areas.

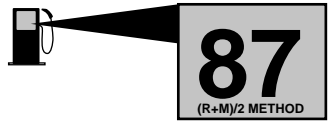

Do not be concerned if your engine sometimes knocks lightly. However, if it knocks heavily under most driving conditions while you are using fuel with the recommended octane rating, see your authorized dealer to prevent any engine damage.

Fuel quality

If you are experiencing starting, rough idle or hesitation driveability problems, try a different brand of unleaded gasoline. “Premium” unleaded gasoline is not recommended for vehicles designed to use “Regular” unleaded gasoline because it may cause these problems to become more pronounced. If the problems persist, see your authorized dealer.

Do not add aftermarket fuel additive products to your fuel tank. It should not be necessary to add any aftermarket products to your fuel tank if you continue to use high quality fuel of the recommended octane rating. These products have not been approved for your engine and could cause damage to the fuel system. Repairs to correct the effects of using an aftermarket product in your fuel may not be covered by your warranty.

Many of the world’s automakers approved the World-Wide Fuel Charter that recommends gasoline specifications to provide improved performance and emission control system protection for your vehicle. Gasolines that meet the World-Wide Fuel Charter should be used when available. Ask your fuel supplier about gasolines that meet the World-Wide Fuel Charter.

Running out of fuel

Avoid running out of fuel because this situation may have an adverse effect on powertrain components.

If you have run out of fuel:

- You may need to cycle the ignition from OFF to ON several times after refueling to allow the fuel system to pump the fuel from the tank to the engine. On restarting, cranking time will take a few seconds longer than normal.

Maintenance and Specifications

- Normally, adding 1 gallon (3.8L) of fuel is enough to restart the engine. If the vehicle is out of fuel and on a steep grade, more than 1 gallon (3.8L) may be required.
- The  indicator may come on. For more information on the “check engine” or the “service engine soon” indicator, refer to *Warning lights and chimes* in the *Instrument Cluster* chapter.

ESSENTIALS OF GOOD FUEL ECONOMY

Measuring techniques

Your best source of information about actual fuel economy is you, the driver. You must gather information as accurately and consistently as possible. Fuel expense, frequency of fillups or fuel gauge readings are NOT accurate as a measure of fuel economy. We do not recommend taking fuel economy measurements during the first 1,000 miles (1,600 km) of driving (engine break-in period). You will get a more accurate measurement after 2,000 miles-3,000 miles (3,000 km-5,000 km).

Filling the tank

The advertised fuel capacity of the fuel tank on your vehicle is equal to the rated refill capacity of the fuel tank as listed in the *Maintenance product specifications and capacities* section of this chapter.

The advertised capacity is the amount of the indicated capacity and the empty reserve combined. Indicated capacity is the difference in the amount of fuel in a full tank and a tank when the fuel gauge indicates empty. Empty reserve is the small amount of fuel remaining in the fuel tank after the fuel gauge indicates empty.

The amount of usable fuel in the empty reserve varies and should not be relied upon to increase driving range. When refueling your vehicle after the fuel gauge indicates empty, you might not be able to refuel the full amount of the advertised capacity of the fuel tank due to the empty reserve still present in the tank.

For consistent results when filling the fuel tank:

- Turn the engine/ignition switch to the off position prior to refueling, an error in the reading will result if the engine is left running.
- Use the same filling rate setting (low — medium — high) each time the tank is filled.
- Allow no more than two automatic click-offs when filling.

- Always use fuel with the recommended octane rating.
- Use a known quality gasoline, preferably a national brand.
- Use the same side of the same pump and have the vehicle facing the same direction each time you fill up.
- Have the vehicle loading and distribution the same every time.

Your results will be most accurate if your filling method is consistent.

Calculating fuel economy

1. Fill the fuel tank completely and record the initial odometer reading (in miles or kilometers).
2. Each time you fill the tank, record the amount of fuel added (in gallons or liters).
3. After at least three to five tank fill-ups, fill the fuel tank and record the current odometer reading.
4. Subtract your initial odometer reading from the current odometer reading.
5. Follow one of the simple calculations in order to determine fuel economy:

Calculation 1: **Divide total miles traveled by total gallons used.**

Calculation 2: **Multiply liters used by 100, then divide by total kilometers traveled.**

Keep a record for at least one month and record the type of driving (city or highway). This will provide an accurate estimate of the vehicle's fuel economy under current driving conditions. Additionally, keeping records during summer and winter will show how temperature impacts fuel economy. In general, lower temperatures give lower fuel economy.

Driving style — good driving and fuel economy habits

Give consideration to the lists that follow and you may be able to change a number of variables and improve your fuel economy.

Habits

- Smooth, moderate operation can yield up to 10% savings in fuel.
- Steady speeds without stopping will usually give the best fuel economy.
- Idling for long periods of time (greater than one minute) may waste fuel.

Maintenance and Specifications

- Anticipate stopping; slowing down may eliminate the need to stop.
- Sudden or hard accelerations may reduce fuel economy.
- Slow down gradually.
- Driving at reasonable speeds (traveling at 55 mph [88 km/h] uses 15% less fuel than traveling at 65 mph [105 km/h]).
- Revving the engine before turning it off may reduce fuel economy.
- Using the air conditioner or defroster may reduce fuel economy.
- You may want to turn off the speed control in hilly terrain if unnecessary shifting between fourth and fifth gear occurs. Unnecessary shifting of this type could result in reduced fuel economy.
- Warming up a vehicle on cold mornings is not required and may reduce fuel economy.
- Resting your foot on the brake pedal while driving may reduce fuel economy.
- Combine errands and minimize stop-and-go driving.

Maintenance

- Keep tires properly inflated and use only recommended size.
- Operating a vehicle with the wheels out of alignment will reduce fuel economy.
- Use recommended engine oil. Refer to the *Maintenance product specifications and capacities* section of this chapter.
- Perform all regularly scheduled maintenance items. Follow the recommended maintenance schedule and owner maintenance checks found in *scheduled maintenance*.

Conditions

- Heavily loading a vehicle or towing a trailer may reduce fuel economy at any speed.
- Carrying unnecessary weight may reduce fuel economy (approximately 1 mpg [0.4 km/L] is lost for every 400 lb [180 kg] of weight carried).
- Adding certain accessories to your vehicle (for example bug deflectors, rollbars/light bars, running boards, ski/luggage racks) may reduce fuel economy.
- Using fuel blended with alcohol may lower fuel economy.
- Fuel economy may decrease with lower temperatures during the first 8–10 miles (12–16 km) of driving.

- Driving on flat terrain offers improved fuel economy as compared to driving on hilly terrain.
- Transmissions give their best fuel economy when operated in the top cruise gear and with steady pressure on the gas pedal.
- Four-wheel-drive operation (if equipped) is less fuel efficient than two-wheel-drive operation.
- Close windows for high speed driving.

EPA window sticker

Every new vehicle should have the EPA window sticker. Contact your authorized dealer if the window sticker is not supplied with your vehicle. The EPA window sticker should be your guide for the fuel economy comparisons with other vehicles.

It is important to note the box in the lower left corner of the window sticker. These numbers represent the Range of MPG (L/100 km) expected on the vehicle under optimum conditions. Your fuel economy may vary depending upon the method of operation and conditions.

EMISSION CONTROL SYSTEM

Your vehicle is equipped with various emission control components and a catalytic converter which will enable your vehicle to comply with applicable exhaust emission standards. To make sure that the catalytic converter and other emission control components continue to work properly:

- Use only the specified fuel listed.
- Avoid running out of fuel.
- Do not turn off the ignition while your vehicle is moving, especially at high speeds.
- Have the items listed in the *scheduled maintenance* section performed according to the specified schedule.

The scheduled maintenance items listed in the scheduled maintenance section are essential to the life and performance of your vehicle and to its emissions system.

If other than Mazda authorized parts are used for maintenance replacements or for service of components affecting emission control, such non-Mazda parts should be equivalent to genuine Mazda parts in performance and durability.

Maintenance and Specifications

WARNING: Do not park, idle, or drive your vehicle in dry grass or other dry ground cover. The emission system heats up the engine compartment and exhaust system, which can start a fire.



Illumination of the  indicator, charging system warning light or the temperature warning light, fluid leaks, strange odors, smoke or loss of engine power, could indicate that the emission control system is not working properly.

WARNING: Exhaust leaks may result in entry of harmful and potentially lethal fumes into the passenger compartment.

Do not make any unauthorized changes to your vehicle or engine. By law, vehicle owners and anyone who manufactures, repairs, services, sells, leases, trades vehicles, or supervises a fleet of vehicles are not permitted to intentionally remove an emission control device or prevent it from working. Information about your vehicle's emission system is on the Vehicle Emission Control Information Decal located on or near the engine. This decal identifies engine displacement and gives some tune up specifications.

Please consult your "Warranty Information" for complete emission warranty information.



On board diagnostics (OBD-II)

Your vehicle is equipped with a computer that monitors the engine's emission control system. This system is commonly known as the On Board Diagnostics System (OBD-II). The OBD-II system protects the environment by ensuring that your vehicle continues to meet government emission standards. The OBD-II system also assists your authorized dealer in properly servicing your vehicle. When the  indicator illuminates, the OBD-II system has detected a malfunction. Temporary malfunctions may cause the  indicator to illuminate. Examples are:

1. The vehicle has run out of fuel—the engine may misfire or run poorly.
2. Poor fuel quality or water in the fuel—the engine may misfire or run poorly.
3. The fuel cap may not have been securely tightened. See *Fuel filler cap* in this chapter.

4. Driving through deep water—the electrical system may be wet.



These temporary malfunctions can be corrected by filling the fuel tank with good quality fuel, properly tightening the fuel cap or letting the electrical system dry out. After three driving cycles without these or any other temporary malfunctions present, the  indicator should stay off the next time the engine is started. A driving cycle consists of a cold engine startup followed by mixed city/highway driving. No additional vehicle service is required.

If the  indicator remains on, have your vehicle serviced at the first available opportunity. Although some malfunctions detected by the OBD-II may not have symptoms that are apparent, continued driving with the  indicator on can result in increased emissions, lower fuel economy, reduced engine and transmission smoothness, and lead to more costly repairs.

Readiness for Inspection/Maintenance (I/M) testing

Some state/provincial and local governments may have Inspection/Maintenance (I/M) programs to inspect the emission control equipment on your vehicle. Failure to pass this inspection could prevent you from getting a vehicle registration. Your vehicle may not pass the I/M test if the  indicator is on or not working properly (bulb is burned out), or if the OBD-II system has determined that some of the emission control systems have not been properly checked. In this case, the vehicle is considered not ready for I/M testing.

If the  indicator is on or the bulb does not work, the vehicle may need to be serviced. Refer to the On board diagnostics (OBD-II) description in this chapter.

If the vehicle's engine or transmission has just been serviced, or the battery has recently run down or been replaced, the OBD-II system may indicate that the vehicle is not ready for I/M testing. To determine if the vehicle is ready for I/M testing, turn the ignition key to the ON position for 15 seconds without cranking the engine. If the  indicator blinks eight times, it means that the vehicle is not ready for I/M testing; if the  indicator stays on solid, it means that the vehicle is ready for I/M testing.

The OBD-II system is designed to check the emission control system during normal driving. A complete check may take several days. If the vehicle is not ready for I/M testing, the following driving cycle consisting of mixed city and highway driving may be performed:

Maintenance and Specifications

15 minutes of steady driving on an expressway/highway followed by 20 minutes of stop-and-go driving with at least four 30-second idle periods.

Allow the vehicle to sit for at least eight hours without starting the engine. Then, start the engine and complete the above driving cycle. The engine must warm up to its normal operating temperature. Once started, do not turn off the engine until the above driving cycle is complete. If the vehicle is still not ready for I/M testing, the above driving cycle will have to be repeated.

POWER STEERING FLUID

- 2.3L I4 engine

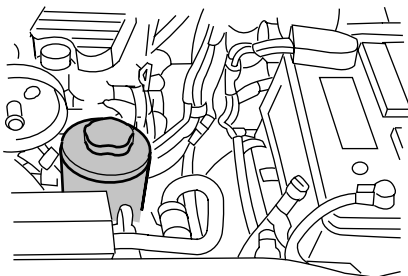

- 3.0L V6 engine

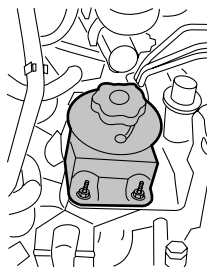

- 4.0L V6 engine

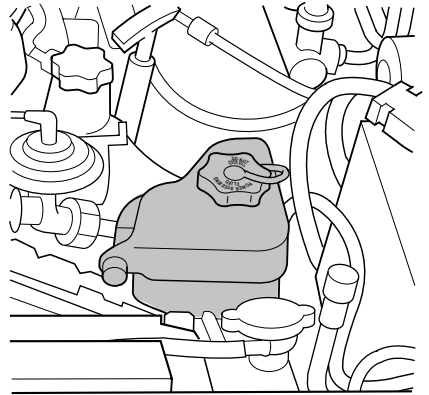

Check the power steering fluid. Refer to the service maintenance section for the service interval schedules.

1. Start the engine and let it run until it reaches normal operating temperature (the engine coolant temperature gauge indicator will be near the center of the normal area between H and C).
2. While the engine idles, turn the steering wheel left and right several times.
3. Turn the engine off.
4. Check the fluid level in the reservoir. It should be between the MIN and MAX lines. Do not add fluid if the level is within this range.
5. If the fluid is low, add fluid in small amounts, until it reaches between the MIN and MAX lines. Refer to *Maintenance product specifications and capacities* in this chapter for the proper fluid type.

Maintenance and Specifications

BRAKE FLUID (C)

The fluid level will drop slowly as the brakes wear, and will rise when the brake components are replaced. Fluid levels between the “MIN” and “MAX” lines are within the normal operating range; there is no need to add fluid. If the fluid levels are outside of the normal operating range the performance of the system could be compromised; seek service from your authorized dealer immediately.

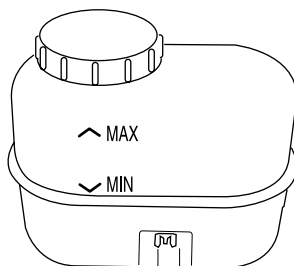

CLUTCH FLUID (IF EQUIPPED)

Check the fluid level. Refer to *scheduled maintenance* for the service interval schedules.

During normal operation, the fluid level in the clutch reservoir should remain constant. If the fluid level drops, refill the fluid level to the step in the reservoir.

Use only a DOT 3 brake fluid designed to meet Mazda specification. Refer to *Maintenance product specifications and capacities* in this chapter.

WARNING: Carefully read cautionary information on product label. For MEDICAL EMERGENCY INFORMATION contact a physician or Poison Control Center immediately. Failure to follow these instructions may result in personal injury.

1. Clean the reservoir cap before removal to prevent dirt and water from entering the reservoir.
2. Remove cap and rubber diaphragm from reservoir.
3. Add fluid until the level reaches the step in the reservoir.
4. Reinstall rubber diaphragm and cap onto reservoir.

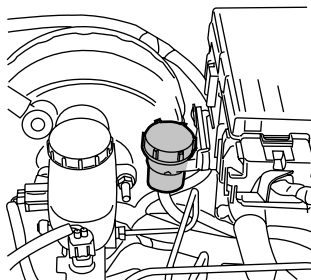

TRANSMISSION FLUID

Checking automatic transmission fluid

- Refer to *scheduled maintenance information* for scheduled check and change intervals.
- Transmission does not consume fluid.
- Check fluid when transmission is not operating properly or if you see a leak.
- Fluid level must be checked at normal operating temperature, 20 miles (30 km) of driving.

To check and add fluid:

1. Drive the vehicle 20 miles (30 km) to reach normal operating temperatures.
2. If driven in hot weather, city traffic, pulling a trailer, allow transmission to cool for 30 minutes before checking.
3. Engage parking brake, start engine.
4. Put your foot on the brake pedal and move the gearshift lever slowly through all of the gear ranges.
5. Shift to P (Park) and leave the engine running.
6. Remove the dipstick, wipe clean with a dry lint free rag.
7. Install and fully seat the dipstick into the filler tube.
8. Remove the dipstick and inspect the fluid level. Level should be in the cross-hatched area.

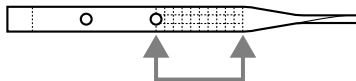

9. If necessary, add fluid in 1/2 pint (250ml) increments through the filler tube until the level is correct at normal operating temperatures. Refer to the *Maintenance product specifications and capacities* section in this chapter for the correct fluid type. The use of any other non-approved fluid may cause internal transmission damage.
10. Fluid can be checked at ambient temperatures between 50–95°F (10–30°C). DO NOT ADD fluid until the transmission is at normal operating temperatures or the transmission will be overfilled.

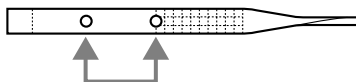

Maintenance and Specifications

Low fluid level

Do not drive the vehicle if the fluid level is at or below the bottom of the dipstick.

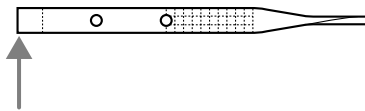

High fluid level

Fluid levels above the safe range may cause overheating, shift and/or engagement concerns and internal transmission damage. If an overfill condition occurs, excess fluid should be removed by an authorized dealer.

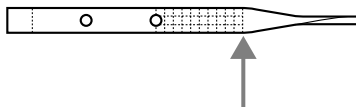

Checking and adding manual transmission fluid (if equipped)

1. Park the vehicle on a level surface.
2. Engage the parking brake fully – put in first gear.
3. Ensure that the vehicle cannot move.
4. Clean the filler plug.
5. Remove the filler plug and inspect the fluid level.

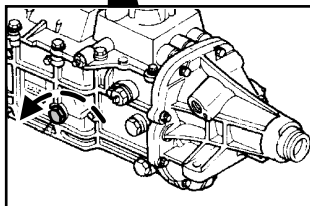
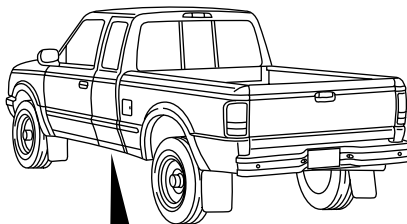

Maintenance and Specifications

6. Fluid level should be at the bottom of the opening.
7. Add enough fluid through the filler opening so that the fluid level is at the bottom of the opening.
8. Install and tighten the fill plug securely.

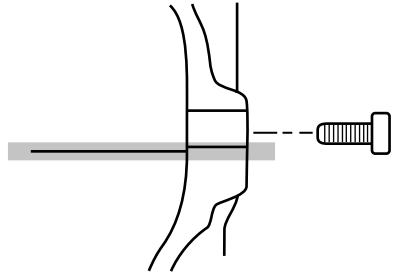

Use only fluid that meets Mazda specifications. Refer to the *Maintenance product specifications and capacities* section in this chapter.

TRANSFER CASE FLUID (IF EQUIPPED)

1. Park the vehicle on a level surface.
2. Engage the parking brake fully – put in first gear.
3. Ensure the vehicle cannot move.
4. Clean the filler plug.
5. Remove the filler plug and inspect the fluid level.
6. Fluid level should be at the bottom of the opening.
7. Add enough fluid through the filler opening so that the fluid level is at the bottom of the opening.
8. Install and tighten the fill plug securely.

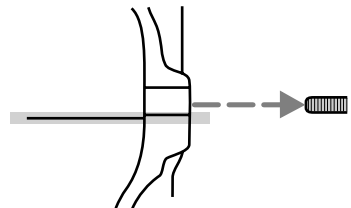
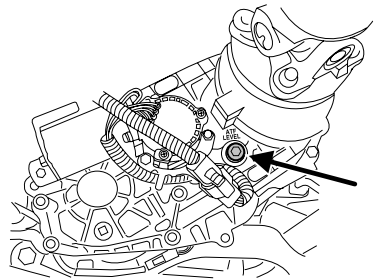

Use only fluid that meets Mazda specifications. Refer to the *Maintenance product specifications and capacities* section in this chapter.

Maintenance and Specifications

DRIVELINE UNIVERSAL JOINT AND SLIP YOKE

Your vehicle may be equipped with universal joints that require lubrication. If the original universal joints are replaced with universal joints equipped with grease fittings, lubrication will also be necessary.

CHECKING AND ADDING REAR DIFFERENTIAL FLUID

1. Park the vehicle on a level surface.
2. Engage the parking brake fully – put in first gear.
3. Ensure the vehicle cannot move.
4. Clean the filler plug.
5. Remove the filler plug and inspect the fluid level.
6. Fluid level should be at the bottom of the opening.
7. Add enough fluid through the filler opening so that the fluid level is at the bottom of the opening.
8. Install and tighten the fill plug securely.

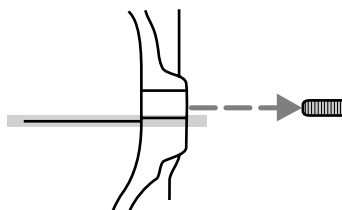
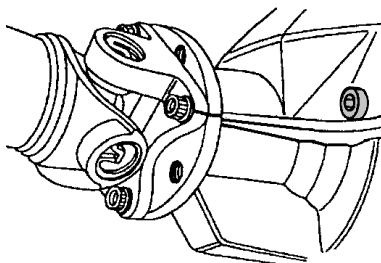

Use only fluid that meets Mazda specifications. Refer to the *Maintenance product specifications and capacities* section in this chapter.

AIR FILTER

Refer to *scheduled maintenance* for the appropriate intervals for changing the air filter element.

When changing the air filter element, only use a genuine Mazda air filter element.

WARNING: To reduce the risk of vehicle damage and/or personal burn injuries do not start your engine with the air cleaner removed and do not remove it while the engine is running.

Maintenance and Specifications

1. Loosen the clamp that secures the air inlet tube to the engine air filter cover and disconnect the tube from the cover (for V6 only).
2. Release the clamps that secure the air filter housing cover.
3. Carefully separate the two halves of the air filter housing.

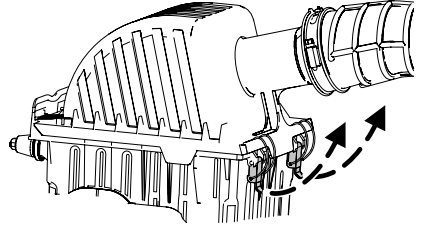

4. Remove the air filter element from the air filter housing.
5. Wipe the air filter housing and cover clean to remove any dirt or debris and to ensure good sealing.
6. Install a new air filter element.
Be careful not to crimp the filter element edges between the air filter housing and cover. This could cause filter damage and allow unfiltered air to enter the engine if not properly seated.

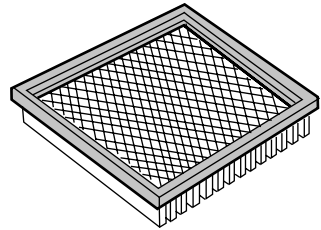

7. Replace the air filter housing cover and secure the clamps.
8. Replace the air inlet tube and secure the clamp.

Note: Failure to use the correct air filter element may result in severe engine damage. The customer warranty may be void for any damage to the engine if the correct air filter element is not used.

Maintenance and Specifications

MAINTENANCE PRODUCT SPECIFICATIONS AND CAPACITIES

Item	Application	Mazda part name or equivalent	Capacity
Brake fluid and clutch fluid (if equipped)	All	High Performance DOT 3 Motor Vehicle Brake Fluid	Between MIN and MAX on reservoir ¹
Door weather strips	All	Silicone Lubricant	—
Hinges, door checks, latches, striker plates, fuel filler door hinge and seat tracks	All	Multi-Purpose Grease	—
Transmission /steering/parking brake linkages and pivots, brake and clutch pedal shaft, clutch pilot bearing and input shaft spline (manual transmission)	All	Premium Long-Life Grease	—

Maintenance and Specifications

Item	Application	Mazda part name or equivalent	Capacity
Engine coolant	2.3 L I4 engine with manual transmission	Premium Engine Coolant ²	10.5 quarts (10.0L)
	2.3L I4 engine with automatic transmission		10.2 quarts (9.7L)
	3.0L V6 engine with manual transmission		15.1 quarts (14.3L)
	3.0L V6 engine with automatic transmission		14.8 quarts (14.0L)
	4.0L V6 engine with manual transmission		13.7 quarts (13.0L)
	4.0L V6 engine with automatic transmission		13.2 quarts (12.5L)
Engine oil	2.3L I4 engine	SAE 5W-20 Motor Oil	4.0 quarts (3.8L)
	3.0L V6 engine		4.5 quarts (4.3L)
	4.0L V6 engine		5.0 quarts (4.7L)
Power steering fluid	All	MERCON® V ATF	Fill between MAX / MIN line on reservoir

Maintenance and Specifications

Item	Application	Mazda part name or equivalent	Capacity
Transfer case fluid (4X4)	4x4 Vehicles	Transfer Case Fluid	1.25 quarts (1.2L)
Manual transmission fluid	5-speed manual	MERCON® V ATF	2.8 quarts (2.65L) ³
Automatic transmission fluid (5R44E and 5R55E)	4x2 vehicles with 2.3L I4 engine	MERCON® V ATF ⁴	9.9 quarts (9.4L) ⁵
	4x2 vehicles with 3.0L or 4.0L engines		10.0 quarts (9.5L) ⁵
	4x4 vehicles with 3.0L or 4.0L engines		10.3 quarts (9.8L) ⁵
Front axle fluid (4X4)	4x4 Vehicles	SAE 80W-90 Premium Rear Axle Lubricant	3.6 pints (1.7L)
Rear axle fluid	All	SAE 80W-90 Premium Rear Axle Lubricant	5.0-5.3 pints (2.4-2.5L) ⁶
Windshield washer fluid	All	Ultra-clear Windshield Washer Concentrate	2.75 quarts (2.6L)

Item	Application	Mazda part name or equivalent	Capacity
Fuel tank	Regular cab (Short wheel base)	—	17 gallons (64.4L)
	Cab Plus 4	—	19.5 gallons (73.8L)

¹Brake fluid will drop slowly as the brakes wear and will rise when brake components are replaced. Fluid levels below the MAX line that do not trigger the brake warning light are within the normal operating range, there is no need to add fluid. If the levels are outside the normal operating range, the performance of your brake system could be compromised, seek service from your authorized dealer immediately.

²Add the coolant type originally equipped in your vehicle. Do not mix different colors or types of coolant. Do not use Mazda Extended Life Engine Coolant (orange in color). Refer to *Adding engine coolant, in this chapter*.

³Service refill capacity is determined by filling the transmission to the bottom of the filler hole with the vehicle on a level surface.

⁴Automatic transmissions that require MERCON® V should only use MERCON® V fluid or fluid that is specified dual usage MERCON®/MERCON® V. Refer to *scheduled maintenance* to determine the correct service interval. Use of any fluid other than the recommended fluid may cause transmission damage.

⁵Indicates only approximate dry-fill capacity. Some applications may vary based on cooler size and if equipped with an in-tank cooler. The amount of transmission fluid and fluid level should be set by the indication on the dipstick's normal operating range.

⁶Traction-Lok axles use 4.75–5.0 pints (2.2–2.4L) of rear axle lubricant. Add 4 oz. (118 ml) of Additive Friction Modifier meeting Mazda specifications for complete refill of Traction-Lok axles. Service refill capacities are determined by filling the rear axle 1/4 inch to 9/16 inch (6 mm to 14 mm) below the bottom of the filler hole.

If submerged in water, the rear axle lubricant should be changed.

Maintenance and Specifications

ENGINE SPECIFICATIONS

Engine	2.3L I4 engine	3.0L V6 engine	4.0L V6 engine
Cubic inches	138	182	245
Required fuel	87 octane	87 octane	87 octane
Firing order	1-3-4-2	1-4-2-5-3-6	1-4-2-5-3-6
Spark plug gap	0.049–0.053 inch (1.25–1.35mm)	0.051–0.057 inch (1.29–1.45mm)	0.052–0.056 inch (1.32–1.42mm)
Ignition system	EDIS	EDIS	EDIS
Compression ratio	9.7:1	9.6:1	9.7:1

Engine drivebelt routing

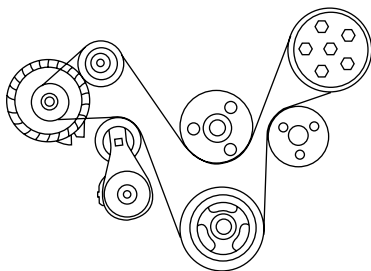

- 2.3L I4 Engine without A/C (with A/C similar)

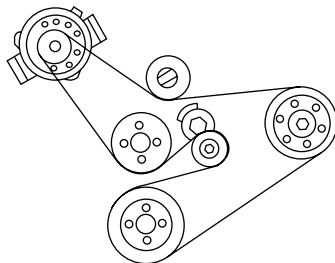

- 3.0L V6 Engine without A/C

Maintenance and Specifications

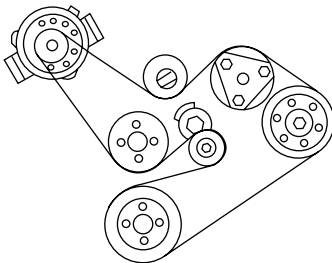

- 3.0L V6 Engine with A/C

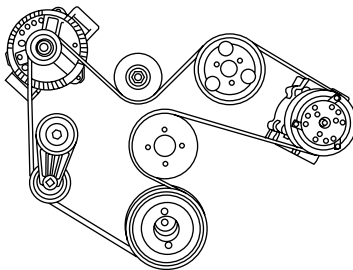

- 4.0L V6 Engine

Maintenance and Specifications

IDENTIFYING YOUR VEHICLE

Safety Compliance Certification Label

The National Highway Traffic Safety Administration Regulations require that a Safety Compliance Certification Label be affixed to a vehicle and prescribe where the Safety Compliance Certification Label may be located. The Safety Compliance Certification Label is located on the structure (B-Pillar) by the trailing edge of the driver's door or the edge of the driver's door.

MF.D. BY FORD MOTOR CO. IN U.S.A.			
FOR MAZDA MOTOR CORPORATION			
DATE: XX/XX	FRONT GAWR: XXXXL		REAR GAWR: XXXXLB
GAWR: XXXXXLB/ XXXXXKG			
XXXXKG	WITH	XXXXKG	WITH
XXXX/XXXXXXXX	TIRES	XXXX/XXXXXXXX	TIRES
XXXX.XX	RIMS	XXXX.XX	RIMS
AT XXX kPa/XX	PSI COLD	AT XXX kPa/XX	PSI COLD
THIS VEHICLE CONFORMS TO ALL APPLICABLE FEDERAL MOTOR VEHICLE SAFETY AND THEFT PREVENTION STANDARDS IN EFFECT ON THE DATE OF MANUFACTURE SHOWN ABOVE.			
VIN: XXXXXXXXXXXXXXXXXXXX			XXXXX
TYPE: XXX			XXXXX
			
EXT PNT: XX	RC: XX	DSO:	
WB ¹ BRK ¹	INT TR ¹	TP/PS ¹	TR ¹ AXLE ¹
TR ¹ SPR ¹	TR ¹ SPR ¹	TR ¹ SPR ¹	TR ¹ SPR ¹
XXX X	XX	X	XX X XX XXX
XXXXXXXXXXXXXXXX XXX XXXX-XXXXXXXX-XX			

Vehicle identification number (VIN)

The vehicle identification number is located on the driver side instrument panel.

Please note that in the graphic, XXXX is representative of your vehicle identification number.

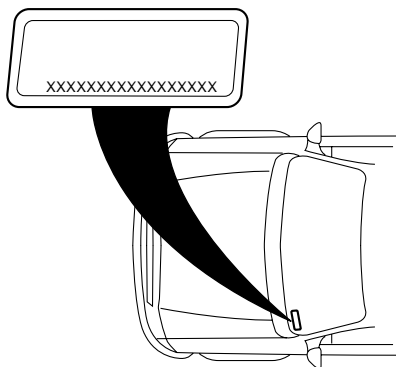

Maintenance and Specifications

The Vehicle Identification Number (VIN) contains the following information:

1. World manufacturer identifier
2. Brake system / Gross Vehicle Weight Rating (GVWR) / Restraint System
3. Vehicle line, series, body type
4. Engine type
5. Check digit
6. Model year
7. Assembly plant
8. Production sequence number

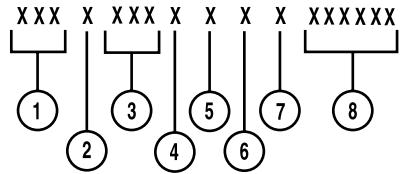

TRANSMISSION/TRANSAXLE CODE DESIGNATIONS

You can find a transmission/transaxle code on the Safety Compliance Certification Label. The following table tells you which transmission or transaxle each code represents.

MFD. BY FORD MOTOR CO. IN U.S.A.
FOR MAZDA MOTOR CORPORATION

DATE: XX/XX GVWR: XXXXXLB/XXXXXXKG

FRONT GAWR: XXXXL WITH XXXXKG WITH XXXXLB

XXXXXXG WITH TIRES XXXXKG WITH TIRES

XXXXXX/XXXXXX RIMS XXXX/XXXXXX RIMS

XXXX.XX RIMS XXXX.XX RIMS

AT XXX kPa/XX PSI COLD AT XXX kPa/XX PSI COLD

THIS VEHICLE CONFORMS TO ALL APPLICABLE FEDERAL MOTOR VEHICLE SAFETY AND THEFT PREVENTION STANDARDS IN EFFECT ON THE DATE OF MANUFACTURE SHOWN ABOVE.

VIN: XXXXXXXXXXXXXXXXXXXX XXXXX

TYPE: XXX XXXXX



EXT PNT: XX RC: XX DSO: XXXXX

WB¹ BRK² INT TR³ T/PIPS⁴ R⁵ AXLE⁶ TR⁷ SPR⁸ XXXXX

XXX X XX X XX X XX XXX

XXXXXXXXXXXXX XXX XXXX-XXXXXXX-XX

Description	Code
Five-speed automatic (5R44E/5R55E)	D
Five-speed manual (HD)	J
Five-speed manual (R1)	R

Accessories

CELL PHONES

Use of cell phones and other devices by driver:

WARNING: Use of any electrical devices such as cell phones, computers, portable radios, vehicle navigation or other devices by the driver while the vehicle is moving is dangerous. Dialing a number on a cell phone while driving also ties-up the driver's hands. Use of these devices will cause the driver to be distracted and could lead to a serious accident. If a passenger is unable to use the device, pull off the right-of-way to a safe area before use. If use of a cell phone is necessary despite this warning, use a hands-free system to at least allow the hands free to drive the vehicle. Never use a cell phone or other electrical device while the vehicle is moving and, instead, concentrate on the full-time job of driving.

In addition, the gasoline distributors are warning against using cell phones during refueling procedures, due to their increased concern about static electricity fires in the self-service pump environment.

A

ABS (see Brakes)	151
Air cleaner filter	258, 260
Airbag supplemental restraint system	86
and child safety seats	89
description	86
disposal	91
driver airbag	86, 89
indicator light	90
operation	86, 89
passenger airbag	86, 89
Ambulance packages	7
Antifreeze (see Engine coolant)	235
Anti-lock brake system (see Brakes)	151–152
Anti-theft system	66
Audio system (see Radio)	19, 21, 26
Automatic transmission	156
driving an automatic overdrive	157
fluid, specification	260
Auxiliary input jack (Line in)	32
Auxiliary power point	54
Axle lubricant specifications	260
traction lok	155

B

Battery	233
acid, treating emergencies	233
jumping a disabled battery	189
maintenance-free	233
servicing	233

Belt-Minder®	82
Booster seats	96
Brakes	151
anti-lock	151–152
anti-lock brake system (ABS) warning light	153
fluid, checking and adding	254
fluid, specifications	260
lubricant specifications	260
parking	153
shift interlock	156
Break-in period	5
Bulbs	46

C

Cargo cage	60
Cell phone warning	268
Changing a tire	179
Child safety restraints	95
child seat belts	95
Child safety seats	99
attaching with tether straps ..	102
in front seat	100
in rear seat	100
tether anchorage hardware ...	102
Child safety seats - booster seats	96
Chimes (warning)	17
Cleaning your vehicle engine compartment	208
instrument panel	211
interior	211
Mazda car care products	212
plastic parts	210
washing	207
waxing	207
wheels	208

Index

- wiper blades210
- Clock adjust
 - AM/FM Stereo20
 - AM/FM stereo CD21
 - Premium AM/FM stereo
 - CD6/MP327
- Clutch
 - fluid254
 - operation while driving159
 - recommended shift speeds ...160
- Console54
- Coolant
 - checking and adding235
 - refill capacities240
 - specifications260
- Cruise control
(see Speed control)57
- Customer Assistance196–197, 199
- D**
- Daytime running lamps
(see Lamps)43
- Dipstick
 - engine oil227
- Driveline universal joint and
slip yoke258
- Driving under special
conditions161, 164, 166
 - mud165
 - sand165
 - snow and ice167
 - through water165, 167
- E**
- Emergencies, roadside
 - jump-starting189
- Emergency Flashers168
- Emission control system249
- Engine264
 - cleaning208
 - coolant235
 - idle speed control233
 - lubrication specifications260
 - service points223–225
 - starting after a collision168
- Engine block heater150
- Engine oil227
 - checking and adding227
 - dipstick227
 - filter, specifications231
 - recommendations231
 - specifications260
- Event data recording6
- Exhaust fumes149
- F**
- Foglamps42
- Four-Wheel Drive vehicles161
 - driving off road163
 - electronic shift162
 - indicator light162
 - preparing to drive your
vehicle155
- Fuel241
 - calculating fuel economy246
 - cap243
 - choosing the right fuel244
 - comparisons with EPA fuel
economy estimates249
 - detergent in fuel244
 - filling your vehicle
 - with fuel241, 243, 246
 - filter, specifications241
 - fuel pump shut-off switch168
 - improving fuel economy246

- octane rating245, 264
- quality245
- running out of fuel245
- safety information relating to
automotive fuels241
- Fuel pump shut-off switch168
- Fuses169–170
- G**
- Gas cap (see Fuel cap)243
- Gas mileage
(see Fuel economy)246
- Gauges17
- H**
- Hazard flashers168
- Headlamps42
 - aiming44
 - bulb specifications46
 - daytime running lights43
 - flash to pass43
 - high beam42
 - replacing bulbs47
 - turning on and off42
- Heating
 - heating and air conditioning
system39–40
- Hood222
- I**
- Ignition146, 264
- Infant seats (see Safety seats) ..99
- Inspection/maintenance (I/M)
testing251
- Instrument panel
 - cleaning211
- cluster12
- lighting up panel and
interior43
- location of components12
- J**
- Jack179
 - positioning179
 - storage179, 182
- Jump-starting your vehicle189
- K**
- Keys62, 67
 - positions of the ignition146
- L**
- Lamps
 - bulb replacement
specifications chart46
 - daytime running light43
 - fog lamps42
 - headlamps42
 - headlamps, flash to pass43
 - instrument panel, dimming43
 - interior lamps46–47
 - replacing bulbs47
- Lane change indicator
(see Turn signal)46
- Lights, warning and indicator12
 - anti-lock brakes (ABS)153
- Load limits129
- Loading instructions135
- Locks
 - doors62
- Lubricant specifications260
- Lug nuts187
- M**
- Manual transmission159

Index

- lubricant specifications260
- reverse160
- Mirrors56
 - fold away57
 - side view mirrors (power)56-57
- Motorcraft parts241
- O**
- Octane rating245
- Oil (see Engine oil)227
- Overdrive59-60
- Overheating188
- P**
- Parking brake153
- Passenger Occupant Classification Sensor73
- Power distribution box (see Fuses)173
- Power door locks62
- Power mirrors56-57
- Power point54
- Power steering154
 - fluid, checking and adding252
 - fluid, specifications260
- Power Windows55
- Preparing to drive your vehicle155
- R**
- Radio19, 21, 26
- Relays169
- Remote entry system63
- illuminated entry65
- locking/unlocking doors63
- panic alarm63
- replacing the batteries64
- S**
- Safety defects, reporting206
- Safety restraints71, 75-79
 - Belt-Minder®82
 - extension assembly80
 - for adults76-79
 - for children94-95
 - Occupant Classification Sensor73
 - seat belt maintenance80
 - warning light and chime81
- Safety restraints - tether anchors102
- Safety seats for children99
- Safety Compliance Certification Label266
- Satellite Radio Information35
- Scheduled Maintenance213
- Seat Belt Maintenance80
- Seat belts (see Safety restraints)71, 75-79
- Seats69
 - child safety seats99
- SecuriLock passive anti-theft system66
- Servicing your vehicle221
- Setting the clock
 - AM/FM stereo20
 - AM/FM stereo CD21
 - Premium AM/FM stereo CD6/MP327
- Snowplowing7

- Spark plugs, specifications264
- Special notice
 ambulance conversions7
 utility-type vehicles7
- Specification chart,
 lubricants260
- Speed control57
- Starting your
 vehicle146–147, 149
 jump starting189
- Steering wheel
 tilting54
- T**
- Tether anchors102
- Tilt steering wheel54
- Tire Pressure Monitoring
 System (TPMS)
 Roadside Emergencies179
 Tires, Wheels and Loading124
- Tires108–109, 179
 alignment117
 care113
 changing179, 184
 checking the pressure113
 inflating110
 label123
 replacing114
 rotating117
 safety practices116
 sidewall information119
 snow tires and chains129
 spare tire180
 terminology110
 tire grades109
 treadwear109, 113
- Towing135
 recreational towing144
 trailer towing135
 wrecker195
- Traction-lok rear axle155
- Transfer case
 fluid checking257
- Transmission
 automatic operation156
 brake-shift interlock (BSI)156
 fluid, checking and adding
 (manual)256
 lubricant specifications260
 manual operation159
- Turn signal46
- V**
- Vehicle Identification Number
 (VIN)266
- Vehicle loading129
 camper bodies145
- Ventilating your vehicle149
- W**
- Warning chimes17
- Warning lights (see Lights)12
- Washer fluid226
- Water, Driving through167
- Windows
 power55
- Windshield washer fluid and
 wipers53
 checking and adding fluid226
 checking and cleaning226
 replacing wiper blades227
- Wrecker towing195

Free Manuals Download Website

<http://myh66.com>

<http://usermanuals.us>

<http://www.somanuals.com>

<http://www.4manuals.cc>

<http://www.manual-lib.com>

<http://www.404manual.com>

<http://www.luxmanual.com>

<http://aubethermostatmanual.com>

Golf course search by state

<http://golfingnear.com>

Email search by domain

<http://emailbydomain.com>

Auto manuals search

<http://auto.somanuals.com>

TV manuals search

<http://tv.somanuals.com>