

Table of Contents

Introduction	4
Instrument Cluster	20
Warning lights and chimes	20
Gauges	25
Entertainment Systems	27
AM/FM stereo with CD/MP3	27
Auxiliary input jack (Line in)	35
USB port	37
Satellite radio information	40
Navigation system	43
Climate Controls	44
Dual automatic temperature control	44
Rear window defroster	48
Lights	49
Headlamps	49
Turn signal control	53
Bulb replacement	55
Driver Controls	61
Windshield wiper/washer control	61
Steering wheel adjustment	62
Power windows	68
Mirrors	69
Cruise control	71
Moon roof	75
Message center	77
Locks and Security	90
Keys	90
Locks	92
Anti-theft system	100

Table of Contents

Seating and Safety Restraints	105
Seating	105
Safety restraints	116
Airbags	130
Child restraints	145
Tires, Wheels and Loading	163
Tire information	165
Tire inflation	168
Tire Pressure Monitoring System (TPMS)	181
Vehicle loading	186
Trailer towing	193
Recreational towing	193
Driving	194
Starting	194
Brakes	199
Electronic stability control	202
Transmission operation	208
Roadside Emergencies	218
Hazard flasher switch	218
Fuel pump/High voltage shut-off switches	218
Fuses and relays	220
Changing tires	228
Wheel lug nut torque	240
Jump starting	241
Wrecker towing	246
Customer Assistance	248
Reporting safety defects (U.S. only)	258
Reporting safety defects (Canada only)	258
Cleaning	259

Table of Contents

Maintenance and Specifications	265
Engine compartment	268
Engine oil	271
Battery	274
Engine Coolant and Motor/Electronics Coolant	277
Fuel information	282
Air filter(s)	297
Maintenance product specifications and capacities	299
Engine data	300
Accessories	303
Service Maintenance Section	304
Normal scheduled maintenance and log	309
Special operating conditions and log	314
Index	320

All rights reserved. Reproduction by any means, electronic or mechanical including photocopying, recording or by any information storage and retrieval system or translation in whole or part is not permitted without written authorization from MNAO. MNAO may change the contents without notice and without incurring obligation.

Copyright © 2008 MNAO

Introduction

CONGRATULATIONS

Congratulations on acquiring your new Mazda Tribute Hybrid. Please take the time to get well acquainted with your vehicle by reading this handbook. The more you know and understand about your vehicle, the greater the safety and pleasure you will derive from driving it.

For more information on Mazda Motor Corporation and its products visit the following website:

- In the United States: www.mazdausa.com
- In Canada: www.mazda.ca

Additional owner information is given in separate publications or refer to the *Mazda Importers/Distributors* section in the *Customer Assistance* chapter.

This *Owner's Manual* describes every option and model variant available and therefore some of the items covered may not apply to your particular vehicle. Furthermore, due to printing cycles it may describe options before they are generally available.

Remember to pass on this *Owner's Manual* when reselling the vehicle. It is an integral part of the vehicle.



WARNING: Fuel pump and high voltage battery shut-off switches: In the event of an accident the fuel pump shut-off switch may automatically cut off the fuel supply to the engine and the high voltage shut-off switch cuts off power from the high voltage battery. These switches can also be activated through sudden vibration (e.g. collision when parking). For information on resetting the fuel pump shut-off switch and the high voltage battery shutoff switch, refer to the ***Fuel pump/high voltage shut-off switches in the Roadside Emergencies*** chapter.

SAFETY AND ENVIRONMENT PROTECTION



Warning symbols in this guide

How can you reduce the risk of personal injury to yourself or others? In this guide, answers to such questions are contained in comments highlighted by the warning triangle symbol. These comments should be read and observed.

Introduction

Warning symbols on your vehicle

When you see this symbol, it is imperative that you consult the relevant section of this guide before touching or attempting adjustment of any kind.



Protecting the environment

We must all play our part in protecting the environment. Correct vehicle usage and the authorized disposal of waste, cleaning and lubrication materials are significant steps towards this aim. Information in this respect is highlighted in this guide with the tree symbol.



CALIFORNIA Proposition 65 Warning



WARNING: Engine exhaust, some of its constituents, and certain vehicle components contain or emit chemicals known to the State of California to cause cancer and birth defects or other reproductive harm. In addition, certain fluids contained in vehicles and certain products of component wear contain or emit chemicals known to the State of California to cause cancer and birth defects or other reproductive harm.

PERCHLORATE MATERIAL

Certain components of this vehicle such as airbag modules, seat belt pretensioners, and button cell batteries may contain Perchlorate Material – Special handling may apply for service or vehicle end of life disposal. See www.dtsc.ca.gov/hazardouswaste/perchlorate.

BREAKING-IN YOUR VEHICLE

Your vehicle does not need an extensive break-in. Try not to drive continuously at the same speed for the first 1,000 miles (1,600 km) of new vehicle operation. Vary your speed frequently in order to give the moving parts a chance to break in.

Drive your new vehicle at least 1,000 miles (1,600 km) before towing a trailer. For more detailed information about towing a trailer, refer to *Trailer towing* in the *Tires, Wheels and Loading* chapter.

Introduction

Do not add friction modifier compounds or special break-in oils since these additives may prevent piston ring seating. See *Engine oil* in the *Maintenance and Specifications* chapter for more information on oil usage.

HYBRID OPERATION

The Hybrid is a whole new kind of SUV that combines electric and gasoline propulsion without compromise, to provide breakthrough performance and efficiency. It requires no special fuels and never has to be plugged in. Familiarizing yourself with these unique characteristics will help ensure optimal performance from your new vehicle.

Normal vehicle operation

Starting: Turn the ignition key to the START position while your vehicle is in Park (P). The gas engine will turn on, **accompanied by the green “ready indicator” light**. Your engine may shut off shortly after starting, depending on temperature and battery charge level. This is a natural part of your Hybrid’s fuel-saving features. The “ready indicator” light will stay on, and you do not need to restart the vehicle.

Note: You may notice higher engine speeds upon start-up. This temporary condition is normal and necessary to heat up the cabin for occupant comfort.

Driving: The gas engine automatically starts and stops to provide power when it’s needed and to save fuel when it’s not. While coasting at low speeds, coming to a stop, or standing, the gas engine normally shuts down and the vehicle operates in electric-only mode. Conditions that may cause the engine to start up or remain running include:

- Driving request for moderate to rapid acceleration
- Vehicle speed above 40 mph (65 kph)
- Ascending a hill
- ECON mode not selected (while Climate Control is ON)
- Selection of climate control defrost mode or defrost/floor mode
- Charge level of high voltage battery is low
- Very high or low outside temperature (to provide system cooling/heating)

Stopping: The gas engine may shut off to conserve fuel as you come to a stop. Restarting the vehicle is not required. Simply step on the accelerator when you are ready to drive.

Introduction

Transmission Operation: Due to the technologically advanced, electronically controlled Continuously Variable Transaxle (eCVT) you will not feel shift changes like those of a non-hybrid vehicle. Your Hybrid's transmission is designed to do its work seamlessly.

Since your engine speed is controlled by the transmission, it may seem elevated at times. This is normal hybrid operation and helps deliver fuel efficiency and performance.

Neutral: It is not recommended to idle the vehicle in (N) Neutral for extended periods of time because this will discharge your high voltage battery and decrease fuel economy. Also, the engine cannot provide power to the hybrid system in (N) Neutral.

Low Gear: Low gear (L) is designed to mimic the enhanced engine braking available in non-hybrid vehicles. On long downhill grades, (L) Low gear may produce high engine speeds to provide necessary engine braking. This is normal and will not damage your vehicle. Response during acceleration should be the same as in the (D) Drive position.

Reverse: (R) Reverse Gear vehicle speed is limited to 22 mph (35 km/h).

Unique Hybrid operating characteristics

Your Hybrid, with its new technology, behaves differently compared to a non-hybrid. Here is a description of the major differences:

Battery: Your Hybrid is equipped with a high voltage battery cooling system in the rear of the vehicle. A cool battery ensures battery life and provides the best possible performance. Your hybrid high voltage battery may periodically re-condition itself to ensure maximum efficiency. You may notice slight changes in drivability during this process, but it's an important part of your Hybrid's high voltage battery optimization features.

You may hear a series of clicks from the cargo area when you first turn the key in the ignition. This sound is the high voltage contactors closing to allow you to start your hybrid.

In addition, you may hear fan noise and a slight tapping sound from the rear as the vent door operates. This fan may continue to operate for short durations after the vehicle has been turned off. These noises are a customary part of hybrid operation and do not require service.

If the vehicle is left inoperative for over 31 days, it may be necessary to jumpstart the vehicle. For more information, refer to *Jump starting your (Low voltage [underhood] battery only)* in the *Roadside Emergencies* chapter.

Introduction

Engine: The engine speed in your hybrid is not directly tied to your vehicle speed. Your vehicle's engine and transmission are designed to deliver the power you need at the most efficient engine speed. During heavy accelerations, your hybrid may reach high engine speeds (up to 6000 RPM). This is characteristic of the Atkinson cycle engine technology helping to maximize your hybrid's fuel economy.

In prolonged mountainous driving, you may see the engine tachometer changing without your input. This is intentional and maintains the battery charge level. You may also notice during extended downhill driving that your engine continues to run instead of shutting off.

During this "engine braking", the engine stays on, but it's not using any fuel. You may also hear a slight whine or whistle when operating your vehicle. This is the normal operation of the electric generator in the hybrid system.

During certain events (such as vehicle servicing) your low voltage (underhood) battery may become disconnected or disabled. When this occurs, and after reconnecting the low voltage (underhood) battery and driving the vehicle, the engine may continue to operate for 3-5 seconds after the key is turned to the 1 (LOCK) position. This is a normal condition, as the vehicle's computers are relearning the operating characteristics of your particular engine in order to operate it at maximum efficiency.

Braking: Your hybrid is equipped with standard hydraulic braking and regenerative braking. Regenerative braking is performed by your transmission and it captures brake energy and stores it in your high voltage battery.

Driving to optimize fuel economy

Your fuel economy should improve throughout your hybrid's break-in period. As with any vehicle, fuel economy can be significantly impacted by your driving habits and accessory usage. For best results, keep in mind these tips:

Tire Inflation: Keep tires properly inflated and only use recommended size.

Climate Control: Your hybrid is equipped with an "ECON" button that offers a more fuel efficient operation of your automatic temperature control system.

When activated, the "ECON" feature may allow the engine to shut down at low speeds or when your vehicle is stopped.

If cooler temperature is desired, the "ECON" button can be turned off, for better interior cooling but lower fuel economy.

Introduction

The “ECON” mode turns itself off when you select defrost or defrost/floor mode, although on cold days, you may still experience engine shut-down while in defrost or defrost/floor mode.

Drive Habits: Aggressive driving increases the amount of energy required to move your vehicle. In general, better fuel economy is achieved with mild to moderate acceleration and deceleration. Moderate braking is particularly important since it allows you to maximize the energy captured by the regenerative braking system.

NOTE: Having your engine running is not always an indication of inefficiency – in some cases it is actually more efficient than driving in electric mode.

Additional Tips:

- Do not carry extra loads
- Be mindful of adding external accessories that may increase aerodynamic drag
- Observe posted speed limits
- Perform all scheduled maintenance
- There is no need to wait for your engine to “warm up”. The vehicle is ready to drive immediately after starting

Introduction

Frequently asked questions

Question	Answer
What are the series of clicks from the cargo area when I first turn the key in the ignition?	The high voltage battery is electrically isolated from the rest of the vehicle when the key is OFF. When the key is turned ON, high voltage contactors inside the battery are closed to make the electricity available to the motor/generator and enable the vehicle to drive. The clicks are the sound of these contactors as they close and open during start up and shut down.
Why does the engine always start at key-on?	Your engine is started at key-on because the emission components need to be warm in order to minimize tailpipe emissions, and in cooler climates for cabin heating and windshield defrost performance.
After I start my car in the morning, why does it take a long time before the engine shuts down?	There are several reasons the engine stays on for an extended amount of time when it is first started. One common reason is to ensure that the emissions components are warm enough to minimize tailpipe emissions. As the climate gets cooler, this "engine-ON" time is extended.
Why does my engine never shut down above 40 mph (64 km/h)?	The engine is required to turn on above this speed to protect the transaxle hardware.

Introduction

Question	Answer
Why does my engine stay ON when it's extremely cold outside?	In order to ensure that the climate control system can begin heating the cabin and/or defrosting the windshield as soon as a driver requests it, the engine coolant temperature has to be kept sufficiently hot. Keeping the engine on is required to maintain the correct minimum temperature.
Why does my engine rev up so high sometimes when I accelerate?	Your vehicle's engine and transmission are designed to deliver the power you need at the most efficient engine speed. This may be higher than expected during heavy accelerations, and may fluctuate during steady state driving. These are characteristics of the Atkinson engine cycle and the eCVT transaxle technology that help maximize your hybrid's fuel economy.
What does it mean when my power assist gauge moves to the right? To the left?	Electricity is coming out of the battery when the gauge moves to the right. Electricity is going into the battery when the gauge moves to the left.
What is the fan noise and slight tapping sound I hear from the rear of my hybrid?	The fan noise comes from two fans located inside the high voltage battery. These fans turn on when the battery requires cooling air. The fan speed, and associated noise level, will change according to the amount of cooling required to maintain good performance.

Introduction

Question	Answer
How far can I go in Electric Drive if I run out of gas?	Running out of gas is not recommended. However, you may be able to go about one mile, driving at 30 mph (48 km/h), if the battery has a normal state of charge.
What is the engine oil change service interval?	The engine oil should be changed every 10,000 miles (16,000 km) under normal operating conditions. See the <i>Scheduled maintenance guide</i> chapter.
Can I put E10 or E85 in my vehicle, and how will it affect my fuel economy?	Your hybrid vehicle can use E10 (10% ethanol, 90% gasoline) fuel, but you may notice slightly reduced fuel economy because ethanol contains less energy per gallon than gasoline. Your hybrid vehicle is not designed to use E85 (85% ethanol).
How long will my high voltage battery last? Does it need maintenance?	The high voltage battery system is designed to last the life of the vehicle and requires no maintenance.
Can you charge the battery with a plug into an A/C outlet?	There are no provisions for charging the high voltage battery from a power supply external to the vehicle.

Introduction

Question	Answer
What is the purpose of the ECON button?	ECON mode may provide improved fuel economy by preventing the gasoline engine from running for the sole purpose of providing air conditioning. When the engine turns off, the A/C compressor does not operate and warm air may come out of the vents. In ECON mode, A/C operates as normal when the gasoline engine is running.
Can I tow the hybrid behind my motor home with all four wheels down?	Yes. Your hybrid vehicle can be "flat-towed" without modification. See the <i>Recreational Towing</i> section in the <i>Tires, Wheels and Loading</i> chapter for more information.

SPECIAL NOTICES

New Vehicle Limited Warranty

For a detailed description of what is covered and what is not covered by your vehicle's New Vehicle Limited Warranty, refer to the *Warranty Guide/Customer Information Guide* that is provided to you along with your *Owner's Manual*.

Special instructions

For your added safety, your vehicle is fitted with sophisticated electronic controls.



WARNING: Please read the section *Airbag Supplemental Restraint System (SRS)* in the *Seating and Safety Restraints* chapter. Failure to follow the specific warnings and instructions could result in personal injury.



WARNING: Front seat mounted rear-facing child or infant seats should NEVER be placed in front of an active passenger airbag.

Introduction

Service Data Recording

Service data recorders in your vehicle are capable of collecting and storing diagnostic information about your vehicle. This potentially includes information about the performance or status of various systems and modules in the vehicle, such as engine, throttle, steering or brake systems. In order to properly diagnose and service your vehicle, Mazda North American Operations, Mazda Canada, and service and repair facilities may access vehicle diagnostic information through a direct connection to your vehicle when diagnosing or servicing your vehicle.

Event Data Recording

Other modules in your vehicle — event data recorders — are capable of collecting and storing data during a crash or near crash event. The recorded information may assist in the investigation of such an event. The modules may record information about both the vehicle and the occupants, potentially including information such as:

- how various systems in your vehicle were operating;
- whether or not the driver and passenger seatbelts were buckled;
- how far (if at all) the driver was depressing the accelerator and/or the brake pedal;
- how fast the vehicle was traveling; and
- where the driver was positioning the steering wheel.

To access this information, special equipment must be directly connected to the recording modules. Mazda North American Operations and Mazda Canada do not access event data recorder information without obtaining consent, unless pursuant to court order or where required by law enforcement, other government authorities or other third parties acting with lawful authority. Other parties may seek to access the information independently of Mazda North American Operations and Mazda Canada.

Introduction

Notice to owners of pickup trucks and utility type vehicles



WARNING: Utility vehicles have a significantly higher rollover rate than other types of vehicles.

Before you drive your vehicle, please read this *Owner's Manual* carefully. Your vehicle is not a passenger car. As with other vehicles of this type, failure to operate this vehicle correctly may result in loss of vehicle control, vehicle rollover, personal injury or death.

Using your vehicle with a snowplow

Do not use this vehicle for snowplowing.

Your vehicle is not equipped with a snowplowing package.

Using your vehicle as an ambulance



















WARNING: Do not use this vehicle as an ambulance.

Your vehicle is not equipped with an ambulance preparation package.

Introduction

These are some of the symbols you may see on your vehicle.

Vehicle Symbol Glossary

Safety Alert		See Owner's Manual	
Protecting the Environment		Fasten Seat Belt	
Airbag - Front		Airbag - Side	
Passenger Airbag Off		Child Seat Lower Anchor	
Child Seat Tether Anchor		Brake System	
Anti-Lock Brake System		Parking Brake System	
Brake Fluid - Non-Petroleum Based		Parking Aid System	
Stability Control System		Master Lighting Switch	
Hazard Warning Flasher		Fog Lamps-Front	
Fuse Compartment		Fuel Pump Reset	
Windshield Wash/Wipe		Windshield Defrost/Demist	
Rear Window Defrost/Demist		Power Windows	

Introduction

Vehicle Symbol Glossary

Power Window Lockout		Personal Alarm System Feature	
Engine Oil		Engine Coolant	
Engine Coolant Temperature		Do Not Open When Hot	
Battery		Avoid Smoking, Flames, or Sparks	
Battery Acid		Explosive Gas	
Fan Warning		Power Steering Fluid	
Maintain Correct Fluid Level		Service Engine Soon	
Engine Air Filter		Speed Control	
Passenger Compartment Air Filter		Jack	
Check Fuel Cap		Low Tire Pressure Warning	

INFORMATION ABOUT THIS GUIDE

The information found in this guide was accurate at the time of printing. Mazda may change the contents without notice.

Instrument Cluster

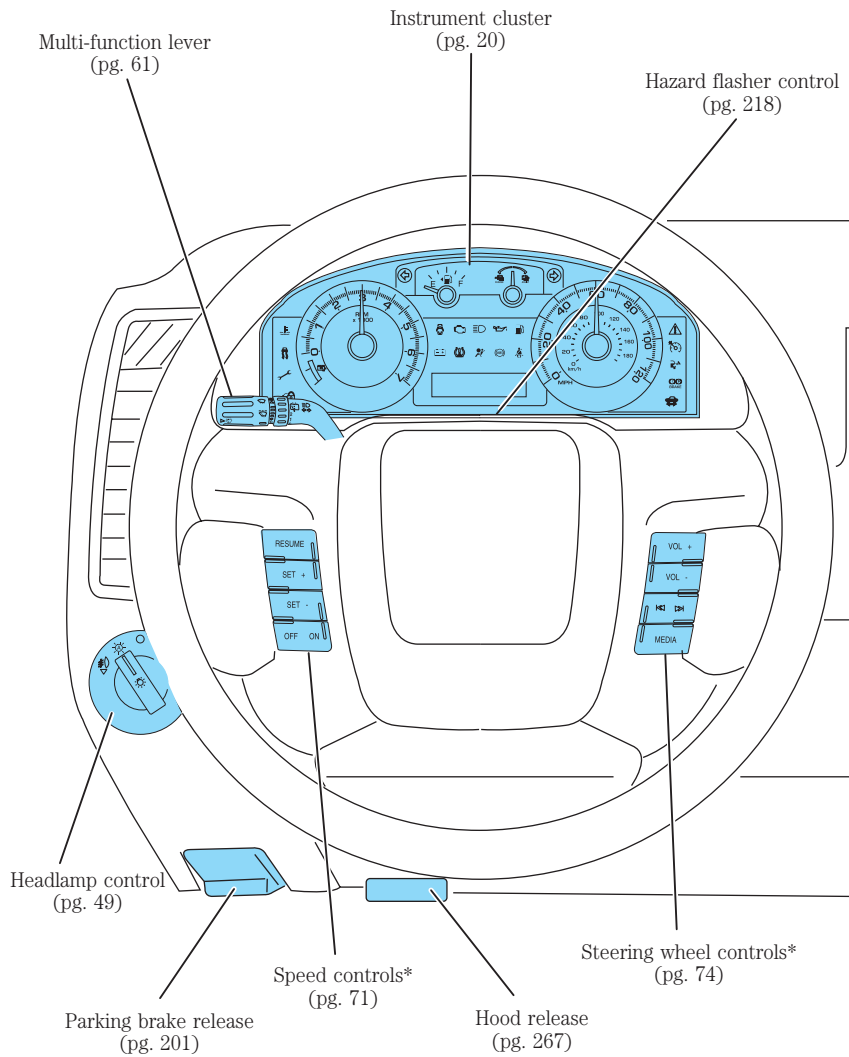

* if equipped

Instrument Cluster

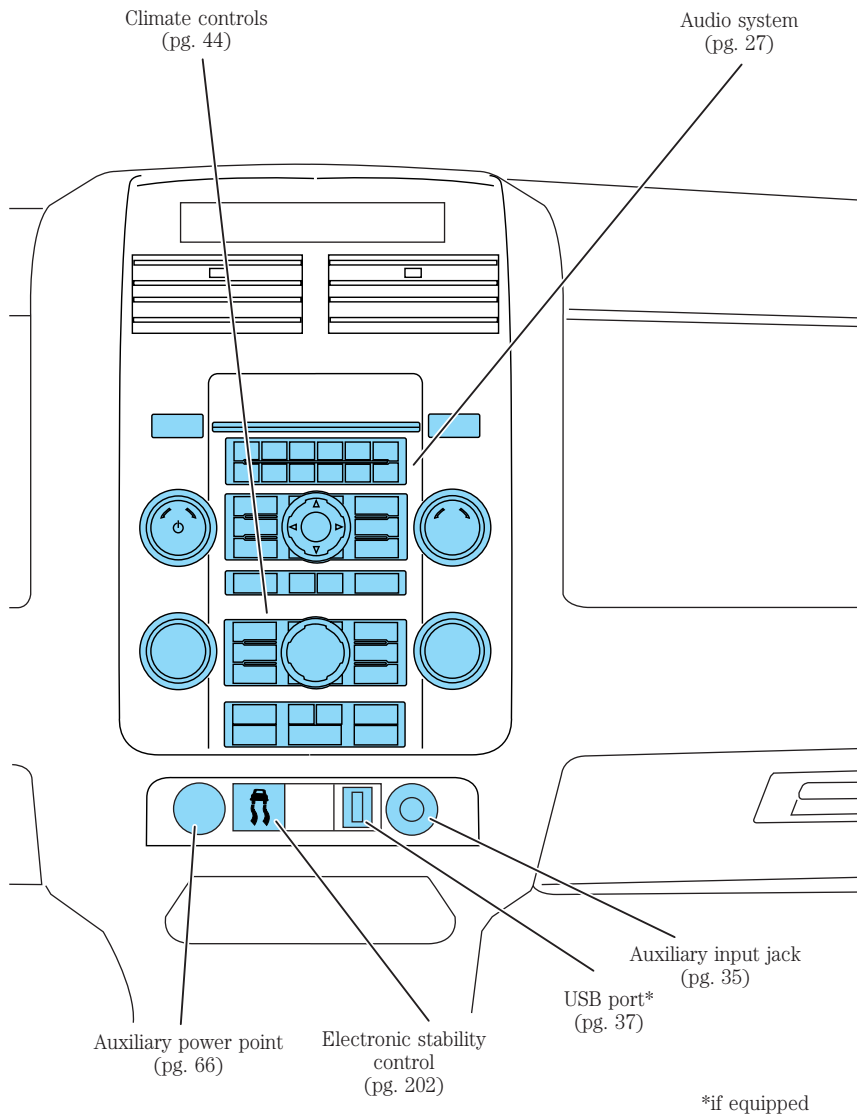

Instrument Cluster

WARNING LIGHTS AND CHIMES

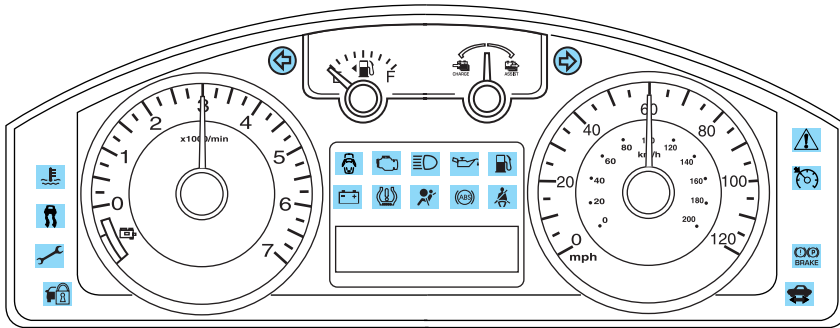

Warning lights and gauges can alert you to a safety hazard or a vehicle condition that may become serious enough to cause extensive repairs. A warning light may illuminate when a problem exists with one of your vehicle's functions. Many lights will illuminate when you start your vehicle to make sure the bulbs work. If any light remains on after starting the vehicle, refer to the respective system warning light for additional information.

Service engine soon: The *Service engine soon* indicator light illuminates when the ignition is first turned to the on position to check

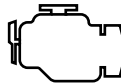

the bulb and to indicate whether the vehicle is ready for Inspection/Maintenance (I/M) testing. Normally, the "Service engine soon" light will stay on until the engine is cranked, then turn itself off if no malfunctions are present. However, if after 15 seconds the "Service engine soon" light blinks eight times, it means that the vehicle is not ready for I/M testing. See the *Readiness for Inspection/Maintenance (I/M) testing* in the *Maintenance and Specifications* chapter.

Solid illumination after the engine is started indicates the On Board Diagnostics System (OBD-II) has detected a malfunction. Refer to *On board diagnostics (OBD-II)* in the *Maintenance and Specifications* chapter. If the light is blinking, engine misfire is occurring which could damage your catalytic converter. Drive in a moderate fashion (avoid heavy acceleration and deceleration) and have your vehicle serviced immediately by your authorized dealer.

Instrument Cluster



WARNING: Under engine misfire conditions, excessive exhaust temperatures could damage the catalytic converter, the fuel system, interior floor coverings or other vehicle components, possibly causing a fire.

Brake system warning light: To confirm the brake system warning light is functional, it will

momentarily illuminate when the ignition is turned to the on position

when the engine is not running, or in a position between on and start, or by applying the parking brake when the ignition is turned to the on position. If the brake system warning light does not illuminate at this time, seek service immediately from your authorized dealer. Illumination after releasing the parking brake indicates low brake fluid level or a brake system malfunction and the brake system should be inspected immediately by your authorized dealer.



WARNING: Driving a vehicle with the brake system warning light on is dangerous. A significant decrease in braking performance may occur. It will take you longer to stop the vehicle. Have the vehicle checked by your authorized dealer. Driving extended distances with the parking brake engaged can cause brake failure and the risk of personal injury.

Anti-lock brake system: If the ABS light stays illuminated or continues to flash, a malfunction has been detected, have the system serviced immediately by your authorized dealer. Normal braking is still functional unless the brake warning light also is illuminated.

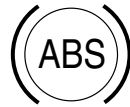

Airbag readiness: If this light fails to illuminate when the ignition is turned to on, continues to flash or remains on, have the system

serviced immediately by your authorized dealer. A chime will also sound when a malfunction in the supplemental restraint system has been detected.



Instrument Cluster

Seat belt: Reminds you to fasten your seat belt. A Belt-Minder® chime will also sound to remind you to fasten your seat belt. Refer to the *Seating and Safety Restraints* chapter to activate/deactivate the Belt-Minder® chime feature.



Master vehicle electrical hazard warning lamp: Indicates Hybrid component fault/failure that will cause the vehicle to shutdown or fail to start.



WARNING: If the vehicle is still running, the vehicle may soon shutdown without further warning and should be stopped safely.

If this lamp is lit, stop the vehicle, shift to P (Park), turn the key to the off position, and attempt to restart the vehicle. If the fault remains, the vehicle may require refueling, jump starting, resetting of the shut-off switches, or service. For information regarding *Low voltage [underhood] battery only* and *Fuel pump/High voltage shut-off switches* please refer to the *Roadside Emergencies* chapter.

Ready indicator light: Illuminates once the vehicle has successfully started. Indicates the vehicle is ready to drive even when you don't hear the engine running.

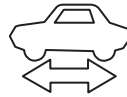

Charging system: Illuminates when the 12V charging system is not working properly.



Engine oil pressure: Illuminates when the oil pressure falls below the normal range, refer to *Engine oil* in the *Maintenance and Specifications* chapter.



Instrument Cluster

Engine or motor electronic

coolant temperature: Illuminates

when the coolant temperature

exceeds the threshold. When the light is flashing or remains on, stop the vehicle as soon as possible, switch off the engine and let cool. Refer to *Engine coolant and motor/electronics coolant* in the *Maintenance and Specifications* chapter.



WARNING: When the engine and radiator are hot, scalding coolant and steam may shoot out under pressure and cause serious injury. Do not remove the cooling system cap when the engine and radiator are hot.

AdvanceTrac®/Traction

Control™: Illuminates when the AdvanceTrac®/Traction Control™ is active. If the light remains on, have the system serviced immediately, refer to the *Driving* chapter for more information.



Low tire pressure warning:

Illuminates when your tire pressure is low. If the light remains on at start up or while driving, the tire pressure should be checked. Refer

to *Inflating your tires* in the *Tires, Wheels and Loading* chapter. When the ignition is first turned to on, the light will illuminate for three seconds to ensure the bulb is working. If the light does not turn on or begins to flash, have the system inspected by your authorized dealer. For more information on this system, refer to *Tire pressure monitoring system (TPMS)* in the *Tires, Wheels and Loading* chapter.



Low fuel: Illuminates when the fuel level in the fuel tank is at or near empty (refer to *Fuel gauge* in this chapter).



Speed control: Illuminates when the speed control is engaged. Turns off when the speed control system is disengaged.



Instrument Cluster

Anti-theft system: Flashes when the SecuriLock™ Passive Anti-theft System has been activated.



Throttle control/Powertrain: Illuminates when a powertrain fault has been detected. Contact your authorized dealer as soon as possible.



Door ajar: Illuminates when the ignition is in the on position and any door is open.



Turn signal: Illuminates when the left or right turn signal or the hazard lights are turned on. If the indicators flash faster, check for a burned out bulb.



High beams: Illuminates when the high beam headlamps are turned on.



Key-in-ignition warning chime: Sounds when the key is left in the ignition in the off or accessory position and the driver's door is opened.

Headlamps on warning chime: Sounds when the headlamps or parking lamps are on, the ignition is off (the key is not in the ignition) and the driver's door is opened.

Parking brake on chime: Sounds when the parking brake is left on and the vehicle is driven. If the warning stays on after the park brake is off, contact your authorized dealer as soon as possible.

HEV Engine off Reminder Chime: Sounds for 10 seconds when the PRNDL is in the P (Park) position and the Driver's door is ajar (open) while ignition is in the on position. Always turn your ignition key to off and remove key before leaving your vehicle. (The engine may be off when the vehicle is stopped, yet the key is on, and the engine can turn on at any time)

Message center activation chime: Sounds when a warning message (except PARKING BRAKE ENGAGED while parked) appears in the message center display for the first time.

Instrument Cluster

GAUGES

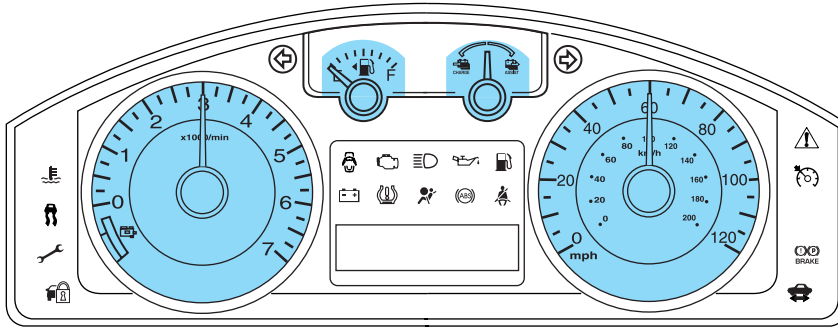

Speedometer: Indicates the current vehicle speed.

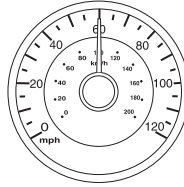

Battery gauge: Provides information about the vehicle's energy usage.

- ASSIST — Battery provides extra power to boost the vehicle's acceleration.
- CHARGE — Storing extra energy in the battery when coasting or slowing down.

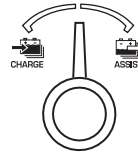

Odometer: Registers the total miles (kilometers) of the vehicle.

Refer to *Message center* in the *Driver Controls* chapter on how to switch the display from Metric to English.



Instrument Cluster

Trip odometer: Registers the miles (kilometers) of individual journeys. To reset, press and release the message center INFO button until TRIP A mode appears in the display. Press the control again to select the TRIP B feature. Press and hold the RESET button to reset.

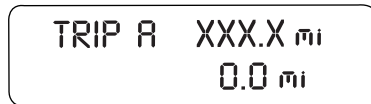

Tachometer: Indicates the engine speed in revolutions per minute. Driving with your tachometer pointer continuously at the top of the scale may damage the engine.

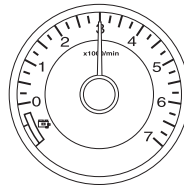

The pointer will indicate engine RPMs when the engine is running and point at the EV symbol when the engine is off and the vehicle is running on pure electrical power.

Fuel gauge: Indicates approximately how much fuel is left in the fuel tank (when the ignition is in the on position). The fuel gauge may vary slightly when the vehicle is in motion or on a grade.



Refer to *Filling the tank* in the *Maintenance and Specifications* chapter for more information.

Entertainment Systems

AUDIO SYSTEMS

AM/FM/single CD or in-dash CD6/MP3 satellite compatible sound system

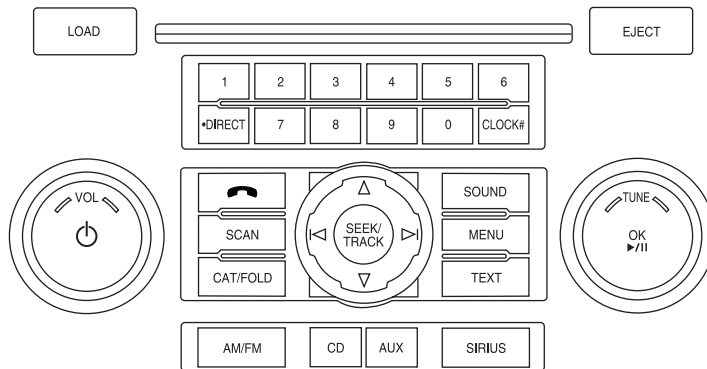

WARNING: Driving while distracted can result in loss of vehicle control, accident and injury. Mazda strongly recommends that drivers use extreme caution when using any device that may take their focus off the road. The driver's primary responsibility is the safe operation of their vehicle. Only use cell phones and other devices not essential to the driving task when it is safe to do so.

Accessory delay: Your vehicle is equipped with accessory delay. With this feature, the radio and other electrical accessories may be used for up to ten minutes after the ignition is turned off or until either front door is opened.

Note: Your vehicle is equipped with a unique audio system. If your display shows six small circles in the display, your audio system is a CD6 system. If not, your system is a Single CD system.

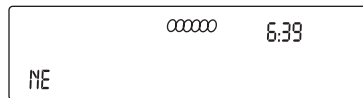

Setting the clock

To set the time, press CLOCK. The display will read SET TIME. Use the memory preset numbers (0–9) to enter in the desired time—hours and minutes. The clock will then begin from that time.

Entertainment Systems

AM/FM Radio

⏻ / VOL (Power/Volume): Press to turn the radio on/off. Turn the knob to increase/decrease volume.

If the volume is set above a certain level and the ignition is turned off, the volume will come back on at a nominal listening level when the ignition is turned back on.

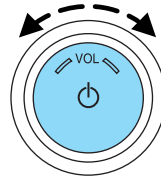

AM/FM: Press repeatedly to select AM/FM1/FM2 frequency band.

TUNE: Turn the knob to go up/down the frequency band in individual increments.

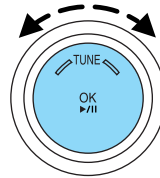

DIRECT: Press DIRECT and then select the desired radio frequency (i.e. 93.9) using the memory preset numbers (0–9).

SEEK/TRACK: Press **◀ SEEK/TRACK ▶** to access the previous/next strong radio station.



SCAN: Press for a brief sampling of all strong radio stations.

MEMORY PRESETS (0–9): When tuned to any station, press and hold a preset button until sound returns and PRESET # SAVED appears in the display. You can save up to 30 stations, 10 in AM, 10 in FM1 and FM2.

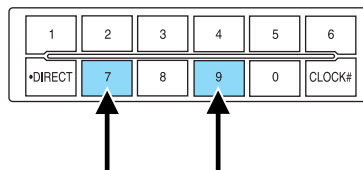

Saving presets automatically (Autoset)– Autoset allows you to set the strongest local radio stations without losing your original manually set preset stations for AM/FM1/FM2.

Entertainment Systems

To activate the autoset feature: Press MENU repeatedly until AUTO PRESET ON/OFF appears in the display. Use ◀ SEEK/TRACK ▶ to toggle AUTO PRESET to ON, and either wait five seconds for the search to initiate or press OK to immediately initiate the search. If you press another control within those five seconds, the search will not initiate; the 10 strongest stations will be filled and the station stored in preset 1 will begin playing.

If there are fewer than 10 strong stations, the system will store the last one in the remaining presets.

RDS Radio

Available only in FM mode. This feature allows you to search RDS-equipped stations for a certain category of music format: CLASSIC, COUNTRY, JAZZ/RB, ROCK, etc.

To activate: Press MENU repeatedly until RDS (ON/OFF) appears in the display. Use ◀ SEEK/TRACK ▶ to toggle RDS ON/OFF. When RDS is OFF, you will not be able to search for RDS equipped stations or view the station name or type.

CAT/FOLD(Category/Folder): This feature allows you to select from various music categories.

To change RDS categories: Press MENU repeatedly until RBDS ON/OFF appears in the display. Use ▲ / ▼ to toggle RDS to ON. Press CAT. PRESS UP OR DOWN TO CHANGE RDS CATEGORY will appear in the display. Press ▲ / ▼ to scroll through all possible categories. When the desired category appears in the display, press ◀ SEEK/TRACK ▶ to find the next station playing that selection or press SCAN for a brief sampling of all stations playing that category of music.

CD/MP3 Player

CD: Press to enter CD/MP3 mode. If a disc is already loaded into the system, CD/MP3 play will begin where it ended last. If no CD is loaded, NO DISC will appear in the display.

LOAD:

For a single CD system– This control is not operational. To load a CD, simply insert the disc, label side up, into the CD slot.

For a CD6 system– Press LOAD. When the display reads SELECT SLOT, choose the desired slot number using memory presets 1–6. When the display reads LOAD CD #, load the desired disc, label side up. If you do not choose a slot within five seconds, the system will choose for you. Once loaded, the first track will begin to play.

Entertainment Systems

To auto load up to six discs– Press and hold LOAD until the display reads AUTOLOAD #. Load the desired disc, label side up. The system will prompt you to load discs for the remaining available slots. Insert the discs, one at a time, label side up, when prompted. Once loaded, the disc in preset #1 will begin to play.

Press the number preset buttons (1–6) to choose the disc you want to play.

EJECT:

For a single CD system– press EJECT to eject the CD.

For a CD6 system– press EJECT and select the desired CD slot by pressing the corresponding memory preset number. The display will read EJECTING #. When the system has ejected the CD, the display will read REMOVE CD #. Remove the CD. If you do not remove the CD, the system will reload the disc.

To auto eject all loaded discs– Press and hold EJECT. The system will eject all discs and prompt you when to remove them.

▶ / || Play/Pause: Press to play/pause a track when playing a CD.

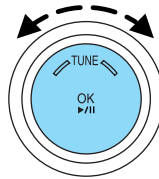

SEEK/TRACK: Press ◀ SEEK/TRACK ▶ to access the previous/next track.



CAT (Category) / FOLD (Folder):

In MP3 mode only– Press CAT/FOLD and then press ◀ SEEK/TRACK ▶ to access the previous/next folder.

SCAN: Press for a brief sampling of all tracks on the current disc or MP3 folder.

DIRECT:

In CD mode– Press DIRECT. The display will read DIRECT TRACK MODE SELECT TRACK. Enter the desired track number using the memory preset buttons (0–9). The system will then begin playing that track.

Entertainment Systems

In MP3 folder mode– Press DIRECT and the memory preset buttons (0–9) of the desired folder. The system will advance to that specific folder.

TEXT:

In MP3 mode only– Press TEXT repeatedly to view Album (AL), Folder (FL), Song (SO) and Artist (AR) in the display, if available.

In TEXT MODE– Sometimes the display requires additional text to be displayed. When the < / > indicator is active, press TEXT and then press ◀ SEEK/TRACK ▶ to view the additional display text.

COMPRESSION: Press MENU repeatedly until COMPRESSION ON/OFF appears in the display. Use ◀ SEEK/TRACK ▶ to toggle between ON/OFF. When COMPRESSION is ON, the system will bring the soft and loud CD passages together for a more consistent listening level.

SHUFFLE: Press MENU repeatedly until SHUFFLE ON/OFF appears in the display. Use ◀ SEEK/TRACK ▶ to toggle between ON/OFF. If you wish to engage shuffle mode right away, press ◀ SEEK/TRACK ▶ to begin random play. Otherwise, random play will begin when the current track is finished playing. The system will only shuffle the disc currently playing.

Satellite Radio

Satellite radio is available only with a valid SIRIUS radio subscription. Check with your authorized dealer for availability.

SIRIUS: Press to access satellite radio mode, if equipped. Press repeatedly to cycle through SAT1, SAT2 and SAT3 modes.

TUNE/OK: Turn the knob to go to the next / previous available SIRIUS satellite station.

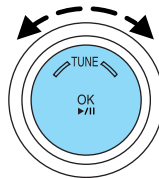

Entertainment Systems

DIRECT: Press DIRECT then enter the desired channel (i.e. 002) using the memory preset buttons (0–9). If you only enter one digit, press OK and the system will go to that satellite channel. If you enter three digits, the system will automatically go to that channel, if available. You may cancel your entry by pressing DIRECT. If an invalid station number is entered, INVALID CHANNEL will appear in the display and the system will continue playing the current station.

SEEK/TRACK: Press

◀ SEEK/TRACK ▶ to seek to the previous/next channel. If a specific category is selected, (Jazz, Rock, News, etc.), press

◀ SEEK/TRACK ▶ to seek to

the previous/next channel in the selected category. Press and hold

◀ SEEK/TRACK ▶ to fast seek through the previous/next channels.



SCAN: Press SCAN for a brief sampling of all available SIRIUS satellite channels. If a specific category is selected, (Jazz, Rock, News, etc.) press SCAN for a brief sampling of all available SIRIUS satellite channels within the selected category.

MEMORY PRESETS (0–9): There are 30 available presets, 10 each for SAT1, SAT2 and SAT3. To save satellite channels in your memory presets, tune to the desired channel then press and hold a memory preset number (0–9) until sound returns.

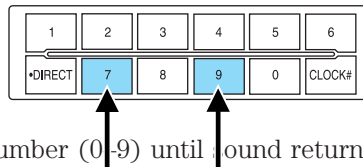

TEXT: Press and release to display the artist and song title. While in TEXT MODE, press again to scroll through the Artist (AR), Song (SO), Channel (CH) and Category (CA).

In TEXT MODE: Sometimes the display requires additional text to be displayed. When the < / > indicator is active, press TEXT and then press ◀ SEEK/TRACK ▶ to view the additional display text.

CAT (Category) / FOLD (Folder): Press to toggle between turning the most recently selected satellite radio category on or off. The category icon (CAT) will illuminate in the display when a specific category is selected (the icon will not illuminate during CATEGORY ALL). If no category has ever been selected, NO CATEGORY SELECTED will display.

Note: Separate categories can be set for SAT1, SAT2 or SAT3.

Refer to *Satellite radio menu* for further information on selecting a satellite radio category.

Entertainment Systems

SATELLITE RADIO MENU: Press MENU when satellite radio mode is active to access. Press OK to enter into the satellite radio menu.

Press ▲ / ▼ to cycle through the following options:

- **CATEGORY:** Press OK to enter category mode. Press ▲ / ▼ to scroll through the list of available SIRIUS channel Categories (Pop, Rock, News, etc.) Press OK when the desired category appears in the display. After a category is selected, press SEEK to search for that specific category of channels only (i.e. ROCK). You may also select CATEGORY ALL to seek all available SIRIUS categories and channels. Press OK to close and return to the main menu.
- **SAVE SONG:** Press OK to save the currently playing song's title in the system's memory. (If you try to save something other than a song, CANT SAVE will appear in the display.) When the chosen song is playing on any satellite radio channel, the system will alert you with an audible prompt. Press OK while SONG ALERT is in the display and the system will take you to the channel playing the desired song. You can save up to 20 song titles. If you attempt to save more than 20 titles, the display will read REPLACE SONG? Press OK to access the saved titles and press ▲ / ▼ to cycle through the saved titles. When the song title appears in the display that you would like to replace, press OK. SONG REPLACED will appear in the display.
- **DELETE SONG:** Press OK to delete a song from the system's memory. Press ▲ / ▼ to cycle through the saved songs. When the song appears in the display that you would like to delete, press OK. The song will appear in the display for confirmation. Press OK again and the display will read SONG DELETED. If you do not want to delete the currently listed song, press ▲ / ▼ to select either RETURN or CANCEL.
Note: If there are no songs presently saved, the display will read NO SONGS.
- **DELETE ALL SONGS:** Press OK to delete all song's from the system's memory. The display will read ARE YOU SURE ? Press OK to confirm deletion of all saved songs and the display will read ALL DELETED.
Note: If there are no songs presently saved, the display will read NO SONGS.
- **ENABLE ALERTS / DISABLE ALERTS:** Press OK to enable/disable the satellite alert status which alerts you when your selected songs are playing on a satellite radio channel. (The system default is disabled.)

Entertainment Systems

SONG ALERTS ENABLED/DISABLED will appear in the display. The menu listing will display the opposite state. For example, if you have chosen to enable the song alerts, the menu listing will read DISABLE as the alerts are currently on, so your other option is to turn them off.

Sound Adjustments

Press SOUND repeatedly to cycle through the following features:

BASS: Press ◀ SEEK/TRACK ▶ to adjust the level of bass.

TREBLE: Press ◀ SEEK/TRACK ▶ to adjust the level of treble.

BALANCE: Press ◀ SEEK/TRACK ▶ to adjust the audio between the left (L) and right (R) speakers.

FADE: Press ◀ SEEK/TRACK ▶ to adjust the audio between the back (B) and front (F) speakers.

SPEED COMPENSATED VOLUME (if equipped): With this feature on, radio volume automatically gets louder with increasing vehicle speed to compensate for road and wind noise.

The default setting is *off*.

Use ◀ SEEK/TRACK ▶ to adjust between SPEED OFF and levels 1–7: Increasing the level from 1 (lowest setting) to 7 (highest setting) allows the radio volume to automatically change slightly with vehicle speed to compensate for road and wind noise.

Recommended level is 1–3; SPEED OFF turns the feature off and level 7 is the maximum setting.

ALL SEATS (Occupancy mode, if equipped): Press SOUND repeatedly to reach the Occupancy mode setting. Press ◀ SEEK/TRACK ▶ to select and optimize sound for ALL SEATS, DRIVERS SEAT or REAR SEATS.

Extra Features

AUX: Press to reach LINE IN (auxiliary audio mode).

For location and further information on auxiliary audio mode, refer to *Auxiliary input jack* later in this chapter.

☞ **(Phone):** This feature is not active.

Entertainment Systems

TUNE/OK: Your vehicle may be equipped with features which will require you to confirm commands by pressing OK.

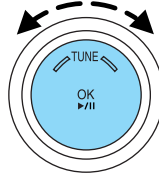

Auxiliary input jack (Line in)



WARNING: Driving while distracted can result in loss of vehicle control, accident and injury. Mazda strongly recommends that drivers use extreme caution when using any device that may take their focus off the road. The driver's primary responsibility is the safe operation of their vehicle. Only use cell phones and other devices not essential to the driving task when it is safe to do so.

Your vehicle is equipped with an Auxiliary Input Jack (AIJ). The Auxiliary Input Jack provides a way to connect your portable music player to the in-vehicle audio system. This allows the audio from a portable music player to be played through the vehicle speakers with high fidelity. To achieve optimal performance, please observe the following instructions when attaching your portable music device to the audio system. If your vehicle is equipped with a navigation system, refer to *Auxiliary input jack* section in the *Audio features* chapter of your *Navigation system* supplement.

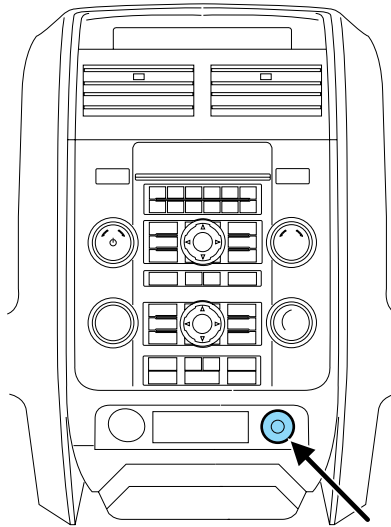

Entertainment Systems

Required equipment:

1. Any portable music player designed to be used with headphones
2. An audio extension cable with stereo male 1/8 in. (3.5 mm) connectors at each end

To play your portable music player using the auxiliary input jack:

1. Begin with the vehicle parked and the radio turned off.
2. Ensure that the battery in your portable music player is new or fully charged and that the device is turned off.
3. Attach one end of the audio extension cable to the headphone output of your player and the other end of the audio extension cable to the AIJ in your vehicle.
4. Turn the radio on, using either a tuned FM station or a CD loaded into the system. Adjust the volume to a comfortable listening level.
5. Turn the portable music player on and adjust the volume to 1/2 the volume.
6. Press AUX on the vehicle radio repeatedly until LINE, LINE IN or SYNC LINE IN appears in the display.
You should hear audio from your portable music player although it may be low.
7. Adjust the sound on your portable music player until it reaches the level of the FM station or CD by switching back and forth between the AUX and FM or CD controls.

Troubleshooting:

1. Do not connect the audio input jack to a line level output. Line level outputs are intended for connection to a home stereo and are not compatible with the AIJ. The AIJ will only work correctly with devices that have a headphone output with a volume control.
2. Do not set the portable music player's volume level higher than is necessary to match the volume of the CD or FM radio in your audio system as this will cause distortion and will reduce sound quality. Many portable music players have different output levels, so not all players should be set at the same levels. Some players will sound best at full volume and others will need to be set at a lower volume.
3. If the music sounds distorted at lower listening levels, turn the portable music player volume down. If the problems persists, replace or recharge the batteries in the portable music player.
4. The portable music player must be controlled in the same manner when it is used with headphones as the AIJ does not provide control (play, pause, etc.) over the attached portable music player.

Entertainment Systems

5. For safety reasons, connecting or adjusting the settings on your portable music player should not be attempted while the vehicle is moving. Also, the portable music player should be stored in a secure location, such as the center console or the glove box, when the vehicle is in motion. The audio extension cable must be long enough to allow the portable music player to be safely stored while the vehicle is in motion.

USB port (if equipped)

 **WARNING:** Driving while distracted can result in loss of vehicle control, accident and injury. Mazda strongly recommends that drivers use extreme caution when using any device that may take their focus off the road. The driver's primary responsibility is the safe operation of their vehicle. Only use cell phones and other devices not essential to the driving task when it is safe to do so.

Your vehicle may be equipped with a USB port located on the instrument panel. This feature allows you to plug in media playing devices, memory sticks, and also to charge devices if they support this feature. For further information on this feature, refer to *Accessing and using your USB port* in the *SYNC* supplement or *Navigation system* supplement.

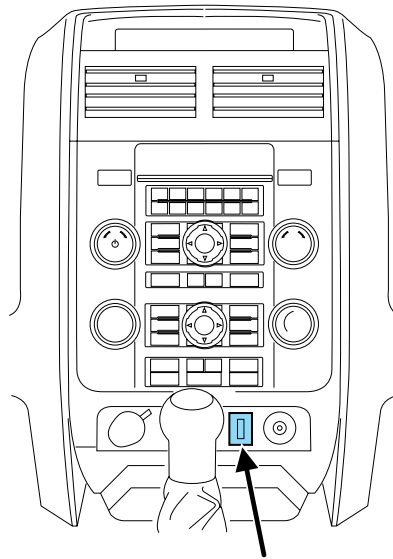

Entertainment Systems

GENERAL AUDIO INFORMATION

Radio frequencies:

AM and FM frequencies are established by the Federal Communications Commission (FCC) and the Canadian Radio and Telecommunications Commission (CRTC). Those frequencies are:

AM: 530, 540–1700, 1710 kHz

FM: 87.7, 87.9–107.7, 107.9 MHz

Radio reception factors:

There are three factors that can affect radio reception:

- Distance/strength: The further you travel from an FM station, the weaker the signal and the weaker the reception.
- Terrain: Hills, mountains, tall buildings, power lines, electric fences, traffic lights and thunderstorms can interfere with your reception.
- Station overload: When you pass a broadcast tower, a stronger signal may overtake a weaker one and play while the weak station frequency is displayed.

CD/CD player care

Do:

- Handle discs by their edges only. (Never touch the playing surface).
- Inspect discs before playing.
- Clean only with an approved CD cleaner.
- Wipe discs from the center out.



Don't:

- Expose discs to direct sunlight or heat sources for extended periods of time.
- Clean using a circular motion.

Entertainment Systems

CD units are designed to play commercially pressed 4.75 in (12 cm) audio compact discs only. Due to technical incompatibility, certain recordable and re-recordable compact discs may not function correctly when used in Mazda CD players.

Do not use any irregular shaped CDs or discs with a scratch protection film attached.

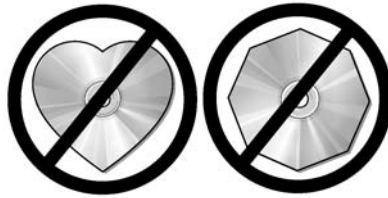

CDs with homemade paper (adhesive) labels should not be inserted into the CD player as the label may peel and cause the CD to become jammed. It is recommended that homemade CDs be identified with permanent felt tip marker rather than adhesive labels. Ballpoint pens may damage CDs. Please contact your authorized dealer for further information.

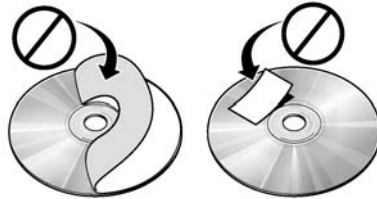

Audio system warranty and service

Refer to the *Warranty Guide/Customer Information Guide* for audio system warranty information. If service is necessary, see your authorized Mazda dealership.

MP3 track and folder structure

Your MP3 system recognizes MP3 individual tracks and folder structure as follows:

- There are two different modes for MP3 disc playback: MP3 track mode (system default) and MP3 folder mode. For more information on track and folder mode, refer to *Sample MP3 structure* in the following section.
- MP3 track mode ignores any folder structure on the MP3 disc. The player numbers each MP3 track on the disc (noted by the .mp3 file extension) from T001 to a maximum of T255.

Note: The maximum number of playable MP3 files may be less depending on the structure of the CD and exact model of radio present.

Entertainment Systems

- MP3 folder mode represents a folder structure consisting of one level of folders. The CD player numbers all MP3 tracks on the disc (noted by the .mp3 file extension) and all folders containing MP3 files, from F001 (folder) T001 (track) to F253 T255.
- Creating discs with only one level of folders will help with navigation through the disc files.

Sample MP3 structure

If you are burning your own MP3 discs, it is important to understand how the system will read the structures you create. While various files may be present, (files with extensions other than mp3), only files with the .mp3 extension will be played. Other files will be ignored by the system. This enables you to use the same MP3 disc for a variety of tasks on your work computer, home computer and your in vehicle system.

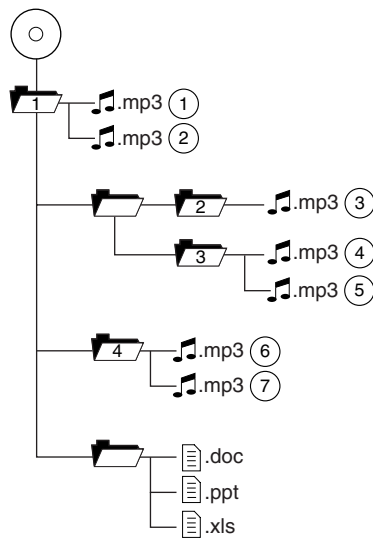

In track mode, the system will display and play the structure as if it were only one level deep (all .mp3 files will be played, regardless of being in a specific folder). In folder mode, the system will only play the .mp3 files in the current folder.

Satellite radio information

Satellite radio channels: SIRIUS broadcasts a variety of music, news, sports, weather, traffic and entertainment satellite radio channels. For more information and a complete list of SIRIUS satellite radio channels, visit www.sirius.com in the United States, www.sirius-canada.ca in Canada, or call SIRIUS at 1-888-539-7474.

Entertainment Systems

Satellite radio reception factors: To receive the satellite signal, your vehicle has been equipped with a satellite radio antenna located on the roof of your vehicle. The vehicle roof provides the best location for an unobstructed, open view of the sky, a requirement of a satellite radio system. Like AM/FM, there are several factors that can affect satellite radio reception performance:

- **Antenna obstructions:** For optimal reception performance, keep the antenna clear of snow and ice build-up and keep luggage and other material as far away from the antenna as possible.
- **Terrain:** Hills, mountains, tall buildings, bridges, tunnels, freeway overpasses, parking garages, dense tree foliage and thunderstorms can interfere with your reception.
- **Station overload:** When you pass a ground based broadcast repeating tower, a stronger signal may overtake a weaker one and result in an audio mute.

Unlike AM/FM audible static, you will hear an audio mute when there is a satellite radio signal interference. Your radio display may display NO SIGNAL to indicate the interference.

SIRIUS satellite radio service: SIRIUS Satellite Radio is a subscription based satellite radio service that broadcasts music, sports, news and entertainment programming. A service fee is required in order to receive SIRIUS service. Vehicles that are equipped with a factory installed SIRIUS Satellite Radio system include:

- Hardware and limited subscription term, which begins on the date of sale or lease of the vehicle.
- Use of online media player providing access to all SIRIUS music channels over the internet using any computer connected to the internet (U.S. customers only)

For information on extended subscription terms, contact SIRIUS at 1-888-539-7474.

Note: SIRIUS reserves the unrestricted right to change, rearrange, add or delete programming including canceling, moving or adding particular channels, and its prices, at any time, with or without notice to you. Mazda Motor Corporation shall not be responsible for any such programming changes.

Satellite Radio Electronic Serial Number (ESN): This 12-digit Satellite Serial Number is needed to activate, modify or track your satellite radio account. You will need this number when communicating with SIRIUS. While in Satellite Radio mode, you can view this number on the radio display by pressing the SIRIUS and Preset 1 buttons at the same time.

Entertainment Systems

Radio Display	Condition	Action Required
ACQUIRING	Radio requires more than two seconds to produce audio for the selected channel.	No action required. This message should disappear shortly.
SAT FAULT	Internal module or system failure present.	If this message does not clear within a short period of time, or with an ignition key cycle, your receiver may have a fault. See your authorized dealer for service.
INVALID CHNL	Channel no longer available.	This previously available channel is no longer available. Tune to another channel. If the channel was one of your presets, you may choose another channel for that preset button.
UNSUBSCRIBED	Subscription not available for this channel.	Contact SIRIUS at 1-888-539-7474 to subscribe to the channel or tune to another channel.
NO TEXT	Artist information not available.	Artist information not available at this time on this channel. The system is working properly.

Entertainment Systems

Radio Display	Condition	Action Required
NO TEXT	Song title information not available.	Song title information not available at this time on this channel. The system is working properly.
NO TEXT	Category information not available.	Category information not available at this time on this channel. The system is working properly.
NO SIGNAL	Loss of signal from the SIRIUS satellite or SIRIUS tower to the vehicle antenna.	You are in a location that is blocking the SIRIUS signal (i.e., tunnel, under an overpass, dense foliage, etc). The system is working properly. When you move into an open area, the signal should return.
UPDATING	Update of channel programming in progress.	No action required. The process may take up to three minutes.
CALL SIRIUS 1-888-539-7474	Satellite service has been deactivated by SIRIUS Satellite Radio.	Call SIRIUS at 1-888-539-7474 to re-activate or resolve subscription issues.

NAVIGATION SYSTEM (IF EQUIPPED)

Your vehicle may be equipped with a navigation system. Refer to the *Navigation system* supplement for further information.





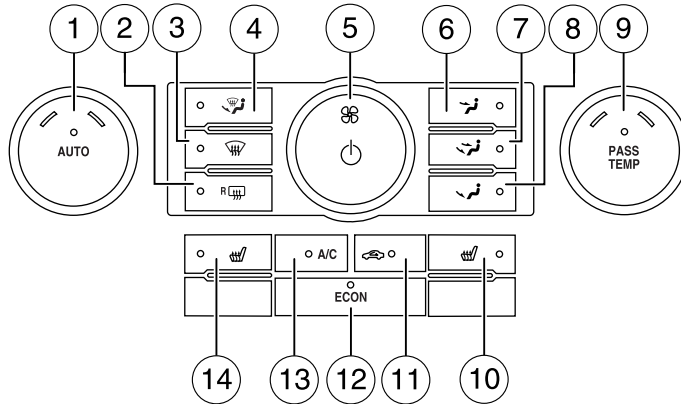





Climate Controls

DUAL AUTOMATIC TEMPERATURE CONTROL







1. **AUTO/Driver temperature:** Press to engage full automatic operation. The system will automatically determine fan speed, airflow distribution, A/C on or off, and outside or recirculated air, to heat or cool the vehicle to reach the desired temperature. Turn to increase/decrease the temperature on the driver side of the vehicle. The control also adjusts the passenger side temperature when PASS TEMP is disengaged. The recommended initial setting is between 72°F (22°C) and 75°F (24°C), then adjust for comfort. The driver side temperature setting will appear in the upper left corner of the display. The engine may run continuously to provide A/C operation unless ECON mode is selected. Selecting ECON mode affects A/C operation. Refer to ECON information later in this section.
2. **Rear defroster:** Press to activate/deactivate the rear window defroster. Refer to *Rear window defroster* later in this chapter for more information.
3. **Defrost:** Distributes outside air through the windshield defroster vents and demister vents. Can be used to clear the windshield of fog and thin ice. The system will automatically provide outside air to reduce window fogging. On days where the outside temperature is approximately freezing or higher, the engine will run continuously in this mode. Press this button again to return to the previous air flow selection or press AUTO to return to full automatic control.

Climate Controls

4.  **Defrost/Floor:** Distributes air through the windshield defroster vents, demister vents, floor vents and rear seat floor vents. The system will automatically provide outside air to reduce window fogging. On days where the outside temperature is approximately freezing or higher, the engine will run continuously in this mode.
5.  **Power/Fan:** Press to activate/deactivate the climate control system. When the system is off, outside air is shut out. Turn to manually increase/decrease the fan speed. The manual fan speed setting will appear on the left side of the display. Press AUTO to return to full automatic control.
6.  **Panel:** Distributes air through the instrument panel vents.
7.  **Panel/Floor:** Distributes air through the instrument panel vents, demister vents, floor vents and rear seat floor vents.
8.  **Floor:** Distributes air through the demister vents, floor vents and rear seat floor vents.
9. **Passenger temperature:** Press to engage/disengage separate passenger side temperature control. Turn to increase/decrease the temperature on the passenger side of the vehicle. The recommended initial setting is between 72°F (22°C) and 75°F (24°C), then adjust for comfort. The passenger side temperature setting will appear in the upper right corner of the display.
10.  **Passenger heated seat control (if equipped):** Press to activate/deactivate the passenger heated seat. See *Heated seats* in the *Seating and Safety Restraints* chapter.
11.  **Recirculated air:** Press to activate/deactivate air recirculation in the vehicle. Recirculated air may reduce the amount of time needed to cool down the interior of the vehicle, may reduce the energy needed to keep the interior of the vehicle cool, and may also help reduce undesired outside odors from reaching the interior of the vehicle. Recirculated air is controlled automatically when AUTO is selected or can be engaged manually in any airflow mode except  (defrost). Recirculated air may turn off automatically in some airflow modes to reduce window fogging potential. When the ignition switch is turned off and back on, the climate system will return to the recirculated air mode only if the A/C button LED is illuminated and the air distribution selection is either AUTO,  (panel) or  (panel/floor).



Climate Controls

12. **ECON:** Press to activate/deactivate economy air conditioning operation. ECON mode may provide improved fuel economy by allowing the gasoline engine to shut down even if air conditioning is requested. When the gas engine turns off, the A/C compressor does not operate to cool the cabin and comfort may be reduced. In ECON mode, when the gasoline engine is running, A/C operates as normal. To prioritize cooling comfort over fuel economy, deactivate ECON. ECON can not be selected in  (defrost) or  (floor/defrost).
13. **A/C:** Press to activate/deactivate air conditioning. Use with recirculated air to improve cooling performance and efficiency. Engages automatically in AUTO,  (defrost) and  (floor/defrost). Selecting ECON mode affects A/C operation. Refer to ECON information previously in this section.
14.  **Driver heated seat control (if equipped):** Press to activate/adjust the driver heated seat. See *Heated seats* in the *Seating and Safety Restraints* chapter.

Outside temperature: The outside temperature will appear in the display and is labeled EXT TEMP.

Temperature conversion: To switch between Fahrenheit and Celsius, refer to *Setup menu* in the *Message center* section of the *Driver Controls* chapter.

Operating tips

- To reduce fog build up on the windshield during humid weather, select  (defrost) or  (floor/defrost).
- To reduce humidity build up inside the vehicle, do not drive with the system OFF or with  (recirculated air) engaged and A/C off.
- Do not put objects under the front seats that will interfere with the airflow to the back seats by blocking the air from the rear seat floor vents.
- Remove any snow, ice or leaves from the air intake area at the base of the windshield.
- To improve the A/C cool down, drive with the windows slightly open for 2-3 minutes after start up or until the vehicle has been “aired out.”
- If you find the comfort degradation too much during the gasoline engine off cycles when using A/C in ECON mode, try leaving the system in ECON mode and reducing the temperature setting 1 or 2 degrees at a time.

Climate Controls



For maximum cooling performance:

• Automatic operation:

1. Press AUTO for full automatic operation.
2. Do not override A/C or  (recirculated air).
3. Set the temperature to 60°F (16°C).

Make sure ECON mode is deactivated.

• Manual operation:

1. Select A/C.
2. Select  or .
3. Select  (recirculated air) to provide colder airflow.
4. Set the temperature to 60°F (16°C).
5. Set highest fan setting initially, then adjust to maintain comfort.

Make sure ECON mode is deactivated.

To aid in side window defogging/demisting in cold weather:

1. Select .
2. Select A/C.
3. Adjust the temperature control to maintain comfort.
4. Set the fan speed to the highest setting.
5. Direct the outer instrument panel vents towards the side windows.



To increase airflow to the outer instrument panel vents, close the vents located in the middle of the instrument panel.

Climate Controls

REAR WINDOW DEFROSTER

The rear defroster control is located on the climate control panel and works to clear the rear window of fog and thin ice.

The vehicle must be on to operate the rear window defroster.

Press  to turn the rear window defroster on. An indicator light on the button will illuminate when active. The rear window defroster turns off automatically after approximately 15 minutes. If a low battery condition is detected or the ignition is turned off or to the accessory position, the rear window defroster will not function. To manually turn off the rear window defroster at any time, press  again.

If your vehicle is equipped with both rear defroster and heated mirrors, the same button will activate both. Refer to *Heated outside mirrors* in the *Driver Controls* chapter.

Do not use razor blades or other sharp objects to clean the inside of the rear window or to remove decals from the inside or the rear window. This may cause damage to the heated grid lines and will not be covered by your warranty.

Lights

HEADLAMP CONTROL ☀️

Rotate the headlamp control to the first position  to turn on the parking lamps.

Rotate to the second position  to turn on the headlamps.

Rotate back to  to turn the headlamps off.

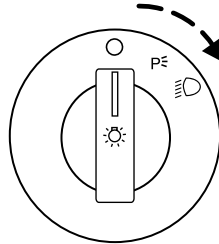

Autolamp control (if equipped) ☀️

The autolamp system provides light sensitive automatic on-off control of the exterior lights normally controlled by the headlamp control.

The autolamp system is factory programmed to keep the lights on for 20 seconds after the ignition switch is turned to off. This delay can be programmed, using the procedure listed below, to any value up to 180 seconds. If equipped, this delay can also be programmed through the message center

- To turn autolamps on, rotate the control counterclockwise.
- To turn autolamps off, rotate the control clockwise to the off position.

Note: If the vehicle is equipped with autolamps it will have the *headlamps on with windshield wipers feature*. If the windshield wipers are turned on for a brief period of time, the exterior lamps will turn on with the headlamp control in the autolamp position.

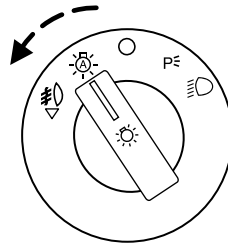

Lights

Autolamp delay system (if equipped)

If your vehicle is equipped with autolamps, you can set the delay time to keep the headlights on for up to three minutes after the key is turned off. The delay time is set to 20 seconds at the factory, but the delay time may be changed by following the steps below (Steps 1 through 6 must be done within 10 seconds):

1. Turn the key to the off position.
2. Rotate the headlamp control to the autolamp position.
3. Rotate the headlamp control to the off position.
4. Turn the key to the on position.
5. Turn the key back to the off position.
6. Turn the headlamp control to the autolamp position (the headlights should turn on).
7. Turn the headlamp control to the off position when the desired delay time (up to 3 minutes) has been reached.

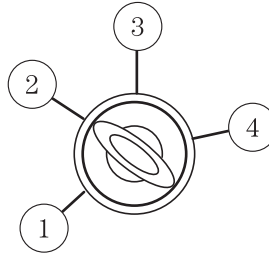

Fog lamp control (if equipped) Ⓢ

The headlamp control also operates the fog lamps. The fog lamps can be turned on when the headlamp control is in the P , Ⓢ , or D positions and the high beams are not turned on.

Pull the headlamp control towards you to turn the fog lamps on. The fog lamp indicator light Ⓢ will illuminate.

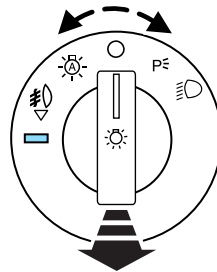

Lights

High beams

Push the lever toward the instrument panel to activate. Pull the lever towards you to deactivate.

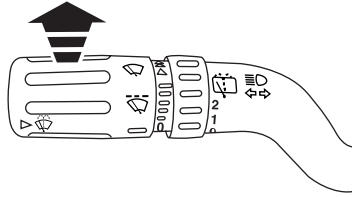

Flash to pass

Pull toward you slightly to activate and release to deactivate.

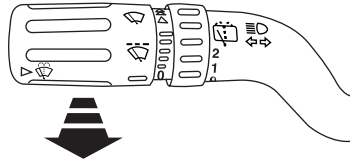

Daytime running lamps (DRL)

Turns the lowbeam headlamps on with a reduced output.

To activate:

- the ignition must be in the on position.
- the headlamp control must be in the off , parking lamps or autolamp position.
- the transmission is not in P (Park),



WARNING: Always remember to turn on your headlamps at dusk or during inclement weather. The Daytime Running Lamp (DRL) system does not activate the tail lamps and generally may not provide adequate lighting during these conditions. Failure to activate your headlamps under these conditions may result in a collision.

Lights

PANEL DIMMER CONTROL

Use to adjust the brightness of the instrument panel and all applicable switches in the vehicle during headlamp and parking lamp operation.

Move the control to the full upright position, past detent, to turn on the interior lamps.

Rotate to full down position (past detent) to prevent interior lamps from illuminating when the doors are opened.

Note: If the battery is disconnected, discharged, or a new battery is installed, the dimmer switch requires re-calibration. Rotate the dimmer switch from the full dim position to the full Dome/ON position to reset. This will ensure that your displays are visible under all lighting conditions.

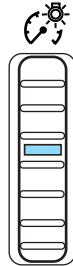

AIMING THE HEADLAMPS

The headlamps on your vehicle are properly aimed at the assembly plant. If your vehicle has been in an accident, the alignment of your headlamps should be checked by your authorized dealer.

Vertical aim adjustment

1. Park the vehicle directly in front of a wall or screen on a level surface, approximately 25 feet (7.6 meters) away.
 - (1) 8 feet (2.4 meters)
 - (2) Center height of lamp to ground
 - (3) 25 feet (7.6 meters)
 - (4) Horizontal reference line
2. Measure the height from the center of your headlamp to the ground and mark an 8 foot (2.4 meter) horizontal reference line on the vertical wall or screen at this height (a piece of masking tape works well). The center of the lamp is marked by a 3.0 mm circle on the headlamp lens.

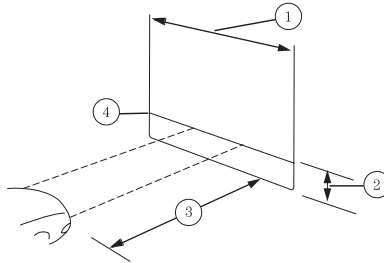

Lights

3. Turn on the low beam headlamps to illuminate the wall or screen and open the hood. Cover the left-hand headlamp with an opaque cloth.

4. On the wall or screen you will observe a light pattern with a distinct horizontal edge of high intensity light towards the right. If this edge is not at the horizontal reference line, the beam will need to be adjusted.

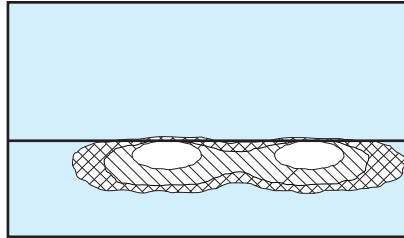

5. Locate the vertical adjuster on the headlamp, then turn the adjuster either clockwise (to adjust up) or counterclockwise (to adjust down) aligning the upper edge of the light pattern to the horizontal line.

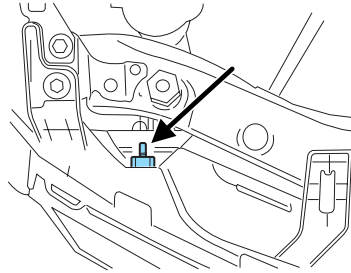

6. Move the opaque cloth to cover the right-hand headlamp and repeat Steps 4 and 5 for the left-hand headlamp.

7. HORIZONTAL AIM IS NOT REQUIRED FOR THIS VEHICLE AND IS NON-ADJUSTABLE.

8. Close the hood and turn off the lamps.

TURN SIGNAL CONTROL ⇄

- Push down to activate the left turn signal.
- Push up to activate the right turn signal.

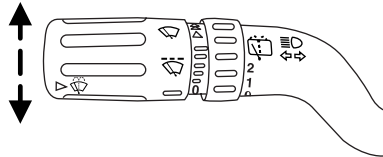

Lights

INTERIOR LAMPS

Dome lamps and map lamps

The front dome lamp is located overhead between the driver and passenger seats.

The dome lamp control has three positions:

- **OFF:** In this position, the lamp will not illuminate when the doors are open or when attempting to turn the dome lamp on by fully rotating the dimmer control located on the instrument panel.
- **DOOR:** In this position, the dome lamp will illuminate only when a door is opened and will remain illuminated for 25 seconds after the door is shut.
- **ON:** In this position, the lamp will remain illuminated.

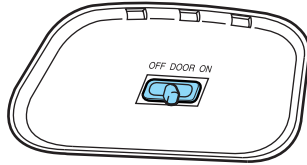

The map lamp controls (without moon roof) are located on the dome lamp. Press the button on either side of each map lamp to illuminate the lamps. Push the button again to turn off the lamps.

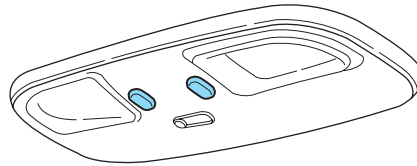

For models equipped with a moon roof, the map lamps are located on the moon roof control panel. Press the button on either side of each map lamp to illuminate the lamps. Push the button again to turn off the lamps.

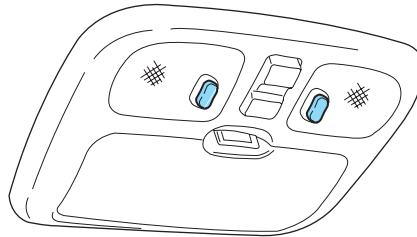

The map lamps will illuminate whenever a door is opened. After the door is shut, the lamps will remain illuminated for 25 seconds.

Lights

Cargo and dome lamp

Rear cargo lamp equipped with an ON/OFF/DOOR control will light when:

- the doors are closed and the control is in the ON position.
- the control is in the DOOR position and any door is open.

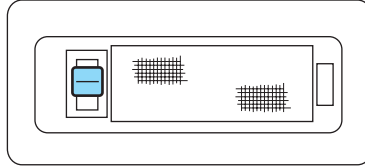

When the control is in the OFF position, it will not illuminate when you open the doors.

Interior lighting battery saver

The interior lamps will automatically extinguish after 10 minutes when the ignition key is in the off/lock position, a door has been left open or the interior lamp controls are in the on position.

BULB REPLACEMENT

Headlamp condensation

Exterior lamps are vented to accommodate normal changes in pressure. Condensation can be a natural by-product of this design. When moist air enters the lamp assembly through the vents, condensation can occur when the temperature is cold. When normal condensation occurs, a thin film of mist can form on the interior of the lens. The thin mist eventually clears and exits through the vents during normal operation. Clearing time may take as long as 48 hours under dry weather conditions.

Examples of acceptable condensation are:

- Presence of thin mist (no streaks, drip marks or droplets)
- Fine mist covers less than 50% of the lens

Examples of unacceptable moisture (usually caused by a lamp water leak) are:

- Water puddle inside the lamp
- Large water droplets, drip marks or streaks present on the interior of the lens

Take your vehicle to dealer for service if any of the above conditions of unacceptable moisture are present.

Using the right bulbs

Replacement bulbs are specified in the chart below. Headlamp bulbs must be marked with an authorized "D.O.T." for North America to ensure lamp performance, light brightness and pattern and safe visibility.

Lights

Note: The correct bulbs will not damage the lamp assembly or void the lamp assembly warranty and will provide quality bulb burn time.

Function	Number of bulbs	Trade number
Headlamps (high and low beams)	2	H13
Park/turn/sidemarkers lamps (front)	2	3157A (amber)
Rear stop/tail/sidemarkers	2	3157K / 4157K
Backup lamp	2	921
Fog lamp (front)	2	9145
Center High-mount stop lamp	5	W5WL
Rear license plate lamp	2	168

All replacement bulbs are clear in color except where noted.
To replace all instrument panel lights - see your authorized dealer

Replacing interior bulbs

Check the operation of all bulbs frequently.

Replacing exterior bulbs

Check the operation of all the bulbs frequently.

Replacing headlamp bulbs

1. Make sure that the headlamp control is in the off position.
2. Open the hood.
3. Reach over the front bolster.
4. Remove the bulb by turning it counterclockwise and then pulling it straight out.

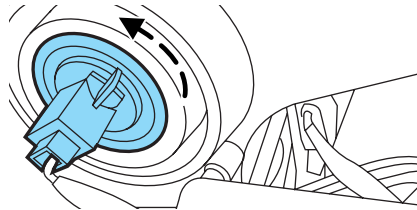

Lights

 **WARNING:** Handling Halogen Bulbs: When a halogen bulb breaks, it is dangerous. These bulbs contain pressurized gas. If one is broken, it will explode and serious injuries could be caused by the flying glass. If the glass portion of the bulb is touched with bare hands, body oil could cause the bulb to overheat and explode when lit. Never touch the glass portion of the bulb with your bare hands and always wear eye protection when handling or working around halogen bulbs.

5. Disconnect the electrical connector from the bulb.

 **WARNING:** Children and Halogen Bulbs: Playing with a halogen bulb is dangerous. Serious injuries could be caused by dropping a halogen bulb or breaking in some other way. Always keep halogen bulbs out of the reach of children.

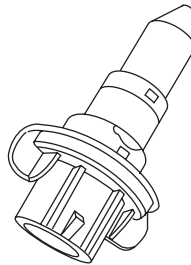

6. Connect the electrical connector on the new bulb.
7. Insert the glass end of the new bulb into the headlamp assembly. When the grooves in the plastic base are aligned, turn the new bulb clockwise to install.

Replacing front parking lamp/turn signal bulbs

For bulb replacement, see your authorized Mazda dealer.

Lights

Replacing tail/stop/turn/backup lamp bulbs

The tail/stop/turn/sidemarker/backup lamp bulbs are located in the same portion of the tail lamp assembly, one just below the other. Follow the same steps to replace either bulb:

1. Make sure the headlamp switch is in the off position and then open the liftgate to expose the lamp assembly screws.
2. Remove the two screws from the lamp assembly.
3. Carefully remove the lamp assembly away from the vehicle by pulling the assembly straight out to expose the bulb socket.
DO NOT TIP THE LAMP ASSEMBLY SIDEWAYS.
4. Rotate the bulb socket counterclockwise and remove from lamp assembly.
5. Pull bulb straight out of socket and push in the new bulb.
6. Install the bulb socket into the lamp assembly and rotate clockwise.
7. Carefully install the tail lamp assembly on the vehicle and secure with two screws.

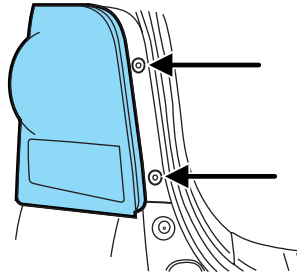

Replacing license plate lamp bulbs

1. Make sure the headlamp switch is in the off position.
2. Depress the lever and carefully pry the license plate lamp assembly (located above the license plate) from the liftgate.
3. Rotate the bulb socket counterclockwise and remove from lamp assembly.

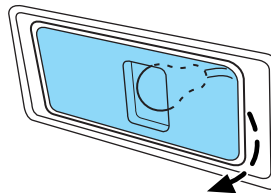

Lights

4. Pull bulb straight out of socket and push in the new bulb.
5. Install the bulb socket into the lamp assembly and rotate clockwise.
6. To install, carefully press the lamp assembly into liftgate.

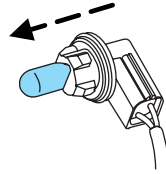

Replacing high-mount brake lamp bulbs

To remove the lamp assembly:

1. Remove the two screws and move the lamp assembly away from the liftgate.
2. Remove the bulb holder from the lamp assembly by depressing the snaps.

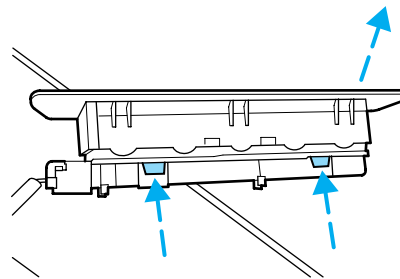
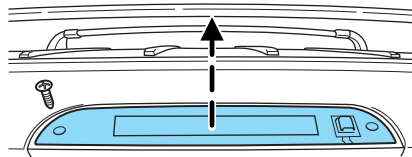

3. Pull the bulb straight out of the socket and push in the new bulb.

To complete installation, follow the removal procedure in reverse order.

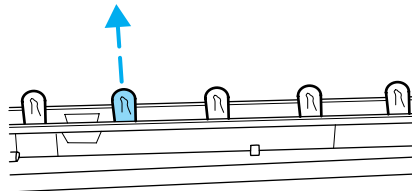

Lights

Replacing fog lamp bulbs (if equipped)

1. Make sure the fog lamp switch is in the off position.
2. From underneath the vehicle, carefully disconnect the electrical connector from the bulb.
3. Remove the bulb from the lamp assembly by pulling out on the bulb while squeezing on the upper and lower snap clips at the same time.

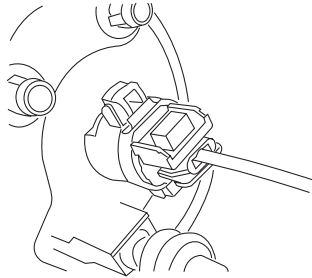

Install the new bulb in reverse order.

Driver Controls

MULTI-FUNCTION LEVER

Windshield wiper: Rotate the end of the control away from you to increase the speed of the wipers; rotate towards you to decrease the speed of the wipers.

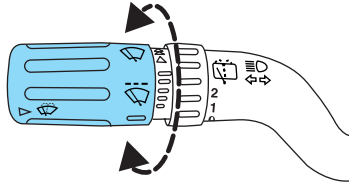

Note: Heavy ice and snow can jam the wiper blades and overheat the wiper motor. If this happens, the motor will automatically stop the operation of the blades for a short period of time. If this happens while driving, turn off the wiper switch, park off the right-of-way, and remove the snow and ice. After a short period of time, turn the switch on and the blades should operate normally. If they don't resume functioning, consult an authorized Mazda Dealer as soon as possible. Wait until the weather clears before trying to drive with the wipers inoperative.

Windshield washer: Push the end of the stalk:

- briefly: causes a single swipe of the wipers without washer fluid.
- a quick push and hold: the wipers will swipe three times with washer fluid.
- a long push and hold: the wipers and washer fluid will be activated for up to ten seconds.

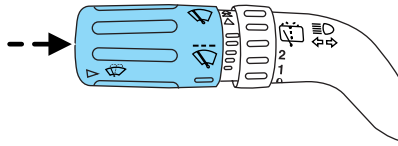

Courtesy wipe feature: One extra wipe will occur a few seconds after washing the front window to clear any excess washer fluid remaining on the windshield.

Note: Do not operate the washer when the washer reservoir is empty. This may cause the washer pump to overheat. Check the washer fluid level frequently. Do not operate the wipers when the windshield is dry. This may scratch the glass, damage the wiper blades and cause the wiper motor to burn out. Before operating the wiper on a dry windshield, always use the windshield washer. In freezing weather, be sure the wiper blades are not frozen to the windshield before operating the wipers.

Windshield wiper rainlamp feature (if equipped with Autolamp)

When the windshield wipers are turned on during daylight, and the headlamp control is in the autolamp position, the exterior lamps will turn on after a brief delay and will remain on until the wipers are turned off.

Driver Controls

Rear window wiper/washer controls

For rear wiper operation, rotate the rear window wiper and washer control to the desired position. Select:

INT 2 — Normal speed operation of rear wiper.

INT 1 — Intermittent operation of rear wiper.

OFF — Rear wiper and washer off.

For rear wash cycle, rotate (and hold as desired) the rear wiper/washer control to either  position.

From either position, the control will automatically return to the INT 2 or OFF position.

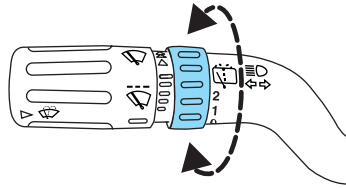

MANUAL TILT STEERING COLUMN

To adjust the steering wheel:

1. Pull down the steering column tilt lever.
2. Move the steering wheel up or down until you find the desired location.
3. Push the steering column tilt lever up. This will lock the steering wheel in position.

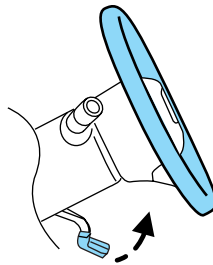
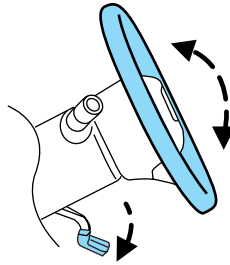

Driver Controls



WARNING: Adjusting the steering wheel while the vehicle is moving is dangerous. Moving it can very easily cause the driver to abruptly turn to the left or right. This can lead to loss of control or an accident. Never adjust the steering wheel while the vehicle is moving.

ILLUMINATED VISOR MIRROR

Lift the mirror cover to turn on the visor mirror lamps.

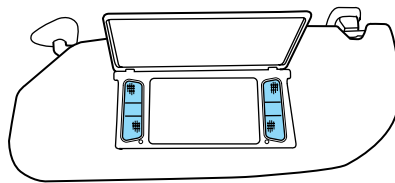

CENTER CONSOLE

Your vehicle is equipped with a variety of console features. These include:

1. Cupholders
2. Utility compartment console lid has a CD holder, a business card holder and two pen holders. The utility compartment has a removable bin with coin holder slots, a sliding tray, a cell phone holder and CD holders
3. Rear power point
4. Rear cupholders
5. Small storage trays

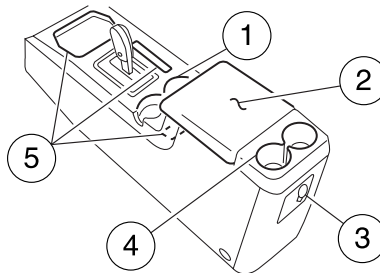

WARNING: Use only soft cups in the cupholders. Hard objects can injure you in a collision.

Driver Controls

The tray and inside bin can be removed to open up space to fit a laptop computer, MP3 players, CDs or handbags. To remove, open the console lid and pull the bin straight up and out from the console housing.

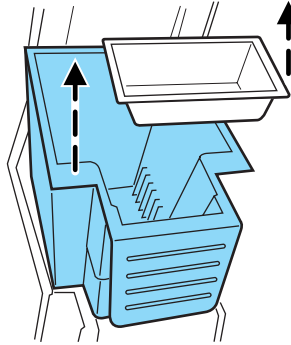

The sliding tray and inside bin can be hooked on the side or rear of the console for extra storage.

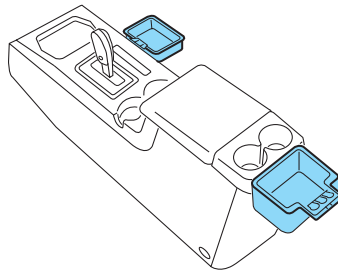

ELECTRONIC COMPASS

The compass heading is displayed as one of N, NE, E, SE, S, SW, W and NW in the center stack display.

The compass reading may be affected when you drive near large buildings, bridges, power lines and powerful broadcast antenna. Magnetic or metallic objects placed in, on or near the vehicle may also affect compass accuracy.

Usually, when something affects the compass readings, the compass will correct itself after a few days of operating your vehicle in normal conditions. If the compass still appears to be inaccurate, a manual calibration may be necessary. Refer to *Compass zone adjustment*.

Most geographic areas (zones) have a magnetic north compass point that varies slightly from the northerly direction on maps. This variation is four degrees between adjacent zones and will become noticeable as the vehicle crosses multiple zones. A correct zone setting will eliminate this error. Refer to *Compass calibration adjustment*.

Driver Controls

Compass zone adjustment

1. Determine which magnetic zone you are in for your geographic location by referring to the zone map.
2. Turn ignition to the on position.
3. Start the engine.

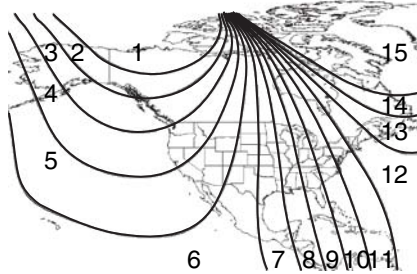

4. Press the SETUP control to select the Update Zone function and display the current ZONE XX in the center stack display.

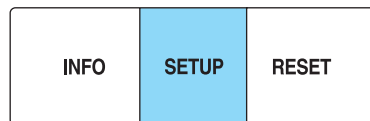

5. Continue to press the RESET control until the correct zone appears in the center stack display.

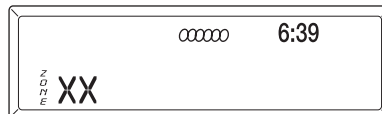

6. The direction will display after the RESET control is released. The zone is now updated.

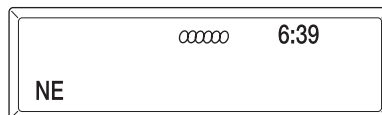

Compass calibration adjustment

Perform compass calibration in an open area free from steel structures and high voltage lines. For optimum calibration, turn off all electrical accessories (heater/air conditioning, wipers, etc.) and make sure all vehicle doors are shut.

1. Start the vehicle.

Driver Controls

- To calibrate, press and hold the RESET control for approximately ten seconds until CAL appears. Release the control.

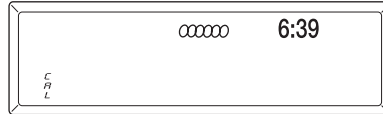

- Slowly drive the vehicle in a circle (less than 3 mph [5 km/h]) until the CAL display changes to the direction value. It may take up to five circles to complete calibration.

- The compass is now calibrated.

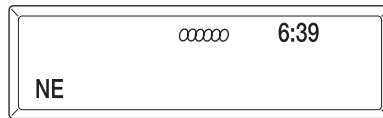

AUXILIARY POWER POINT (12V)

Power outlets are designed for accessory plugs only. Do not insert any other object in the power outlet as this will damage the outlet and blow the fuse. Do not hang any type of accessory or accessory bracket from the plug. Improper use of the power outlet can cause damage not covered by your warranty.

The auxiliary power point is located in the instrument panel.

A second auxiliary power point is located on the rear side of the center console.

Do not use the power point for operating the cigarette lighter element (if equipped).

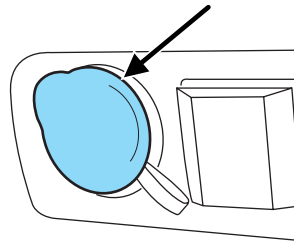

To prevent the fuse from being blown, do not use the power point(s) over the vehicle capacity of 12 VDC/180W. If the power point or cigar lighter socket is not working, a fuse may have blown. Refer to *Fuses and relays* in the *Roadside Emergencies* chapter for information on checking and replacing fuses.

To have full capacity usage of your power point, the engine is required to be running to avoid unintentional discharge of the battery. To prevent the battery from being discharged:

- do not use the power point longer than necessary when the engine is not running,

Driver Controls

- do not leave battery chargers, video game adapters, computers and other devices plugged in overnight or when the vehicle is parked for extended periods.

Always keep the power point caps closed when not being used.

Cigar/Cigarette lighter (if equipped)

Do not plug optional electrical accessories into the cigarette lighter socket.

Do not hold the lighter in with your hand while it is heating, this will damage the lighter element and socket. The lighter will be released from its heating position when it is ready to be used.

Note: Improper use of the lighter can cause damage not covered by your warranty, and can result in fire or serious injury.

Power point (110 VAC)

The 110 VAC power point outlet is used for powering electrical devices that require up to 150W. Exceeding the 150W limit will cause the power point to cut off the power temporarily to provide overload protection.

Note: The 110 VAC power point is equipped with a safety cap and a safety twist tab. They both provide protection from inserting any object into the power point other than the 110 VAC electrical device plug. The safety cap should always be in a closed position whenever the power point outlet is not in use.

The 110 VAC power point is located in the floor console in front of the gearshift.

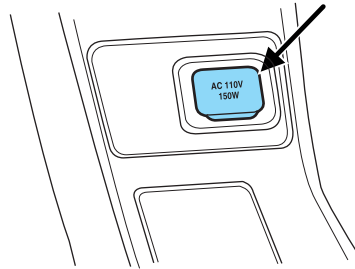

The power outlet is not designed for the following electric appliances; they may not work properly:

- Cathode ray tube televisions.
- Motor loads, such as vacuum cleaners, electric saws and other electric power tools, compressor-driven refrigerators, etc.
- Measuring devices, which process precise data, such as medical equipment, measuring equipment, etc.
- Other appliances requiring an extremely stable power supply: microcomputer-controlled electric blankets, touch sensor lamps, etc.

Driver Controls

Do not keep electrical devices plugged in the power point whenever the device is not in use. It is not recommended to use any extension cord with the 110 VAC power point, since it will defeat the safety protection design provided by the cap and twist tab. It will also cause the power point to overload due to powering multiple devices that can reach beyond the 150W load limit.

The power point can switch to a fault mode when it is overloaded, overheated, or shorted. For overloading and shorting conditions, unplug your device and turn the ignition key off then on. For an overheating condition, let the system cool off, then turn the ignition key off then on.

The 110 VAC power point can provide power whenever the vehicle ignition is in the run position and the power point green indicator light located in the top left corner is turned on. Refer to the indicator light code below for the power point status.

Indicator light Code

Green light is On — Power point is ready to supply power

Green light is Off — Power point power supply is off. Ignition is not in RUN position

Green light is blinking — Power point is in fault mode

POWER WINDOWS (IF EQUIPPED)



WARNING: Do not leave children unattended in the vehicle and do not let children play with the power windows. They may seriously injure themselves.



WARNING: When closing the power windows, you should verify they are free of obstructions and ensure that children and/or pets are not in the proximity of the window openings.

Press and pull the window switches to open and close windows.

- Push down (to the first detent) and hold the switch to open.
- Pull up and hold the switch to close.

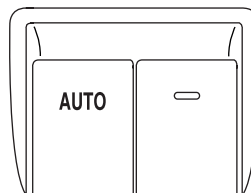

Driver Controls

Rear Window Buffeting: When one or both of the rear windows are open, the vehicle may demonstrate a wind throb or buffeting noise; this noise can be alleviated by lowering a front window approximately two to three inches.

One touch down (AUTO)

Allows the driver's window to open fully without holding the control down. Push the switch completely down to the second detent and release quickly. The window will open fully. Momentarily press the switch to any position to stop the window operation.

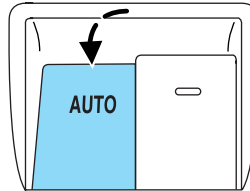

Window lock

The window lock feature allows only the driver to operate the power windows.

To lock out all the window controls (except for the driver's) press the right side of the control. Press the left side to restore the window controls.

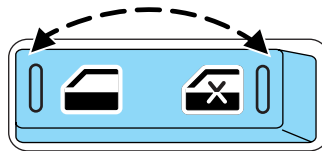

Accessory delay

With accessory delay, the window switches, moon roof (if equipped) and audio system may be used for up to 10 minutes after the ignition switch is turned to the off position or until either front door is opened.

INTERIOR MIRROR

The interior rear view mirror has two pivot points on the support arm which lets you adjust the mirror UP or DOWN and from SIDE to SIDE.



WARNING: Do not adjust the mirror while the vehicle is in motion.

Driver Controls

Automatic dimming interior rear view mirror (if equipped)

Your vehicle may be equipped with an interior rear view mirror that has an auto-dimming function. The electronic day/night mirror will change from the normal (high reflective) state to the non-glare (darkened) state when bright lights (glare) reach the interior mirror. When the interior mirror detects bright light from behind the vehicle, it will automatically adjust (darken) to minimize glare.

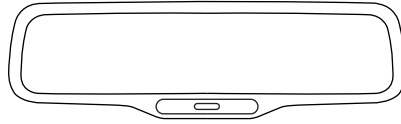

The mirror will automatically return to the normal state whenever the vehicle is placed in R (Reverse) to ensure a bright clear view when backing up.

Do not block the sensors on the front and back of the interior rear view mirror since this may impair proper mirror performance.

Do not clean the housing or glass of any mirror with harsh abrasives, fuel or other petroleum-based cleaning products.

EXTERIOR MIRRORS

Power side view mirrors



WARNING: Do not adjust the mirror while the vehicle is in motion.

To adjust your mirrors:

1. Rotate the control clockwise to adjust the right mirror and rotate the control counterclockwise to adjust the left mirror.
2. Move the control in the direction you wish to tilt the mirror.
3. Return to the center position to lock mirrors in place.

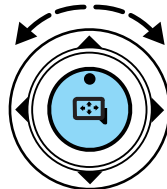

Driver Controls

Fold-away mirrors

Fold the side mirrors in carefully when driving through a narrow space, like an automatic car wash.

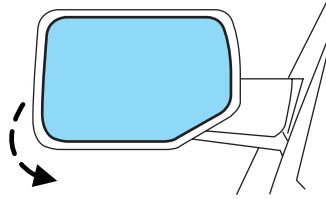

Heated outside mirrors (if equipped)

Both mirrors are heated automatically to remove ice, mist and fog when the rear window defrost is activated.

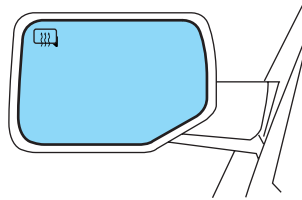

Do not remove ice from the mirrors with a scraper or attempt to readjust the mirror glass if it is frozen in place.

These actions could cause damage to the glass and mirrors.

Do not clean the housing or glass of any mirror with harsh abrasives, fuel or other petroleum-based cleaning products.

CRUISE CONTROL/SPEED CONTROL (IF EQUIPPED)

With cruise control/speed control set, you can maintain a set speed without keeping your foot on the accelerator pedal.



WARNING: Using cruise control in the following conditions could cause you to lose control of the vehicle:

- **Heavy or unsteady traffic**
- **Slippery or winding roads**
- **Similar restrictions that require inconsistent speed**
Don't use cruise control in these situations.

Driver Controls

Setting speed control

The controls for using your speed control are located on the steering wheel for your convenience.

1. Press the ON control and release it.
2. Accelerate to the desired speed.

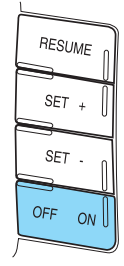

3. Press the SET + control and release it.
4. Take your foot off the accelerator pedal.
5. The indicator light  on the instrument cluster will turn on.

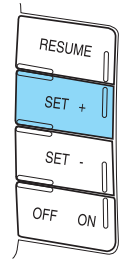

Note:

- Vehicle speed may vary momentarily when driving up and down a steep hill.
- If the vehicle speed increases above the set speed on a downhill, you may want to apply the brakes to reduce the speed.
- If the vehicle speed decreases more than 10 mph (16 km/h) below your set speed on an uphill, your speed control will disengage.

Disengaging speed control

To disengage the speed control:

- Depress the brake pedal

Disengaging the speed control will not erase previous set speed.

Driver Controls

Resuming a set speed

Press the RESUME control and release it. This will automatically return the vehicle to the previously set speed.

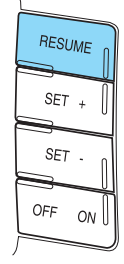

Increasing speed while using speed control

There are three ways to set a higher speed:

- Press and hold the SET + control until you get to the desired speed, then release the control.
- Press and release the SET + control to operate the Tap-Up function. Each tap will increase the set speed by 1 mph (1.6 km/h).
- Use the accelerator pedal to get to the desired speed. When the vehicle reaches that speed press and release the SET + control.

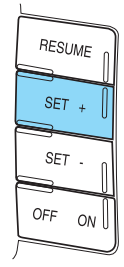

Reducing speed while using speed control

There are three ways to reduce a set speed:

- Press and hold the SET - control until you get to the desired speed, then release the control.
- Press and release the SET - control to operate the Tap-Down function. Each tap will decrease the set speed by 1 mph (1.6 km/h).

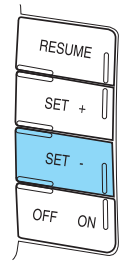

Driver Controls

- Depress the brake pedal until the desired vehicle speed is reached, press the SET + control.

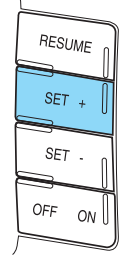

Turning off speed control

There are two ways to turn off the speed control:

- Press the speed control OFF control.
- Turn off the ignition.

Note: When you turn off the speed control or the ignition, your speed control set speed memory is erased.

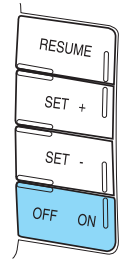

STEERING WHEEL CONTROLS (IF EQUIPPED)

These controls allow you to operate some audio control features.

Radio control features

Press MEDIA to select:

- AM, FM1, FM2, or CD
- SAT1, SAT2 or SAT3 (Satellite radio mode)
- LINE IN (Auxiliary input jack)



Driver Controls

In Radio mode:

- Press  to access the next/previous preset station.

In CD mode:

- Press  to listen to the next track on the disc.



In Satellite radio mode:

- Press  to advance through preset channels.

In any mode:

- Press VOL + or VOL - to adjust the volume.

Navigation system hands free control features (if equipped)

Press and hold  control briefly until the voice  icon appears on the navigation display to use the voice command feature.

Press  to complete a voice command.

For further information on the navigation system, refer to the *Navigation System* supplement.

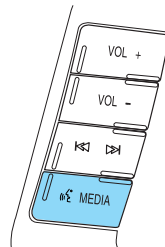
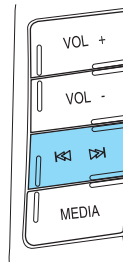

MOON ROOF (IF EQUIPPED)

You can move the glass panel of the moon roof back to open or tilt up (from the closed position) to ventilate the vehicle.



WARNING: Do not let children play with the moon roof or leave children unattended in the vehicle. They may seriously hurt themselves.

Driver Controls

To open the moon roof: The moon roof is equipped with an automatic, one-touch, opening, closing and venting feature. Press and release the rear portion of the control. To stop motion at any time during the one-touch operation, press the control a second time.

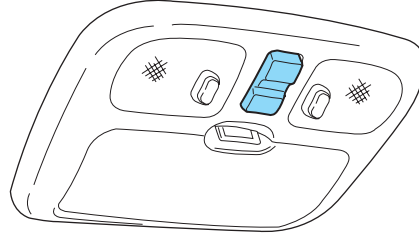

WARNING: When closing the moon roof, you should verify that it is free of obstructions and ensure that children and/or pets are not in the proximity of the moon roof opening.

To close the moon roof: The moon roof is equipped with an automatic, one-touch, closing feature. Press and release the front portion of the control. To stop motion at any time during the one-touch closing, press the control again.

Bounce-back: When an obstacle has been detected in the moon roof opening as the moon roof is closing, the moon roof will automatically open and stop at a prescribed position. This is known as “bounce-back”. If the ignition is turned off (without accessory delay being active) during bounce-back, the moon roof will move until the bounce-back position is reached.

Bounce-back override: To override bounce-back, press and hold the front portion of the control. For example: Bounce-back can be used to overcome the resistance of ice on the moon roof or seals. If during a bounce-back condition, the control is released to the neutral position, then held in the one-touch position within two seconds after the moon roof reaches the bounce-back position, **the moon roof will travel with no bounce-back protection.** If the control is released before the moon roof reaches fully closed or the ignition is turned off (without accessory delay being active), the moon roof will stop.

To vent:

- The moon roof is equipped with an automatic, one-touch, vent feature. To tilt the moon roof into the vent position (when the glass panel is closed), press and release the front portion of the control.
- To close the moon roof from the vent position, press and hold the rear portion of the control until the glass panel stops moving.

The moon roof has a sliding shade that can be opened or closed when the glass panel is shut. To close the shade, pull it toward the front of the vehicle.

Driver Controls

Accessory delay:

With accessory delay, the window switches, audio system, and moon roof (if equipped) may be used for up to 10 minutes after the ignition switch is turned off or until either front door is opened.

MESSAGE CENTER (IF EQUIPPED)

With the ignition in the on position, the message center, located on your instrument cluster, displays important vehicle information



XXXXXXXXXXXXXXXXXX
XXXXXXXXXXXXXXXXXX

through a constant monitor of vehicle systems. You may select

display features on the message center for a display of status. The system will also notify you of potential vehicle problems with a display of system warnings followed by a long indicator chime.

Selectable features

Reset

Press this control to select and reset functions shown in the INFO menu and SETUP menu.

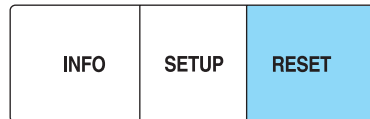

Info menu

This control displays the following control displays:

- Odometer/Trip Odometer
- Distance to Empty (DTE)
- Average Fuel Economy (AFE) (if equipped)
- Instantaneous Fuel Economy (if equipped)
- Electric Energy
- Blank (odometer off)



Note: If equipped with a Navigation Screen, the Average Fuel Economy and Instantaneous Fuel Economy will display in that screen instead of the message center display.

Odometer/Trip odometer

Refer to *Gauges* in the *Instrument Cluster* chapter.

Driver Controls

Distance to empty (DTE)

Selecting this function from the INFO menu will give you an estimate of how far you can drive with the fuel remaining in your tank under normal driving conditions.

Remember to turn the ignition off when refueling your vehicle. Otherwise, the display will not show the addition of fuel for a few miles (kilometers). DTE will vary according to your driving habits.



XXX MILES TO E
0.0 mi

Average fuel economy (AFE) (if equipped)

Selecting this function from the INFO menu will display your average fuel economy in miles/gallon or liters/100 km.



XX.X AVE MPG
0.0 mi

If you calculate your average fuel economy by dividing miles traveled by gallons of fuel used (liters of fuel by used 100 kilometers traveled), your figure may be different than displayed for the following reasons:

- your vehicle was not perfectly level during fill-up
- differences in the automatic shut-off points on the fuel pumps at service stations
- variations in top-off procedure from one fill-up to another
- rounding off the displayed values to the nearest 0.1 gallon (liter)
 1. Drive the vehicle at least 5 miles (8 km) with the speed control system engaged to display a stabilized average.
 2. Record the highway fuel economy for future reference.

It is important to press the RESET control after setting the speed control to get accurate highway fuel economy readings.

To reset back to zero, press and hold the RESET button for two seconds.

Instantaneous fuel economy (if equipped)

Select this function from the INFO menu to display your instantaneous fuel economy. This will display your fuel economy as a bar graph ranging from ▼ poor economy to ▲ excellent economy.



MPG ▼■■■■▲
0.0 mi

Driver Controls

Your vehicle must be moving to calculate instantaneous fuel economy. When your vehicle is not moving, this function shows ▼, one or no bars illuminated. Instantaneous fuel economy cannot be reset.

Electric Energy

Select this function from the INFO menu for the state of charge of the high voltage battery. For normal operation “ELECT ENERGY OK” will be displayed.



ELECT ENERGY OK

Setup menu

Press this control for the following displays:

- Reset to English (if in another language)
- System Check
- Oil Life
- Units (English/Metric)
- Autolamp Delay (if equipped)
- Autolock (if equipped)
- Autounlock (if equipped)
- Language

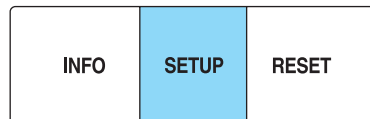

Reset to English (if in another language)

When entering the SETUP MENU and a non-English language has been selected, “PRESS RESET FOR ENGLISH” will be displayed to change back to English.



PRESS RESET
FOR ENGLISH

Press the RESET control to change back to English.

System check

Selecting this function from the SETUP menu causes the message center to cycle through each of the systems being monitored. For each of the monitored systems, the message center will indicate either an OK message or a warning message for four seconds.



RESET FOR
SYSTEM CHECK

Driver Controls

Pressing the RESET control cycles the message center through each of the systems being monitored. If you don't press any button, the system will cycle itself.

The sequence of the system check report is as follows:

1. Oil life
2. Electric drive
3. Brake system
4. Liftgate and glass
5. DTE/Fuel level

Oil life

An oil change is required whenever indicated by the message center. USE ONLY RECOMMENDED ENGINE OILS.

To reset the oil monitoring system to 100% after each oil change (approximately 10,000 miles [16,000 km] or 12 months) perform the following:

1. Press and release the SETUP control to display "OIL LIFE = XXX% HOLD RESET = NEW".



OIL LIFE XXX%
HOLD RESET=NEW

2. Press and hold the RESET control for two seconds and release. Oil life is set to 100% and "OIL LIFE SET TO 100%" is displayed.

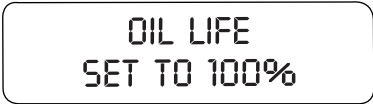

OIL LIFE
SET TO 100%

3. While "OIL LIFE SET TO 100%" is displayed, if a lower oil life start value is desired, press and release the RESET control to reduce the start value. Each press of the RESET control reduces the value by 10 %.

Note: Oil life start value of 100% equals 10,000 miles [16,000 km] or 12 months. For example, setting oil life start value to 60% sets the oil life start value to 6,000 miles (10,000 km) and 219 days.

Driver Controls

Units (English/Metric)

1. Select this function from the SETUP menu for the current units to be displayed.
2. Press the RESET control to change the message display from English to Metric.

UNITS
< ENG > METRIC

Autolamp delay

This feature keeps your headlights on for up to three minutes after the ignition is switched off.

1. To disable/enable the autolamp delay feature, select this function from the SETUP control for the current display mode.
2. Press the RESET control to select the new Autolamp delay values of 0, 10, 20, 30, 60, 90, 120 or 180 seconds.

AUTOLAMP (SEC)
< 0 > 10 20

Autolock

This feature automatically locks all vehicle doors when the vehicle is shifted into any gear, putting the vehicle in motion.

1. To disable/enable the autolock feature, select this function from the SETUP control for the current display mode.
2. Press the RESET control to turn the autolock ON or OFF.

AUTOLOCK
< ON > OFF

Autounlock

This feature automatically unlocks all vehicle doors when the driver's door is opened within 10 minutes of the ignition being turned off.

1. To disable/enable the autounlock feature, select this function from the SETUP control for the current display mode.
2. Press the RESET control switch to turn the autounlock ON or OFF.

AUTOUNLOCK
< ON > OFF

Driver Controls

Language

1. Select this function from the SETUP menu for the current language to be displayed.
2. Waiting four seconds or pressing the RESET control cycles the message center through each of the language choices.

LANGUAGE =
ENGLISH

Selectable languages are English, Spanish, or French.

3. Press and hold the RESET control for two seconds to set the language choice.

System warnings/information

System warnings alert you to possible problems or malfunctions in your vehicle's operating systems.

In the event of a multiple warning situation, the message center will cycle the display to show all warnings by displaying each one for four seconds.

The message center will display the last selected feature if there are no more warning messages. This allows you to use the full functionality of the message center after you acknowledge the warning by pressing the RESET control and clearing the warning message.

Warning messages that have been reset are divided into two categories:

- They will reappear on the display ten minutes from the reset.
- They will not reappear until an ignition off/on cycle has been completed if the fault condition still exists.

This acts as a reminder that these warning conditions still exist within the vehicle.

Warnings	Status
Driver door ajar	Warning cannot be reset
Passenger door ajar	
Rear left door ajar	
Rear right door ajar	

Driver Controls

Warnings	Status
Stop safely now	Warning returns after 10 minutes if condition still exists
High engine temperature	
High motor temperature	
Park brake engaged	
XXX miles to E fuel level low	Warning returns after the ignition key is turned from off to on.
Liftgate/Glass ajar	
Check fuel fill inlet	
Check brake system	
Brake fluid level low	
Regen brakes disabled	
Low tire pressure	
Tire pressure monitor fault	
Tire pressure sensor fault	
XX% oil life change soon	
Oil change required	

DRIVER DOOR AJAR — Displayed when the driver's door is not completely closed.

PASSENGER DOOR AJAR — Displayed when the passenger side door is not completely closed.

REAR LEFT DOOR AJAR — Displayed when the rear left door is not completely closed.

REAR RIGHT DOOR AJAR — Displayed when the rear right door is not completely closed.

STOP SAFELY NOW — Displayed when the Master electrical hazard warning lamp is illuminated indicating a Hybrid component failure. If this warning occurs, the vehicle will soon shutdown without further warning, stop the vehicle as soon as safely possible and contact your authorized dealer as soon as possible.

HIGH ENGINE TEMPERATURE — Displayed when the engine coolant is overheating. Engine coolant temperature warning lamp will illuminate indicating coolant temperature is high. Stop the vehicle as soon as safely possible, turn off the engine and let it cool. Check the coolant level. Refer to *Engine coolant* in the *Maintenance and Specifications* chapter. If the warning stays on or continues to come on, contact your authorized dealer as soon as possible.

Driver Controls



WARNING: When the engine and radiator are hot, scalding coolant and steam may shoot out under pressure and cause serious injury. Do not remove the cooling system cap when the engine and radiator are hot.

HIGH MOTOR TEMPERATURE — Displayed when the motor electronics are overheating. Stop the vehicle as soon as safely possible, turn off the engine and let it cool. Refer to *Engine coolant and motor/electronics coolant* in the *Maintenance and Specifications* chapter. If the warning stays on or continues to come on, contact your authorized dealer as soon as possible.

PARK BRAKE ENGAGED — Displayed when the manual park brake is set, the engine is running and the vehicle is driven more than 3 mph (5 km/h). If the warning stays on after the park brake is released, contact your authorized dealer as soon as possible.

XXX MILES TO E FUEL LEVEL LOW — Displayed as an early reminder of a low fuel condition.

LIFTGATE / GLASS AJAR — Displayed when the liftgate or liftgate glass is not completely closed. Press RESET to reset display.

CHECK BRAKE SYSTEM — Displayed when the braking system is not operating properly. If the warning stays on or continues to come on, contact your authorized dealer as soon as possible.

CHECK FUEL FILL INLET — Displayed when the fuel fill inlet may not be properly closed. Refer to *Easy Fuel™ “no cap” fuel system* in the *Maintenance and Specifications* chapter.

BRAKE FLUID LEVEL LOW — Indicates the brake fluid level is low and the brake system should be inspected immediately. Refer to *Brake fluid* in the *Maintenance and Specifications* chapter.

REGEN BRAKE DISABLED — Indicates the regenerative braking system is disabled at this moment. Please see your authorized dealer if this warning remains present over several days.

LOW TIRE PRESSURE — Displayed when one or more tires on your vehicle have low tire pressure. Refer to *Inflating your tires* in the *Tires, Wheels and Loading* chapter.

TIRE PRESSURE MONITOR FAULT — Displayed when the Tire Pressure Monitoring System is malfunctioning. If the warning stays on or continues to come on, have the system inspected by your authorized dealer.

Driver Controls

TIRE PRESSURE SENSOR FAULT — Displayed when a tire pressure sensor is malfunctioning, or your spare tire is in use. For more information on how the system operates under these conditions, refer to *Tire Pressure Monitoring System (TPMS)* in the *Tires, Wheels and Loading* chapter. If the warning stays on or continues to come on, have the system inspected by your authorized dealer.

OIL LIFE CHANGE SOON — Displayed when the engine oil life remaining is 10% or less. When oil life left is between 10% and 0%, the XX% OIL LIFE CHANGE SOON message will be displayed.

OIL CHANGE REQUIRED — Displayed when the oil life left reaches 0%, the OIL CHANGE REQUIRED message will be displayed.

LIFTGATE

- To open the liftgate window, unlock the liftgate (with the power door locks or the remote entry) and push the **right side** control button under the license plate lamp shield.
- To open the liftgate, unlock the liftgate (with the power door locks or the remote entry) and push the **middle** control button under the license plate lamp shield.

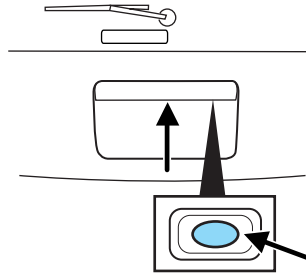

To lock the liftgate and the liftgate window, use the power door locks. Do not open the liftgate or liftgate glass in a garage or other enclosed area with a low ceiling. If the liftgate glass is raised and the liftgate is also opened, both liftgate and glass could be damaged against a low ceiling.

Do not leave the liftgate or liftgate glass open while driving. Doing so could cause serious damage to the liftgate and its components as well as allowing carbon monoxide to enter the vehicle.

WARNING: Make sure that the liftgate door and/or window are closed to prevent exhaust fumes from being drawn into the vehicle. Exhaust fumes contain carbon monoxide which can injure your lungs and cause drowsiness and even death. This will also prevent passengers and cargo from falling out. If you must drive with the liftgate door or window open, keep the vents open so outside air comes into the vehicle.

Driver Controls

CARGO AREA FEATURES

Cargo shade (if equipped)

If your vehicle has a cargo shade, you can use it to cover items in the cargo area of your vehicle.

To install the shade:

- Insert the ends of the cargo shade into the mounting features located behind the rear seat on the rear trim panels.

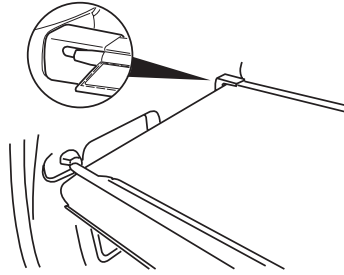

To operate the shade:

1. Grasp the rear edge of the cargo shade and pull rearward.
2. Secure both ends of the support rod into the retention slots located on the rear quarter trim panels.



WARNING: Ensure that the posts are properly latched in mounting features. The cover may cause injury in a sudden stop or accident if it is not securely installed.



WARNING: Do not place any objects on the cargo area shade. They may obstruct your vision or strike occupants of vehicle in the case of a sudden stop or collision.

Driver Controls

LUGGAGE RACK

Your vehicle may be equipped with a roof rack. The maximum load for the roof rack is 100 lb (45 kg), evenly distributed on the cross-bars. If it is not possible to evenly distribute the load, position it in the center or as far forward on the cross-bars as possible.

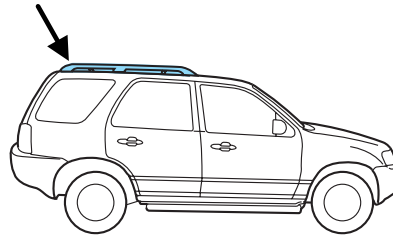

Do not use the vehicle's door handles as tie down loops. Use the tie-down loops on the thumbwheels to secure load.

To adjust the cross-bar (if equipped) position:

1. Loosen the thumbwheel at both ends of the cross-bar (both cross-bars are adjustable).
2. Slide the cross-bar to the desired location.
3. Tighten the thumbwheel at both ends of the cross-bar.

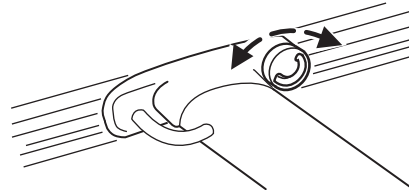

To remove the cross-bar assembly (if equipped) from the roof rack side rails:

1. Loosen the thumbwheel at both ends of the cross-bar (both cross-bars are adjustable).

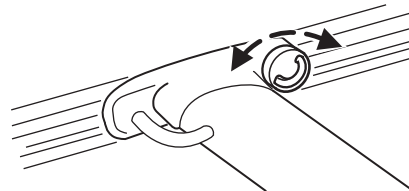

Driver Controls

2. Slide the cross-bar to the end of the rail.

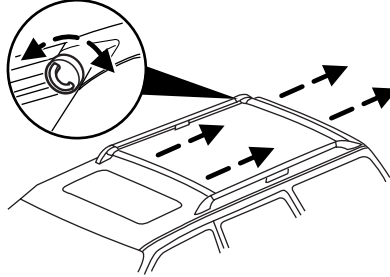

3. Use a long, flat object to depress the tongue in the endcaps on both sides of the cross-bar.
4. Slide the cross-bar assembly off the end of the rail.

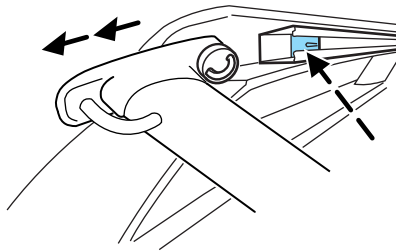

To reinstall the cross-bar assembly (if equipped) to the roof rack side rails:

1. Ensure that both cross-bar assemblies are installed with the F (front) arrow facing towards the front of the vehicle.
2. Use a long, flat object to depress the tongue in the endcaps on both sides of the cross-bar.
3. Slide the cross-bar assemblies over the end cap tongue and into the side rails.

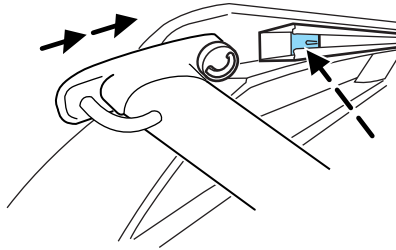

Driver Controls

4. Tighten thumbwheel at both ends of the cross-bar.

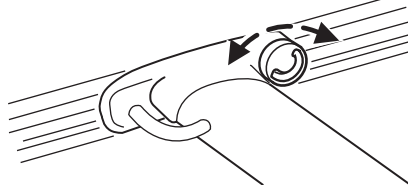

Locks and Security

KEYS

Your vehicle is equipped with two Integrated Keyhead Transmitters (IKTs). The IKT functions as both a programmed ignition key that operates all the locks and starts the vehicle, and a remote keyless entry transmitter.

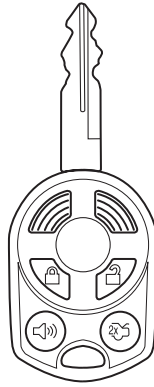

Your IKTs are programmed to your vehicle; using a non-programmed key will not permit your vehicle to start. If you lose your authorized dealer supplied IKTs, replacement IKTs are available through your authorized dealer. Standard SecuriLock™ keys without remote entry transmitter functionality can also be purchased from your authorized dealer if desired.

Always carry a spare key with you in case of an emergency.

For more information regarding programming replacement IKTs, refer to the *SecuriLock™ passive anti-theft system* section later in this chapter.

Note: Your vehicle's IKTs were issued with a security label on them that provides important vehicle key cut information. It is recommended that you maintain the label in a safe place for future reference, such as the inside front cover of this *Owner's Manual*.





Locks and Security

Recommended handling of the Integrated Keyhead Transmitter (IKT)

To avoid inadvertently activating the remote entry functions of your vehicle, it is recommended that the Integrated Keyhead Transmitter (IKT) be handled properly when starting and turning off your vehicle.

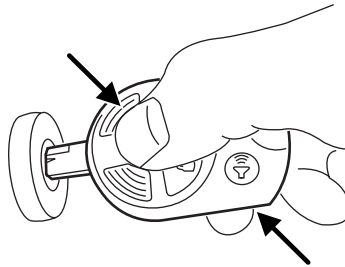
When inserting the IKT into the ignition cylinder, place your thumb on the center thumb rest of the IKT and forefinger on the logo badge on the opposite side.



To gain more leverage when rotating the IKT in the ignition lock cylinder, you can readjust the location of your thumb to grasp the IKT on the outer edge next to the  control.

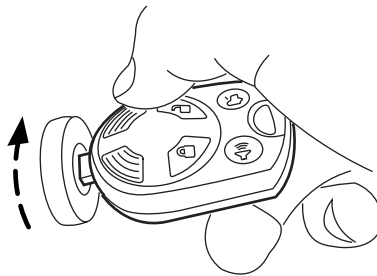

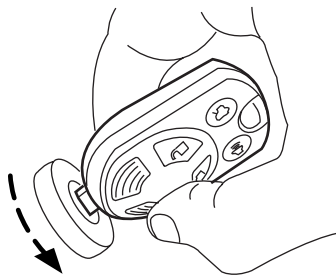

Likewise, when rotating the IKT to the off position in the ignition lock cylinder, the bottom edge of the IKT adjacent to the  control can be utilized.



Locks and Security

POWER DOOR LOCKS

- Press the  control to unlock all doors.
- Press the  control to lock all doors.

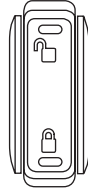

Door key unlocking/locking

Unlocking the doors

Turn the key in the door cylinder to unlock the driver's door only. All other doors will remain locked.

Locking the doors

Turn the key in the door cylinder to lock the driver's door only.

Autolock

The autolock feature will lock all the doors, liftgate and liftgate window when:

- all doors are closed,
- the ignition is in the on position,
- you shift into any gear putting the vehicle in motion, and
- the vehicle attains a speed greater than 12 mph (20 km/h).

The autolock feature repeats when:

- any door is opened then closed while the ignition is in the on position and the vehicle speed is 9 mph (15 km/h) or lower, and
- the vehicle attains a speed greater than 12 mph (20 km/h).

Deactivating/activating autolock

Your vehicle comes with the autolock feature enabled. There are two methods to enable/disable this feature:

- Through your authorized dealer, or
- Performing the power door lock control procedure.

Note: The autolock feature can be activated/deactivated independently of the autounlock feature.

Before following the activation or deactivation procedures, make sure that the anti-theft system is not armed, ignition is in the off position, and all vehicle doors, liftgate and liftgate window are closed.

Locks and Security

Power door unlock/lock procedure

You must complete Steps 1-5 within 30 seconds or the procedure will have to be repeated. If the procedure needs to be repeated, you must wait 30 seconds.

Note: All doors must be closed and remain closed throughout the configuration process.

1. The ignition must be off to begin sequence.
2. Turn the ignition to the on position.
3. Press the power door unlock control three times.
4. Turn the ignition from the on to the off position.
5. Press the power door unlock control three times.
6. Turn the ignition back to the on position. The horn will chirp.
7. Press the unlock control, then press the lock control. The horn will chirp once if autolock was deactivated or twice (one short and one long chirp) if autolock was activated.
8. Turn the ignition to the off position. The horn will chirp once to confirm the procedure is complete.

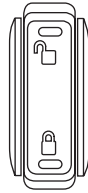

Autounlock

The autounlock feature will unlock all the doors when:

- the ignition is in the on position, all the doors are closed, and the vehicle has been in motion at a speed greater than 12 mph (20 km/h);
- the vehicle has then come to a stop and the ignition is turned to the off or accessory position; and
- the driver door is opened within 10 minutes of the ignition being transitioned to the off or accessory position.

Note: The doors will not autounlock if the vehicle has been electronically locked before the driver door is opened.

Locks and Security

Deactivating/activating autounlock

Your vehicle comes with the autounlock feature activated. There are two methods to enable/disable this feature:

- Through your authorized dealer, or
- by using the power door unlock/lock sequence.

Note: The autounlock feature can be activated/deactivated independently of the autolock feature.

Power door lock switch autounlock enable/disable procedure

Before starting, ensure the ignition is in the off position and all vehicle doors are closed. You must complete Steps 1–5 within 30 seconds or the procedure will have to be repeated. If the procedure needs to be repeated, wait a minimum of 30 seconds before beginning again.

1. Place the key in the ignition and turn the ignition to the on position.
2. Press the power door unlock control on the door panel three times.
3. Turn the ignition from the on position to the off position.
4. Press the power door unlock control on the door panel three times.
5. Turn the ignition back to the on position. The horn will chirp one time to confirm programming mode has been entered and is active.
6. To enable/disable the autounlock feature, press the lock control, then press the unlock control. The horn will chirp once if autounlock was deactivated or twice (one short and one long chirp) if autounlock was activated.
7. Turn the ignition to the off position. The horn will chirp once to confirm the procedure is complete.

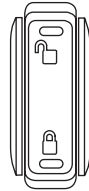

Smart unlocking feature

The smart unlocking feature helps prevent you from locking yourself out of the vehicle. With the key in any ignition position, the driver's door will automatically unlock if it is locked using the power lock control on the driver's door panel while the driver's door is open.

Locks and Security

CHILDPROOF DOOR LOCKS

When these locks are set, the rear doors cannot be opened from the inside. The rear doors can be opened from the outside when the doors are unlocked.

The childproof locks are located on rear edge of each rear door and must be set separately for each door.

NOTE: Setting the lock for one door will not automatically set the lock for both doors so you must set each child lock on each door separately.

Insert the key and turn in the direction of arrow shown on the door to engage the child proof lock. Turn in the opposite direction to disengage childproof locks.

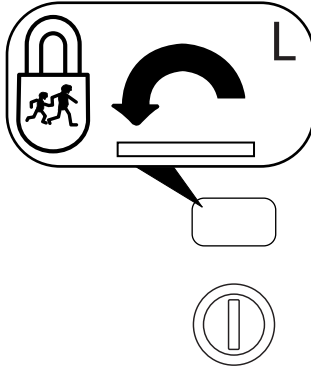

REMOTE ENTRY SYSTEM (IF EQUIPPED)

The Integrated Keyhead Transmitter (IKT) complies with part 15 of the FCC rules and with RSS-210 of Industry Canada. Operation is subject to the following two conditions: (1) This device may not cause harmful interference, and (2) This device must accept any interference received, including interference that may cause undesired operation.

Changes or modifications not expressly approved by the party responsible for compliance could void the user's authority to operate the equipment.

The typical operating range for your IKT is approximately 33 feet (10 meters). A decrease in operating range could be caused by:

- weather conditions,
- nearby radio towers,
- structures around the vehicle, or
- other vehicles parked next to your vehicle.

Locks and Security

The IKT allows you to:

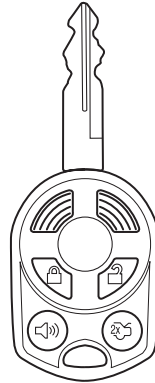

- remotely unlock the vehicle doors.
- remotely lock all the vehicle doors.
- remotely open the power liftgate glass.
- activate the personal alarm.
- operate the illuminated entry feature.



The remote entry lock/unlock feature operates in any ignition position except while the key is held in the start position. The panic feature operates with the key in the off position.

If there are problems with the remote entry system, make sure to take **ALL Integrated Keyhead Transmitters** with you to the authorized dealer in order to aid in troubleshooting the problem.

Two step door unlocking

1. Press  and release to unlock the driver's door. **Note:** The interior lamps will illuminate if the lamp is in the DOOR position.
2. Press  and release again within three seconds to unlock the passenger doors, the liftgate and liftgate glass.



The battery saver feature will turn off the interior lamps 10 minutes after the ignition is turned to the off position.

One step door unlocking



If the one step door unlocking feature is activated, press  and release once to unlock all of the doors, the liftgate and liftgate glass. **Note:** The interior lamps will illuminate (refer to *Illuminated entry* information later in this section), if the control on the overhead lamp is in the DOOR position.

Locks and Security

Switching from two step to one step door unlocking

Unlocking can be switched between two step and one step door unlocking by pressing and holding both  and  buttons simultaneously on the remote entry transmitter for approximately 4 seconds. The turn signal will flash twice to indicate that the vehicle has switched to one step unlocking. Repeat the procedure to switch back to two step unlocking.

Locking the doors

1. Press  and release to lock all the doors. Assuming all vehicle doors and the liftgate are properly closed and the park/turn lamps will flash once.
2. Press  and release again within three seconds to confirm that all the doors and liftgate are closed and locked. **Note:** The doors will lock again and the horn will chirp once.

If any of the doors or the hood are not properly closed, the horn will chirp twice and park/turn lamps will not flash when the  control is pressed.

Opening the liftgate glass (if equipped)

Press  twice within three seconds to open the liftgate glass.

Car finder

Press  twice within three seconds. The horn will chirp and the turn lamps will flash. It is recommended that this method be used to locate your vehicle, rather than using the panic alarm.

Sounding a panic alarm

Press  to activate the alarm. To deactivate the feature, press the control again, turn the ignition to the on or start position, or wait for the alarm to time out in approximately three minutes.

Note: The panic alarm will only operate when the ignition is in the off position.

Replacing the battery

The Integrated Keyhead Transmitter uses one coin type three-volt lithium battery CR2032 or equivalent.

Locks and Security

To replace the battery:

1. Twist a thin coin in the slot of the IKT near the key ring in order to remove the battery cover.

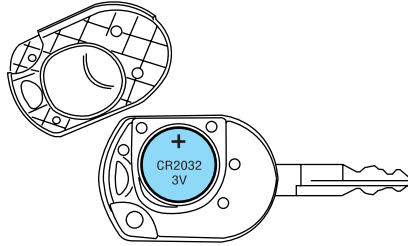

2. Do not wipe off any grease on the battery terminals on the back surface of the circuit board.

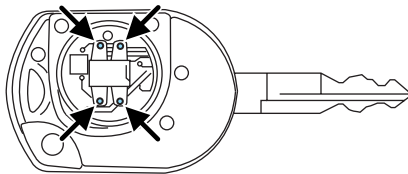

3. Remove the old battery. **Note:** Please refer to local regulations when disposing of transmitter batteries.
4. Insert the new battery. Refer to the instructions inside the IKT for the correct orientation of the battery. Press the battery down to ensure that the battery is fully seated in the battery housing cavity.
5. Snap the battery cover back onto the key.

Note: Replacement of the battery will **not** cause the IKT to become deprogrammed from your vehicle. The IKT should operate normally after battery replacement.

Replacing lost Integrated Keyhead Transmitters (IKTs)

If you would like to have your Integrated Keyhead Transmitters reprogrammed because you lost one, or would like to buy additional IKTs, you can either reprogram them yourself, or take **all IKTs** to your authorized dealer for reprogramming.

How to reprogram your Integrated Keyhead Transmitters (IKTs)

To program a new Integrated Keyhead Transmitter yourself, refer to *Programming spare keys* in the *SecuriLock™ passive anti-theft* section of this chapter. **Note:** At least two IKTs are required to perform this procedure yourself.

Locks and Security

Illuminated entry

The interior lamps and puddle lamps (if equipped) illuminate when the Integrated Keyhead Transmitter or the keyless entry system keypad is used to unlock the door(s).

The illuminated entry system will turn off the interior lights if:

- the ignition is turned to the on position, or
- the Integrated Keyhead Transmitter lock control is pressed, or
- the vehicle is locked using the keyless entry keypad (if equipped), or
- after 25 seconds of illumination.

The inside lights will not turn off if:

- they have been turned on with the dimmer control, or
- any door is open.

Illuminated exit

- The interior lights will illuminate when the key is removed from the ignition.

The lamps automatically turn off after 25 seconds. The dome and cargo lamp controls must **not** be set to the off position for the illuminated exit system to operate.

Perimeter lamps illuminated entry

With the Integrated Keyhead Transmitter system, the following items will illuminate when the  (unlock) control on the transmitter is pressed:

- Head lamps
- Park lamps
- Tail lamps

The lamps will automatically turn off:

- if the ignition switch is turned to the on position, or
- the IKT  control is pressed, or
- after 25 seconds of illumination.

Note: On some vehicles, the perimeter lamps illuminated entry feature will not activate in daylight conditions.

Deactivating/activating perimeter lamps illuminated entry

You may enable/disable this feature by having your vehicle serviced by your authorized dealer.

Locks and Security

You may also perform the following power door lock sequence to enable/disable the perimeter lamps feature. **Note:** Before starting, ensure the ignition is in the 1 (off) position and all vehicle doors are closed. You must complete Steps 1–5 within 30 seconds or the procedure will have to be repeated. If the procedure needs to be repeated, wait a minimum of 30 seconds before beginning again.

1. The ignition must be off to begin the sequence.
2. Place the key in the ignition and turn the ignition to the 3 (on) position.
3. Press the power door unlock control on the door panel three times.
4. Turn the ignition from the 3 (on) position to the 1 (off) position.
5. Press the power door unlock control on the door panel three times.
6. Turn the ignition back to the 3 (on) position. The horn will chirp one time to confirm programming mode has been entered and is active.
7. Press the power door unlock control twice within five seconds.
Note: The horn will chirp once to indicate the perimeter lighting feature has been deactivated. The horn will chirp once and honk once (one short and one long) to indicate the perimeter lighting feature has been activated.
8. Turn the ignition to the 1 (off) position to exit the procedure.
Note: The horn will chirp once to confirm the procedure is complete.

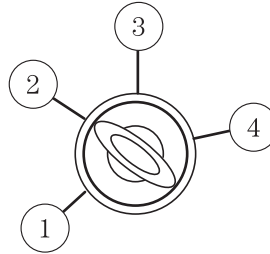

SECURILOCK™ PASSIVE ANTI-THEFT SYSTEM

SecuriLock™ passive anti-theft system is an engine immobilization system. This system is designed to help prevent the engine from being started unless a **coded Integrated Keyhead Transmitter (IKT) programmed to your vehicle** is used. The use of the wrong type of coded key may lead to a “no-start” condition.

Locks and Security

Your vehicle comes with two coded Integrated Keyhead Transmitters; additional coded IKTs may be purchased from your authorized dealer. Standard SecuriLock™ keys without remote entry transmitter functionality can also be purchased from your authorized dealer if desired. The authorized dealer can program your spare IKTs to your vehicle or you can program the IKTs yourself. Refer to *Programming spare keys* for instructions on how to program the coded key.

Note: The SecuriLock™ passive anti-theft system is not compatible with non-Mazda aftermarket remote start systems. Use of these systems may result in vehicle starting problems and a loss of security protection.

Note: Large metallic objects, electronic devices that are used to purchase gasoline or similar items, or a second coded key on the same key chain may cause vehicle starting issues. You need to prevent these objects from touching the coded IKT while starting the engine. These objects will not cause damage to the coded IKT, but may cause a momentary issue if they are too close to the IKT when starting the engine. If a problem occurs, turn the ignition off, remove all objects on the key chain away from the coded IKT and restart the engine.

Note: Do not leave a duplicate coded key in the vehicle. Always take your keys and lock all doors when leaving the vehicle.

Anti-theft indicator

The anti-theft indicator is located in the instrument panel cluster.

- When the ignition is in the off position, the indicator will flash once every two seconds to indicate the SecuriLock™ system is functioning as a theft deterrent.
- When the ignition is in the on position, the indicator will glow for three seconds to indicate normal system functionality.



If a problem occurs with the SecuriLock™ system, the indicator will flash rapidly or glow steadily when the ignition is in the on position. If this occurs, the vehicle will not start and should be taken to an authorized dealer for service.

Locks and Security

Automatic arming

The vehicle is armed immediately after switching the ignition to the off position.

The theft indicator will flash every two seconds to act as a theft deterrent when the vehicle is armed.



Automatic disarming

The vehicle is disarmed immediately after the ignition is turned to the on position.

The theft indicator will illuminate for three seconds and then go out. If the theft indicator stays on for an extended period of time or flashes rapidly, have the system serviced by your authorized dealer.

Replacement Integrated Keyless Transmitters (IKT) and coded keys

Note: Your vehicle comes equipped with two Integrated Keyhead Transmitters (IKTs). The IKT functions as both a programmed ignition key that operates all the locks and starts the vehicle, as well as a remote keyless entry transmitter. A maximum of eight coded keys can be programmed to your vehicle; only four of these eight keys can be IKTs with remote entry functionality.

If your IKTs or standard SecuriLock™ coded keys are lost or stolen and you don't have an extra coded key, you will need to have your vehicle towed to an authorized dealer. The key codes need to be erased from your vehicle and new coded keys will need to be programmed.

Replacing coded keys can be very costly. Store an extra programmed key away from the vehicle in a safe place to help prevent any inconveniences. Please visit an authorized dealer to purchase additional spare or replacement keys.

Programming spare keys

You can program your own Integrated Keyhead Transmitters or standard SecuriLock™ coded keys to your vehicle. This procedure will program both the engine immobilizer keycode and the remote entry transmitter portion of the IKT to your vehicle. **Note:** A maximum of eight coded keys can be programmed to your vehicle; only four of these eight can be IKTs with remote entry functionality.

Locks and Security

Tips:

- Only use Integrated Keyhead Transmitters (IKTs) or standard SecuriLock™ keys.
- You must have two previously programmed coded keys (keys that already operate your vehicle's engine) and the new unprogrammed key(s) readily accessible.
- If two previously programmed coded keys are not available, you must take your vehicle to your authorized dealer to have the spare key(s) programmed.

Please read and understand the entire procedure before you begin.

1. Insert the first previously programmed **coded key** into the ignition.
2. Turn the ignition from the 1 (off) position to the 3 (on) position. Keep the ignition in the 3 (on) position for at least three seconds, but no more than 10 seconds.
3. Turn the ignition to the 1 (off) position and remove the first **coded key** from the ignition.
4. Within 10 seconds of turning the ignition to the 1 (off) position, insert the second previously **coded key** into the ignition.
5. Turn the ignition from the 1 (off) position to the 3 (on) position. Keep the ignition in the 3 (on) position for at least three seconds, but no more than 10 seconds.
6. Turn the ignition to the 1 (off) position and remove the second previously programmed **coded key** from the ignition.
7. Within 20 seconds of turning the ignition to the 1 (off) position and removing the previously programmed **coded key**, insert the new unprogrammed key (new key/valet key) into the ignition.
8. Turn the ignition from the 1 (off) position to the 3 (on) position. Keep the ignition in the 3 (on) position for at least six seconds.
9. Remove the newly programmed **coded key** from the ignition.

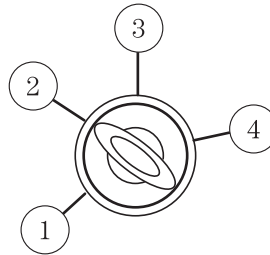

Locks and Security

If the key has been successfully programmed it will start the vehicle's engine and will operate the remote entry system (if the new key is an Integrated Keyhead Transmitter). The theft indicator light will illuminate for three seconds and then go out to indicate successful programming.

If the key was not successfully programmed, it will not start your vehicle's engine and/or will not operate the remote entry features. The theft indicator light may flash on and off. Wait 20 seconds and you may repeat Steps 1 through 8. If failure repeats, bring your vehicle to your authorized dealer to have the new key(s) programmed.

To program additional new unprogrammed key(s), wait 20 seconds and then repeat this procedure from Step 1.

Seating and Safety Restraints

FRONT SEATS

Notes:



WARNING: Reclining the seatback can cause an occupant to slide under the seat's seat belt, resulting in severe personal injuries in the event of a collision.



WARNING: Do not pile cargo higher than the seatbacks to reduce the risk of injury in a collision or sudden stop.



WARNING: Before returning the seatback to its original position, make sure that cargo or any objects are not trapped behind the seatback. After returning the seatback to its original position, pull on the seatback to ensure that it has fully latched. An unlatched seat may become dangerous in the event of a sudden stop or collision.

Adjustable head restraints

Your vehicle is equipped with front row outboard head restraints that are vertically adjustable.



WARNING: To minimize the risk of neck injury in the event of a crash, the driver and passenger occupants should not sit in and/or operate the vehicle, until the head restraint is placed in its proper position. The driver should never adjust the head restraint while the vehicle is in motion.

The adjustable head restraints consist of :

- a trimmed energy absorbing foam and structure (1),
- two steel stems (2),
- a guide sleeve adjust/release button (3),
- and a guide sleeve unlock/remove button (4).

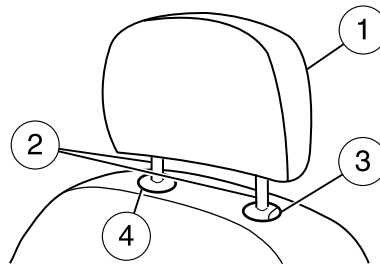

Seating and Safety Restraints

To adjust the head restraint, do the following:

1. Adjust the seatback to an upright driving/riding position.
2. Raise the head restraint by pulling up on the head restraint.

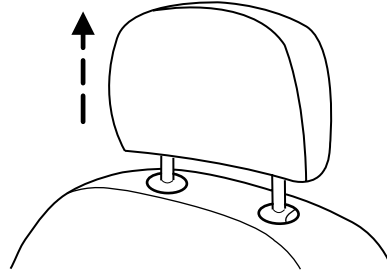

3. Lower the head restraint by pressing and holding the guide sleeve adjust/release button and pushing down on the head restraint.

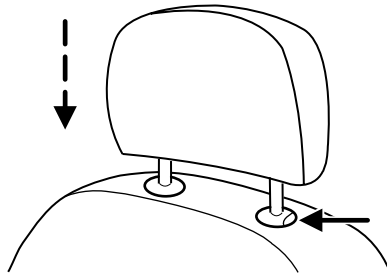

Properly adjust the head restraint so that the top of the head restraint is even with the top of your head and positioned as close as possible to the back of your head. For occupants of extremely tall stature, adjust the head restraint to its full up position.



WARNING: The adjustable head restraint is a safety device. Whenever possible it should be installed and properly adjusted when the seat is occupied.

Seating and Safety Restraints

To remove the adjustable head restraint, do the following:

1. Pull up the head restraint until it reaches the highest adjustment position.

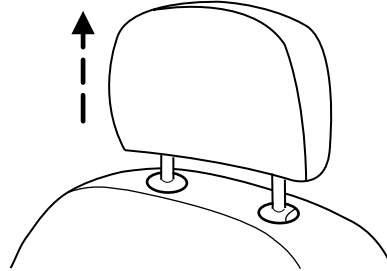

2. Simultaneously press and hold both the adjust/release button and the unlock/remove button, then pull up on the head restraint.

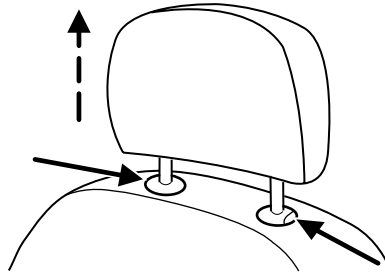

To reinstall the adjustable head restraint, do the following:

1. Insert the two stems into the guide sleeve collars.
2. Push the head restraint down until it locks.

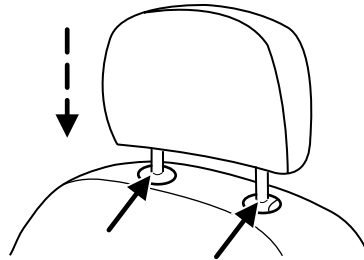

Properly adjust the head restraint so that the top of the head restraint is even with the top of your head and positioned as close as possible to the back of your head. For occupants of extremely tall stature, adjust the head restraint to its full up position.

Seating and Safety Restraints



WARNING: To minimize the risk of neck injury in the event of a crash, head restraints must be installed properly.

Adjusting the front manual seat (if equipped)

Lift handle to move seat forward or backward.

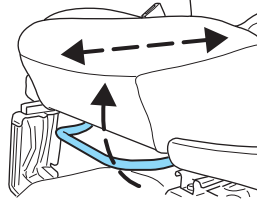

Pull lever up to adjust seatback.

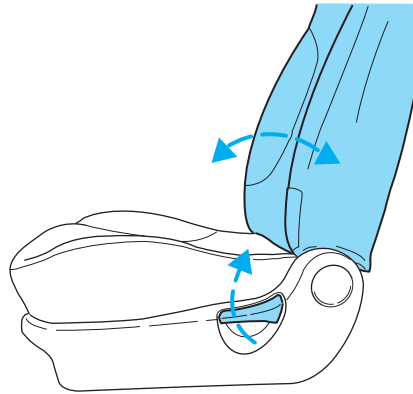

Adjusting the front power seat (if equipped)





WARNING: Never adjust the driver's seat or seatback when the vehicle is moving. You could move out of position to control the vehicle. Then a serious accident could occur. Sudden braking or a collision could cause serious injury. Adjust the seat only when the vehicle is stopped.





WARNING: Do not pile cargo higher than the seatbacks to reduce the risk of injuring people in a collision or sudden stop.

Seating and Safety Restraints

 **WARNING:** Always drive and ride with your seatback upright and the lap belt snug and low across the hips and the shoulder belt snug across the chest.

 **WARNING:** Sitting in a reclined position while the vehicle is moving is dangerous because you don't get the full protection from seat belts. During sudden braking or a collision, you can slide under the lap belt and suffer serious internal injury, or in a rear end collision you could fly up and out of the vehicle. For maximum protection, sit well back and upright.

 **WARNING:** Sitting improperly out of position or with the seat back reclined too far can take off weight from the seat cushion and affect the decision of the passenger sensing system, resulting in serious injury or death in a crash. Always sit upright against your seatback, with your feet on the floor.

 **WARNING:** To reduce the risk of possible serious injury: Do not hang objects off seat back or stow objects in the seatback map pocket (if equipped) when a child is in the front passenger seat. Do not place objects underneath the front passenger seat or between the seat and the center console (if equipped). Check the "passenger airbag off" or "pass airbag off" indicator lamp for proper airbag status. Refer to **Front passenger sensing system section for additional details. Failure to follow these instructions may interfere with the front passenger seat sensing system.**

The control is located on the outboard side of the seat cushion.

Move the front of the control up or down to raise or lower the front portion of the seat cushion.

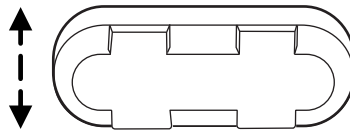

Seating and Safety Restraints

Move the rear of the control up or down to raise or lower the rear portion of the seat cushion.

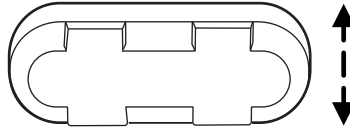

Move the control in the directions shown to move the seat forward, backward, up or down.

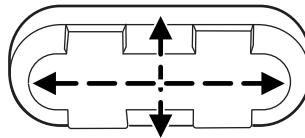

Heated seats (if equipped)



WARNING: Persons who are unable to feel pain to the skin because of advanced age, chronic illness, diabetes, spinal cord injury, medication, alcohol use, exhaustion, or other physical conditions, must exercise care when using the seat heater. The seat heater may cause burns even at low temperatures, especially if used for long periods of time. Do not place anything on the seat that insulates against heat, such as a blanket or cushion, because this may cause the seat heater to overheat. Do not puncture the seat with pins, needles, or other pointed objects because this may damage the heating element which may cause the seat heater to overheat. An overheated seat may cause serious personal injury.

Note: Do not do the following:

- Place heavy objects on the seat
- Operate the seat heater if water or any other liquid is spilled on the seat. Allow the seat to dry thoroughly.

Seating and Safety Restraints

To operate the heated seats:

- Push the button located on the instrument panel to activate.
- Push again to deactivate.



The heated seats will activate when the ignition is in the on position.

REAR SEATS

Head restraints

The purpose of these head restraints is to help limit head motion in the event of a rear collision. To properly adjust your head restraints, lift the head restraint so that it is located directly behind your head or as close to that position as possible.

The head restraints can be moved up and down. Lift the head restraint so that it is located directly or as close as possible behind your head.

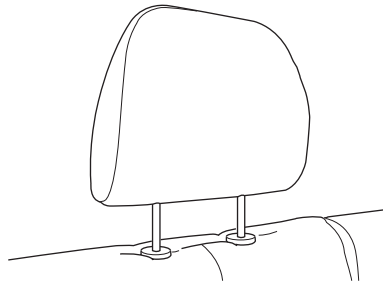

Push control to lower or remove head restraint.

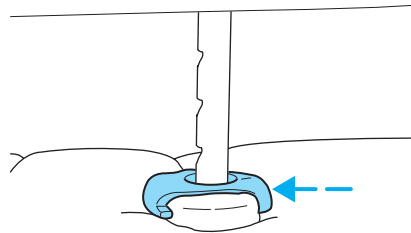

Seating and Safety Restraints

Folding down rear seats

1. Raise the rear seat head restraint and remove.

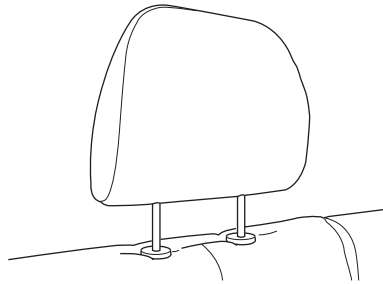

2. Place the head restraint under the front seat for storage.

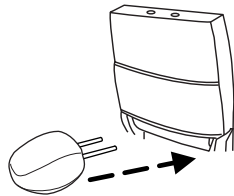

3. Pull the seat release control.

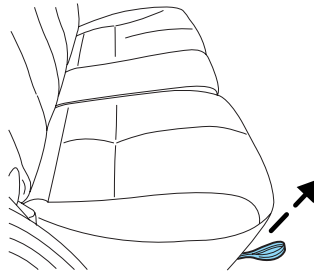

Note: Make sure the floor is clear of all objects before folding the seat.

Seating and Safety Restraints

4. Flip seat forward.

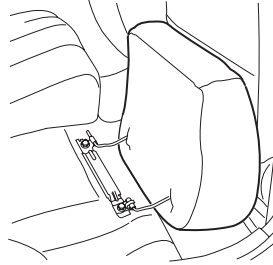

Attach the seat belt web snap button to the quarter trim panel snap button. This will ensure that seat belt does not get caught by staying out of the seat back folding path.

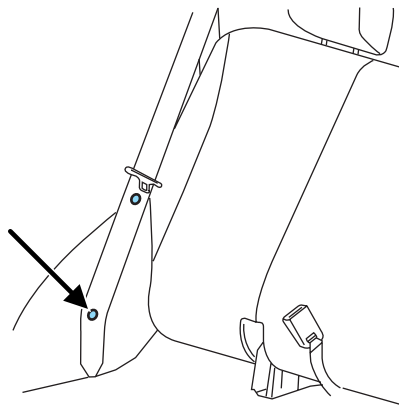

5. To release seatback, pull the seatback release lever (on top of seat) toward the front seat. This is common for both 60% and 40% seatbacks.

Note: When the seatback release lever is pulled, slowly lower seatback to the flat position.

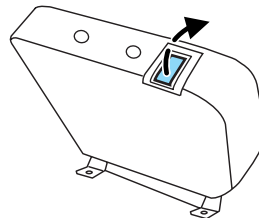

Seating and Safety Restraints

6. Rotate seatback down into load floor position.

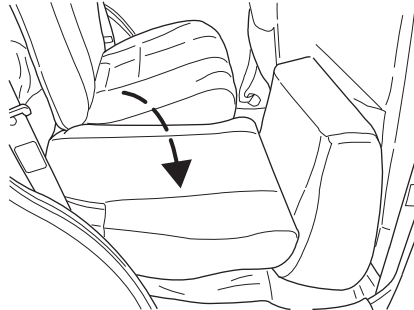

Returning the rear seats to upright position

1. Pull seatback up and into upright position making sure seatback locks into place and the red seat unlatched indicator on release paddle is not visible.

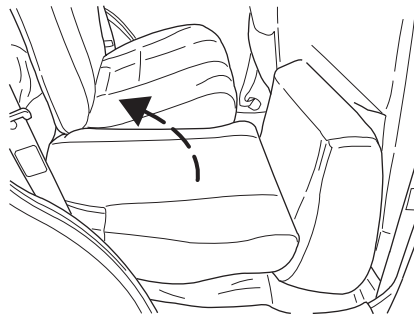

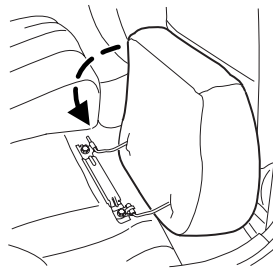

2. Rotate seat cushion down into the seating position making sure that the seat cushion is locked into place and that the seat belt buckles are exposed.



Seating and Safety Restraints

 **WARNING:** Make sure seat belt buckle heads are through elastic holders on seat backs. Seat belt buckles may break if they are trapped underneath the seatback as the seatback is rotated down.

 **WARNING:** Before returning the seatback to its original position, make sure that cargo or any objects are not trapped behind the seatback. After returning the seatback to its original position, reinstall the head restraints, and pull on the seatback to ensure that it has fully latched. An unlatched seat may become dangerous in the event of a sudden stop or collision.

 **WARNING:** Remove the head restraint stored under the front set and return it to the original position on the seatback. Failure to do so could result in personal injury.

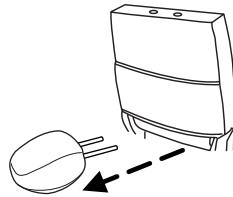

3. Unsnap the seat belt webbing from the quarter trim panel.

To remove the rear cushion

1. Lift the yellow tab to release the hinges.
2. Pull the cushion to the outboard side of the vehicle.

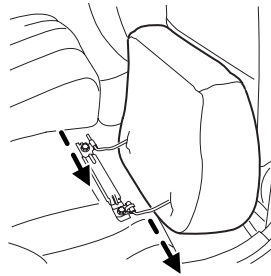

Seating and Safety Restraints

To install the rear cushion

1. Push the cushion to the inboard side of the vehicle.
2. Make sure that the hinges are locked into place.

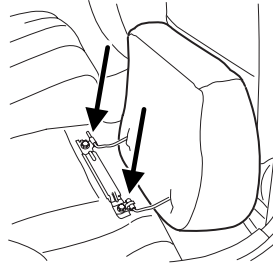

SAFETY RESTRAINTS

Personal Safety System®

The Personal Safety System® provides an improved overall level of frontal crash protection to front seat occupants and is designed to help further reduce the risk of airbag-related injuries. The system is able to analyze different occupant conditions and crash severity before activating the appropriate safety devices to help better protect a range of occupants in a variety of frontal crash situations.

Your vehicle's Personal Safety System® consists of:

- Driver and passenger dual-stage airbag supplemental restraints
- Front seat belts with pretensioners, energy management retractors, and seat belt usage sensors
- Front passenger sensing system
- "Passenger airbag off" or "pass airbag off" indicator lamp
- Front crash severity sensor
- Restraints Control Module (RCM) with impact and safing sensors
- Driver's seat position sensor
- Restraint system warning light and back-up tone
- The electrical wiring for the airbags, crash sensor(s), seat belt pretensioners, front seat belt usage sensors, driver seat position sensor, front passenger sensing system, and indicator lights

Seating and Safety Restraints

How does the Personal Safety System® work?

The Personal Safety System® can adapt the deployment strategy of your vehicle's safety devices according to crash severity and occupant conditions. A collection of crash and occupant sensors provides information to the Restraints control module (RCM). During a crash, the RCM may activate the seat belt pretensioners and/or both stages of the dual-stage airbag supplemental restraints based on crash severity and occupant conditions.

The fact that the pretensioners or airbags did not activate for both front seat occupants in a collision does not mean that something is wrong with the system. Rather, it means the Personal Safety System® determined the accident conditions (crash severity, belt usage, etc.) were not appropriate to activate these safety devices. Front airbags are designed to activate only in frontal and near-frontal collisions, not rollovers, side-impacts, or rear-impacts unless the collision causes sufficient longitudinal deceleration.

Dual-stage airbag supplemental restraints

The dual-stage airbag offers the capability to tailor the level of airbag inflation energy. A lower, less forceful energy level is provided for more common, moderate-severity impacts. A higher energy level is used for the most severe impacts. Refer to *Airbag supplemental restraints* section in this chapter.

Front crash severity sensor

The front crash severity sensor enhances the ability to detect the severity of an impact. Positioned up front, it provides valuable information early in the crash event on the severity of the impact. This allows your Safety System to distinguish between different levels of crash severity and modify the deployment strategy of the dual-stage airbag and seat belt pretensioners.

Driver's seat position sensor

The driver's seat position sensor allows your Safety System to tailor the deployment level of the driver airbag based on seat position. The system is designed to help protect smaller drivers sitting close to the driver airbag by providing a lower airbag output level.

Seating and Safety Restraints

Front passenger sensing system

For airbags to do their job they must inflate with great force, and this force can pose a potentially deadly risk to occupants that are very close to the airbag when it begins to inflate. For some occupants, like infants in rear-facing child seats, this occurs because they are initially sitting very close to the airbag. For other occupants, this occurs when the occupant is not properly restrained by seat belts or child safety seats and they move forward during pre-crash braking. The most effective way to reduce the risk of unnecessary injuries is to make sure all occupants are properly restrained. Accident statistics suggest that children are much safer when properly restrained in the rear seating positions than in the front.



WARNING: Airbags can kill or injure a child in a child seat. NEVER place a rear-facing child seat in front of an active airbag. If you must use a forward-facing child seat in the front seat, move the seat all the way back.



WARNING: Always transport children 12 years old and under in the back seat and always properly use appropriate child restraints.

The front passenger sensing system can automatically turn off the passenger front airbag. The system is designed to help protect small (child size) occupants from airbag deployments when they are improperly seated or restrained in the front passenger seat contrary to proper child-seating or restraint usage recommendations. Even with this technology, parents are **STRONGLY** encouraged to always properly restrain children in the rear seat. The sensor also turns off the passenger front airbag and seat-mounted side airbag (if equipped) when the passenger seat is empty to prevent unnecessary replacement of airbag(s) after a collision.

When the front passenger seat is occupied and the sensing system has turned off the passenger's frontal airbag, the "pass airbag off" indicator will light and stay lit to remind you that the front passenger frontal airbag is off. See *Front passenger sensing system* in the airbags section of this chapter.

Seating and Safety Restraints

Front seat belt usage sensors

The front seat belt usage sensors detect whether or not the driver and front outboard passenger seat belts are fastened. This information allows your Safety System to tailor the airbag deployment and seat belt pretensioner activation depending upon seat belt usage. Refer to *Seat belt* section in this chapter.

Front seat belt pretensioners

The seat belt pretensioners at the front outboard seating positions are designed to tighten the seat belts firmly against the occupant's body during frontal collisions, and in side collisions and rollovers when the vehicle is equipped with the Safety Canopy® system. This helps increase the effectiveness of the seat belts. In frontal collisions, the seat belt pretensioners can be activated alone or, if the collision is of sufficient severity, together with the front airbags.

Seat belt energy management retractors

The front and rear outboard seat belt energy management retractors, once initiated, allow webbing to be pulled out of the retractor in a gradual and controlled manner in response to the occupant's forward momentum. This helps reduce the risk of force-related injuries to the occupant's chest by limiting the load on the occupant. Refer to *Energy management feature* section in this chapter.

Determining if the Personal Safety System® is operational

The Safety System uses a warning light in the instrument cluster or a back-up tone to indicate the condition of the system. Refer to the *Warning lights and chimes* section in the *Instrument Cluster* chapter. Routine maintenance of the Safety System is not required.

The Restraints control module (RCM) monitors its own internal circuits and the circuits for the airbag supplemental restraints, crash sensor(s), seat belt pretensioners, front seat belt buckle sensors, driver seat position sensor, and front passenger sensing system. In addition, the RCM also monitors the restraints warning light in the instrument cluster. A difficulty with the system is indicated by one or more of the following.

- The warning light will either flash or stay lit.
- The warning light will not illuminate immediately after ignition is turned on.
- A series of five beeps will be heard. The tone pattern will repeat periodically until the problem and warning light are repaired.

If any of these things happen, even intermittently, have the Safety System serviced at an authorized dealer immediately. Unless serviced, the system may not function properly in the event of a collision.

Seating and Safety Restraints

Safety restraints precautions



WARNING: Always drive and ride with your seatback upright and the lap belt snug and low across the hips and the shoulder belt snug across the chest.



WARNING: To reduce the risk of injury, make sure children sit where they can be properly restrained.



WARNING: Never let a passenger hold a child on his or her lap while the vehicle is moving. The passenger cannot protect the child from injury in a collision.



WARNING: All occupants of the vehicle, including the driver, should always properly wear their seat belts, even when an air bag supplemental restraint system (SRS) is provided.



WARNING: It is extremely dangerous to ride in a cargo area, inside or outside of a vehicle. In a collision, people riding in these areas are more likely to be seriously injured or killed. Do not allow people to ride in any area of your vehicle that is not equipped with seats and seat belts. Be sure everyone in your vehicle is in a seat and using a seat belt properly.



WARNING: In a rollover crash, an unbelted person is significantly more likely to die or be seriously injured than a person wearing a seat belt.



WARNING: Each seating position in your vehicle has a specific seat belt assembly which is made up of one buckle and one tongue that are designed to be used as a pair. 1) Use the shoulder belt on the outside shoulder only. Never wear the shoulder belt under the arm. 2) Never swing the seat belt around your neck over the inside shoulder. 3) Never use a single belt for more than one person.

Seating and Safety Restraints

⚠ WARNING: Placing a child, 12 years or younger, in the front seat is dangerous. The child could be hit by a deploying airbag and be seriously injured or even killed. A sleeping child is more likely to lean against the door and be hit by the side airbag (if equipped) in a moderate collision. Whenever possible, always secure a child, 12 years or younger, in the rear seat, with an appropriate child restraint system for the child's age and size. Never use a rear-facing child restraint system in the front seat with an airbag that could deploy.

⚠ WARNING: Front and rear seat occupants, including pregnant women, should wear seat belts for optimum protection in an accident.

Combination lap and shoulder belts

1. Insert the belt tongue into the proper buckle (the buckle closest to the direction the tongue is coming from) until you hear a snap and feel it latch. Make sure the tongue is securely fastened in the buckle.

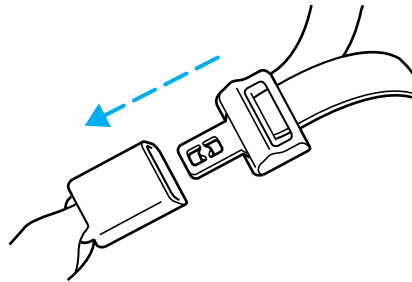

2. To unfasten, push the release button and remove the tongue from the buckle.

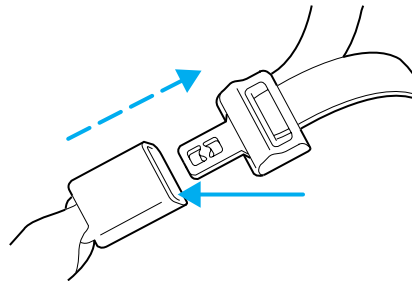

Energy Management Feature

- This vehicle has a seat belt system with an energy management feature at the front and rear outboard seating positions to help further reduce the risk of injury in the event of a head-on collision.

Seating and Safety Restraints

- The front and rear outboard seat belt system has a retractor assembly that is designed to extend the seat belt webbing in a controlled manner. This helps reduce the belt force acting on the user's chest.

All seat belts in the vehicle are combination lap and shoulder belts. The passenger seat belts have two types of locking modes described below:

Vehicle sensitive mode

This is the normal retractor mode, which allows free shoulder belt length adjustment to your movements and locking in response to vehicle movement. For example, if the driver brakes suddenly or turns a corner sharply, or the vehicle receives an impact of approximately 5 mph (8 km/h) or more, the combination seat belts will lock to help reduce forward movement of the driver and passengers.

Automatic locking mode

When to use the automatic locking mode

In this mode, the shoulder belt is automatically pre-locked. The belt will still retract to remove any slack in the shoulder belt. The automatic locking mode is not available on the driver seat belt.

This mode should be used **any time** a child safety seat (other than a belt-positioning booster) is installed. Children 12 years old and under should be properly restrained in the rear seat whenever possible. Refer to *Safety restraints for children* or *Safety seats for children* later in this chapter.

How to use the automatic locking mode

- Buckle the combination lap and shoulder belt.

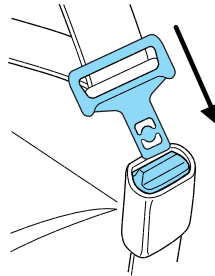

Seating and Safety Restraints

- Grasp the shoulder portion and pull downward until the entire belt is pulled out.



- Allow the belt to retract. As the belt retracts, you will hear a clicking sound. This indicates the seat belt is now in the automatic locking mode.

How to disengage the automatic locking mode

Disconnect the combination lap/shoulder belt and allow it to retract completely to disengage the automatic locking mode and activate the vehicle sensitive (emergency) locking mode.



WARNING: After a collision all seat belts should be checked for proper function. In addition, the automatic locking retractor function in all but the driver's seat must be checked by an authorized dealer to confirm the child restraint system functions properly.



WARNING: BELT AND RETRACTOR ASSEMBLY MUST BE REPLACED if the seat belt assembly "automatic locking retractor" feature or any other seat belt function is not operating properly when checked by an authorized dealer. Failure to replace the Belt and Retractor assembly could increase the risk of injury in collisions. The pretensioners in the front seats deploy with a related airbag and will only operate once and must be replaced to provide appropriate restraint in any future accident.

Seating and Safety Restraints

Seat belt height adjustment

Your vehicle has seat belt height adjustments at the front outboard seating positions. Adjust the height of the shoulder belt so the belt rests across the middle of your shoulder.

To adjust the shoulder belt height, squeeze and hold the buttons on the side and slide the height adjuster up or down. Release the buttons and pull down on the height adjuster to make sure it is locked in place.

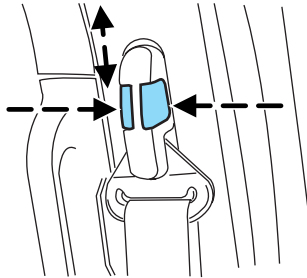

WARNING: Position the seat belt height adjusters so that the belt rests across the middle of your shoulder. Failure to adjust the seat belt properly could reduce the effectiveness of the seat belt and increase the risk of injury in a collision.

Seat belt pretensioner

Your vehicle is equipped with seat belt pretensioners at the driver and front passenger seating positions.

The seat belt pretensioners activate during frontal collisions, and in side collisions and rollovers. A seat belt pretensioner is a device which tightens the webbing of the lap and shoulder belts in such a way that they fit more snugly against the body.



WARNING: The driver and front passenger seat belt system (including retractors, buckles and height adjusters) must be replaced if the vehicle is involved in a collision that results in deployment of front airbags, seat-mounted side airbags and Safety Canopy®, and seat belt pretensioners.



WARNING: Failure to replace the seat belt assembly under the above conditions could result in severe personal injuries in the event of a collision.

Seating and Safety Restraints

Seat belt extension assembly

If the seat belt is too short when fully extended, a 9 inch (23 cm) or 12 inch (31 cm) seat belt extension assembly can be added (part numbers 611C22-A and 611C22-B respectively). Seat belt extension assemblies can be obtained from your authorized Mazda dealership.

Use only extensions manufactured by the same supplier as the seat belt. Manufacturer identification is located at the end of the webbing on the label. Also, use the seat belt extension only if the seat belt is too short for you when fully extended.

When you are not using the extensions store them in another location so that no one will accidentally use them.

NOTE: Do not use extensions to change the fit of the shoulder belt across the torso.

Seat belt warning light and indicator chime

The seat belt warning light illuminates in the instrument cluster and a chime sounds to remind the occupants to fasten their seat belts.

Conditions of operation

If...	Then...
The driver's seat belt is not buckled before the ignition switch is turned to the on position...	The seat belt warning light illuminates 1 minute and the warning chime sounds 6 seconds.
The driver's seat belt is buckled while the indicator light is illuminated and the warning chime is sounding...	The seat belt warning light and warning chime turn off.
The driver's seat belt is buckled before the ignition switch is turned to the on position...	The seat belt warning light and indicator chime remain off.

Belt-Minder®

The Belt-Minder® feature is a supplemental warning to the seat belt warning function. This feature provides additional reminders by intermittently sounding a chime and illuminating the seat belt warning lamp in the instrument cluster when the driver's and front passenger's seat belt is unbuckled.

Seating and Safety Restraints

The Belt-Minder® feature uses information from the front passenger sensing system to determine if a front seat passenger is present and therefore potentially in need of a warning. To avoid activating the Belt-Minder® feature for objects placed in the front passenger seat, warnings will only be given to large front seat occupants as determined by the front passenger sensing system.

Both the driver's and passenger's seat belt usages are monitored and either may activate the Belt-Minder® feature. The warnings are the same for the driver and the front passenger. If the Belt-Minder® warnings have expired (warnings for approximately 5 minutes) for one occupant (driver or front passenger), the other occupant can still activate the Belt-Minder® feature.

If...	Then...
The driver's and front passenger's seat belts are buckled before the ignition switch is turned to the on position or less than 1-2 minutes have elapsed since the ignition switch has been turned to on...	The Belt-Minder® feature will not activate.
The driver's or front passenger's seat belt is not buckled when the vehicle has reached at least 3 mph (5 km/h) and 1-2 minutes have elapsed since the ignition switch has been turned to on...	The Belt-Minder® feature is activated - the seat belt warning light illuminates and the warning chime sounds for 6 seconds every 30 seconds, repeating for approximately 5 minutes or until the seat belts are buckled.
The driver's or front passenger's seat belt becomes unbuckled for approximately 1 minute while the vehicle is traveling at least 3 mph (5 km/h) and more than 1-2 minutes have elapsed since the ignition switch has been turned to on...	The Belt-Minder® feature is activated - the seat belt warning light illuminates and the warning chime sounds for 6 seconds every 30 seconds, repeating for approximately 5 minutes or until the seat belts are buckled.

Seating and Safety Restraints

The following are reasons most often given for not wearing seat belts
(All statistics based on U.S. data):

Reasons given...	Consider...
"Crashes are rare events"	36,700 crashes occur every day. The more we drive, the more we are exposed to "rare" events, even for good drivers. <i>1 in 4 of us will be seriously injured in a crash during our lifetime.</i>
"I'm not going far"	3 of 4 fatal crashes occur within 25 miles of home.
"Belts are uncomfortable"	Seat belts are designed to enhance comfort. If you are uncomfortable - try different positions for the seat belt upper anchorage and seatback which should be as upright as possible; this can improve comfort.
"I was in a hurry"	Prime time for an accident. Seat Belt Warning Chime reminds us to take a few seconds to buckle up.
"Seat belts don't work"	Seat belts , when used properly, reduce risk of death to front seat occupants by 45% in cars , and by 60% in light trucks .
"Traffic is light"	Nearly 1 of 2 deaths occur in single-vehicle crashes , many when no other vehicles are around.
"Belts wrinkle my clothes"	Possibly, but a serious crash can do much more than wrinkle your clothes, particularly if you are unbelted.
"The people I'm with don't wear belts"	Set the example, teen deaths occur 4 times more often in vehicles with TWO or MORE people. Children and younger brothers/sisters imitate behavior they see.

Seating and Safety Restraints

Reasons given...	Consider...
"I have an airbag"	Airbags offer greater protection when used with seat belts. Frontal airbags are not designed to inflate in rear and side crashes or rollovers.
"I'd rather be thrown clear"	Not a good idea. People who are ejected are 40 times more likely to DIE. Seat belts help prevent ejection, WE CAN'T "PICK OUR CRASH".



WARNING: Do not sit on top of a buckled seat belt or insert a latchplate into the buckle to avoid the Belt-Minder® chime. To do so may adversely affect the performance of the vehicle's air bag system and result in serious injury, ejection and death.

One-time disable

If at any time the driver/front passenger quickly buckles then unbuckles the seat belt for that seating position, the Belt-Minder® is disabled for the current ignition cycle. The Belt-Minder® feature will enable during the same ignition cycle if the occupant buckles and remains buckled for approximately 30 seconds. Confirmation is not given for the one time disable.

Deactivating/activating the Belt-Minder® feature

The driver and front passenger Belt-Minder® are deactivated/activated independently. When deactivating/activating one seating position, do not buckle the other position as this will terminate the process.

Read Steps 1 - 4 thoroughly before proceeding with the deactivation/activation programming procedure.

The driver and front passenger Belt-Minder® features can be deactivated/activated by performing the following procedure:

Before following the procedure, make sure that:

- The parking brake is set
- The gearshift is in P (Park)
- The ignition switch is in the off position
- The driver and front passenger seat belts are unbuckled

128

*2009 Tribute Hybrid (thv)
Owners Guide, 1st Printing
USA (fus)*

Seating and Safety Restraints



WARNING: While the design allows you to deactivate your Belt-Minder®, this system is designed to improve your chances of being safely belted and surviving an accident. We recommend you leave the Belt-Minder® system activated for yourself and others who may use the vehicle. To reduce the risk of injury, do not deactivate/activate the Belt-Minder® feature.

1. Turn the ignition switch to the on position. **DO NOT START THE ENGINE.**
2. Wait until the seat belt warning light turns off (Approximately 1 minute).
- Step 3 must be completed within 30 seconds after the seat belt warning light turns off.
3. For the seating position being disabled, at a moderate speed, buckle then unbuckle the seat belt three times, ending in the unbuckled state.
- After Step 3, the seat belt warning light will be turned on for three seconds.
4. Within approximately seven seconds of the light turning off, buckle then unbuckle the seat belt.
- This will disable the Belt-Minder® feature for that seating position if it is currently enabled. As confirmation, the seat belt warning light will flash four times per second for three seconds.
- This will enable the Belt-Minder® feature for that seating position if it is currently disabled. As confirmation, the seat belt warning light will flash four times per second for three seconds, followed by three seconds with the light off, then followed by the seat belt warning light flashing four times per second for three seconds again.
- After receiving confirmation, the deactivation/activation procedure is complete.

Seating and Safety Restraints

AIRBAG SUPPLEMENTAL RESTRAINT SYSTEM (SRS)

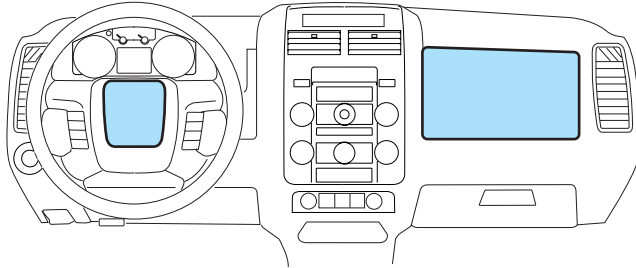

Important supplemental restraint system (SRS) precautions

The supplemental restraint system is designed to work with the seat belt to help protect the driver and right front passenger from certain upper body injuries.

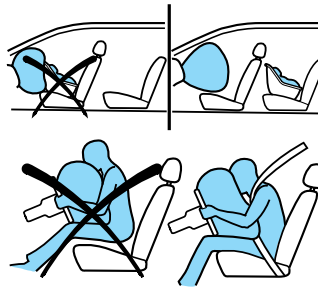

! WARNING: Airbags DO NOT inflate slowly or gently and the risk of injury from a deploying airbag is greatest close to the trim covering the airbag module.

! WARNING: All occupants of the vehicle, including the driver, should always properly wear their seat belts, even when an air bag supplemental restraint system (SRS) is provided.

! WARNING: When possible, all children 12 years old and under should be properly restrained in a rear seating position.

! WARNING: National Highway Traffic Safety Administration (NHTSA) recommends a minimum distance of at least 10 inches (25 cm) between an occupant's chest and the driver airbag module.

Seating and Safety Restraints

 **WARNING:** The driver should always hold onto only the rim of the steering wheel. Never place your arm over the airbag module or anywhere inside the rim as a deploying airbag can result in serious arm fractures or other injuries.

Steps you can take to properly position yourself away from the airbag:

- Move your seat to the rear as far as you can while still reaching the pedals comfortably.
- Recline the seat slightly (one or two notches) from the upright position.

 **WARNING:** Do not put anything on or over the airbag module including hands or feet. Placing objects on or over the airbag inflation area may cause those objects to be propelled by the airbag into your face and torso causing serious injury.

 **WARNING:** Do not attempt to service, repair, or modify the Airbag Supplemental Restraint Systems or its fuses. See your authorized Mazda dealership.

 **WARNING:** Modifications to the front end of the vehicle, including frame, bumper, front end body structure, tow hooks, and snow plows may affect the performance of the airbag sensors increasing the risk of injury. Do not modify the front end of the vehicle.

 **WARNING:** Additional equipment may affect the performance of the airbag sensors increasing the risk of injury. Consult your authorized Mazda dealership before installation of additional equipment.

Seating and Safety Restraints

Children and airbags

Children must always be properly restrained. Accident statistics suggest that children are safer when properly restrained in the rear seating positions than in the front seating position. Failure to follow these instructions may increase the risk of injury in a collision.

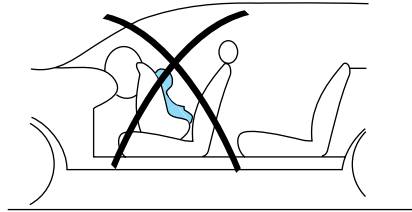

WARNING: Airbags can kill or injure a child in a child seat. NEVER place a rear-facing child seat in front of an active airbag. If you must use a forward-facing child seat in the front seat, move the seat all the way back.

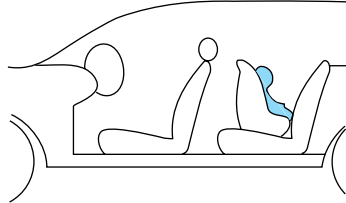

How does the airbag supplemental restraint system work?

The airbag SRS is designed to activate when the vehicle sustains a longitudinal deceleration sufficient to cause the airbag sensors to close an electrical circuit that initiates airbag inflation. The fact that the airbags did not inflate in a collision does not mean that something is wrong with the system. Rather, it means the forces were not sufficient enough to cause activation. Front airbags are designed to inflate in frontal and near-frontal collisions, not rollover, side-impact, or rear-impacts unless the collision causes sufficient longitudinal deceleration.

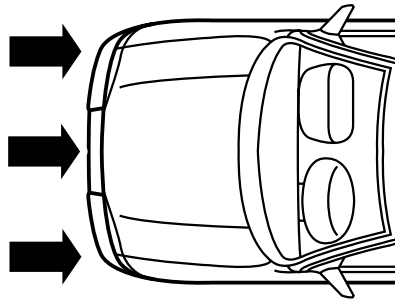

Seating and Safety Restraints

The airbags inflate and deflate rapidly upon activation. After airbag deployment, it is normal to notice a smoke-like, powdery residue or smell the burnt propellant. This may consist of cornstarch, talcum powder or sodium compounds which may irritate the skin and eyes, but none of the residue is toxic.



While the SRS is designed to help reduce serious injuries, contact with a deploying airbag may also cause abrasions, swelling or temporary hearing loss. Because airbags must inflate rapidly and with considerable force, there is the risk of death or serious injuries such as fractures, facial and eye injuries or internal injuries, particularly to occupants who are not properly restrained or are otherwise out of position at the time of airbag deployment. It is extremely important that occupants be properly restrained as far away from the airbag module as possible while maintaining vehicle control.

The SRS consists of:

- driver and passenger airbag modules (which include the inflators and airbags)
- one or more impact and safing sensors
- a readiness light and tone
- a diagnostic module
- and the electrical wiring which connects the components

The RCM (restraints control module) monitors its own internal circuits and the supplemental airbag electrical system wiring (including the impact sensors, the system wiring, the airbag system readiness light, the airbag back up power and the airbag ignitors).



WARNING: Several air bag system components get hot after inflation. Do not touch them after inflation.



WARNING: If the airbag has deployed, the airbag will not function again and must be replaced immediately. If the airbag is not replaced, the unrepaired area will increase the risk of injury in a collision.

Seating and Safety Restraints

Front passenger sensing system

The front passenger sensing system is designed to meet the regulatory requirements of Federal Motor Vehicle Safety Standard (FMVSS) 208 and is designed to disable (will not inflate) the front passenger's frontal airbag under certain conditions.

The front passenger sensing system works with sensors that are part of the front passenger's seat and seat belt. The sensors are designed to detect the presence of a properly seated occupant and determine if the front passenger's frontal airbag should be enabled (may inflate) or disabled (will not inflate).

The front passenger sensing system will disable (will not inflate) the front passenger's frontal airbag if:

- the front passenger seat is unoccupied, or has small/medium objects in the front seat,
- the system determines that an infant is present in a rear-facing infant seat that is installed according to the manufacturer's instructions,
- the system determines that a small child is present in a forward-facing child restraint that is installed according to the manufacturer's instructions,
- the system determines that a small child is present in a booster seat,
- a front passenger takes his/her weight off of the seat for a period of time,

For side airbag equipped vehicles, the front passenger sensing system will turn off the passenger seat side airbag if:

- the seat is empty and seat belt is unbuckled.
- a child or a small person occupies the front passenger seat and the child or small person is unbuckled.

The front passenger sensing system uses a "passenger airbag off" or "pass airbag off" indicator which will illuminate and stay lit to remind you that the front passenger frontal airbag is off. The indicator lamp is located in the center stack of the instrument panel just above the air vents.

A rectangular indicator lamp with rounded corners, containing the text "PASSENGER AIRBAG OFF" followed by a small blue circle with a white center.

Note: The indicator lamp will illuminate for a short period of time when the ignition is turned to the ON position to confirm it is functional.

When the front passenger seat is not occupied (empty seat) or in the event that the front passenger frontal airbag is enabled (may inflate), the indicator lamp will be unlit.

Seating and Safety Restraints

The front passenger sensing system is designed to disable (will not inflate) the front passenger's frontal airbag when a rear facing infant seat, a forward-facing child restraint, or a booster seat is detected.

- When the front passenger sensing system disables (will not inflate) the front passenger frontal airbag, the indicator lamp will illuminate and stay lit to remind you that the front passenger frontal airbag is disabled.
- If the child restraint has been installed and the indicator lamp is not lit, then turn the vehicle off, remove the child restraint from the vehicle and reinstall the restraint following the child restraint manufacturer's instructions.

The front passenger sensing system is designed to enable (may inflate) the front passenger's frontal airbag anytime the system senses that a person of adult size is sitting properly in the front passenger seat.

- When the front passenger sensing system enables the front passenger frontal airbag (may inflate), the indicator will be unlit and stay unlit.

If a person of adult size is sitting in the front passenger's seat, but the "passenger airbag off" or "pass airbag off" indicator lamp is lit, it is possible that the person isn't sitting properly in the seat. If this happens:

- Turn the vehicle off and ask the person to place the seatback in the full upright position.
- Have the person sit upright in the seat, centered on the seat cushion, with the person's legs comfortably extended.
- Restart the vehicle and have the person remain in this position for about two minutes. This will allow the system to detect that person and enable the passenger's frontal airbag.
- If the indicator lamp remains lit even after this, the person should be advised to ride in the rear seat, and the system should be taken promptly to an authorized dealer for repair before that seat is occupied again.

Seating and Safety Restraints

Occupant	Pass Airbag Off Indicator Lamp	Passenger Airbag
Empty seat	Unlit	Disabled
Small child in child safety seat or booster	Lit	Disabled
Small child with seat belt buckled or unbuckled	Lit	Disabled
Adult	Unlit	Enabled



WARNING: Even with Advanced Restraints Systems, children 12 and under should be properly restrained in the back seat.

After all occupants have adjusted their seats and put on seat belts, it's very important that they continue to sit properly. A properly seated occupant sits upright, leaning against the seat back, and centered on the seat cushion, with their feet comfortably extended on the floor. Sitting improperly can increase the chance of injury in a crash event. For example, if an occupant slouches, lies down, turns sideways, sits forward, leans forward or sideways, or puts one or both feet up, the chance of injury during a crash is greatly increased.



WARNING: Sitting improperly out of position or with the seat back reclined too far can take off weight from the seat cushion and affect the decision of the front passenger sensing system, resulting in serious injury or death in a crash. Always sit upright against your seatback, with your feet on the floor.

The front passenger sensing system may detect small or medium objects placed on the seat cushion. For most objects that are in the front passenger seat, the passenger airbag will be disabled. Even though the passenger airbag is disabled, the "pass airbag off" lamp may or may not be illuminated according to the table below.

Seating and Safety Restraints

Objects	Pass Airbag Off Indicator Lamp	Passenger Airbag
Small (i.e. three-ring binder, small purse, bottled water)	Unlit	Disabled
Medium (i.e. heavy briefcase, fully packed luggage)	Lit	Disabled
Empty seat, or small to medium object with seat belt buckled	Lit	Disabled

If you think that the status of the passenger airbag off indicator lamp is incorrect, check for the following:

- Objects lodged underneath the seat
- Objects between the seat cushion and the center console (if equipped)
- Objects hanging off the seat back
- Objects stowed in the seatback map pocket (if equipped)
- Objects placed on the occupant's lap
- Cargo interference with the seat
- Other passengers pushing or pulling on the seat
- Rear passenger feet and knees resting or pushing on the seat

The conditions listed above may cause the weight of a properly seated occupant to be incorrectly interpreted by the front passenger sensing system. The person in the front passenger seat may appear heavier or lighter due to the conditions described in the list above.



WARNING: To reduce the risk of possible serious injury:

Do not stow heavy objects in seat back map pocket (if equipped) or hang objects off seat back if a child is in the front passenger seat. Do not place objects underneath the front passenger seat or between the seat and the center console (if equipped).

Check the "passenger airbag off" or "pass airbag off" indicator lamp for proper airbag Status.

Failure to follow these instructions may interfere with the front passenger seat sensing system.

Seating and Safety Restraints

In case there is a problem with the front passenger sensing system, the airbag readiness lamp in the instrument cluster will stay lit.



If the airbag readiness lamp is lit, do the following:

The driver and/or adult passengers should check for any objects that may be lodged underneath the front passenger seat or cargo interfering with the seat.

If objects are lodged and/or cargo is interfering with the seat; please take the following steps to remove the obstruction:

- Pull the vehicle over.
- Turn the vehicle off.
- Driver and/or adult passengers should check for any objects lodged underneath the front passenger seat or cargo interfering with the seat.
- Remove the obstruction(s) (if found).
- Restart the vehicle.
- Wait at least 2 minutes and verify that the airbag readiness lamp is no longer illuminated
- If the airbag readiness lamp remains illuminated, this may or may/not be a problem due to the front passenger sensing system.

DO NOT attempt to repair or service the system; take your vehicle immediately to an authorized Mazda dealer. Ask the front seat occupant to sit in a rear seat until the air bag system is checked by the authorized Mazda Dealer.

If it is necessary to modify an advanced front airbag system to accommodate a person with disabilities, contact the Mazda Customer Relationship Center at the phone number shown in the *Customer Assistance* chapter of this *Owner's Manual*.



WARNING: Any alteration/modification to the front passenger seat may affect the performance of the front passenger sensing system.

Seating and Safety Restraints

Determining if the system is operational

The SRS uses a readiness light in the instrument cluster or a tone to indicate the status of the system. Refer to *Airbag readiness* section in the *Instrument Cluster* chapter. Routine maintenance of the airbag is not required.

A difficulty with the system is indicated by one or more of the following:

- The readiness light will either flash or stay lit.
- The readiness light will not illuminate immediately after ignition is turned on.
- A series of five beeps will be heard. The tone pattern will repeat periodically until the problem and/or light are repaired.



If any of these things happen, even intermittently, have the SRS serviced at an authorized dealer immediately. Unless serviced, the system may not function properly in the event of a collision.

Seat-mounted side airbag system (if equipped)



WARNING: Do not place objects or mount equipment on or near the airbag cover on the side of the seatbacks of the front seats or in front seat areas that may come into contact with a deploying airbag. Failure to follow these instructions may increase the risk of personal injury in the event of a collision.



WARNING: Do not use accessory seat covers. The use of accessory seat covers may prevent the deployment of the side airbags and increase the risk of injury in an accident.



WARNING: Do not lean your head on the door. The side airbag could injure you as it deploys from the side of the seatback.



WARNING: Do not attempt to service, repair, or modify the airbag SRS, its fuses or the seat cover on a seat containing an airbag. See an authorized dealer.



WARNING: All occupants of the vehicle should always wear their seat belts even when an airbag SRS is provided.

Seating and Safety Restraints

How does the side airbag system work?

The design and development of the side airbag system included recommended testing procedures that were developed by a group of automotive safety experts known as the Side Airbag Technical Working Group. These recommended testing procedures help reduce the risk of injuries related to the deployment of side airbags.

The side airbag system consists of the following:

- An inflatable nylon bag (airbag) with a gas generator concealed behind the outboard bolster of the driver and front passenger seatbacks.
- A special seat cover designed to allow airbag deployment.
- The same warning light, electronic control and diagnostic unit as used for the front airbags.
- Two crash sensors located on the lower portion of the b-pillar (one on each side of the vehicle).

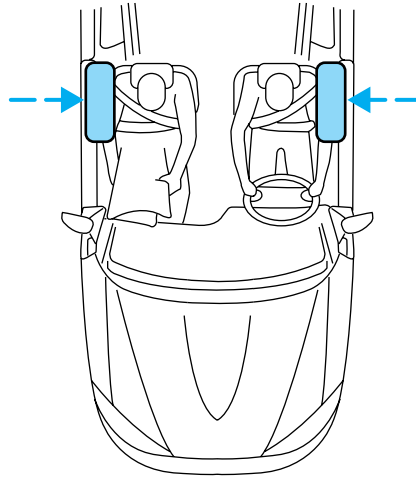

Side airbags, in combination with seat belts, can help reduce the risk of severe injuries in the event of a significant side impact collision.

The side airbags are fitted on the outboard side of the seatbacks of the front seats. In certain lateral collisions, the airbag on the side affected by the collision will be inflated. If the front passenger sensing system detects an empty seat, the front passenger seat-mounted side airbag will be deactivated. The airbag was designed to inflate between the door panel and occupant to further enhance the protection provided occupants in side impact collisions.

The airbag SRS is designed to activate when the vehicle sustains lateral deceleration sufficient to cause the sensors to close an electrical circuit that initiates airbag inflation.

Seating and Safety Restraints

The fact that the airbags did not inflate in a collision does not mean that something is wrong with the system. Rather, it means the forces were not of the type sufficient to cause activation. Side airbags are designed to inflate in side-impact collisions, not roll-over, rear-impact, frontal or near-frontal collisions, unless the collision causes sufficient lateral deceleration.



WARNING: Several airbag system components get hot after inflation. Do not touch them after inflation.



WARNING: If the side airbag has deployed, the airbag will not function again. The side airbag system (including the seat) must be inspected and serviced by an authorized dealer. If the airbag is not replaced, the unrepaired area will increase the risk of injury in a collision.

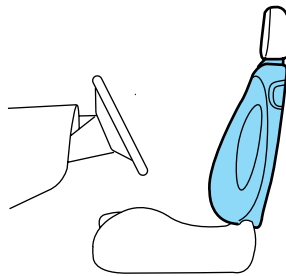

Determining if the system is operational

The SRS uses a readiness light in the instrument cluster or a tone to indicate the condition of the system. Refer to the *Airbag readiness* section in the *Instrument Cluster* chapter. Routine maintenance of the side airbag is not required.

A difficulty with the system is indicated by one or more of the following:

- The readiness light (same light as for front airbag system) will either flash or stay lit.
- The readiness light will not illuminate immediately after ignition is turned on.
- A series of five beeps will be heard. The tone pattern will repeat periodically until the problem and/or light are repaired.

If any of these things happen, even intermittently, have the SRS serviced at your authorized dealer immediately. Unless serviced, the system may not function properly in the event of a collision.

Seating and Safety Restraints

Side-curtain airbag system (if equipped)

You can determine if you have a vehicle with a side-curtain airbag system by looking near the top of the trim between the windows and see an “SRS” label on the main pillars between the windows.

 **WARNING:** Do not place objects or mount equipment on or near the headliner at the siderail that may come into contact with a deploying side-curtain airbags (if equipped). Failure to follow these instructions may increase the risk of personal injury in the event of a collision.

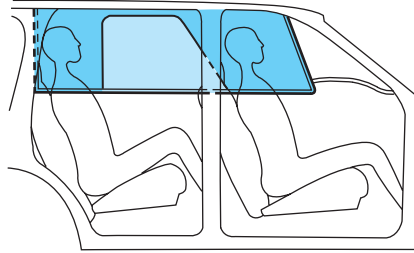

 **WARNING:** Do not lean your head on the door or window glass. The side-curtain airbags (if equipped) could injure you as it deploys from the headliner.

 **WARNING:** Do not attempt to service, repair, or modify the side-curtain airbags (if equipped), fuses, the A, B, or C pillar trim, or the headliner on a vehicle containing side-curtain airbags. See your authorized Mazda dealer.

 **WARNING:** All occupants of the vehicle including the driver should always wear their seat belts even when an airbag SRS and side-curtain airbags (if equipped) are provided.

 **WARNING:** To reduce risk of injury, do not obstruct or place objects in the deployment path of the inflatable side-curtain airbags (if equipped).

Seating and Safety Restraints

How do the side-curtain airbags (if equipped) work?

The design and development of the side air curtain system included recommended testing procedures that were developed by a group of automotive safety experts known as the Side Airbag Technical Working Group. These recommended testing procedures help reduce the risk of injuries related to the deployment of side airbags (including side air curtain systems).

The side-curtain airbags (if equipped) consists of the following:

- An inflatable nylon curtain with a gas generator concealed behind the headliner and above the doors (one on each side of vehicle).
- A headliner designed to flex open above the side doors to allow side-curtain airbag deployment.
- The same warning light, electronic control and diagnostic unit as used for the front airbags.
- Two crash sensors mounted at lower B-Pillar (one on each side).
- Two crash sensors located at the c-pillar behind the rear doors (one on each side).
- Rollover sensor in the restraints control module (RCM).

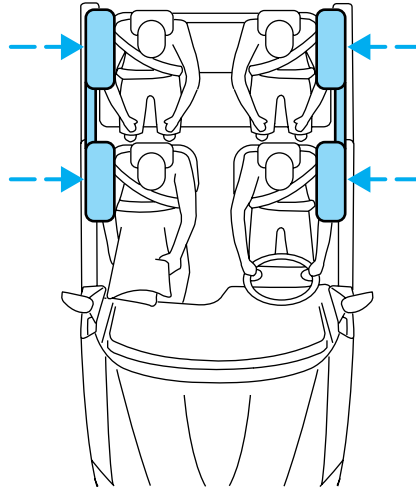

The side-curtain airbags (if equipped), in combination with seat belts, can help reduce the risk of severe injuries in the event of a significant side impact collision or rollover event.

Children 12 years old and under should always be properly restrained in the rear seats. The side-curtain airbags (if equipped) will not interfere with children restrained using a properly installed child or booster seat because it is designed to inflate downward from the headliner above the doors along the side window opening.

The side-curtain airbags (if equipped) are designed to activate when the vehicle sustains lateral deceleration sufficient to cause the RCM to initiate side-curtain airbag (if equipped) inflation or when a certain likelihood of a rollover event is detected by the rollover sensor.

Seating and Safety Restraints

The side-curtain airbags are mounted to roof side-rail sheet metal, behind the headliner, above the first and second row seats. In certain lateral collisions or rollover events, the side-curtain airbags will be activated, regardless of which seats are occupied. In certain rollover events, the side-curtain airbag (if equipped) on both sides of the vehicle will be inflated, regardless of which seats are occupied. The side-curtain airbags (if equipped) are designed to inflate between the side window area and occupants to further enhance protection provided in side impact collisions and rollover events.

The fact that the side-curtain airbags (if equipped) did not activate in a collision does not mean that there is a malfunction with the system. Rather, it means the forces were not of the type sufficient to cause activation. The side-curtain airbags (if equipped) are designed to inflate in certain side impact collisions or rollover events, not in rear impact, frontal or near-frontal collisions, unless the collision causes sufficient lateral deceleration or rollover likelihood.

 **WARNING:** Several side-curtain airbag (if equipped) components get hot after inflation. Do not touch them after inflation.

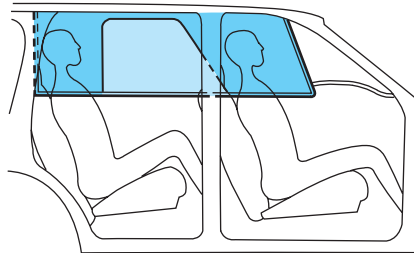

 **WARNING:** If the side-curtain airbags (if equipped) have deployed, the side-curtain airbags will not function again unless replaced. The side-curtain airbags (including the A, B and C pillar trim) must be inspected and serviced by a authorized dealer in accordance with the vehicle workshop manual. If the side-curtain airbags are not replaced, the unrepaired area will increase the risk of injury in a collision.

Determining if the side-curtain airbags are operational

The SRS uses a readiness light in the instrument cluster or a tone to indicate the condition of the system. Refer to the *Airbag readiness* section in the *Instrument cluster* chapter. Routine maintenance of the airbag is not required.

144

**2009 Tribute Hybrid (thv)
Owners Guide, 1st Printing
USA (fus)**

Seating and Safety Restraints

A difficulty with the system is indicated by one or more of the following:

- The readiness light (same light as for front airbag system) will either flash or stay lit.
- The readiness light will not illuminate immediately after ignition is turned on.
- A series of five beep sounds will be heard. The tone pattern will repeat periodically until the problem and light are repaired.

If any of these things happen, even intermittently, have the SRS serviced at your authorized Mazda dealership immediately. Unless serviced, the system may not function properly in the event of a collision.

S.O.S. Post Crash Alert

The S.O.S Post Crash Alert automatically flashes the turn signal lamps and sounds the horn three times at four second intervals in the event of a serious impact that deploys an airbag (front, side, side curtain or Safety Canopy®) or the seat belt pretensioners.

The S.O.S. Post Crash Alert can be turned off when any one of the following actions are taken by the driver or any other person:

- pressing the hazard control button,
- or pressing the panic button on the remote key fob.

The feature will continue to operate until the vehicle runs out of power.

Disposal of airbags and airbag equipped vehicles (including pretensioners)

See your authorized dealer. Airbags MUST BE disposed of by qualified personnel.

SAFETY RESTRAINTS FOR CHILDREN

See the following sections for directions on how to properly use safety restraints for children. Also see *Airbag supplemental restraint system (SRS)* in this chapter for special instructions about using airbags.

Important child restraint precautions



WARNING: Always make sure your child is secured properly in a device that is appropriate for their height, age and weight. Child safety restraints must be purchased separately from the vehicle. Failure to follow these instructions and guidelines may result in an increased risk of serious injury or death to your child.

Seating and Safety Restraints



WARNING: All children are shaped differently. The Recommendations for Safety Restraints are based on probable child height, age and weight thresholds from NHTSA and other safety organizations or are the minimum requirements of law. Mazda recommends checking with a NHTSA Certified Child Passenger Safety Technician (CPST) and your pediatrician to make sure your child seat is appropriate for your child, and is compatible with and properly installed in the vehicle. To locate a child seat fitting station and CPST contact the NHTSA toll free at 1-888-327-4236 or on the internet at <http://www.nhtsa.dot.gov>. Failure to properly restrain children in safety seats made especially for their height, age, and weight may result in an increased risk of serious injury or death to your child.

Recommendations for Safety Restraints for Children		
	Child size, height, weight, or age	Recommended restraint type
Infants or toddlers	Children weighing 40 lb (18 kg) or less (generally age four or younger)	Use a child safety seat (sometimes called an infant carrier, convertible seat, or toddler seat).
Small children	Children who have outgrown or no longer properly fit in a child safety seat (generally children who are less than 4 feet 9 inches (1.45 meters) tall, are greater than age four (4) and less than age twelve (12), and between 40 lbs (18 kg) and 80 lbs (36 kg) and upward to 100 lbs (45 kg) if recommended by your child restraint manufacturer)	Use a belt-positioning booster seat.

Seating and Safety Restraints

Recommendations for Safety Restraints for Children		
	Child size, height, weight, or age	Recommended restraint type
Larger children	Children who have outgrown or no longer properly fit in a belt-positioning booster seat (generally children who are at least 4 feet 9 inches (1.45 meters) tall or greater than 80 lb (36 kg) or 100 lb (45 kg) if recommended by child restraint manufacturer)	Use a vehicle seat belt having the lap belt snug and low across the hips, shoulder belt centered across the shoulder and chest, and seatback upright.

- You are required by law to properly use safety seats for infants and toddlers in the U.S. and Canada.
- Many states and provinces require that small children use approved booster seats until they reach age eight, a height of 4 ft 9 in (1.45 meters) tall, or 80 lb (36 kg). Check your local and state or provincial laws for specific requirements regarding the safety of children in your vehicle.
- When possible, always properly restrain children twelve (12) years of age and under in a rear seating position of your vehicle. Accident statistics suggest that children are safer when properly restrained in the rear seating positions than in a front seating position.

Seating and Safety Restraints

Recommendations for attaching child safety restraints for children

Restraint Type	Child Weight	Use any attachment method as indicated below by "X"				
		LATCH (lower anchors and top tether anchor)	LATCH (lower anchors only)	Seat belt and top tether anchor	Seat belt and LATCH (lower anchors and top tether anchor)	Seat belt only
Rear facing child seat	Up to 48 lb (21 kg)		X			X
Forward facing child seat	Up to 48 lb (21 kg)	X		X	X	
Forward facing child seat	Over 48 lb (21 kg)			X	X	



WARNING: Air bags can kill or injure a child in a child seat. NEVER place a rear-facing child seat in front of an active air bag. If you must use a forward-facing child seat in the front seat, move the vehicle seat all the way back. When possible, all children age 12 and under should be properly restrained in a rear seating position. If all children cannot be seated and restrained properly in a rear seating position, properly restrain the largest child in the front seat.



WARNING: Always carefully follow the instructions and warnings provided by the manufacturer of any child restraint to determine if the restraint device is appropriate for your child's size, height, weight, or age. Follow the child restraint manufacturer's instructions and warnings provided for installation and use in conjunction with the instructions and warnings provided by the vehicle manufacturer. A safety seat that is improperly installed or utilized, is inappropriate for your child's height, age, or weight or does not properly fit the child may increase the risk of serious injury or death.

Seating and Safety Restraints



WARNING: Never let a passenger hold a child on his or her lap while the vehicle is moving. The passenger cannot protect the child from injury in a collision, which may result in serious injury or death.



WARNING: Never use pillows, books, or towels to boost a child. They can slide around and increase the likelihood of injury or death in a collision.



WARNING: Always restrain an unoccupied child seat or booster seat. These objects may become projectiles in a collision or sudden stop, which may increase the risk of serious injury.



WARNING: Never place, or allow a child to place, the shoulder belt under a child's arm or behind the back because it reduces the protection for the upper part of the body and may increase the risk of injury or death in a collision.



WARNING: Do not leave children, unreliable adults, or pets unattended in your vehicle.

Transporting children

Always make sure your child is secured properly in a device that is appropriate for their age, height and weight. All children are shaped differently. The child height, age and weight thresholds provided are recommendations or the minimum requirements of law. The National Highway Traffic Safety Administration (NHTSA) provides education and training to ensure that all children ages 0 to 16 are properly restrained in the correct restraint system. Mazda recommends checking with a NHTSA Certified Child Passenger Safety Technician (CPST) and your pediatrician to make sure your seat is appropriate for your child and properly installed in the vehicle. To locate a child seat fitting station and CPST contact the NHTSA toll free at **1-888-327-4236** or on the internet at <http://www.nhtsa.dot.gov>.

Follow all the safety restraint and airbag precautions that apply to adult passengers in your vehicle.

Seating and Safety Restraints

If the child is the proper height, age, and weight (as specified by your child safety seat or booster manufacturer), fits the restraint and can be restrained properly, then restrain the child in the child safety seat or with the belt-positioning booster. Remember that child seats and belt-positioning boosters vary and may be designed to fit children of different heights, ages and weights. Children who are too large for child safety seats or belt-positioning boosters (as specified by your child safety seat manufacturer) should always properly wear seat belts.

SAFETY SEATS FOR CHILDREN

Infant and/or toddler seats

Use a safety seat that is recommended for the size and weight of the child.

When installing a child safety seat:

- Review and follow the information presented in the *Airbag supplemental restraint system (SRS)* section in this chapter.
- Carefully follow all of the manufacturer's instructions included with the safety seat you put in your vehicle. If you do not install and use the safety seat properly, the child may be injured in a sudden stop or collision.

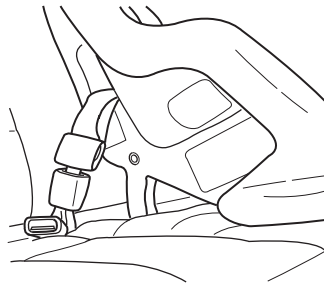

Airbags can kill or injure a child in a child seat. NEVER place a rear-facing child seat in front of an active airbag. If you must use a forward-facing child seat in the front seat, move the vehicle seat all the way back.

Children 12 and under should be properly restrained in a rear seating position whenever possible. If all children cannot be seated and restrained properly in a rear seating position, properly restrain the largest child in the front seat.

Seating and Safety Restraints

Installing child safety seats with combination lap and shoulder belts

The rear seat head restraints must be removed when using a child seat that utilizes the top tether anchor.

Check to make sure the child seat is properly secured before each use. Children 12 and under should be properly restrained in a rear seating position whenever possible. If all children cannot be seated and restrained properly in a rear seating position, properly restrain the largest child in the front seat.

When installing a child safety seat with combination lap/shoulder belts:

- Use the correct seat belt buckle for that seating position.
- Insert the belt tongue into the proper buckle until you hear a snap and feel it latch. Make sure the tongue is securely fastened in the buckle.
- Keep the buckle release button pointing up and away from the safety seat, with the tongue between the child seat and the release button, to help prevent accidental unbuckling.
- Place vehicle seat back in upright position.
- Put the seat belt in the automatic locking mode. Refer to step 5 below.

Perform the following steps when installing the child seat with combination lap/shoulder belts:

Note: Although the child seat illustrated is a forward facing child seat, the steps are the same for installing a rear facing child seat.

1. Position the child safety seat in a seat with a combination lap and shoulder belt.

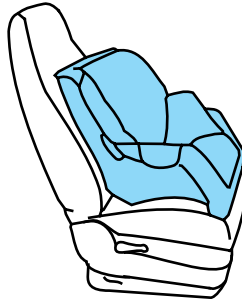

Seating and Safety Restraints

2. Pull down on the shoulder belt and then grasp the shoulder belt and lap belt together.

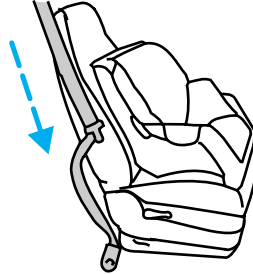

3. While holding the shoulder and lap belt portions together, route the tongue through the child seat according to the child seat manufacturer's instructions. Be sure the belt webbing is not twisted.

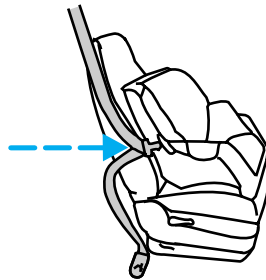

4. Insert the belt tongue into the proper buckle (the buckle closest to the direction the tongue is coming from) for that seating position until you hear a snap and feel the latch engage. Make sure the tongue is latched securely by pulling on it.

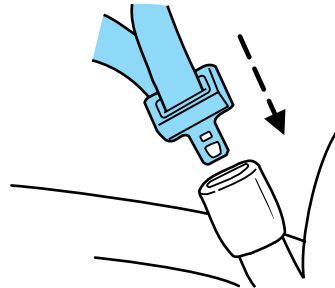

Seating and Safety Restraints

5. To put the retractor in the automatic locking mode, grasp the shoulder portion of the belt and pull downward until all of the belt is pulled out.

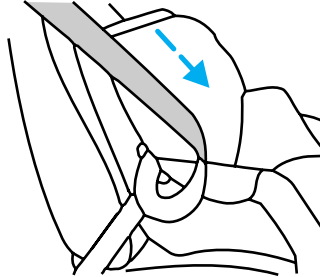

6. Allow the belt to retract to remove slack. The belt will click as it retracts to indicate it is in the automatic locking mode.
7. Try to pull the belt out of the retractor to make sure the retractor is in the automatic locking mode (you should not be able to pull more belt out). If the retractor is not locked, repeat Steps 5 and 6.

8. Remove remaining slack from the belt. Force the seat down with extra weight, e.g., by pressing down or kneeling on the child restraint while pulling up on the shoulder belt in order to force slack from the belt. This is necessary to remove the remaining slack that will exist once the additional weight of the child is added to the child restraint. It also helps to achieve the proper snugness of the child seat to the vehicle. Sometimes, a slight lean towards the buckle will additionally help to remove remaining slack from the belt.

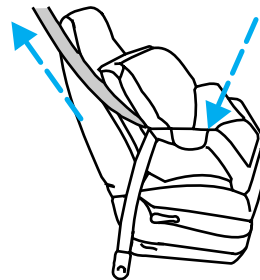

9. Attach the tether strap (if the child seat is equipped). Refer to *Attaching child safety seats with tether straps* later in this chapter.

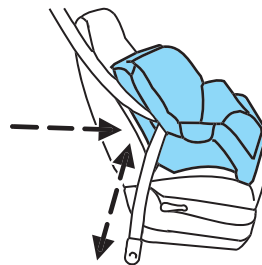

Seating and Safety Restraints

10. Before placing the child in the seat, forcibly move the seat forward and back to make sure the seat is securely held in place. To check this, grab the seat at the belt path and attempt to move it side to side and forward and back. There should be no more than one inch (2.5 cm) of movement for proper installation.
11. Mazda recommends checking with a NHTSA Certified Child Passenger Safety Technician (CPST) to make certain the child restraint is properly installed.

Attaching child safety seats with LATCH (Lower Anchors and Tethers for Children) attachments

The LATCH system is composed of three vehicle anchor points: two (2) lower anchors located where the vehicle seat back and seat cushion meet (called the “seat bight”) and one (1) top tether anchor located behind that seating position.

LATCH compatible child safety seats have two rigid or webbing mounted attachments that connect to the two lower anchors at the LATCH equipped seating positions in your vehicle. This type of attachment method eliminates the need to use seat belts to attach the child seat, however the seat belt can still be used to attach the child seat. For forward-facing child seats, the top tether strap must also be attached to the proper top tether anchor, if a top tether strap has been provided with your child seat. Mazda Motor Corporation recommends the use of a child safety seat having a top tether strap. See *Attaching child safety seats with tether straps* and *Recommendations for attaching safety restraints for children* in this chapter for more information.

Your vehicle has LATCH lower anchors for child seat installation at the seating positions marked with the child seat symbol.

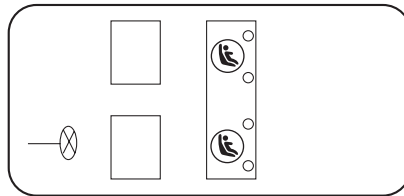

Seating and Safety Restraints

The LATCH anchors are located at the rear section of the rear seat between the cushion and seatback. Follow the child seat manufacturer's instructions to properly install a child seat with LATCH attachments.

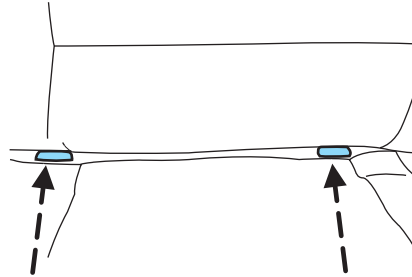

Follow the instructions on attaching child safety seats with tether straps. Refer to *Attaching child safety seats with tether straps* later in this chapter.

Attach LATCH lower attachments of the child seat only to the anchors shown.



WARNING: Never attach two child safety seats to the same anchor. In a crash, one anchor may not be strong enough to hold two child safety seat attachments and may break, causing serious injury or death.

Use of inboard lower anchors from the outboard seating positions (center seating use)

The lower anchors at the center of the second row rear seat are spaced 400 mm (16 inches) apart. The standardized spacing for LATCH lower anchors is 280 mm (11 inches) center to center. A child seat with rigid LATCH attachments cannot be installed at the center seating position. LATCH compatible child seats (with attachments on belt webbing) can only be used at this seating position provided that the child seat manufacturer's instructions permit use with the anchor spacing stated. Do not attach a child seat to any lower anchor if an adjacent child seat is attached to that anchor.



WARNING: The standardized spacing for LATCH lower anchors is 280 mm (11 inches) center to center. Do not use LATCH lower anchors for the center seating position unless the child seat manufacturer's instructions permit and specify using anchors spaced at least as far apart as those of this vehicle.

Seating and Safety Restraints

If you install a child seat with rigid LATCH attachments, and have attached the top tether strap to the proper top tether anchor, do not tighten the tether strap enough to lift the child seat off the vehicle seat cushion when the child is seated in it. Keep the tether strap just snug without lifting the front of the child seat. Keeping the child seat just touching the vehicle seat gives the best protection in a severe crash.

Each time you use the safety seat, check that the seat is properly attached to the lower anchors and tether anchor, if applicable. Tug the child seat from side to side and forward and back where it is secured to the vehicle. The seat should move less than one inch when you do this for a proper installation.

If the safety seat is not anchored properly, the risk of a child being injured in a crash greatly increases.

Combining seat belt and LATCH lower anchors for attaching child safety seats

When used in combination, either the seat belt or the LATCH lower anchors may be attached first, provided a proper installation is achieved. Attach the tether strap afterward, if included with the child seat. Refer to *Recommendations for attaching safety restraints for children* in this chapter.

Attaching child safety seats with tether straps

Many forward-facing child safety seats include a tether strap which extends from the back of the child safety seat and hooks to an anchoring point called the top tether anchor. Tether straps are available as an accessory for many older safety seats. Contact the manufacturer of your child seat for information about ordering a tether strap, or to obtain a longer tether strap if the tether strap on your safety seat does not reach the appropriate top tether anchor in the vehicle.

The rear seating positions of your vehicle are equipped with built-in tether strap anchors located behind the seats on the roof panel in the cargo area.

Seating and Safety Restraints

The tether strap anchors in your vehicle are in the following positions (shown from top view):

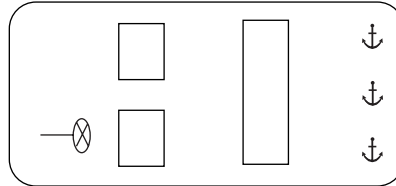

Attach the tether strap only to the appropriate tether anchor as shown. The tether strap may not work properly if attached somewhere other than the correct tether anchor.

Once the child safety seat has been installed, using either the seat belt or the lower anchors of the LATCH system, you can attach the top tether strap.

Perform the following steps to install a child safety seat with tether anchors:

1. Route the child safety seat tether strap over the back of the seat.

For vehicles with adjustable head restraints, remove the head restraint first, place under the front seat for storage, and then route the tether strap over the top of the seatback.

2. Locate the correct anchor for the selected seating position.

There are three tether anchors located on the headliner at the rear of the vehicle.

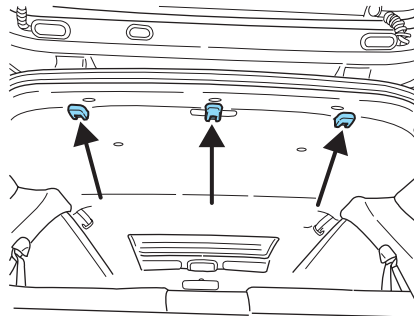

Seating and Safety Restraints

3. Clip the tether strap to the anchor as shown.

The arrow in the above graphic points toward the front of the vehicle.

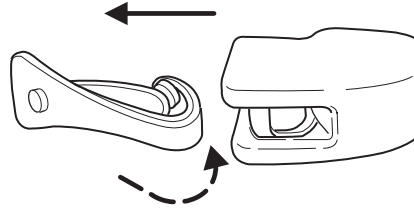

If the tether strap is clipped incorrectly, the child safety seat may not be retained properly in the event of a collision.

4. Tighten the child safety seat tether strap according to the manufacturer's instructions.

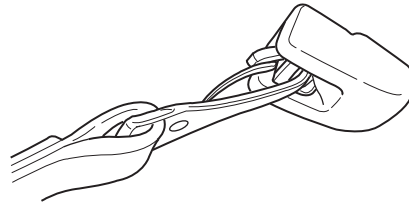

If the safety seat is not anchored properly, the risk of a child being injured in a collision greatly increases.

Child booster seats

The belt-positioning booster (booster seat) is used to improve the fit of the vehicle seat belt. Children outgrow a typical child seat (e.g., convertible or toddler seat) when they weigh about 40 lb (18 kg) and are around four (4) years of age. Consult your child safety seat owner manual for the weight, height, and age limits specific to your child safety seat. Keep your child in the child safety seat if it properly fits the child, remains appropriate for their weight, height and age AND if properly secured to the vehicle.

Although the lap/shoulder belt will provide some protection, children who have outgrown a typical child seat are still too small for lap/shoulder belts to fit properly, and wearing an improperly fitted vehicle seat belt could increase the risk of serious injury in a crash. To improve the fit of both the lap and shoulder belt on children who have outgrown child safety seats, Mazda Motor Corporation recommends use of a belt-positioning booster.

Seating and Safety Restraints

Booster seats position a child so that vehicle lap/shoulder seat belts fit better. They lift the child up so that the lap belt rests low across the hips and the knees bend comfortably at the edge of the cushion, while minimizing slouching. Booster seats may also make the shoulder belt fit better and more comfortably. Try to keep the belt near the middle of the shoulder and across the center of the chest. Moving the child closer (a few centimeters or inches) to the center of the vehicle, but remaining in the same seating position, may help provide a good shoulder belt fit.

When children should use booster seats

Children need to use booster seats from the time they outgrow the toddler seat until they are big enough for the vehicle seat and lap/shoulder belt to fit properly. Generally this is when they reach a height of at least 4 feet 9 inches (1.45 meters) tall (around age eight to age twelve and between 40 lb (18 kg) and 80 lb (36 kg) or upward to 100 lb (45 kg) if recommended by your child restraint manufacturer). Many state and provincial laws require that children use approved booster seats until they reach age eight, a height of 4 feet 9 inches (1.45 meters) tall, or 80 lb (36 kg).

Booster seats should be used until you can answer YES to ALL of these questions when seated without a booster seat:

- Can the child sit all the way back against the vehicle seat back with knees bent comfortably at the edge of the seat cushion?
- Can the child sit without slouching?

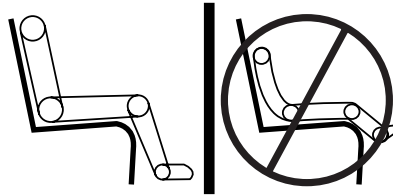

- Does the lap belt rest low across the hips?
- Is the shoulder belt centered on the shoulder and chest?
- Can the child stay seated like this for the whole trip?

Seating and Safety Restraints

Types of booster seats

There are generally two types of belt-positioning booster seats: backless and high back. Always use booster seats in conjunction with the vehicle lap/shoulder belt.

- **Backless booster seats**

If your backless booster seat has a removable shield, remove the shield. If a vehicle seating position has a low seat back or no head restraint, a backless booster seat may place your child's head (as measured at the tops of the ears) above the top of the seat. In this case, move the backless booster to another seating position with a higher seat back or head restraint and lap/shoulder belts, or consider using a high back booster seat.



- **High back booster seats**

If, with a backless booster seat, you cannot find a seating position that adequately supports your child's head, a high back booster seat would be a better choice.



Seating and Safety Restraints

Children and booster seats vary in size and shape. Choose a booster that keeps the lap belt low and snug across the hips, never up across the stomach, and lets you adjust the shoulder belt to cross the chest and rest snugly near the center of the shoulder. The drawings below compare the ideal fit (center) to a shoulder belt uncomfortably close to the neck and a shoulder belt that could slip off the shoulder. The drawings below also show how the lap belt should be low and snug across the child's hips.

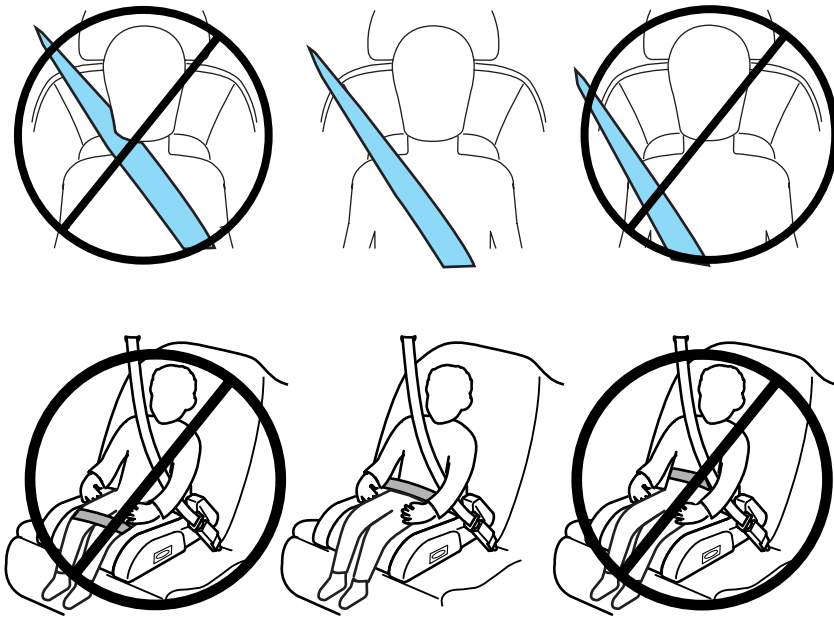

If the booster seat slides on the vehicle seat, placing a rubberized mesh sold as shelf or carpet liner under the booster seat may improve this condition. Do not introduce any item thicker than this under the booster seat. Check with the booster seat manufacturer's instructions.

The importance of shoulder belts

Using a booster without a shoulder belt increases the risk of a child's head hitting a hard surface in a collision. For this reason, you should never use a booster seat with a lap belt only. It is generally best to use a booster seat with lap/shoulder belts in the back seat.

Seating and Safety Restraints

Move a child to a different seating location if the shoulder belt does not stay positioned on the shoulder during use.

Follow all instructions provided by the manufacturer of the booster seat.



WARNING: Never place, or allow a child to place, the shoulder belt under a child's arm or behind the back because it reduces the protection for the upper part of the body and may increase the risk of injury or death in a collision.

Child restraint and seat belt maintenance

Inspect the vehicle seat belts and child safety seat systems periodically to make sure they work properly and are not damaged. Inspect the vehicle and child seat seat belts to make sure there are no nicks, tears or cuts. Replace if necessary. All vehicle seat belt assemblies, including retractors, buckles, front seat belt buckle assemblies, buckle support assemblies (slide bar-if equipped), shoulder belt height adjusters (if equipped), shoulder belt guide on seatback (if equipped), child safety seat LATCH and tether anchors, and attaching hardware, should be inspected after a collision. Refer to the child restraint manufacturer's instructions for additional inspection and maintenance information specific to the child restraint. Mazda Motor Corporation recommends that all seat belt assemblies in use in vehicles involved in a collision be replaced. However, if the collision was minor and an authorized dealer finds that the belts do not show damage and continue to operate properly, they do not need to be replaced. Seat belt assemblies not in use during a collision should also be inspected and replaced if either damage or improper operation is noted.

For proper care of soiled seat belts, refer to *Interior* in the *Cleaning* chapter.



WARNING: Failure to inspect and if necessary replace the seat belt assembly or child restraint system under the above conditions could result in severe personal injuries in the event of a collision.

Tires, Wheels and Loading

NOTICE TO UTILITY VEHICLE AND TRUCK OWNERS

Utility vehicles and trucks handle differently than passenger cars in the various driving conditions that are encountered on streets, highways and off-road. Utility vehicles and trucks are not designed for cornering at speeds as high as passenger cars any more than low-slung sports cars are designed to perform satisfactorily under off-road conditions.

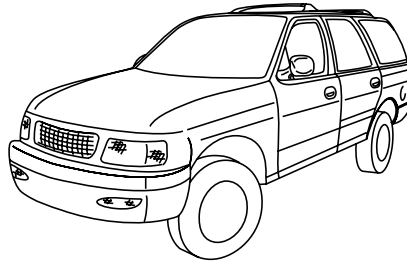

! **WARNING:** Utility vehicles have a significantly higher rollover rate than other types of vehicles. To reduce the risk of serious injury or death from a rollover or other crash you must:

- **Avoid sharp turns and abrupt maneuvers;**
- **Drive at safe speeds for the conditions;**
- **Keep tires properly inflated;**
- **Never overload or improperly load your vehicle; and**
- **Make sure every passenger is properly restrained.**

! **WARNING:** In a rollover crash, an unbelted person is significantly more likely to die than a person wearing a seat belt. All occupants must wear seat belts and children/infants must use appropriate restraints to minimize the risk of injury or ejection.

Study your “Owner’s Manual” and any supplements for specific information about equipment features, instructions for safe driving and additional precautions to reduce the risk of an accident or serious injury.

Tires, Wheels and Loading

VEHICLE CHARACTERISTICS

4WD Systems (if equipped)

Your vehicle may be equipped with a Four Wheel Drive (4WD) system. With the 4WD option, power will be delivered to the front wheels and distributed to the rear wheels as needed. This increases traction which may enable you to safely drive over terrain and road conditions that a conventional two-wheel drive vehicle cannot. The 4WD system is active all the time and requires no input from the operator.

For 4WD vehicles, a spare tire of a different size other than the tire provided should never be used. A dissimilar spare tire size (other than the spare tire provided) or major dissimilar tire sized between the front and rear axles could cause the 4WD system to stop functioning and default to front wheel drive.



WARNING: Do not become overconfident in the ability of 4WD vehicles. Although a 4WD vehicle may accelerate better than two-wheel drive vehicle in low traction situations, it won't stop any faster than two-wheel drive vehicles. Always drive at a safe speed.

How your vehicle differs from other vehicles

SUV and trucks can differ from some other vehicles in a few noticeable ways. Your vehicle may be:

- Higher – to allow higher load carrying capacity and to allow it to travel over rough terrain without getting hung up or damaging underbody components.
- Shorter – to give it the capability to approach inclines and drive over the crest of a hill without getting hung up or damaging underbody components. All other things held equal, a shorter wheelbase may make your vehicle quicker to respond to steering inputs than a vehicle with a longer wheelbase.

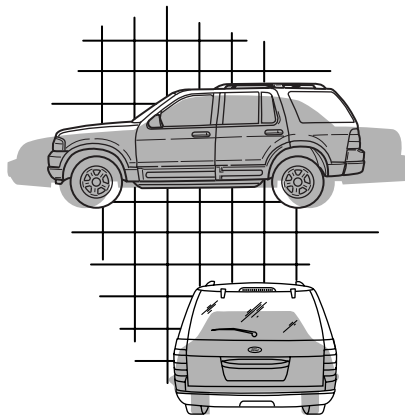

Tires, Wheels and Loading

- Narrower — to provide greater maneuverability in tight spaces, particularly in off-road use.

As a result of the above dimensional differences, SUV's and trucks often will have a higher center of gravity and a greater difference in center of gravity between the loaded and unloaded condition.

These differences that make your vehicle so versatile also make it handle differently than an ordinary passenger car.

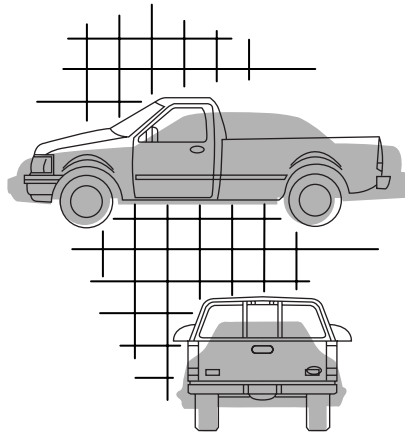

INFORMATION ABOUT UNIFORM TIRE QUALITY GRADING

Tire Quality Grades apply to new pneumatic passenger car tires. The Quality grades can be found where applicable on the tire sidewall between tread shoulder and maximum section width. For example:

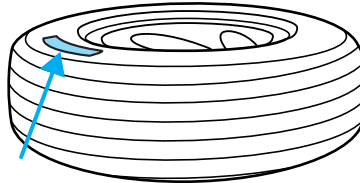

- **Treadwear 200 Traction AA Temperature A**

These Tire Quality Grades are determined by standards that the United States Department of Transportation has set.

Tire Quality Grades apply to new pneumatic passenger car tires. They do not apply to deep tread, winter-type snow tires, space-saver or temporary use spare tires, light truck or "LT" type tires, tires with nominal rim diameters of 10 to 12 inches or limited production tires as defined in Title 49 Code of Federal Regulations Part 575.104(c)(2).

U.S. Department of Transportation-Tire quality grades: The U.S. Department of Transportation requires Mazda Motor Corporation to give you the following information about tire grades exactly as the government has written it.

Tires, Wheels and Loading

Treadwear

The treadwear grade is a comparative rating based on the wear rate of the tire when tested under controlled conditions on a specified government test course. For example, a tire graded 150 would wear one and one-half (1½) times as well on the government course as a tire graded 100. The relative performance of tires depends upon the actual conditions of their use, however, and may depart significantly from the norm due to variations in driving habits, service practices, and differences in road characteristics and climate.

Traction AA A B C

The traction grades, from highest to lowest are AA, A, B, and C. The grades represent the tire's ability to stop on wet pavement as measured under controlled conditions on specified government test surfaces of asphalt and concrete. A tire marked C may have poor traction performance.



WARNING: The traction grade assigned to this tire is based on straight-ahead braking traction tests, and does not include acceleration, cornering, hydroplaning or peak traction characteristics.

Temperature A B C

The temperature grades are A (the highest), B and C, representing the tire's resistance to the generation of heat and its ability to dissipate heat when tested under controlled conditions on a specified indoor laboratory test wheel. Sustained high temperature can cause the material of the tire to degenerate and reduce tire life, and excessive temperature can lead to sudden tire failure. The grade C corresponds to a level of performance which all passenger car tires must meet under the Federal Motor Vehicle Safety Standard No. 139. Grades B and A represent higher levels of performance on the laboratory test wheel than the minimum required by law.



WARNING: The temperature grade for this tire is established for a tire that is properly inflated and not overloaded. Excessive speed, underinflation, or excessive loading, either separately or in combination, can cause heat buildup and possible tire failure.

TIRES

Tires are designed to give many thousands of miles of service, but they must be maintained in order to get the maximum benefit from them.

166

*2009 Tribute Hybrid (thv)
Owners Guide, 1st Printing
USA (fus)*

Tires, Wheels and Loading

Glossary of tire terminology

- **Tire label:** A label showing the OE (Original Equipment) tire sizes, recommended inflation pressure and the maximum weight the vehicle can carry.
- **Tire Identification Number (TIN):** A number on the sidewall of each tire providing information about the tire brand and manufacturing plant, tire size and date of manufacture. Also referred to as DOT code.
- **Inflation pressure:** A measure of the amount of air in a tire.
- **Standard load:** A class of P-metric or Metric tires designed to carry a maximum load at 35 psi [37 psi (2.5 bar) for Metric tires]. Increasing the inflation pressure beyond this pressure will not increase the tire's load carrying capability.
- **Extra load:** A class of P-metric or Metric tires designed to carry a heavier maximum load at 41 psi [43 psi (2.9 bar) for Metric tires]. Increasing the inflation pressure beyond this pressure will not increase the tire's load carrying capability.
- **kPa:** Kilopascal, a metric unit of air pressure.
- **PSI:** Pounds per square inch, a standard unit of air pressure.
- **Cold inflation pressure:** The tire pressure when the vehicle has been stationary and out of direct sunlight for an hour or more and prior to the vehicle being driven for 1 mile (1.6 km).
- **Recommended inflation pressure:** The cold inflation pressure found on the Safety Compliance Certification Label or Tire Label located on the B-Pillar or the edge of the driver's door.
- **B-pillar:** The structural member at the side of the vehicle behind the front door.
- **Bead area of the tire:** Area of the tire next to the rim.
- **Sidewall of the tire:** Area between the bead area and the tread.
- **Tread area of the tire:** Area of the perimeter of the tire that contacts the road when mounted on the vehicle.
- **Rim:** The metal support (wheel) for a tire or a tire and tube assembly upon which the tire beads are seated.

Tires, Wheels and Loading

INFLATING YOUR TIRES

Safe operation of your vehicle requires that your tires are properly inflated. Remember that a tire can lose up to half of its air pressure without appearing flat.

Every day before you drive, check your tires. If one looks lower than the others, use a tire gauge to check pressure of all tires and adjust if required.

At least once a month and before long trips, inspect each tire and check the tire pressure with a tire gauge (including spare, if equipped). Inflate all tires to the inflation pressure recommended by Mazda Motor Corporation.

You are strongly urged to buy a reliable tire pressure gauge, as automatic service station gauges may be inaccurate. Mazda recommends the use of a digital or dial-type tire pressure gauge rather than a stick-type tire pressure gauge.

Use the recommended cold inflation pressure for optimum tire performance and wear. Under-inflation or over-inflation may cause uneven treadwear patterns.



WARNING: Under-inflation is the most common cause of tire failures and may result in severe tire cracking, tread separation or "blowout", with unexpected loss of vehicle control and increased risk of injury. Under-inflation increases sidewall flexing and rolling resistance, resulting in heat buildup and internal damage to the tire. It also may result in unnecessary tire stress, irregular wear, loss of vehicle control and accidents. A tire can lose up to half of its air pressure and not appear to be flat!

Always inflate your tires to the Mazda recommended inflation pressure even if it is less than the maximum inflation pressure information found on the tire. The Mazda recommended tire inflation pressure is found on the Safety Compliance Certification Label or Tire Label which is located on the B-Pillar or the edge of the driver's door. Failure to follow the tire pressure recommendations can cause uneven treadwear patterns and adversely affect the way your vehicle handles.

Maximum Permissible Inflation Pressure is the tire manufacturer's maximum permissible pressure and/or the pressure at which the maximum load can be carried by the tire. This pressure is normally higher than the manufacturer's recommended cold inflation pressure which can be found on the Safety Compliance Certification Label or Tire Label which is located on the B-Pillar or the edge of the driver's door.

168

*2009 Tribute Hybrid (thv)
Owners Guide, 1st Printing
USA (fus)*

Tires, Wheels and Loading

The cold inflation pressure should never be set lower than the recommended pressure on the Safety Compliance Certification Label or Tire Label.

When weather temperature changes occur, tire inflation pressures also change. A 10°F (6°C) temperature drop can cause a corresponding drop of 1 psi (7 kPa) in inflation pressure. Check your tire pressures frequently and adjust them to the proper pressure which can be found on the Safety Compliance Certification Label or Tire Label.

To check the pressure in your tire(s):

1. Make sure the tires are cool, meaning they are not hot from driving even a mile.

If you are checking tire pressure when the tire is hot, (i.e. driven more than 1 mile [1.6 km]), never “bleed” or reduce air pressure. The tires are hot from driving and it is normal for pressures to increase above recommended cold pressures. A hot tire at or below recommended cold inflation pressure could be significantly under-inflated.

Note: If you have to drive a distance to get air for your tire(s), check and record the tire pressure first and add the appropriate air pressure when you get to the pump. It is normal for tires to heat up and the air pressure inside to go up as you drive.

2. Remove the cap from the valve on one tire, then firmly press the tire gauge onto the valve and measure the pressure.
3. Add enough air to reach the recommended air pressure.

Note: If you overfill the tire, release air by pushing on the metal stem in the center of the valve. Then recheck the pressure with your tire gauge.

4. Replace the valve cap.
5. Repeat this procedure for each tire, including the spare.

Note: Some spare tires operate at a higher inflation pressure than the other tires. For T-type/mini-spare tires (see the *Dissimilar spare tire/wheel information* section for description): Store and maintain at 60 psi (4.15 bar). For Full Size and Dissimilar spare tires (see the *Dissimilar spare tire/wheel information* section for description): Store and maintain at the higher of the front and rear inflation pressure as shown on the Tire Label.

6. Visually inspect the tires to make sure there are no nails or other objects embedded that could poke a hole in the tire and cause an air leak.
7. Check the sidewalls to make sure there are no gouges, cuts or bulges.

Tires, Wheels and Loading

TIRE CARE

Inspecting your tires

Periodically inspect the tire treads for uneven or excessive wear and remove objects such as stones, nails or glass that may be wedged in the tread grooves. Check for holes or cuts that may permit air leakage from the tire and make necessary repairs. Also inspect the tire sidewalls for cracking, cuts, bruises and other signs of damage or excessive wear. If internal damage to the tire is suspected, have the tire demounted and inspected in case it needs to be repaired or replaced. For your safety, tires that are damaged or show signs of excessive wear should not be used because they are more likely to blow out or fail.

Improper or inadequate vehicle maintenance can cause tires to wear abnormally. Inspect all your tires, including the spare, frequently, and replace them if one or more of the following conditions exist:

Tire wear

When the tread is worn down to 1/16th of an inch (2 mm), tires must be replaced to help prevent your vehicle from skidding and hydroplaning. Built-in treadwear indicators, or “wear bars”, which look like narrow strips of smooth rubber across the tread will appear on the tire when the tread is worn down to 1/16th of an inch (2 mm).

When the tire tread wears down to the same height as these “wear bars”, the tire is worn out and must be replaced.

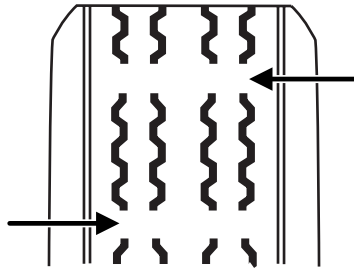

Damage

Periodically inspect the tire treads and sidewalls for damage (such as bulges in the tread or sidewalls, cracks in the tread groove and separation in the tread or sidewall). If damage is observed or suspected have the tire inspected by a tire professional. Tires can be damaged during off-road use, so inspection after off-road use is also recommended.

Tires, Wheels and Loading



WARNING: Age

Tires degrade over time depending on many factors such as weather, storage conditions, and conditions of use (load, speed, inflation pressure, etc.) the tires experience throughout their lives. In general, tires should be replaced after 6 years regardless of tread wear. However, heat caused by hot climates or frequent high loading conditions can accelerate the aging process and may require tires to be replaced more frequently.

You should replace your spare tire when you replace the road tires or after 6 years due to aging even if it has not been used.

U.S. DOT Tire Identification Number (TIN)

Both U.S. and Canada Federal regulations require tire manufacturers to place standardized information on the sidewall of all tires. This information identifies and describes the fundamental characteristics of the tire and also provides a U.S. DOT Tire Identification Number for safety standard certification and in case of a recall.

This begins with the letters "DOT" and indicates that the tire meets all federal standards. The next two numbers or letters are the plant code designating where it was manufactured, the next two are the tire size code and the last four numbers represent the week and year the tire was built. For example, the numbers 317 mean the 31st week of 1997. After 2000 the numbers go to four digits. For example, 2501 means the 25th week of 2001. The numbers in between are identification codes used for traceability. This information is used to contact customers if a tire defect requires a recall.

Tire Replacement Requirements

Your vehicle is equipped with tires designed to provide a safe ride and handling capability.

Tires, Wheels and Loading



WARNING: Only use replacement tires and wheels that are the same size, load index, speed rating and type (such as P-metric versus LT-metric or all-season versus all-terrain) as those originally provided by Mazda. The recommended tire and wheel size may be found on either the Safety Compliance Certification Label or the Tire Label which is located on the B-Pillar or edge of the driver's door. If this information is not found on these labels then you should consult your Mazda dealer. Use of any tire or wheel not recommended by Mazda can affect the safety and performance of your vehicle, which could result in an increased risk of loss of vehicle control, vehicle rollover, personal injury and death. Additionally the use of non-recommended tires and wheels could cause steering, suspension, axle or transfer case/power transfer unit failure. If you have questions regarding tire replacement, see an authorized dealer.



WARNING: When mounting replacement tires and wheels, you should not exceed the maximum pressure indicated on the sidewall of the tire to set the beads without additional precautions listed below. If the beads do not seat at the maximum pressure indicated, re-lubricate and try again.

When inflating the tire for mounting pressures up to 20 psi greater than the maximum pressure on the tire sidewall, the following precautions must be taken to protect the person mounting the tire:

- 1. Make sure that you have the correct tire and wheel size.**
- 2. Lubricate the tire bead and wheel bead seat area again.**
- 3. Stand at a minimum of 12 feet away from the tire wheel assembly.**
- 4. Use both eye and ear protection.**

For a mounting pressure more than 20 psi greater than the maximum pressure, a Mazda Dealer or other tire service professional should do the mounting.

Always inflate steel carcass tires with a remote air fill with the person inflating standing at a minimum of 12 ft. away from the tire wheel assembly.

Important: Remember to replace the valve stems when the road tires are replaced on your vehicle.

It is recommended that the two front tires or two rear tires generally be replaced as a pair.

172

*2009 Tribute Hybrid (thv)
Owners Guide, 1st Printing
USA (fus)*

Tires, Wheels and Loading

Note: The use of a different tire can effect the fuel economy of your vehicle.

The tire pressure monitoring sensors mounted in the wheels (originally installed on your vehicle) are not designed to be used in aftermarket wheels.

The use of wheels or tires not recommended by Mazda Motor Corporation may affect the operation of your Tire Pressure Monitoring System.

If the TPMS indicator is flashing, your TPMS is malfunctioning. Your replacement tire might be incompatible with your TPMS, or some component of the TPMS may be damaged.

Safety practices

Driving habits have a great deal to do with your tire mileage and safety.

- Observe posted speed limits
- Avoid fast starts, stops and turns
- Avoid potholes and objects on the road
- Do not run over curbs or hit the tire against a curb when parking



WARNING: If your vehicle is stuck in snow, mud, sand, etc., do not rapidly spin the tires; spinning the tires can tear the tire and cause an explosion. A tire can explode in as little as three to five seconds.



WARNING: Do not spin the wheels at over 35 mph (56 km/h). The tires may fail and injure a passenger or bystander.

Highway hazards

No matter how carefully you drive there's always the possibility that you may eventually have a flat tire on the highway. Drive slowly to the closest safe area out of traffic. This may further damage the flat tire, but your safety is more important.

If you feel a sudden vibration or ride disturbance while driving, or you suspect your tire or vehicle has been damaged, immediately reduce your speed. Drive with caution until you can safely pull off the road. Stop and inspect the tires for damage. If a tire is under-inflated or damaged, deflate it, remove wheel and replace it with your spare tire and wheel. If you cannot detect a cause, have the vehicle towed to the nearest repair facility or tire dealer to have the vehicle inspected.

Tires, Wheels and Loading

Tire and wheel alignment

A bad jolt from hitting a curb or pothole can cause the front end of your vehicle to become misaligned or cause damage to your tires. If your vehicle seems to pull to one side when you're driving, the wheels may be out of alignment. Have an authorized dealer check the wheel alignment periodically.

Wheel misalignment in the front or the rear can cause uneven and rapid treadwear of your tires and should be corrected by an authorized dealer. Front wheel drive (FWD) vehicles and those with an independent rear suspension (if equipped) may require alignment of all four wheels.

The tires should also be balanced periodically. An unbalanced tire and wheel assembly may result in irregular tire wear.

Tire rotation

Rotating your tires at the recommended interval (as indicated in the *Scheduled maintenance* section of the *Maintenance and Specifications* chapter) will help your tires wear more evenly, providing better tire performance and longer tire life.

- Front Wheel Drive (FWD) vehicles (front tires at top of diagram)

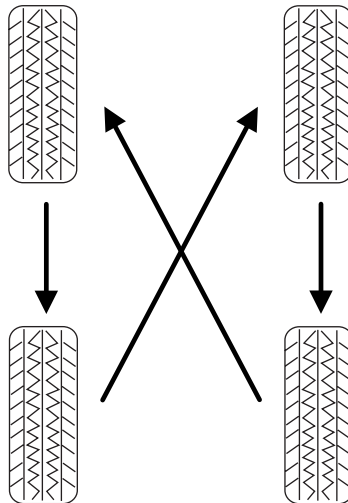

Tires, Wheels and Loading

- Rear Wheel Drive (RWD) vehicles/Four Wheel Drive (4WD)/All Wheel Drive (AWD) vehicles (front tires at top of diagram)

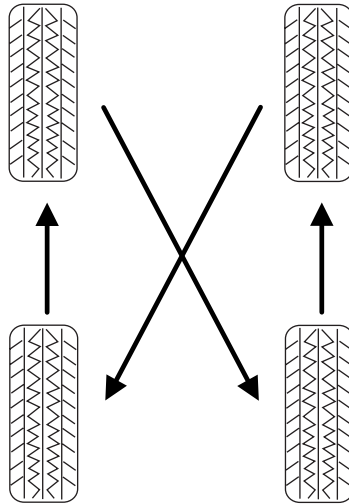

Sometimes irregular tire wear can be corrected by rotating the tires.

Note: If your tires show uneven wear ask a qualified technician at a Mazda dealership to check for and correct any wheel misalignment, tire imbalance or mechanical problem involved before tire rotation.

Note: Your vehicle may be equipped with a dissimilar spare tire/wheel. A dissimilar spare tire/wheel is defined as a spare tire and/or wheel that is different in brand, size or appearance from the road tires and wheels. If you have a dissimilar spare tire/wheel it is intended for temporary use only and should not be used in a tire rotation.

Note: After having your tires rotated, inflation pressure must be checked and adjusted to the vehicle requirements.

INFORMATION CONTAINED ON THE TIRE SIDEWALL

Both U.S. and Canada Federal regulations require tire manufacturers to place standardized information on the sidewall of all tires. This information identifies and describes the fundamental characteristics of the tire and also provides a U.S. DOT Tire Identification Number for safety standard certification and in case of a recall.

Tires, Wheels and Loading

Information on “P” type tires

P215/65R15 95H is an example of a tire size, load index and speed rating. The definitions of these items are listed below. (Note that the tire size, load index and speed rating for your vehicle may be different from this example.)

1. **P:** Indicates a tire, designated by the Tire and Rim Association (T&RA), that may be used for service on cars, SUVs, minivans and light trucks.

Note: If your tire size does not begin with a letter this may mean it is designated by either ETRTO (European Tire and Rim Technical Organization) or JATMA (Japan Tire Manufacturing Association).

2. **215:** Indicates the nominal width of the tire in millimeters from sidewall edge to sidewall edge. In general, the larger the number, the wider the tire.
3. **65:** Indicates the aspect ratio which gives the tire's ratio of height to width.
4. **R:** Indicates a “radial” type tire.
5. **15:** Indicates the wheel or rim diameter in inches. If you change your wheel size, you will have to purchase new tires to match the new wheel diameter.
6. **95:** Indicates the tire's load index. It is an index that relates to how much weight a tire can carry. You may find this information in your *Owner's Manual*. If not, contact a local tire dealer.

Note: You may not find this information on all tires because it is not required by federal law.

7. **H:** Indicates the tire's speed rating. The speed rating denotes the speed at which a tire is designed to be driven for extended periods of time under a standard condition of load and inflation pressure. The tires on your vehicle may operate at different conditions for load and inflation pressure. These speed ratings may need to be adjusted for the difference in conditions. The ratings range from 81 mph (130 km/h) to 186 mph (299 km/h). These ratings are listed in the following chart.

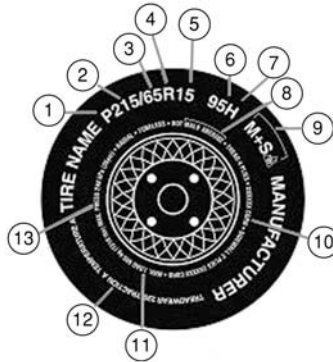

Tires, Wheels and Loading

Note: You may not find this information on all tires because it is not required by federal law.

Letter rating	Speed rating - mph (km/h)
M	81 mph (130 km/h)
N	87 mph (140 km/h)
Q	99 mph (159 km/h)
R	106 mph (171 km/h)
S	112 mph (180 km/h)
T	118 mph (190 km/h)
U	124 mph (200 km/h)
H	130 mph (210 km/h)
V	149 mph (240 km/h)
W	168 mph (270 km/h)
Y	186 mph (299 km/h)

Note: For tires with a maximum speed capability over 149 mph (240 km/h), tire manufacturers sometimes use the letters ZR. For those with a maximum speed capability over 186 mph (299 km/h), tire manufacturers always use the letters ZR.

8. **U.S. DOT Tire Identification Number (TIN):** This begins with the letters "DOT" and indicates that the tire meets all federal standards. The next two numbers or letters are the plant code designating where it was manufactured, the next two are the tire size code and the last four numbers represent the week and year the tire was built. For example, the numbers 317 mean the 31st week of 1997. After 2000 the numbers go to four digits. For example, 2501 means the 25th week of 2001. The numbers in between are identification codes used for traceability. This information is used to contact customers if a tire defect requires a recall.
9. **M+S or M/S:** Mud and Snow, or
AT: All Terrain, or
AS: All Season.
10. **Tire Ply Composition and Material Used:** Indicates the number of plies or the number of layers of rubber-coated fabric in the tire tread and sidewall. Tire manufacturers also must indicate the ply materials in the tire and the sidewall, which include steel, nylon, polyester, and others.

Tires, Wheels and Loading

11. **Maximum Load:** Indicates the maximum load in kilograms and pounds that can be carried by the tire. Refer to the Safety Compliance Certification Label, which is located on the B-Pillar or the edge of the driver's door, for the correct tire pressure for your vehicle.
12. **Treadwear, Traction and Temperature Grades**
 - **Treadwear:** The treadwear grade is a comparative rating based on the wear rate of the tire when tested under controlled conditions on a specified government test course. For example, a tire graded 150 would wear one and one-half (1½) times as well on the government course as a tire graded 100.
 - **Traction:** The traction grades, from highest to lowest are AA, A, B, and C. The grades represent the tire's ability to stop on wet pavement as measured under controlled conditions on specified government test surfaces of asphalt and concrete. A tire marked C may have poor traction performance.
 - **Temperature:** The temperature grades are A (the highest), B and C, representing the tire's resistance to the generation of heat and its ability to dissipate heat when tested under controlled conditions on a specified indoor laboratory test wheel.
13. **Maximum Permissible Inflation Pressure:** Indicates the tire manufacturers' maximum permissible pressure and/or the pressure at which the maximum load can be carried by the tire. This pressure is normally higher than the manufacturer's recommended cold inflation pressure which can be found on the Safety Compliance Certification Label or Tire Label which is located on the B-Pillar or the edge of the driver's door. The cold inflation pressure should never be set lower than the recommended pressure on the vehicle label.

The tire suppliers may have additional markings, notes or warnings such as standard load, radial tubeless, etc.

Tires, Wheels and Loading

Additional information contained on the tire sidewall for “LT” type tires

“LT” type tires have some additional information beyond those of “P” type tires; these differences are described below.

Note: Tire Quality Grades do not apply to this type of tire.

1. **LT:** Indicates a tire, designated by the Tire and Rim Association (T&RA), that is intended for service on light trucks.
2. **Load Range/Load Inflation Limits:** Indicates the tire’s load-carrying capabilities and its inflation limits.
3. **Maximum Load Dual lb. (kg) at psi (kPa) cold:** Indicates the maximum load and tire pressure when the tire is used as a dual; defined as four tires on the rear axle (a total of six or more tires on the vehicle).
4. **Maximum Load Single lb. (kg) at psi (kPa) cold:** Indicates the maximum load and tire pressure when the tire is used as a single; defined as two tires (total) on the rear axle.

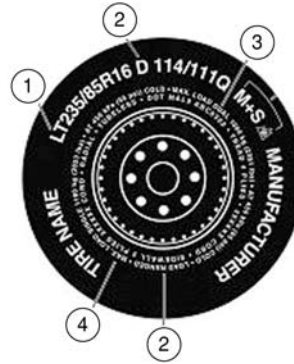

Tires, Wheels and Loading

Information on “T” type tires

“T” type tires have some additional information beyond those of “P” type tires; these differences are described below:

T145/80D16 is an example of a tire size.

Note: The temporary tire size for your vehicle may be different from this example. Tire Quality Grades do not apply to this type of tire.

1. **T:** Indicates a type of tire, designated by the Tire and Rim Association (T&RA), that is intended for temporary service on cars, SUVs, minivans and light trucks.
2. **145:** Indicates the nominal width of the tire in millimeters from sidewall edge to sidewall edge. In general, the larger the number, the wider the tire.
3. **80:** Indicates the aspect ratio which gives the tire’s ratio of height to width. Numbers of 70 or lower indicate a short sidewall.
4. **D:** Indicates a “diagonal” type tire.
R: Indicates a “radial” type tire.
5. **16:** Indicates the wheel or rim diameter in inches. If you change your wheel size, you will have to purchase new tires to match the new wheel diameter.

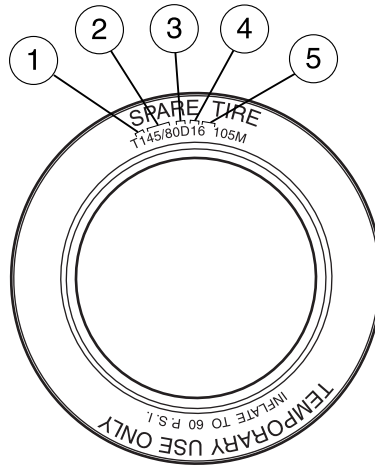

Location of the tire label

You will find a Tire Label containing tire inflation pressure by tire size and other important information located on the B-Pillar or the edge of the driver’s door. Refer to the payload description and graphic in the *Vehicle loading — with and without a trailer* section.

Tires, Wheels and Loading

TIRE PRESSURE MONITORING SYSTEM (TPMS)

Each tire, including the spare (if provided), should be checked monthly when cold and inflated to the inflation pressure recommended by the vehicle manufacturer on the



vehicle placard or tire inflation pressure label. (If your vehicle has tires of a different size than the size indicated on the vehicle placard or tire inflation pressure label, you should determine the proper tire inflation pressure for those tires.)

As an added safety feature, your vehicle has been equipped with a tire pressure monitoring system (TPMS) that illuminates a low tire pressure telltale when one or more of your tires is significantly under-inflated. Accordingly, when the low tire pressure telltale illuminates, you should stop and check your tires as soon as possible, and inflate them to the proper pressure. Driving on a significantly under-inflated tire causes the tire to overheat and can lead to tire failure. Under-inflation also reduces fuel efficiency and tire tread life, and may affect the vehicle's handling and stopping ability.

Please note that the TPMS is not a substitute for proper tire maintenance, and it is the driver's responsibility to maintain correct tire pressure, even if under-inflation has not reached the level to trigger illumination of the TPMS low tire pressure telltale.

Your vehicle has also been equipped with a TPMS malfunction indicator to indicate when the system is not operating properly. The TPMS malfunction indicator is combined with the low tire pressure telltale. When the system detects a malfunction, the telltale will flash for approximately one minute and then remain continuously illuminated. This sequence will continue upon subsequent vehicle start-ups as long as the malfunction exists.

When the malfunction indicator is illuminated, the system may not be able to detect or signal low tire pressure as intended. TPMS malfunctions may occur for a variety of reasons, including the installation of replacement or alternate tires or wheels on the vehicle that prevent the TPMS from functioning properly. Always check the TPMS malfunction telltale after replacing one or more tires or wheels on your vehicle to ensure that the replacement or alternate tires and wheels allow the TPMS to continue to function properly.

Tires, Wheels and Loading

The Tire Pressure Monitoring System complies with part 15 of the FCC rules and with RSS-210 of Industry Canada. Operation is subject to the following two conditions: (1) This device may not cause harmful interference, and (2) This device must accept any interference received, including interference that may cause undesired operation.

! **WARNING:** The Tire Pressure Monitoring System is NOT a substitute for manually checking tire pressure. The tire pressure should be checked periodically (at least monthly) using a tire gauge, see *Inflating your tires* in this chapter. **Failure to properly maintain your tire pressure could increase the risk of tire failure, loss of control, vehicle rollover and personal injury.**

Changing tires with TPMS

Each road tire is equipped with a tire pressure sensor located inside the tire/wheel cavity. The pressure sensor is attached to the valve stem. The pressure sensor is covered by the tire and is not visible unless the tire is removed. Care must be taken when changing the tire to avoid damaging the sensor. It is

recommended that you always have your tires serviced by an authorized dealer.

The tire pressure should be checked periodically (at least monthly) using an accurate tire gauge, refer to *Inflating your tires* in this chapter.

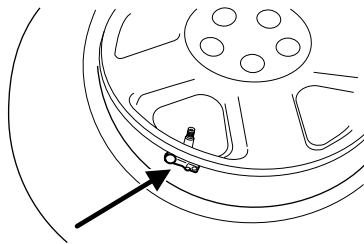

Tires, Wheels and Loading

Understanding your Tire Pressure Monitoring System (TPMS)

The Tire Pressure Monitoring System measures pressure in your four road tires and sends the tire pressure readings to your vehicle. The Low Tire Pressure Warning Lamp will turn ON if the tire pressure is significantly low. Once the light is illuminated, your tires are under inflated and need to be inflated to the manufacturer's recommended tire pressure. Even if the light turns ON and a short time later turns OFF, your tire pressure still needs to be checked. Visit www.checkmytires.org for additional information.

When your temporary spare tire is installed

When one of your road tires needs to be replaced with the temporary spare, the TPMS system will continue to identify an issue to remind you that the damaged road wheel/tire needs to be repaired and put back on your vehicle.

To restore the full functionality of the Tire Pressure Monitoring System, have the damaged road wheel/tire repaired and remounted on your vehicle. For additional information, refer to *Changing tires with TPMS* in this section.

Tires, Wheels and Loading

When you believe your system is not operating properly

The main function of the Tire Pressure Monitoring System is to warn you when your tires need air. It can also warn you in the event the system is no longer capable of functioning as intended. Please refer to the following chart for information concerning your Tire Pressure Monitoring System:

Low Tire Pressure Warning Light	Possible cause	Customer Action Required
Solid Warning Light	Tire(s) under-inflated	1. Check your tire pressure to ensure tires are properly inflated; refer to <i>Inflating your tires</i> in this chapter. 2. After inflating your tires to the manufacturer's recommended inflation pressure as shown on the Tire Label (located on the edge of driver's door or the B-Pillar), the vehicle must be driven for at least two minutes over 20 mph (32 km/h) before the light will turn OFF.
	Spare tire in use	Your temporary spare tire is in use. Repair the damaged road wheel/tire and reinstall it on the vehicle to restore system functionality. For a description on how the system functions, refer to <i>When your temporary spare tire is installed</i> in this section.
	TPMS malfunction	If your tires are properly inflated and your spare tire is not in use and the light remains ON, have the system inspected by your authorized dealer.

Tires, Wheels and Loading

Low Tire Pressure Warning Light	Possible cause	Customer Action Required
Flashing Warning Light	Spare tire in use	Your temporary spare tire is in use. Repair the damaged road wheel and re-mount it on the vehicle to restore system functionality. For a description of how the system functions under these conditions, refer to <i>When your temporary spare tire is installed</i> in this section.
	TPMS malfunction	If your tires are properly inflated and your spare tire is not in use and the TPMS warning light still flashes, have the system inspected by your authorized dealer.

When inflating your tires

When putting air into your tires (such as at a gas station or in your garage), the Tire Pressure Monitoring System may not respond immediately to the air added to your tires.

It may take up to two minutes of driving over 20 mph (32 km/h) for the light to turn OFF after you have filled your tires to the recommended inflation pressure.

How temperature affects your tire pressure

The Tire Pressure Monitoring System (TPMS) monitors tire pressure in each pneumatic tire. While driving in a normal manner, a typical passenger tire inflation pressure may increase approximately 2 to 4 psi (14 to 28 kPa) from a cold start situation. If the vehicle is stationary over night with the outside temperature significantly lower than the daytime temperature, the tire pressure may decrease approximately 3 psi (20.7 kPa) for a drop of 30° F (16.6°C) in ambient temperature. This lower pressure value may be detected by the TPMS as being significantly lower than the recommended inflation pressure and activate the TPMS warning for low tire pressure. If the low tire pressure warning light is ON, visually check each tire to verify that no tire is flat. (If one or more tires are flat, repair as necessary.) Check air pressure in the road tires. If any tire is under-inflated, carefully drive the vehicle to the nearest location where air can be added to the tires. Inflate all the tires to the recommended inflation pressure.

Tires, Wheels and Loading

SNOW TIRES AND CABLES



WARNING: Snow tires must be the same size, load index, speed rating as those originally provided by Mazda. Use of any tire or wheel not recommended by Mazda can affect the safety and performance of your vehicle, which could result in an increased risk of loss of vehicle control, vehicle rollover, personal injury and death. Additionally, the use of non-recommended tires and wheels could cause steering, suspension, axle or transfer case/power transfer unit failure.

The tires on your vehicle have all weather treads to provide traction in rain and snow. However, in some climates, you may need to use snow tires and cables. If you need to use cables, it is recommended that steel wheels (of the same size and specifications) be used, as cables may chip aluminum wheels.

Follow these guidelines when using snow tires and traction devices:

- SAE class “S” cables should ONLY be used on the front axle for P235/70R16 tires.
- Install cables securely, verifying that the cables do not touch any wiring, brake lines or fuel lines.
- Drive cautiously. If you hear the cables rub or bang against the vehicle, stop and retighten them. If this does not work, remove the cables to prevent vehicle damage.
- Avoid overloading your vehicle.
- Remove the cables when they are no longer needed.
- Do not use cables on dry roads.
- Do not exceed 30 mph (48 km/h) with tire cables on your vehicle.

Consult your authorized dealer for information on other Mazda Motor Corporation approved methods of traction control.

VEHICLE LOADING – WITH AND WITHOUT A TRAILER

This section will guide you in the proper loading of your vehicle and/or trailer, to keep your loaded vehicle weight within its design rating capability, with or without a trailer. Properly loading your vehicle will provide maximum return of vehicle design performance. Before loading your vehicle, familiarize yourself with the following terms for determining your vehicle’s weight ratings, with or without a trailer, from the vehicle’s Tire Label or Safety Compliance Certification Label:

Base Curb Weight – is the weight of the vehicle including a full tank of fuel and all standard equipment. It does not include passengers, cargo, or optional equipment.

Tires, Wheels and Loading

Vehicle Curb Weight – is the weight of your new vehicle when you picked it up from your authorized dealer plus any aftermarket equipment.

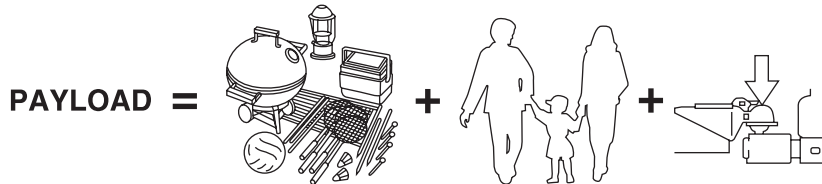

Payload – is the combined weight of cargo and passengers that the vehicle is carrying. The maximum payload for your vehicle can be found on the Tire Label on the B-Pillar or the edge of the driver's door (vehicles exported outside the US and Canada may not have a Tire Label). Look for **“THE COMBINED WEIGHT OF OCCUPANTS AND CARGO SHOULD NEVER EXCEED XXX kg OR XXX lb.”** for maximum payload. The payload listed on the Tire Label is the maximum payload for the vehicle as built by the assembly plant. If any aftermarket or authorized-dealer installed equipment has been installed on the vehicle, the weight of the equipment must be subtracted from the payload listed on the Tire Label in order to determine the new payload.

! WARNING: The appropriate loading capacity of your vehicle can be limited either by volume capacity (how much space is available) or by payload capacity (how much weight the vehicle should carry). Once you have reached the maximum payload of your vehicle, do not add more cargo, even if there is space available. Overloading or improperly loading your vehicle can contribute to loss of vehicle control and vehicle rollover.

Tires, Wheels and Loading

Example only:

TIRE AND LOADING INFORMATION			
SEATING CAPACITY		TOTAL 5	FRONT 2 REAR 3
The combined weight of occupants and cargo should never exceed : XXX kg or XXX lbs.			
TIRE	SIZE	COLD TIRE PRESSURE	SEE OWNERS MANUAL FOR ADDITIONAL INFORMATION
FRONT	LT225/75R 16.5E	200 KPA, 29 PSI	
REAR	LT225/75R 16.5E	200 KPA, 29 PSI	
SPARE	T145/80D16 P225/60R17	420 KPA, 60 PSI 200 KPA, 29 PSI	

TIRE AND LOAD INFORMATION			
SEATING CAPACITY		TOTAL XX	FRONT XX REAR X
NOMBRE DE PLACES		TOTAL	AVANT ARRIERE
The combined weight of occupants and cargo should never exceed . XXX kg. La charge du véhicule (occupants et bagages) ne doit jamais dépasser XXX lbs.			
TIRE PNEUS	SIZE DIMENSIONS	COLD TIRE PRESSURE PRESSION A FROID	SEE OWNERS MANUAL FOR ADDITIONAL INFORMATION CONSULTER LE GUIDE DU PROPRIETAIRE POUR DE PLUS AMPLES RENSEIGNEMENTS
FRONT/ AVANT	LT225/75R 16.5E	200 KPA, 29 PSI	
REAR/ ARRIERE	LT225/75R 16.5E	200 KPA, 29 PSI	
SPARE/ PNEU DE SECOURS	T145/80D16 P225/60R17	420 KPA, 60 PSI 200 KPA, 29 PSI	

CARGO

=



+

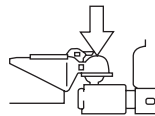

Cargo Weight – includes all weight added to the Base Curb Weight, including cargo and optional equipment. When towing, trailer tongue load or king pin weight is also part of cargo weight.

GAW (Gross Axle Weight) – is the total weight placed on each axle (front and rear) – including vehicle curb weight and all payload.

188

2009 Tribute Hybrid (thv)
Owners Guide, 1st Printing
USA (fus)

Tires, Wheels and Loading

GAWR (Gross Axle Weight Rating) – is the maximum allowable weight that can be carried by a single axle (front or rear). **These numbers are shown on the Safety Compliance Certification Label located on the B-Pillar or the edge of the driver's door. The total load on each axle must never exceed its GAWR.**

Note: For trailer towing information refer to *Trailer towing* found in this chapter or the *RV and Trailer Towing Guide* provided by your authorized dealer.

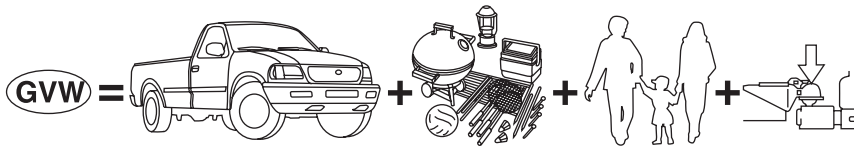

GVW (Gross Vehicle Weight) – is the Vehicle Curb Weight + cargo + passengers.

GVWR (Gross Vehicle Weight Rating) – is the maximum allowable weight of the fully loaded vehicle (including all options, equipment, passengers and cargo). **The GVWR is shown on the Safety Compliance Certification Label located on the B-Pillar or the edge of the driver's door. The GVW must never exceed the GVWR.**

MFD. BY FORD MOTOR CO. IN U.S.A.			
FOR MAZDA MOTOR CORPORATION			
DATE: XX/XX	GVWR: XXXXXLB/XXXXXKG		
FRONT GAWR: XXXXL	REAR GAWR: XXXXLB		
XXXXKG	WITH XXXKG	WITH	
XXXX/XXXXXX	TIRES XXX/XXXXXX	TIRES	
XXXX.XX	RIMS XXXX.XX	RIMS	
AT XXX kPa/XX	PSI COLD	AT XXX kPa/XX	PSI COLD
THIS VEHICLE CONFORMS TO ALL APPLICABLE FEDERAL MOTOR VEHICLE SAFETY AND THEFT PREVENTION STANDARDS IN EFFECT ON THE DATE OF MANUFACTURE SHOWN ABOVE.			
VIN: XXXXXXXXXXXXXXXX			
TYPE: XXX			
EXT PNT: XX	RC: XX	DSO:	
WB ¹ BRK ¹	INT TR ¹	TP/PS ¹	R ¹ AXLE ¹ TR SPR ¹ XXXXX
XXX X	XX	X	XX X XX XXX
XXXXXXXXXXXX XXX XXXX-XXXXXX-XX			

Tires, Wheels and Loading

 **WARNING:** Exceeding the Safety Compliance Certification Label vehicle weight rating limits could result in substandard vehicle handling or performance, engine, transmission and/or structural damage, serious damage to the vehicle, loss of control and personal injury.

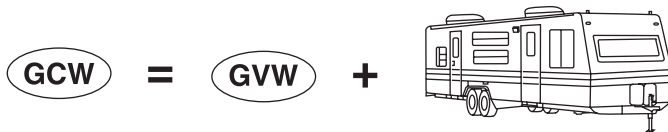

GCW (Gross Combined Weight) – is the weight of the loaded vehicle (GVW) plus the weight of the fully loaded trailer.

GCWR (Gross Combined Weight Rating) – is the maximum allowable weight of the vehicle and the loaded trailer – including all cargo and passengers – that the vehicle can handle without risking damage. (Important: The towing vehicle's braking system is rated for operation at GVWR, not at GCWR.) Separate functional brakes should be used for safe control of towed vehicles and for trailers where the GCW of the towing vehicle plus the trailer exceed the GVWR of the towing vehicle.

The GCW must never exceed the GCWR.

Maximum Loaded Trailer Weight – is the highest possible weight of a fully loaded trailer the vehicle can tow. It assumes a vehicle with only mandatory options, no cargo (internal or external), a tongue load of 10–15% (conventional trailer) or king pin weight of 15–25% (fifth wheel trailer), and driver only (150 lb. [68 kg]). **Consult your authorized dealer (or the *RV and Trailer Towing Guide* provided by your authorized dealer) for more detailed information.**

Tongue Load or Fifth Wheel King Pin Weight – refers to the amount of the weight that a trailer pushes down on a trailer hitch.

Examples: For a 5,000 lb. (2,268 kg) conventional trailer, multiply 5,000 by 0.10 and 0.15 to obtain a proper tongue load range of 500 to 750 lb. (227 to 340 kg). For an 11,500 lb. (5,216 kg) fifth wheel trailer, multiply by 0.15 and 0.25 to obtain a proper king pin load range of 1,725 to 2,875 lb. (782 to 1,304 kg)

 **WARNING:** Do not exceed the GVWR or the GAWR specified on the Safety Compliance Certification Label.

Tires, Wheels and Loading



WARNING: Do not use replacement tires with lower load carrying capacities than the original tires because they may lower the vehicle's GVWR and GAWR limitations. Replacement tires with a higher limit than the original tires do not increase the GVWR and GAWR limitations.



WARNING: Exceeding any vehicle weight rating limitation could result in serious damage to the vehicle and/or personal injury.

Steps for determining the correct load limit:

1. Locate the statement "The combined weight of occupants and cargo should never exceed XXX kg or XXX lb." on your vehicle's placard.
2. Determine the combined weight of the driver and passengers that will be riding in your vehicle.
3. Subtract the combined weight of the driver and passengers from XXX kg or XXX lb.
4. The resulting figure equals the available amount of cargo and luggage load capacity. For example, if the "XXX" amount equals 1,400 lb. and there will be five 150 lb. passengers in your vehicle, the amount of available cargo and luggage load capacity is 650 lb. (1400-750 (5 x 150) = 650 lb.). In metric units (635-340 (5 x 68) = 295 kg.)
5. Determine the combined weight of luggage and cargo being loaded on the vehicle. That weight may not safely exceed the available cargo and luggage load capacity calculated in Step 4.
6. If your vehicle will be towing a trailer, load from your trailer will be transferred to your vehicle. Consult this manual to determine how this reduces the available cargo and luggage load capacity of your vehicle.

The following gives you a few examples on how to calculate the available amount of cargo and luggage load capacity:

- Another example for your vehicle with 1,400 lb. (635 kg) of cargo and luggage capacity. You decide to go golfing. Is there enough load capacity to carry you, 4 of your friends and all the golf bags? You and four friends average 220 lb. (99 kg) each and the golf bags weigh approximately 30 lb. (13.5 kg) each. The calculation would be: 1400 - (5 x 220) - (5 x 30) = 1400 - 1100 - 150 = 150 lb. Yes, you have enough load capacity in your vehicle to transport four friends and your golf bags. In metric units, the calculation would be: 635 kg - (5 x 99 kg) - (5 x 13.5 kg) = 635 - 495 - 67.5 = 72.5 kg.

Tires, Wheels and Loading

- A final example for your vehicle with 1,400 lb. (635 kg) of cargo and luggage capacity. You and one of your friends decide to pick up cement from the local home improvement store to finish that patio you have been planning for the past 2 years. Measuring the inside of the vehicle with the rear seat folded down, you have room for 12-100 lb. (45 kg) bags of cement. Do you have enough load capacity to transport the cement to your home? If you and your friend each weigh 220 lb. (99 kg), the calculation would be: $1400 - (2 \times 220) - (12 \times 100) = 1400 - 440 - 1200 = -240$ lb. No, you do not have enough cargo capacity to carry that much weight. In metric units, the calculation would be: $635 \text{ kg} - (2 \times 99 \text{ kg}) - (12 \times 45 \text{ kg}) = 635 - 198 - 540 = -103$ kg. You will need to reduce the load weight by at least 240 lb. (104 kg). If you remove 3-100 lb. (45 kg) cement bags, then the load calculation would be:
 $1400 - (2 \times 220) - (9 \times 100) = 1400 - 440 - 900 = 60$ lb. Now you have the load capacity to transport the cement and your friend home. In metric units, the calculation would be: $635 \text{ kg} - (2 \times 99 \text{ kg}) - (9 \times 45 \text{ kg}) = 635 - 198 - 405 = 32$ kg.

The above calculations also assume that the loads are positioned in your vehicle in a manner that does not overload the Front or the Rear Gross Axle Weight Rating specified for your vehicle on the Safety Compliance Certification Label found on the edge of the driver's door.

Special loading instructions for owners of pickup trucks and utility-type vehicles



WARNING: For important information regarding safe operation of this type of vehicle, see the *Preparing to drive your vehicle* section in the *Driving* chapter of this *Owner's Manual*.



WARNING: Loaded vehicles may handle differently than unloaded vehicles. Extra precautions, such as slower speeds and increased stopping distance, should be taken when driving a heavily loaded vehicle.

Your vehicle can haul more cargo and people than most passenger cars. Depending upon the type and placement of the load, hauling cargo and people may raise the center of gravity of the vehicle.

Tires, Wheels and Loading

TRAILER TOWING

Mazda strongly discourages towing with the Tribute Hybrid vehicle. Your vehicle is not equipped to tow. No towing packages or towing accessories are available through your dealer.

RECREATIONAL TOWING

An example of “recreational towing” is towing your vehicle behind a motorhome.

Your vehicle may be “flat-towed” (all wheels on the ground) by shifting the transmission into Neutral. This is permitted for Front Wheel Drive (FWD) or Four-Wheel Drive (4WD) vehicles. Your vehicle may be towed up to a speed of 75 mph (120 km/h) but you should always obey local speed limits.

Note: The Hybrid brake system is capable of providing full brake assist with the ignition off. This may cause the vehicle’s 12-volt battery to become discharged when a portable braking system is used to activate the vehicle’s brakes.

You also have the option of trailering the vehicle with its front wheels on a dolly (FWD only), or trailering with all four wheels off the ground.

For other towing requirements, refer to *Wrecker towing* in the *Roadside Emergencies* chapter.

Driving

STARTING

Positions of the ignition

1. Off— locks the gearshift lever and allows key removal.
2. Accessory— allows the electrical accessories such as the radio to operate while the vehicle is not running.
3. On— all electrical circuits operational and warning lights will illuminate. This is the position the key is in when you're driving.
4. Start— starts the engine, vehicle and electrical power systems.

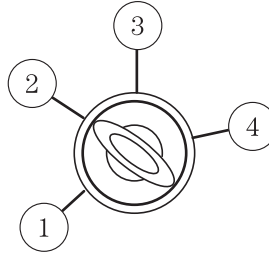

Preparing to start your vehicle

Engine starting is controlled by the electronically-controlled Continuously Variable Transaxle (eCVT). For more information on starting the vehicle, refer to *Starting the vehicle* in this chapter.



WARNING: Extended idling at high engine speeds can produce very high temperatures in the engine and exhaust system, creating the risk of fire or other damage.



WARNING: Do not park, idle, or drive your vehicle in dry grass or other dry ground cover. The emission system heats up the engine compartment and exhaust system, which can start a fire.



WARNING: Do not start your vehicle in a closed garage or in other enclosed areas. Exhaust fumes can be toxic. Always open the garage door before you start the engine. See ***Guarding against exhaust fumes*** in this chapter for more instructions.



WARNING: If you smell exhaust fumes inside your vehicle, have your dealer inspect your vehicle immediately. Do not drive if you smell exhaust fumes.

Important safety precautions

A computer system controls the engine's idle revolutions per minute (RPM). When the engine starts, the idle RPM runs higher than normal in order to warm the engine. If the engine idle speed does not slow down automatically, have the vehicle checked.

Before starting the vehicle:

1. Make sure all vehicle occupants have buckled their seat belts. For more information on seat belts and their proper usage, refer to the *Seating and Safety Restraints* chapter.
 2. Make sure vehicle accessories are off.
- Make sure the parking brake is set.

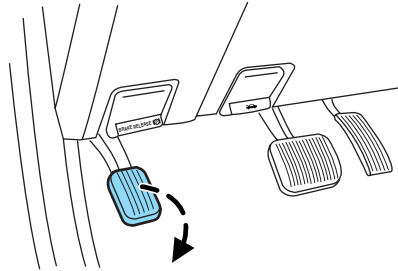

- Make sure the gearshift lever is in P (Park).

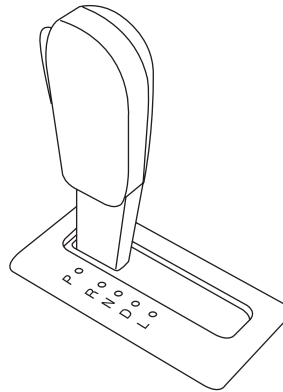

Driving

3. Turn the key to 3 (on) without turning the key to 4 (start).

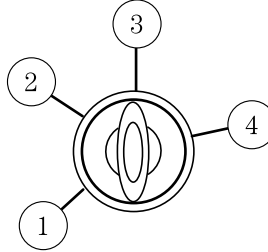

Some warning lights will briefly illuminate. See *Warning lights and chimes* in the *Instrument Cluster* chapter for more information regarding the warning lights.

Starting the vehicle

1. Turn the key to 3 (on) without turning the key to 4 (start). If there is difficulty in turning the key, rotate the steering wheel until the key turns freely. This condition may occur when:

- the front wheels are turned
- a front wheel is against the curb

2. Turn the key to 4 (start), then release the key as soon as the engine begins cranking. Your vehicle has a computer assisted cranking system that assists in starting the engine. After releasing the key from the 4 (start) position, the engine may continue cranking for up to 10 seconds or until the vehicle starts.

Note: Cranking may be stopped at any time by turning the key to the off position.

3. After idling for a few seconds, apply the brake, shift into gear and drive.

Note: After the vehicle has been started, a vehicle symbol (called the Ready Indicator Light) will appear in the instrument cluster to indicate the vehicle is on. This indicator will remain on while the vehicle is on, whether the engine is running or not, to indicate the vehicle is capable of movement (using its electric motor, engine, or both).

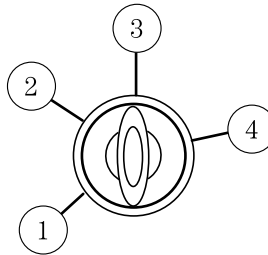

Driving

Note: After starting the vehicle, the engine may stop running to conserve fuel after it is warmed-up and the high voltage battery is sufficiently charged.

Note: If the vehicle does not start, put the gearshift lever into P (Park), turn the ignition off, then attempt to start the vehicle again. If the vehicle still does not start, it may require refueling, jump starting, resetting of the fuel pump/high voltage shut-off switches or service. For information on jump starting the vehicle and resetting the fuel pump/high voltage shut-off switches, refer to the *Jump starting your vehicle* section and the *Fuel pump/High voltage shut-off switches* section found in the *Roadside Emergencies* chapter.

Guarding against exhaust fumes

Carbon monoxide is present in exhaust fumes. Take precautions to avoid its dangerous effects.



WARNING: If you smell exhaust fumes inside your vehicle, have your dealer inspect your vehicle immediately. Do not drive if you smell exhaust fumes.

Important ventilating information

If the engine is idling while the vehicle is stopped for a long period of time, open the windows at least one inch (2.5 cm) or adjust the heating or air conditioning to bring in fresh air.

ENGINE BLOCK/HIGH VOLTAGE BATTERY HEATER (IF EQUIPPED)

An engine block/high voltage battery heater warms the engine coolant and high voltage battery cells which aids in starting and allows the heater/defroster system to respond quickly. If your vehicle is equipped with this system, your equipment includes a heater element which is installed in your engine block and a wire harness which allows the user to connect the system to a grounded 120 volt a/c electrical source. The block heater system is most effective when outdoor temperatures reach below 0°F (-18°C).



WARNING: Failure to follow engine block heater instructions could result in property damage or physical harm.

Driving



WARNING: To reduce the risk of electrical shock, do not use your heater with ungrounded electrical systems or two-pronged (cheater) adapters.

Prior to using the engine block heater, follow these recommendations for proper and safe operation:

- For your safety, use an outdoor extension cord that is product certified by Underwriter's Laboratory (UL) or Canadian Standards Association (CSA). Use only an extension cord that can be used outdoors, in cold temperatures, and is clearly marked "Suitable for Use with Outdoor Appliances." Never use an indoor extension cord outdoors; it could result in an electric shock or fire hazard.
- Use a 16 gauge outdoor extension cord, minimum.
- Use as short an extension cord as possible.
- Do not use multiple extension cords. Instead, use one extension cord which is long enough to reach from the engine block heater cord to the outlet without stretching.
- Make certain that the extension cord is in excellent condition (not patched or spliced). Store your extension cord indoors at temperatures above 32°F (0°C). Outdoor conditions can deteriorate extension cords over a period of time.
- To reduce the risk of electrical shock, do not use your heater with ungrounded electrical systems or two pronged (cheater) adapters. Also ensure that the block heater, especially the cord, is in good condition before use.
- Make sure that when in operation, the extension cord plug /engine block heater cord plug connection is free and clear of water in order to prevent possible shock or fire.
- Be sure that areas where the vehicle is parked are clean and clear of all combustibles such as petroleum products, dust, rags, paper and similar items.
- Be sure that the engine block heater, heater cord and extension cord are solidly connected. A poor connection can cause the cord to become very hot and may result in an electrical shock or fire. Be sure to check for heat anywhere in the electrical hookup once the system has been operating for approximately a half hour.
- Finally, have the engine block heater system checked during your fall tune-up to be sure it's in good working order.

How to use the engine block heater

Ensure the receptacle terminals are clean and dry prior to use. To clean them, use a dry cloth.

Depending on the type of factory installed equipment, your engine block heater system may consume anywhere between 400 watts or 1000 watts of energy per hour. Your factory installed block heater system does not have a thermostat; however, maximum temperature is attained after approximately 3 hours of operation. Block heater operation longer than 3 hours will not improve system performance and will unnecessarily use additional electricity.

Make sure system is unplugged and properly stowed before driving the vehicle. While not in use, make sure the protective cover seals the prongs of the engine block heater cord plug.

BRAKES

Occasional brake noise is normal. If a metal-to-metal, continuous grinding or continuous squeal sound is present, the brake linings may be worn-out and should be inspected by an authorized dealer. If the vehicle has continuous vibration or shudder in the steering wheel while braking, the vehicle should be inspected by an authorized dealer.

Refer to *Brake system warning light* in the *Instrument Cluster* chapter for information on the brake system warning light.



Under normal operating conditions, brake dust may accumulate on the wheels. Some brake dust is inevitable as brakes wear and does not contribute to brake noise. The use of modern friction materials with emphasis on improved performance and environmental considerations can lead to more dust than in the past. Brake dust can be cleaned by weekly washing with soapy water and a soft sponge. Heavier deposits can be removed with Mazda Wheel and Tire Cleaner (ZC-37-A).

Four-wheel anti-lock brake system (ABS)

Your vehicle is equipped with an Anti-lock Braking System (ABS). This system helps you maintain steering control during emergency stops by keeping the brakes from locking. Noise from the ABS pump motor and brake pedal pulsation may be observed during ABS braking and the brake pedal may suddenly travel a little farther as soon as ABS braking is done and normal brake operation resumes. These are normal characteristics of the ABS and should be no reason for concern.

Driving

Using ABS

When hard braking is required, apply continuous force on the brake pedal; do not pump the brake pedal since this will reduce the effectiveness of the ABS and will increase your vehicle's stopping distance. The ABS will be activated immediately, allowing you to retain steering control during hard braking and on slippery surfaces. However, the ABS does not decrease stopping distance.

ABS warning lamp

The ABS lamp in the instrument cluster momentarily illuminates when the ignition is turned on. If the light does not illuminate during start up, remains on or flashes, the ABS may be disabled and may need to be serviced.



Even when the ABS is disabled, normal braking is still effective. If your BRAKE warning lamp illuminates with the parking brake released, have your brake system serviced immediately by an authorized dealer.



Regenerative Braking System (RBS)

Your vehicle uses a feature known as regenerative braking. This is used to simulate the engine braking of an internal combustion engine and assist the standard brake system while recovering some of the energy of motion and storing it in the battery to improve fuel economy. The standard brake system is designed to fully stop the car if regenerative braking is not available. During regenerative braking, the motor is spun as a generator to create electrical current. This recharges the high voltage battery and slows the vehicle. In effect, once the accelerator pedal is released, the motor changes from an energy user to an energy producer.

When the accelerator pedal is released or the brake pedal is applied, the brake controller automatically detects the amount of deceleration requested and optimizes how much of the deceleration will be produced by regenerative braking. The remaining portion is generated by standard friction braking. When the battery is almost fully charged, the amount of regenerative braking is limited to avoid overcharging, and the requested deceleration is produced by standard friction braking alone.

Driving

Regenerative braking does not take the place of the standard friction brakes; it only assists them. Regenerative braking has also been designed to interact with the anti-lock brake system (ABS). Regenerative braking is disabled when the ABS is activated or the battery is fully charged.

Parking brake

Apply the parking brake whenever the vehicle is parked. To set the parking brake, press the parking brake pedal down until the pedal stops.

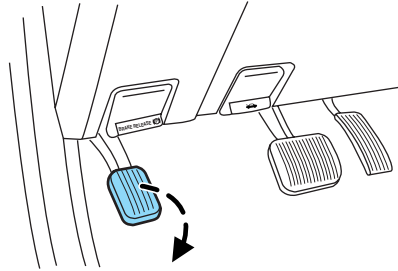

The BRAKE warning lamp in the instrument cluster illuminates and remains illuminated (when the ignition is turned on) until the parking brake is released.



WARNING: If the parking brake is fully released, but the brake warning lamp remains illuminated, the brakes may not be working properly. See your authorized dealer.



WARNING: Always set the parking brake fully and make sure that the gearshift is securely latched in P (Park).

The parking brake is not recommended to stop a moving vehicle. However, if the normal brakes fail, the parking brake can be used to stop your vehicle in an emergency. Since the parking brake applies only the rear brakes, the vehicle's stopping distance will increase greatly and the handling of your vehicle will be adversely affected.

Driving

Pull the release lever to release the brake. Driving with the parking brake on will cause the brakes to wear out quickly and reduce fuel economy.

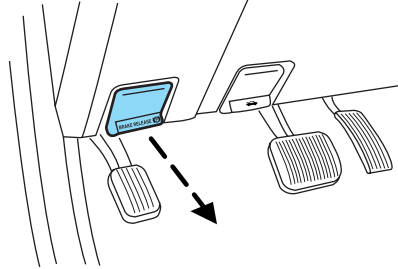



ELECTRONIC STABILITY CONTROL (ESC) SYSTEM

! **WARNING:** Vehicle modifications involving braking system, aftermarket roof racks, suspension, steering system, tire construction and/or wheel/tire size may change the handling characteristics of the vehicle and may adversely affect the the performance of the AdvanceTrac® with RSC® system. In addition, installing any stereo loudspeakers may interfere with and adversely affect the AdvanceTrac® with RSC® system. Install any aftermarket stereo loudspeaker as far as possible from the front center console, the tunnel, and the front seats in order to minimize the risk of interfering with the AdvanceTrac® with RSC® sensors. Reducing the effectiveness of the AdvanceTrac® with RSC® system could lead to an increased risk of loss of vehicle control, vehicle rollover, personal injury and death.

! **WARNING:** Remember that even advanced technology cannot defy the laws of physics. It's always possible to lose control of a vehicle due to inappropriate driver input for the conditions. Aggressive driving on any road condition can cause you to lose control of your vehicle increasing the risk of personal injury or property damage. Activation of the AdvanceTrac® with RSC® system is an indication that at least some of the tires have exceeded their ability to grip the road; this could reduce the operator's ability to control the vehicle, potentially resulting in a loss of vehicle control, vehicle rollover, personal injury and death. If your AdvanceTrac® with RSC® system activates, SLOW DOWN.

Driving



WARNING: If a failure has been detected within the AdvanceTrac® with RSC® system, the "sliding car" icon  will illuminate steadily. Verify that the AdvanceTrac® with RSC® system is not manually disabled (push the AdvanceTrac® with RSC® "Off" button located on the center of the instrument panel). If the "sliding car" icon  still illuminates steadily, have the system service by an authorized dealer immediately. Operating your vehicle with AdvanceTrac® with RSC® disabled could lead to an increased risk of loss of vehicle control, vehicle rollover, personal injury and death.



The AdvanceTrac® with RSC® system provides the following stability enhancement features for certain driving situations:

- Traction Control (TCS), which functions to help avoid drive-wheel spin and loss of traction.
- Electronic Stability Control (ESC), which functions to help avoid skids or lateral slides
- Roll Stability Control™ (RSC®), which functions to help avoid a vehicle roll-over.

The AdvanceTrac® with RSC® system automatically enables each time the engine is started. All features of the AdvanceTrac® with RSC® system (TCS, ESC, and RSC®) are active and monitor the vehicle from start-up. However, the system will only intervene if the driving situation requires it.

The AdvanceTrac® with RSC® system includes an AdvanceTrac® with RSC® "Off" button on the center of the instrument panel, and a "sliding car" icon  in the instrument cluster. The "sliding car"



icon  in the instrument cluster will illuminate temporarily during start-up as part of a normal system self-check, or during driving if a driving situation causes the AdvanceTrac® with RSC® system to operate. If the "sliding car" icon  illuminates steadily, verify that the AdvanceTrac® with RSC® system is not manually disabled by pressing the AdvanceTrac® with RSC® "Off" button located on the center stack of the instrument panel. If the "sliding car" icon  remains steadily illuminated, have the system serviced by an authorized dealer immediately.

Driving

When AdvanceTrac® with RSC® performs a normal system self-check, some drivers may notice a rumble, grunting, or grinding noise after startup and when driving off.

When an event occurs that activates AdvanceTrac® with RSC® you may experience the following:

- A slight deceleration of the vehicle
- The “sliding car”  indicator light will flash.
- A vibration in the pedal when your foot is on the brake pedal
- If the driving condition is severe and your foot is not on the brake, the brake pedal may move as the systems applies higher brake forces. You may also hear a whoosh of air from under the instrument panel during this severe condition.
- The brake pedal may feel stiffer than usual.

Traction Control (TCS)

Traction Control is a driver aid feature that helps your vehicle maintain traction of the wheels, typically when driving on slippery and/or hilly road surfaces, by detecting and controlling wheel spin.

Excessive wheel spin is controlled in two ways, which may work separately or in tandem: Engine Traction Control and Brake Traction Control. Engine Traction Control works to limit drive-wheel spin by momentarily reducing engine power. Brake Traction Control works to limit wheel spin by momentarily applying the brakes to the wheel that is slipping. Traction Control is most active at low speeds.

During Traction Control events the “sliding car” icon  in the instrument cluster will flash.

If the Traction Control system is activated excessively in a short period of time, the braking portion of the system may become temporarily disabled to allow the brakes to cool down. In this situation, Traction Control will use only engine power reduction or transfer to help control the wheels from over-spinning. When the brakes have cooled down, the system will regain all features. Anti-lock braking, RSC®, and ESC are not affected by this condition and will continue to function during the cool-down period.

The Engine Traction Control and Brake Traction Control system may be deactivated in certain situations. See the *Switching Off AdvanceTrac® with RSC®* section following.

Electronic Stability Control (ESC)

Electronic Stability Control (ESC) may enhance your vehicle's directional stability during adverse maneuvers, for example when cornering severely or avoiding objects in the roadway. ESC operates by applying brakes to one or more of the wheels individually and, if necessary, reducing engine power if the system detects that the vehicle is about to skid or slide laterally.

During Electronic Stability Control events the “sliding car” icon  in the instrument cluster will flash.

Certain adverse driving maneuvers may activate the Electronic Stability Control system, which include but are not limited to:

- Taking a turn too fast
- Maneuvering quickly to avoid an accident, pedestrian or obstacle
- Driving over a patch of ice or other slippery surfaces
- Changing lanes on a snow-rutted road
- Entering a snow-free road from a snow-covered side street, or vice versa
- Entering a paved road from a gravel road, or vice versa
- Cornering while towing a heavily loaded trailer (refer to *Trailer towing* in the *Tires, Wheels and Loading* chapter).

The Electronic Stability Control system may be deactivated in certain situations. See the *Switching Off AdvanceTrac® with RSC®* section following.

Roll Stability Control™ (RSC®)

Roll Stability Control™ (RSC®) may help to maintain roll stability of the vehicle during adverse maneuvers. RSC® operates by detecting the vehicle's roll motion and the rate at which it changes and by applying the brakes to one or more wheels individually.

During an event that activates the Roll Stability Control™ (RSC®) the “sliding car” icon  in the instrument cluster will flash.

Certain adverse driving maneuvers may activate the Roll Stability Control system, which include:



- Emergency lane-change
- Taking a turn too fast
- Quick maneuvering to avoid an accident, pedestrian or obstacle

Driving

The Roll Stability Control system may be deactivated in certain situations. See the *Switching Off AdvanceTrac® with RSC®* section following.

Switching Off AdvanceTrac® with RSC®

If the vehicle is stuck in snow, mud or sand, and seems to lose engine power, switching off certain features of the AdvanceTrac® with RSC® system may be beneficial because the wheels are allowed to spin. This will restore full engine power and will enhance momentum through the obstacle. To switch off the AdvanceTrac® with RSC® system press the AdvanceTrac® with RSC® "Off" button. Full features of the AdvanceTrac® with RSC® system can be restored by pressing the AdvanceTrac® with RSC® "Off" button again or by turning off and restarting the engine.

If you switch off the AdvanceTrac® with RSC® system, the "sliding car" icon  will illuminate steadily. Pressing the AdvanceTrac® with RSC® "Off" button again will turn off the "sliding car" icon .

In R (Reverse), ABS and the Engine and Brake Traction Control features will continue to function; however, ESC and RSC® are disabled.

AdvanceTrac® with RSC® Features				
Button functions	"Sliding car" icon 	RSC®	ESC	Traction Control
Default at start-up	Illuminated during bulb check	Enabled	Enabled	Enabled
Button pressed momentarily	Illuminated solid	Enabled	Enabled	Disabled
Button pressed again after deactivation	Not illuminated	Enabled	Enabled	Enabled

STEERING

Your vehicle is equipped with an Electric Power-Assisted Steering (EPAS) system. There is no fluid reservoir to check or fill.

If your vehicle loses electrical power while you are driving (or if the ignition is turned off), you can steer the vehicle manually, but it takes more effort. Under extreme usage conditions, the steering effort may increase. This occurs to prevent overheating and permanent damage to

Driving

your steering system. If this should occur, you will neither lose the ability to steer the vehicle manually nor will it cause permanent damage. Typical steering and driving maneuvers will allow the system to cool and steering assist will return to normal.

If the steering wanders or pulls, check for:

- an improperly inflated tire
- uneven tire wear
- loose or worn suspension components
- loose or worn steering components
- improper steering alignment

A high crown in the road or high crosswinds may also make the steering seem to wander/pull.

PREPARING TO DRIVE



WARNING: Utility vehicles have a significantly higher rollover rate than other types of vehicles.



WARNING: In a rollover crash, an unbelted person is significantly more likely to die than a person wearing a seat belt.

Utility vehicles and trucks have larger tires and increased ground clearance, giving the vehicle a higher center of gravity than a passenger car.



WARNING: Vehicles with a higher center of gravity such as utility vehicles and trucks handle differently than vehicles with a lower center of gravity. Utility vehicles and trucks are not designed for cornering at speeds as high as passenger cars any more than low-slung sports cars are designed to perform satisfactorily under off-road conditions. Avoid sharp turns, excessive speed or abrupt maneuvers in these vehicles. Failure to drive cautiously could result in an increased risk of loss of vehicle control, vehicle rollover, personal injury and death.



WARNING: Loaded vehicles, with a higher center of gravity, may handle differently than unloaded vehicles. Do not overload your vehicle and use extra precautions, such as driving at slower speeds, avoiding abrupt steering changes and allowing for increased stopping distance, when driving a heavily loaded vehicle. Over-loading or loading the vehicle improperly can deteriorate handling capability and contribute to loss of vehicle control and vehicle rollover.

Driving

AUTOMATIC TRANSMISSION OPERATION

Brake-shift interlock

This vehicle is equipped with a brake-shift interlock feature that prevents the gearshift lever from being moved from P (Park) when the ignition is in the on position unless brake pedal is depressed.

If you cannot move the gearshift lever out of P (Park) with ignition in the on position and the brake pedal depressed, it is possible that a fuse has blown or the vehicle's brake lamps are not operating properly. Refer to *Fuses and relays* in the *Roadside Emergencies* chapter.

If the fuse is not blown, perform the following procedure:

1. Apply the parking brake.
2. Using a screwdriver or similar tool, carefully pry out the small Brake Transmission Shift Interlock (BTSI) cover cap located to the right of the gearshift lever.
3. Depress the brake pedal and then start the vehicle.
4. Insert a screwdriver or similar tool straight down into the access hole and press downward while pulling the gearshift lever out of the P (Park) position and into the N (Neutral) position.
5. Remove tool and reinstall BTSI cover cap.
6. Release the parking brake and drive normally.

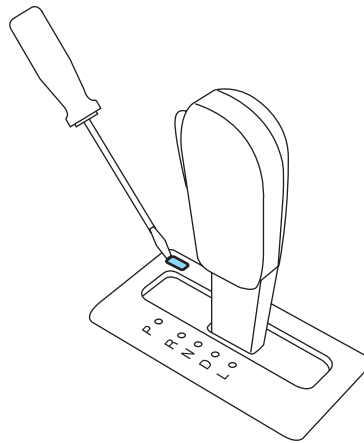

WARNING: Do not drive your vehicle until you verify that the brakelamps are working.



WARNING: Always set the parking brake fully and make sure the gearshift is latched in P (Park). Turn the ignition to the off position and remove the key whenever you leave your vehicle.

Driving



WARNING: If the parking brake is fully released, but the brake warning lamp remains illuminated, the brakes may not be working properly. Drive slowly and carefully to your authorized dealer.

Understanding the gearshift positions of the electronically-controlled Continuously Variable Transmission (eCVT)

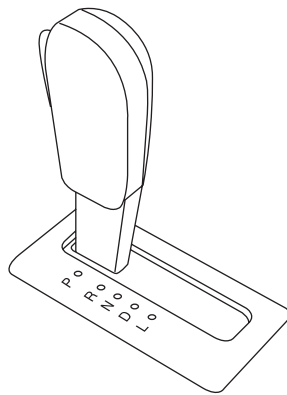

P (Park)

This position locks the transmission and prevents the front wheels from turning.

To put your vehicle in gear:

- Start the engine
- Release the parking brake
- Depress the brake pedal
- Move the gearshift lever into the desired gear

To put your vehicle in P (Park):

- Come to a complete stop
- Move the gearshift lever and securely latch it in P (Park)

Driving



WARNING: Always set the parking brake fully and make sure the gearshift is latched in P (Park). Turn the ignition to the LOCK position and remove the key whenever you leave your vehicle.

R (Reverse)

With the gearshift lever in R (Reverse), the vehicle will move backward. Always come to a complete stop before shifting into and out of R (Reverse).

N (Neutral)

With the gearshift lever in N (Neutral), the vehicle is free to roll; hold the brake pedal down while in this position. Because of the unique nature of the hybrid vehicle, the engine will not start in the N (Neutral) position.

The vehicle does not charge the high voltage battery in the N (Neutral) position. Do not idle the vehicle in N (Neutral) for extended periods as this will discharge your high voltage battery.

D (Drive)

The normal driving position for the best fuel economy.

L (Low)

- Provides maximum engine braking.
- The transmission may be shifted into L (Low) at any vehicle speed.



WARNING: When parking, do not use the gearshift in place of the parking brake. Always set the parking brake fully and make sure that the gearshift is securely latched in P (Park). Turn off the ignition whenever you leave your vehicle. Never leave your vehicle unattended while it is running. If you do not take these precautions, your vehicle may move unexpectedly and injure someone.

If your vehicle gets stuck in mud or snow

If your vehicle gets stuck in mud or snow, it may be rocked out by shifting between forward and reverse gears, stopping between shifts in a steady pattern. Press lightly on the accelerator in each gear.

Do not rock the vehicle if the engine is not at normal operating temperature or damage to the transmission may occur.

Do not rock the vehicle for more than a minute or damage to the transmission and tires may occur, or the engine may overheat.

210

FOUR WHEEL DRIVE (4WD) SYSTEM (IF EQUIPPED)



WARNING: For important information regarding safe operation of this type of vehicle, see *Preparing to drive your vehicle in this chapter*.

Your vehicle is equipped with an intelligent 4WD System that continuously monitors vehicle conditions and automatically adjusts the power distribution between the front and rear wheels. It combines transparent all-surface operation with highly capable four-wheel drive.

The 4WD system is always active and requires no driver input. It is capable of handling all road conditions, including street and highway driving as well as off-road and winter driving.

Driving off-road with truck and utility vehicles

4WD vehicles are specially equipped for driving on sand, snow, mud and rough terrain and have operating characteristics that are somewhat different from conventional vehicles, both on and off the road.

How your vehicle differs from other vehicles

Truck and utility vehicles can differ from some other vehicles. Your vehicle may be higher to allow it to travel over rough terrain without getting hung up or damaging underbody components.

The differences that make your vehicle so versatile also make it handle differently than an ordinary passenger car.

Maintain steering wheel control at all times, especially in rough terrain. Since sudden changes in terrain can result in abrupt steering wheel motion, make sure you grip the steering wheel from the outside. Do not grip the spokes.

Drive cautiously to avoid vehicle damage from concealed objects such as rocks and stumps.

You should either know the terrain or examine maps of the area before driving. Map out your route before driving in the area. To maintain steering and braking control of your vehicle, you must have all four wheels on the ground and they must be rolling, not sliding or spinning.

Basic operating principles

- Drive slower in strong crosswinds which can affect the normal steering characteristics of your vehicle.
- Be extremely careful when driving on pavement made slippery by loose sand, water, gravel, snow or ice.

Driving

If your vehicle goes off the edge of the pavement

- If your vehicle goes off the edge of the pavement, slow down, but avoid severe brake application, and ease the vehicle back onto the pavement only after reducing your speed. Do not turn the steering wheel too sharply while returning to the road surface.
- It may be safer to stay on the apron or shoulder of the road and slow down gradually before returning to the pavement. You may lose control if you do not slow down or if you turn the steering wheel too sharply or abruptly.
- It often may be less risky to strike small objects, such as highway reflectors, with minor damage to your vehicle rather than attempt a sudden return to the pavement which could cause the vehicle to slide sideways out of control or roll over. Remember, your safety and the safety of others should be your primary concern.



WARNING: Vehicles with a higher center of gravity such as utility and four-wheel drive vehicles handle differently than vehicles with a lower center of gravity. Utility and four-wheel drive vehicles are not designed for cornering at speeds as high as passenger cars any more than low-slung sports cars are designed to perform satisfactorily under off-road conditions. Avoid sharp turns, excessive speed and abrupt maneuvers in these vehicles. Failure to drive cautiously could result in an increased risk of loss of vehicle control, vehicle rollover, personal injury and death.

If your vehicle gets stuck

If your vehicle gets stuck in mud or snow it may be rocked out by shifting between forward and reverse gears, stopping between shifts, in a steady pattern. Press lightly on the accelerator in each gear.

Do not rock the vehicle if the engine is not at normal operating temperature or damage to the transmission may occur.

Do not rock the vehicle for more than a few minutes or damage to the transmission and tires may occur or the engine may overheat.



WARNING: Always set the parking brake fully and make sure the gearshift is latched in P (Park). Turn the ignition to the LOCK position and remove the key whenever you leave your vehicle.

Driving



WARNING: If the parking brake is fully released, but the brake warning lamp remains illuminated, the brakes may not be working properly. See your authorized dealer.



WARNING: Do not spin the wheels at over 35 mph (56 km/h). The tires may fail and injure a passenger or bystander.

Emergency maneuvers

- In an unavoidable emergency situation where a sudden sharp turn must be made, remember to avoid “over-driving” your vehicle, i.e., turn the steering wheel only as rapidly and as far as required to avoid the emergency. Excessive steering will result in less vehicle control, not more. Additionally, smooth variations of the accelerator and/or brake pedal pressure should be utilized if changes in vehicle speed are required. Avoid abrupt steering, acceleration or braking which could result in an increased risk of loss of vehicle control, vehicle rollover and/or personal injury. Use all available road surface to return the vehicle to a safe direction of travel.
- In the event of an emergency stop, avoid skidding the tires and do not attempt any sharp steering wheel movements.



WARNING: Vehicles with a higher center of gravity such as utility and four-wheel drive vehicles handle differently than vehicles with a lower center of gravity. Utility and four-wheel drive vehicles are not designed for cornering at speeds as high as passenger cars any more than low-slung sports cars are designed to perform satisfactorily under off-road conditions. Avoid sharp turns, excessive speed and abrupt maneuvers in these vehicles. Failure to drive cautiously could result in an increased risk of loss of vehicle control, vehicle rollover, personal injury and death.

- If the vehicle goes from one type of surface to another (i.e., from concrete to gravel) there will be a change in the way the vehicle responds to a maneuver (steering, acceleration or braking). Again, avoid these abrupt inputs.

Sand

When driving over sand, try to keep all four wheels on the most solid area of the trail. Avoid reducing the tire pressures and drive steadily through the terrain. Apply the accelerator slowly and avoid spinning the wheels.

Driving

Avoid excessive speed because vehicle momentum can work against you and cause the vehicle to become stuck to the point that assistance may be required from another vehicle. Remember, you may be able to back out the way you came if you proceed with caution.

Mud and water

If you must drive through high water, drive slowly. Traction or brake capability may be limited.

When driving through water, determine the depth; avoid water higher than the bottom of the hubs (if possible) and proceed slowly. If the ignition system gets wet, the vehicle may stall.

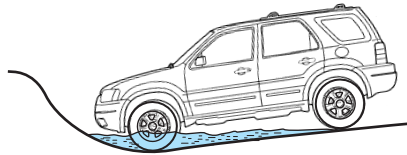

Once through water, always try the brakes. Wet brakes do not stop the vehicle as effectively as dry brakes. Drying can be improved by moving your vehicle slowly while applying light pressure on the brake pedal.

Be cautious of sudden changes in vehicle speed or direction when you are driving in mud. Even 4WD vehicles can lose traction in slick mud. As when you are driving over sand, apply the accelerator slowly and avoid spinning your wheels. If the vehicle does slide, steer in the direction of the slide until you regain control of the vehicle.

If the transmission, transfer case or front axle are submerged in water, their fluids should be checked and changed, if necessary.

Driving through deep water may damage the transmission.

If the front or rear axle is submerged in water, the axle lubricant should be replaced.

After driving through mud, clean off residue stuck to rotating driveshafts and tires. Excess mud stuck on tires and rotating driveshafts causes an imbalance that could damage drive components.

“Tread Lightly” is an educational program designed to increase public awareness of land-use regulations and responsibilities in our nation’s wilderness areas. Mazda Motor

Corporation joins the U.S. Forest Service and the Bureau of Land Management in encouraging you to help preserve our national forest and other public and private lands by “treading lightly.”



Driving on hilly or sloping terrain

Although natural obstacles may make it necessary to travel diagonally up or down a hill or steep incline, you should always try to drive straight up or straight down. **Avoid driving crosswise or turning on steep slopes or hills.** A danger lies in losing traction, slipping sideways and possibly rolling over. Whenever driving on a hill, determine beforehand the route you will use. Do not drive over the crest of a hill without seeing what conditions are on the other side. Do not drive in reverse over a hill without the aid of an observer.

If you do stall out, do not try to turn around because you might roll over. It is better to back down to a safe location.

Apply just enough power to the wheels to climb the hill. Too much power will cause the tires to slip, spin or lose traction, resulting in loss of vehicle control.

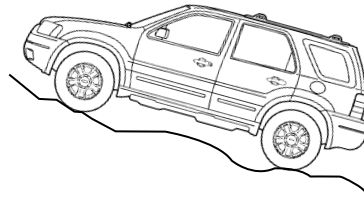

Descend a hill in the same gear you would use to climb up the hill to avoid excessive brake application and brake overheating. Do not descend in neutral; instead, disengage overdrive or manually shift to a lower gear. When descending a steep hill, avoid sudden hard braking as you could lose control. When you brake hard, the front wheels can't turn and if they aren't turning, you won't be able to steer. The front wheels have to be turning in order to steer the vehicle. Rapid pumping of the brake pedal will help you slow the vehicle and still maintain steering control.

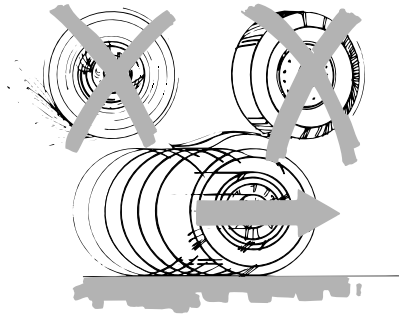

Since your vehicle has anti-lock brakes, apply the brakes steadily. Do not "pump" the brakes.

Driving

Driving on snow and ice

4WD vehicles have advantages over 2WD vehicles in snow and ice but can skid like any other vehicle.

Should you start to slide while driving on snowy or icy roads, turn the steering wheel in the direction of the slide until you regain control.

Avoid sudden applications of power and quick changes of direction on snow and ice. Apply the accelerator slowly and steadily when starting from a full stop.

Avoid sudden braking as well. Although a 4WD vehicle may accelerate better than a two-wheel drive vehicle in snow and ice, it won't stop any faster, because as in other vehicles, braking occurs at all four wheels. Do not become overconfident as to road conditions.

Make sure you allow sufficient distance between you and other vehicles for stopping; drive slower than usual. Since your vehicle is equipped with a Four Wheel Anti-Lock Brake System (ABS), apply the brake steadily. Do not "pump" the brakes. Refer to the *Brakes* section of this chapter for additional information on the operation of the anti-lock brake system.

4WD vehicles should be driven with traction devices as referred to in *Using snow tires and traction devices* in the *Tires, Wheels and Loading* chapter.

Maintenance and Modifications

The suspension and steering systems on your vehicle have been designed and tested to provide durable load carrying capability and predictable performance whether loaded or empty. For this reason, Mazda Motor Corporation strongly recommends that you do not make modifications such as adding or removing parts (such as lift kits or stabilizer bars) or using replacement parts not equivalent to the original factory equipment.

Any modifications to a vehicle that raise the center of gravity can make it more likely the vehicle will roll over as a result of a loss of control. Mazda Motor Corporation recommends that caution be used with any vehicle equipped with a high load or device (such as ladder racks or pickup box cover).

Failure to maintain your vehicle properly may void the warranty, increase your repair cost, reduce vehicle performance and operational capabilities and adversely affect driver and passenger safety. Frequent inspection of vehicle chassis components is recommended if the vehicle is subjected to heavy off-road usage.

216

***2009 Tribute Hybrid (thv)
Owners Guide, 1st Printing
USA (fus)***

DRIVING THROUGH WATER

If driving through deep or standing water is unavoidable, proceed very slowly especially when the depth is not known. Never drive through water that is higher than the bottom of the wheel rims (for cars) or the bottom of the hubs (for trucks).

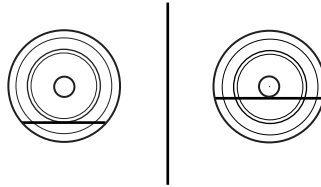

When driving through water, traction or brake capability may be limited. Also, water may enter your engine's air intake and severely damage your engine or your vehicle may stall. **Driving through deep water where the transmission vent tube is submerged may allow water into the transmission and cause internal transmission damage.**

Once through the water, always dry the brakes by moving your vehicle slowly while applying light pressure on the brake pedal. Wet brakes do not stop the vehicle as quickly as dry brakes.

Roadside Emergencies

HAZARD FLASHER CONTROL

The hazard flasher is located on the steering column, just behind the steering wheel. The hazard flashers will operate when the ignition is in any position or if the key is not in the ignition.

Push in the flasher control and all front and rear direction signals will flash. Press the flasher control again to turn them off. Use it when your vehicle is disabled and is creating a safety hazard for other motorists.

Note: With extended use, the flasher may run down your low voltage (underhood) battery.

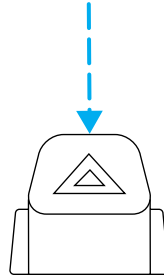

FUEL PUMP/HIGH VOLTAGE SHUT-OFF SWITCHES

The fuel pump shut-off switch stops the electric fuel pump from sending fuel to the engine and the high voltage shut-off switch shuts off power from the high voltage battery when your vehicle receives a substantial physical jolt.

After an accident, if the engine does not start, one or both of the switches may have been activated.

Roadside Emergencies

The fuel pump shut-off switch is located in the front passenger's footwell, behind a flip-up cover.

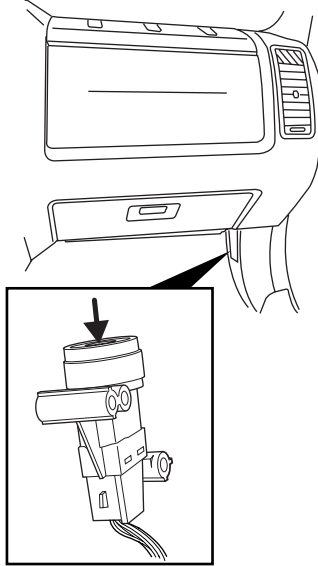

The high voltage shut-off switch is located in the cargo area on the passenger side of the vehicle in the jack compartment, behind the jack access door. The switch is located behind the jack.

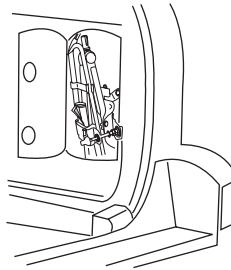

Roadside Emergencies

To reset the switch(es):

1. Turn the ignition to the off position.
2. Check the fuel system for leaks.
3. If no leaks are apparent, reset the switch by pushing in on the reset button. Both switches should be checked and reset.
4. Turn the ignition to the on position.
5. Wait a few seconds and return the key to the off position.
6. Make another check for leaks.

If you see or smell fuel, do not reset the fuel pump shut-off or try to start your vehicle; you could injure yourself or others. Have all the passengers get out of the vehicle and call the local fire department or a towing service.

FUSES AND RELAYS

Fuses

If electrical components in the vehicle are not working, a fuse may have blown. Blown fuses are identified by a broken wire within the fuse. Check the appropriate fuses before replacing any electrical components.

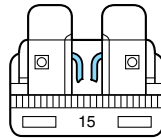

Note: Always replace a fuse with one that has the specified amperage rating. Using a fuse with a higher amperage rating can cause severe wire damage and could start a fire.

Roadside Emergencies

Standard fuse amperage rating and color

Fuse rating	COLOR				
	Mini fuses	Standard fuses	Maxi fuses	Cartridge maxi fuses	Fuse link cartridge
2A	Grey	Grey	—	—	—
3A	Violet	Violet	—	—	—
4A	Pink	Pink	—	—	—
5A	Tan	Tan	—	—	—
7.5A	Brown	Brown	—	—	—
10A	Red	Red	—	—	—
15A	Blue	Blue	—	—	—
20A	Yellow	Yellow	Yellow	Blue	Blue
25A	Natural	Natural	—	—	—
30A	Green	Green	Green	Pink	Pink
40A	—	—	Orange	Green	Green
50A	—	—	Red	Red	Red
60A	—	—	Blue	Yellow	Yellow
70A	—	—	Tan	—	Brown
80A	—	—	Natural	Black	Black

Passenger compartment fuse panel

The fuse panel is located on the right-hand side of the center console, by the instrument panel. Remove the panel cover to access the fuse cover. Press the tabs on the top and bottom of the fuse cover to remove.

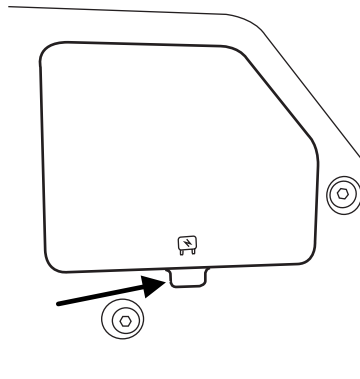

Roadside Emergencies

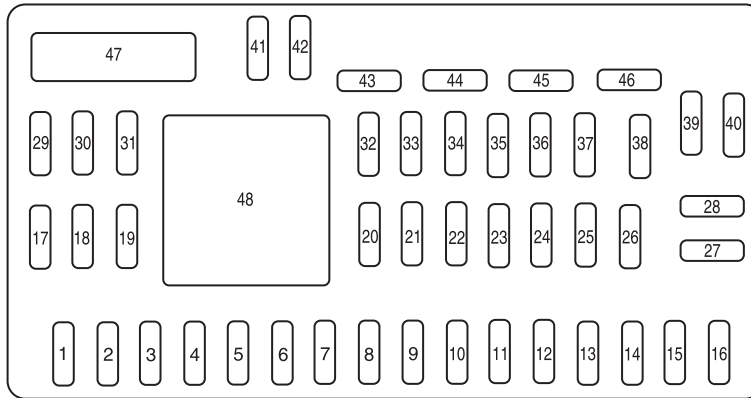

The fuses are coded as follows:

Fuse/Relay Location	Fuse Amp Rating	Protected Circuits
1	30A	110V inverter
2	15A	Brake On/Off switch
3	15A	Not used (spare)
4	30A	Moon roof
5	10A	Brake Shift Interlock (BSI), SPDJB
6	20A	Turn signals, Stop lamps
7	10A	Low beam headlamps (left)
8	10A	Low beam headlamps (right)
9	15A	Interior lights
10	15A	Backlighting
11	10A	Four wheel drive
12	7.5A	Power mirror switch
13	5A	Not used (spare)
14	10A	FCIM (radio buttons), Satellite radio, Front display module
15	10A	Climate control

222

2009 Tribute Hybrid (thv)
 Owners Guide, 1st Printing
 USA (fus)

Roadside Emergencies

Fuse/Relay Location	Fuse Amp Rating	Protected Circuits
16	15A	Not used (spare)
17	20A	All lock motor feeds, Liftgate release, Liftglass release
18	20A	Heated seat
19	25A	Rear wiper
20	15A	Datalink
21	15A	Fog lamps
22	15A	Park lamps
23	15A	High beam headlamps
24	20A	Horn relay
25	10A	Demand lamps
26	10A	Instrument panel cluster
27	20A	Ignition switch
28	5A	Radio
29	5A	Instrument panel cluster
30	5A	Not used (spare)
31	10A	Restraints control module
32	10A	Not used (spare)
33	10A	Not used (spare)
34	5A	Not used (spare)
35	10A	Four wheel drive, EPAS (steering), 110V inverter module
36	5A	PATS transceiver
37	10A	Climate control
38	20A	Subwoofer/Amp (Audiophile radio)
39	20A	Radio, Radio amplifier (navigation)
40	20A	Front power point

Roadside Emergencies

Fuse/Relay Location	Fuse Amp Rating	Protected Circuits
41	15A	Driver/passenger door lock switches, Auto dimming mirror, Compass, Ambient lighting, Moon roof
42	10A	Not used (spare)
43	10A	Rear wiper logic, Heated seats relay, Instrument cluster
44	10A	Not used (spare)
45	5A	Front wiper logic, Blower motor relay
46	7.5A	OCS (restraints), PADI (restraints)
47	30A Circuit Breaker	Power windows
48	—	Delayed accessory relay

Power distribution box

The power distribution box is located in the engine compartment. The power distribution box contains high-current fuses that protect your vehicle's main electrical systems from overloads.



WARNING: Always disconnect the low voltage (underhood) battery before servicing high current fuses.



WARNING: To reduce risk of electrical shock, always replace the cover to the power distribution box before reconnecting the low voltage (underhood) battery or refilling fluid reservoirs.

If the low voltage (underhood) battery has been disconnected and reconnected, refer to the *Low voltage (underhood) battery* section of the *Maintenance and Specifications* chapter.

Roadside Emergencies

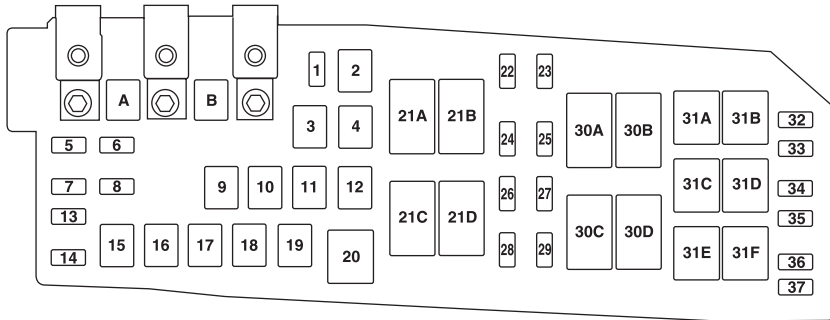

The fuses are coded as follows.

Fuse/Relay Location	Fuse Amp Rating	Protected Circuits
A	80A Midi	Power steering control module
B	125A Midi	SPDJB
1	15A*	Heated mirror
2	30A**	Rear defroster
3	20A**	Rear power point
4	40A**	Electric vacuum pump
5	10A*	Powertrain Control Module (PCM) Keep Alive power, PCM relay, Transmission control module, Canister vent
6	—	Not used
7	15A*	Liftgate latch
8	5A*	Traction battery control module
9	50A**	Brake control module
10	30A**	Front wipers
11	—	Not used
12	40A**	Blower motor
13	10A*	A/C clutch
14	10A*	Heater/Coolant pump

Roadside Emergencies

Fuse/Relay Location	Fuse Amp Rating	Protected Circuits
15	50A**	Traction Battery Control Module (TBCM)
16	40A**	Cooling fan 1
17	40A**	Cooling fan 2
18	50A**	Brake control module solenoid
19	30A**	Power seats
20	—	A/C clutch relay
21A	—	Rear defroster relay
21B	—	Ignition relay
21C	—	Blower relay
21D	—	PCM relay
22	15A*	Ignition coils
23	15A*	Fuel injectors
24	10A*	Transmission control module
25	5A*	Traction battery control module, Thermal expansion valve
26	20A*	Fuel pump, Traction battery control module
27	10A*	PCM (non-mil-malfunction indicator lamp)
28	15A*	Heated Exhaust Gas Oxygen (HEGO) sensor, PCM (mil-on — malfunction indicator lamp)
29	15A*	PCM power
30A	—	Cooling fan 1 relay
30B	—	Electric vacuum pump mechanical relay
30C	—	Cooling fan main relay
30D	—	Cooling fan 2 relay
31A	—	Reverse lamp relay
31B	—	Not used
31C	—	Heater pump relay

Roadside Emergencies

Fuse/Relay Location	Fuse Amp Rating	Protected Circuits
31D	—	Coolant pump relay
31E	—	Not used
31F	—	Liftgate latch relay
32	—	A/C clutch diode
33	—	PCM diode
34	—	Not used
35	10A*	Run/start, Reverse lamps
36	—	Not used
37	—	Not used

* Mini fuse ** Cartridge fuse

Auxiliary relay box

The relay box is located in the engine compartment on the radiator support bracket.

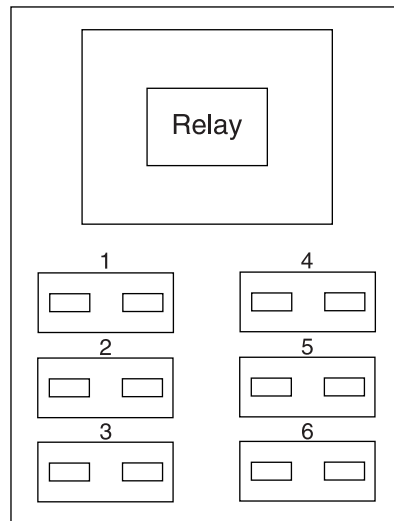

Roadside Emergencies

Fuse/Relay location	Fuse amp rating	Description
Relay	—	Electric vacuum pump (solid state)
1	—	Not used
2	—	Not used
3	—	Not used
4	5A*	Vacuum pump monitor
6	—	Not used

* Mini fuses **Cartridge fuse

CHANGING A FLAT TIRE

If you get a flat tire while driving:

- do not brake heavily.
- gradually decrease the vehicle's speed.
- hold the steering wheel firmly.
- slowly move to a safe place on the side of the road.

Your vehicle may be equipped with a conventional spare tire that is different in one or more of the following: type, brand, size, speed rating and tread design. If this is the case, this dissimilar spare tire is still rated for your vehicle loads (GAWR and GVWR). This temporary spare tire is not equipped with a Tire Pressure Monitor System (TPMS) sensor.

Note: The tire pressure monitoring system (TPMS) indicator light will illuminate when the spare is in use. To restore the full functionality of the TPMS system, all road wheels equipped with the tire pressure monitoring sensors must be mounted on the vehicle.

Have a flat tire serviced by an authorized dealer in order to prevent damage to the TPMS sensor, refer to *Tire Pressure Monitoring System (TPMS)* in the *Tires, Wheels, and Loading* chapter. Replace the spare tire with a road tire as soon as possible. During repairing or replacing of the flat tire, have the authorized dealer inspect the TPMS sensor for damage.



WARNING: The use of tire sealants may damage your Tire Pressure Monitoring System and should not be used.

Roadside Emergencies



WARNING: Refer to *Tire Pressure Monitoring System (TPMS)* in the *Tire, Wheels and Loading* chapter for important information. If the tire pressure monitor sensor becomes damaged, it will no longer function.

Dissimilar spare tire/wheel information



WARNING: Failure to follow these guidelines could result in an increased risk of loss of vehicle control, injury or death.

If you have a dissimilar spare tire/wheel, then it is intended for temporary use only. This means that if you need to use it, you should replace it as soon as possible with a road tire/wheel that is the same size and type as the road tires and wheels that were originally provided by Mazda. If the dissimilar spare tire or wheel is damaged, it should be replaced rather than repaired.

A dissimilar spare tire/wheel is defined as a spare tire and/or wheel that is different in brand, size or appearance from the road tires and wheels and can be one of three types:

1. **T-type mini-spare:** This spare tire begins with the letter “T” for tire size and may have “Temporary Use Only” molded in the sidewall
2. **Full-size dissimilar spare with label on wheel:** This spare tire has a label on the wheel that states: “THIS TIRE AND WHEEL FOR TEMPORARY USE ONLY”

When driving with one of the dissimilar spare tires listed above, **do not:**

- Exceed 50 mph (80 km/h)
- Load the vehicle beyond maximum vehicle load rating listed on the Safety Compliance Label
- Tow a trailer
- Use snow chains on the end of the vehicle with the dissimilar spare tire
- Use more than one dissimilar spare tire at a time
- Use commercial car washing equipment
- Try to repair the dissimilar spare tire

Roadside Emergencies

Use of one of the dissimilar spare tires listed above at any one wheel location can lead to impairment of the following:

- Handling, stability and braking performance
- Comfort and noise
- Ground clearance and parking at curbs
- Winter weather driving capability
- Wet weather driving capability

3. Full-size dissimilar spare without label on wheel

When driving with the full-size dissimilar spare tire/wheel, **do not:**

- Exceed 70 mph (113 km/h)
- Use more than one dissimilar spare tire/wheel at a time
- Use commercial car washing equipment
- Use snow chains on the end of the vehicle with the dissimilar spare tire/wheel

The usage of a full-size dissimilar spare tire/wheel can lead to impairment of the following:

- Handling, stability and braking performance
- Comfort and noise
- Ground clearance and parking at curbs
- Winter weather driving capability
- Wet weather driving capability
- All-Wheel driving capability (if applicable)
- Load leveling adjustment (if applicable)

When driving with the full-size dissimilar spare tire/wheel additional caution should be given to:

- Towing a trailer
- Driving vehicles equipped with a camper body
- Driving vehicles with a load on the cargo rack

Drive cautiously when using a full-size dissimilar spare tire/wheel and seek service as soon as possible.

230

*2009 Tribute Hybrid (thv)
Owners Guide, 1st Printing
USA (fus)*

Roadside Emergencies

Stopping and securing the vehicle

1. Park on a level surface, set the parking brake and activate the hazard flashers.
2. Place gearshift lever in P (Park) and turn engine off.

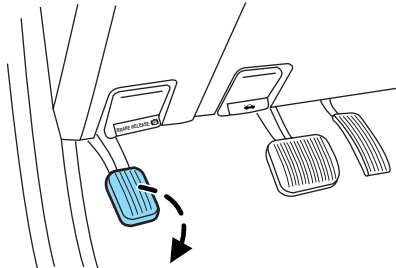

Removing the jack and tools

The jack and tools are located in the right rear of the cargo area behind an access panel.

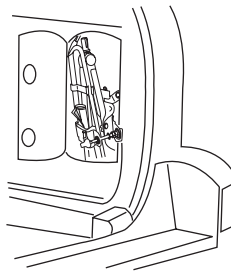

Roadside Emergencies

To remove jack from vehicle:

1. Release the thumbscrew on the bracket.
2. Release the retention clip on the upper part of the jack bracket.
3. Dislodge the jack from the bracket and carefully guide jack down and out through trim opening, upper end out first.

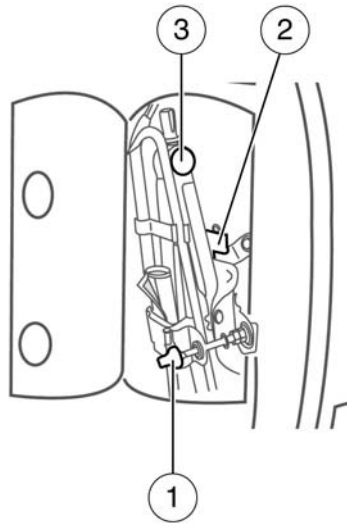

Remove the lug wrench from the jack in order to remove the spare tire from under the vehicle.

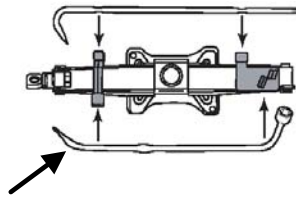

Removing the spare tire or spare tire and tether (if equipped)

1. Insert the lug wrench through the access hole in the rear bumper.
2. Turn the handle counterclockwise and lower the spare tire until it can be slid rearward and the cable is slack.
3. Slide the retainer through the center of the wheel.

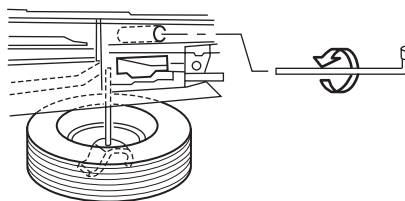

Roadside Emergencies

If equipped with a tether, perform the following additional steps:

4. Lift the spare tire on end to access tether attachment (1).

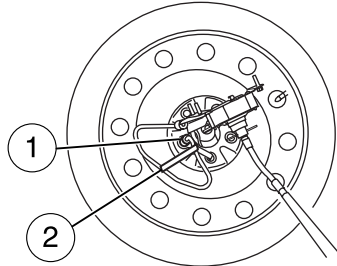

5. Use the lug wrench to remove the lug nut from the spare tire tether.

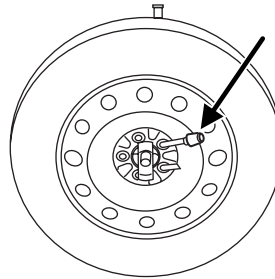

6. If not replacing the spare or flat tire to the underbody storage area, raise winch up into the installed position.

7. Use the attached fastener strap (2) to tie the tether end to the winch actuator shaft (if equipped).

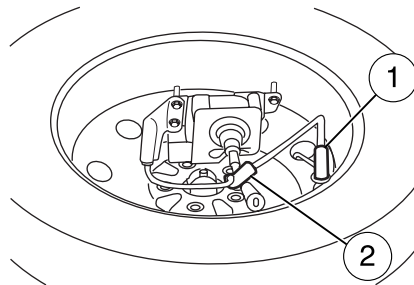



Roadside Emergencies

Tire change procedure

 **WARNING:** When one of the front wheels is off the ground, the transmission alone will not prevent the vehicle from moving or slipping off the jack, even if the vehicle is in P (Park).

 **WARNING:** To help prevent the vehicle from moving when you change a tire, be sure the parking brake is set, then block (in both directions) the wheel that is diagonally opposite (other side and end of the vehicle) to the tire being changed.

 **WARNING:** Changing a tire is dangerous if not done properly. If the vehicle slips off the jack, you or someone else could be seriously injured. Be sure to follow the directions for changing a tire, and never get under a vehicle that is supported only by a jack.

 **WARNING:** Do not attempt to change a tire on the side of the vehicle close to moving traffic. Pull far enough off the road to avoid the danger of being hit when operating the jack or changing the wheel.

1. Block the diagonally opposite wheel.

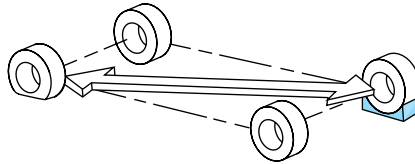

2. Loosen each wheel lug nut one-half turn counterclockwise but do not remove them until the wheel is raised off the ground.

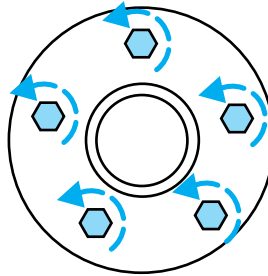

Roadside Emergencies

 Before placing the jack under the vehicle, NOTE the jack locations:

- **Front**

View shown from rear of front tire.
Position the jack directly below the protruding bolt.

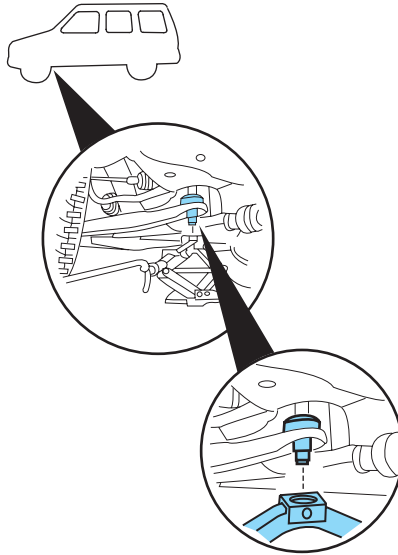

Roadside Emergencies

- **Rear**

View shown from forward of rear tire. Position jack directly below the stud on the rear trailing arm.

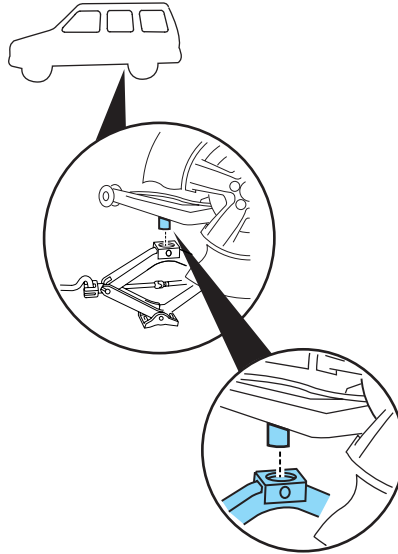

3. Position the jack according to the guides and turn the jack handle clockwise until the tire is a maximum of 1 inch (25 mm) off the ground.

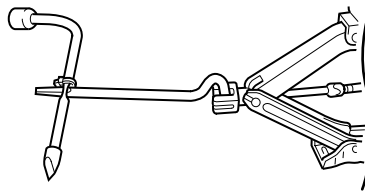

Be sure to place the jack away from the rear edge of the rocker to avoid damaging the rear tire spoiler (pictured).

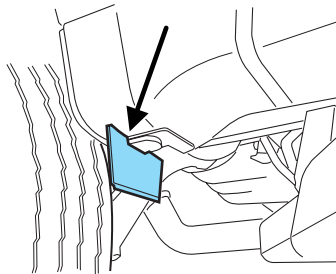

Roadside Emergencies

Never use the differentials as a jacking point.

 **WARNING:** To lessen the risk of personal injury, do not put any part of your body under the vehicle while changing a tire. Do not start the engine when your vehicle is on the jack. The jack is only meant for changing the tire. Be sure any occupants are out of the vehicle and in a safe place.

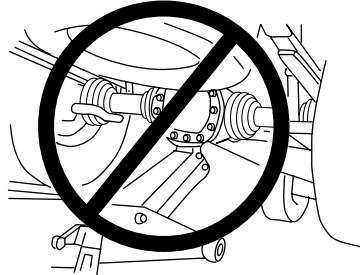

4. Remove the lug nuts with the lug nut wrench.
5. Replace the flat tire with the spare tire, making sure the valve stem is facing outward. Reinstall lug nuts until the wheel is snug against the hub. Do not fully tighten the lug nuts until the wheel has been lowered.
6. Lower the wheel by turning the jack handle counterclockwise.
7. Remove the jack and fully tighten the lug nuts in the order shown. Refer to *Wheel lug nut torque specifications* later in this chapter for the proper lug nut torque specification.

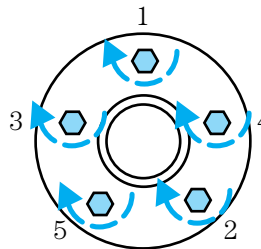

Roadside Emergencies

Stowing the jack and tools

Make sure the jack is fully lowered and reclip the tools onto the jack.

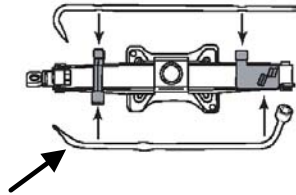

Reinstall the jack and tools in the cargo area. To replace the jack in the vehicle,

- guide the jack bottom first in the trim opening and position in the bracket (3),
- secure the retention clip on the upper part of the jack (2), and
- close the thumbscrew (1).

Make sure the jack is fastened so it does not rattle when you drive.

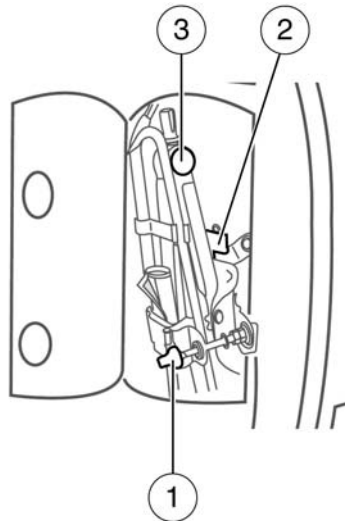

Stowing the flat/spare tire

Note: Failure to follow spare tire stowage instructions may result in failure of cable or loss of spare tire.

Roadside Emergencies

If you are stowing a tire that requires reattaching it to the vehicle with a tether, perform these steps first, then proceed with the steps following.

1. Place tire on end with valve stem facing rearward, away from vehicle.
2. Place tether into bolt holes in wheel and attach lug nut using lug wrench.

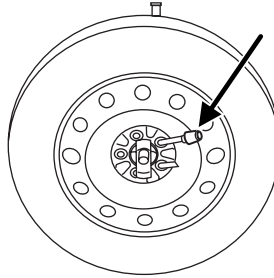

3. Lay the tire on the ground with the valve stem facing down. If your vehicle is equipped with aluminum wheels, remove the wheel ornament.
4. Slide the wheel partially under the vehicle and install the retainer through the center of the wheel.
5. Turn the jack handle clockwise until the tire is raised to its original position underneath the vehicle. The effort to turn the jack handle increases significantly as the tire contacts the frame. The spare tire carrier will ratchet when the tire is in the fully stowed position. The spare tire carrier has a built-in ratchet feature that will not allow you to overtighten. If the spare tire carrier ratchets with very little effort, take the vehicle to your authorized dealer for assistance at your earliest convenience. **If your vehicle is equipped with a trailer hitch, guide the tire with one hand; keep the rear of the tire tilted down until the tire clears the bumper.**
6. Check that the tire lies flat against the frame assembly. Push against the tire to make sure it is tightly seated under the vehicle. Loosen and retighten, if necessary. Failure to properly stow the spare tire may result in failure of the winch cable and loss of the spare tire. **(Make sure that the tire does not contact the bumper.)**
7. Repeat this tightness check procedure (every six months, per *scheduled maintenance information*), when servicing the spare tire pressure or at any time that the spare tire is disturbed through service of other components.

Roadside Emergencies

WHEEL LUG NUT TORQUE SPECIFICATIONS

Retighten the lug nuts to the specified torque at 500 miles (800 km) after any wheel disturbance (tire rotation, changing a flat tire, wheel removal, etc.).

Bolt size	Wheel lug nut torque*	
	lb.ft.	N•m
M12 x 1.5	100	135

* Torque specifications are for nut and bolt threads free of dirt and rust. Use only Mazda recommended replacement fasteners.

! WARNING: When a wheel is installed, always remove any corrosion, dirt or foreign materials present on the mounting surfaces of the wheel or the surface of the wheel hub, brake drum or brake disc that contacts the wheel. Ensure that any fasteners that attach the rotor to the hub are secured so they do not interfere with the mounting surfaces of the wheel. Installing wheels without correct metal-to-metal contact at the wheel mounting surfaces can cause the wheel nuts to loosen and the wheel to come off while the vehicle is in motion, resulting in loss of control.

Note: Inspect the wheel pilot hole prior to installation. If there is visible corrosion in wheel pilot hole, remove loose particles by wiping with clean rag and apply grease. Apply grease only to the wheel pilot hole surface by smearing a “dime” (1 square cm) sized glob of grease around the wheel pilot surface (1) with end of finger. **DO NOT** apply grease to lugnut/stud holes or wheel-to-brake surfaces.

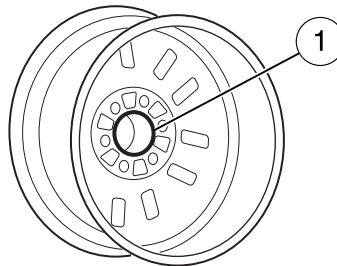

RUNNING OUT OF FUEL

If you have run out of fuel and need to refill the vehicle with a portable fuel container, see *Running out of fuel* in the *Maintenance and Specifications* chapter for proper fuel filling method using a portable fuel container and the included fuel filler funnel. **Do not** insert the nozzle of portable fuel containers or any type of aftermarket funnels into

240

2009 Tribute Hybrid (thv)
Owners Guide, 1st Printing
USA (fus)

Roadside Emergencies

the Easy Fuel™ "no cap" fuel system as it can be damaged. You must use the included funnel in such circumstances.



WARNING: Do not insert the nozzle of portable fuel containers or aftermarket funnels into the Easy Fuel™ system. This could damage the fuel system and its seal, and may cause fuel to run onto the ground instead of filling the tank, all of which could result in serious personal injury.

JUMP STARTING (LOW VOLTAGE [UNDERHOOD] BATTERY ONLY)



WARNING: The gases around the battery can explode if exposed to flames, sparks, or lit cigarettes. An explosion could result in injury or vehicle damage.



WARNING: Batteries contain sulfuric acid which can burn skin, eyes and clothing, if contacted.

Do not attempt to push-start your automatic transmission vehicle. Automatic transmissions do not have push-start capability. Attempting to push-start a vehicle with an automatic transmission may cause transmission damage.

Preparing your vehicle

If your low voltage (underhood) battery becomes disconnected or disabled for any reason, the vehicle controller must relearn the engine's operating characteristics in order to operate it at maximum efficiency. This relearning process occurs the first time the vehicle is driven after reconnecting the low voltage battery. If the learning procedure does not have time to complete during the drive, the engine will continue to operate for 3-5 seconds after you turn the ignition off to complete the relearning process. This is a normal condition and will not re-occur until the low voltage battery is disconnected again. The brake system must also be reset. Refer to *Low voltage (underhood) battery* in the *Maintenance and Specification* chapter for more information.

1. **Use only a 12-volt supply to start your vehicle.**
2. Do not disconnect the battery of the disabled vehicle as this could damage the vehicle's electrical system.

Roadside Emergencies

3. Park the booster vehicle close to the hood of the disabled vehicle making sure the two vehicles **do not** touch. Set the parking brake on both vehicles and stay clear of the engine cooling fan and other moving parts.
4. Check all battery terminals and remove any excessive corrosion before you attach the battery cables. Ensure that vent caps are tight and level.
5. Turn the heater fan on in both vehicles to protect from any electrical surges. Turn all other accessories off.

Connecting the jumper cables

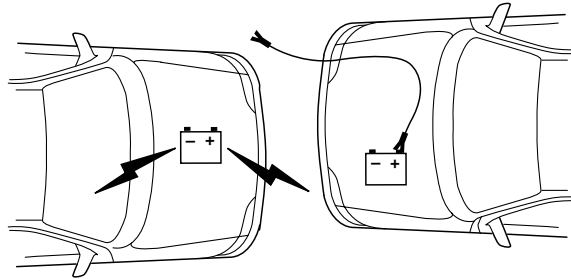

1. Connect the positive (+) jumper cable to the positive (+) terminal of the discharged battery.

Note: In the illustrations, *lightning bolts* are used to designate the assisting (boosting) battery.

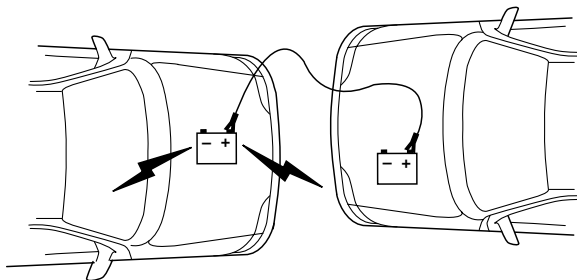

2. Connect the other end of the positive (+) cable to the positive (+) terminal of the assisting battery.

242

2009 Tribute Hybrid (thv)
Owners Guide, 1st Printing
USA (fus)

Roadside Emergencies

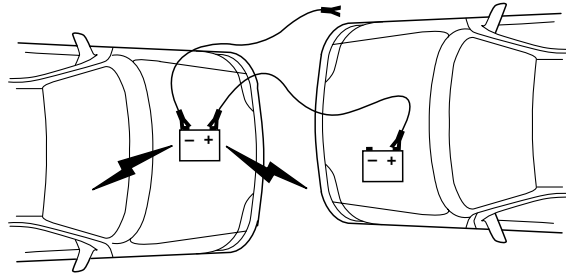

3. Connect the negative (-) cable to the negative (-) terminal of the assisting battery.

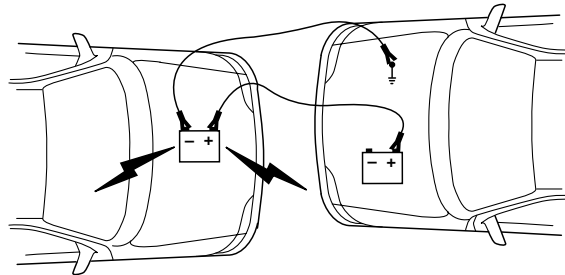

4. Make the final connection of the negative (-) cable to an exposed metal part of the stalled vehicle's engine, away from the battery and the carburetor/fuel injection system. **Do not** use fuel lines, engine rocker covers or the intake manifold as *grounding* points.

 **WARNING:** Do not connect the end of the second cable to the negative (-) terminal of the battery to be jumped. A spark may cause an explosion of the gases that surround the battery.

5. Ensure that the cables are clear of fan blades, belts, moving parts of both engines, or any fuel delivery system parts.

Roadside Emergencies

Jump starting

1. Start the engine of the booster vehicle and run the engine at moderately increased speed.
2. Start the engine of the disabled vehicle.
3. Once the disabled vehicle has been started, run both engines for an additional three minutes before disconnecting the jumper cables.

Removing the jumper cables

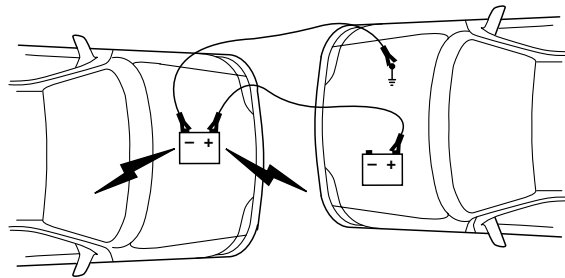

Remove the jumper cables in the reverse order that they were connected.

1. Remove the jumper cable from the *ground* metal surface.

Note: In the illustrations, *lightning bolts* are used to designate the assisting (boosting) battery.

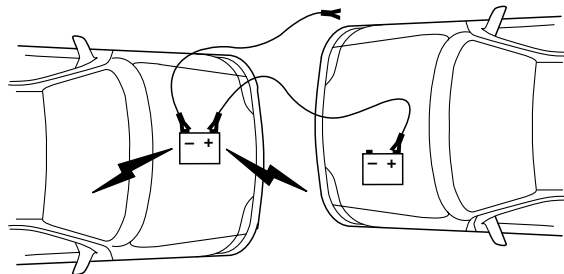

2. Remove the jumper cable on the negative (-) connection of the booster vehicle's battery.

Roadside Emergencies

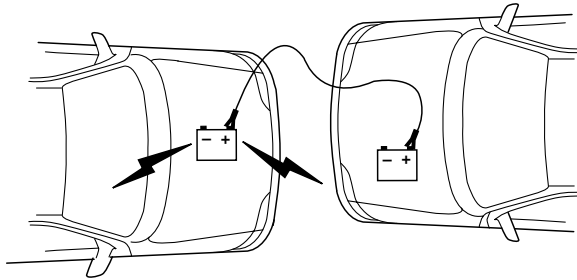

3. Remove the jumper cable from the positive (+) terminal of the booster vehicle's battery.

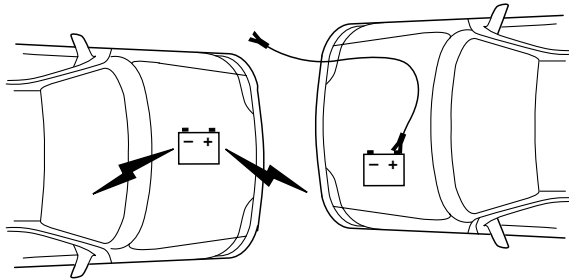

4. Remove the jumper cable from the positive (+) terminal of the disabled vehicle's battery.

After the disabled vehicle has been started and the jumper cables removed, allow it to idle for several minutes so the engine computer can *relearn* its idle conditions.

Roadside Emergencies

WRECKER TOWING

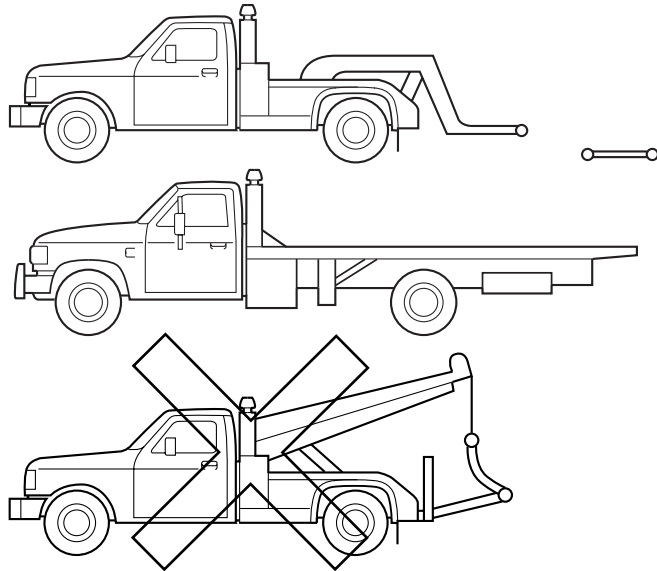

If you need to have your vehicle towed, contact a professional towing service or, if you are a member of a roadside assistance program, your roadside assistance service provider.

It is recommended that your vehicle be towed with a wheel lift and dollies or flatbed equipment. Do not tow with a slingbelt. Mazda has not approved a slingbelt towing procedure.

On FWD vehicles, if your vehicle is to be towed from the front, ensure proper wheel lift equipment is used to raise the front wheels off the ground. The rear wheels can be left on the ground when towed in this fashion.

If your vehicle is to be towed from the rear using wheel lift equipment, it is **required** that the front wheels (drive wheels) be placed on a dolly to prevent damage to the transmission.

On 4WD vehicles, it is **required** that your vehicle be towed with a wheel lift and dollies or flatbed equipment with all the wheels off the ground to prevent damage to the automatic transmission, 4WD system or vehicle.

Roadside Emergencies

If the vehicle is towed by other means or incorrectly, vehicle damage may occur.

Emergency towing

In case of a roadside emergency with a disabled vehicle (without access to wheel dollies, car hauling trailer, or flatbed transport vehicle) your vehicle (regardless of transmission powertrain configuration) can be flat towed (all wheels on the ground) under the following conditions:

- Vehicle is facing forward so that it is being towed in a forward direction.
- Place the transmission in N (Neutral). Refer to *Brake shift interlock* in the *Driving* chapter for specific instructions if you cannot move the gear shift lever into N (Neutral).
- Maximum speed is not to exceed 35 mph (56 km/h).
- Maximum distance is 50 miles (80 km).

Customer Assistance

CUSTOMER ASSISTANCE (U.S.A. MAINLAND AND HAWAII)

Your complete and permanent satisfaction is our business. We are here to serve you. All Authorized Mazda Dealers have the knowledge and the tools to keep your Mazda vehicle in top condition.

If you have any questions or recommendations for improvement regarding the service of your Mazda vehicle or servicing by Authorized Mazda Dealer personnel, we recommend that you take the following steps:

STEP 1: Contact Your Authorized Mazda Dealer

Discuss the matter with an Authorized Mazda Dealer. This is the quickest and best way to address the issue. If your concern has not been resolved by the CUSTOMER RELATIONS, SALES, SERVICE, or PARTS MANAGER, then please contact the GENERAL MANAGER of the authorized dealer or the OWNER.

STEP 2: Contact Mazda North American Operations

If for any reason you feel the need for further assistance after contacting your authorized dealer management, you can reach Mazda North American Operations by one of the following ways:

Log on at: www.mazdaUSA.com.

Answers to many questions, including how to locate or contact a local Authorized Mazda Dealership in the U.S., can be found here.

By email at: www.mazdaUSA.com (Click on CONTACT US at the bottom of the home page).

By phone at: 1 (800) 222-5500

By letter at:

Attn: Customer Assistance
Mazda North American Operations
7755 Irvine Center Drive
Irvine, CA 92618-2922
P.O. Box 19734
Irvine, CA 92623-9734

Whatever way you contact us, please help us to serve you more efficiently and effectively by providing the following information:

1. Your name, address, and telephone number
2. Year and model of vehicle
3. Vehicle Identification Number (17 digits, noted on your registration or title or located on the upper driver's side corner of the dash)

248

*2009 Tribute Hybrid (thv)
Owners Guide, 1st Printing
USA (fus)*

Customer Assistance

4. Purchase date and current mileage
5. Your authorized dealer's name and location
6. Your question(s)

If you live outside the U.S.A., please contact your nearest Mazda Distributor.

STEP 3: Contact Better Business Bureau (BBB)

Mazda North American Operations realizes that mutual agreement on some issues may not be possible. As a final step to ensure that your concerns are being fairly considered, Mazda North American Operations has agreed to participate in a dispute settlement program administered by the Better Business Bureau (BBB) system, at no cost to you the consumer.

BBB AUTO LINE works with consumers and the manufacturer in an attempt to reach a mutually acceptable resolution of any warranty related concerns. If the BBB is not able to facilitate a settlement they will provide an informal hearing before an arbitrator.

You are required to resort to BBB AUTO LINE before exercising rights or seeking remedies under the Federal Magnuson-Moss Warranty Act, 15 U.S.C. § 2301 et seq. To the extent permitted by the applicable state "Lemon Law", you are also required to resort to BBB AUTO LINE before exercising any rights or seeking remedies under the "Lemon Law." If you choose to seek remedies that are not created by the Magnuson-Moss Warranty Act or the applicable state "Lemon Law," you are not required to first use BBB AUTO LINE.

The whole process normally takes 40 days or less. The arbitration decision is not binding on you or Mazda else you accept the decision. For more information about BBB AUTO LINE, including current eligibility standards, please call 1-800-955-5100 or visit the BBB website at www.lemonlaw.bbb.org.

Being truly committed to customer satisfaction is more than a phrase with Mazda. We hope to satisfy every customer directly, but if there is ever a question about our decision, Mazda believes in providing a fast, fair and free method such as the BBB AUTO LINE to ensure Mazda delivers on our commitment to do the right thing for our customers!

CUSTOMER ASSISTANCE (CANADA)

Your complete and permanent satisfaction is our business. We are here to serve you. All Authorized Mazda Dealers have the knowledge and the tools to keep your Mazda vehicle in top condition.

Customer Assistance

In our experience, any questions, problems or complaints regarding the operation of your Mazda or any other general service transactions are most effectively resolved by your authorized dealer. If the cause of your dissatisfaction cannot adequately be addressed by normal authorized dealer procedures, we recommend that you take the following steps:

STEP 1: Contact Your Authorized Mazda Dealer

Discuss the matter with a member of authorized dealer management. If the Service Manager has already reviewed your concerns, contact the owner of the authorized dealer or its General Manager.

STEP 2: Call the Mazda Regional Office

If you feel that you still require assistance, ask the authorized dealer Service Manager to arrange for you to meet the local Mazda Service Representative. If more expedient, contact Mazda Canada Inc. Regional Office nearest you for such arrangements.

STEP 3: Contact the Mazda Customer Relations Department

If still not substantially satisfied, contact the Customer Relations Department, Mazda Canada Inc., 55 Vogell Road, Richmond Hill, Ontario L4B 3K5 Canada TEL: 1 (800) 263-4680.

Provide the Department with the following information:

1. Your name, address, and telephone number
2. Year and model of vehicle
3. Vehicle Identification Number (VIN). Refer to *Vehicle identification label* in the *Maintenance and Specifications* chapter of this manual for the location of the VIN.
4. Purchase date.
5. Present odometer reading.
6. Your authorized dealer's name and location
7. The nature of your problem and/or cause of dissatisfaction.

The Department, in cooperation with the local Mazda Service Representative, will review the case to determine if everything possible has been done to ensure your satisfaction.

Please recognize that the resolution of service problems in most cases requires the use of your authorized dealer's service facilities, personnel and equipment. We urge you to follow the above three steps in sequence therefore for most effective results.

250

2009 Tribute Hybrid (thv)
Owners Guide, 1st Printing
USA (fus)

Customer Assistance

Mediation/Arbitration Program

Occasionally a customer concern cannot be resolved through Mazda's Customer Satisfaction Program. If after exhausting procedures in this manual, your concern is still not resolved, you have another option.

Mazda Canada Inc. participates in an arbitration program administered by the Canadian Motor Vehicle Arbitration Plan (CAMVAP). CAMVAP will advise you about how your concern may be reviewed and resolved by an independent third party through binding arbitration.

Your complete satisfaction is the goal of Mazda Canada Inc. and our authorized dealers. Mazda's participation in CAMVAP makes a valuable contribution to our achieving that goal. There is no charge for using CAMVAP. CAMVAP results are fast, fair and final as the award is binding on both you and Mazda Canada Inc.

Canadian Motor Vehicle Arbitration Plan (CAMVAP)

For vehicles delivered to authorized Canadian dealerships. If a specific item of concern arises, where a solution cannot be reached between an owner, Mazda, and/or one of its authorized dealers (that all parties cannot agree upon), the owner may wish to use the services offered by the Canadian Motor Vehicle Arbitration Plan (CAMVAP).

CAMVAP uses the services of Provincial Administrators to assist consumers in scheduling and preparing for their arbitration hearings. However, before you can proceed with CAMVAP you must follow your Mazda dispute resolution process as outlined previously.

CAMVAP is fully implemented in all provinces and territories. Consumers wishing to obtain further information about the Program can obtain an information booklet from their authorized dealer, the Provincial Administrator at 1 (800) 207-0685, or by contacting the Canadian Motor Vehicle Arbitration Office At:
235 Yorkland Boulevard, Suite 407
North York, Ontario
M2J 4Y8
<http://camvap.ca>

Customer Assistance

Regional Offices

Regional Offices	Areas Covered
Mazda Canada Inc. Western Region 8171 Ackroyd Road Suite 2000 Richmond, B.C. V6X 3K1 (604) 303-5670	Alberta, British Columbia, Manitoba, Saskatchewan, Yukon
Mazda Canada Inc. Central Region 55 Vogell Road Richmond Hill, Ontario. L4B 3K5 1 (800) 263-4680	Ontario
Mazda Canada Inc. Quebec Region/Atlantic Region 6111 Route Trans Canadienne Pointe Claire, Quebec H9R 5A5 (514) 694-6390	Quebec, New Brunswick, Nova Scotia, Prince Edward Island, Newfoundland

CUSTOMER ASSISTANCE (PUERTO RICO & VIRGIN ISLANDS)

Your complete and permanent satisfaction is our business. That is why all Authorized Mazda Dealers have the knowledge and the tools to keep your Mazda vehicle in top condition.

If you have any questions or recommendations for improvement regarding the service of your Mazda vehicle or servicing by Authorized Mazda Dealer personnel, we recommend that you take the following steps:

STEP 1

Discuss the matter with an Authorized Mazda Dealer. This is the quickest and best way to address the issue. If your concern has not been resolved by the CUSTOMER RELATIONS, SALES, SERVICE, or PARTS MANAGER, then please contact the GENERAL MANAGER of the authorized dealer or the OWNER.

252

*2009 Tribute Hybrid (thv)
Owners Guide, 1st Printing
USA (fus)*

Customer Assistance

STEP 2

If, after following STEP 1, you feel the need for further assistance, please contact your area's Mazda representative (Indicated on the next page).

Please help us by providing the following information:

1. Your name, address, and telephone number
2. Year and model of vehicle
3. Vehicle Identification Number (17 digits, noted on your registration or title or located on the upper driver's side corner of the dash)
4. Purchase date and current mileage
5. Your authorized dealer's name and location
6. Your question(s)

If you would like to write a letter, please address it to the following,
Attn: Customer Assistance

Plaza Motors Corp.

Mazda de Puerto Rico
P.O. Box 362722
San Juan, Puerto Rico
00936-2722
Tel: (787) 788-9300

This way, we can be sure to respond to you as efficiently as possible.
That is our goal.

If you live outside the U.S.A., please contact your nearest Mazda Distributor.

IN CALIFORNIA (U.S. ONLY)

California Civil Code Section 1793.2(d) requires that, if a manufacturer or its representative is unable to repair a motor vehicle to conform to the vehicle's applicable express warranty after a reasonable number of attempts, the manufacturer shall be required to either replace the vehicle with one substantially identical or repurchase the vehicle and reimburse the buyer in an amount equal to the actual price paid or payable by the consumer (less a reasonable allowance for consumer use). The consumer has the right to choose whether to receive a refund or replacement vehicle.

Customer Assistance

California Civil Code Section 1793.22(b) presumes that the manufacturer has had a reasonable number of attempts to conform the vehicle to its applicable express warranties if, within the first 18 months of ownership of a new vehicle or the first 18,000 miles (29,000 km), whichever occurs first:

1. Two or more repair attempts are made on the same nonconformity likely to cause death or serious bodily injury OR
2. Four or more repair attempts are made on the same nonconformity (a defect or condition that substantially impairs the use, value or safety of the vehicle) OR
3. The vehicle is out of service for repair of nonconformities for a total of more than 30 calendar days (not necessarily all at one time).

In the case of 1 or 2 above, the consumer must also notify the manufacturer of the need for the repair of the nonconformity at the following address:

Mazda North American Operations
7755, Irvine Center Drive
Irvine, CA 92618-2922

MAZDA IMPORTERS/DISTRIBUTORS

U.S.A (Importer/Distributor)

Mazda North American Operations

7755 Irvine Center Drive
Irvine, CA 92618-2922
P.O. Box 19734
Irvine, CA 92623-9734
TEL: 1 (800) 222-5500 (in U.S.A.)
(949) 727-1990 (outside U.S.A.)

(Distributor in each area)

CANADA

Mazda Canada, Inc.

55 Vogell Road
Richmond Hill, Ontario L4B 3K5 Canada
TEL: 1 (800) 263-4680 (in Canada)
(416) 609-9909 (outside Canada)

PUERTO RICO & VIRGIN ISLANDS

Plaza Motors Corp. (Mazda de Puerto Rico)

P.O. Box 362722, San Juan, Puerto Rico 00936-2722
TEL: (787) 788-9300

254

2009 Tribute Hybrid (thv)
Owners Guide, 1st Printing
USA (fus)

Customer Assistance

GUAM

(d.b.a. Triple J. Enterprises, Inc.)

P.O. Box 6066 Tamuning, Guam
TEL: (671) 646-9216

SAIPAN

Pacific International Marianas, Inc.

(d.b.a. Midway Motors)

P.O. Box 887 Saipan, MP 96950
TEL: (670) 234-7524

Triple J Saipan, Inc.

(d.b.a. Triple J Motors)

Beach Road
Chalan LauLau
Saipan, MP 96950
TEL: (670) 235-4868

AMERICAN SAMOA

Polynesia Motors, Inc.

P.O. Box 1120, Pago Pago, American Samoa 96799
TEL: (684) 699-1854

WARRANTIES FOR YOUR MAZDA

- New Vehicle Limited Warranty
- Safety Restraint System Limited Warranty
- Anti-perforation Limited Warranty
- Federal Emission Control Warranty
 - Emission Defect Warranty
 - Emission Performance Warranty
- California Emission Control Warranty (if applicable)
- Replacement Parts and Accessories Limited Warranty
- Tire Warranty

NOTE: Detailed warranty information is provided with your Mazda portfolio.

Outside the United States

Government regulations in the United States require that automobiles meet specific emission regulations and safety standards. Therefore, vehicles built for use in the United States, may differ from those sold in other countries.

Customer Assistance

The differences may make it difficult or even impossible for your vehicle to receive satisfactory servicing in other countries. We strongly recommend that you NOT take your Mazda outside the United States. However, in the event that you are moving to Canada permanently, Mazda vehicles built for use in the United States could be eligible for exportation to Canada with specific vehicle modifications to comply with the Canadian Motor Vehicle Safety requirements.

Special Note: The above is applicable for permanent import/export situations and not related to travelers on vacation.

You may have the following problems if you do take your vehicle outside of the United States:

- Recommended fuel may be unavailable. Any kind of leaded fuel or low-octane fuel will affect vehicle performance and damage the emission controls and engine.
- Proper repair facilities, tools, testing equipment, and replacement parts may not be available.

Please refer to your manufacturers warranty booklet for more information.

Outside Canada

Government regulations in Canada require that automobiles meet specific emission regulations and safety standards. Therefore, vehicles built for use in Canada, may differ from those sold in other countries.

The differences may make it difficult or even impossible for your vehicle to receive satisfactory servicing in other countries. We strongly recommend that you NOT take your Mazda outside Canada. However, in the event that you are moving to the United States permanently, Mazda vehicles built for use in Canada could be eligible for exportation to the United States with specific vehicle modifications to comply with the United States Federal Motor Vehicle Safety requirements.

Special Note: The above is applicable for permanent import/export situations and not related to travelers on vacation.

You may have the following problems if you do take your vehicle outside of Canada:

- Recommended fuel may be unavailable. Any kind of leaded fuel or low-octane fuel will affect vehicle performance and damage the emission controls and engine.
- Proper repair facilities, tools, testing equipment, and replacement parts may not be available.

Please refer to your manufacturers warranty booklet for more information.

256

2009 Tribute Hybrid (thv)
Owners Guide, 1st Printing
USA (fus)

Customer Assistance

ADD-ON NON-GENUINE PARTS AND ACCESSORIES

Non-genuine parts and accessories for Mazda vehicles can be found in stores. These may fit your vehicle, but they are not approved by the manufacturer for use with Mazda vehicles. When you install non-genuine parts or accessories, they could affect your vehicle's performance or safety system; the manufacturer's warranty doesn't cover this. Before you install any non-genuine parts or accessories, consult an Authorized Mazda Dealer.



WARNING: Installation of Non-Genuine Parts or Accessories:

Installation of non-genuine parts or accessories could be dangerous. Improperly designed parts or accessories could seriously affect your vehicle's performance or safety system. This could cause you to have an accident or increase your chances of injuries in an accident. Always consult an Authorized Mazda Dealer before you install non-genuine parts or accessories.



WARNING: Add-On Electrical and Electronic Equipment:

Incorrectly choosing or installing improper add-on equipment or choosing an improper installer could be dangerous. Essential systems could be damaged, causing engine stalling, air-bag (SRS) activation, ABS inactivation, or a fire in the vehicle. Be very careful in choosing and installing add-on electrical equipment, such as mobile telephones, two-way radios, stereo systems, and car alarm systems.

Mazda assumes no responsibility for death, injury, or expenses that may result from the installation of add-on non-genuine parts or accessories.

SERVICE PUBLICATIONS

Factory-authorized Mazda service publications are available for owners who wish to do some of their own maintenance and repair.

When requesting any of our publications through an Authorized Mazda Dealer, refer to the chart below.

If they don't have what you need in stock, they can order it for you.

PUBLICATION ORDER NUMBER	PUBLICATION DESCRIPTION
9999 95 062B 09	WORKSHOP MANUAL
9999 95 038G 09	WIRING DIAGRAM
9999 95 014C 09	OWNER'S MANUAL

Customer Assistance

WORKSHOP MANUAL:

Covers recommended maintenance and repair procedures of the drive train, body and chassis.

WIRING DIAGRAM:

Provides electrical schematics as well as component location for the entire electrical system.

OWNER'S MANUAL:

This booklet contains information regarding the proper care and operation of your vehicle. This is not a technician's manual.

Please note that your Authorized Mazda Dealership has trained personnel and special service tools to correctly and safely maintain Mazda vehicles.

REPORTING SAFETY DEFECTS (U.S. ONLY)

If you believe that your vehicle has a defect that could cause a crash, or could cause injury or death, you should immediately inform the National Highway Traffic Safety Administration (NHTSA) in addition to notifying Mazda Corporation.

If NHTSA receives similar complaints, it may open an investigation, and if it finds that a safety defect exists in a group of vehicles, it may order a recall and remedy campaign. However, NHTSA cannot become involved in individual problems between you, your dealer or Mazda Corporation.

To contact NHTSA, you may call the Vehicle Safety Hotline toll-free at 1-888-327-4236 (TTY: 1-800-424-9153); go to <http://www.safercar.gov>; or write to:

Administrator
1200 New Jersey Avenue, Southeast
Washington, D.C. 20590

You can also obtain other information about motor vehicle safety from <http://www.safercar.gov>.

REPORTING SAFETY DEFECTS (CANADA ONLY)

If you believe that your vehicle has a defect which could cause a crash or could cause injury or death, you should immediately inform Transport Canada, using their toll-free number: 1-800-333-0510.

WASHING THE EXTERIOR

Wash your vehicle regularly with cool or lukewarm water and a neutral pH shampoo.

- Never use strong household detergents or soap, such as dish washing or laundry liquid. These products can discolor and spot painted surfaces.
- Never wash a vehicle that is “hot to the touch” or during exposure to strong, direct sunlight.
- Always use a clean sponge or car wash mitt with plenty of water for best results.
- Dry the vehicle with a chamois or soft terry cloth towel in order to eliminate water spotting.
- It is especially important to wash the vehicle regularly during the winter months, as dirt and road salt are difficult to remove and cause damage to the vehicle.
- Immediately remove items such as gasoline, diesel fuel, bird droppings and insect deposits because they can cause damage to the vehicle’s paintwork and trim over time.
- Remove any exterior accessories, such as antennas, before entering a car wash.
- **Suntan lotions and insect repellents can damage any painted surface; if these substances come in contact with your vehicle, wash off as soon as possible.**
- **Use care when washing the vehicle to ensure water and soap are not directed into the high voltage battery vent, located near the driver side rear window.**

WAXING

Applying a premium paint sealant to your vehicle every six months will assist in reducing minor scratches and paint damage.

- Wash the vehicle first. Refer to *Washing the exterior* for more detailed information.
- Do not use waxes that contain abrasives; use a premium liquid wax.
- Do not allow paint sealant to come in contact with any non-body (low-gloss black) colored trim, such as grained door handles, roof racks, bumpers, side moldings, mirror housings or the windshield cowl area. The paint sealant will “gray” or stain the parts over time.

Cleaning

PAINT CHIPS

Your dealer has touch-up paint to match your vehicle's color. Touch-up paint can be used to repair minor scratches to painted surfaces.

- Remove particles such as bird droppings, tree sap, insect deposits, tar spots, road salt and industrial fallout before repairing paint chips.
- Always read the instructions before using the products.

ALUMINUM WHEELS AND COVERS

Aluminum wheel rims or covers are coated with a clearcoat paint finish. In order to maintain their shine:

- Clean with cool or lukewarm water and a neutral pH shampoo.
- Never apply any cleaning chemical to hot or warm wheel rims or covers.
- Some automatic car washes may cause damage to the finish on your wheel rims or covers. Chemical-strength cleaners, or cleaning chemicals, in combination with brush agitation to remove brake dust and dirt, could wear away the clearcoat finish over time.
- Do not use hydrofluoric acid-based or high caustic-based wheel cleaners, steel wool, fuels or strong household detergent.
- To remove tar and grease, use Extra Strength Tar and Road Oil Remover (0000-77-410E-01), available from your authorized Mazda dealer.

ENGINE

Engines are more efficient when they are clean because grease and dirt buildup keep the engine warmer than normal. When washing:

- Take care when using a power washer to clean the engine. The high-pressure fluid could penetrate the sealed parts and cause damage.
- Never spray the engine or other engine components with water. Water will damage the engine or other engine components.
- Spray Engine Shampoo and Degreaser (0000-77-410E-09), available at your authorized Mazda dealer, on all parts that require cleaning and pressure rinse clean.

260

*2009 Tribute Hybrid (thv)
Owners Guide, 1st Printing
USA (fus)*

Cleaning

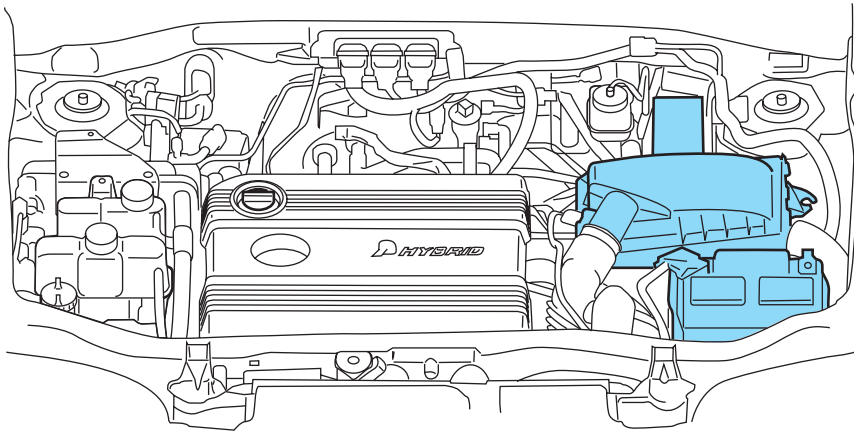

- Cover the highlighted areas to prevent water damage when cleaning the engine. **Note:** As with all transmissions, be especially careful as water entry into the vents can damage internal parts.
- Never wash or rinse the engine while it is running; water in the running engine may cause internal damage.

PLASTIC (NON-PAINTED) EXTERIOR PARTS

Use only approved products to clean plastic parts. These products are available from your dealer.

- For routine cleaning, use cool or lukewarm water with a neutral pH shampoo.
- If tar or grease spots are present, use Extra Strength Tar and Road Oil Remover (0000-77-410E-01), available at your authorized Mazda dealer.

Cleaning

WINDOWS AND WIPER BLADES

The windshield, rear and side windows and the wiper blades should be cleaned regularly. If the wipers do not wipe properly, substances on the vehicle's glass or the wiper blades may be the cause. These may include hot wax treatments used by commercial car washes, water repellent coatings, tree sap, or other organic contamination; these contaminants may cause squeaking or chatter noise from the blades, and streaking and smearing of the windshield. To clean these items, follow these tips:

- The windshield, rear windows and side windows may be cleaned with a non-abrasive cleaner such as Ultra-Clear Spray Glass Cleaner (0000-77-400E-01 and 0000-77-400E-02), available from your authorized Mazda dealer.
- The wiper blades can be cleaned with isopropyl (rubbing) alcohol or a windshield washer concentrate. This washer fluid concentrate contains a special solution in addition to alcohol which helps to remove the hot wax deposited on the wiper blade and windshield from automated car wash facilities. Be sure to replace wiper blades when they appear worn or do not function properly.
- Do not use abrasives, as they may cause scratches.
- Do not use fuel, kerosene, or paint thinner to clean any parts.

INSTRUMENT PANEL / INTERIOR TRIM AND CLUSTER LENS

Clean the interior trim areas and instrument panel with a damp cloth, then with a clean, dry cloth, or use Mazda Deluxe Leather and Vinyl Cleaner (0000-77-430E-15).

- Avoid cleaners or polish that increase the gloss of the upper portion of the instrument panel. The dull finish in this area helps protect the driver from undesirable windshield reflection.
- Do not use household or glass cleaners, as these may damage the finish.



WARNING: Do not use chemical solvents or strong detergents when cleaning the steering wheel, instrument panel or interior trim areas to avoid contamination of the airbag systems.

- Be certain to wash or wipe your hands clean if you have been in contact with certain products such as insect repellent and suntan lotion in order to avoid possible damage to the interior painted surfaces.

Cleaning

INTERIOR

For fabric, carpets, cloth seats, seat belts and seats equipped with side air bags (if equipped):

- Remove dust and loose dirt with a vacuum cleaner.
- Remove light stains and soil with Upholstery Cleaner and Spot Remover (0000-77-430E-01), available at your authorized Mazda dealer.
- If grease or tar is present on the material, spot-clean the area first with Spot and Stain Remover (0000-77-410E-01), available at your authorized Mazda dealer.
- If a solvent ring forms on the fabric after spot cleaning, clean the entire area immediately (but do not oversaturate) or the ring will set.
- Do not use household cleaning products or glass cleaners, which can stain and discolor the fabric and affect the flame retardant abilities of the seat materials.



WARNING: Do not use chemical solvents or strong detergents when cleaning the seat where the side air bag (if equipped) is mounted. Such products may contaminate the side air bag system and affect performance of the air bag in a collision. The air bag may not function correctly and not provide any injury reduction benefits.

LEATHER SEATS (IF EQUIPPED)

Your leather seating surfaces have a clear, protective coating over the leather.

- To clean, use a soft cloth with Deluxe Leather and Vinyl Cleaner (0000-77-430E-15), available at your authorized Mazda dealer. Dry the area with a soft cloth.
- To help maintain its resiliency and color, use the Deluxe Leather Care Kit (0000-77-609E-03), available at your authorized Mazda dealer.
- Do not use household cleaning products, alcohol solutions, solvents or cleaners intended for rubber, vinyl and plastics, or oil/petroleum-based leather conditioners. These products may cause premature wearing of the clear, protective coating.

Cleaning

UNDERBODY

Flush the complete underside of your vehicle frequently. Keep body and door drain holes free from packed dirt.

MAZDA CAR CARE PRODUCTS

Your Mazda dealer has many quality products available to clean your vehicle and protect its finishes. These quality products have been specifically engineered to fulfill your automotive needs; they are custom designed to complement the style and appearance of your vehicle. Each product is made from high quality materials that meet or exceed rigid specifications. For best results, use these products or products of equivalent quality. These products are available at your authorized Mazda dealer.

Maintenance and Specifications

SERVICE RECOMMENDATIONS

To help you service your vehicle, we provide *scheduled maintenance information* which makes tracking routine service easy.

If your vehicle requires professional service, your authorized dealer can provide the necessary parts and service. Check your *Warranty Guide/Customer Information Guide* to find out which parts and services are covered.

Use only recommended fuels, lubricants, fluids and service parts conforming to specifications. Mazda parts are designed and built to provide the best performance in your vehicle.

PRECAUTIONS WHEN SERVICING YOUR VEHICLE

- Do not work on a hot engine.
- Make sure that nothing gets caught in moving parts.
- Do not work on a vehicle with the engine running in an enclosed space, unless you are sure you have enough ventilation.
- Keep all open flames and other burning (cigarettes) material away from the battery and all fuel related parts.

High Voltage Information



WARNING: Exposure to high voltage may result in severe personal injury or death. High voltage components must be serviced by a trained service technician.

Your vehicle consists of various high voltage components and wiring. All of the high voltage power flows through specific wiring assemblies which are labeled as such and/or are covered with a solid orange convolute or orange stripe tape. Do not come in contact with these components.

The following are specific locations in the rear cargo area that consist of high voltage components and/or wiring.

Maintenance and Specifications

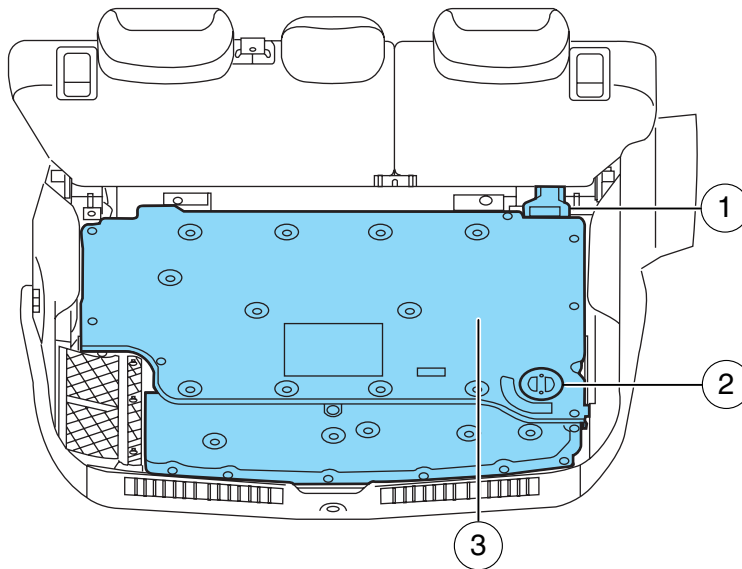

1. High voltage connector shield
2. Service Disconnect
3. High voltage battery case

Working with the engine off

1. Set the parking brake and ensure the gearshift is securely latched in P (Park).
2. Turn off the engine and remove the key.
3. Block the wheels to prevent the vehicle from moving unexpectedly.

Maintenance and Specifications

Working with the engine on

1. Set the parking brake and shift to P (Park).
2. Block the wheels.

 **WARNING:** To reduce the risk of vehicle damage and/or personal burn injuries, do not start your engine with the air cleaner removed and do not remove it while the engine is running.

OPENING THE HOOD

1. Inside the vehicle, pull the hood release handle located under the bottom of the instrument panel.
2. At the front of the vehicle, lift up on the auxiliary latch handle located in the center between the hood and the grille.
3. Lift the hood open and secure it with the prop rod.

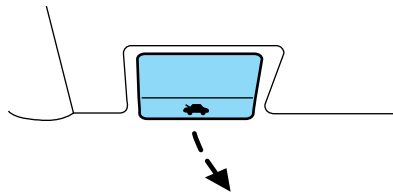

Maintenance and Specifications

IDENTIFYING COMPONENTS IN THE ENGINE COMPARTMENT

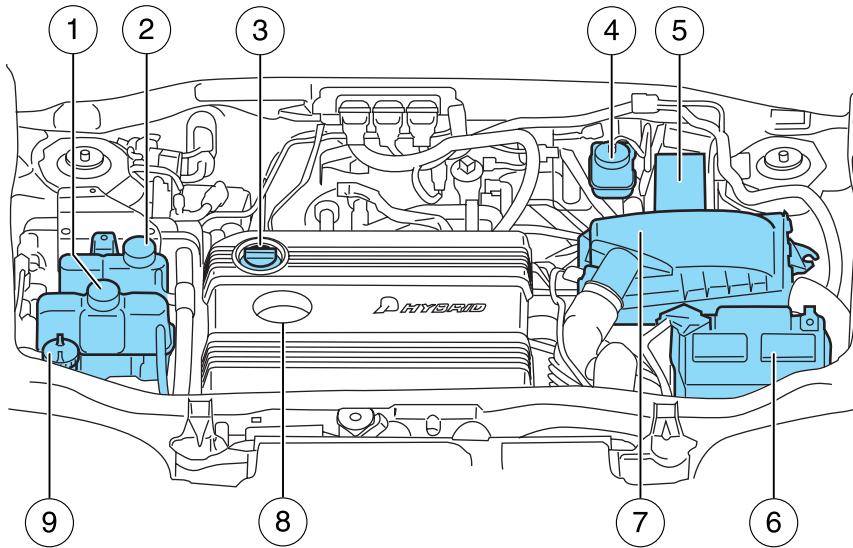

1. Engine coolant reservoir
2. Motor/Electronics (M/E) coolant reservoir
3. Engine oil filler cap
4. Brake fluid reservoir
5. Power distribution box
6. Low voltage (underhood) battery
7. Engine air filter assembly
8. Engine oil dipstick
9. Windshield washer fluid reservoir

Maintenance and Specifications

WINDSHIELD WASHER FLUID

Add fluid to fill the reservoir if the level is low. In very cold weather, do not fill the reservoir completely.

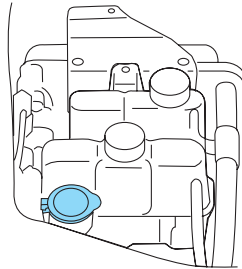

Only use a washer fluid that meets Mazda specifications. Do not use any special washer fluid such as windshield water repellent type fluid or bug wash. They may cause squeaking, chatter noise, streaking and smearing. Refer to the *Maintenance product specifications and capacities* section in this chapter.

State or local regulations on volatile organic compounds may restrict the use of methanol, a common windshield washer antifreeze additive. Washer fluids containing non-methanol antifreeze agents should be used only if they provide cold weather protection without damaging the vehicle's paint finish, wiper blades or washer system.



WARNING: If you operate your vehicle in temperatures below 40°F (5°C), use washer fluid with antifreeze protection. Failure to use washer fluid with antifreeze protection in cold weather could result in impaired windshield vision and increase the risk of injury or accident.

Note: Do not put washer fluid in the engine coolant reservoir. Washer fluid placed in the cooling system may harm engine and cooling system components.

Checking and adding washer fluid for the liftgate

Washer fluid for the liftgate is supplied by the same reservoir as the windshield.

Maintenance and Specifications

CHANGING THE WIPER BLADES

1. Pull the wiper blade and arm away from the glass. Turn the blade at a right angle to the arm.
2. Squeeze the locking tabs to release the blade from the arm and pull the blade away from the arm to remove it.

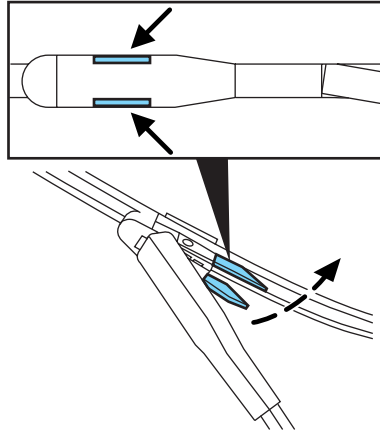

3. Attach the new blade to the arm and snap it into place.

Replace wiper blades at least once per year for optimum performance.

Poor wiper quality can be improved by cleaning the wiper blades and the windshield, refer to *Windows and wiper blades* in the *Cleaning* chapter.

To prolong the life of the wiper blades, it is highly recommended to scrape off the ice on the windshield before turning on the wipers. The layer of ice has many sharp edges and can damage the micro edge of the wiper rubber element.

Maintenance and Specifications

Changing rear window wiper blade

The rear wiper arm is designed without a service position. This reduces the risk of damage to the blade in an automatic car wash.

To replace the wiper blade:

1. Grab the wiper arm with one hand close to the arm/blade joint and pull it as far away from the glass as possible. Do not use excessive force because it can break the wiper arm at the heel. Hold it there until the next step.
2. Grab the primary structure of the blade with the other hand close to the arm/blade joint.
3. Grip tightly and push on the arm/blade joint from beneath and separate the blade from the arm.
4. Attach the new wiper to the wiper arm and press it into place until a click is heard.

If you find this procedure too difficult, please see your dealer.

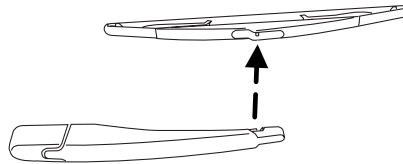
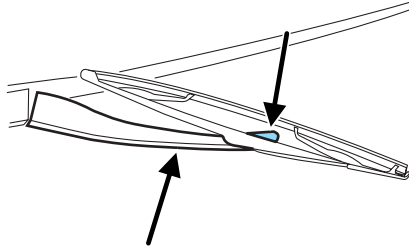

ENGINE OIL

Checking the engine oil

Refer to the *scheduled maintenance information* for the appropriate intervals for checking the engine oil.

1. Make sure the vehicle is on level ground.
2. Turn the engine off and wait 15 minutes for the oil to drain into the oil pan.
3. Set the parking brake and ensure the gearshift is securely latched in P (Park).
4. Open the hood. Protect yourself from engine heat.

Maintenance and Specifications

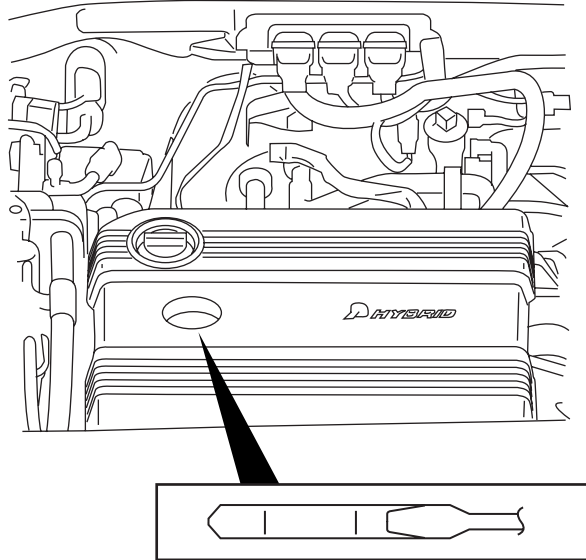

5. Locate and carefully remove the engine oil level dipstick.
6. Wipe the dipstick clean. Insert the dipstick fully, then remove it again.
- If the oil level is within the lower and upper holes/lines, the oil level is acceptable. **DO NOT ADD OIL.**
- If the oil level is below the lower hole/line, engine **oil must be added** to raise the level within the normal operating range.
- If required, add engine oil to the engine. Refer to *Adding engine oil* in this chapter.
- **Do not overfill the engine with oil. Oil levels above the upper hole/line may cause engine damage.** If the engine is overfilled, some oil must be removed from the engine by an authorized dealer.
7. Put the dipstick back in and ensure it is fully seated.

Adding engine oil

1. Check the engine oil. For instructions, refer to *Checking the engine oil* in this chapter.

272

2009 Tribute Hybrid (thv)
Owners Guide, 1st Printing
USA (fus)

Maintenance and Specifications

2. If the engine oil level is not within the normal range, add only certified engine oil of the recommended viscosity. Remove the engine oil filler cap and use a funnel to pour the engine oil into the opening.
3. Recheck the engine oil level. Make sure the oil level is not above the full mark on the engine oil level dipstick.
4. Install the dipstick and ensure it is fully seated.
5. Fully install the engine oil filler cap by turning the filler cap clockwise 1/4 of a turn until it is seated.

To avoid possible oil loss, DO NOT operate the vehicle with the engine oil level dipstick and/or the engine oil filler cap removed.

Engine oil and filter recommendations

Look for this certification trademark.



Use SAE 5W-20 engine oil

Only use oils "Certified For Gasoline Engines" by the American Petroleum Institute (API). An oil with this trademark symbol conforms to the current engine and emission system protection standards and fuel economy requirements of the International Lubricant Standardization and Approval Committee (ILSAC), comprised of U.S. and Japanese automobile manufacturers.

To protect your engine and engine's warranty, use Mazda SAE 5W-20 or an equivalent SAE 5W-20 oil meeting Mazda specification WSS-M2C930-A. **SAE 5W-20 oil provides optimum fuel economy and durability performance meeting all requirements for your vehicle's engine.**

273

**2009 Tribute Hybrid (thv)
Owners Guide, 1st Printing
USA (fus)**

Maintenance and Specifications

Do not use supplemental engine oil additives, cleaners or other engine treatments. They are unnecessary and could lead to engine damage that is not covered by Mazda warranty.

Change your engine oil and filter according to the appropriate schedule listed in *scheduled maintenance information*.

When changing the oil filter on the 2.3L engine, you must also replace the filter cap O-ring. The oil filter drain plug O-ring must also be replaced whenever the oil filter drain plug is removed. Reuse of the O-rings may cause engine oil leakage and may result in severe engine damage. The customer warranty may be void for any damage to the engine if the O-rings are not replaced.

Mazda production and Mazda replacement oil filters are designed for added engine protection and long life. If a replacement oil filter is used that does not meet Mazda material and design specifications, start-up engine noises or knock may be experienced.

It is recommended you use the appropriate Mazda oil filter or another with equivalent performance for your engine application.

LOW VOLTAGE (UNDERHOOD) BATTERY

Your vehicle is equipped with a Mazda maintenance-free battery which normally does not require additional water during its life of service.

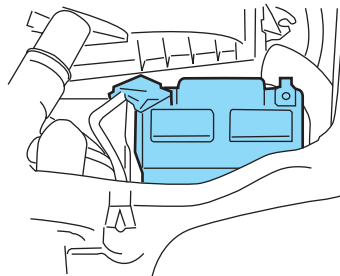

If your battery has a cover/shield, make sure it is reinstalled after the battery has been cleaned or replaced.

For longer, trouble-free operation, keep the top of the battery clean and dry. Also, make certain the battery cables are always tightly fastened to the battery terminals.

If you see any corrosion on the battery or terminals, remove the cables from the terminals and clean with a wire brush. You can neutralize the acid with a solution of baking soda and water.

274

*2009 Tribute Hybrid (thv)
Owners Guide, 1st Printing
USA (fus)*

Maintenance and Specifications

Note: Electrical or electronic accessories or components added to the vehicle by the dealer or the owner (e.g. spot lights, electric winch, etc.) may adversely affect vehicle performance and durability.



WARNING: Batteries normally produce explosive gases which can cause personal injury. Therefore, do not allow flames, sparks or lighted substances to come near the battery. When working near the battery, always shield your face and protect your eyes. Always provide proper ventilation.



WARNING: When lifting a plastic-cased battery, excessive pressure on the end walls could cause acid to flow through the vent caps, resulting in personal injury and/or damage to the vehicle or battery. Lift the battery with a battery carrier or with your hands on opposite corners.



WARNING: Keep batteries out of reach of children. Batteries contain sulfuric acid. Avoid contact with skin, eyes or clothing. Shield your eyes when working near the battery to protect against possible splashing of acid solution. In case of acid contact with skin or eyes, flush immediately with water for a minimum of 15 minutes and get prompt medical attention. If acid is swallowed, call a physician immediately.



WARNING: Battery posts, terminals and related accessories contain lead and lead compounds. Wash hands after handling.

If the battery is disconnected, the Regenerative Braking System will need to relearn the initial brake pedal position. After reconnecting the battery, slowly depress and release the brake pedal one time.

Because your vehicle's engine is electronically controlled by a computer, some control conditions are maintained by power from the battery. When the battery is disconnected or a new battery is installed, the engine must relearn its idle and fuel trim strategy for optimum driveability and performance. To begin this process:

1. With the vehicle at a complete stop, set the parking brake.
2. Put the gearshift in P (Park), turn off all accessories and start the engine.

Maintenance and Specifications

3. Run the engine until it reaches normal operating temperature.
 4. Allow the engine to idle for at least one minute.
 5. Turn the A/C on and allow the engine to idle for at least one minute.
 6. Drive the vehicle to complete the relearning process.
- The vehicle may need to be driven 10 miles (16 km) or more to relearn the idle and fuel trim strategy.
 - **If you do not allow the engine to relearn its idle trim, the idle quality of your vehicle may be adversely affected until the idle trim is eventually relearned.**

If the battery has been disconnected or a new battery has been installed, the clock and the preset radio stations must be reset once the battery is reconnected.

- Always dispose of automotive batteries in a responsible manner. Follow your local authorized standards for disposal. Call your local authorized recycling center to find out more about recycling automotive batteries.

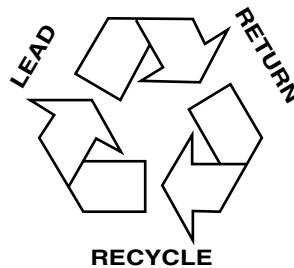

Low and high voltage battery – storage

Your vehicle must be started and run for a minimum of 10 minutes once a month in order to maintain the high voltage battery charge. This will maintain the high voltage battery but it is not enough to maintain the low voltage (underhood) battery and additional low voltage (underhood) battery charging may be required after 60 days.

If your vehicle is to be stored for 30 days or longer, the low voltage (underhood) battery negative terminal must be disconnected. Failure to do this could damage your vehicle's batteries.

Maintenance and Specifications

ENGINE COOLANT AND MOTOR/ELECTRONICS COOLANT

Your vehicle is equipped with two separate coolant systems. One is for engine cooling and the other is for various electric motors and other components that are specific to the hybrid operating systems.

Checking engine coolant

The concentration and level of engine coolant should be checked at the intervals listed in *scheduled maintenance information*. The coolant concentration should be maintained at 50/50 coolant and distilled water, which equates to a freeze point of -34°F (-36°C). Coolant concentration testing is possible with a hydrometer or antifreeze tester (such as the Rotunda Battery and Antifreeze Tester, 014-R1060). The level of coolant should be maintained at the "FULL COLD" level or within the "COLD FILL RANGE" in the coolant reservoir. If the level falls below, add coolant per the instructions in the *Adding engine coolant* section. When the engine is cold, check the level of engine coolant in the reservoir.

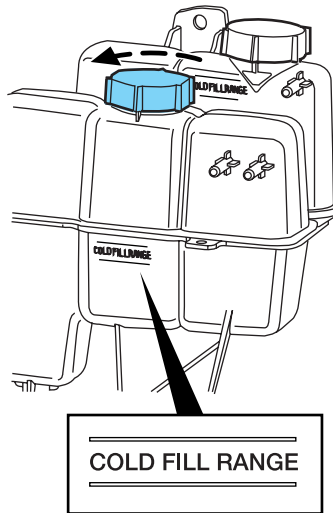

Maintenance and Specifications

Checking motor/electronics (M/E) coolant

The M/E coolant reservoir is located behind the engine coolant reservoir. Refer to the following engine coolant sections for all information, instructions and warnings related to cooling systems. The two systems use the same coolant and operate similarly, with the Motor and Electronics system generally operating at a lower temperature and pressure. The fluid levels in both reservoirs need to be maintained. When the engine is cold, check the level of M/E coolant in the reservoir.

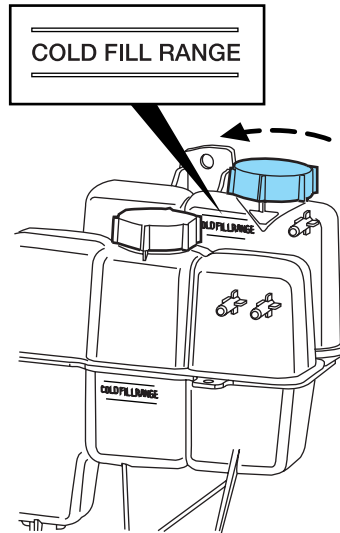

Factory fill and coolant specifications

Your vehicle was factory-filled with a 50/50 engine coolant and water concentration. If the concentration of coolant falls below 40% or above 60%, the engine parts could become damaged or not work properly. **A 50–50 mixture of coolant and water provides the following:**

- **Freeze protection down to -34°F (-36°C).**
- **Boiling protection up to 265°F (129°C).**
- **Protection against rust and other forms of corrosion.**
- **Enables calibrated gauges to work properly.**

Common instructions for cooling systems

- The engine coolant should be at the “FULL COLD” level or within the “COLD FILL RANGE” as listed on the engine coolant reservoir (depending upon application).
- Refer to the *scheduled maintenance information* for service interval schedules.
- Be sure to read and understand *Precautions when servicing your vehicle* in this chapter.

278

2009 Tribute Hybrid (thv)
Owners Guide, 1st Printing
USA (fus)

Maintenance and Specifications

If the engine coolant has not been checked at the recommended interval, the engine coolant reservoir may become low or empty. If the reservoir is low or empty, add engine coolant to the reservoir. Refer to *Adding engine coolant* in this chapter.

Note: Automotive fluids are not interchangeable; do not use engine coolant, antifreeze or windshield washer fluid outside of its specified function and vehicle location.

Adding engine coolant

Use only Mazda Genuine Engine Coolant or a premium engine coolant that meets a Mazda specification.

- **DO NOT USE Extended Life Engine Coolant (orange in color).**
- **DO NOT USE a DEX-COOL® engine coolant or an equivalent engine coolant.**
- **DO NOT USE alcohol or methanol antifreeze or any engine coolants mixed with alcohol or methanol antifreeze.**
- **DO NOT USE supplemental coolant additives in your vehicle. These additives may harm your engine's cooling system.**
- **DO NOT MIX different colors or types of coolant in your vehicle. Make sure the correct coolant is used.**
- **DO NOT MIX recycled coolant and conventional coolant together in your vehicle. Mixing of engine coolants may harm your engine's cooling system.**
- **The use of an improper coolant may harm engine and cooling system components and may void the warranty of your vehicle's engine cooling system. If you are unsure which type of coolant your vehicle requires, contact your local authorized dealer.**



WARNING: Do not put engine coolant in the windshield washer fluid reservoir. If engine coolant is sprayed onto the windshield, it could make it difficult to see through the windshield.

When adding coolant, make sure it is a 50/50 mixture of engine coolant and distilled water. Add the mixture to the coolant reservoir, **when the engine is cool**, until the appropriate fill level is obtained.

- **NEVER increase the coolant concentration above 60%.**
- **NEVER decrease the coolant concentration below 40%.**
- **Engine coolant concentrations above 60% or below 40% will decrease the freeze protection characteristics of the engine coolant and may cause engine damage.**

Maintenance and Specifications

A large amount of water without engine coolant may be added, in case of emergency, to reach a vehicle service location. In this instance, the cooling system must be drained and refilled with a 50/50 mixture of engine coolant and distilled water as soon as possible. Water alone (without engine coolant) can cause engine damage from corrosion, overheating or freezing.

For vehicles with overflow coolant systems with a non-pressurized cap on the coolant recovery system, add coolant to the coolant recovery reservoir when the engine is cool. Add the proper mixture of coolant and water to the "COLD FILL RANGE". For all other vehicles, which have a coolant degas system with a pressurized cap, or if it is necessary to remove the coolant pressure relief cap on the radiator of a vehicle with an overflow system, follow these steps to add engine coolant.

1. Before you begin, turn the engine off and let it cool.
2. When the engine is cool, wrap a thick cloth around the coolant pressure relief cap on the coolant reservoir (an opaque plastic bottle). Slowly turn cap counterclockwise (left) until pressure begins to release.
3. Step back while the pressure releases.
4. When you are sure that all the pressure has been released, use the cloth to turn it counterclockwise and remove the cap.
5. Fill the coolant reservoir slowly with the proper coolant mixture (see above), to within the "COLD FILL RANGE" or the "FULL COLD" level on the reservoir. If you removed the radiator cap in an overflow system, fill the radiator until the coolant is visible and radiator is almost full.
6. Replace the cap. Turn until tightly installed. Cap must be tightly installed to prevent coolant loss.

After any coolant has been added, check the coolant concentration. Refer to the *Checking engine coolant* section. If the concentration is not 50/50 (protection to -34° F [-36° C]), drain some coolant and adjust the concentration. It may take several drains and additions to obtain a 50/50 coolant concentration.

Whenever coolant has been added, the coolant level in the coolant reservoir should be checked the next few times you drive the vehicle. If necessary, add enough 50/50 concentration of engine coolant and distilled water to bring the liquid level to the proper level.

If you have to add more than 1.0 quart (1.0 liter) of engine coolant per month, have your authorized dealer check the engine cooling system.

280

2009 Tribute Hybrid (thv)
Owners Guide, 1st Printing
USA (fus)

Maintenance and Specifications

Your cooling system may have a leak. Operating an engine with a low level of coolant can result in engine overheating and possible engine damage.

Recycled engine coolant

Mazda Motor Corporation does NOT recommend the use of recycled engine coolant in vehicles originally equipped with Mazda Premium Gold Engine Coolant since a Mazda-approved recycling process is not yet available.



Used engine coolant should be disposed of in an appropriate manner. Follow your community's regulations and standards for recycling and disposing of automotive fluids.

Coolant refill capacity

To find out how much fluid your vehicle's cooling system can hold, refer to *Maintenance product specifications and capacities* in this chapter. Fill your engine coolant reservoir as outlined in *Adding engine coolant* in this section.

Severe climates

If you drive in extremely cold climates (less than -34°F [-36°C):

- **It may be necessary to increase the coolant concentration above 50%.**
- **NEVER increase the coolant concentration above 60%.**
- **Increased engine coolant concentrations above 60% will decrease the overheat protection characteristics of the engine coolant and may cause engine damage.**
- **Refer to the chart on the coolant container to ensure the coolant concentration in your vehicle will provide adequate freeze protection at the temperatures in which you drive in the winter months.**

If you drive in extremely hot climates:

- **It is still necessary to maintain the coolant concentration above 40%.**
- **NEVER decrease the coolant concentration below 40%.**
- **Decreased engine coolant concentrations below 40% will decrease the corrosion protection characteristics of the engine coolant and may cause engine damage.**

Maintenance and Specifications

- **Decreased engine coolant concentrations below 40% will decrease the freeze protection characteristics of the engine coolant and may cause engine damage.**
- **Refer to the chart on the coolant container to ensure the coolant concentration in your vehicle will provide adequate protection at the temperatures in which you drive.**

Vehicles driven year-round in non-extreme climates should use a 50/50 mixture of engine coolant and distilled water for optimum cooling system and engine protection.

FUEL FILTER

Your vehicle is equipped with a lifetime fuel filter that is integrated with the fuel tank. Regular maintenance or replacement is not needed.

WHAT YOU SHOULD KNOW ABOUT AUTOMOTIVE FUELS

Important safety precautions



WARNING: Do not overfill the fuel tank. The pressure in an overfilled tank may cause leakage and lead to fuel spray and fire.



WARNING: The fuel system may be under pressure. If you hear a hissing sound near the fuel filler door (Easy Fuel™ “no cap” fuel system), do not refuel until the sound stops. Otherwise, fuel may spray out, which could cause serious personal injury.



WARNING: Automotive fuels can cause serious injury or death if misused or mishandled.



WARNING: Gasoline may contain benzene, which is a cancer-causing agent.

Maintenance and Specifications

Observe the following guidelines when handling automotive fuel:

- Extinguish all smoking materials and any open flames before refueling your vehicle.
- Always turn off the vehicle before refueling.
- Automotive fuels can be harmful or fatal if swallowed. Fuel such as gasoline is highly toxic and if swallowed can cause death or permanent injury. If fuel is swallowed, call a physician immediately, even if no symptoms are immediately apparent. The toxic effects of fuel may not be visible for hours.
- Avoid inhaling fuel vapors. Inhaling too much fuel vapor of any kind can lead to eye and respiratory tract irritation. In severe cases, excessive or prolonged breathing of fuel vapor can cause serious illness and permanent injury.
- Avoid getting fuel liquid in your eyes. If fuel is splashed in the eyes, remove contact lenses (if worn), flush with water for 15 minutes and seek medical attention. Failure to seek proper medical attention could lead to permanent injury.
- Fuels can also be harmful if absorbed through the skin. If fuel is splashed on the skin and/or clothing, promptly remove contaminated clothing and wash skin thoroughly with soap and water. Repeated or prolonged skin contact with fuel liquid or vapor causes skin irritation.
- Be particularly careful if you are taking “Antabuse” or other forms of disulfiram for the treatment of alcoholism. Breathing gasoline vapors, or skin contact could cause an adverse reaction. In sensitive individuals, serious personal injury or sickness may result. If fuel is splashed on the skin, promptly wash skin thoroughly with soap and water. Consult a physician immediately if you experience an adverse reaction.



WARNING: When refueling always shut the engine off and never allow sparks or open flames near the filler neck. Never smoke while refueling. Fuel vapor is extremely hazardous under certain conditions. Care should be taken to avoid inhaling excess fumes.



WARNING: The flow of fuel through a fuel pump nozzle can produce static electricity, which can cause a fire if fuel is pumped into an ungrounded fuel container.

Maintenance and Specifications

Refueling



WARNING: Fuel vapor burns violently and a fuel fire can cause severe injuries. To help avoid injuries to you and others:

- **Read and follow all the instructions on the pump island;**
- **Turn off your engine when you are refueling;**
- **Do not smoke if you are near fuel or refueling your vehicle;**
- **Keep sparks, flames and smoking materials away from fuel;**
- **Stay outside your vehicle and do not leave the fuel pump unattended when refueling your vehicle — this is against the law in some places;**
- **Keep children away from the fuel pump; never let children pump fuel.**

Use the following guidelines to avoid electrostatic charge build-up when filling an ungrounded fuel container:

- Place approved fuel container on the ground.
- DO NOT fill a fuel container while it is in the vehicle (including the cargo area).
- Keep the fuel pump nozzle in contact with the fuel container while filling.
- DO NOT use a device that would hold the fuel pump handle in the fill position.

Easy Fuel™ “no cap” fuel system

Your fuel tank is equipped with an Easy Fuel™ “no cap” fuel filler system. This allows you to simply open the fuel filler door and insert the fuel filler nozzle into the fuel system. The Easy Fuel™ system is self-sealing and protected against dust, dirt, water and snow/ice.

When fueling your vehicle:

1. Turn the engine off.
2. Open the fuel filler door.
3. Slowly insert the fuel filler nozzle fully into the fuel system. Pump fuel as normal.

Maintenance and Specifications

4. After you are done pumping fuel, slowly remove the fuel filler nozzle—allow about five seconds after pumping fuel before removing the fuel filler nozzle. This allows residual fuel to drain back into the fuel tank and not spill onto the vehicle.

If the Check Fuel Fill Inlet lamp or Check Fuel Fill Inlet message comes on, the fuel fill inlet may not have properly closed. The inlet may have stuck open or debris may be preventing the inlet from fully closing. At the next opportunity, safely pull off the road, turn off the engine, open the fuel filler door and remove any visible debris from the fuel fill opening. Insert either the fuel fill nozzle or the fuel fill funnel (see *Refilling with a portable fuel container* for funnel location) provided with the vehicle several times to dislodge any debris and/or allow the inlet to close properly. If this action corrects the problem, the Check Fuel Fill Inlet lamp or Check Fuel Fill Inlet message may not reset immediately. It may take several driving cycles for the Check Fuel Fill Inlet lamp or Check Fuel Fill Inlet message to turn off. A driving cycle consists of an engine start-up (after four or more hours with the engine off) followed by city/highway driving. Continuing to drive with the Check Fuel Fill Inlet lamp or Check Fuel Fill Inlet message on may cause the Service Engine Soon lamp to turn on as well.



WARNING: The fuel system may be under pressure. If you hear a hissing sound near the fuel filler door (Easy Fuel™ “no cap” fuel system), do not refuel until the sound stops. Otherwise, fuel may spray out, which could cause serious personal injury.

Choosing the right fuel

Use only UNLEADED fuel or UNLEADED fuel blended with a maximum of 10% ethanol. Do not use fuel ethanol (E85), diesel, methanol, leaded fuel or any other fuel. The use of leaded fuel is prohibited by law and could damage your vehicle.

Your vehicle was not designed to use fuel or fuel additives with metallic compounds, including manganese-based additives.

Note: Use of any fuel other than those recommended may cause powertrain damage, a loss of vehicle performance, and repairs may not be covered under warranty.

Maintenance and Specifications

Octane recommendations

Your vehicle is designed to use “Regular” unleaded gasoline with a pump (R+M)/2 octane rating of 87. We do not recommend the use of gasolines labeled as “Regular” in high altitude areas that are sold with octane ratings less than 87.

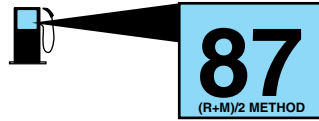

Do not be concerned if your engine sometimes knocks lightly. However, if it knocks heavily under most driving conditions while you are using fuel with the recommended octane rating, see your authorized dealer to prevent any engine damage.

Fuel quality

If you are experiencing starting, rough idle or hesitation driveability problems, try a different brand of unleaded gasoline. “Premium” unleaded gasoline is not recommended for vehicles designed to use “Regular” unleaded gasoline because it may cause these problems to become more pronounced. If the problems persist, see your authorized dealer.

Do not add aftermarket fuel additive products to your fuel tank. It should not be necessary to add any aftermarket products to your fuel tank if you continue to use high quality fuel of the recommended octane rating. These products have not been approved for your engine and could cause damage to the fuel system. Repairs to correct the effects of using an aftermarket product in your fuel may not be covered by your warranty.

Many of the world’s automakers approved the World-Wide Fuel Charter that recommends gasoline specifications to provide improved performance and emission control system protection for your vehicle. Gasolines that meet the World-Wide Fuel Charter should be used when available. Ask your fuel supplier about gasolines that meet the World-Wide Fuel Charter.

Cleaner air

Mazda endorses the use of reformulated “cleaner-burning” gasolines to improve air quality, per the recommendations in the *Choosing the right fuel* section.

Running out of fuel

Avoid running out of fuel because this situation may have an adverse effect on powertrain components.

286

2009 Tribute Hybrid (thv)
Owners Guide, 1st Printing
USA (fus)

Maintenance and Specifications

If you have run out of fuel:

- You may need to cycle the ignition from off to on several times after refueling to allow the fuel system to pump the fuel from the tank to the engine. On restarting, cranking time will take a few seconds longer than normal.
- Normally, adding 1 gallon (3.8L) of fuel is enough to restart the engine. If the vehicle is out of fuel and on a steep grade, more than 1 gallon (3.8L) may be required.
- The *Service engine soon*  indicator may come on. For more information on the “service engine soon” indicator, refer to *Warning lights and chimes* in the *Instrument Cluster* chapter.

Refilling with a portable fuel container

With the Easy Fuel™ “no cap” fuel system, use the following directions when filling from a portable fuel container:

 **WARNING:** Do not insert the nozzle of portable fuel containers or aftermarket funnels into the Easy Fuel™ system. This could damage the fuel system and its seal, and may cause fuel to run onto the ground instead of filling the tank, which could result in serious personal injury.

 **WARNING:** Do not try to pry open or push open the Easy Fuel™ system with foreign objects. This could damage the fuel system and its seal and cause injury to you or others.

When filling the vehicle’s fuel tank from a portable fuel container, use the included funnel.

1. Locate the white plastic funnel. It is attached to the inside of the rear passenger side cargo compartment access door.

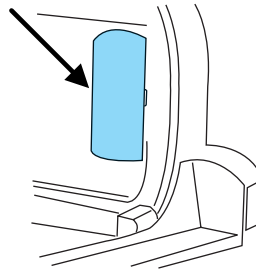

Maintenance and Specifications

2. Slowly insert the funnel into the Easy Fuel™ system.

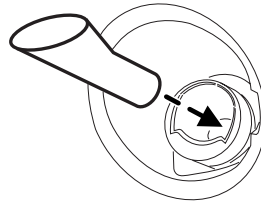

3. Fill the vehicle with fuel from the portable fuel container.
4. When done, clean the funnel or properly dispose of it. Extra funnels can be purchased from your authorized dealer if you choose to dispose of the funnel. **Do not** use aftermarket funnels; they will not work with the Easy Fuel™ system and can damage it. The included funnel has been specially designed to work safely with your vehicle.

ESSENTIALS OF GOOD FUEL ECONOMY

Measuring techniques

Your best source of information about actual fuel economy is you, the driver. You must gather information as accurately and consistently as possible. Fuel expense, frequency of fill-ups or fuel gauge readings are NOT accurate as a measure of fuel economy. We do not recommend taking fuel economy measurements during the first 1,000 miles (1,600 km) of driving (engine break-in period). You will get a more accurate measurement after 2,000 miles–3,000 miles (3,000 km–5,000 km).

Filling the tank

When the fuel gauge indicates empty, there is still a small reserve of fuel in the fuel system. When refueling your vehicle after the fuel gauge indicates empty, you might not be able to refuel the full amount of the advertised capacity of the fuel tank due to the empty reserve still present in the tank. The amount of usable fuel in the empty reserve varies and should not be relied upon to increase driving range.

For consistent results when filling the fuel tank:

- Turn the engine/ignition switch to the off position prior to refueling; an error in the reading will result if the engine is left running.
- Allow no more than two automatic click-offs when filling.

288

2009 Tribute Hybrid (thv)
Owners Guide, 1st Printing
USA (fus)

Maintenance and Specifications

- Always use fuel with the recommended octane rating.
- Use a known quality gasoline, preferably a national brand.

Your results will be most accurate if your filling method is consistent.

Calculating fuel economy

1. Fill the fuel tank completely and record the initial odometer reading (in miles or kilometers).
2. Each time you fill the tank, record the amount of fuel added (in gallons or liters).
3. After at least three to five tank fill-ups, fill the fuel tank and record the current odometer reading.
4. Subtract your initial odometer reading from the current odometer reading.
5. Follow one of the simple calculations in order to determine fuel economy:

Calculation 1: **Divide total miles traveled by total gallons used.**

Calculation 2: **Multiply liters used by 100, then divide by total kilometers traveled.**

Keep a record for at least one month and record the type of driving (city or highway). This will provide an accurate estimate of the vehicle's fuel economy under current driving conditions. Additionally, keeping records during summer and winter will show how temperature impacts fuel economy. In general, very hot or very cold temperatures give lower fuel economy.

Driving style — good driving and fuel economy habits

Since it is able to operate in electric mode and to collect braking energy, your hybrid vehicle will get better fuel economy in city driving than on the highway. This is contrary to conventional vehicles. However, many of the same actions that improve fuel economy in a conventional vehicle will also improve fuel economy in this vehicle.

Give consideration to the lists that follow and you may be able to improve your fuel economy.

Habits

- Avoid aggressive driving. Quick acceleration and deceleration decrease fuel economy.
- Drive at a smooth, constant speed. Excessive variation in pedal input causes more operating mode changes and reduces efficiency.

Maintenance and Specifications

- Drive at reasonable speeds. Traveling at 60 mph [96 km/h] uses approximately 20% less fuel than traveling at 70 mph [112 km/h]).
- Minimize A/C and defroster usage. Selecting defrost, or defrost/floor mode on the climate control system will force the engine to run continuously, which reduces fuel economy. Selecting AUTO will typically force the engine to run continuously, unless ECON is selected. ECON will allow the engine to shut down for a period of time, even when air conditioning is requested.
- Minimize temperature extremes when the vehicle is parked, for example by storing in a garage to avoid extreme cold in winter and extreme sun loads in summer. The high voltage battery operates more efficiently in moderate temperatures.
- Combine errands. Your vehicle is more fuel efficient when the engine is warm. Driving to your farthest destination first will warm the engine more quickly and may improve fuel economy for the rest of the trip.

Maintenance

- Keep tires properly inflated and use only recommended size.
- Keep wheels properly aligned.
- Use recommended engine oil. Refer to *Lubricant specifications* in this chapter.
- Perform all regularly scheduled maintenance items. Follow the recommended maintenance schedule and owner maintenance checks found in *scheduled maintenance information*.

Conditions

- Heavily loading a vehicle or towing a trailer may reduce fuel economy at any speed.
- Carrying unnecessary weight may reduce fuel economy (approximately 1 mpg [0.4 km/L] is lost for every 300 lb [136 kg] of weight carried).
- Adding certain accessories to your vehicle (for example; bug deflectors, rollbars/light bars, running boards, ski/luggage racks, flags) may reduce fuel economy.
- Using fuel blended with alcohol may lower fuel economy.
- Driving on flat terrain offers improved fuel economy as compared to driving on mountainous terrain.
- Close windows for high speed driving.

Maintenance and Specifications

EPA fuel economy estimates

Every new vehicle should have a window sticker containing EPA fuel economy estimates. Contact your authorized dealer if the window sticker is not supplied with your vehicle. The EPA fuel economy estimates should be your guide for the fuel economy comparisons with other vehicles. Your fuel economy may vary depending upon the method of operation and conditions.

EMISSION CONTROL SYSTEM

Your vehicle is equipped with various emission control components and a catalytic converter which will enable your vehicle to comply with applicable exhaust emission standards. To make sure that the catalytic converter and other emission control components continue to work properly:

- Use only the specified fuel listed.
- Avoid running out of fuel.
- Do not turn off the ignition while your vehicle is moving, especially at high speeds.
- Have the items listed in *scheduled maintenance information* performed according to the specified schedule.

The scheduled maintenance items listed in *scheduled maintenance information* are essential to the life and performance of your vehicle and to its emissions system.

If other than Mazda or Mazda-authorized parts are used for maintenance replacements or for service of components affecting emission control, such non-Mazda parts should be equivalent to genuine Mazda Motor Corporation parts in performance and durability.



WARNING: Do not park, idle, or drive your vehicle in dry grass or other dry ground cover. The emission system heats up the engine compartment and exhaust system, which can start a fire.

Illumination of the *Service engine soon*  indicator, charging system warning light or the temperature warning light, fluid leaks, strange odors, smoke or loss of engine power could indicate that the emission control system is not working properly.

An improperly operating or damaged exhaust system may allow exhaust to enter the vehicle. Have a damaged or improperly operating exhaust system inspected and repaired immediately.

Maintenance and Specifications





WARNING: Exhaust leaks may result in entry of harmful and potentially lethal fumes into the passenger compartment.

Do not make any unauthorized changes to your vehicle or engine. By law, vehicle owners and anyone who manufactures, repairs, services, sells, leases, trades vehicles, or supervises a fleet of vehicles are not permitted to intentionally remove an emission control device or prevent it from working. Information about your vehicle's emission system is on the Vehicle Emission Control Information Decal located on or near the engine. This decal also lists engine displacement.

Please consult your *Warranty Guide/Customer Information Guide* for complete emission warranty information.

On board diagnostics (OBD-II)

Your vehicle is equipped with a computer that monitors the engine's emission control system. This system is commonly known as the On Board Diagnostics System (OBD-II). The OBD-II system protects the environment by ensuring that your vehicle continues to meet government emission standards. The OBD-II system also assists your authorized dealer in properly servicing your vehicle. When the *Service engine soon*  indicator illuminates, the OBD-II system has detected a malfunction. Temporary malfunctions may cause the *Service engine soon*  indicator to illuminate. Examples are:

1. The vehicle has run out of fuel—the engine may misfire or run poorly.
2. Poor fuel quality or water in the fuel—the engine may misfire or run poorly.
3. The fuel fill inlet may not have been properly closed. See *Easy Fuel™* “no cap” fuel system in this chapter.
4. Driving through deep water—the electrical system may be wet.

These temporary malfunctions can be corrected by filling the fuel tank with good quality fuel, properly closing the fuel fill inlet or letting the electrical system dry out. After three driving cycles without these or any other temporary malfunctions present, the *Service engine soon*  indicator should stay off the next time the engine is started. A driving cycle consists of a cold engine startup followed by mixed city/highway driving. No additional vehicle service is required.

If the *Service engine soon*  indicator remains on, have your vehicle serviced at the first available opportunity. Although some malfunctions



Maintenance and Specifications

detected by the OBD-II may not have symptoms that are apparent, continued driving with the *Service engine soon*  indicator on can result in increased emissions, lower fuel economy, reduced engine and transmission smoothness, and lead to more costly repairs.

Readiness for Inspection/Maintenance (I/M) testing

Some state/provincial and local governments may have Inspection/Maintenance (I/M) programs to inspect the emission control equipment on your vehicle. Failure to pass this inspection could prevent you from getting a vehicle registration. Your vehicle may not pass the I/M test if the *Service engine soon*  indicator is on or not working properly (bulb is burned out), or if the OBD-II system has determined that some of the emission control systems have not been properly checked. In this case, the vehicle is considered not ready for I/M testing.

If the *Service engine soon*  indicator is on or the bulb does not work, the vehicle may need to be serviced. Refer to the On board diagnostics (OBD-II) description in this chapter.

If the vehicle's engine or transmission has just been serviced, or the battery has recently run down or been replaced, the OBD-II system may indicate that the vehicle is not ready for I/M testing. To determine if the vehicle is ready for I/M testing, turn the ignition key to the on position for 15 seconds without cranking the engine. If the *Service engine soon*  indicator blinks eight times, it means that the vehicle is not ready for I/M testing; if the *Service engine soon*  indicator stays on solid, it means that the vehicle is ready for I/M testing.

The OBD-II system is designed to check the emission control system during normal driving. A complete check may take several days. If the vehicle is not ready for I/M testing, the following driving cycle consisting of mixed city and highway driving may be performed:

15 minutes of steady driving on an expressway/highway followed by 20 minutes of stop-and-go driving with at least four 30-second idle periods.

Allow the vehicle to sit for at least eight hours without starting the engine. Then, start the engine and complete the above driving cycle. The engine must warm up to its normal operating temperature. Once started, do not turn off the engine until the above driving cycle is complete. If the vehicle is still not ready for I/M testing, the above driving cycle will have to be repeated.

Maintenance and Specifications

BRAKE FLUID

The fluid level will drop slowly as the brakes wear, and will rise when the brake components are replaced.

Check fluid levels with the ignition in the RUN position. Fluid levels between the “MIN” and “MAX” lines are within the normal operating range; there is no need to add fluid.

If the fluid levels are outside of the normal operating range the performance of your brake system could be compromised; seek service from your authorized dealer immediately.

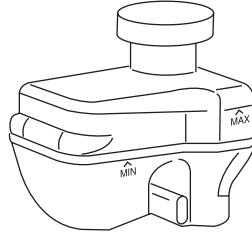

TRANSMISSION FLUID

Checking electronically controlled continuously variable transmission (eCVT)

Refer to your *scheduled maintenance information* chapter for scheduled intervals for fluid checks and changes. Your transmission does not consume fluid. It is designed to be filled for life. However, the fluid level should be checked if you notice some sign of fluid leakage.

Automatic transmission fluid expands when warmed. To obtain an accurate fluid check, drive the vehicle until it is warmed up (approximately 20 miles [30 km]). If your vehicle has been operated for an extended period at high speeds, in city traffic during hot weather or pulling a trailer, the vehicle should be turned off for about 30 minutes to allow fluid to cool before checking.

1. Drive the vehicle 20 miles (30 km) or until it reaches normal operating temperature.
2. Park the vehicle on a level surface and engage the parking brake.

Maintenance and Specifications

3. With the parking brake engaged and your foot on the brake pedal, turn the key to the ACCESSORY position but do not start the engine. Turn the wheel to the left to gain access to the check plug.

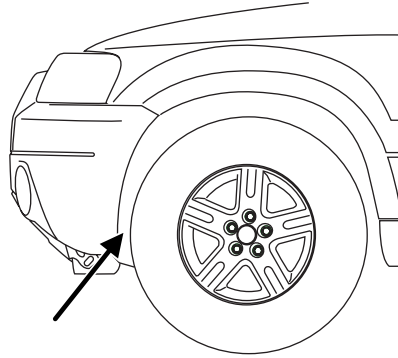

4. Latch the gearshift lever in P (Park) and make sure that the engine is OFF by placing the ignition in the Lock position.
5. Remove the check plug from the side of the transmission.

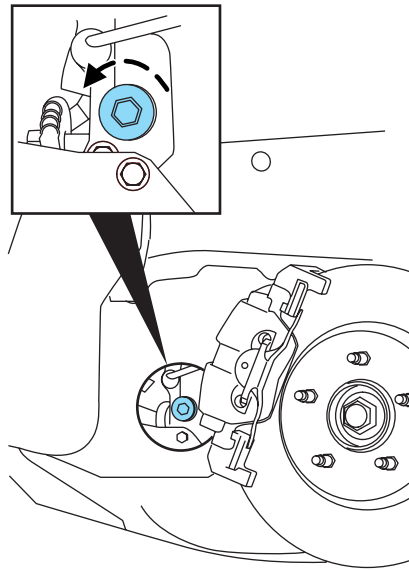

Maintenance and Specifications

6. Be sure the engine has been stopped for at least 3 minutes before performing the fluid level check.
7. The fluid level should be within 1/4 inch (6 mm) of the plug threads.
8. Replace the check plug.

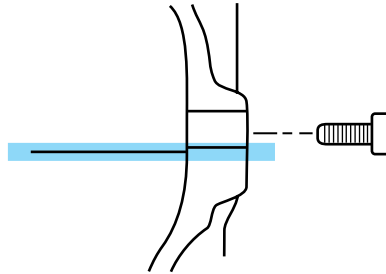

Adjusting eCVT fluid levels

Before adding any fluid, make sure the correct type is used. The type of fluid used is indicated in the *Maintenance product specifications and capacities* section in this chapter.

Use of a non-approved fluid may cause internal transmission component damage.

If the fluid level is low, add fluid through the check port until the level is correct and fluid begins to run out of the transmission. If an overfill occurs, excess fluid should be removed by allowing the fluid to run out of the check port.

A serious overfill condition of transmission fluid may cause damage.

Do not use supplemental transmission fluid additives, treatments or cleaning agents. The use of these materials may affect transmission operation and result in damage to internal transmission components.

Maintenance and Specifications

AIR FILTER

Refer to *scheduled maintenance information* for the appropriate intervals for changing the air filter element.

When changing the air filter element, use only the Mazda air filter element listed. Refer to *Mazda part numbers* in this chapter.



WARNING: To reduce the risk of vehicle damage and/or personal burn injuries do not start your engine with the air cleaner removed and do not remove it while the engine is running.

Changing the air filter element

1. Release the clamps that secure the air filter housing cover.
2. Carefully separate the two halves of the air filter housing.

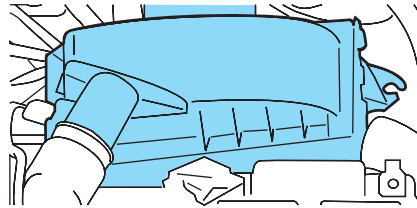

3. Remove the air filter element from the air filter housing.
4. Wipe the air filter housing and cover clean to remove any dirt or debris and to ensure good sealing.
5. Install a new air filter element. Be careful not to crimp the filter element edges between the air filter housing and cover. This could cause filter damage and allow unfiltered air to enter the engine if not properly seated.
6. Replace the air filter housing cover and secure the clamps.

Note: Failure to use the correct air filter element may result in severe engine damage. The customer warranty may be voided for any damage to the engine if the correct air filter element is not used.

Maintenance and Specifications

HIGH VOLTAGE BATTERY COOLING FILTER (REAR A/C) MAINTENANCE

The high voltage battery has a dedicated A/C cooling system which includes an air filter.

Refer to the *scheduled maintenance information* for the appropriate intervals for air filter.

When changing the air filter element, use only the Mazda air filter element listed. Refer to *Mazda part numbers* in this chapter.

Changing the high voltage battery air filter element

1. Remove access panel located in the rear cargo area on the driver's side trim panel to expose the filter cover.

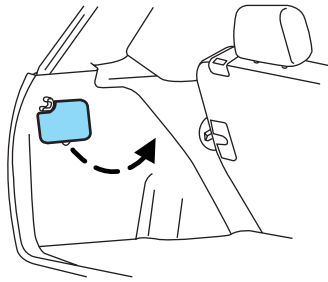

2. Push the tabs (located on each side of filter cover) while pulling gently to remove filter cover. Remove the old filter.

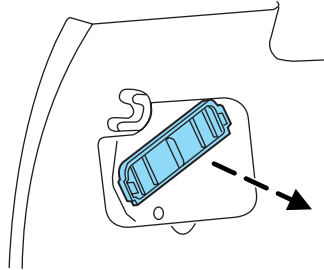

3. Install new filter and filter cover (note arrows indicating top side). The arrow on the filter cover and the arrow on the filter both point in the same direction (upward).
4. Re-install the access panel into the trim panel.

Maintenance and Specifications

MAINTENANCE PRODUCT SPECIFICATIONS AND CAPACITIES

Item	Capacity	Mazda Part Name or equivalent	Application
Brake fluid	Between MIN and MAX lines on reservoir	High Performance DOT 3 Motor Vehicle Brake Fluid	Brake fluid reservoir
Engine coolant	7.4 quarts (7.0L)	Mazda Premium Engine Coolant ¹	Cooling systems
Motor/Electronics (M/E) Coolant	3.7 quarts (3.5L)		
Engine oil	5.0 quarts (4.73L)	SAE 5W-20 Motor Oil	Engine
Automatic eCVT transmission fluid	5.3 quarts (5.0L) ²	MERCON® V ATF ³	Transmission
Rear axle fluid (4WD)	2.96 pints (1.4L) ⁴	API service GL-5 SAE 80W-90 ⁵	Rear axle
Power Transfer Unit fluid (4WD) ⁶	12 ounces (0.35L)	API service GL-5 SAE 75W-140 Synthetic Lubricant	Power transfer unit
Windshield washer fluid	2.7 quarts (2.6L)	Ultra-clear Windshield Washer Concentrate	Washer fluid reservoir
Fuel tank	15 gallons (56.8L)	—	All

¹Add the coolant type originally equipped in your vehicle. Refer to *Adding engine coolant* in this chapter.

²Indicates only approximate dry-fill capacity.

³Using any transmission fluid other than those that meet the recommended specification may cause internal transaxle damage. Do not use MERCON® CVT (blue) ATF. This vehicle uses only MERCON® V ATF.

⁴Fill to 1/4 inch to 9/16 inch (6mm to 14mm) below bottom of fill hole.

⁵4WD vehicles exposed for prolonged periods to temperatures less than -40° C (-40° F) should change out the rear axle fluid to SAE 75W-140 axle lubricant.

⁶The Power Transfer Unit is lubricated for life with synthetic lube. Lubricant levels are not to be checked or changed unless a leak is suspected or repair required. Replace Power Transfer Unit lubricant with specified synthetic lubricant anytime the unit is submerged in water.

Maintenance and Specifications

ENGINE DATA

Engine	2.5L I4 engine
Cubic inches	152
Required fuel	87 octane
Firing order	1-3-4-2
Ignition system	Coil on plug
Spark plug gap	0.049–0.053 inch (1.25–1.35mm)
Compression ratio	12.3:1

Engine drivebelt routing

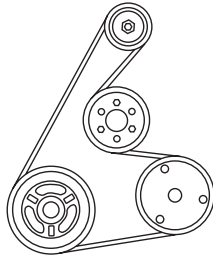

- 2.5L I4 Engine

HIGH VOLTAGE BATTERY DATA

High Voltage Battery	
Battery chemistry	Nickel metal hydride
Nominal voltage	330 volts
Battery system capacity	6 amp-hours

Maintenance and Specifications

IDENTIFYING YOUR VEHICLE

Safety Compliance Certification Label

The National Highway Traffic Safety Administration Regulations require that a Safety Compliance Certification Label be affixed to a vehicle and prescribe where the Safety Compliance Certification Label may be located. The Safety Compliance Certification Label is located on the structure (B-Pillar) by the trailing edge of the driver's door or the edge of the driver's door.

MFD. BY FORD MOTOR CO. IN U.S.A.					
FOR MAZDA MOTOR CORPORATION					
DATE: XX/XX	GVWR: XXXXXLB/XXXXXKG				
FRONT GAWR: XXXXL	REAR GAWR: XXXXLB				
XXXXKG	WITH	XXXXKG	WITH		
XXXX/XXXXXX	TIRES	XXXX/XXXXXX	TIRES		
XXXX.XX	RIMS	XXXX.XX	RIMS		
AT XXX kPa/XX	PSI COLD	AT XXX kPa/XX	PSI COLD		
THIS VEHICLE CONFORMS TO ALL APPLICABLE FEDERAL MOTOR VEHICLE SAFETY AND THEFT PREVENTION STANDARDS IN EFFECT ON THE DATE OF MANUFACTURE SHOWN ABOVE.					
VIN: XXXXXXXXXXXXXXXXX					
TYPE: XXX					
					
EXT PNT: XX	RC: XX	DSO:			
WB ' BRK ' INT TR ' TP/PS ' R ' AXLE ' TR SPR ' XXXXX					
XXX X XX X XX X XX XXX					
XXXXXXXXXXXX XXX XXXX-XXXXXX-XX					

Vehicle identification number (VIN)

The vehicle identification number is located on the driver side instrument panel.

Please note that in the graphic, XXXX is representative of your vehicle identification number.

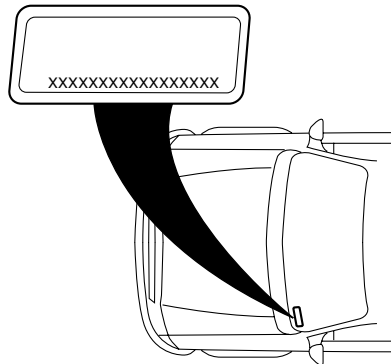

Maintenance and Specifications

The Vehicle Identification Number (VIN) contains the following information:

1. World manufacturer identifier
2. Brake system / Gross Vehicle Weight Rating (GVWR) / Restraint System
3. Vehicle line, series, body type
4. Engine type
5. Check digit
6. Model year
7. Assembly plant
8. Production sequence number

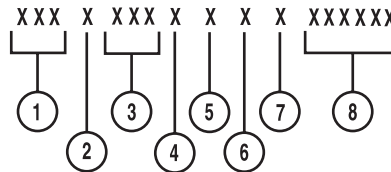

TRANSMISSION CODE DESIGNATIONS

You can find a transmission code on the Safety Compliance Certification Label. The following table tells you which transmission each code represents.

MFD. BY FORD MOTOR CO. IN U.S.A.	
FOR MAZDA MOTOR CORPORATION	
DATE: XX/XX	GVWR: XXXXXLb/ XXXXXKg
FRONT GAWR: XXXXL	REAR GAWR: XXXXLb
XXXXKg WITH XXXXXKg	XXXXKg WITH XXXXXKg
XXXX/XXXXXXXXX TIRES	XXXX/XXXXXXXXX TIRES
XXXX.XX RIMS	XXXX.XX RIMS
AT XXX kPa/XX PSI COLD	AT XXX kPa/XX PSI COLD
THIS VEHICLE CONFORMS TO ALL APPLICABLE FEDERAL MOTOR VEHICLE SAFETY AND THEFT PREVENTION STANDARDS IN EFFECT ON THE DATE OF MANUFACTURE SHOWN ABOVE.	
VIN: XXXXXXXXXXXXXXXXXXXX	XXXXX
TYPE: XXX	XXXXX
EXT PNT: XX	RC: XX
WB BRK INT TR TP/PS R AXLE TR SPR	XXXXX
XXX X XX X XX X XX	XXX
XXXXXXXXXXXX XXX XXXX-XXXXXX-XX	

Description	Code
Electronically controlled continuously variable transmission, eCVT	H

Accessories

CELL PHONES

Use of cell phones and other devices by driver:



WARNING: Use of any electrical devices such as cell phones, computers, portable radios, vehicle navigation or other devices by the driver while the vehicle is moving is dangerous. Dialing a number on a cell phone while driving also ties-up the driver's hands. Use of these devices will cause the driver to be distracted and could lead to a serious accident. If a passenger is unable to use the device, pull off the right-of-way to a safe area before use. If use of a cell phone is necessary despite this warning, use a hands-free system to at least allow the hands free to drive the vehicle. Never use a cell phone or other electrical device while the vehicle is moving and, instead, concentrate on the full-time job of driving. In addition, the gasoline distributors are warning against using cell phones during refueling procedures, due to their increased concern about static electricity fires in the self-service pump environment.

Service Maintenance Section

GENERAL MAINTENANCE INFORMATION

Why maintain your vehicle?

This guide describes the scheduled maintenance required for your vehicle. Carefully following this schedule helps protect against major repair expenses resulting from neglect or inadequate maintenance and may also help to increase the value of your vehicle when you sell or trade it.

It is your responsibility to see that all scheduled maintenance is performed and that the materials used meet Mazda engineering specifications. Failure to perform scheduled maintenance specific in this guide will invalidate warranty coverage on parts affected by the lack of maintenance. Be sure receipts for completed maintenance are kept with the vehicle and confirmation of the work performed is always recorded in this guide.

Your Mazda dealer, or Mazda Quality Care Center has factory trained technicians who can perform the required maintenance using genuine Mazda parts. They are committed to meeting your service needs and to assuring your continuing satisfaction.

Protecting your investment

Maintenance is an investment that will pay dividends in the form of improved reliability, durability and resale value. To ensure the proper performance of your vehicle and its emission control systems, it is imperative that scheduled maintenance be completed at the designated intervals.

Your vehicle is very sophisticated and built with multiple complex performance systems. Every manufacturer develops these systems using different specifications and performance features. That's why it's important to rely upon your Mazda dealership to properly diagnose and repair your vehicle.

Mazda Motor Corporation has recommended maintenance intervals for various parts and component systems based upon engineering testing. Mazda Motor Corporation relies upon this testing to determine the most appropriate mileage for replacement of oils and fluids to protect your vehicle at the lowest overall cost to you and recommends against maintenance schedules that deviate from the scheduled maintenance information.

Service Maintenance Section

Mazda strongly recommends the use of genuine Mazda replacement parts. Parts other than Mazda or Mazda authorized remanufactured parts that are used for maintenance replacement or for the service of components affecting emission control must be equivalent to genuine Mazda Motor Corporation parts in performance and durability. It is the owner's responsibility to determine the equivalency of such parts. Please consult your *Warranty Guide* for complete warranty information.

Non-Mazda approved chemicals or additives are not required for factory recommended maintenance. In fact, Mazda Motor Corporation recommends against the use of such additive products unless specifically recommended by Mazda for a particular application.

Oil, fluids and flushing

In many cases, fluid discoloration is a normal operating characteristic and, by itself, does not necessarily indicate a concern or that the fluid needs to be changed. However, discolored fluids that also show signs of overheating and/or foreign material contamination should be inspected immediately by a qualified expert such as the factory-trained technicians at your Mazda Dealership. Your vehicle's oils and fluids should be changed at the specified intervals or in conjunction with a repair. Flushing is a viable way to change fluid for many vehicle sub-systems during scheduled maintenance. It is critical that systems are flushed only with new fluid that is the same as that required to fill and operate the system, or using a Mazda-approved flushing chemical.

Engine Emissions label

Emissions information appears on the Engine Emissions label on the underside of the hood. This decal identifies engine displacement and provides certain engine specifications.

Any modification of the emissions control system could create liability under federal law (U.S.) if made prior to sale and registration, under the laws of some states if made thereafter. Further, federal law prohibits vehicle manufacturers, dealers and other persons engaged in the business of repairing, servicing, selling, leasing or trading motor vehicles as well as fleet operations from knowingly removing or rendering an emissions control system inoperative after sale and delivery to an ultimate purchaser. In Canada, modifications of the emissions control system could create liability under applicable federal or provincial laws.

Genuine Mazda Parts and Service

When planning your maintenance services, consider your Mazda dealership for all your vehicle's needs.

Service Maintenance Section

Get the most from your service and maintenance visits

There are a lot of reasons why visiting your Mazda Dealership for all your service needs is a great way to help keep your vehicle running great.

Convenience

Many Dealerships have extended evening and Saturday hours to make your service visit more convenient. How's that for quality service?

Factory-trained Technicians

Mazda service technicians participate in extensive factory-sponsored certification training to help them become experts on the operation of your vehicle. Ask your Dealership about the training and certification their technicians have received.

Factory Authorized Systems Checks

In the event your vehicle experiences a component related concern, please contact your Mazda dealership. The Mazda Motor Corporation Trained Technicians who work at Mazda dealerships are specifically trained to understand your vehicle.

A proper repair begins with a thorough system check. Factory Authorized Systems Checks can ONLY be found at a Mazda dealership. In some circumstances, the Technician may need to request your authorization to perform additional operations to determine the final diagnosis. The Technician's goal is to ensure that your vehicle is fixed right the first time, at the best value to you.

The following list represents several of the Factory Authorized Systems Checks available at participating Mazda Dealerships:

- Climate Control
- Check Engine Light
- All Wheel Drive/Four-Wheel Drive
- Automatic Transmission
- Engine Cooling/Cabin Heating
- Suspension/Steering
- Charge/Start/Battery
- Wheel Alignment
- Brakes

306

2009 Tribute Hybrid (thv)
Owners Guide, 1st Printing
USA (fus)

Service Maintenance Section

And when your vehicle needs replacement parts, insist that only parts meeting Mazda Motor Corporation's specifications are used. Genuine Mazda branded parts meet these specifications. You can find them at your Mazda Dealership. Look for the following brand logos to ensure the parts installed on your vehicle meet Mazda Motor Corporation Specifications.

Genuine Mazda Replacement Parts

Mazda dealerships stock Mazda branded replacement parts. These parts meet or exceed Mazda Motor Corporation's specifications, and we stand behind them. Maintenance parts installed at your Mazda dealership carry a nationwide, 12 months, 12,000 mile parts and labor limited warranty. Your dealer can give you details.

Value Shopping for Your Vehicle's Maintenance Needs

Your dealership recognizes the competitive landscape of maintenance and light repair automotive services. With factory-trained technicians, and one-stop service from routine maintenance like oil changes and tire rotations to repairs like brake service, check out the value your Mazda dealers can offer.

WHICH MAINTENANCE SCHEDULE SHOULD YOU FOLLOW?

Owner Checks and Services

Refer to Mileage Intervals for Additional Checks and Services

Certain basic maintenance checks and inspections should be performed by the owner or a service technician at the intervals indicated. Service information and supporting specifications are provided in this *Owner's Manual*.

Any adverse condition should be brought to the attention of your dealer or qualified service technician as soon as possible for the proper service advice. The owner maintenance service checks are generally not covered by warranties so you may be charged for labor, parts or lubricants used.

Maximum Oil Change Interval

- 12 months, 10,000 miles (16,000 km) or 200 hours of engine operation.

Mazda Premium Gold Engine Coolant change interval

- 6 years or 100,000 miles (160,000 km) - change Mazda Premium Gold Engine Coolant (whichever comes first)
- After initial change - change Mazda Premium Gold Engine Coolant every 3 years or 50,000 miles (80,000 km).

Service Maintenance Section

Check every month

- Check function of all interior and exterior lights
- Check tires for wear and correct air pressure, including spare tire
- Check windshield washer fluid level
- Check engine oil level

Check every six months

- Check lap/shoulder belts and seat latches for wear and function
- Check that externally mounted spare tire is properly stowed (tight)
- Check parking brake for proper operation
- Check safety warning lamps (brake, ABS, air bag, seat belt) for operation
- Check cooling system fluid level and coolant strength
- Check low voltage (underhood) battery connections and clean if necessary
- Check washer spray, wiper operation and clean all wiper blades (replace as necessary)
- Check and lubricate all hinges, latches and outside locks. Inspect for correct operation
- Check and lubricate door rubber weatherstrips. Inspect for excessive wear
- Check and clean body and door drain holes. Inspect for clogs and obstructions

Multi-point Inspection

In order to keep your vehicle running right, it is important that you have the systems on your vehicle checked regularly. This can help identify any potential issue before there are any problems. Mazda Motor Corporation suggests the following multi-point inspection to be performed at every scheduled maintenance as the way to ensure your vehicle keeps running right.

Multi-point inspection - Recommended at every visit

- Check and top up fluid levels: brake, engine coolant recovery reservoir, motor/electronics reservoir and window washer.
- Inspect tires for wear and correct air pressure.
- Check exhaust system for leaks, damage, loose parts and foreign materials.
- Check low voltage (underhood) battery performance.
- Check operation of horn, exterior lamps, turn signals and hazard warning lights.
- Check radiator, coolers and heater and air conditioning hoses.
- Inspect windshield washer spray and wiper operation.
- Check windshield for cracks, chips and pitting.
- Inspect for oil and fluid leaks.
- Inspect engine air cleaner filter and elements.
- Inspect half-shaft dust boots.
- Check shocks, struts and other suspension components for leaks and damage.

Service Maintenance Section

NORMAL SCHEDULED MAINTENANCE AND LOG

The following section contains the “Normal Schedule”. This schedule is presented at specific mileage (kilometer) intervals with exceptions noted.

ADDITIONAL INFORMATION AVAILABLE ON THE WEB

To learn more about the importance of routine and dealer-performed maintenance on your vehicle, please visit the Mazda Customer Service Web site. You'll also find important warranty information, customer assistance, technical expertise, frequently asked questions and much more. The Web site location is: www.genuineservice.com.

Then go to the vehicles and services pick at the Web site.

U.S. AND CANADIAN SCHEDULE

5,000 miles (8,000 km)	
<input type="checkbox"/> Inspect tires for wear and measure tread depth <input type="checkbox"/> Rotate tires	<p>DEALER VALIDATION:</p> <p>RO#: P&A CODE: DATE: MILEAGE:</p>
10,000 miles (16,000 km)	
<input type="checkbox"/> Change engine oil and replace oil filter <input type="checkbox"/> Inspect tires for wear and measure tread depth <input type="checkbox"/> Rotate tires <input type="checkbox"/> Inspect wheel ends for end play and noise <input type="checkbox"/> Inspect high voltage battery A/C filter, replace if necessary	<p>DEALER VALIDATION:</p> <p>RO#: P&A CODE: DATE: MILEAGE:</p>

Service Maintenance Section

20,000 miles (32,000 km)

- Change engine oil and replace oil filter
- Inspect tires for wear and measure tread depth
- Rotate tires
- Inspect wheel ends for end play and noise
- Inspect brake pads, shoes, rotors, drums, brake lines and hoses and parking brake
- Inspect engine and Motor/electronics cooling system and hoses
- Inspect steering linkage, suspension and, if equipped, half-shafts, driveshaft and ball joints
- Inspect exhaust system and heat shields
- Replace high voltage battery A/C filter

DEALER VALIDATION:

RO#: P&A CODE:
DATE: MILEAGE:

30,000 miles (48,000 km)

- Change engine oil and replace oil filter
- Inspect tires for wear and measure tread depth
- Rotate tires
- Inspect wheel ends for end play and noise
- Inspect high voltage battery A/C filter, replace if necessary
- Replace engine air filter

DEALER VALIDATION:

RO#: P&A CODE:
DATE: MILEAGE:

40,000 miles (64,000 km)

- Change engine oil and replace oil filter
- Inspect tires for wear and measure tread depth
- Rotate tires
- Inspect wheel ends for end play and noise
- Inspect brake pads, shoes, rotors, drums, brake lines and hoses and parking brake
- Inspect engine and Motor/electronics cooling system and hoses
- Inspect steering linkage, suspension and, if equipped, half-shafts, driveshaft and ball joints
- Inspect exhaust system and heat shields
- Replace high voltage battery A/C filter

DEALER VALIDATION:

RO#: P&A CODE:
DATE: MILEAGE:

Service Maintenance Section

50,000 miles (80,000 km)

- Change engine oil and replace oil filter
- Inspect tires for wear and measure tread depth
- Rotate tires
- Inspect wheel ends for end play and noise
- Inspect high voltage battery A/C filter, replace if necessary

DEALER VALIDATION:

RO#:

P&A CODE:

DATE:

MILEAGE:

60,000 miles (96,000 km)

- Change engine oil and replace oil filter
- Inspect tires for wear and measure tread depth
- Rotate tires
- Inspect wheel ends for end play and noise
- Inspect brake pads, shoes, rotors, drums, brake lines and hoses and parking brake
- Inspect engine and Motor/electronics cooling system and hoses
- Inspect steering linkage, suspension and, if equipped, half-shafts, driveshaft and ball joints
- Inspect exhaust system and heat shields
- Replace high voltage battery A/C filter
- Replace engine air filter

DEALER VALIDATION:

RO#:

P&A CODE:

DATE:

MILEAGE:

70,000 miles (112,000 km)

- Change engine oil and replace oil filter
- Inspect tires for wear and measure tread depth
- Rotate tires
- Inspect wheel ends for end play and noise
- Inspect high voltage battery A/C filter, replace if necessary

DEALER VALIDATION:

RO#:

P&A CODE:

DATE:

MILEAGE:

Service Maintenance Section

80,000 miles (128,000 km)

- Change engine oil and replace oil filter
- Inspect tires for wear and measure tread depth
- Rotate tires
- Inspect wheel ends for end play and noise
- Inspect brake pads, shoes, rotors, drums, brake lines and hoses and parking brake
- Inspect engine and Motor/electronics cooling system and hoses
- Inspect steering linkage, suspension and, if equipped, half-shafts, driveshaft and ball joints
- Inspect exhaust system and heat shields
- Replace high voltage battery A/C filter

DEALER VALIDATION:

RO#: P&A CODE:
DATE: MILEAGE:

90,000 miles (144,000 km)

- Change engine oil and replace oil filter
- Inspect tires for wear and measure tread depth
- Rotate tires
- Inspect wheel ends for end play and noise
- Inspect high voltage battery A/C filter, replace if necessary
- Replace engine air filter

DEALER VALIDATION:

RO#: P&A CODE:
DATE: MILEAGE:

100,000 miles (160,000 km)

- Change engine oil and replace oil filter
- Inspect tires for wear and measure tread depth
- Rotate tires
- Inspect wheel ends for end play and noise
- Inspect brake pads, shoes, rotors, drums, brake lines and hoses and parking brake
- Inspect engine and Motor/electronics cooling system and hoses
- Inspect steering linkage, suspension and, if equipped, half-shafts, driveshaft and ball joints
- Inspect exhaust system and heat shields
- Replace high voltage battery A/C filter
- Replace engine coolant and Motor/electronics coolant (see Mazda Premium Gold Coolant Change Record)
- Inspect accessory drive belt
- Replace spark plugs

DEALER VALIDATION:

RO#: P&A CODE:
DATE: MILEAGE:

Service Maintenance Section

110,000 miles (176,000 km)

- Change engine oil and replace oil filter
- Inspect tires for wear and measure tread depth
- Rotate tires
- Inspect wheel ends for end play and noise
- Inspect high voltage battery A/C filter, replace if necessary

DEALER VALIDATION:

RO#: P&A CODE:
DATE: MILEAGE:

120,000 miles (192,000 km)

- Change engine oil and replace oil filter
- Inspect tires for wear and measure tread depth
- Rotate tires
- Inspect wheel ends for end play and noise
- Inspect brake pads, shoes, rotors, drums, brake lines and hoses and parking brake
- Inspect engine and Motor/electronics cooling system and hoses
- Inspect steering linkage, suspension and, if equipped, half-shafts, driveshaft and ball joints
- Inspect exhaust system and heat shields
- Replace high voltage battery A/C filter
- Replace engine air filter

DEALER VALIDATION:

RO#: P&A CODE:
DATE: MILEAGE:

130,000 miles (208,000 km)

- Change engine oil and replace oil filter
- Inspect tires for wear and measure tread depth
- Rotate tires
- Inspect wheel ends for end play and noise
- Inspect high voltage battery A/C filter, replace if necessary

DEALER VALIDATION:

RO#: P&A CODE:
DATE: MILEAGE:

Service Maintenance Section

140,000 miles (224,000 km)

- Change engine oil and replace oil filter
- Inspect tires for wear and measure tread depth
- Rotate tires
- Inspect wheel ends for end play and noise
- Inspect brake pads, shoes, rotors, drums, brake lines and hoses and parking brake
- Inspect engine and Motor/electronics cooling system and hoses
- Inspect steering linkage, suspension and, if equipped, half-shafts, driveshaft and ball joints
- Inspect exhaust system and heat shields
- Replace high voltage battery A/C filter

DEALER VALIDATION:

RO#: P&A CODE:
DATE: MILEAGE:

150,000 miles (240,000 km)

- Change engine oil and replace oil filter
- Inspect tires for wear and measure tread depth
- Rotate tires
- Inspect wheel ends for end play and noise
- Inspect high voltage battery A/C filter
- Replace engine air filter
- Replace engine coolant and Motor/electronics coolant (see Mazda Premium Gold Coolant Change Record)
- Replace accessory drive belt (if not replaced in the last 100,000 miles)
- Inspect PCV valve for flow and replace, if required
- Replace rear axle lubricant (4WD vehicles only)

DEALER VALIDATION:

RO#: P&A CODE:
DATE: MILEAGE:

SPECIAL OPERATING CONDITIONS

Towing a trailer or using a camper or car-top carrier

Every 5,000 miles, 6 months or 200 hours of engine operation (whichever comes first) Change engine oil and replace filter

Every 5,000 miles Inspect tires and rotate
Inspect wheel ends for end play and noise

Service Maintenance Section

Extensive Idling and/or Low Speed Driving for Long Distances as in Heavy Commercial Use Such as Delivery, Taxi, Patrol Vehicle or Livery. This operating condition is for Extensive Maximum A/C or Heater Operation with engine on in the above listed usage.

Every 5,000 miles, 6 months or 200 hours of engine operation (whichever comes first) Change engine oil and replace filter

Every 5,000 miles Inspect tires and rotate
Inspect wheel ends for end play and noise

Every 60,000 miles Replace spark plugs

As required Replace cabin air filter, if equipped

Operating in dusty conditions such as unpaved or dusty roads

Every 5,000 miles, 6 months or 200 hours of engine operation (whichever comes first) Change engine oil and replace filter

As required Inspect tires and rotate
Inspect wheel ends for end play and noise

Replace cabin air filter, if equipped
Replace engine air filter
Replace high voltage battery A/C air filter

Off-road operation

Every 5,000 miles, 6 months or 200 hours of engine operation (whichever comes first) Change engine oil and replace filter

As required Inspect tires and rotate
Inspect wheel ends for end play and noise

Replace cabin air filter, if equipped
Replace engine air filter
Replace high voltage battery A/C filter

Service Maintenance Section

Special Operating Conditions Log

DEALER VALIDATION:	DEALER VALIDATION:
RO#: P&A CODE: DATE: MILEAGE:	RO#: P&A CODE: DATE: MILEAGE:
DEALER VALIDATION:	DEALER VALIDATION:
RO#: P&A CODE: DATE: MILEAGE:	RO#: P&A CODE: DATE: MILEAGE:
DEALER VALIDATION:	DEALER VALIDATION:
RO#: P&A CODE: DATE: MILEAGE:	RO#: P&A CODE: DATE: MILEAGE:
DEALER VALIDATION:	DEALER VALIDATION:
RO#: P&A CODE: DATE: MILEAGE:	RO#: P&A CODE: DATE: MILEAGE:
DEALER VALIDATION:	DEALER VALIDATION:
RO#: P&A CODE: DATE: MILEAGE:	RO#: P&A CODE: DATE: MILEAGE:

Service Maintenance Section

Special Operating Conditions Log

<p style="text-align: center;">DEALER VALIDATION:</p> <p>RO#: P&A CODE: DATE: MILEAGE:</p>	<p style="text-align: center;">DEALER VALIDATION:</p> <p>RO#: P&A CODE: DATE: MILEAGE:</p>
<p style="text-align: center;">DEALER VALIDATION:</p> <p>RO#: P&A CODE: DATE: MILEAGE:</p>	<p style="text-align: center;">DEALER VALIDATION:</p> <p>RO#: P&A CODE: DATE: MILEAGE:</p>
<p style="text-align: center;">DEALER VALIDATION:</p> <p>RO#: P&A CODE: DATE: MILEAGE:</p>	<p style="text-align: center;">DEALER VALIDATION:</p> <p>RO#: P&A CODE: DATE: MILEAGE:</p>
<p style="text-align: center;">DEALER VALIDATION:</p> <p>RO#: P&A CODE: DATE: MILEAGE:</p>	<p style="text-align: center;">DEALER VALIDATION:</p> <p>RO#: P&A CODE: DATE: MILEAGE:</p>
<p style="text-align: center;">DEALER VALIDATION:</p> <p>RO#: P&A CODE: DATE: MILEAGE:</p>	<p style="text-align: center;">DEALER VALIDATION:</p> <p>RO#: P&A CODE: DATE: MILEAGE:</p>

Index

A

Accessory delay69
Air cleaner filter297–298
Air conditioning
 automatic temperature
 control system44
Airbag supplemental restraint
system130, 139, 142
 and child safety seats132
 description130, 139, 142
 disposal145
 driver airbag132, 140, 143
 indicator light139, 141, 144
 operation132, 140, 143
 passenger airbag132, 140, 143
 side airbag139
All Wheel Drive (AWD),
driving off road211
Ambulance packages15
AM/FM27
Anti-lock brake system
(see Brakes)199–200
Anti-theft system100
Audio system (see Radio)27
Automatic transaxle
 fluid, adding294
 fluid, checking294
Automatic transmission
 driving an automatic
 overdrive209
 fluid, refill capacities299
 fluid, specification299
Auxiliary input jack (Line in)35
Auxiliary power point66
Axle
 lubricant specifications299

320

refill capacities299

B

Battery274
 acid, treating emergencies274
 jumping a disabled battery241
 maintenance-free274
 servicing274
Belt-Minder®125
Booster seats159
Brakes199
 anti-lock199–200
 anti-lock brake system (ABS)
 warning light200
 fluid, checking and adding294
 fluid, refill capacities299
 fluid, specifications299
 lubricant specifications299
 parking201
 shift interlock208
Bulbs55

C

Capacities for refilling fluids299
Cargo area shade86
CD27
Cell phone warning303
Child safety seats150
 attaching with tether straps ..156
 in front seat151
 in rear seat151
 LATCH154
 recommendations148
Child safety seats - booster
seats159
Cleaning your vehicle
 engine compartment260

Index

- instrument panel262
- interior263
- Mazda car care products264
- plastic parts261
- washing259
- waxing259
- wheels260
- wiper blades262
- Climate control (see Air conditioning or Heating)44
- Clock27
- Compass, electronic64
 - calibration65
 - set zone adjustment65
- Console63
- Controls
 - power seat108
 - steering column74
- Coolant
 - checking and adding277–278
 - refill capacities281, 299
 - specifications299
- Cruise control71
- Cruise control (see Speed control)71
- Customer Assistance248–249, 252
- D**
- Daytime running lamps (see Lamps)51
- Dipstick
 - automatic transmission
 - fluid294
 - engine oil271
- Driving under special conditions210, 212, 215
- sand213
- snow and ice216
- through water214, 217
- E**
- Electronic message center77
- Electronic stability control202
- Emergencies, roadside
 - jump-starting241
 - running out of fuel240, 286
- Emission control system291
- Engine300
 - cleaning260
 - idle speed control274
 - lubrication specifications299
 - refill capacities299
 - service points268–269
- Engine block heater197
- Engine oil271
 - checking and adding271
 - dipstick271
 - filter, specifications273
 - recommendations273
 - refill capacities299
 - specifications299
- Event data recording14
- Exhaust fumes197
- F**
- Fluid capacities299
- Fog lamps50
- Four-Wheel Drive vehicles
 - driving off road211
 - preparing to drive your vehicle207

Index

- Fuel282
 calculating fuel
 economy78, 288
 cap284
 capacity299
 choosing the right fuel285
 comparisons with EPA fuel
 economy estimates291
 detergent in fuel286
 filler funnel286
 filling your vehicle with
 fuel282, 284, 288
 filter, specifications282
 fuel pump/high voltage
 shut-off switches218
 improving fuel economy288
 octane rating286, 300
 quality286
 running out of fuel240, 286
 safety information relating to
 automotive fuels282
Fuses220–221
- G**
- Gas cap (see Fuel cap)284
Gas mileage
(see Fuel economy)288
Gauges25
- H**
- Hazard flashers218
Head restraints111
Headlamps49
 aiming52
 bulb specifications55
 daytime running lights51
 flash to pass51
 high beam51
 replacing bulbs56
 turning on and off49
- Heating
 heating and air conditioning
 system44
Hood267
- I**
- Ignition194, 300
Illuminated visor mirror63
Infant seats
(see Safety seats)150
Inspection/maintenance (I/M)
testing293
Instrument panel
 cleaning262
 cluster20
 lighting up panel and
 interior52
 location of components20
- J**
- Jump-starting your vehicle241
- K**
- Keyless entry system
 autolock92–93
Keys90, 102
 positions of the ignition194
- L**
- Lamps
 bulb replacement
 specifications chart55
 daytime running light51
 fog lamps50
 headlamps49

322

**2009 Tribute Hybrid (thv)
Owners Guide, 1st Printing
USA (fus)**

Index

- headlamps, flash to pass51
- instrument panel, dimming52
- interior lamps54–56
- replacing bulbs56
- LATCH anchors154
- Liftgate85, 97
- Lights, warning and indicator20
 - anti-lock brakes (ABS)200
- Load limits186
- Loading instructions192
- Locks
 - autolock92–93
 - childproof95
 - doors92
- Lubricant specifications299
- Lug nuts240
- Luggage rack87
- M**
- Manual transmission
 - fluid capacities299
 - lubricant specifications299
- Message center77
 - english/metric button81
 - system check button79
 - warning messages82
- Mirrors69–70
 - automatic dimming rearview mirror70
 - fold away71
 - heated71
 - side view mirrors (power)70
- Moon roof75
- Motorcraft parts282
- N**
- Navigation system43
- O**
- Octane rating286
- Oil (see Engine oil)271
- P**
- Parking brake201
- Passenger Occupant Classification Sensor118
- Power distribution box (see Fuses)224
- Power door locks92
- Power mirrors70
- Power point66
- Power Seats108
- Power steering206
- Power Windows68
- Preparing to drive your vehicle207
- R**
- Radio27
- Recommendations for attaching safety restraints for children148
- Relays220
- Remote entry system95–96
 - illuminated entry99
 - locking/unlocking doors96–97
 - opening the trunk97
 - panic alarm97
 - replacement/additional transmitters98
 - replacing the batteries97
- Roof rack87

Index

S

- Safety Canopy140
- Safety defects, reporting258
- Safety restraints116, 120–124
 - Belt-Minder®125
 - extension assembly125
 - for adults121–123
 - for children145
 - Occupant Classification
 - Sensor118
 - warning light and chime125
- Safety restraints - LATCH anchors154
- Safety seats for children150
- Safety Compliance Certification Label301
- Satellite Radio (if equipped)27
- Satellite Radio Information40
- Scheduled Maintenance Guide304
 - General Maintenance Information304
 - Normal Scheduled Maintenance and Log309
 - Special Operating Conditions314
 - What Maintenance Schedule Should You Follow?307
- Seat belts (see Safety restraints)116, 120–124
- Seats105
 - child safety seats150
 - heated110
- SecuriLock passive anti-theft system100
- Servicing your vehicle265
- Setting the clock27
- Side-curtain airbags system (if equipped)142–143
- Snowplowing15
- Spark plugs, specifications300
- Special notice
 - ambulance conversions15
 - utility-type vehicles15
- Specification chart, lubricants299
- Speed control71
- Starting your vehicle194–196
 - jump starting241
- Steering wheel
 - controls74
 - tilting62
- Stereo
 - CD-MP327

T

- Tilt steering wheel62
- Tire Pressure Monitoring System (TPMS)
 - Tires, Wheels and Loading181
- Tires165–166
 - alignment174
 - care170
 - changing231, 234
 - checking the pressure170
 - inflating168
 - label180
 - replacing171
 - rotating174
 - safety practices173
 - sidewall information175
 - snow tires and chains186
 - spare tire229, 231
 - terminology167
 - tire grades166

324

2009 Tribute Hybrid (thv)
Owners Guide, 1st Printing
USA (fus)

Index

- treadwear166, 170
- Towing193
recreational towing193
trailer towing193
wrecker246
- Transmission208
brake-shift interlock (BSI)208
fluid, checking and adding
(automatic)294
fluid, refill capacities299
lubricant specifications299
- Turn signal53
- U**
- USB port37
- V**
- Vehicle Identification Number
(VIN)301
- Vehicle loading186
- Ventilating your vehicle197
- W**
- Warning lights (see Lights)20
- Washer fluid269
- Water, Driving through217
- Windows
power68
rear wiper/washer62
- Windshield washer fluid and
wipers61
checking and adding fluid269
liftgate reservoir269
replacing wiper blades ...270–271
- Wrecker towing246

Free Manuals Download Website

<http://myh66.com>

<http://usermanuals.us>

<http://www.somanuals.com>

<http://www.4manuals.cc>

<http://www.manual-lib.com>

<http://www.404manual.com>

<http://www.luxmanual.com>

<http://aubethermostatmanual.com>

Golf course search by state

<http://golfingnear.com>

Email search by domain

<http://emailbydomain.com>

Auto manuals search

<http://auto.somanuals.com>

TV manuals search

<http://tv.somanuals.com>