

# Supplementary Instructions

Meade 8" Model 2080/LX6 and 10" Model 2120/LX6  
Schmidt-Cassegrain Telescopes  
with Quartz Electronic Drive System

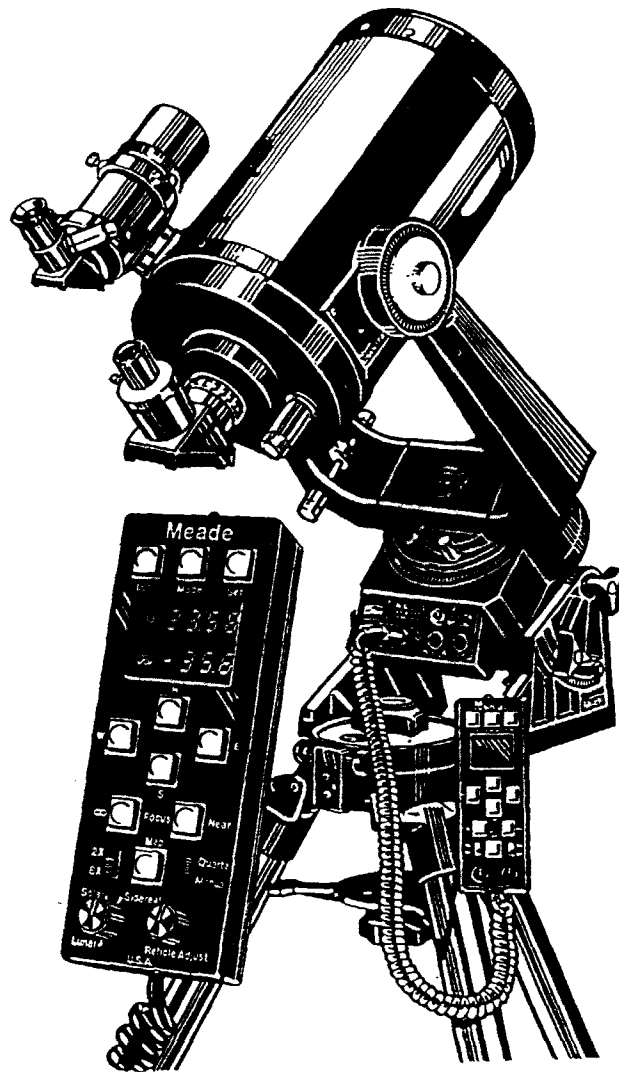

**Meade Instruments Corporation**  
1675 Toronto Way, Costa Mesa, Ca 92626\* (714) 556-2291

Ver. 0689-1

© 1989

**WARNING**

**NEVER ATTEMPT TO OBSERVE THE SUN THROUGH YOUR MEADE TELESCOPE! OBSERVING THE SUN, EVEN FOR THE SHORTEST FRACTION OF A SECOND, WILL CAUSE INSTANT AND IRREVERSIBLE EYE DAMAGE. WHEN OBSERVING DURING THE DAYTIME, DO NOT POINT THE TELESCOPE EVEN CLOSE TO THE SUN.**

**WHEN USING YOUR TELESCOPE, PLEASE KEEP IN MIND THAT IT IS A PRECISION INSTRUMENT. WHILE NOT OVERLY FRAGILE, THE TELESCOPE CAN BE DAMAGED BY IMPROPER USE OR CARELESSNESS, SUCH AS FORCING THE MANUAL LOCKS OR DROPPING THE ELECTRONIC COMMAND CENTER. SUCH ABUSE IS NOT COVERED BY THE WARRANTY.**

**FOR PROPER UTILIZATION OF YOUR MEADE LX6 SCHMIDT-CASSEGRAIN, A THOROUGH READING OF THIS SUPPLEMENTARY MANUAL IS ESSENTIAL. PLEASE READ ALL CONTENTS OF THIS MANUAL BEFORE ATTEMPTING TO OPERATE THE TELESCOPE.**

# Contents

A. Introduction	5
1. Optics	5
2. Electronics	5
3. This Manual	5
4. f/6.3 Optical System	5
B. LX6 Power Panel	6
1. Ammeter	6
2. Power Indicator	7
3. On/Off Switch	7
4. Northern/Southern Switch	7
5. Dec Motor Output	7
6. Electric Focuser Output	7
7. Illuminated Reticle Output	7
8. Electronic Command Center Socket	7
9. Power Input Socket	7
10. C.A.T. Socket	7
11. Encoders Socket	8
C. Electronic Command Center	8
1. Map Light	8
2. DRS Buttons	8
3. DRS Display	8
4. Drive Corrector Control Buttons	8
5. Electric Focuser Buttons	9
6. Map Light Button	9
7. 2X/8X Slide Switch	9
8. Quartz/Manual Slide Switch	9
9. Variable Speed Knob	9
10. Reticle Adjustment Knob	9
D. Operation	9
1. AC Operation	9
2. DC Operation	10
3. Battery Pack	10

<b>E. 9 x 60 Polar Viewfinder</b> . . . . .	<b>10</b>
<b>1. The Illuminated Reticle</b> . . . . .	<b>10</b>
<b>2. Focusing the Viewfinder</b> . . . . .	<b>10</b>
<b>3. Finding the Celestial Pole</b> . . . . .	<b>11</b>
<b>F. Magnetic Compass</b> . . . . .	<b>12</b>
<b>1. Setting the Magnetic Declination</b> . . . . .	<b>12</b>
<b>2. Compass Installation</b> . . . . .	<b>13</b>
<b>3. Finding True North</b> . . . . .	<b>14</b>
<b>G. Azimuth Control</b> . . . . .	<b>17</b>
<b>H. Deluxe Latitude Adjuster</b> . . . . .	<b>17</b>
<b>I. Troubleshooting the LX6 Drive System</b> . . . . .	<b>18</b>
<b>J. Specifications</b> . . . . .	<b>19</b>

## A. Introduction

Congratulations on your purchase of the Meade LX6 model telescope! These telescopes are the latest in a long line of Meade Schmidt-Cassegrain telescope models, and as such they represent the absolute pinnacle in state-of-the-art telescope design for the serious amateur. Important advances in all three major areas of telescope design - optics, mechanics, and electronics - have been incorporated into these telescopes.

### 1. Optics

Perhaps the most significant advancement in commercial telescopes since the introduction of the Schmidt-Cassegrain itself, the Meade f/6.3 optical system results in numerous advantages over the traditional f/10 telescope system. Fields of view are 59% wider, images are 2 1/2 times brighter, and photographic times are 60% faster than those obtained with f/10 telescopes. Because of their computer-optimized ultra high contrast baffling, all of this is possible without any compromise of resolution or performance on high power lunar and planetary work.

### 2. Electronics

The heart of every LX6 system is a dedicated microprocessor that continuously controls, with quartz precision, all important electronic operations of the telescope, from the drive-rate frequency input to the main RA pulse motor, to the Electronic Command Center's multi-functioned digital readouts.

The advanced-design Power Panel allows virtually every modern electronic accessory you might wish to add to your LX6 to be plugged into the telescope - from a simple Dec motor to the Meade "CAT" Computer Aided Telescope system.

### 3. This Manual

This supplementary manual explains in detail the operation and application of those features unique to Meade 8" and 10" LX6 Schmidt-Cassegrain telescopes. Refer to the standard Model 2080/2120 Instruction Manual for complete detailed information regarding set-up and operation of your telescope.

### 4. f/6.3 Optical System

The f/6.3 optical system of the LX6 can be used with all accessories offered for the f/10 systems, and the Model 2080/2120 Instruction Manual covers the operation of the optical tube assembly. The only change involves the Series VI drop-in filters. The f/6.3 tube assembly, in order to provide full 35mm film coverage, does not have the recess for these filters. The eyepiece thread-in filters must be used if filters are required.

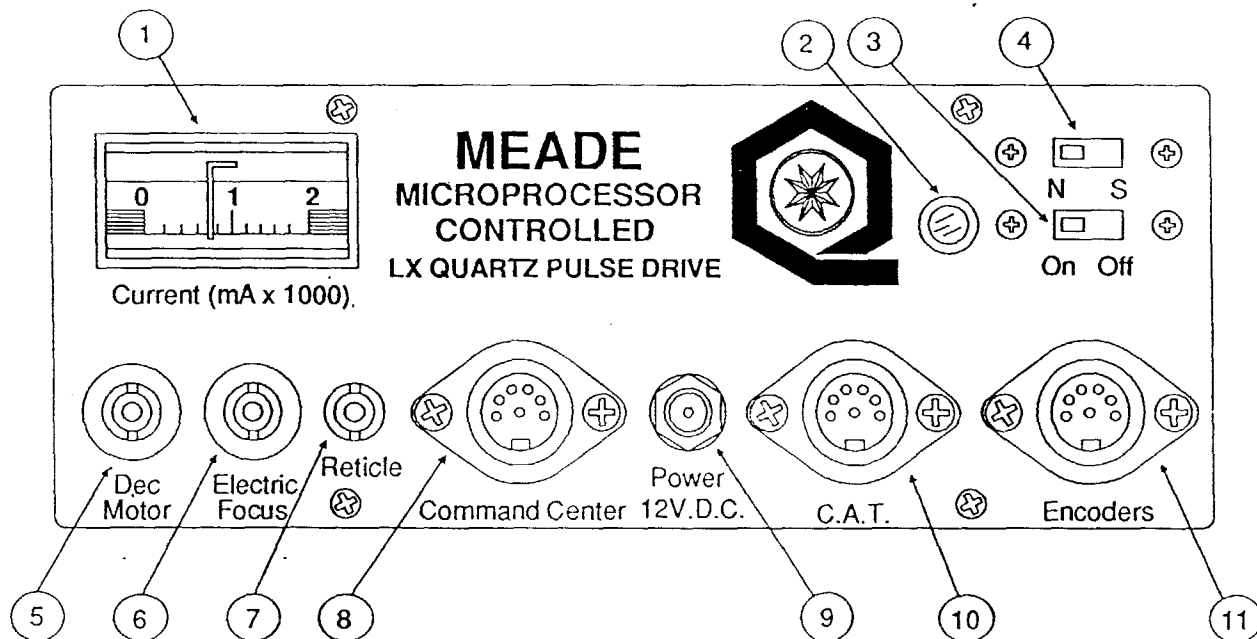

- (1) Ammeter
- (2) Power Indicator
- (3) On/Off Switch
- (4) Northern/Southern Switch
- (5) Dec Motor Output
- (6) Electric Focus Output
- (7) Illuminated Reticule Output
- (8) Electronic Command Center Socket
- (9) Power Input Socket
- (10) C.A.T. Socket
- (11) Encoders Socket

Fig. 1: LX6 Power Panel

## B. LX6 Power Panel

The Meade LX6 Quartz drive system has several built-in features for simplifying the operation of the telescope. Output jacks are provided on the Power Panel for some of the more common accessories, eliminating the need for separate Battery Packs.

### 1. Ammeter

An important feature on the LX6 telescope is the ammeter. This meter shows the power usage of the telescope. When the telescope is powered from an AC source or a car battery, the amount of current being used is not important because the power available is essentially unlimited. But when the telescope is powered from a small power cell (such as a 12 volt, 5 amp hour video camera battery) or from the supplied Battery Pack, the telescope operating time will vary, depending on the power usage.

To estimate the operating time of the telescope, divide the amp hour rating of the power source by the power usage. For example, the ammeter reads from 0 to 2000 mA (0 to 2 amps), so if the needle is positioned over the second mark, the telescope is using 400 mA or .4 amp. When the batteries are fully charged, the Battery Pack amp hour rating is .5 (the Meade 600 Power Cell has a 5 amp hour rating). So, the operating time of the telescope when using the Battery Pack when the ammeter is showing a power usage of 400 mA would be about  $.5/.4 = 1.25$  hours. Note: Actual operating time will depend on many factors such as the condition of the batteries and outside temperature.

## 2. Power Indicator

The red Power Indicator light is illuminated anytime the ON/OFF switch is in the ON position, and indicates that power is being supplied to the telescope.

## 3. On/Off Switch

This switch turns on and off the power to the telescope.

## 4. Northern/Southern Switch

The Northern/Southern (N-S) switch supplied on the Meade LX6 Schmidt-Cassegrains allows operation of the telescope anywhere in the world. Moving the switch to the Southern (S) position reverses the telescope's tracking direction. Note: Once set, unless the telescope is operated in a different hemisphere, this switch need never be used again.

**Note: The N-S switch must be set to the correct position before turning the ON/OFF switch to the ON position. Moving the Northern/Southern switch after the telescope is turned on will result in incorrect tracking.**

## 5. Dec Motor Output

The "Declination Motor" socket is used for the optional #39 Declination motor assembly. The hand-held Electronic Command Center is required for use of the Declination motor and will operate the Declination Motor at the 2X guide correcting speed and the 8X image scanning speed.

## 6. Electric Focuser Output

The optional Meade #1200A Electric Focuser may also be plugged directly into the LX6 power panel by using the Electric Focuser jack. The Electronic Command Center may now be used to control the Electric Focuser to achieve very precise focusing of the telescope.

## 7. Illuminated Reticle Output

The optional Illuminated Reticle can be plugged directly into the LX6 power panel reticle jack, eliminating the need for a separate battery box. The Reticle Adjust Knob (located on the Electronic Command Center) controls the brightness of the reticle.

## 8. Electronic Command Center Socket

The Electronic Command Center Socket results in the "plug-in" capability of the LX6. By simply plugging the Electronic Command Center into the socket, the full range of LX6 features are made available. See below for description of the Electronic Command Center features.

## 9. Power Input Socket

Each LX6 includes power cords for three different methods of powering the telescope: Directly from auto cigarette lighter plugs; directly from 115 v.AC home outlets; and from a Battery Pack (using 10 user supplied AA-sized batteries). Each of these power cords plugs into the Power Input socket to supply power to the telescope.

## 10. CAT Socket

When the optional Model 9008 CAT Computer Aided Telescope system is plugged into this socket, the CAT receives all encoder information and power directly from the Power Panel, eliminating unnecessary wires.

## 11. Encoders Socket

When encoders are added to the telescope, either for the CAT or Digital Readout System (DRS), they are plugged into this socket.

## C. Electronic Command Center (ECC)

The hand-held Electronic Command Center plugs directly into the LX6 power panel "Command Center" socket (#8, Fig. 1) and is the heart of the LX6 concept. Virtually all telescope functions are put at your fingertips, making separate Battery Packs and handboxes obsolete. At the same time, if a simple, quick observing session is planned which will not require the sophisticated features of the LX6, the telescope may be operated without the Electronic Command Center, reducing power consumption. This may be useful if you wish to power the telescope from the Battery Pack.

### 1. Map Light

The Electronic Command Center (ECC) includes a red L.E.D. located at the top of the handbox. Depressing the "Map" button (#6, Fig. 2) illuminates this light for reading star maps or charts during an observing session.

### 2. DRS Buttons

These buttons control the Digital Readout System functions. See section I for detailed information on the use of the DRS. Note: If the DRS is not installed, these buttons are non-functional.

### 3. DRS Display

This area contains the bar L.E.D.'s (Light Emitting Diodes) and numeric L.E.D.'s which make up the DRS. See section I for detailed information. Note: If the DRS is not installed, this display is blank.

### 4. Drive Corrector Control Buttons

These buttons are used to electronically move the telescope. The "E" and "W" buttons move the telescope in Right Ascension using the main drive motor. The "N" and "S" buttons move the telescope in Declination using the optional #39 Dec Motor. If this motor is not attached, these two buttons are non-functional.

The speed at which the telescope moves when using these buttons is determined by the position of the 2X/8X slide switch (see #7, below).

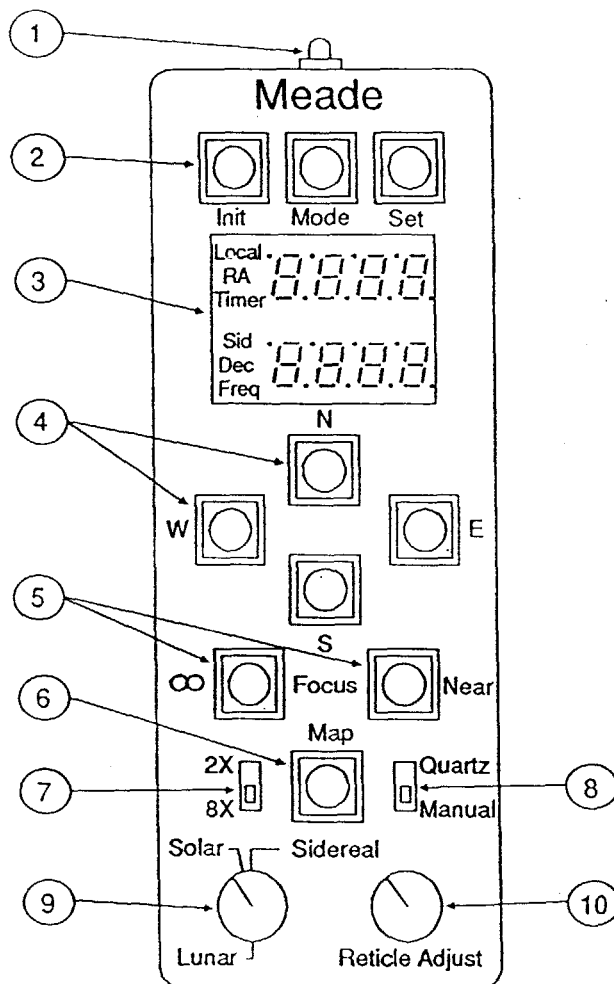

- |                             |                                |
|-----------------------------|--------------------------------|
| (1) Map Light               | (7) 2X/8X Slide Switch         |
| (2) DRS Buttons             | (8) Quartz/Manual Slide Switch |
| (3) DRS Display             | (9) Variable Speed Knob        |
| (4) Drive Corrector Buttons | (10) Reticle Adjust Knob       |
| (5) Focus Buttons           |                                |
| (6) Map Light Button        |                                |

Fig. 2: Electronic Command Center (ECC)



## 5. Electric Focuser Buttons

Add the optional Meade #1200A Electric Focuser, and ultraprecise microfocusing is at your fingertips. Simply depress the ECC's focus pushbuttons (#5, Fig. 2) to obtain the sharpest lunar and planetary focus possible. Coarse focusing is accomplished with the telescope's manual focus knob.

## 6. Map Light Button

When pushed, this button illuminates the L.E.D. located at the top of the ECC. (See #1 Map Light on page 8.)

## 7. 2X/8X Slide Switch

As described previously, when any one of the four Drive Corrector buttons is pressed, the telescope moves in the labeled direction. The speed at which the telescope moves is determined by the 2X/8X slide switch.

When in the 2X position, the telescope moves twice the tracking rate in the Right Ascension direction; perfect for critical corrections during long exposure photography or image centering at very high observing powers. Moving to the 8X position results in telescope movement at eight times the tracking speed in the Right Ascension direction. Add the optional #39 Declination Motor, which plugs into the LX6 power panel, and you can scan at either speed in any direction, making the manual controls almost superfluous.

## 8. Quartz/Manual Slide Switch

When the slide switch is on the "Quartz" position, the Quartz crystal in the LX6 Drive is controlling the telescope's tracking speed. The "E" and "W" buttons override the Quartz crystal to speed up or slow down the tracking speed as long as the button is pressed. When the button is released, the Quartz crystal resumes control. Note: In the "Quartz" mode, the variable speed knob (#9, Fig. 2) is non-functional. This mode of operation is best suited for observing or photographing deep-space objects, which move at the sidereal rate.

Moving the slide switch to the "Manual" position transfers the tracking speed control from the Quartz crystal to the variable speed knob (#9, below).

## 9. Variable Speed Knob

This knob varies the drive frequency from approximately 57 Hz to 61 Hz, which covers the Lunar, Solar, and Planetary rates. The Lunar and Solar rate positions are marked for reference. As in the "Quartz" mode, the "E" and "W" buttons override the variable knob to speed up and slow down the drive rate.

## 10. Reticle Adjustment Knob

This knob controls the brightness of the optional MA 12mm Illuminated Reticle eyepiece, which plugs into the main Power Panel.

## D. Operation

The 8" and 10" LX6 Schmidt-Cassegrain telescopes incorporate the superb Meade LX Drive System and the latest in state-of-the-art electronics to achieve a first in commercially produced telescopes: quartz accuracy coupled with true sidereal rate tracking. The quartz crystal used in the Meade LX6 Quartz Drive provides accurate tracking to within plus or minus .005% of the sidereal frequency, independent of temperature changes or local power line variations.

### 1. AC Operation

Meade LX6 telescopes are supplied with an AC Adapter, which converts 115 v.AC from a wall outlet into the 12 v.DC required by the telescope. The AC Adapter should only be plugged into an indoor home AC outlet.

The AC Adapter has a 25 foot cord, which should reach most observing locations from an indoor plug. If the cord is too short to reach the telescope's location, optional extension cords are available from your Meade dealer in 25 foot lengths. Do not plug the AC Adapter into the end of a standard extension cord to extend the observing range of the telescope.

To use the AC Adapter, plug it into a standard indoor AC outlet. Plug the end of the cord into the power input socket (#9, Fig. 1). Check that the Northern/Southern (N-S) switch (#4, Fig. 1) is set for the hemisphere of the observing location and then turn the "On/Off" switch (#3, Fig. 1) to "On". (Remember: The N-S switch must be correctly set before the telescope is turned on.) The power indicator light (#2, Fig. 1) should now be lit and the telescope tracking. If the Power Light is not working, see "Troubleshooting the LX6 Drive System", page 18.

## 2. DC Operation

The 8" and 10" LX6 telescopes operate on DC current and may be powered directly from a 12 volt battery or power cell. The LX6 drive system normally draws about .5 amp in standard operation with the Electronic Command Center (ECC) in use. Maximum current usage is .8 amp when all optional accessories are being used. If the telescope is being powered from a fully charged car battery in good condition, the current drain is negligible and the telescope may be used all night without fear of a "dead battery".

The LX6 Schmidt-Cassegrains are supplied with a DC power cable for use with a car battery. To use the DC power cable, connect the cable to the power socket (#9, Fig.1) on the power panel of the LX6, and the cigarette plug to your cigarette lighter. Be sure that the N-S switch is correctly set and that the On/Off switch is "On". If the power indicator is not lit, see "Troubleshooting the LX6 Drive System", page 18.

## 3. Battery Pack

Also supplied with the telescope is a small Battery Pack with cord. This Battery Pack holds 10 size AA batteries and is intended for short observing sessions. Rechargeable batteries are recommended. Note: When the telescope is being powered by the Battery Pack without the ECC, the power usage is about .35 amp or 30% less than normally required by the telescope when used with the ECC (.5 amp).

## E. 9 X 60 Polar Viewfinder

In addition to being an excellent 9 X 60 viewfinder, the Meade Illuminated Reticle Polar Viewfinder is designed to be used as an optical guide for finding the celestial pole.

### 1. The Illuminated Reticle

To assure safe arrival, the Polar Viewfinder is shipped with the bulb/battery holder not mounted on the viewfinder. To attach, thread the bulb/battery holder into the hole located just under the eyepiece of the viewfinder.

To turn on the reticle, rotate the knurled switch on the bulb/battery holder to the "on" position. The brightness is adjustable by rotating the knurled switch. To prolong battery life, remember to turn off the reticle when not in use.

To replace the batteries in the Polar Viewfinder, remove the bulb/battery holder from the Polar Viewfinder. Separate the two halves of the bulb/battery holder by unthreading the two pieces, exposing the batteries. After replacing the batteries, thread the two halves of the bulb/battery holder together, and replace the unit onto the Polar Viewfinder.

### 2. Focusing the Viewfinder

The Meade Polar Viewfinder has been pre-focused at the factory. However, not everyone has perfect vision and slight adjustment is sometimes necessary to obtain maximum performance.

1. Rotate the eyepiece until the reticle is in sharp focus.
2. Loosen the black knurled locking ring (just behind the dew shield).
3. While looking at a star, rotate the dew shield until the star is in focus. (This refocuses the objective lens.) CAUTION! Take care when rotating counter clockwise. You are unthreading the dew shield and it may fall off if rotated too far! Refocusing the objective lens will only require a few turns of the dew shield at most.
4. When the dew shield is rotated to the sharpest focus for your eye, tighten the black knurled locking ring against the dew shield to fix the position.

### 3. Finding the Celestial Pole

To accurately position the telescope on the celestial pole, follow this procedure:

1. Align the Polar Viewfinder with the main optical tube (as described in the Model 2080/2120 Instruction Manual) by adjusting the black thumbscrews on the bracket until an object in the main telescope is centered on the cross hairs of the Polar Viewfinder.
2. Rotate the optical tube in declination until the declination circle reads 90 degrees. (In this position, the optical tube will be pointing toward Polaris.)
3. Rotate the telescope in R.A. until one of the cross hairs is vertical to the horizon (this is not necessarily vertical to your eye), and the viewfinder's eyepiece is also vertical to the horizon. By making sure the viewfinder's eyepiece is also vertical, you are automatically picking the correct cross hair to make vertical to the horizon.
4. Hold the Polaris Reference Circle next to the telescope with the arrow pointing up.
5. Rotate the inner (local time) circle until your current local time corresponds to the current date on the outer (date) circle.
6. The position of Polaris will be indicated by the slant of the inner (local time) circle that extends out to the outer (date) circle.
7. The date circle represents the reticle in the Polar Viewfinder. Move the telescope in azimuth (rotate the wedge) and latitude (move the tilt plate of the wedge) until Polaris is in the same position on the reticle as shown on the Polar Reference Circle.

You now have an accurate polar alignment.

## F. Magnetic Compass

The magnetic compass helps the observer to set-up the telescope without actually seeing the pole star Polaris. This allows setting up before dark or in locations where the view of Polaris is obstructed. The magnetic compass has an adjustment to compensate for the local angle of Magnetic Declination. Note: Magnetic Declination is the difference between Magnetic North (which the compass shows) and true north (where the telescope should be pointed). Magnetic Declination should not be confused with the astronomical term "Declination," which, when used with "Right Ascension", describes the celestial coordinate system.

### 1. Setting Magnetic Declination

In order to obtain an accurate reading using the compass, you must first adjust for the Magnetic Declination for your location.

1. First, determine the Magnetic Declination in your area using the Isogonic Chart (Fig. 3)

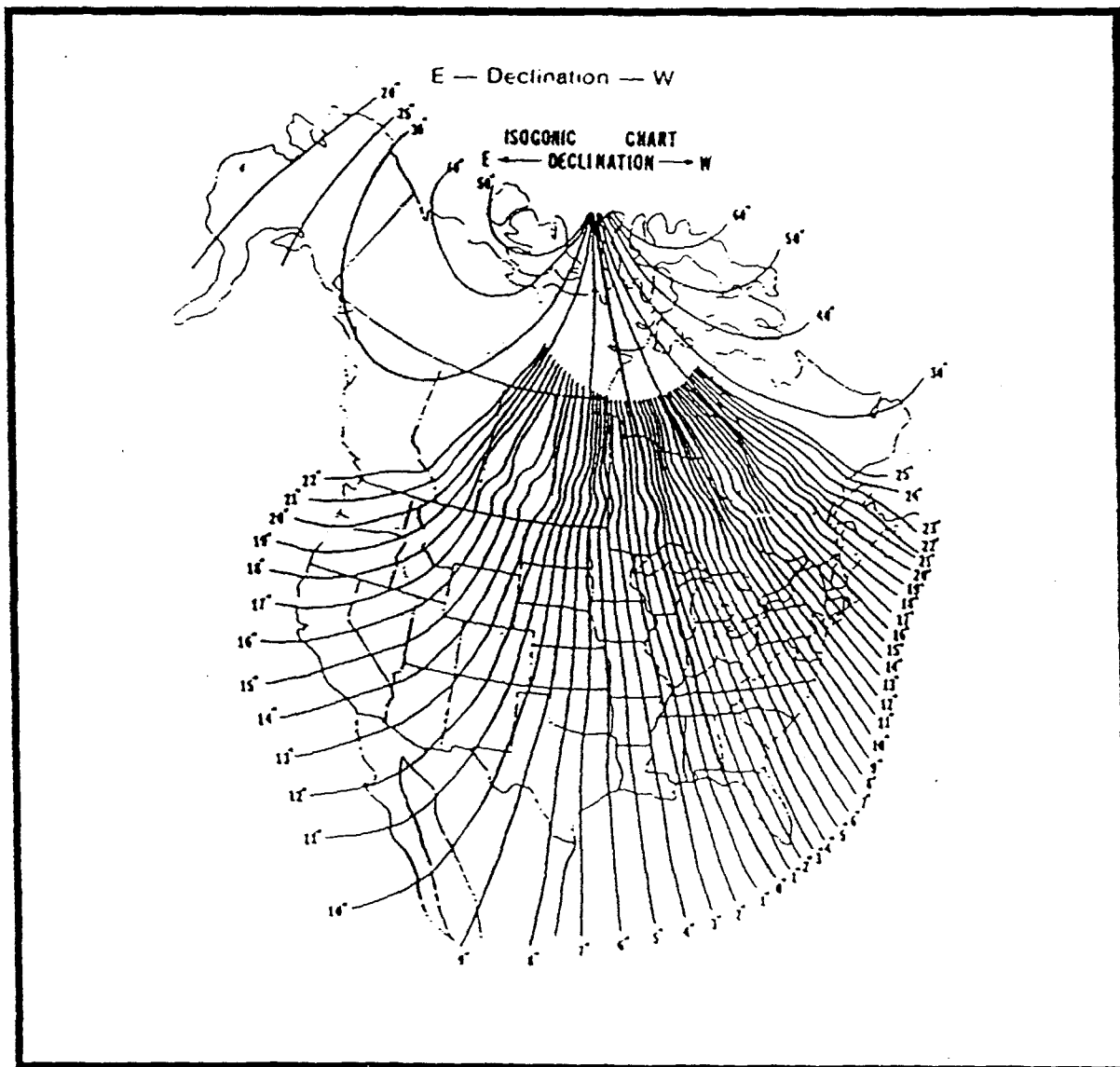

Fig. 3: Magnetic Declination Map

2. Squeeze the clear central vial with thumb and index finger of the left hand.
3. With the right hand, rotate the outer dial until the orienting arrow (the black arrow painted on the inside clear surface) is lined up with the desired Magnetic Declination angle on the declination scale. Notice that East Magnetic Declination is to the right of the "North" position and West Magnetic Declination is left of the "North" position. As an example, Fig. 4 shows the correct setting for 10 degrees west declination, which covers Buffalo, NY, or Philadelphia, PA.

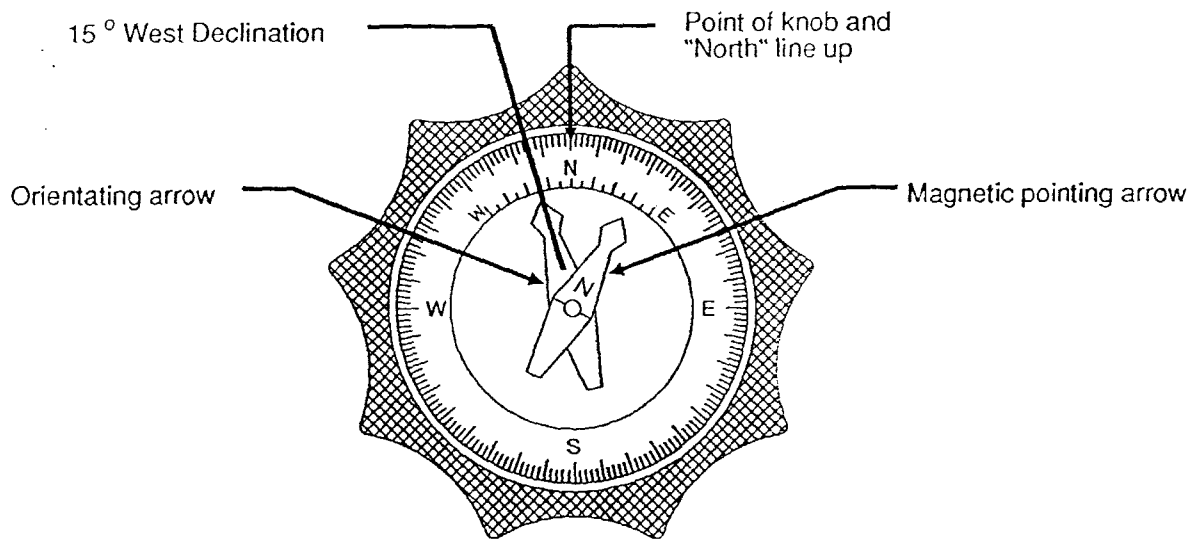

Fig. 4: Magnetic Compass

## 2. Compass Installation

The Magnetic Compass is now set for the correct declination angle. To attach to the Equatorial Wedge, follow these steps:

1. Snap the Magnetic Compass into the 3" diameter wedge attachment knob (after setting the Magnetic Declination as described above). Position the compass into the knob so that the 360 degree location on the direction scale (the "North" position) lines up with one of the nine points of the knobs. (See Fig. 4.) Press the compass firmly into the knob.

2. Assemble the Equatorial Wedge onto the Field Tripod as described in the Instruction Manual using the knob/compass combination to attach the wedge to the tripod.

### 3. Finding True North

The Magnetic Compass is now ready to use. Just follow these simple steps for a quick and easy azimuth alignment:

1. Loosen the knob/compass slightly. This allows for rotation of the Equatorial Wedge under the knob/compass (Fig. 5). The magnetic pointing arrow will point to magnetic north.

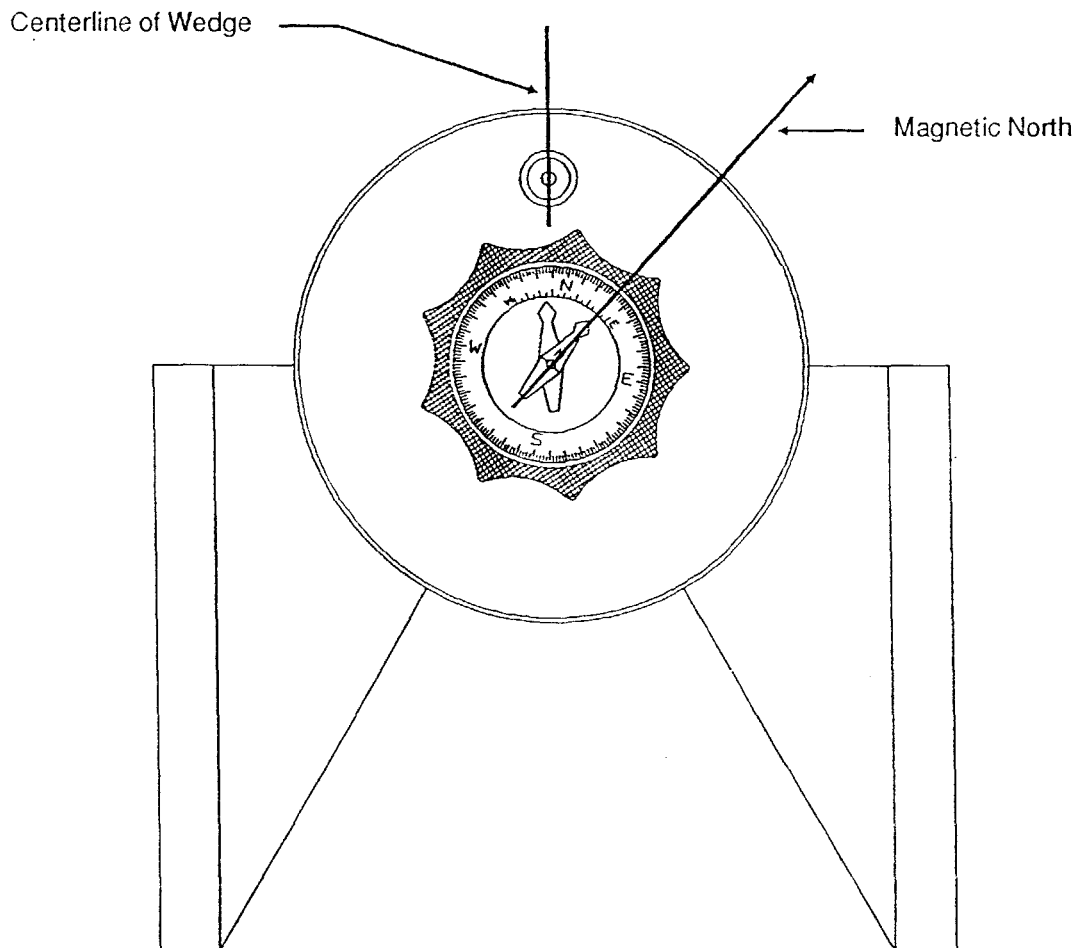

Fig. 5: Equatorial Wedge

2. Rotate the knob/compass so that the magnetic pointing arrow lies directly over the painted black alignment arrow (Fig. 6). The "North" position on the direction scale (and the point on the knob/compass) now point directly north.

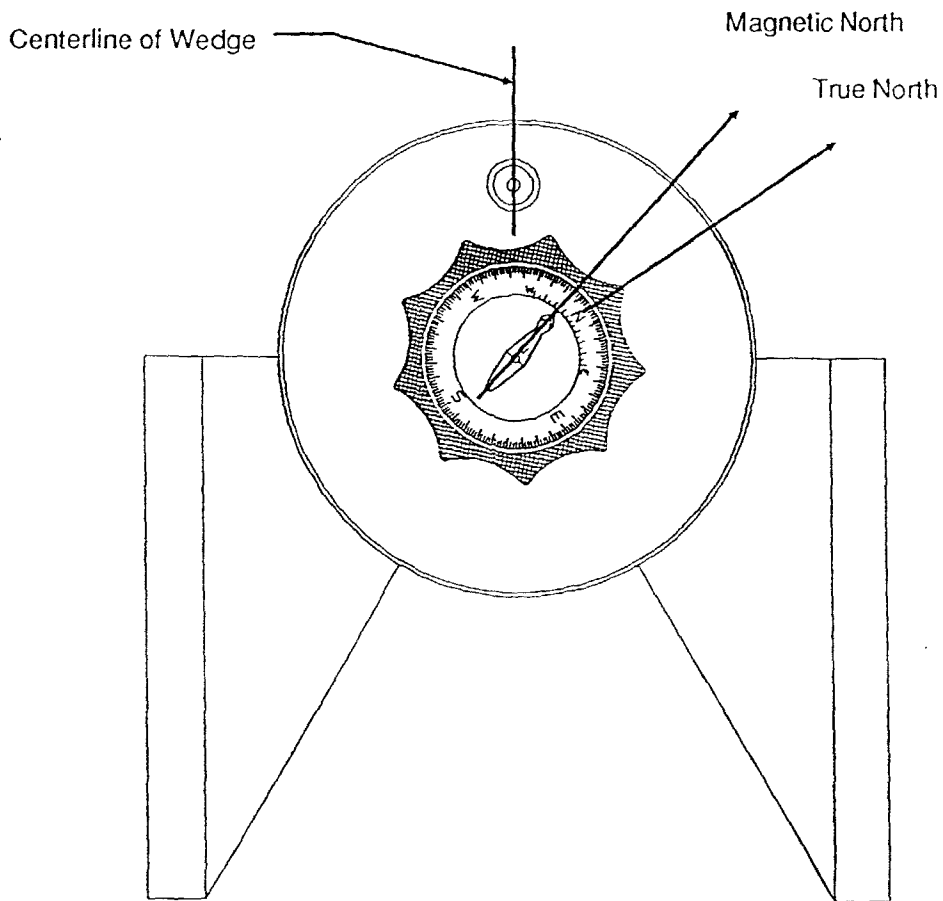

Fig. 6: Equatorial Wedge

3. By rotating the Equatorial Wedge in azimuth, position the point of the knob/compass so that it points directly to the center of the bubble level (Fig. 7). The centerline of the Equatorial Wedge now falls directly on the true north line.

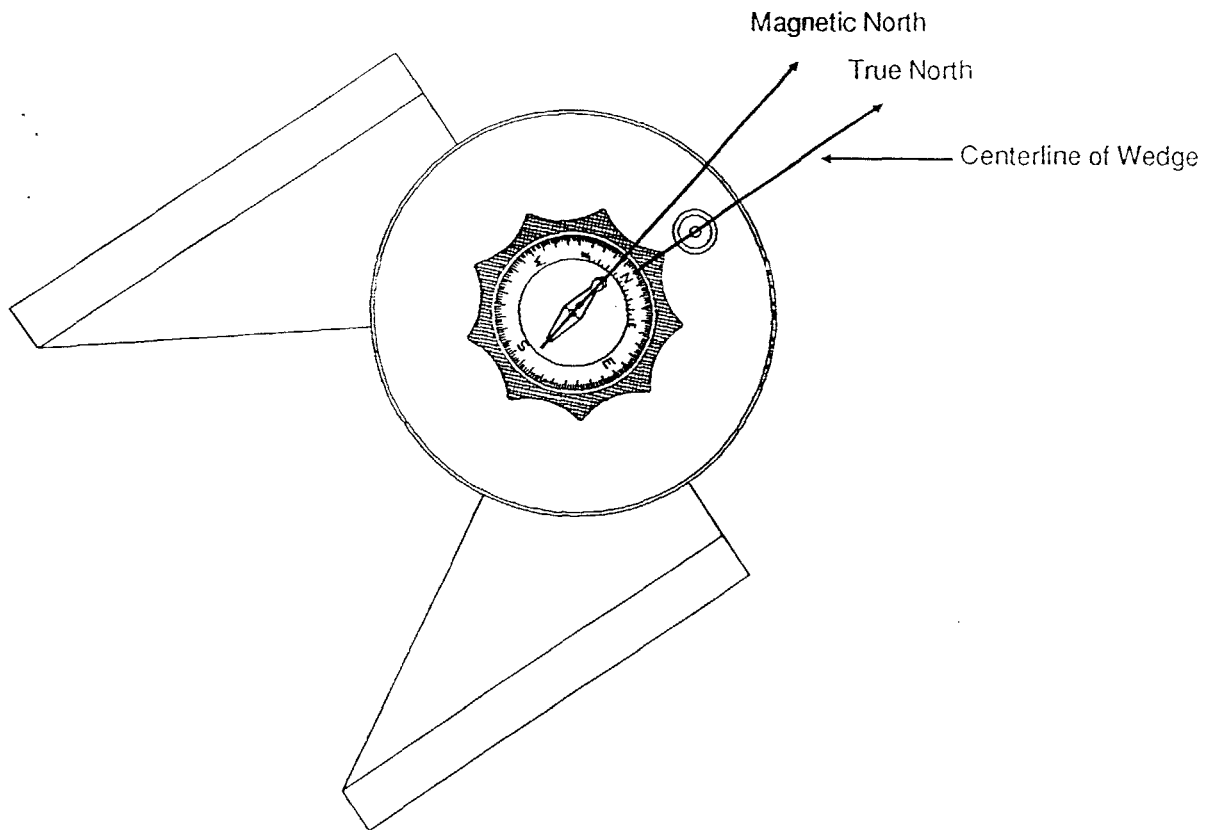

Fig. 7: Equatorial Wedge

4. Tighten the knob/compass, locking the Equatorial Wedge into place.

The Field Tripod and Equatorial Wedge are now pointed directly toward celestial north, without ever having seen the North Star.



## G. Azimuth Control

The Azimuth Control for the Meade Equatorial Wedge and Field Tripod is shipped in a plastic bag and includes the following parts:

- o Azimuth Base (large U shaped piece of aluminum)
- o Azimuth Arm (small T shaped piece of aluminum)
- o 2 - Azimuth Knobs
- o 2 - 8-32 x 1/2" flat-head machine screws
- o 2 - 8-32 x 1" round-head machine screws

To attach the Azimuth Control to your wedge and tripod, follow these steps:

1. Remove the 4 set screws from the wedge and field tripod (which plug the attachment holes) using a screwdriver.
2. Attach the Azimuth Arm to the Equatorial Wedge using the 2 8-32 x 1/2" flat-head machine screws.
3. Attach the Azimuth Base to the Field Tripod using the 2 8-32 x 1" round-head machine screws.
4. Thread the two Azimuth Adjustment Knobs into the Azimuth Base, until they just touch the Azimuth Arm.

The Azimuth control is now ready to use. To adjust in azimuth, loosen the central wedge knob (or the three attachment bolts in the case of the Meade Model 2120). After positioning the wedge, tighten the central wedge knob or bolts.

## H. Deluxe Latitude Adjuster

The Deluxe Latitude Adjuster (DLA) attaches directly to the Equatorial Wedge and permits very precise adjustments in latitude angle by the simple turning of one knob.

The Equatorial Wedge for Meade 8" and 10" Schmidt-Cassegrain telescopes is shipped with the main crossbar of the DLA already installed. Loosen the two socket-head screws that lock the main crossbar in place, to allow the crossbar to rotate slightly if needed. Thread the long adjustment knob into the main crossbar and position the end of the adjustment knob into the cavity at the lower end of the Equatorial Wedge Tilt-Plate. Tighten the two socket-head screws locking the main crossbar into place.

The DLA is now ready to use. To make fine latitude adjustments, follow this procedure:

1. Slightly loosen the knobs (see item (4), Fig. 8, on page 18 of the Model 2080/2120 Instruction Manual) on each side of the wedge.
2. Turn the DLA's adjustment knob (pressing against the bottom of the tilt-plate), so that the tilt-plate moves in latitude angle.
3. Re-tighten the two knobs (4), which were loosened in step 1, above.

NOTE: When installing the tilt-plate to the wedge, note that it is a tight fit and the sides must generally spread slightly to accept the tilt-plate. If the main crossbar of the DLA is already tightened into place this will inhibit your installation of the tilt-plate. You will therefore see that by releasing the screws on the ends of the DLA crossbar your installation of the wedge tilt-plate will be facilitated.

## I. Troubleshooting the LX6 Drive System

The following list of problems should cover most common problems.

**Symptom:** Power Indicator (#2, Fig. 1) does not illuminate and/or the Ammeter (#1, Fig.1) does not show any current.

**Problem:** Telescope not receiving power.

**Solution:** The telescope is not receiving the correct power. If using the AC Adapter, be sure it is plugged into an active wall receptacle (make sure the wall receptacle is not a switched plug; if it is, make sure the switch is on). If using the DC power cord or battery pack, check the connections, both at the power cell and at the telescope.

If the connections look OK, try an alternate power source. This will eliminate the power cord as the source of the problem.

**Symptom:** When using the ECC, pushing the 8X E or 8X W buttons, the telescope either does not move at all, moves only one direction, or sporadically in one or both directions.

**Problem:** Telescope not moving at 8X centering speed in Right Ascension.

**Solution:** This is almost always due to low battery voltage. When the motor is pushed to 8X speeds, that is when it has the least amount of torque and requires the most current to move the telescope. The 8X centering speeds will be the first indication of low battery voltage, and should be taken as a warning, especially if the telescope is being operated from your car battery.

Check the telescope operation using the AC Adapter. If the telescope then operates correctly, then check your battery.

**Symptom:** When the telescope is first turned on, the telescope tracks at the 8X rate for several seconds.

**Problem:** The telescope is doing a self diagnostics test.

**Solution:** This is a normal function of the telescope and does not require any action. During the first 8 seconds of operation, the telescope's microprocessor does a series of tests to determine proper telescope functions.

## J. Specifications

	2080 LX6	2120 LX6
Optical Design	Schmidt-Cassegrain Catadioptric	Schmidt-Cassegrain Catadioptric
Clear Aperture	203mm (8")	254mm (10")
Primary Mirror Diameter	209.6mm (8.25")	263.5mm (10.375")
Focal Length	1280mm (50.4")	1600mm (63")
Focal Ratio (photographic speed)	f/6.3	f/6.3
Resolution	0.56 arc secs.	0.45 arc secs.
Limiting Visual Magnitude (approx.)	13.9	14.5
Limiting Photographic Magnitude (approx.)	16.5	17.0
Image scale	1.14°/inch	0.91°/inch
Maximum Practical Visual Power	500x	625x
35mm. Angular Film Coverage	1.55° x 1.08°	1.24° x 0.86°
Optical Tube Size	9.1" Dia. x 16" Long	11.75" Dia. x 22" Long
Secondary Mirror Obstruction	18.6%	16%
Telescope Mounting	Fork-Type, Double Tine	Fork-Type, Double Tine
Setting Circle Diameters	Dec.: 4"; R.A.: 8"	Dec.: 4"; R.A.: 8"
Motor Drive Gear Diameter	5-3/4" Worm Gear	5-3/4" Worm Gear
Manual Slow-Motion Controls	Dec. and R.A.	Dec. and R.A.
Viewfinder	9 x 60mm	9 x 60mm
Eyepiece	SP 26mm (49X)	SP 26mm (62X)
Telescope Size, Swung Down	9-1/4" x 14" x 24-1/2"	12" x 16" x 28"
Carrying Case Dimensions	30" x 16" x 12"	35" x 20" x 16"
Net Telescope Weight (approx.)	25 lbs.	46 lbs.
Shipping Weight (approx.)	48 lbs.	77 lbs.

The following table lists the powers obtained and actual field of view for optional eyepieces.

Eyepiece/Apparent Field	2080 LX6	2120 LX6
	Power/Actual Field	Power/Actual Field
Series 2 Orthoscopic Eyepieces (4-elements; 1-1/4" O.D.)		
4mm/45°	320/0.14°	400/0.11°
6mm/45°	213/0.21°	267/0.17°
9mm/45°	142/0.32°	178/0.25°
12.5mm/45°	102/0.44°	128/0.35°
18mm/45°	71/0.63°	89/0.51°
25mm/45°	51/0.88°	64/0.70°
Super Plossl Eyepieces (5-elements; 1-1/4" O.D., except as noted)		
6.4mm/52°	200/0.26°	250/0.21°
9.7mm/52°	132/0.39°	165/0.32°
12.4mm/52°	103/0.50°	129/0.40°
15mm/52°	85/0.61°	107/0.49°
20mm/52°	64/0.81°	80/0.65°
26mm/52°	49/1.06°	62/0.84°
32mm/52°	40/1.30°	50/1.04°
40mm/44°	32/1.69°	40/1.35°
56mm/52° (2" O.D.)	23/2.27°	29/1.82°

Eyepiece/Apparent Field	2080 LX6 Power/Actual Field	2120 LX6 Power/Actual Field
<b>Super Wide Angle Eyepieces (6-elements; 1-1/4" O.D., except as noted)</b>		
13.8mm/67°	93/0.72°	116/0.58°
18mm/67°	71/0.94°	89/0.75°
24.5mm/67°	52/1.28°	65/1.03°
32mm/67° (2" O.D.)	40/1.67°	50/1.34°
40mm/67° (2" O.D.)	32/2.09°	40/1.67°
<b>Ultra Wide Angle Eyepieces (8-elements; 1-1/4" O.D., except as noted)</b>		
4.7mm/84°	272/0.31°	340/0.25°
6.7mm/84°	191/0.44°	239/0.35°
8.8mm/84° (1-1/4" - 2" O.D.)	145/0.58°	182/0.46°
14mm/84° (1-1/4" - 2" O.D.)	91/0.92°	114/0.73°

## Free Manuals Download Website

<http://myh66.com>

<http://usermanuals.us>

<http://www.somanuals.com>

<http://www.4manuals.cc>

<http://www.manual-lib.com>

<http://www.404manual.com>

<http://www.luxmanual.com>

<http://aubethermostatmanual.com>

Golf course search by state

<http://golfingnear.com>

Email search by domain

<http://emailbydomain.com>

Auto manuals search

<http://auto.somanuals.com>

TV manuals search

<http://tv.somanuals.com>