

- Never use scouring agents.
- Never immerse the appliance itself in water. To clean, simply wipe off with a soft, damp cloth.
- Never use a cloth to clean inside of the water chamber, as this might leave fuzzy deposits in the chamber. Just rinse with cold water periodically.

DECALCIFYING OF THE COFFEEMAKER

The coffeemaker must be decalcified regularly. The frequency depends on the hardness of your water and how often you use the coffeemaker.

Recognizable indications that descaling is necessary are:

- increased noise during boiling
- longer preparation time.

If usage is frequent, descaling should be carried out as follows:

- with soft water once a year
- with medium hard water every quarter year
- with hard water once a month.

In doubt regarding the water hardness in your area, you may call your local water department.

For ecological and health reasons, we recommend the exclusive use of biological materials such as citric acid, which can be obtained from drugstores.

Dissolve 2 tablespoonfuls of citric acid in 1/2 quart water and pour into the water container. Run this through 2 or 3 time as if making coffee, but using no ground coffee. The hot descaling solution must be allowed to cool down before being poured into the water container. Finally do the same twice using clear water.

mellerware

29001

Instruction Manual



COMBINATION COFFEE MAKER

Before operating this product, please read these instructions carefully.

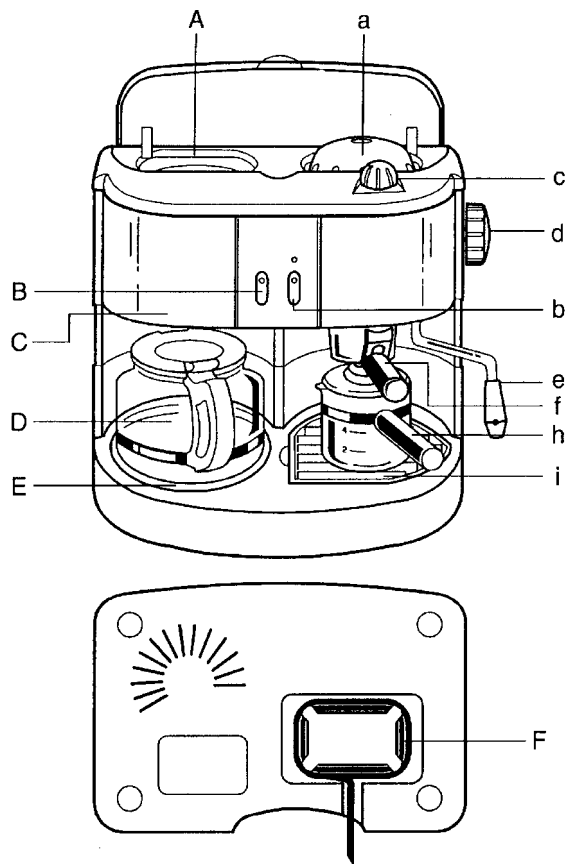

Coffee

- A - Hinged Water Chamber Lid
- B - Drip Coffee On/Off Button
- C - Swing-Out Filter Holder
- D - Glass Carafe
- E - Thermostatically Controlled Warming Plate
- F - A/C Cord and Cord Storage

Espresso/Cappuccino

- a - Boiler Cap
- b - Espresso/Cappuccino On/Off Button
- c - Espresso Strength Control
- d - Steam Control Knob
- e - Steam Nozzle
- f - Filter Holder
- g - Metal Filter
- h - Glass Carafe with Handle and Lid
- i - Removable Overflow Grid
- j - Cup Adaptor

- Use your hands to conform the filter to the contours of the filter holder. This will enable you to achieve better results.
- 2. Put ground coffee into the filter holder (see figure 3). We suggest using one level measuring spoon of ground coffee for each cup of robust brewed coffee. After using your coffee maker several times, you can adjust the quantity to suit your own taste.
- We do not recommend using coffee that is ground to a powder-like consistency, as this will prevent water from passing through the coffee.
- 3. Close the filter holder and make sure that it is completely close (see figure 4).

ATTENTION

- Make sure that the filter paper does not fold over when closing the filter holder. Otherwise the water might run between the filter paper and the filter holder producing a weak cup of coffee.

Filling The Water Chamber

1. Open the hinged water chamber lid (see figure 5). Pour in the desired quantity of water (see figure 6).
- The amount of freshly brewed coffee delivered after the brewing process will always be slightly less than the amount put into the water chamber. This is due to the minimal absorption of the water by the ground coffee. Therefore, put in a little more water to begin with so that you will have the number of cups that you desire.
2. Place the glass carafe with lid in position on the warming plate.
3. Turn on your **Coffee Bar** using the on/off button. The indicator light will illuminate indicating that the brewing process has begun (see figure 7).

Stop & Serve Feature

This device automatically stops the flow of brewed coffee through the filter cone if the glass carafe is removed from the warming plate during the brewing cycle. You have about 20 seconds between the removal of the carafe and it being reinserted back onto the warming plate.

The Stop & Serve device closes off the filter cone so effectively that there is virtually no coffee-drip onto the warming plate. Once the carafe is replaced, the brewing process and the flow of coffee into the carafe can be resumed.

CAUTION

If the coffee DOES drip onto the warming plate after the removal of the carafe, it is usually an indication that the seal in the filter holder is missing or defective.

It is also possible that too much ground coffee has been placed in the filter paper. This causes the water that jets into the filter cone to overflow between the filter and the sides of the filter cone.

If this blockage and subsequent dripping does occur, put the glass carafe immediately back onto the warming plate, and allow the full brewing cycle to run its course. Do not swing out the swivel filter until the brewing process is completed.

CLEANING

- Always unplug this appliance before cleaning. Clean the filter basket, carafe and lid in a solution of warm water and mild liquid soap. These parts can also be placed in the upper level of your dishwasher away from the heating element for safe effective cleaning.

PROBLEMS AND CAUSES IN MAKING ESPRESSO OR CAPPUCCINO

(Always check if the appliance is plugged in and is in the proper on position.)

Problem	Causes
1. Espresso leaking from filter holder	Filter holder not properly inserted Filter holder not pushed in far enough Internal gasket is dirty and needs to be cleaned Gasket without elasticity, replace it with a new one Coffee powder not cleaned off the edge of the filter holder
2. Espresso does not come out	No water in boiler container No coffee in filter holder Filter clogged because coffee is ground too fine and or pressed down too hard
3. Steam does not come out of steam nozzle	No water or not enough water in the boiler chamber Steam nozzle is clogged (see CLEANING section)
4. Not enough froth when frothing the milk	Steam nozzle is clogged (see CLEANING) Insufficient water left in the boiler to steam 45-60 seconds Milk not cold enough Did not use a stainless steel frothing pitcher Stale milk

PREPARING COFFEE

Before making your first pot of delicious coffee, we recommend rinsing the coffee maker once or twice with water only, without ground coffee in the filter basket. This will remove any possible dust which may have settled during shipping.

Be sure that the water chamber is empty. Remove any literature, etc. if found in the water chamber.

- Make sure that the swivel filter is closed properly during the brewing process. When closing the swivel filter you will feel a noticeable resistance when the handle of the swivel filter is approximately 1/2 inch away from the nonremovable side piece. Push in firmly until the handle touches the side of the coffee maker.
- Caution: If the filter holder is not pushed in properly the Stop & Serve trigger cannot function. This may cause hot water or hot coffee to overflow.
- The Stop & Serve mechanism is opened as long as the glass carafe is inserted into the machine and sits properly on the warming plate and the swivel filter is closed properly. When brewing coffee make sure the glass carafe is in place (see Stop & Serve Feature section.)

Putting in The Ground Coffee

1. Swing out the filter holder (C) (see figure 1) and insert a paper filter. When inserting a paper filter make sure the seam is pointing towards the handle of the filter holder (see figure 2).

Espresso/Cappuccino

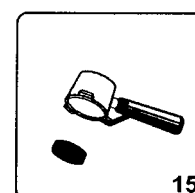
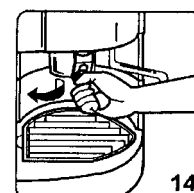
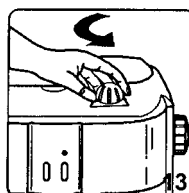
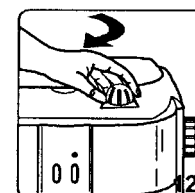
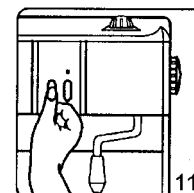
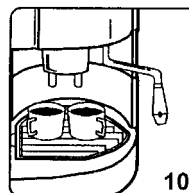
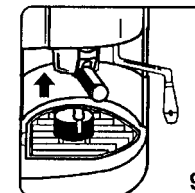
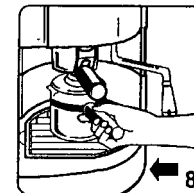
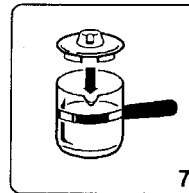
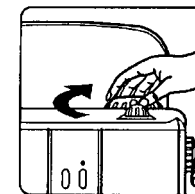
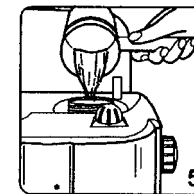
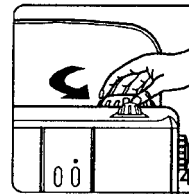
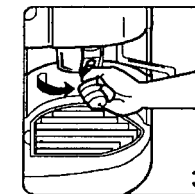
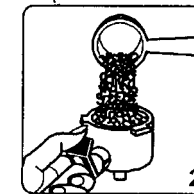
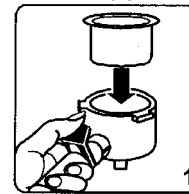

Espresso/Cappuccino

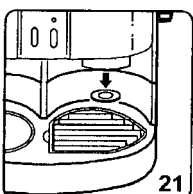
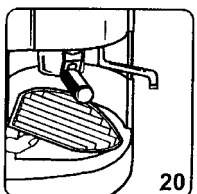
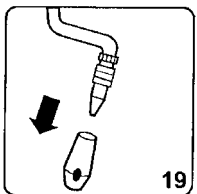
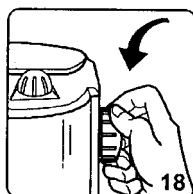
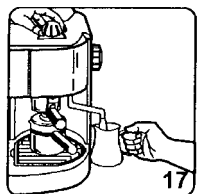
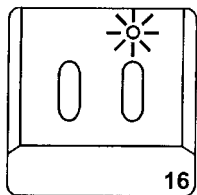

Filter Coffee

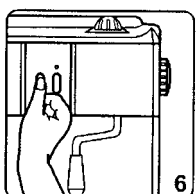
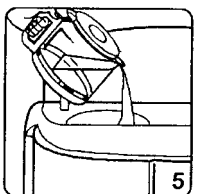
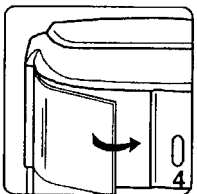
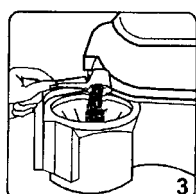
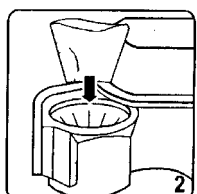
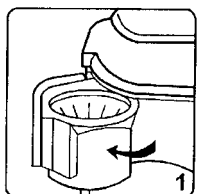

CLEANING

Before cleaning, turn off the machine, unplug it, and allow it to cool down. The filter holder, filter basket, carafe, carafe lid, and overflow grid can be put in the dishwasher's upper rack, away from the heating / drying element. The machine can be wiped clean by using a damp cloth. Never immerse the body of your **Coffee Bar** in water or any other liquid. Clean the brewing head with a damp cloth and remove ground coffee. If there is water left in the boiler chamber, let the machine cool down, remove all loose parts and empty through the top opening by turning upside down.

Cleaning The Steam Nozzle

Clean the steam nozzle each time after you have immersed it in milk, otherwise the inside of the nozzle becomes clogged and the milk deposits on the outside harden and become difficult to remove. The froth attachment can be removed for cleaning (See figure 19). If clogging does occur, remove all milk particles using a sewing needle. Immediately after you are done with frothing milk, wipe off the outside of the nozzle with a wet cloth. Hold the wet cloth very close to the tip of the nozzle and turn on the steam control knob. Let the steam escape into the wet cloth for one or two seconds. Any milk residue will then be flushed out. Then turn off the machine.

Cleaning The Drip Tray

The overflow grid can be cleaned by removing the grid (see figure 20).

CAUTION

DO NOT try to open or disassemble the main body of the machine.

DECALCIFYING OF THE ESPRESSO MACHINE

The espresso machine must be decalcified regularly. The frequency depends on the hardness of your water and how often you use the espresso machine.

Before descaling, the brewing sieve on the brewing head **MUST** first be screwed off. (See figure 21)

1. Remove all lime and coffee residues from the brewing sieve and the brewing head.
For ecological and health reasons, we recommend the exclusive use of biological materials such as citric acid, which can be obtained from drugstores.
2. Dissolve 2 tablespoonfuls of citric acid in 10 fluid ounces of lukewarm water and pour it into the boiler container. Put one receptacle under the brewing head and another under the steam nozzle (Note: Do not use the filter holder during decalcification).
3. Turn on the machine and the steam control knob, and wait until steam comes out of the steam nozzle. Let steam run for approximately 30 seconds.
4. Then turn off the steam control knob and allow the descaling solution to pass through the brewing head.
5. After each brewing cycle, switch off the appliance and allow the appliance to cool down.
6. Repeat this operation once again.

Following this, allow 2 boiler containerfuls of clear water to run through the system. Switch off the appliance. Allow the appliance to cool down. Insert the brewing sieve into the brewing head again and screw tight.

ATTENTION

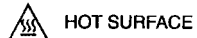

The filter holder may be hot during operation, to remove the filter holder, turn the filter to the left, until the holder dislodges from the machine. (See figure 14)

The metal parts might still be hot and can be cooled down by running cold water over them.

To make more espresso, proceed as follows: Check to see if the boiler chamber is empty and not under pressure (see section CAUTION - PRESSURE).

Remove filter holder (f). Empty metal filter (See figure 15). Repeat steps 1-4 of this section.

Preparation of Cappuccino

1. The first step in making cappuccino is to make espresso. Therefore, fill the glass carafe with the amount of water which is required to make the desired amount of espresso, plus additional water for frothing milk (see section Making Espresso).
2. Fill a small stainless steel pitcher 1/3 to 1/2 full with fresh, cold milk and set aside.
3. To make espresso, turn on the machine. As soon as half the required amount of espresso is produced, turn the strength control knob clockwise until tight. At this time the boiler has created enough pressure and steam to start frothing milk. The indicator light of steam will turn on (See figure 16) frothing milk before finishing the espresso prevents you from running out of steam. This will happen if you froth milk towards the end of the brewing process.
4. To froth milk, take your pitcher with fresh, cold milk and insert steam nozzle with froth attachment halfway into the milk (See figure 17). Then turn the steam control knob in anti-clockwise direction (See figure 18) for approximately 45-60 seconds depending on how much froth you want. Turn the steam control knob clockwise till tight after use.

ATTENTION

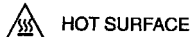

Do not bring milk to a boil (this will happen if large bubbles start forming at the surface of the milk).

5. After the milk is frothed, set aside, and allow it to settle. Turn the steam control knob clockwise to shut steam.
6. Turn the strength control knob anti-clockwise to the desired level to finish making the espresso.
7. Pour the espresso into a cup which has a capacity of at least 5 ounces. Add the steamed milk to the espresso and spoon on the frothed milk. The proportion between espresso and milk is to taste; in Italy it is normally 1 part espresso to 2 parts milk plus froth. The steam nozzle may be hot during operation.

Steam Only

If you only want to froth milk, fill the glass carafe with water up to the "☺" mark. This will give you approximately one minute of steaming. Make sure the strength control knob is set to the rightmost position.

1. Pour the water into the water chamber and turn on the machine.
2. Place a cup under the steam nozzle to collect any water which may escape. As soon as the indicator light is on, turn on the steam control knob.
3. Now follow steps 4 & 5 and when finished frothing the milk turn off the machine.

IMPORTANT

When using electrical appliances, basic safety precautions should always be followed, including the following:

- Read all instructions and information in this instruction book and any other literature included in this carton referring to this product before operating or using this appliance.
- Do not touch hot surfaces. Use handles or knobs.
- To protect against fire, electric shock and personal injury do not immerse cord, plugs, or appliance in water or other liquid.
- Close supervision is necessary when any appliance is used by or near children.
- Unplug from outlet when not in use and before cleaning. Allow to cool before putting on or taking off parts, and before cleaning the appliance.
- Do not operate any appliance with a damaged cord or plug or after the appliance malfunctions, or has been damaged in any manner. Return appliance to the nearest authorized Service Center for examination, repair or adjustment.
- The use of accessory attachments not recommended by the appliance manufacturer may result in fire, electric shock, or personal injury.
- Do not use outdoors.
- Do not let cord hang over edge of table or counter, or touch hot surfaces.
- Do not place on or near a hot gas or electric burner, or in a heated oven.
- To disconnect, turn any control to off then remove plug from wall outlet.
- Do not use appliance for other than intended use.
- Do not unscrew or remove boiler cap while the machine is in operation. Wait until brewing cycle is completed and all water and steam has been used up.
- Use of the Glass Carafes.
 - A. The carafe is designed for use with this appliance. It must never be used on a range top.
 - B. Do not set a hot carafe on a wet or cold surface.
 - C. Do not use a cracked carafe or a carafe having a loose or weakened handle.
 - D. Do not clean carafe with cleansers, steel wool pads, or other abrasive material.

CAUTION:

SAVE THESE INSTRUCTIONS

This appliance is for household use. Any servicing other than cleaning and use maintenance should be performed by an authorized service representative.

- Do not immerse base in water or try to disassemble.
- To reduce the risk of fire or electric shock, do not remove the base. No user serviceable parts inside. Repair should be done by authorized service personnel only.
- Check voltage to be sure that the voltage indicated on the name plate agrees with your voltage.
- Never use warm or hot water to fill the water container! Use cold water only!
- Never refill the water chamber while this coffeemaker is in the on-position. Turn the coffeemaker off and let it cool down for ten minutes before refilling with water.
- Before turning your coffeemaker on, please make sure that carafe sits flat on inside circle of heating plate.
- Keep your hands and the cord away from hot parts of the appliance during operation.
- Never clean with scouring powders or hard implements.

The **Coffee Bar** is a state of the art combination coffee, espresso, and cappuccino maker that incorporates all of these functions in an all in one space saving coffee/espresso making system. This appliance offers ease of operation and flawless performance.

BEFORE YOU START...

We recommend that you get familiar with all the parts of your **Coffee Bar** before operating the machine. With the unit unplugged, begin by inserting the metal filter (g) into the filter holder (f), fit the filter holder into the brewing head, and remove and replace the boiler cap (a). Try the on/off button and steam controller, and check out all parts of the coffeemaker as well. Wash all loose parts in warm, soapy water, rinse thoroughly and dry.

It is also recommended that you operate your **Coffee Bar** once without coffee using the instructions provided for espresso and coffee making.

CAUTION - PRESSURE

It is important to remember to NEVER open the boiler cap (a) or remove the filter holder (f) while your **Coffee Bar** turned "on", or as long as there is pressure in the boiler.

Please follow the instructions listed below to see if the machine is still under pressure. **These safety precautions should be followed while your machine is in use and ten to fifteen minutes after last use of the machine.**

1. Make sure the machine is in the "off" position.
2. Unplug the machine.
3. Hold a pitcher with cold water underneath the steam nozzle and insert nozzle into the pitcher.
4. Once the steam nozzle is immersed in the pitcher of water, turn the steam control knob in anti-clockwise direction. Continue this procedure until no more steam comes out of the steam nozzle.
5. Turn the steam control knob to the clockwise direction.
6. Now you can remove the boiler cap and filter holder.

In case there is still water in the boiler chamber, remove the glass carafe and drip tray, and turn the machine upside down to empty any remaining water in the chamber.

GENUINE ESPRESSO

Espresso is a far richer and stronger brew than regular coffee. It should be deep, dark, and delicious. Most people find that they enjoy it in small quantities because of its richness, and for that reason, espresso is usually served in small (2-2 1/2 oz.) demitasse cups.

Your **Coffee Bar** properly used, will always produce espresso that is deep, dark and delicious. Just follow the instructions and use fresh, well-roasted, pre-ground espresso beans.

Remember: Espresso requires a finer grind than regular coffee.

Making Espresso

1. Place your **Coffee Bar** near an electrical outlet, then plug in the machine. Make sure the espresso button is in the off position.
2. Place your metal filter (g) into the filter holder (f) (see figure 1). The metal is marked on the inside indicating 2 or 4 cups. Fill to the desired level.
3. Fill the metal filter with ground espresso coffee (see figure 2). Pack the coffee lightly and clear any excess coffee from the rim of the filter holder. This will ensure the filter holder will fit properly into the brewing head.

ATTENTION

Do not pack coffee tightly. Do not fill more coffee than indicated by the 4-Cup marking.

This might cause clogging or overflow (see section Problems & Causes).

4. Insert the filter holder to the machine. Raise the filter holder up into brewing head and turn the filter holder firmly to the right, until it can go no further. The filter holder should be as far right in the lock range as possible. If the filter is not at least in the middle of the lock range, do not operate the machine. Rather, remove the filter holder and reinsert it as described above until the filter is within the lock range (see figure 3).

By following this procedure this will prevent the filter holder from being dislodged as pressure builds up during the brewing process.

5. Unscrew the boiler cap (a) by turning it anti-clockwise (see figure 4).
6. Using the glass carafe, fill the boiler chamber with fresh, cold water (see figure 5) to the corresponding water level.

Measuring Guidelines

The glass carafe (i) has markings for 2 cups and 4 cups and steaming. 2 cups of water yields 2 cups of espresso. 3 cups of water yields 2 cups espresso, plus steam for frothing milk for cappuccino. 4 cups of water yields 4 cups espresso. 5-5 1/2 cups of water is the upper rim of the metal band surrounding the carafe.

CAUTION

Never fill the boiler chamber while your **Coffee Bar** is in operation. It should be in the off position.

Never pour more than 12 oz. of water into the boiler chamber.

7. Place the boiler cap (a) on the machine and turn it clockwise until it is secure (see figure 6).
8. Next, place the carafe lid on the carafe (h) so that the opening points towards the pouring spout on the carafe (see figure 7).
9. Position the carafe under the filter holder. Make sure that the nozzle in the filter holder points through the opening of the carafe lid (see figure 8).

ATTENTION

Make sure that the overflow grid (j) is in place.

10. To make espresso directly into the cups, clip the cup adapter (j) onto the filter holder (see figure 9). Place cups directly under the two spouts (see figure 10).
11. Now you are ready to make espresso. Simply press the "Espresso / Cappuccino" button to turn on. (See figure 11). The on/off indicator light will illuminate. Turn the espresso strength control (c) to desired level. (See figure 12 & 13).
12. After approximately 2 minutes the water will have reached the proper temperature. The water at this time will pass through the ground coffee, producing espresso in the glass carafe or in the cups, whichever you choose.
13. Once the espresso has stopped brewing, turn off the machine by depressing the "Espresso / Cappuccino" button. (See figure 11). The control light will go out, indicating that the machine is off.
14. Before you remove the filter holder for cleaning, make sure that the boiler is no longer under pressure (see section CAUTION - PRESSURE).

Free Manuals Download Website

<http://myh66.com>

<http://usermanuals.us>

<http://www.somanuals.com>

<http://www.4manuals.cc>

<http://www.manual-lib.com>

<http://www.404manual.com>

<http://www.luxmanual.com>

<http://aubethermostatmanual.com>

Golf course search by state

<http://golfingnear.com>

Email search by domain

<http://emailbydomain.com>

Auto manuals search

<http://auto.somanuals.com>

TV manuals search

<http://tv.somanuals.com>