

mellerware®

TRENDS FOR LIFE



prima complete
hand mixer & bowl



complies with
INTERNATIONAL
IEC60335
SAFETY SPECIFICATIONS

m
200W

CE
2 YEAR
GUARANTEE

Model:
26401

PLEASE READ ALL INSTRUCTIONS BEFORE USE

2 year
guarantee



Dear Customer,

Thank you for purchasing a MELLERWARE household appliance. Its technology, design, and functionality, along with complying to the strictest quality standards, will be a source of satisfaction for a long time to come.

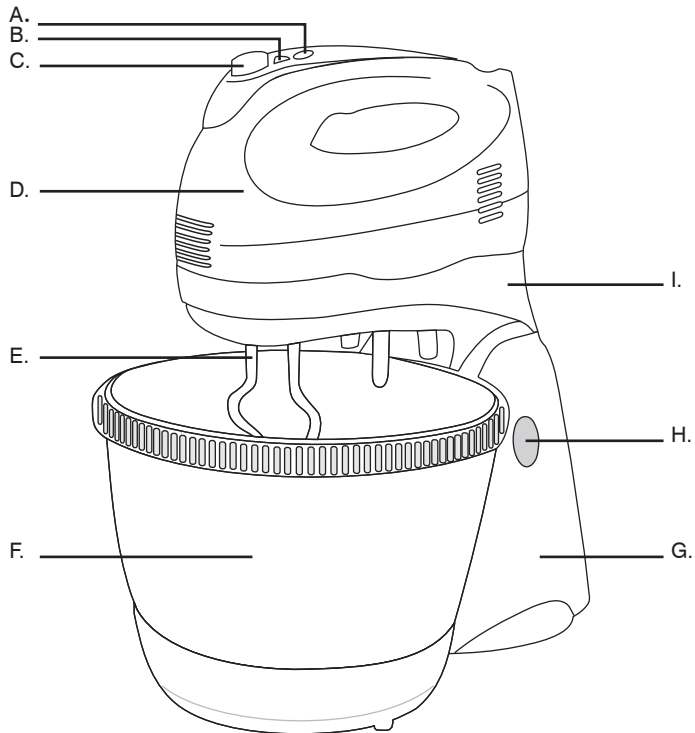

DESCRIPTION

- | | |
|---|-----------------------|
| A | Turbo |
| B | Speed control |
| C | Throwing out key |
| D | Power unit |
| E | Beaters/Kneaders |
| F | Rotating bowl |
| G | Stand |
| H | Holder release button |
| I | Mixer holder |

USE

The appliance is designed to work on standard voltage only. Please check that the voltage indicated on the plate corresponds to that in use.

MIXING FUNCTION

1. Put the food that you want to blend into a container.
2. Set the speed turbo to "0" position, and then fix mixer into the appliance.
3. Plug the socket and then press the selector after the mixer is put into the container.
4. Please use slow speed (1-2) for blending around 30 seconds, and then use high speed. If you press the turbo, the mixer can get to the highest speed instantly. The machine must have 30 minutes interval after it works 5 minutes.

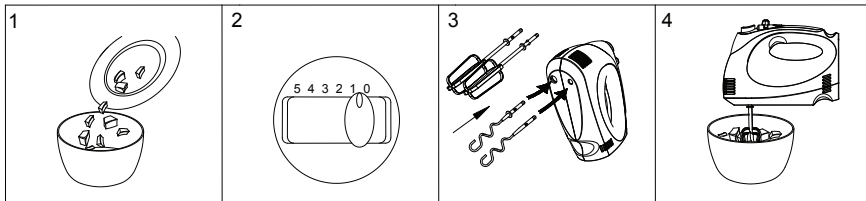

Mixing with the mixer on the stand

1. Place the mixer on the stand. First fit the front of the mixer into the snap hook in the holder and then press the rear end of the mixer down ('click').
2. Press the holder release button and tilt the holder with the mixer backwards.
3. Insert the beaters or kneading hooks into the mixer. Make sure you insert the beater or the kneading hook with the plastic collar into the larger opening in the bottom of the mixer.
4. Put the ingredients in the bowl. For the best result, put the liquid ingredients in the bowl first and then add the dry ones. Then place the bowl on the stand and put plug in the wall socket.
5. Press the holder release button and bring the mixer into horizontal position so that the beaters or kneading hooks are lowered into the ingredients. Then switch the mixer on.
6. When you have finished mixing, set the control slide to 0 and unplug the appliance. Then press the holder release button and tilt the holder with the mixer on it backwards.
7. Push the control slide forward to the eject position to release the beaters or kneading hooks and remove them from the mixer.
8. The mixer can be removed from the holder when the holder is in upright or horizontal position. Press the mixer release lever at the rear end of the holder and lift the mixer off the holder. Finally remove the bowl from the stand.

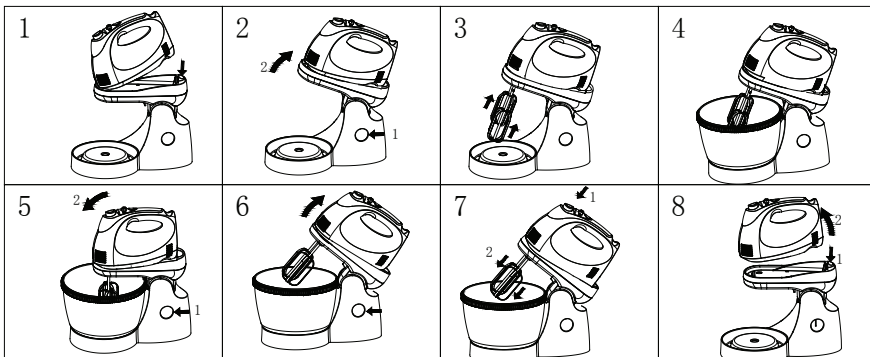



WARNING

1. This appliance has been designed to operate at intervals. Do not use your hand blender continuously for 1 minute maximum. After such time allow the motor of your appliance to cool down.
2. The appliance is not to be used by children or persons with reduced physical, sensory or mental capabilities, or lack of experience and knowledge, unless they have been given supervision or instruction.

Children being supervised not to play with the appliance

3. We suggest wearing ear protection while operating the appliance.

SAFETY

1. Do not operate the appliance under the following conditions:
 - a) The surface or the power cord is damaged.
 - b) After the appliance was dropped from high place or crashed.
 - c) Some water on the surface of the appliance or power cord.
2. Do not place the appliance on any heat surface (such as an electric stove or heat sources).
3. Do not place the appliance into water or any other liquid.
4. The current voltage indicated on the plate must correspond to that in use.
5. Keep the appliance away from children.
6. Please unplug the appliance and cut off the power in these cases:
 - a) Before inserting or removing the beaters and dough hooks.
 - b) The appliance has broken down during operation.
 - c) Before any cleaning is undertaken.
 - d) After each use.
7. Only turn on the power when the beaters have been fixed and when they have been placed into the container. The beaters should only be removed when the mixer has stopped completely.
8. Hard objects should not be placed in the mixer during operation. Never touch the spinning beaters / dough hooks with your hand during operation.
9. Do not blend paint with this mixer.
10. The appliance will heat up during normal operation. Please stop using it when the surface temperature is beyond 60degC. Allow it cool down before using it again.
11. Do not hang or move the appliance with power cord.
12. Do not pull the cord strongly. Never operate the appliance or connect wire with wet hands.
13. The appliance comes with a type Y attachment having a specially prepared cord. If the supply cord is damaged, it must be replaced by the manufacturer or its service agent or a similarly qualified person in order to avoid a hazard.
14. Close adult supervision is required when this appliance is used by children.

Do not place appliance into water or other liquid



Do not place appliance on any heat surface

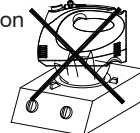





CLEANING

1. Unplug the appliance and set the speed turbo to "0" position. The mixer should be taken out from the container before cleaning. Please ensure that all parts of the appliance are dry before using.
2. The mixing bowl can be cleaned with hot water, detergent or in dishwasher.
3. The appliance and power cord can be cleaned with a damp cloth. Dirt that is hard to remove can be cleaned with detergent. In order to avoid damaging the surface, do not clean it with hard stuff.



How to Select the Proper Mixing Speed

SPEED	Function	USE	Select Tools	Mix Weight (g)	Mix Time(s)
1(Low)	Blend	To combine liquids, fold in dry ingredients, egg whites and whipped cream		1000	30
2(Low)	Stir	To prepare sauces, puddings, muffins and quick breads.		1200	60
3(Medium)	Mix	To prepare batters and mixes		800	180
4-5(Medium)	Beat	To cream butter and sugar, make cookie dough, cake mixer and frostings.		600	300
Turbo(High)	Whip	To whip light and fluffy mixtures, whip cream, beat eggs (white, yolks, whole) and mash potatoes		1000	100



This marking indicates that this product should not be disposed with other household wastes throughout the EU. To prevent possible harm to the environment or human health from uncontrolled waste disposal, recycle it responsibly to promote the sustainable reuse of material resources. To return your used device, please use the return and collection systems or contact the retailer where the product was purchased. They can take this product for environmental safe recycling.



creative housewares

27 Nourse Avenue Epping 2 Cape Town
PO. Box 975 Eppindust 7475 South Africa
Tel: +27 21 534 8114 Fax: +27 21 534 8086
Service Centre Share Call: 086 111 5006
web: www.creativehousewares.co.za

Free Manuals Download Website

<http://myh66.com>

<http://usermanuals.us>

<http://www.somanuals.com>

<http://www.4manuals.cc>

<http://www.manual-lib.com>

<http://www.404manual.com>

<http://www.luxmanual.com>

<http://aubethermostatmanual.com>

Golf course search by state

<http://golfingnear.com>

Email search by domain

<http://emailbydomain.com>

Auto manuals search

<http://auto.somanuals.com>

TV manuals search

<http://tv.somanuals.com>