

Miele

NOVOTRONIC

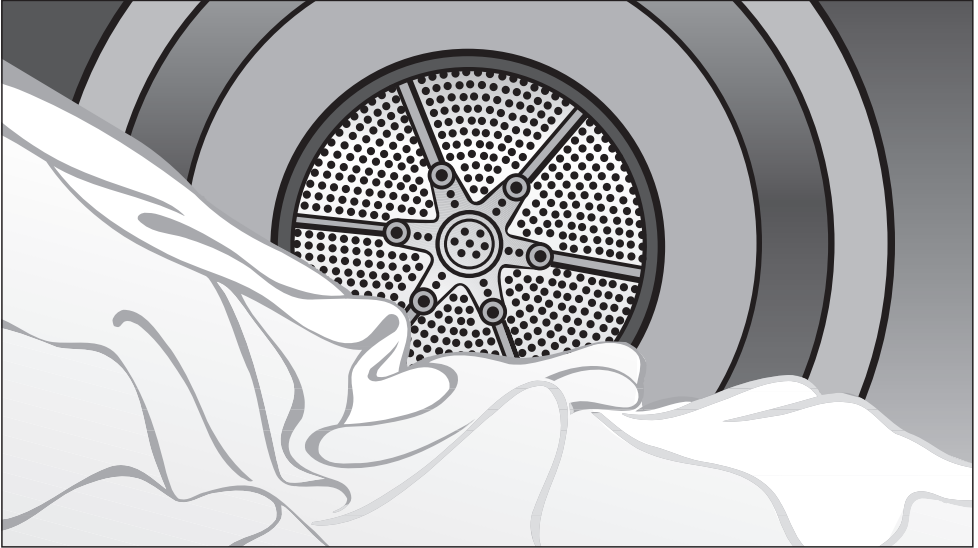

Operating Instructions for condenser tumble dryer T 7644 C

To avoid the risk of personal injury or damage to the appliance, it is **essential** that you read these operating instructions **before** installation and use. This machine is not approved for use in the United States.

en - CA

M.-Nr. 07 323 260

Caring for the environment

Disposal of packing material

The packing materials protect the dryer from damage during transport. They have been selected for environmental compatibility and efficient disposal and can therefore be recycled.

To prevent suffocation, ensure that any plastic wrappings, bags, etc. are disposed of safely and kept out of the reach of children.

Disposing of your old appliance

Old appliances may contain materials that can be recycled. Please contact your local recycling authority about the possibility of recycling these materials.

Ensure that a discarded dryer presents no danger to children. When being stored for disposal remove the door to the drying compartment.

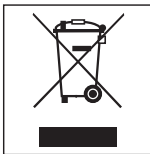

Saving energy

To avoid unnecessarily long drying times and increased energy use:

- Let the wash spin in the washer at maximum spin speed.
You can save about 30% in energy and time if you spin at 1600 instead of 800 rpm.
- Use the maximum load for each drying program. This gives the optimum energy consumption in relation to the total amount of laundry.
- Ensure that the room where the dryer is located is sufficiently ventilated.
- Clean the lint screen after every use.
- Check the condenser unit from time to time and clean it when necessary.

Caring for the environment	2
IMPORTANT SAFETY INSTRUCTIONS	5
Description	8
Operating the dryer	8
Function of Miele condenser dryer	8
Operation of Miele condenser dryer	8
Main Features	8
Operating the dryer	10
Control panel	10
Laundry care	12
Care symbols	12
Drying tips	12
Proper drying	14
Brief instructions	14
Options/Delay	17
Gentle	17
Buzzer	17
Delay	17
Program Overview	18
Changing the program sequence	21
Switching over from a running program	21
- Canceling and selecting a new program	21
- Interrupting a program and removing laundry	21
Loading or removing laundry	21
Time remaining	21
Electronic lock	22
Cleaning and care	23
Emptying the condensed water container	23
Cleaning the lint filtration components	24
Cleaning without water	24
Cleaning with water	25
Cleaning the dryer	25
Cleaning the condenser (heat exchanger) unit	26
Removing the condenser unit	26
Checking the condenser unit	27
Cleaning the condenser unit	27
Replacing the condenser unit	28

Contents

Trouble shooting	29
What to do, if . . . ?	29
Test and fault messages.	29
Other problems	31
Replacing the light bulb.	34
Customer service	35
Repairs.	35
Program updates	35
Warranty conditions and warranty period	35
Optional accessories	35
Installation and connection	36
Front view.	36
Rear view	37
Installation site	37
Carrying the dryer to the installation site	37
Washer-dryer stack.	37
Leveling the dryer	38
Ventilating the installation area	39
Before transport at a later date.	39
Draining condensed water externally	40
Arranging the drain hose	40
Hooking up the drain hose (in sink or floor drain)	41
Special installation conditions requiring a non-return valve	41
Electrical connections	43
Technical data	44
Programmable functions	46
Extending the range of drying levels	46
Adjusting buzzer volume	47
Set memory function	48
Extending cooldown time	49
Change function of Filter/Vent indication.	50
Adjust keypad tone	51
Changing water conductivity setting	52

IMPORTANT SAFETY INSTRUCTIONS

 This machine T 7644 C meets all CSA requirements. This machine is not approved for use in the United States.

 **WARNING** - To reduce the risk of fire, electric shock, or injury to persons when using your appliance, follow basic precautions, including the following:

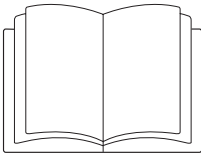

▶ It is **essential** to read all instructions before using the appliance.

▶ The dryer is designed for household use only and only for drying textiles that have been washed in water and whose fabric care label states that they can be tumble dried. Other uses may be dangerous. Miele will not be held liable for damage caused by improper use or incorrect operation.

▶ Do not allow children to play on or in the appliance. Close supervision is necessary when the appliance is used near children. Always close the door after use to prevent child hazards.

▶ This appliance is not intended for use by persons (including children) with reduced physical, sensory or mental capabilities, or lack of experience or knowledge, unless they are supervised whilst using it or have been shown how to use it by a person responsible for their safety.

▶ Before this appliance is removed for service or discarded, remove the door to the drying compartment.

▶ Do not reach into the dryer if the drum is moving.

▶ Do not install or store this appliance where it will be exposed to the weather.

▶ Do not tamper with the controls.

▶ Do not repair or replace any part of the appliance or attempt any servicing unless specifically recommended in these operating instructions. Repairs to electrical appliances should only be performed by qualified personnel. Incorrectly repaired machines may pose a considerable risk to the user.

▶ Do not use fabric softener sheets to eliminate static in this dryer. Best results are achieved when a liquid softener is used in the washer. Follow the manufacturers instructions.

▶ To prevent the risk of fire, the following textiles must not be dried in this dryer:

- items which have not been washed.
- items, such as work-wear, exposed to grease, oils, or other deposits (such as lotions or cosmetics) in your dryer. If these items have not been thoroughly cleaned there is a danger that they may contribute to a chemical reaction that could cause the laundry to ignite when heated even after being removed from the dryer.

IMPORTANT SAFETY INSTRUCTIONS

- items that have been previously cleaned, washed, soaked or spotted with gasoline, dry-cleaning solvents or other flammable or explosive substances. They may give off vapors that could ignite or explode.
- items treated with flammable cleaning agents or items containing acetone, alcohol, petrol, stain remover, wax or chemicals from buffing, etc.
- items which have been splashed with hair spray, nail polish remover, etc.

When washing heavily soiled items ensure that sufficient detergent is used with a high temperature. If in doubt wash the item several times.

- items containing foam rubber or similarly textured rubber-like materials.
 - items with padding or filling (e.g. pillows or jackets) which have been damaged. Loose filling could catch fire.
- ▶ **WARNING** – Never stop a tumble dryer before the end of the drying cycle unless all items are quickly removed and spread out so that the heat is dissipated.
- ▶ Allow the dryer to complete each stage of the program selected, including the cooling down phase. This will ensure that the items being removed are not too hot to handle
- ▶ Clean the lint filter and lint screens before or after each load.

- ▶ Keep the area around the air intake (toe kick) and adjacent surrounding areas free from lint, dust and dirt.
- ▶ The interior of the machine should be cleaned periodically by qualified personnel.

This dryer is intended for residential use only!

▶ GROUNDING INSTRUCTIONS

This appliance must be grounded. In the event of malfunction or breakdown, grounding will reduce the risk of electric shock by providing a path of least resistance for electric current. This appliance is equipped with a cord having an equipment grounding conductor and a grounding plug. The plug must be plugged into an appropriate outlet that is properly installed and grounded in accordance with all local codes and ordinances.

▶ **WARNING** – Improper connection of the equipment-grounding conductor can result in a risk of electric shock. Contact a qualified electrician if you are in doubt as to whether the appliance is properly grounded.

▶ Do not modify the plug provided with the appliance: if it will not fit the outlet, have a proper outlet installed by a qualified electrician.

▶ A faulty power cord must be replaced by a genuine Miele power cord.

▶ Do not use the dryer without lint screens or with damaged lint screens.

▶ Lint screens must be cleaned regularly!

IMPORTANT SAFETY INSTRUCTIONS

▶ The dryer should not be operated without its condenser unit.

▶ Lint screens and door lint filter must be dried after wet cleaning. Wet screens may cause faulty dryer operation!

▶ Do not place the dryer in a room where there is a risk of frost occurring. Temperatures around the freezing point affect dryer performance. Condensed water freezing in the pump and the drain hose can lead to damage.

Permissible room temperature must be between +2°C and +35°C.

▶ If the condensed water is drained externally, you must secure the drain hose against slipping off, if for example it is hanging from a sink. If the hose slips off, the condensed water released can cause damage.

▶ Condensed water is not potable. It can endanger the health of people and pets.

▶ Keep the room in which the dryer is installed free of dust and fluff. Dirt particles in the incoming cooling air impair performance.

▶ Do not sit or lean on the door. The dryer might tip over.

▶ Close the door after every drying cycle. In this way you can prevent

- children from trying to climb into the dryer or leaving objects inside it.
- Pets or small animals from getting into the dryer.

▶ Do not hose down the dryer.

Accessories

▶ Accessory parts may only be attached or installed when they have been expressly approved by Miele. If other parts are added or installed, guarantee, performance and/or product liability claims are invalidated.

The manufacturer will not be held liable for damage caused by failure to comply with the safety instructions and warnings.

SAVE THESE INSTRUCTIONS

Description

Operating the dryer

Dear Customer,

Thank you for choosing Miele condenser (heat-exchanger) dryer!

Function of Miele condenser dryer

The condenser dryer evaporates water from damp clothes.

The water vapor is then condensed and collected in a special container.

Operation of Miele condenser dryer

The condenser dryer circulates air (trapped with wet laundry inside a reversibly rotating drum) via lint filters, heat exchanger and heaters, back into the drum in a closed loop.

The vapor condenses inside the heat exchanger and is collected in a condensed water container.

The heat exchanger (condenser) needs cooling, so the dryer circulates ambient air, through separate channels across heat exchanger, in an open loop. (the two air flows do not mix).

Returning ambient air warms up the room with dry heat.

Practically all energy, taken from the electrical wall outlet, remains in the room as dry heat.

Main Features

1. **No outside venting is required:**

The dryer operates on heat-exchange principle.

Ideal for condominiums – needs only a regular Canadian dryer wall outlet and room air for cooling. Saves space (normally taken by a vent).

2. **No depressurization,**

3. **No burden on dwelling's existing venting system,**

4. **High energy efficiency:**

Axial air flow.

Automatic moisture sensing and drying stage termination.

No venting to outside = the electrical energy is not blown outside, but stays in the room in form of dry heat (as opposed to a vented dryer).

This dry heat helps to keep a house warm in cold months.

By helping to heat the house in winter, condenser dryer lowers overall energy needs of a house, thus becoming effectively more energy efficient than a vented dryer.

5. Laundry care – anti-crease action and roll-up prevention:

To limit wrinkling the dryer performs the following actions:

- 5.1. Tumble drying with drum reversal (prevents roll-ups of laundry, creasing and uneven drying),
- 5.2. Constantly measures the temperature of air coming into and leaving the drum,
- 5.3. Cycles two heater sections for 0, half and full power, to control drum's temperature,
- 5.4. Automatic drying stage termination, after the desired Dryness level of laundry is reached,
- 5.5. Cooling down with tumbling and drum reversal,
- 5.6. Anti-crease with drum reversal:
 - **axial air flow in the drum:** for uniform drying.
 - **smooth stainless steel drum:** for air cushioning of tumbling laundry and reliable residual moisture sensing.

To do all this, the dryer is equipped with systems:

- i. water conductivity metering,
- ii. sensing of laundry's residual moisture,
- iii. software,
- iv. reversing drum drive.

Operating the dryer

Control panel

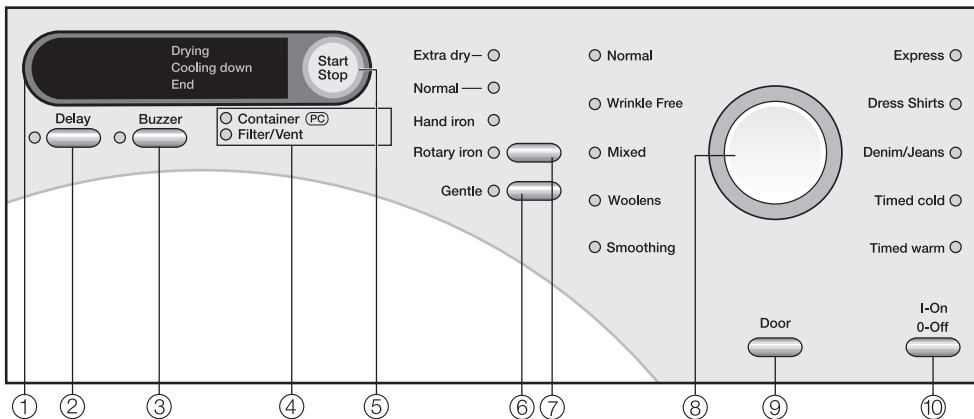

① Display

② Delay button

This button has a dual function:

- Selecting the duration of the *Timed cold* and *Timed warm* programs.
- Pre-selection of start time.

③ Buzzer button

The end of the program is signaled audibly.

④ Fault indicator / Optical interface

Description: See "Problem solving / Customer service" section.

⑤ Start/Stop button

Starts and stops a program.
Interrupts a program when pressed.
Flashes during program selection and lights once the program starts.

⑥ Gentle button

Delicate fabrics are dried at a lower temperature.

⑦ Dryness button

Indicator lights identify the drying level selected.

⑧ Program selector

Indicator lights identify the program selected.

⑨ Door button

This button opens the door independently of the power supply.

⑩ I-On/0-Off button

For switching the dryer on and off.

Display

The following functions are selected from the display:

- Delay
- Selecting duration of *timed* programs.
- Programmable functions.

The display also shows:

- Program duration.
- Program stage:
 - Drying*
 - Cooling down*
 - End.*
- Test and fault messages.

Program duration/ Estimated time remaining

When a program is selected, the estimated time remaining will be displayed. This is to be considered an estimate only.

The following factors can lead to variations in the time remaining estimate: Residual moisture after spinning; type of fabric; size of load; ambient temperature, or fluctuations in the power supply.

The adaptive electronics constantly adjusts to the individual wash load to ensure a more accurate estimate of time remaining. This estimate is permanently monitored during drying, which in some cases can lead to a change in the estimate.

In this way, the delicate and smoothing programs can end earlier, when a certain temperature is reached. This can happen with particularly fine fabrics, very small loads, or if items have previously been dried.

Delay

The delay time selected will be displayed.

The delay time countdown begins after pressing the *Start* button.







Once the time delay expired, the estimated program duration will appear in the display and the drying begins.

Programmable functions

The programmable functions can be used to adapt the dryer to your personal requirements. In programming mode, the display will show the function selected.

Laundry care

Care symbols

Drying	
	Normal/higher temperature
	reduced temperature: select <i>Gentle</i> (for delicate fabrics)
	Not suitable for dryer
Ironing and rotary ironing	
	very hot
	hot
	not very hot
	Do not iron/rotary iron

Drying tips

- Always check the weight recommendation for maximum loads as listed in the "Program Overview" section.

Overloading will cause wear and tear on the laundry, give a poor drying result and cause more creasing.

- Do not dry fabrics that are still soaking wet! After washing, spin fabrics for at least 30 seconds.
- Dry mixed loads of cottons, colors and easy-care fabrics in the Express program.
- Open jackets so that they dry evenly.
- Woolens and wool blends tend to mat and shrink. Only handle these fabrics in the *Woolens* program.
- The linings of down-filled garments, depending on quality, tend to shrink. Handle these fabrics only in the *Smoothing* program.
- Pure linens are dried only when indicated on the care label. Otherwise the fabric may become rough. Handle these fabrics only in the *Smoothing* program.
- Cottons (such as T-shirts and underwear) depending on quality, often shrink at the first wash. Therefore: to avoid further shrinkage, do not over-dry these textiles.
- Starched laundry may be dried. To achieve the usual finish, however, use a double amount of starch.
- Wash new colored fabrics separately before the first drying. Do not dry them together with light-colored fabrics since their colors may run and discolor other garments or even plastic dryer components.

- Wrinkling increases with larger loads. This especially occurs with very fine fabrics as used in shirts and blouses.

To limit wrinkling the dryer performs the following actions:

1. Tumble drying with drum reversal (prevents roll-ups of laundry, creasing and uneven drying),
2. Constantly measures the temperature of air coming into and leaving the drum,
3. Cycles two heater sections for 0, half and full power,
4. Automatic drying stage termination, after the desired Dryness level of laundry is reached. To do this, the dryer is equipped with systems:
 - water conductivity metering,
 - sensing of laundry's residual moisture,
 - software.
5. Cooling down with tumbling and drum reversal,
6. Anti-crease with drum reversal.

In cases of doubt, reduce the load by dividing it.

Use the *Dress shirts* program.

Proper drying

Brief instructions

The operating steps identified with numbers(1, 2, 3, ...) may be used as short-cut instructions.

1 Preparing the laundry

Loosen the washed garments and sort them by: . .

- . . . desired drying level,
- . . . type of fabric and finish,
- . . . size,
- . . . same residual moisture content after spinning.

This will produce very even drying.

 Remove foreign objects like detergent dispensing devices from the laundry. They can melt and damage the dryer and the wash.

- Check hems and seams to ensure that linings don't come out.
- Close duvet covers and pillowcases to prevent small items from getting inside.
- Fasten hooks and close buttons.
- Tie fabric belts together.

2 Turn on the dryer

You may also switch the dryer on after loading it, as the drum will not be illuminated, to save energy.

- To turn it on, press the *I-On/0-Off* button.

3 Loading the dryer

- Press the *Door* button to open.
- Place the laundry loosely in the drum.

Do not exceed maximum loads specified in the "Program Overview" Section.

Overloading may cause wear and tear on the laundry and adversely affects drying.

- Before closing the door, check that the lint filter is properly inserted in the door casing.

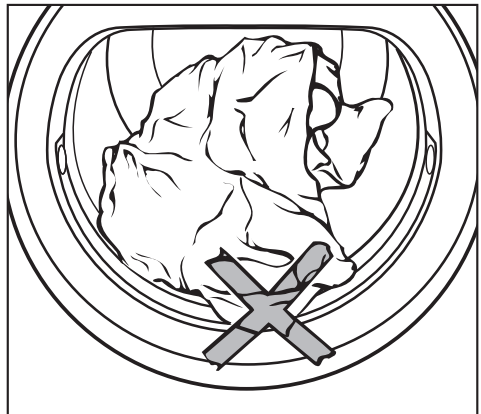

Ensure that no small items are jammed in the door, because they might otherwise be damaged.

4 Select program

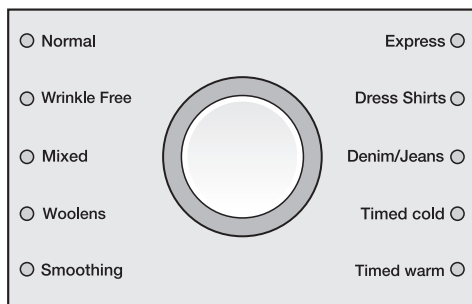

- Select the desired program.

The indicator light for the program selected lights up.

Other indicator lights for drying levels or extras may be lit, and drying times displayed.

Dryness level selection in programs:

- *Normal, Wrinkle-free, Express, Dress shirts, denim/jeans*

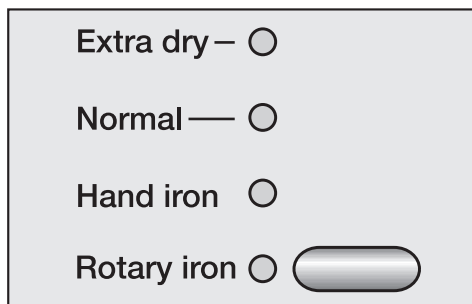

- Press the button repeatedly until the desired indicator light is lit.

For *Normal* any dryness level can be selected, but selection is limited in other programs.

Note: The estimate of time remaining shown in the display varies with each new program selection.

Woolens and Smoothing programs:

- cannot be altered.

Timed program

The *Delay* button flashes when *Timed cold* or *Timed warm* programs are selected.

- Repeatedly press the *Delay* button until the required duration appears in the display.

Drying time can be selected in 10-minute increments from 20 minutes up to 2 hours.

5 Extra options/Select Delay

- Press button to select the following options:
Gentle, Buzzer, Delay options (see "Options/Delay").
Anti-Crease action always activates at program's end (see next page).

Please note: Delay is not possible in combination with the *Timed warm* and *Timed cold* programs.

Proper drying

⑥ Starting the program

The Start/Stop button flashes during program selection. This means that a program can be started.

- Press the *Start/Stop* button.

The *Start/Stop* button lights.

Drying appears in the display and the time remaining is counted down.

Before the end of a program

After the drying phase finished a cooldown phase follows.

The following programs have no cooldown phase: *Woolens*, *Smoothing*.

⑦ End of program - Remove laundry

0 and *End* appear in the display to indicate the program end. The buzzer sounds at intervals (when selected).

After the program end the drum rotates reversibly in intervals if clothes are not removed (Anti-crease action). This helps to prevent creasing for up to 2 hours.

- Press the *Door* button.
- Open the door.
- Remove the laundry.

Check that the drum is empty.
Laundry left behind may be damaged if dried again.

To save energy, the drum light turns off after a few minutes when the dryer is not operating and the door is open.

- To shut it off, press the *On/Off* button.
- Clean the lint filter and lint screens.
- Close the door.
- Empty the condensed water container (if the condensed water is not drained off externally).
- The condenser should be checked at intervals and cleaned as necessary (See the section on "Dryer Care").

Gentle

Delicate fabrics (with the  symbol on the care label, such as acrylics) must be dried at lower temperatures for longer durations.

On some programs *Gentle* is permanently set and cannot be deselected.

Buzzer

At the end of the program a buzzer sounds at intervals, for a maximum of 1 hour.

A continuous warning tone for fault messages sounds whether the buzzer is on or off.

Delay

With the Delay option, you can select a later program start time. Program start can be delayed by 30 minutes up to a maximum of 24 hours. This enables you, for instance, to take advantage of night electricity rates.

After program selection:

- Repeatedly press the *Delay* button until the required duration appears in the display.
- The *Delay* indicator light flashes.
- Times of up to *10h* are selected in 30-minute steps, more than *10h* in one-hour steps.
- If you keep the *Delay* button pressed in, the time will continue to increase up to *24h*.

Starting

- Press the *Start/Stop* button.
- The *Delay* indicator light comes on.

The Delay counts down to program start as follows:

- More than *10h*, in whole hours.
- Less than *10h*, in minutes.

The drum will turn briefly every hour to prevent creasing.

Canceling / altering Delay

- Press the *Start/Stop* button.

The Delay is cancelled.

- Repeatedly press the *Delay* button until the required duration appears in the display.
- Press the *Start/Stop* button.



The Delay resumes from the beginning.

Adding laundry



You can add laundry while the Delay is still counting down:

- Switch off the dryer.
- Open the door and add the laundry.
- Close the door and switch on the dryer.

Program Overview

Normal	
Extra dry, Normal	
Fabrics	Single- and multi-layered cotton such as: hand towels, T-shirts, baby clothes.
Note	<ul style="list-style-type: none"> – <i>Select Extra dry</i> for multi-layered and extra thick fabrics. – Do not use <i>Extra dry</i> to dry jersey fabrics like T-shirts and baby clothes - they may shrink.
Gentle	To be selected for delicate fabrics with the care symbol  .
Hand iron, Rotary iron	
Fabrics	Cotton or linen fabrics. For example: Table linens, bed linens, starched laundry.
Note	– You can keep laundry moist if you roll it up until ready to iron it.
Gentle	To be selected for delicate fabrics with the care symbol  .
Wrinkle-free	
Extra dry, Normal, Hand iron	
Fabrics	Easy-care fabrics in synthetics, cotton or blends. For example: sweaters, dresses, trousers, skirts, tablecloths.
Note	<ul style="list-style-type: none"> – To reduce creasing even more, select <i>Hand iron</i> and reduce the load to 1.5 kg*. – Fabrics are dried with low creasing with the <i>Hand iron</i> drying program, depending on fabric type and load.
Gentle	To be selected for delicate fabrics with the care symbol  .
Mixed	
Normal, Hand iron	
Fabrics	Delicate items made of synthetic fibres, blends or cottons such as shirts, blouses, lingerie, appliqué fabrics.
Gentle	Unavailable.

Program Overview

Woolens	
Fabrics	Woolens.
Note	– Remove items immediately after the end of the program while still slightly damp. Allow items to air dry.
Gentle	Unavailable.
Smoothing	
Fabrics	<ul style="list-style-type: none"> – Cotton or linen fabrics. – Synthetics, cotton or blends. For example: cotton trousers, jackets, shirts.
Note	<ul style="list-style-type: none"> – Program to reduce creases formed during spin cycle in washer. – Remove garments immediately the program ends and air-dry
Gentle	Unavailable.
Express	
Normal, Hand iron	
Fabrics	Mixed loads of fabrics for the <i>Normal</i> and <i>Wrinkle-free</i> programs.
Dress shirts	
Normal, Hand iron	
Fabrics	Shirts and blouses.
Gentle	To be selected for delicate fabrics with the care symbol  .
Denim / Jeans	
Normal, Hand iron	
Fabrics	Denim material like trousers, jackets, skirts or shirts.
Gentle	To be selected for delicate fabrics with the care symbol  .

Program Overview

Timed cold	
Fabrics	– Any fabric needing airing.
Timed warm	
Fabrics	– Additional drying of multi-layered garments which dry unevenly owing to their design: e.g., jackets, pillows and voluminous fabrics. – Drying individual laundry items: e.g. bath towels, bathing suits, dish cloths.
Note	To start with, do not select the longest time. Determine the most suitable time by trial.
Tip:	Use <i>Timed warm</i> to remove or reduce unwanted odors from clean cotton clothing (duration: 1/2-1 hour). The freshening effect is reinforced if you moisten the clothing or use a sheet of fabric conditioner before airing them. Odor reduction will be less for synthetics.
Gentle	To be selected for delicate fabrics with the care symbol  .

Changing the program sequence

Switching over from a running program

As a protection against unintentional changes, program selection is no longer possible.

To be able to choose a new program, you must cancel the current program.

- Canceling and selecting a new program

- Press the *Start/Stop* button.

The load will be cooled down for a few minutes, until a specific drying time and temperature have been reached.

If you press the *Start/Stop* button again, the drum stops, *End* appears in the display.

- Switch the dryer off.
- Then, switch it on again.
- Select and start a new program immediately.

- Interrupting a program and removing laundry

- See below: "Loading or removing laundry".
- Turn the dryer off after closing the door.

Loading or removing laundry

- Press the *Door* button.
- Open the door.

 Danger of burning:
Do not touch the back of the drum when adding or removing items. Temperatures in the drum area can be high.

- Add or remove laundry as needed.
- Close the door.
- Press the *Start/Stop* button.

Time remaining

When the program sequence is changed, the time remaining as shown by the display may differ from the actual drying time.

Electronic lock

The lock function protects your dryer against unauthorized use.

You can activate this function whenever you wish.

It locks the dryer's electronics. It can be turned on, but no program can be started.

- In such a case, the *Gentle* indicator light flashes and a key symbol  appears in the display.

The door may be opened at any time, as it is not locked.

Activating the lock

Precondition:

- The dryer is switched off.
 - The door is closed.
- ➊ Press the *Gentle* button and keep it pressed until Step ➋.
 - ➋ Press the *I-On/O-Off* button in.
- The *Express* indicator light comes on.
- ➌ Slowly turn the program selector step by step through three positions clockwise.
The three program indicator lights must light up in succession.

- ➍ Slowly turn the program selector step by step through three positions counterclockwise.
The three program indicator lights must light up in succession.

The *Gentle* indicator light flashes and the key symbol  appears in the display.

- ➎ Release the *Gentle* button.

The lock function has been activated.

- You may turn off the dryer.

Deactivating the lock

Precondition:

- The dryer is switched off.
 - The door is closed.
- The procedure is as for "Activating the Lock". Perform steps ➊ to ➍.

At step ➍ the indicator light for the *Gentle* button no longer flashes and the  key symbol goes out.

The lock function has been deactivated.

Emptying the condensed water container

Water separated from laundry by drying is collected in the condensed water container.

Empty the container after every drying program.

The *Container* indicator light comes on when the maximum water level in the container has been reached. It will go out when the door has been opened and closed again.

 Close the door completely. Otherwise, the door and the handgrip panel could be damaged when the container is pulled out.

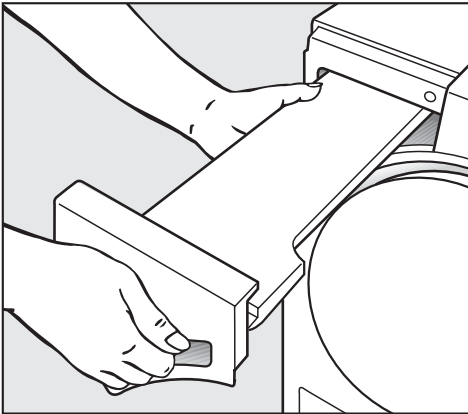

- Pull out the condensed water container.
- Carry the container levelly so that water does not pour out. Hold it by the handgrip panel and the end.

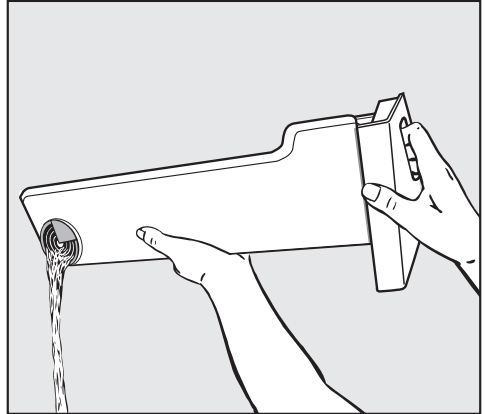

- Empty the condensed water container.
- Return it to the dryer.

 Do not drink condensed water! It could cause health problems for humans or pets.

You may use condensed water for household uses (for steam ironing, or for air humidifiers for instance). First pass the condensed water through a fine sieve or a coffee filter. The finest lint, which might otherwise cause damage, will be filtered from the water.

Cleaning and care

Cleaning the lint filtration components

The lint filter in the door casing and lint screens in the port-hole capture lint generated by the drying process. Clean them after **every** drying*.

Cleaning without water

Tip: You can dispose of the lint without touching it by using a vacuum cleaner.

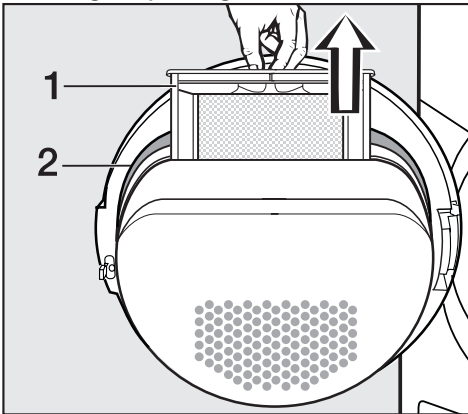

- Pull the door lint filter (1) out of the door casing.

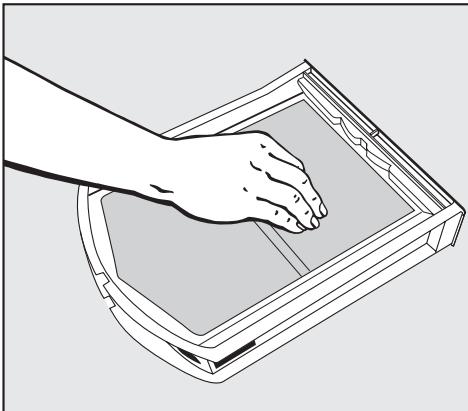

- Rub or vacuum the lint from the screen surface.

- Remove the lint from the space in the door casing with a bottle brush or the vacuum.
- Wipe the door casing seal (2) all around with a damp cloth.
- Insert the cleaned door lint filter fully into the door casing.

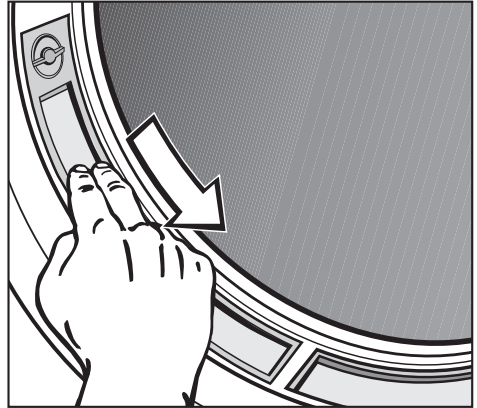

- Wipe or vacuum the lint from both lint screens in the port hole.
- Close the door.

* Also check the lint screens and door lint filter when the *Clean out airways* indicator light comes on.

Cleaning with water

The lint screens and door lint filter should be given a wet cleaning **only** when severely blocked or plugged.

- Open the door and extract the door lint filter from the door casing.

Remove both lint screens from the port-hole:

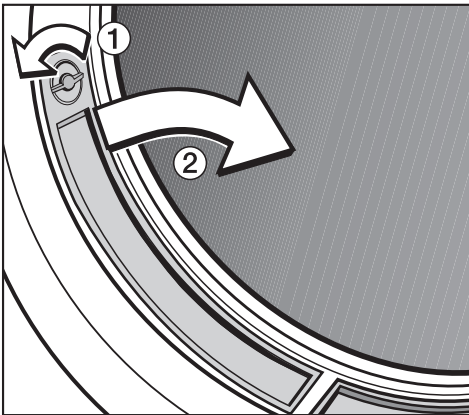

- Turn the left and right lint screen knobs ① (until you hear them click).
- Grasping the knobs, pull the lint screens out towards the centre ②.
- Clean all screens under running hot water.
- Shake the screens thoroughly until drips are no longer visible.
- Dry them thoroughly and with care.
- Also clean the air passages underneath the screens, using a vacuum cleaner, for example.

 When inserted, all lint screens must be dry. Wet screens can cause faulty dryer operation!

- Insert the door lint filter fully into the door casing.
- Insert the lint screens in the port-hole and push them downwards.
- Latch both knobs (until you hear them click).

Cleaning the dryer

Disconnect the dryer from the electrical supply.

- Clean the housing, control panel and door seal only with a slightly damp cloth and mild detergent or soapy water.
- Clean stainless steel parts (like the drum) with a suitable stainless steel cleaner.

Use no scouring products, cleaners containing solvents, or glass or all-purpose cleaners. They can damage plastic surfaces and other parts.

- Dry all parts with a soft cloth.

Cleaning and care

Cleaning the condenser (heat exchanger) unit

Detergent residue, hair and fine lint from the laundry can get through the lint screen and plug the condenser. Dust from the room taken in with the cooling air can also cause blockages.

Check the condenser at least twice a year and also if the *Filter/Vent* indicator light comes on. For frequent use, no later than approximately every 100 drying cycles. Clean it when necessary.

Removing the condenser unit

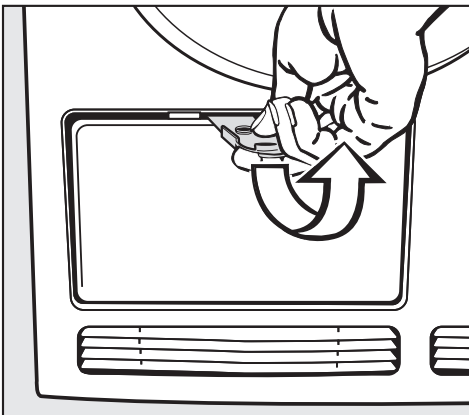

- Open the outer panel.
- Remove the panel by pulling it diagonally upwards and put it aside.

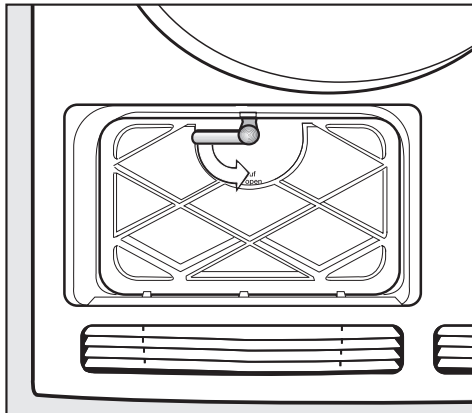

- Turn the locking lever on the inner cover downwards.
- Tilt the internal cover forwards.
- Remove it by pulling it diagonally upwards.

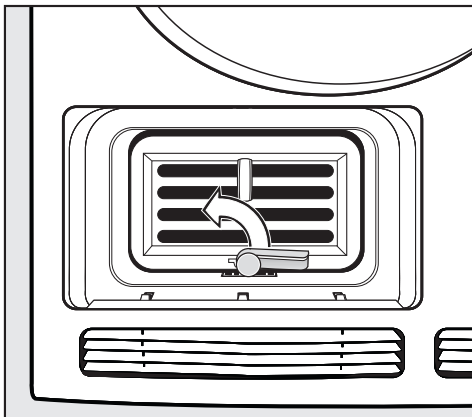

- Rotate the locking lever on the condenser upward (the locking lever hook disengages from the groove in the base).

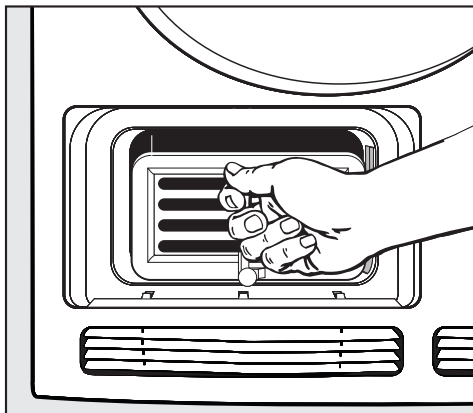

If no lint is visible:

- Replace the condenser unit (see the next page).

If lint is visible:

- Clean the condenser unit as described below.

Cleaning the condenser unit

- **When rinsing the condenser unit, be sure to position it as shown in the following two illustrations:**

- Pull the condenser by its handle out of its housing.

Checking the condenser unit

- Hold the condenser up to the light in two directions:

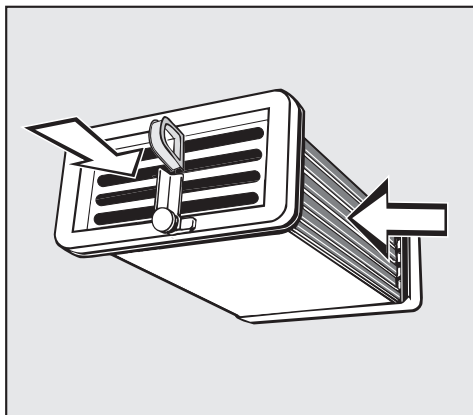

- Look to see whether there is lint inside it.
The arrows in the illustration above indicate where to look.

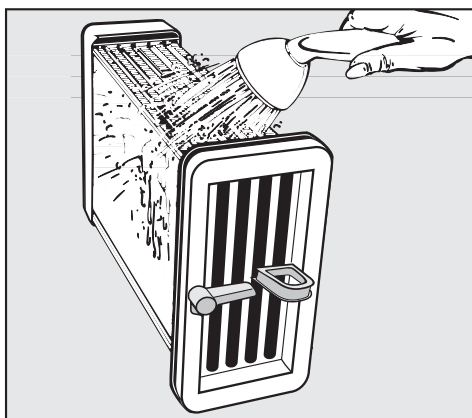

- Rinse the unit from the longitudinal side with a stream of water – as shown in the top illustration.

Cleaning and care



- Rinse the unit from the front with a stream of water.
- Check the condenser unit once more for visible fouling (see "Checking the Condenser Unit"). Rinse as often as necessary.
- Ensure that the condenser unit rubber seals are clean. Seals should not be removed and must be free of kinks.

Checking and cleaning the condenser unit housing

- Check the condenser unit housing inside the dryer for visible lint. Using a damp cloth, wipe it only from areas you can reach with your hand.

Replacing the condenser unit

- Push the condenser unit **fully** (to the stop) back into its housing.
The handle of the unit must be on top, the locking lever down.
- Rotate the locking lever into the horizontal position so that its hooks clearly **latch down into the groove in the base of the housing.**

When replacing the inner cover, ensure that the rubber seal is correctly seated in its groove.

- Locate the inner cover so that its latching hooks are down. While doing so, hold it at an angle and push it gently downwards.
- Push against the cover and latch it with its locking lever. After latching, the locking lever must be horizontal.
- Insert the bottom of the external panel and press until the upper edge latches into position.

 Only a correctly inserted and latched condenser unit will ensure the watertightness of the system!

What to do, if . . . ?

You can remedy most problems yourself. In many cases you can save time and expense, since you will not have to call in customer service.

The following tips should help you locate and remedy the cause of a problem. However, please note the following:

 Repairs to electrical appliances should only be carried out by qualified professionals. Work performed by unqualified persons can place the user at considerable risk.

Test and fault messages.

Problem	Cause	Solution
Cancelling a program ⏏ and Finish appear in the display The buzzer sounds.	This is not a fault. The electronics recognizes that there is no laundry in the drum and cancels the program. Drying of single or already dried laundry items can also lead to program cancellation.	In future, dry individual laundry items with the warm air program. Cancelling test message: – Open and close door
⏏ appears in the display. Gentle indicator light flashes.	The lock function has been activated.	If you wish to dry, you must disable the lock function (see "Electronic lock function").
Canceling a program The buzzer sounds. Flashing display may show Cold air or Finish.	The cause is not immediately obvious.	– Switch the dryer off and then on again. – Start a program. If program interruption and error message occur, a fault is present. Contact Miele customer service.

Trouble shooting

Problem	Cause	Solution
<p>Filter/Vent indicator light goes on.</p>	<p>The indicator light shows that the dryer is not operating at its most efficient or economical.</p> <p>Possible causes: Blockage by lint or detergent residues.</p>	<ul style="list-style-type: none"> - As a rule, it is sufficient to clean the lint screens and door filter. Should that not be sufficient, then check all possible causes listed under "The drying cycle goes on too long or even switches off." <p>Canceling test message:</p> <ul style="list-style-type: none"> - Open and close door
		<p>You can deactivate the <i>Filter/Vent</i> indicator light (see section on "Programmable functions").</p>
<p>Canceling a program Filter/Vent indicator light goes on.</p>	<p>Possible causes and remedies are described above.</p>	<p>Canceling the fault message:</p> <ul style="list-style-type: none"> - Open and close door - Start a program. - If the fault message comes back, call Customer Service.
<p>Container indicator light goes on. The buzzer sounds.</p>	<p>The condensed water container is full or there is a kink in the drain hose.</p>	<ul style="list-style-type: none"> - Empty the condensed water container. - Check the drain hose. <p>Canceling test message:</p> <ul style="list-style-type: none"> - Open and close door

Other problems		
Problem	Cause	Solution
<p>The drying process goes on too long or even switches off. Even after the lint screen is cleaned, the <i>Filter/Vent</i> indicator come on.</p>	<p>Please check all possible causes and switch the dryer off and then on again.</p>	
	<p>Insufficient ventilation, perhaps because the installation space is too small. As a result, room temperature may rise.</p>	<p>Open the door or window, to prevent room temperature from rising.</p>
	<p>The ventilation inlets beneath the door are closed.</p>	<p>– Remove the blocking objects.</p>
	<p>Lint screens are plugged with lint or have been put back wet after cleaning.</p>	<p>– Remove the lint. – Lint screens must be dry.</p>
	<p>Detergent residues, hair and fine lint may block the condenser.</p>	<p>Inspect and clean the condenser from time to time.</p>
	<p>Laundry was insufficiently spun.</p>	<p>In future, spin textiles in the washer at a higher rpm.</p>
	<p>The dryer is overloaded.</p>	<p>Verify the maximum load for each drying program.</p>
<p>Metal components such as zippers have prevented the moisture level of the laundry from being determined accurately.</p>	<p>– In future, open the zippers. If the problem recurs, in future dry garments with long zippers using the Warm air program.</p>	
<p>The laundry was not satisfactorily dried.</p>	<p>The load consists of various fabrics.</p>	<p>– Re-dry with warm air. – Next time, select a suitable program.</p>

Trouble shooting

Problem	Cause	Solution
Water runs from the dryer after the condenser has been cleaned:	<ul style="list-style-type: none">- The condenser inner cover and/or the condenser have not been properly inserted and latched.- Lint is sticking in the condenser housing recess.	<ul style="list-style-type: none">- Verify that the internal cover and the condenser are correctly and solidly seated.- Check their rubber seals as well.- Using a cloth, remove all visible lint from the heat exchanger recess.
Synthetic laundry items are statically charged after drying.	Synthetics have a tendency to static discharges.	Using a fabric softener in the last rinse cycle can reduce static charge when drying.
There has been a lint buildup.	Drying releases fabric lint formed primarily from rubbing during wear but also, in part, from washing. The stress on fabrics in the dryer is minimal in relation to their strength.	Lint released is captured in the lint screen and can be easily removed (see "Care and Cleaning").

Trouble shooting

Problem	Cause	Solution
<p>The Dress shirts, Denim/Jeans, and Timed cold programs will not start and the indicator lights for these programs do not come on.</p>	<p>The cause is not immediately obvious.</p>	<ul style="list-style-type: none"> – Switch the dryer off and then on again. – Select one of the programs. – If the program will still not start, there is a fault. Contact Miele customer service. – Meanwhile, use another program.
<p>The dryer will not start when switched on.</p>	<p>The cause is not immediately obvious.</p>	<ul style="list-style-type: none"> – Is the dryer switched on? – Is it plugged in? – Is the door closed? – Check fuses or circuit breakers.
<p>Drum lighting does not come on.</p>	<p>The lighting switches off automatically to save energy.</p>	<p>Switch the dryer off and on again.</p>
	<p>The bulb may need changing.</p>	<p>You can replace the bulb: See the end of this section.</p>

Trouble shooting

Replacing the light bulb

Disconnect the dryer from the electrical supply.

- Open the door.

The hinged cover for the lighting is over the port-hole.

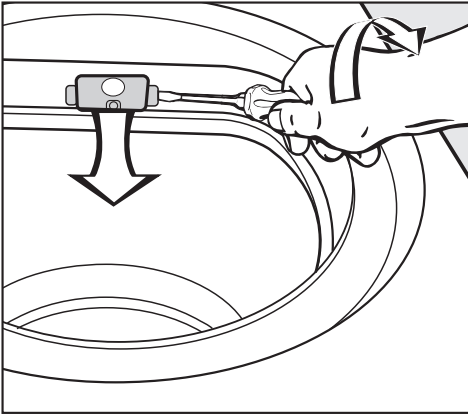

- Gently insert an ordinary tool* under the side of the cover.

* such as a wide slot-type screwdriver

- Open the cover by pressing lightly while rotating your wrist.

The cover opens downwards.

The heat-resistant bulb should be obtained only from Miele customer service.

The bulb should be of the same type and maximum wattage indicated on the data plate and the lighting cover.

- Replace the bulb.
- Fold the cover upwards and press it on the right and left until you hear it latch.

⚠ Ensure that the cover is properly seated. If moisture gets inside it may cause a short-circuit.

Repairs

For faults you cannot correct yourself, please contact:

- the Miele Factory Repair Service.

The telephone number for the Factory Repair Service is listed at the back of these operating instructions.

When contacting the Miele Service Department, you will need to quote the model and serial number of your appliance.

These can be found on the data plate, visible when the door is open.

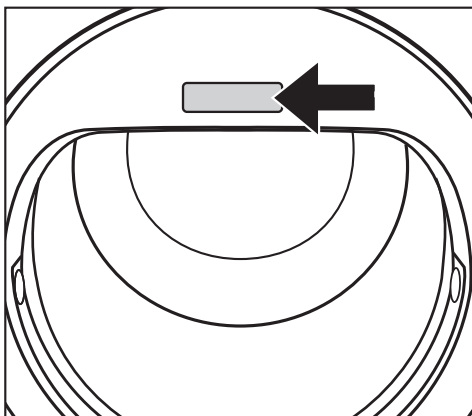

Program updates

The **PC** optical interface is used by Miele customer service to transfer program updates (PC = Program Correction) as well as for diagnose and testing.

In this way, future developments in fabrics and in the drying procedure can be integrated into your appliance.

Miele will give timely notification of Program updates.

Warranty conditions and warranty period

Warranty information can be found in your warranty booklet.

Optional accessories

Optional accessories for this dryer are available from Miele customer service.

Installation and connection

Front view

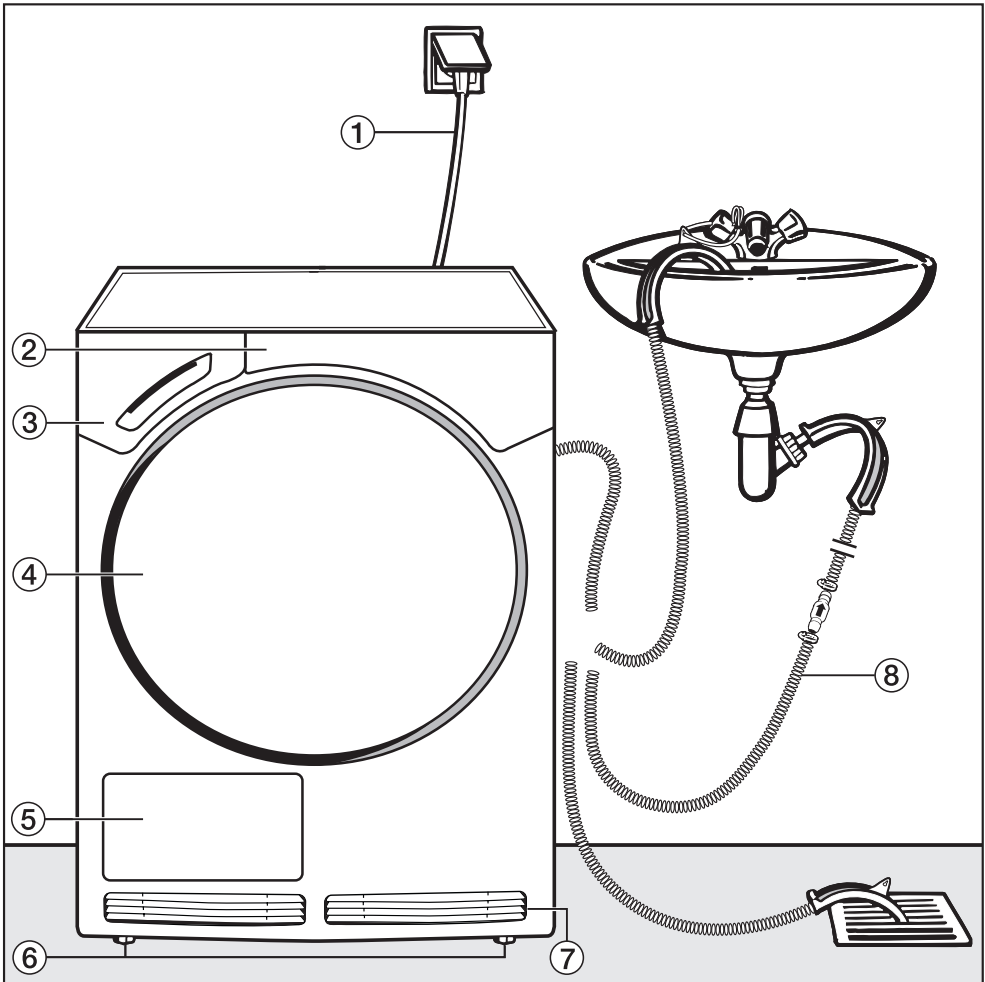

- ① Power cord
- ② Control panel
- ③ Condensed water container
- ④ Door
- ⑤ Condenser service access
- ⑥ Four height-adjustable screw feet
- ⑦ Air inlet and outlet vents for cooling condenser unit
- ⑧ Condensed water drain hose (see section "Draining condensed water externally")

Rear view

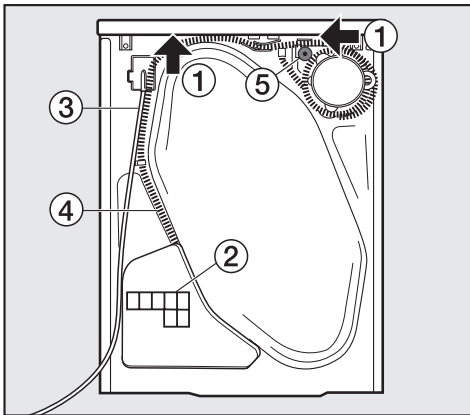

- ① Handgrips under the cover overhang for moving the appliance (arrows)
- ② Air inlet vent for cooling condenser unit
- ③ Power cord
- ④ Condensed water drainage hose
- ⑤ Accessories for connection to a sink drain outlet

Installation site

This dryer can be accommodated under a worktop if there is sufficient height.

⚠ Do not install the dryer in a location where its door could conflict with room doors.

⚠ The appliance top is not removable.

Carrying the dryer to the installation site

The rear cover overhang provides handgrips for transport. To carry the dryer from the packing base to the installation site, use the appliance front feet and the rear cover overhang.

Washer-dryer stack

The dryer can be combined with a Miele automatic washer in a washer-dryer stack. For this, a "WTV 412" stacking unit* is required.

* Miele accessory available on order

⚠ Installation of the stacking unit may be performed only by an authorized Miele technician.

Installation and connection

Leveling the dryer

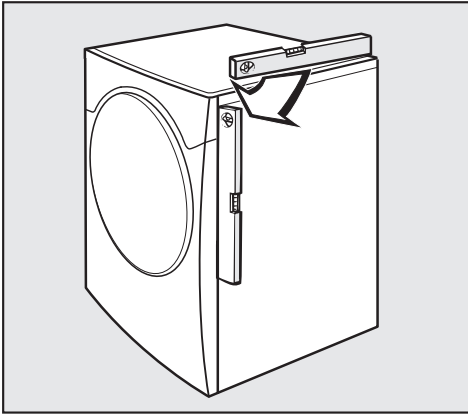

⚠ Do not block the gap between the bottom of the tumble dryer and the floor with plinth facings, deep pile carpet etc. This would hinder a sufficient flow of air to the dryer.

⚠ The air inlet/outlet vents on the front and back must NEVER be covered. Otherwise, sufficient condenser cooling cannot be ensured.

To ensure trouble-free operation, the dryer must be level.

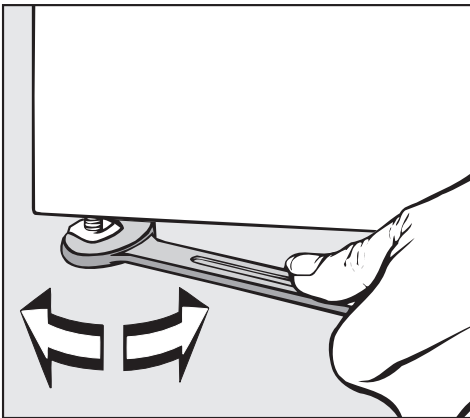

- Compensate for floor irregularities by turning the threaded feet in or out.

Ventilating the installation area

Function of Miele condenser dryer:
The condenser dryer separates the mixture of water and laundry (the wet load) into water and dry laundry itself.

The water is heated / evaporated, then condensed and collected into condensed water container.

The remaining dry laundry remains in the drum.

Operation of Miele condenser dryer:

The dryer circulates some air (trapped with wet laundry inside a reversibly rotating drum) via lint filters, heat exchanger and heaters, in a closed loop.

The heat exchanger (condenser) needs cooling, so the dryer circulates also ambient air, through separate channels across heat exchanger, in an open loop. (these two loops do not mix).

Returning ambient air warms up the room with dry heat.

Practically all energy, taken from the electrical wall outlet, remains in the room as dry heat.

You must therefore take measures, especially in small rooms, to provide sufficient ventilation, by opening windows for instance. Otherwise, longer running times may be expected.

Before transport at a later date

After every drying, a small quantity of condensed water will collect in the pump area. This condensed water can leak out when the dryer is tipped. We therefore recommend starting the Timed cold program for about one minute before transport. Residual condensed water will be drained into the condensed water container or out through the drain hose.

Installation and connection

Draining condensed water externally

General

When drying is in progress, the condensed water is pumped into the condensed water container through the drain hose at the back of the dryer. You can also drain it off externally through the drain hose - you will no longer need to empty the condensed water container.

Hose length 1.50 m
Max. delivery height 1.50 m
Max. delivery length 4.00 m

 Under special kinds of connection conditions, this dryer must be fitted with a non-return valve (see following pages).

The following optional accessories are available:

- an extension hose.
- a non-return valve kit for conversion to an external water outlet (includes an extension hose).
Max. delivery head with non-return valve fitted: 1.00 m

Arranging the drain hose

 Do not pull on the drain hose, stretch it or kink it, as it could get damaged!

- There will be a small amount of residual water in the drain hose. Have a container ready to collect it.

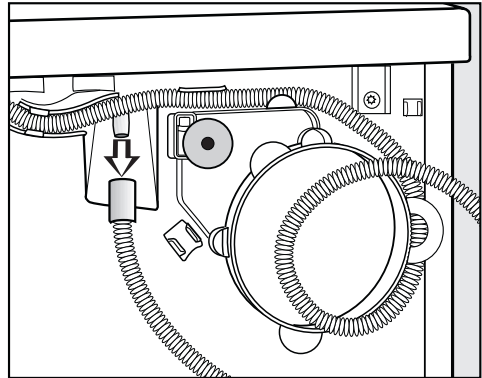

- Pull the drain hose off its connection.
- Allow any residual water to run into the container.
- Unwind the hose from its coil and pull it carefully out of the holders.

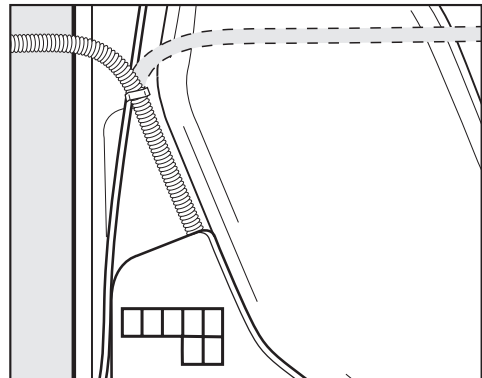

- Guide the hose to the right or left side of the dryer, as necessary.
- Leave the hose in the central holder to prevent it from being inadvertently kinked.

Hooking up the drain hose (in sink or floor drain)

- See front view illustration.

⚠ If you decide to hook the hose up to a sink, secure it against being detached, by clamping it, for example. Otherwise overflowing water can cause damage.

- Use the bow-shaped holder to prevent the drain hose from becoming kinked.

Special installation conditions requiring a non-return valve

⚠ Under special connection conditions, a **non-return valve (kit available) for external water disposal** (optional accessory) must be used. This will prevent the back-flow of water into the dryer and possible damage.

Such special conditions include:

- Connection to a sink drain outlet (see following section).
- Various kinds of connection, to which an automatic washer or dishwasher **already in use** are also connected.

Example: Connection to a sink drain outlet

The drain hose with non-return valve can be connected directly to a special sink drain outlet.

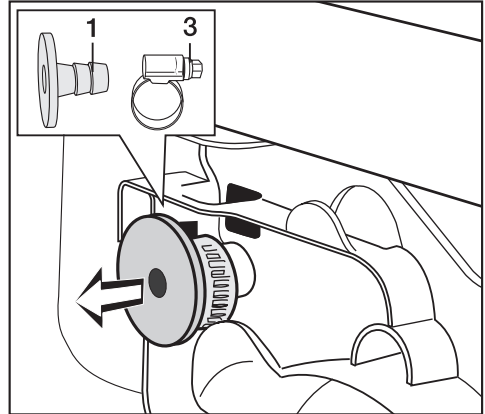

- Remove the accessories from the top of the rear side of the dryer: Adapter **1** and the hose clip **3** behind it.

Installation and connection

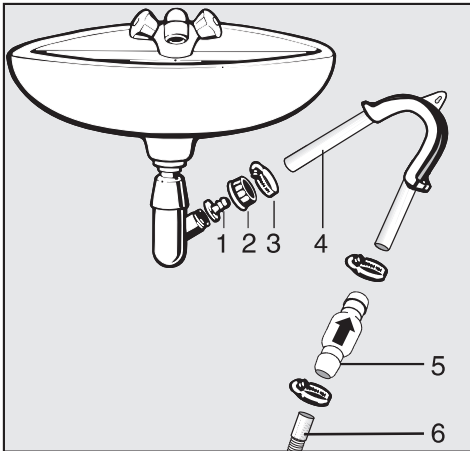

- 1 Adapter
- 2 Sink coupling nut
- 3 Hose clip
- 4 End of hose
- 5 Non-return valve
- 6 Dryer drain hose

- Fit the adapter to the sink drain outlet **1** with the sink coupling nut **2**.

Usually the sink coupling nut has a flat washer, which you must remove.

- Fit the end of the hose **4** to the adapter **1**.
- Using a screwdriver, tighten the hose clip **3** directly behind the sink coupling nut.

! Install the non-return valve **5** so that the arrow points in the direction of flow (towards the sink). Otherwise, pumping out will be impossible.

- Insert the non-return valve **5** into the dryer drain hose **6** (make sure it is connected in the right direction, check the arrow on the non-return valve!).
- Attach the non-return valve using the hose clips.

Electrical connections

GROUNDING INSTRUCTIONS

This appliance must be grounded. In the event of malfunction or breakdown, grounding will reduce the risk of electric shock by providing a path of least resistance for electric current. This appliance is equipped with a cord having an equipment grounding conductor and a grounding plug. The plug must be plugged into an appropriate outlet that is properly installed and grounded in accordance with all local codes and ordinances.

WARNING – Improper connection of the equipment grounding conductor can result in a risk of electric shock. Check with a qualified electrician or service representative or personnel if you are in doubt as to whether the appliance is properly grounded.

Do not modify the plug provided with the appliance! If it will not fit the outlet, have a proper outlet installed by a qualified electrician.

The dryer comes with a 5 ft long, 12/4 AWG cord and a NEMA 14-30 P plug.

It should be connected to a 120/208-240 V, 30 A, 60 Hz AC power supply. A 3 pole-4 wire grounding power outlet (NEMA type 14-30 R) is necessary.

The dryer is equipped with a power cable and plug ready for connection.

The plug must always be accessible to facilitate disconnecting the dryer from the electrical supply.

To eliminate a potential fire source, the dryer should NEVER be connected by means of extension cords, or by multi-outlet power strips or the like.

The appliance data plate indicates the nominal power consumption and the appropriate fuse capacity. Please compare the information on the data plate with the electrical network data.

Technical data

Height	850 mm
Width	595 mm
Depth	634 mm
Depth with door open	1074 mm
Can be pushed under a worktop	Yes
– Height	850 mm
– Width	600 mm
Suitable for stacking	Yes
Weight	52 kg
Drum Volume	111 liters
Volume of condensed water container	approx. 3.5 liters
Hose length	1.50 m
Maximum delivery head	1.50 m
Maximum delivery length	4.00 m
Length of power cord	2.00 m
Voltage] see data plate
Connected load (Watts)	
Rated current (Amps)	
Light bulb wattage	
Test certifications granted	

Programmable functions for changing standard values

As needed, you can use programmable functions to adapt the dryer electronics to changing requirements.

You can alter programmable functions at any time.

Programmable functions

Extending the range of drying levels

You can extend the range of the drying levels for many of the programs:

Rotary iron+

(drier than Rotary Iron).

Hand iron+

(drier than Hand iron).

Normal +

(drier than Normal).

Additionally, the *Extra dry level* can be selected for the *Mixed* and *Denim Jeans* programs.

This programmable function is also effective in the following programs:

Normal, *Wrinkle free**, *Mixed**, *Express*, *Denim/Jeans*
(* no Rotary iron+).

For programming and saving in the memory, follow steps ❶ to ❺.

The programmable function is programmed using the buttons.

Precondition:

– The dryer is switched off.

– The door is closed.

❶ Press *Start/Stop* and keep it pressed it during steps ❷-❸.

❷ Press the *I-On/O-Off* button in.

Wait until the *Start/Stop* button lights up continuously . . .

❸ . . . then release the *Start/Stop* button.

– The *Gentle* indicator light flashes twice briefly.

– *P* and *D* flash alternatively in the display (default setting).

The number appearing alternatively with *P* means:

D Default setting

I Drying range steps added

(*Express* indicator light also flashes)

❹ Pressing the *Start/Stop* button switches from one to the other.

❺ Using the *I-On/O-Off* button, switch the dryer off.

The programming is now stored in memory. You can change it again at any time.

To select the extended drying level:

■ Select a program.

■ Press the drying level button repeatedly until one or two indicator lights come on.

– Indicator lights *Extra dry* and *Normal* = Normal+

– Indicator lights *Normal* and *Hand iron* = Hand iron+

– Indicator lights *Hand iron* and *Rotary iron* = Rotary iron+

Adjusting buzzer volume

The buzzer has two volumes.

For programming and saving in memory, follow steps ❶ to ❺.

This function is programmed using the buttons.

Precondition:

- The dryer is switched off.
- The door is closed.
- ❶ Press *Start/Stop* and keep it pressed it during steps ❷–❸.
- ❷ Press the *I-On/O-Off* button in.

Wait until the *Start/Stop* button lights up continuously . . .

- ❸ . . . then release the *Start/Stop* button.
- ❹ Press the *Gentle* button once.
- The *Gentle* indicator light flashes briefly four times.
- *P* and *I* flash alternately in the display (default setting).

The number appearing alternately with *P* means:

I **Buzzer normal**
(default setting)

I **Buzzer loud**
(*Express* indicator light also flashes)

- ❺ Pressing the *Start/Stop* button switches from one number to the other, and you simultaneously hear the buzzer setting.
- ❻ Using the *I-On/O-Off* button, switch the dryer off.

The programming is now stored in memory. You can change it again at any time.

Programmable functions

Set memory function

The electronics memorizes any selected program with extra options. The duration of a *Smoothing* program will also be stored in memory. These settings will be used for the next drying. They can be accepted, or changed by using the buttons.

For programming and saving in memory, follow steps ❶ to ❺.

The programmable function is programmed using the buttons.

Precondition:

- The dryer is switched off.
- The door is closed.
- ❶ Press *Start/Stop* and keep it pressed it during steps ❷–❸.
- ❷ Press the *I-On/O-Off* button in.

Wait until the *Start/Stop* button lights up continuously . . .

- ❸ . . . then release the *Start/Stop* button.
- ❹ Press the *Gentle* button twice.
 - The *Gentle* indicator light flashes briefly six times.
 - *P* and *D* flash alternately in the display (default setting).

The number appearing alternately with *P* means:

- I* **Memory**
(*Express* indicator light also flashes)
- D* **no Memory**
(default setting)
- ❺ Pressing the *Start/Stop* button switches from one to the other.
- ❻ Using the *I-On/O-Off* button, switch the dryer off.

The programming is now stored in memory. You can change it again at any time.

Extending cooldown time

You can individually lengthen the cooldown phase the occurs before the end of a program. Fabrics will be more completely cooled down.

Cooldown time

- can be extended by two stages.
- it does not function for *Smoothing* programme.

For programming and saving in memory, follow steps ❶ to ❺.

The programmable function is programmed using the buttons.

Precondition:

- The dryer is switched off.
 - The door is closed.
- ❶ Press *Start/Stop* and keep it pressed it during steps ❷–❸.
 - ❷ Press the *I-On/O-Off* button in.

Wait until the *Start/Stop* button lights up continuously . . .

- ❸ . . . then release the *Start/Stop* button.
 - ❹ Press the *Gentle* button three times.
- The *Gentle* indicator light flashes briefly seven times.
 - *P* and *D* flash alternatingly in the display (default setting).

The number appearing alternatingly with *P* means:

D Default setting

1 **Five minutes longer cooldown time**
(*Express* indicator light will flash once)

2 **Ten minutes longer cooldown time**
(*Express* indicator light will also flash twice)

❺ Pressing the *Start/Stop* button switches from one to the other.

❻ Using the *I-On/O-Off* button, switch the dryer off.

The programming is now stored in memory. You can change it again at any time.

Programmable functions

Change function of Filter/Vent indication

Lint should be removed after drying. At the same time, the *Filter/Vent* indicator light reminds you to do so as soon as a certain degree of lint has accumulated. You can yourself decide which degree of lint accumulation will trigger that reminder.

Determine by trial and error which of the four options responds to your drying practices.

For programming and saving in memory, follow steps ❶ to ❺.

The programmable function is programmed using the buttons.

Precondition:

- The dryer is switched off.
- The door is closed.

❶ Press *Start/Stop* and keep it pressed it during steps ❷-❸.

❷ Press the *I-On/O-Off* button in.

Wait until the *Start/Stop* button lights up continuously . . .

❸ . . . then release the *Start/Stop* button.

❹ Press the *Gentle* button four times.

- The *Gentle* indicator light flashes once slowly.
- *P* and *Z* flash alternately in the display (default setting).

The number appearing alternately with *P* means:

❶ **The *Filter/Vent* indicator is deactivated**

❷ **The *Filter/Vent* indicator comes on only when there is a heavy lint buildup**

(*Express* control light additionally flashes once)

❸ **default setting**

(the *Express* indicator light also flashes twice)

❹ **The *Filter/Vent* indicator will come on when there is only a light lint buildup**

(The *Express* indicator light also flashes three times)

❺ Pressing the *Start/Stop* button switches from one to the other.

❻ Using the *I-On/O-Off* button, switch the dryer off.

The programming is now stored in memory. You can change it again at any time.

Adjust keypad tone

An audible tone sounds every time a button is pressed.

For programming and saving in memory, follow steps ① to ⑤.

The programmable function is programmed using the buttons.

Precondition:

- The dryer is switched off.
- The door is closed.

- ① Press *Start/Stop* and keep it pressed it during steps ②-③.
- ② Press the *I-On/O-Off* button in.

Wait until the *Start/Stop* button lights up continuously . . .

- ③ . . . then release the *Start/Stop* button.
- ④ Press the *Gentle* button five times.
 - The *Gentle* indicator light flashes once slowly and once briefly.
 - *P* and *0* flash alternately in the display (default setting).

The number appearing alternately with *P* means:

0 **no Keypad tone**
(default setting)

1 **Keypad tone on**
(*Express* indicator light also flashes)

- ⑤ Pressing the *Start/Stop* button switches from one to the other.
- ⑥ Using the *I-On/O-Off* button, switch the dryer off.

The programming is now stored in memory. You can change it again at any time.

Programmable functions

Changing water conductivity setting

 This programmable function should be adjusted only when residual water content is erroneously determined owing to the extreme softness of the water.

Important condition

The water in which fabrics are washed may be extremely soft with a conductivity value less than 150 $\mu\text{S}/\text{cm}$. Drinking water conductivity can be ascertained from your local water supplier.

Activate this programmable function only if the above-mentioned condition applies. Otherwise the drying result will be unsatisfactory.

For programming and saving in memory, follow steps ① to ⑤.

The function is programmed using the buttons.

Precondition:

- The dryer is switched off.
- The door is closed.

① Press *Start/Stop* and keep it pressed it during steps ②-③.

② Press the *I-On/O-Off* button in.

Wait until the *Start/Stop* button lights up continuously . . .

③ . . . then release the *Start/Stop* button.

④ Press the *Gentle* button six times.

- The *Gentle* indicator light flashes once slowly and twice briefly.
- *P* and *D* flash alternately in the display (default setting).

The number appearing alternately with *P* means:

D Default setting

I Lower conductivity setting

(*Express* indicator light also flashes)

⑤ Pressing the *Start/Stop* button switches from one to the other.

⑥ Using the *I-On/O-Off* button, switch the dryer off.

The programming is now stored in memory. You can change it again at any time.



Miele Limited

Headquarters and Showroom

161 Four Valley Drive

Vaughan, ON L4K 4V8

Phone: 800-643-5381

905-660-9936

Fax: 905-532-2290

www.miele.ca

professional@miele.ca (commercial enquiries)

MieleCare National Service

Phone: 800-565-6435

905-532-2272

Fax: 905-532-2292

customercare@miele.ca (general and technical enquiries)



Free Manuals Download Website

<http://myh66.com>

<http://usermanuals.us>

<http://www.somanuals.com>

<http://www.4manuals.cc>

<http://www.manual-lib.com>

<http://www.404manual.com>

<http://www.luxmanual.com>

<http://aubethermostatmanual.com>

Golf course search by state

<http://golfingnear.com>

Email search by domain

<http://emailbydomain.com>

Auto manuals search

<http://auto.somanuals.com>

TV manuals search

<http://tv.somanuals.com>