

Miele

Operating and installation instructions



Compact oven H 5040 B





To avoid the risk of accidents or damage to the appliance it is **essential** to read these instructions before it is installed and used for the first time.

en - GB

M.-Nr. 07 959 840

Warning and Safety instructions	6
Caring for the environment	11
Guide to the appliance	12
H 5040 B	12
Features	13
Oven controls	13
Safety features	13
System lock	13
Safety switch-off	13
Cooling system	13
Vented oven door	13
PerfectClean treated surfaces	14
Catalytic enamelled surface	14
Energy saving features	14
Time of day display	14
Energy efficiency rating according to EN 50304	14
Accessories	14
Baking tray, universal tray and rack	15
Anti-splash insert (depending on model)	15
Handle (depending on model)	15
Controls	16
Function selector	16
Temperature selector	17
Sensors	17
Symbols in the display	18
Triangle ▲ in the display	19
Functions	20
Before using for the first time	22
To set the time of day for the first time	22
Changing the time of day	22
Cleaning and heating up for the first time	23
Operation	24
Using the oven	24
Cooling system	24
Recommended temperature	24
Changing the temperature	25
Temperature indicator	25

Contents

Pre-heating	25
Switching on and off automatically	26
Entering a cooking duration	26
Entering a cooking duration and delaying the finish time	27
The end of a cooking programme	28
To check and change an entered time.	28
To delete an entered time.	28
Minute minder (egg timer)	29
 Settings	30
To change the "status" of a setting	31
System lock	32
Baking tips	33
Bakeware	33
Baking parchment	33
Universal tray	33
Rectangular tins	33
Notes about the charts	34
Temperature, baking duration	34
Shelf levels	34
Frozen food	34
Baking chart	35
Fan plus 	35
Conventional heat 	36
Intensive bake 	37
Roasting tips	38
Useful tips	39
Browning	39
Standing time	39
Roasting poultry	39
Frozen meat	39
Roasting chart	40
Notes on Slow cooking	41
Proceed as follows:	41
Cooking duration/Core temperatures	42
Grilling tips	43
Preparing food for grilling	45
Grilling	45

Useful tips	45
Grilling chart	46
Defrost	47
Cooking ready meals	48
Cleaning and care	49
Appliance front	49
Accessories	50
Baking tray, universal tray, anti-splash insert (if applicable)	50
Rack, runners	50
Oven interior	50
Seal and inside of the oven door	50
PerfectClean	51
Catalytic enamel surfaces	53
To remove the oven door	54
To dismantle the oven door	55
To refit the door	58
To remove the runners	59
To remove the catalytic enamelled back panel and roof liner	59
Back panel	59
Roof liner	60
Problem solving guide	61
After sales service	63
Optional accessories	64
Electrical connection	66
Building-in diagrams	67
Appliance dimensions and unit cut-out	67
Front dimensions	68
Installing the oven	69

Warning and Safety instructions

This appliance conforms to current safety requirements. Inappropriate use can, however, lead to personal injury and damage to property.

To avoid the risk of accidents and damage to the appliance, please read these instructions carefully before using it for the first time. They contain important notes on installation, safety, use and maintenance.

Keep these instructions in a safe place and ensure that new users are familiar with the content. Pass them on to any future owner.

Correct application

► This oven is not designed for commercial use. It is intended for use in domestic households and for use in similar working and residential environments such as:

- Shops
- Offices and showrooms

and by residents in establishments such as:

- Hostels and guest houses

► It is intended for domestic use only to cook food, and in particular to bake, roast, grill, defrost and dry food.

Any other use is not supported by the manufacturer and could be dangerous. Miele cannot be held liable for damage resulting from incorrect or improper use or operation of the appliance.

► This appliance is not intended for use by persons (including children) with reduced physical, sensory or mental capabilities, or lack of experience and knowledge, unless they are supervised whilst using it, or have been shown how to use it correctly by a person responsible for their safety.

Warning and Safety instructions

Safety with children

▶ This appliance is not a toy! To prevent the risk of injury or damage, do not let children play with the appliance or its controls.

▶ Older children may only use the oven when its operation has been clearly explained to them and they are able to use it safely, recognising the dangers of misuse.

▶ Great care should be taken to ensure that children do not touch the appliance when it is being used. Children's skin is far more sensitive to high temperatures than that of adults. External parts of the oven such as the door glass, control panel and the vent become quite hot.

Technical safety

▶ Installation, maintenance and repairs may only be carried out by a suitably qualified and competent person in strict accordance with current national and local safety regulations. Repairs and other work by unqualified persons could be dangerous. The manufacturer cannot be held liable for unauthorised work.

▶ Before installation, check the appliance for visible signs of damage. Do not install and use a damaged appliance. A damaged appliance could be dangerous.

▶ The electrical safety of this appliance can only be guaranteed when continuity is complete between it and an effective earthing system. It is most important that this basic safety requirement is present and tested regularly, and where there is any doubt the household wiring system should be inspected by a qualified electrician. The manufacturer cannot be held liable for the consequences of an inadequate earthing system (e.g. electric shock).

Warning and Safety instructions

▶ Before connecting the appliance, make sure that the connection data on the data plate (voltage and connected load) match the mains electricity supply.

This data must correspond in order to avoid the risk of damage to the appliance. Consult a competent person if in doubt.

▶ Do not connect the appliance to the mains electricity supply by a multi-socket unit or an extension lead. These do not guarantee the required safety of the appliance (e.g. danger of overheating).

▶ For safety reasons, this appliance may only be used when it has been built in.

▶ Never open the housing of the appliance.

Tampering with electrical connections or components and mechanical parts is highly dangerous to the user and can cause operational faults.

▶ While the appliance is under guarantee, repairs should only be undertaken by a service technician authorised by the manufacturer. Otherwise the guarantee will be invalidated.

▶ During installation, maintenance and repair work, the appliance must be disconnected from the mains electricity supply. It is only completely isolated from the electricity supply when:

- the mains fuse is disconnected,
- the screw-out fuse is removed (in countries where this is applicable),
- it is switched off at the isolator.

Ensure that current is not supplied to the appliance until after maintenance or repair work has been carried out.

▶ Faulty components must only be replaced by genuine Miele original spare parts. The manufacturer can only guarantee the safety of the appliance when Miele replacement parts are used.

▶ If the supply cord is damaged, it must be replaced by a Miele approved service technician to avoid a hazard.

▶ This appliance may only be used in mobile installations such as ships if a risk assessment of the installation has been carried out by a suitably qualified engineer.

▶ In countries where there are areas which may be subject to infestation by cockroaches or other vermin, pay particular attention to keeping the appliance and its surroundings in a clean condition at all times. Any damage which may be caused by cockroaches or other vermin will not be covered by the guarantee.



Warning and Safety instructions





Correct use

Caution. Danger of burning.
High temperatures are produced by the oven.

► Use oven gloves when placing food in the oven, turning or removing it and when adjusting oven shelves etc. in a hot oven. Be very careful that you do not burn yourself on the top heating / grill element.

► Never leave the appliance unattended when cooking with oil or fats, as these are a fire hazard if allowed to overheat.

► Do not exceed the recommended grilling times when using the "Full grill , "Economy grill " and "Fan grill " functions. Excessively long grilling times can lead to food drying out and burning, or could even cause it to catch fire.

► Do not use the "Full grill , "Economy grill " or "Fan grill " to finish baking part-cooked rolls or bread or to dry flowers or herbs. Fire hazard. Use "Fan plus " or "Conventional heat " instead.





► If using alcohol in your recipes, high temperatures can cause the alcohol to vaporise and even to ignite on the hot heating elements.

Alcohol should be burnt off before the dish is placed in the oven to avoid this danger.

► Cover any food which is left in the oven to be kept hot. Any moisture in the food could lead to corrosion damage in the oven. This also prevents the food from drying out.

► If you wish to complete a cooking process using the residual heat in the oven, leave the function selector at the position set and turn the temperature selector to the lowest setting. Do not switch the appliance off until the food has been removed. Increased moisture in the oven could cause condensation to form which could lead to

- corrosion in the oven compartment.
- damage to the control panel, worktop and surrounding kitchen furniture.

► Do not line the floor of the oven with aluminium foil when using "Conventional heat " / "Bottom heat " / "Intensive bake " / "Rapid heat-up ".

This would cause a build-up of heat which could cause damage to the floor of the oven.

For this reason do not place a dish, tin or baking tray directly on the oven floor.

Warning and Safety instructions

If using a tray made by a different manufacturer, make sure that there is a gap of at least 6 cm between the bottom of the tray and the floor of the oven.

▶ Never add cold water to food on a hot universal tray or baking tray or directly onto food in a hot oven. The steam created could cause serious burns or scalding and the sudden change in temperature can damage the enamel.

▶ Always ensure that food is suitably cooked or reheated.

Some foods may contain micro-organisms which are only destroyed by thorough cooking at temperatures over 70 °C for a minimum of 10 minutes. Therefore when cooking or reheating foods, e.g. poultry, it is particularly important that food is fully cooked through. If in doubt select a longer cooking or reheating time. It is important that the heat is allowed to spread evenly throughout the food being cooked. This can be achieved by stirring and/or turning the food during cooking.

▶ If using plastic containers for cooking, they must be declared by the manufacturer as being suitable for use in an oven. Other types of plastic containers melt at high temperatures, and could damage the oven.

▶ Do not heat up unopened tins or jars of food in the oven. Pressure can build up and they may explode, resulting in injury or damage.

▶ Do not push pots and pans around on the oven floor, as this could damage the surface.

▶ Do not lean or sit on an open oven door, or place heavy items on it. Make sure that nothing gets trapped between the door and the oven compartment. This could damage the oven. The oven door can support a maximum load of 15 kg.

▶ Do not use the appliance to heat up the room. Due to the high temperatures radiated, objects near the appliance could catch fire.

Accessories

▶ Only use genuine Miele original spare parts and accessories with this appliance. Using spare parts or accessories from other manufacturers will invalidate the guarantee, and Miele cannot accept liability.

The manufacturer cannot be held liable for damage caused by non-compliance with these Warning and Safety instructions.

Disposal of the packing material

The transport and protective packing has been selected from materials which are environmentally friendly for disposal, and should be recycled.

Ensure that any plastic wrappings, bags, etc. are disposed of safely and kept out of the reach of babies and young children. Danger of suffocation.

Disposal of your old appliance

Electrical and electronic appliances often contain materials which, if handled or disposed of incorrectly, could be potentially hazardous to human health and to the environment. They are, however, essential for the correct functioning of your appliance. Please do not therefore dispose of it with your household waste.

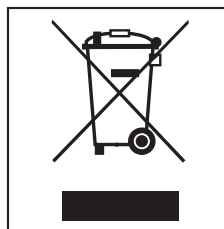

Please dispose of it at your local community waste collection / recycling centre or contact your dealer for advice. Ensure that it presents no danger to children while being stored for disposal.

Guide to the appliance

H 5040 B

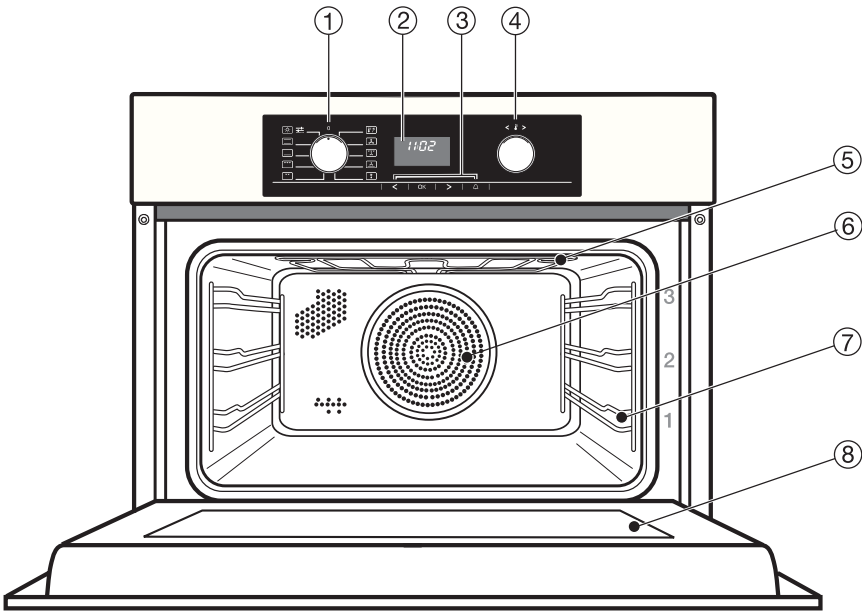

- ① Function selector, retractable when it is at "0"
- ② Display
- ③ Sensors <, OK, >, 
- ④ Temperature selector, retractable
- ⑤ Top heat/grill element
- ⑥ Catalytic enamelled back panel with air inlet for the fan
- ⑦ Side runners with three shelf levels
- ⑧ Door

Oven controls

In addition to operating the various cooking programmes to bake, roast and grill the controls also offer the following:

- a time of day display,
- a minute minder,
- a timer to automatically switch cooking programmes on and off,
- settings that can be customised.

Safety features

System lock

The system lock  prevents the oven from being used unintentionally by children, for example. See "System lock".

Safety switch-off

The oven will switch itself off automatically if it has been on for an unusually long period of time. The period of time will depend on the particular oven function being used. If it has switched itself off automatically "Fault 55" will appear in the display. The oven can be used again immediately after switching it off and back on.

Cooling system

A cooling fan will come on automatically when a cooking programme is started. The cooling fan mixes hot air from the oven cavity with cool room air before venting it out into the kitchen through vents located between the appliance door and the control panel.

The cooling fan will continue to run for a while after the oven has been switched off to prevent any humidity building up in the oven, on the control panel or on the oven housing unit.

When the temperature in the oven has fallen sufficiently, the cooling fan will switch off automatically.

Vented oven door

The oven door is an open system and the door panes have a heat-reflecting coating. During operation, cool air is passed through the oven door to keep the outer pane cool.

If necessary, the oven door can be dismantled for cleaning.

See "Cleaning and care" for more information.

Features

PerfectClean treated surfaces

The following surfaces are all treated with PerfectClean enamelling:

- Oven interior,
- Runners,
- Baking tray,
- Universal tray,
- Anti-splash insert (if present) and
- Rack

PerfectClean enamelled surfaces have very good anti-stick properties and are much easier to keep clean than conventional enamel, if cleaned regularly.

See "Cleaning and care" for more information.

Catalytic enamelled surface

The back panel and roof liner are coated with dark grey catalytic enamel. Soiling from oil and fat is burnt off these surfaces when very high temperatures are used in the oven.

See "Cleaning and care" for more information.

Energy saving features

Time of day display

The clock display can be switched off to save energy. When the oven is switched off the display will not light up. The time of day will, however, continue to run unseen in the background (see "Settings").

It will reappear in the display when the oven is next used.

Energy efficiency rating according to EN 50304

This appliance is rated energy efficiency class **A** in accordance with EN 50304.

Tests were carried out using "Fan plus " without catalytic roof liner fitted.

Accessories

The following accessories are supplied with this oven.

These and other accessories are also available to order from the Miele Spare Parts Department, your Dealer or via the internet on www.miele-shop.com.

Baking tray, universal tray and rack

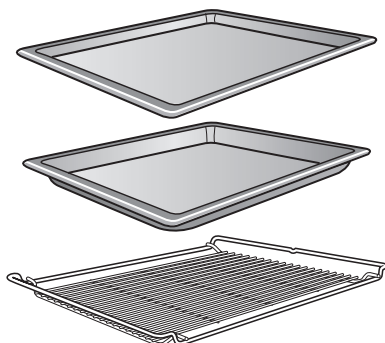

The baking tray, universal tray and rack are inserted into the oven between the two rails of a shelf runner.

The trays and rack have non-tip safety notches in the middle which prevent them being pulled right out when they only need to be partially pulled out. The trays and rack can then only be taken out of the oven by raising them upwards and then pulling them out.

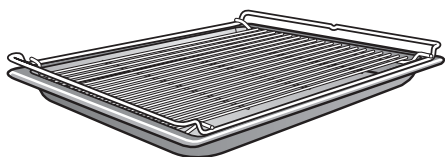

If you are using a tray with the rack on top, insert the tray between the rails of a shelf runner and the rack will sit on top of it.

Anti-splash insert (depending on model)

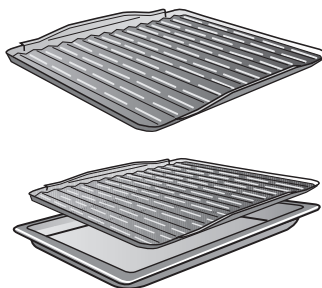

The anti-splash insert should be placed in the universal tray when grilling or roasting.

The juices from the food being cooked collect under the anti-splash tray. This prevents them from spitting and making the oven dirty. The juices can then be used for making gravy and sauces.

Handle (depending on model)

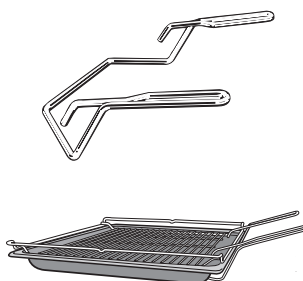







The handle makes it easier to take the universal tray, baking tray and rack out of the oven, or to put them into it. The two prongs at the top go inside the tray or above the rack and the U-shaped supports underneath.

Controls



Function selector

The left-hand control is used to select the function. It can be turned clockwise or anti-clockwise. The function selector can only be retracted when it is at "0".

-  Rapid heat-up
-  Fan plus
-  Fan grill
-  Intensive bake
-  Defrost
-  Conventional
-  Bottom heat
-  Full grill
-  Economy grill
-  Lighting/Settings:

For switching on the oven light independently. This can be useful when cleaning the oven. From this position you can also alter the settings of the appliance.

Temperature selector

The right-hand control <  > is used to

- set the required temperature.
- enter times (as an alternative to using the < or > sensor).

It can be turned clockwise or anti-clockwise.





The temperature selector can be retracted in any position.

Turn it clockwise to increase the value, turn it anti-clockwise to decrease the value.



Sensors

The sensors under the display react to touch.

A keypad tone will sound each time a sensor is touched. You can deactivate this, if wished (see "Settings ").

	Use
OK	<ul style="list-style-type: none"> – For calling up the functions in the display. Triangle  will appear in the display. – For confirming an entry.
<	<ul style="list-style-type: none"> – Moves triangle  in the display to the left or right. – Decreases or increases the time entry.
>	<ul style="list-style-type: none"> – For selecting the Setting  and changing the Status .
	For entering a minute minder time, e.g. for boiling eggs.

The following will change each time the < or > is touched

- Duration  and Finish time  in 1 minute increments,
- Minute minder time , at first in 5 second increments and then in 1 minute increments.

Touching the sensor for longer, speeds up the change in the display.

Controls

Symbols in the display



The following symbols will appear in the display depending on the position of the function selector and/or whether a sensor has been touched:

Position of the function selector	Symbol	Function/meaning
0	⊕	Time of day
	🔒	System lock
Function (except lighting)	🌡️	Temperature indicator
	🌡️	Temperature
	⊕	Time of day
	🕒 and h	Duration
	🕒	Finish
	<i>P</i> and a number	Setting
	<i>S</i> and a number	Status of the setting
Any	▲ lights up under a symbol	The function will show in the display.
	▲ flashes under a symbol	The function is selected and can be altered.
Any	🔔 and min	Minute minder time

Triangle ▲ in the display



When a sensor is touched, the **symbols of functions** which can be altered will light up in the display. These will vary depending on programme.

Touch the < or > sensor repeatedly until triangle ▲ is underneath the symbol of the required function.

Then select the function using the OK sensor.

Triangle ▲ will flash for approx. 15 seconds.

You can only make entries while triangle ▲ is flashing.
If the triangle has stopped flashing, you will need to call the function up again with the OK sensor.





Functions









Your oven has a range of oven functions for preparing a wide variety of recipes.

These include:

- Ⓐ Top heat/grill element (under the roof of the oven)
- Ⓑ Bottom heating element (under the floor of the oven)
- Ⓒ Ring heating element (behind the intake vent for the fan)
- Ⓓ Fan (behind the intake vent for the fan)

These components are combined in various ways, depending on the oven function selected. See the letters given in brackets for each function.

Function	Notes
 Conventional heat [Ⓐ + Ⓑ]	<ul style="list-style-type: none">– For baking traditional recipes, e.g. fruit cake, casseroles.– Also ideal for soufflés.– If using an older recipe or cookbook, set the oven temperature for Conventional heat 10°C lower than that recommended.– The cooking duration does not need to be changed.
 Bottom heat [Ⓑ]	<ul style="list-style-type: none">– Use this setting towards the end of baking to brown the base of a cake, quiche or pizza.
 Full grill [Ⓐ]	<ul style="list-style-type: none">– The whole grill element is switched on and glows red in order to create the heat required.– For grilling larger quantities of thin cuts (e.g. steaks).– For browning food in larger dishes.
 Economy grill [Ⓐ]	<ul style="list-style-type: none">– The inner part of the grill element is switched on and glows red in order to create the heat required.– For grilling smaller quantities of thin cuts (e.g. steaks).– For browning food in smaller dishes.

Function	Notes
 Rapid heat-up [A + C + D]	<ul style="list-style-type: none"> – For pre-heating the oven compartment. The oven function required must then be selected.
 Fan plus [C + D]	<ul style="list-style-type: none"> – For baking and roasting. – You can bake and roast on different levels at the same time. – Lower temperatures can be used than with Conventional heat  as the Fan plus system distributes the heated air around the food.
 Fan grill [A + D]	<ul style="list-style-type: none"> – The grill element and the fan switch on and off alternately. – For grilling larger items, e.g. rolled meat, poultry. – The hot air from the grill is distributed over the food by the fan. This enables a lower temperature to be selected than when using Full grill /Economy grill .
 Intensive-bake [B + C + D]	<ul style="list-style-type: none"> – For cooking dishes which require a moist topping and a crisp base such as pizza and quiche lorraine. – Intensive bake is not suitable for baking thin biscuits etc. or for roasting as the juices will become too dark.
 Defrost [C + D]	<ul style="list-style-type: none"> – For the gentle defrosting of frozen food.

Before using for the first time

Before the oven can be used, you will need to

- release the controls by pressing them in, if they are pushed in when the oven is delivered.
- set the time of day.

To set the time of day for the first time

The time can only be entered when the function selector is at "0".

In the display:

- the clock symbol ⌚ will light up,
- the time of day and triangle ▲ will flash underneath the ⌚ symbol.

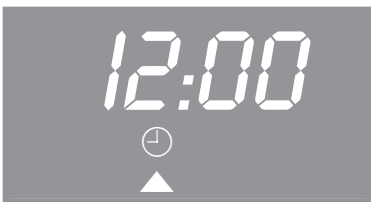

- Use the temperature selector or the < or > sensor to enter the hour first of all.
- Touch the OK sensor.

This confirms the hour and the minutes will then start to flash.

- Now use the temperature selector or the < or > sensor to enter the minutes.
- Touch the OK sensor.

This confirms the minutes.

The time of day you have selected has now been entered.

If there is a power cut, the appliance will store the current time of day of approx. 24 hours. If more than 24 hours have elapsed it will show "12:00" and will need to be reset.

When power is restored the time of day will flash in the display. If it is correct press the OK sensor to confirm it.

Changing the time of day

- Touch the OK sensor twice.
- Use the temperature selector or the < or > sensor to enter the hour first of all.
- Touch the OK sensor.
- Now use the temperature selector or the < or > sensor to enter the minutes.
- Touch the OK sensor.

The time of day has been changed.

Before using for the first time

Cleaning and heating up for the first time

- Before use, please remove
- any stickers from the oven and from any accessories.
 - any protective foil from the oven front.

See "Cleaning and care" for more information.

Before using the oven for the first time

- take **all accessories** out of the oven and wash them.
- then **heat the oven up once with nothing in it**. New ovens have a slight smell on first use and this will dissipate the smells before you use it to cook food.
- Before heating the oven up it is a good idea to wipe the interior out with a damp cloth. This way any dust or bits of packaging that may have accumulated in the oven cavity during storage and unpacking will be removed.
- Press and release the function selector and the temperature selector.
- Use the function selector to select "Fan plus ".

The recommended temperature of 160 °C will appear.

- Use the temperature selector to set the highest temperature (250 °C).

The oven will start heating up as soon as this entry has been accepted.

- Heat the empty oven for at least an hour.

Please ensure the kitchen is well ventilated during this operation. Close doors to other rooms to prevent the smell spreading throughout the house.

The timer can also be used to set the finish time. See "Entering a cooking duration".

- Leave the appliance to cool down to room temperature.
- Then wipe the oven interior out with a solution of hot water and a mild detergent and then dry it thoroughly with a soft clean cloth.

Leave the oven door open until the oven interior is completely dry.



Operation

Using the oven

- Place the food in the oven.
- Select the function you want (e.g. Fan plus ).

The following will appear in the display:



- "160" - the recommended temperature,
- the temperature indicator light ,
- the triangle  under the  symbol.

At the same time the oven compartment heating, lighting and cooling fan will switch on.

You can follow the temperature rising in the display. A buzzer will sound when the set temperature is reached for the first time, if the buzzer is switched on (see "Settings  - P 2).

- At the end of the programme turn the function selector to "0" and remove the food from the oven.









Cooling system

The cooling fan will continue to run for a while after the oven has been switched off to prevent any humidity building up in the oven, on the control panel or on the oven housing unit.

When the temperature in the oven has fallen sufficiently the cooling fan will switch off automatically.









Recommended temperature

As soon as a cooking function is selected, a **recommended temperature** will appear in the display.

Function	Recommended temperature
 Fan plus	160 °C
 Intensive bake	170 °C
 Conventional	180 °C
 Bottom heat	180 °C
 Fan grill	200 °C
 Full grill	240 °C
 Economy grill	240 °C
 Defrost	Time of day
 Rapid heat-up	160 °C

Changing the temperature

If your recipe requires a temperature which is different from the recommended temperature for that function you can use the temperature selector to change it within a given range. The temperature can be changed in increments of 5°C.

Function	Temperature range
 Fan plus	30 – 250 °C
 Intensive bake	50 – 250 °C
 Conventional	30 – 280 °C
 Bottom heat	100 – 280 °C
 Fan grill	50 – 260 °C
 Full grill	200 – 300 °C
 Economy grill	200 – 300 °C
 Defrost	–
 Rapid heat-up	30 – 250 °C

Temperature indicator

The **temperature indicator light**  will appear next to the temperature in the display. The indicator light is always on when the heating is on.

When the set temperature is reached,

- the oven heating switches off.
- the temperature indicator light goes out.
- a buzzer will sound, if the buzzer is switched on (see "Settings  - P 2).

However, if the temperature falls below the set temperature, the oven heating and the temperature indicator light will switch on again.

Pre-heating

Most dishes can be placed in a cold oven. They will then make use of the heat produced during the heating-up phase.

It is only necessary to pre-heat the oven in a few instances:

With **Fan plus** ,



- pre-heating may be necessary for foods which cook in less than 20 minutes and for foods such as puff pastries and yeast mixtures where instant heat is required to make them rise quickly.
- for roasting beef/fillet.

With **Conventional** ,

- it is usually necessary to pre-heat the oven.

Do not use Rapid heat-up  to pre-heat the oven when baking pizzas or biscuits and small cakes. They will brown too quickly.

To pre-heat the oven:

- Select Rapid heat-up  and set a temperature.
- When the temperature indicator light  goes out for the first time, set the oven function you require for continued cooking or baking, and place the food in the oven.

Operation

Switching on and off automatically

You can programme the oven to switch off automatically or on and off automatically.

For automatic switching off you need to enter the duration or the duration and a finish time.

The maximum duration which can be set is 12 hours.

We recommend using automatic switching on and off when roasting. However, do not delay the start for too long when baking as the cake mixture or dough will dry out, and the raising agents will lose their effectiveness.

Entering a cooking duration

To use the automatic switching off function on the oven, the cooking duration must be entered.

- Place the food in the oven.
- Select the required function and set the temperature.

The oven heating, lighting and cooling fan will switch on.

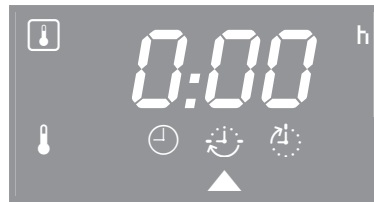

- Touch the > sensor repeatedly until triangle ▲ is underneath the ⏰ (Duration) symbol.

"0:00" appears in the display.

- Touch the OK sensor.
- Whilst triangle ▲ is flashing, enter the required duration in hours:minutes with the temperature selector or the > sensor.
- Touch the OK sensor.

If no other symbol is selected, the cooking duration will be seen counting down in the display.

Entering a cooking duration and delaying the finish time

To use the automatic switching on and off function on the oven, both the cooking duration and the finish time must be entered.

For example:

The time now is 10:45; you want a dish with a cooking duration of 90 minutes to be ready at 13:30.

- Place the food in the oven.
- Select the required function and set the temperature.

The oven heating, lighting and cooling fan will switch on.

First **enter the cooking duration**:

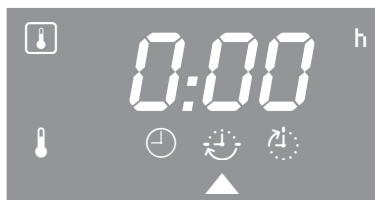

- Touch the > sensor repeatedly until triangle ▲ is underneath the  (Duration) symbol.

"0:00" appears in the display.

- Touch the OK sensor.

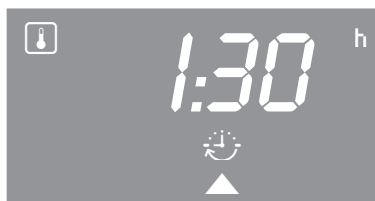

- Whilst triangle ▲ is flashing, enter the required duration in

hours:minutes (1:30) with the temperature selector or the > sensor.

- Touch the OK sensor.

Now set the **Finish** time:



- Touch the > sensor repeatedly until triangle ▲ is underneath the  (Finish) symbol.

- Touch the OK sensor.

The time of day plus the cooking duration entered appear in the display (10:45 + 1:30 = 12:15).

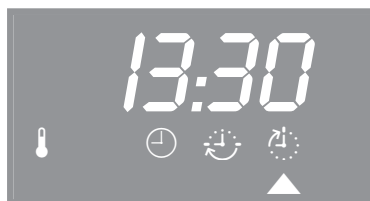

- Use the temperature selector or the > sensor to delay the finish time to 13:30.

- Touch the OK sensor.

The oven heating, lighting and cooling fan will switch off.



The Finish time will now show in the display as long as the triangle is not moved to under another symbol.

As soon as the start time (13:30 - 1:30 = 12:00) is reached, the oven heating, lighting and cooling fan will switch on.

Operation

The end of a cooking programme

At the end of the duration

- the oven heating switches off automatically.
- the cooling fan will continue to run for a while.
- the  symbol (Finish) will start flashing.
- a buzzer will sound, if the buzzer is switched on (see "Settings  - P 2).

- Turn the function selector to "0".

The buzzer will stop and the symbols in the display will go out.

- Remove the food from the oven.

To check and change an entered time

It is possible to check or change times entered for a cooking programme at any time by calling up the relevant symbol with the < or > sensors.

To change the time, touch the OK sensor and whilst triangle  is flashing, change the entry with the temperature selector or the < or > sensor.

To delete an entered time

- Set the duration to "0:00" or turn the function selector to "0".

If there is a power cut, all data entered will be deleted.

Minute minder (egg timer)

The minute minder can be used to time any activity in the kitchen, e.g. boiling eggs.

A maximum minute minder time of 59 minutes and 55 seconds can be set.



You can set the minute minder at the same time as another timed programme, e.g. as a reminder to stir a dish or add seasoning etc.

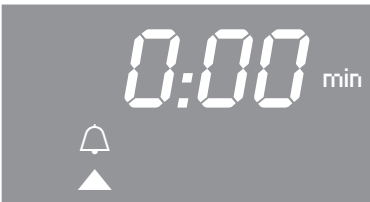

To set the minute minder

- Touch the  sensor.





"0:00" appears in the display.



- Whilst triangle  is flashing, enter the minute minder time with the temperature selector or the  sensor.
- Touch the OK sensor.

The minute minder time will be visible counting down in the display, as long as triangle  is underneath the  symbol.

At the end of the time set for the minute minder

- the  symbol will flash.
 - a buzzer will sound, if the buzzer is switched on (see "Settings  - P 3).
 - at the end of the minute minder time, the display will show the time counting upwards.
- Touch the OK sensor.

To cancel the time set for the minute minder

- Call up the  function with the OK sensor.
Triangle  must be flashing underneath the symbol.
- Use the temperature selector or the  sensor to set the minute minder time to "0:00".
- Touch the OK sensor.

Settings

Your oven is supplied with standard factory default settings. These settings "P" can be changed by altering their status "S" (see chart).

Setting	Status (* factory default setting)	
P 1 Time of day display	S 0	The time of day display is switched off . When the function selector is turned to the "0" position, the display remains dark. The time of day continues to run unseen in the background.
	S 1 *	The time of day display is switched on and is visible in the display.
P 2 Buzzer for cooking duration	S 0	The buzzer does not sound at the end of a cooking duration or at the end of the heating-up phase.
	S 1 *(short) S 2 (long)	The buzzer sounds at the end of a cooking duration and at the end of the heating-up phase. There are two buzzer tones to select from.
P 3 Buzzer for minute minder	S 0	The buzzer does not sound at the end of the minute minder time.
	S 1 *(short) S 2 (long)	The buzzer sounds at the end of a minute minder duration. There are two buzzer tones to select from.
P 4 Keypad tone	S 0	A keypad tone does not sound when a sensor is touched.
	S 1 *	A keypad tone sounds when a sensor is touched.
P 5 Buzzer volume	S 0 * to S 30	The volume can be changed if you have selected buzzer status S 2 for cooking duration P 2 and minute minder P 3. The volume cannot be changed if "P 2 – S 1" and "P 3 – S 1" have been selected.
P 6 Clock format	24 *	24 hour clock display.
	12	12 hour clock display.

To change the "status" of a setting

- Select "⚙️ Settings".
- Touch the OK sensor.

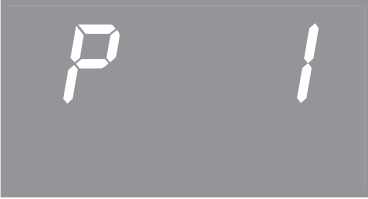

"P 1" will appear in the display.

- Touch the < or > sensor repeatedly until the setting required appears in the display.
- Touch the OK sensor.

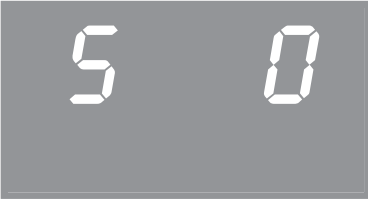

The current status "5" of the setting will appear in the display.

- Use the < or > sensor to change the status.
- Touch the OK sensor.

The change to the status is then stored in memory.

"P" will appear in the display again together with the number for the setting.

You can alter more settings as long as the function selector is not turned to "0".

The changes remain in memory even after a power cut.

System lock

Your oven has a **system lock**  which prevents it from being used unintentionally, for example, by children.

- Turn the function selector to "0".



- Touch the > sensor repeatedly until triangle ▲ is underneath the  symbol.
- Touch the OK sensor.

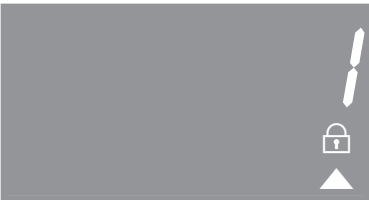

- Whilst triangle ▲ is flashing under the  symbol, use the < or > sensors to select the "1" or "0" setting for the system lock.

"0" = **Off**

"1" = **On**

- Confirm your choice of setting by touching the OK sensor.

If the "1" setting is selected, the appliance cannot be operated.

The  symbol will remind you that the system lock has been activated.

The lock remains active even after a power cut.

Refer to the baking charts for suggestions of temperatures, shelf levels and cooking durations. These take into account a range of different baking tins, quantities and cooking traditions.

Handling and preparing food correctly is essential for maintaining good health.

Only bake cakes, pizza, chips etc until they are golden. Do not overcook them.

Bakeware

Please take into account the material of your bakeware in your choice of oven function:

Fan plus , **Intensive bake** 

Any heat-resistant material can be used.

Conventional heat 

Dark metal, enamel or aluminium baking tins with a matt finish, as well as heat-resistant glass and ceramic dishes can be used.

Bright, shiny metal tins result in uneven or poor browning and in some cases cakes might not cook properly.

Baking parchment

Because of their PerfectClean anti-stick surface **the baking tray and the universal tray** do not need to be greased or lined with baking parchment for baking.

Baked goods are easily removed when done.

Baking parchment is only necessary when baking:

- Anything with a **high salt content** (e. g. pretzels, bread sticks), because sodium can damage the PerfectClean surface.
- Meringues or biscuits with a **high egg-white content**, because they are more likely to stick.

Universal tray

When baking cakes with **fresh fruit toppings** and **deep sponge cakes** place the tin in the universal tray to catch any spillages and keep the oven cleaner.

Rectangular tins

Place cakes in loaf tins and rectangular tins with the longer side across the width of the oven for optimum heat distribution and even results.

Baking tips

Notes about the charts



Temperature, baking duration

To achieve even results without over-browning the food,

- always select the **lowest temperature** given in the chart.
Do not set a temperature higher than that recommended. Increasing the temperature may reduce the cooking time, but will lead to uneven browning, and unsatisfactory cooking results.
- Check if the food is cooked at the end of the **shortest time quoted**.
To check if a cake is ready, insert a wooden skewer into the centre. It is ready if the skewer comes out clean, without dough or crumbs sticking to it.

Shelf levels

The shelf levels are counted from the bottom of the oven upwards (1 = lowest, 3 = highest).

	Number of trays	Shelf levels
	1	2
	2	1 and 2
	1	1 or 2
	1	1 or 2

The universal tray should be used beneath the baking tray when baking on two levels at the same time.

Frozen food

When baking frozen products such as **cakes, pizza and baguettes**, use the lowest temperature quoted on the manufacturer's packaging. Bake on a layer of baking parchment placed on the rack. Cooking large frozen items on the baking tray or the universal tray can cause the metal to distort. This distortion would increase with subsequent use.

Small items of frozen food such as **oven chips or potato croquettes** can be cooked on the universal tray. Place them on baking parchment and select the lowest temperature quoted on the manufacturer's packaging. Turn several times during cooking.

Fan plus

Cakes / biscuits	Temperature in °C	Recommended shelf level	Duration ¹⁾ in min.
Creamed mixture			
Sponge cake	150 – 170	2	60 – 70
Ring cake	150 – 170	2	65 – 80
Foam cake (tray)	150 – 170	2	25 – 40
Marble, nut cake (tin)	150 – 170	2	60 – 80
Fresh fruit cake with filling (tray)	150 – 170	2	45 – 50
Fresh fruit cake (tray)	150 – 170	2	35 – 55
Fresh fruit cake (tin)	150 – 170	2	55 – 65
Flan base ³⁾	150 – 170	2	25 – 30
Small cakes/biscuits ³⁾ (tray)	150 – 170	1, 2 ⁴⁾	20 – 25
Sponge mix³⁾			
Sponge cake (3 to 6 eggs) ³⁾	160 – 180	2	25 – 35
Sponge cake (2 eggs) ³⁾	160 – 180	2	20 – 25
Swiss roll ²⁾	160 – 180	2	20 – 25
Rubbed in mixture			
Tart / flan base	150 – 170	2	20 – 25
Streusel cake	150 – 170	2	45 – 55
Small cakes/biscuits ³⁾ (tray)	150 – 170	1, 2 ⁴⁾	15 – 25
Cheese cake	150 – 170	2	70 – 90
Apple pie	150 – 170	2	50 – 70
Apricot tart with topping	150 – 170	2	55 – 75
Swiss apple pie ²⁾	190 – 210	2	25 – 35
Yeast mixtures with quark dough			
To prove dough	30 – 50	Oven floor ⁵⁾	15 – 30
Guglhupf	150 – 170	1 or 2	50 – 60
Streusel cake	150 – 170	2	35 – 45
Fresh fruit cake (tray)	160 – 180	2	40 – 50
White bread	160 – 180	2	40 – 50
Wholegrain bread ²⁾	170 – 190	2	50 – 60
Pizza (tray) ³⁾	170 – 190	2	35 – 45
Onion tart	170 – 190	2	35 – 45
Apple turnovers	150 – 170	1, 2 ⁴⁾	25 – 30
Choux pastry³⁾, Eclairs	160 – 180	1, 2 ⁴⁾	30 – 40
Puff pastry	170 – 190	1, 2 ⁴⁾	20 – 25
Meringues, Macaroons	120 – 140	1, 2 ⁴⁾	25 – 50

1) Unless otherwise stated, the times given are for an oven which has not been pre-heated.

With a pre-heated oven, shorten times by up to 10 minutes.

2) Pre-heat the oven.

3) Switch Rapid heat-up  off during the heating-up phase.

4) Take baking trays out of the oven early if the food is sufficiently browned before the specified time has elapsed.

5) Place the rack on the floor of the oven, and stand the bowl containing the dough on the rack.

In general, if a range of temperatures/times is given, it is best to select a lower temperature and to check the food after the shortest time.

Baking chart

Conventional heat

Cakes / biscuits	Temperature in °C	Recommended shelf level	Duration ¹⁾ in min.
Creamed mixture			
Sponge cake	150 – 170	2	60 – 70
Ring cake	170 – 190	2	65 – 80
Foam cake (tray) ¹⁾	170 – 190	2	25 – 40
Marble, nut cake (tin)	150 – 170	2	60 – 80
Fresh fruit cake, with filling (tray)	170 – 190	2	45 – 50
Fresh fruit cake (tray)	170 – 190	2	35 – 55
Fresh fruit cake (tin)	160 – 180	2	55 – 65
Flan base ^{2) 3)}	170 – 190	2	20 – 25
Small cakes/biscuits ^{2) 3)}	170 – 190	2	15 – 25
Sponge mix^{2) 3)}			
Sponge cake (3 to 6 eggs) ^{2) 3)}	170 – 190	2	20 – 35
Sponge cake (2 eggs) ^{2) 3)}	170 – 190	2	15 – 20
Swiss roll ^{2) 3)}	180 – 200	1	12 – 16
Rubbed in mixture			
Tart / flan base	170 – 190	2	15 – 20
Streusel cake	170 – 190	2	45 – 55
Small cakes ^{2) 3)} (tray)	160 – 180	2	15 – 25
Cheesecake	170 – 190	2	70 – 90
Apple pie ²⁾	170 – 190	2	45 – 65
Apricot tart, with filling ²⁾	170 – 190	2	55 – 75
Swiss apple pie ²⁾	220 – 240	2	25 – 35
Yeast mixtures with quark dough			
To prove dough ^{Guglhupf}	30 – 50	Oven floor ⁴⁾	15 – 30
Streusel cake	160 – 180	1 or 2	50 – 60
Fresh fruit cake (tray)	170 – 190	2 ⁵⁾	35 – 45
White bread	180 – 200	2 ⁵⁾	40 – 50
Wholegrain bread ²⁾	160 – 180	2	50 – 60
Pizza (tray) ^{2) 3)}	190 – 210	2	50 – 60
Onion tart ²⁾	190 – 210	2	30 – 40
Apple turnovers	180 – 200	2	25 – 35
	160 – 180	2	25 – 30
Choux pastry^{2) 3)}, Eclairs	180 – 200	2	35 – 45
Puff pastry²⁾	190 – 210	2	15 – 25
Meringues²⁾, Macaroons	120 – 140	2	25 – 50

1) Unless otherwise stated, the times given are for an oven which has not been pre-heated.

With a pre-heated oven, shorten times by up to 10 minutes.

2) Pre-heat the oven.

3) Switch Rapid heat-up  off during the heating-up phase.

4) Place the rack on the floor of the oven, and stand the bowl containing the dough on the rack.

5) Shelf level for yeast dough. For quark dough, use shelf level 3.

In general, if a range of temperatures/times is given, it is best to select a lower temperature and to check the food after the shortest time.

Intensive bake

Particularly suitable for

- dishes that require a moist topping and crisp base like pizza and quiche lorraine.
- cakes with a filling where the base has not been pre-baked, e.g. some cheesecakes.

Cakes / biscuits	Temperature in °C	Recommended shelf level	Duration ¹⁾ in min.
Creamed mixture			
Fresh fruit cake, with filling (tray)	150 – 170	1	30 – 35
Rubbed in mixture			
Cheesecake	150 – 170	2	65 – 75
Apple pie	150 – 170	2	50 – 60
Apricot tart, with filling	150 – 170	1	50 – 60
Swiss apple pie	190 – 210	1 or 2	25 – 30
Yeast mixtures with quark dough			
Pizza (tray) ²⁾	170 – 190	2	40 – 50
Onion tart	170 – 190	2	25 – 35





1) Unless otherwise stated, the times given are for an oven which has not been pre-heated.

With a pre-heated oven, shorten times by up to 10 minutes.

2) Switch Rapid heat-up  off during the heating-up phase.

In general, if a range of temperatures/times is given, it is best to select a lower temperature and to check the food after the shortest time.

Roasting tips

Recommendations	Notes
Function Fan plus 	You can also use Conventional  .
Containers Any heat-resistant containers	<p>The Miele Gourmet oven dish, roasting pans with a lid, ovenproof china or glass, roasting bags, the universal tray, the rack on top of the universal tray, the anti-splash insert (if you have one) in the universal tray.</p> <p>We recommend roasting in a covered pot, as</p> <ul style="list-style-type: none"> – this ensures that sufficient stock remains for making gravy. – and the oven stays cleaner, too.
Shelf level 1st or 2nd shelf level from the bottom	
Pre-heating Generally not required	Place the covered pot on the rack into a cold oven. Pre-heating is only required when roasting beef/fillet.
Temperature Please refer to the roasting chart.	<ul style="list-style-type: none"> – Do not select a higher temperature than that suggested. The meat will brown on the outside, but will not be properly cooked through. – With Fan plus , a temperature of 20°C less than for Conventional  is sufficient. – For cuts which weigh 3 kg or more, select a temperature approx. 10 °C lower than that given in the roasting chart. Roasting will take longer at the lower temperature, but will be more even. – For roasting directly on the rack, select a temperature that is about 20°C lower than for roasting in a covered pot.
Roasting times Please refer to the roasting chart.	To calculate the roasting time: The traditional British method is to allow 15 to 20 minutes per lb/450 grammes, according to type of meat, plus approx. 20 minutes, adjusting the length of time as roasting proceeds to obtain the required result.

Useful tips

Browning

Browning only occurs towards the end of the roasting time. Remove the lid about halfway through the roasting time if a more intensive browning result is desired.

Standing time

At the end of the programme, take the roast out of the oven, wrap in aluminium foil and leave to stand for about 10 minutes. This helps retain juices when the meat is carved.



Roasting poultry



For a crisp finish, baste the poultry ten minutes before the end of cooking time with slightly salted water.

Frozen meat

Do not roast deep frozen meat. Meat should be thoroughly defrosted before roasting.

Roasting chart

Food	Recommended shelf level	Fan plus 		Conventional  ¹⁾	
		Temperature in °C ²⁾	Time in min. ³⁾	Temperature in °C ²⁾	Time in min. ³⁾
Topside of beef, approx. 1 kg	1 or 2	170 – 190	100 – 120	190 – 210	100 – 120
Beef fillet or roast beef, approx. 1 kg ⁴⁾	1 or 2	190 – 210	45 – 55	200 – 220	45 – 55
Venison, approx. 1 kg	1 or 2	180 – 200	90 – 120	190 – 210	90 – 120
Pork joint, approx. 1 kg	1 or 2	170 – 190	100 – 120	200 – 220	100 – 120
Pork joint with crackling, approx. 2 kg	1 or 2	150 – 170	160 – 180	180 – 200	120 – 150
Gammon joint, approx. 1 kg	1 or 2	170 – 190	60 – 70	200 – 220	60 – 70
Meat loaf, approx. 1 kg	1 or 2	160 – 180	70 – 80	190 – 210	70 – 80
Veal, approx. 1.5 kg	1 or 2	170 – 190	100 – 120	190 – 210	100 – 120
Leg of lamb, approx. 1.5 kg	1 or 2	170 – 190	90 – 120	200 – 220	90 – 120
Rack of lamb, approx. 1.5 kg ⁴⁾	1 or 2	170 – 190	50 – 60	190 – 210	50 – 60
Poultry, 0.8 – 1 kg	1 or 2	170 – 190	60 – 70	190 – 210	60 – 70
Poultry, approx. 2 kg	1 or 2	170 – 190	90 – 110	190 – 210	90 – 110
Poultry, stuffed, approx. 2 kg	1 or 2	170 – 190	110 – 130	190 – 210	110 – 130
Poultry, approx. 4 kg	1 or 2	160 – 180	150 – 180	180 – 200	150 – 180
Fish, whole, approx. 1.5 kg	1 or 2	160 – 180	35 – 55	190 – 210	35 – 55

1) We recommend Fan plus  for roasting, however, Conventional  can also be used.

2) Temperature in a covered pot.

If open roasting, set the temperatures 20°C lower.

3) Unless otherwise stated, the times given are calculated on the basis of an oven which has not been pre-heated.

4) Pre-heat the oven.

In general, if a range of temperatures and times is given, it is best to select a temperature in the middle and to check the food after the shortest time.

Notes on Slow cooking

This type of cooking is ideal for cooking beef, pork, veal or lamb when a tender result is required.

First sear the meat all over at a high temperature on the hob in order to seal it.

Then cook the meat in the oven at a low temperature over a long period. The meat juices inside the joint will start to circulate evenly throughout the meat to reach the outer layers.

This gives very tender and succulent results.

Please note:

- Use lean meat which has been correctly hung and trimmed. The meat should be taken off the bone before cooking.
- For searing use a suitable cooking oil that can withstand high temperatures.
- Do not cover meat during cooking.
- Cooking takes between 2-4 hours depending on the size and amount of meat and on the degree of doneness and browning required.
- Meat can be carved straight from the oven. It does not need to rest.

Proceed as follows:

We recommend using the universal tray with the rack on top.

- Place the universal tray with the rack on top in the oven at shelf level 2.
- Select the Conventional heat function.
- Pre-heat the oven, rack and universal tray at 130 °C for approx. 15 minutes.
- Whilst the oven is pre-heating, sear the meat thoroughly on the hob.

Please refer to the chart on the next page for cooking durations and core temperatures if you are using a food probe.

 The top heating element/grill element is hot. Danger of burning.

- Place the meat on the rack.
- Insert a food probe, if available, into a fleshy part of the meat.
- Reduce the temperature to 100 °C.
- Cook the meat.

It is a good idea to programme the duration; see "Operation - Entering a cooking duration". The result will not be affected if the meat is left in the oven for a while after cooking has finished.

Notes on Slow cooking

Cooking duration/Core temperatures

Food	Duration in min.	Core temp. in °C
Sirloin joint		
– rare	60–90	48
– medium	120–150	57
– well done	180–240	69
Pork fillet	120–150	63
Boned gammon	150–210	68
Boned saddle of veal	180–210	63
Boned saddle of lamb	90–120	60





Useful tips

Because it has been cooked using low temperatures,

- meat can be kept warm quite safely in the oven until it is served. This will not affect results in any way.
- the meat is at an ideal temperature to eat straight away. Serve on pre-heated plates with very hot sauce or gravy to prevent it cooling down too quickly.

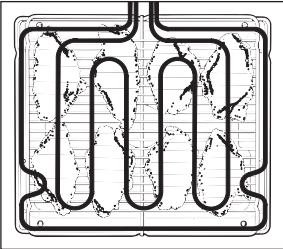
 Grill with the oven door closed.

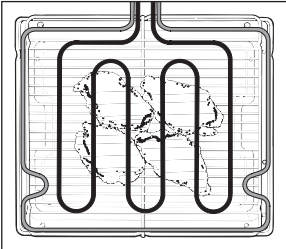
If you grill with the door open, hot air will escape from the oven instead of being cooled by the cooling fan. The controls will get hot. Danger of burning.

Function	Notes
Full grill 	<p>For grilling thin cuts in large quantities and for browning large baked dishes.</p> <p>The whole grill element will get hot and glow red.</p> 
Economy grill 	<p>For grilling thin cuts in small quantities and for browning small baked dishes.</p> <p>The inner part of the grill heating element will get hot and glow red.</p> 
Fan grill 	For grilling thicker items, e.g. rolled meat, poultry pieces.

Grilling tips

Recommendations	Notes
<p>Containers</p> <p>Rack on the universal tray Anti-splash insert in the universal tray (if you have one)</p>	<p>Do not use the baking tray.</p>
<p>Recommended shelf level, from the bottom</p> <p>Please refer to the grilling chart.</p>	<p>For thin cuts use shelf level 2 or 3 For thicker cuts use shelf level 1 or 2</p>
<p>Pre-heating</p> <p>is necessary</p>	<p>Pre-heat the grill for approx. 5 minutes with the door shut.</p>
<p>Temperature</p> <p>Please refer to the grilling chart.</p>	<ul style="list-style-type: none"> – For thin cuts of meat (e. g. chops or steak): 275 °C – For grilling thicker items, (e. g. rolled meat, poultry) 240 °C – Do not select a higher temperature than that suggested. The meat will brown on the outside, but will not be properly cooked through.
<p>Grilling time</p> <p>Please refer to the grilling chart.</p>	<ul style="list-style-type: none"> – Flat pieces of fish and meat usually take 6 – 8 minutes per side. Thicker pieces take a little longer. – With rolled meat, allow approx. 10 minutes per cm diameter. – Turn food half way through cooking.

Preparing food for grilling

Rinse briefly under running cold water, pat dry and season with pepper and herbs. Do not season meat with salt before grilling as this draws the juices out.

Add a little oil to lean meat if necessary. Do not use other types of fat as they can burn and cause smoke.

Clean fish in the normal way. To enhance the flavour, add a little salt or squeeze a little lemon juice over the fish.

Grilling

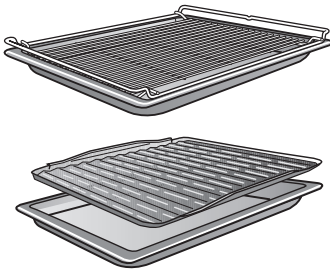

- Assemble the rack and anti-splash insert (if you have one) on the universal tray as illustrated.
- Place the food on the rack.
- Select the required function and set the temperature.
- Pre-heat the grill for approx. 5 minutes with the door shut.
- Place the food under the grill and shut the door.
- Turn food half way through cooking.

Useful tips

It is best to grill food of a similar thickness at the same time so that the grilling time for each item does not vary too greatly.



To grill thicker pieces of food more gradually after an initial high temperature, continue grilling at a lower temperature setting or use a lower shelf runner to allow the food to cook through to the centre.

One way of finding out how far through a piece of meat has been cooked is to press down on it with a spoon.

- If there is very little resistance to the pressure of the spoon, it will still be red on the inside ("rare").
- If there is some resistance the inside will be pink ("medium").
- If there is great resistance, it is thoroughly cooked through ("well done").

Grilling chart

Pre-heat the grill for approx. 5 minutes with the door shut.

Food to be grilled	Recommended shelf level	Full grill  / Economy grill 		Fan grill 	
		Temperature in °C	Total grilling time in min. ¹⁾	Temperature in °C	Total grilling time in min. ¹⁾
Thin cuts					
Steak	2	275	10 – 16	220	20 – 25
Kebabs	2 or 3	240	25 – 30	220	16 – 20
Chicken kebabs	2 or 3	240	20 – 25	200	23 – 27
Escalope	2 or 3 ²⁾	275	12 – 18	220	23 – 27
Liver	2 or 3 ²⁾	275	8 – 12	220	12 – 15
Burgers	2 or 3 ²⁾	275	14 – 20	220	18 – 22
Sausages	2 or 3 ²⁾	275	10 – 15	220	9 – 13
Fish fillet	2 or 3 ²⁾	275	12 – 16	220	13 – 18
Trout	2 or 3 ²⁾	275	16 – 20	220	20 – 25
Toast	2 or 3 ²⁾	275	2 – 4	220	3 – 6
Cheese toast	2 or 3 ²⁾	275	7 – 9	220	5 – 8
Tomatoes	2 or 3	275	6 – 8	220	8 – 10
Peaches	2 or 3	275	6 – 8	220	15 – 20
Thicker cuts					
Chicken (approx. 1 kg)	1	240	50 – 60	190	60 – 65
Rolled meat, Ø 7 cm, (approx. 1 kg)	1	240	75 – 85	200	100 – 110
Pork shank (approx. 1 kg)	1	240	100 – 120	200	95 – 100
Sirloin, approx. 1 kg	1	–	–	250	25 – 35

1) Turn half way through the grilling time.

2) Select the appropriate shelf level for the thickness of the food.

The Defrost  function uses the fan to circulate air at room temperature.

Please note:

- Where possible remove the packaging and put the food to be defrosted on the universal tray or into a suitable dish.
- When defrosting poultry, put it on the rack over the universal tray to catch the defrosted liquid so that the meat is not lying in this liquid.

 It is particularly important to observe food hygiene rules when defrosting poultry. Do not use the liquid from the defrosted poultry. Pour it away, and wash the tray, the sink and your hands. Danger of salmonella poisoning.

- Fish does not need to be fully defrosted before cooking. Defrost so that the surface is sufficiently soft to take herbs and seasoning.

 Do not refreeze food once it has thawed.

Defrosting times

The time needed for defrosting depends on the type and weight of the food, and at what temperature it was deep frozen. The following chart is for guidance only. It is important to check that food is thoroughly defrosted.

Chicken, 800 g	90 – 120 min.
Meat, 500 g	60 – 90 min.
Meat, 1000 g	90 – 120 min.
Sausages, 500 g	30 – 50 min.
Fish, 1000 g	60 – 90 min.
Strawberries, 300 g	30 – 40 min.
Sponge cake, 500 g	20 – 30 min.
Bread, 500 g	30 – 50 min.

Cooking ready meals

We recommend using Fan plus .

- Select the required function and set the temperature.
- When the temperature indicator light  goes out, place the dish in the pre-heated oven.

Cook frozen cakes and pizza on baking paper on the rack rather than on the baking tray or the universal tray. Cooking large frozen items on the baking tray or the universal tray can cause the metal to distort. This distortion will increase with each subsequent use.

Frozen food such as oven chips or croquette potatoes can, however, be cooked on the baking tray or the universal tray.

Examples of ready meals

Food	Temperature in °C *	Shelf level from the bottom*	Time in min.*	Notes
Potato, pasta or vegetable bake	250	2	20 – 25	Place in a suitable dish
Lasagne, cannelloni	190	2	35 – 40	Remove the lid
Filled baguette, panini	200	2	12 – 15	Place on baking paper, directly on the rack
Pre-cooked pizza	200	2	12 – 20	Place on baking paper, directly on the rack
Pre-cooked mini pizza	220	2	8 – 10	Place on baking paper, directly on the rack
Potato pancakes, Rösti, croquettes	220	2	12 – 20	Place on baking paper, directly on the rack

* Observe recommended temperatures, cooking times and position in the oven given on the manufacturer's packaging.

Miele branded cleaning and conditioning products are available from the Miele Spare Parts Department or via the internet on www.miele-shop.com.

 Do not use a steam cleaner to clean the appliance. The steam could reach electrical components and cause a short circuit.

Appliance front

Remove any soiling immediately. If not, it might become impossible to remove and could cause the surface to alter or discolour.

Clean the front using a damp Miele microfibre E-cloth or with a clean sponge and a solution of hot water and washing-up liquid. Wipe dry using a soft cloth.

The external surfaces of this appliance are all susceptible to scratching. Scratches on glass surfaces could even cause a breakage in certain circumstances. Contact with unsuitable cleaning agents can alter or discolour the outer surfaces.

To prevent damage to your appliance when cleaning, do not use:

- cleaning agents containing soda, ammonia, acids or chlorides,
- cleaning agents containing descaling agents,
- abrasive cleaning agents, e.g. powder cleaners and cream cleaners,
- solvent-based cleaning agents,
- stainless steel cleaning agents,
- dishwasher cleaner,
- oven sprays,
- glass cleaning agents,
- hard, abrasive sponges and brushes, e.g. pot scourers,
- sharp metal scrapers.

Cleaning and care

Accessories

Baking tray, universal tray, anti-splash insert (if applicable)

The surface has been treated with **PerfectClean enamel**.

Please refer to the section on "PerfectClean" for information on cleaning and care.

Rack, runners

The surface has been treated with **PerfectClean enamel**.

Treat in the same way as other surfaces coated with PerfectClean. See "PerfectClean".

Oven interior

Allow the oven to cool down before cleaning.
Danger of burning

The oven interior should be cleaned after each use. If this is not done subsequent soiling from baking and roasting will become worse and make cleaning harder. In extreme cases soiling will be impossible to remove or even cause damage to the surface material.

The surface of the oven interior has been treated with **PerfectClean enamel**.

When baking items with a high salt content (e.g. continental pretzels) place them on baking parchment in the universal tray. Sodium deposits can

cause lasting discolouration to PerfectClean surfaces.

Please refer to the section on "PerfectClean" for information on cleaning and care.

The removable **back panel and roof liner** are coated with a dark grey **catalytic enamel**.

See the cleaning instructions for "Catalytic enamelled surfaces".

To make cleaning easier

- remove the oven door,
- dismantle the door,
- take out the runners,
- remove the catalytic enamelled back panel and roof liner.
- lower the top heating/grill element.

Instructions for doing so are given further on in this section.

Seal and inside of the oven door

Grease desposits on the seal between the inside of the oven door and the oven interior can cause it to become brittle and cracked.

It is best to clean the seal and the inside of the door after each with a Miele E-cloth or a clean sponge and a solution of hot water with a little washing-up liquid. Wipe dry using a soft cloth.

PerfectClean

The following have been treated with a special finish called PerfectClean:

- oven interior
- baking tray
- universal tray
- anti-splash insert (if applicable)

PerfectClean surfaces have very good **anti-stick properties** and are **much easier to keep clean** than conventional oven enamel, if cleaned regularly.

Food can be lifted off more easily, and soiling from baking and roasting is easier to remove.

The following notes on cleaning and care should ensure that the anti-stick and easy clean properties of PerfectClean last for many years.

PerfectClean surfaces can be treated as you would treat glass.

Food can be sliced or cut up on the PerfectClean surface in the same way as on a baking tray with conventional enamel.

Do not use ceramic knives on PerfectClean treated surfaces, as these can cause scratches.

 Allow the oven and any accessories to cool down before cleaning by hand. Danger of burning.

For the optimum performance of PerfectClean, it is important to clean the oven and accessories after each use.

The surfaces will become harder to clean and the anti-stick properties will deteriorate if soiling is not removed after each use and allowed to build up. In extreme cases cleaning may become impossible.

To avoid damaging the surface structure, the following must not be used on PerfectClean surfaces:

- abrasive cleaning agents, e.g. powder cleaners and cream cleaners,
- cleaning agents for ceramic hobs,
- wire wool or metal scourers,
- abrasive sponges, e.g. pot scourers or sponges which have been previously used with abrasive cleaning agents,
- oven spray must not be used on PerfectClean surfaces which are hot or left on for too long,
- PerfectClean enamelled items must not be washed in a dishwasher,
- spot cleaning.

Cleaning and care

After cleaning, rinse thoroughly with clean water to remove any residual cleaning agents as these can diminish the anti-stick properties.

Normal soiling should be cleaned as soon as possible after each use with a soft sponge and a solution of hot water and a little washing up liquid. The longer soiling is left, the harder it may become to remove.

If necessary, the scouring pad on the back of a non-scratch washing-up sponge or a soft nylon brush can be used.

You may find it easier to clean the oven trays if you soak any deposits in a solution of hot water with a little washing-up liquid for a few minutes.

Stubborn soiling can be more difficult to clean and may require an oven cleaning spray.

Remove all catalytic enamelled panels from the oven interior before using oven spray. The chemicals used in oven sprays will damage catalytic enamel.

Allow the PerfectClean surfaces to cool down to room temperature before applying the spray. Apply a proprietary oven cleaning spray and leave to take effect for up to ten minutes only.

Miele oven cleaning spray can be left on for longer. Always follow the instructions on the packaging.

If necessary, the pad on the back of a non-scratch washing-up sponge can also be used.

Repeat the process, if necessary.

After using oven spray, rinse thoroughly with clean water and then dry thoroughly.

For **extremely stubborn soiling** a glass scraper or a non-abrasive stainless steel pad can be used.

The steps described above should enable you to clean the surfaces thoroughly.

Should the PerfectClean surface be damaged by any of the above measures not being heeded, it will still retain the anti-stick qualities of standard enamel and be as easy to keep clean as standard enamel.

Please note:

- Soiling such as spilt juices and cake mixtures are best removed whilst the oven or tray is still warm. Exercise caution and make sure the oven is not too hot - danger of burning.
- Soiling such as spilt juices and roasting deposits may cause lasting discolouration or matt areas to appear. Discolouration or matt areas will not affect the efficiency of the surface. Follow the cleaning instructions given above and do not use force to remove them.

Catalytic enamel surfaces

The back panel and roof liner are coated with dark grey catalytic enamel. Soiling from oil and fat is burnt off these surfaces when very high temperatures are used in the oven. The higher the temperature, the more effective the process.

The catalytic coating becomes ineffective through using

- abrasive cleaning agents,
- hard brushes or abrasive sponges,
- oven sprays.

Remove the catalytic back panel and roof liner from the oven before cleaning the PerfectClean oven surfaces with oven spray.

Note that deposits of **spices, syrups and similar substances** are not removed from the catalytic coating by this process. These should be removed by hand whilst still fresh, using a mild solution of hot water and washing-up liquid applied with a soft sponge or brush. Remove the panels from the oven to do this.

Soiling caused by **oil and grease splashes** are removed from catalytic coated surfaces when the oven is heated to a high temperature. To do this:

- Take all accessories out of the oven.
- Wipe large deposits of soiling from the oven interior and the inside of the door before starting the cleaning process to avoid them baking onto PerfectClean surfaces and becoming impossible to remove.

- Select Fan plus .

- Set the highest temperature setting.

Run the oven for approx. 1 hour. The length of time will depend on the level of soiling.

The timer can also be used to set the finish time.

If the catalytic coated panels are very heavily soiled with oil and grease, a film will develop on the oven surface during the cleaning process which can be wiped off with warm water and a little washing-up liquid once cool.

- Finally, clean the PerfectClean surfaces and the inside of the door.

Any remaining soiling will gradually disappear with each subsequent use of the oven at high temperatures.

Should the catalytic coating on the back panel or roof liner become ineffective through improper use or heavy soiling, a replacement can be obtained from your Miele dealer or the Miele Spare Parts Department.

Cleaning and care

To remove the oven door

The oven door is connected to the oven by hinges.

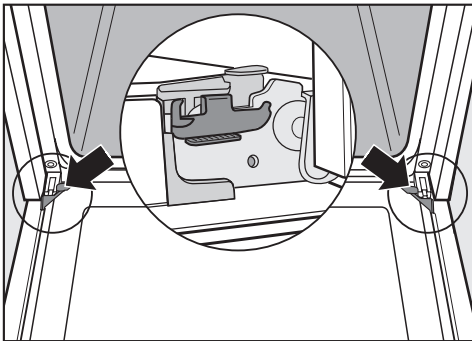

Before removing the door, the locking clamps on both hinges have to be released.

- Open the door fully.

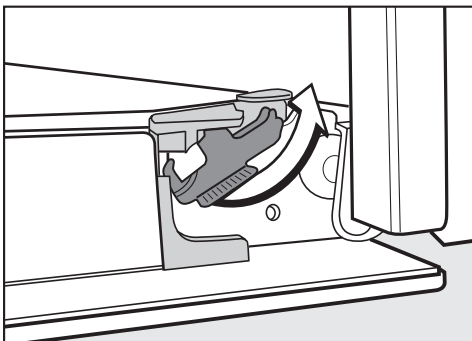

- To release the locking clamps on the hinges turn them upwards as far as they will go until they are at an angle. See illustration.

- Then lift the door upwards as far as it will go.

Do not attempt to take the door off the hinge guides when it is in a horizontal position. The guides will close, and damage the appliance. Danger of injury.



- Hold the door securely at both sides and lift upwards off the hinge guides.

Do not lift the door off by the handle. The handle could break and damage the door.

Make sure that you lift the door off equally on both sides.

To dismantle the oven door

The oven door is made up of three panes of glass and has vents at the top and bottom.

When the oven is operating, air is circulated through the door to keep the outer pane cool.

If condensate has worked its way in between the glass panes, the door can be dismantled in order to clean in between the panes.

When cleaning the glass panes please follow the same instructions given for cleaning the appliance front.

Do not use abrasive cleaning agents, sponges or brushes, as these can scratch the surface. These could damage the surface. Scratches can also cause the glass to break.

Do not use an oven spray. This will damage the surface of the aluminium surrounds.

To avoid the risk of breakage, it is advisable to place the panes on a table protected by a soft cloth (e.g. a towel).

Always remove the oven door before dismantling it.

- Place the door on a protective surface (e.g. on a table cloth) to prevent it getting scratched. The door handle should line up with the edge of the table. Make sure the glass lies flat and does not get broken during cleaning.

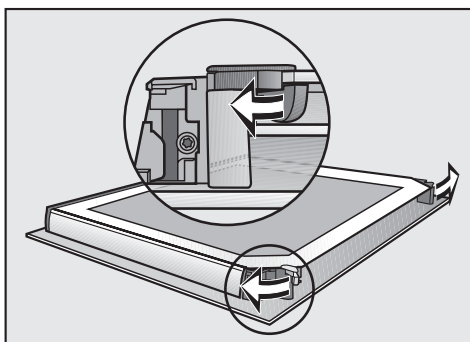

- Flip the glass pane retainers outwards to open them.

You can now remove the inner and middle panes.

Cleaning and care

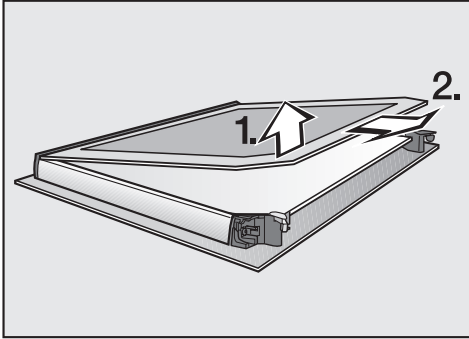

- **Gently** lift the inner pane up and out of the plastic strip.

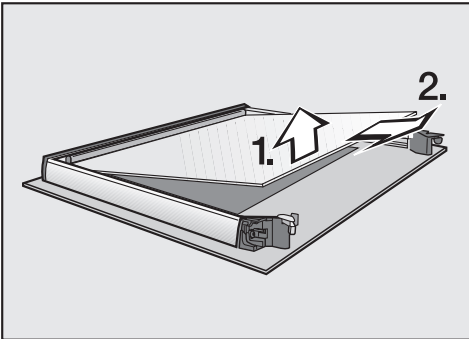

- Gently lift the middle pane and remove it together with the seal.
- Remove the seal from the pane.

- Clean the glass panes and other parts with a Miele E-cloth or a clean sponge and a solution of hot water with a little washing-up liquid. Wipe dry using a soft cloth.

- To refit the door:

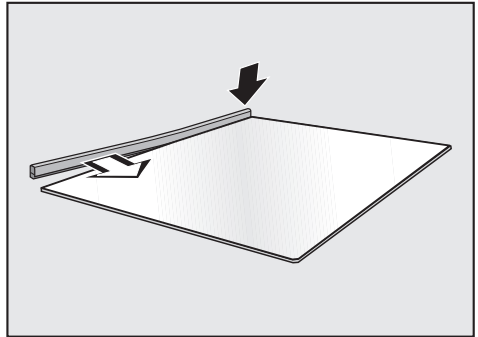

- Secure the seal to the middle pane.

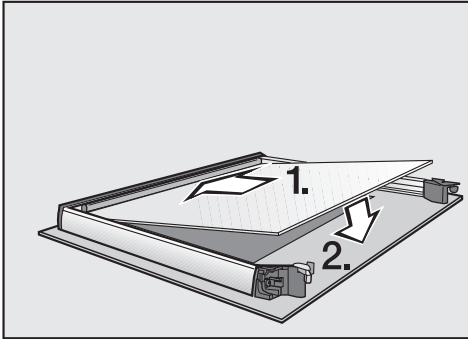

- Refit the middle pane and the seal.

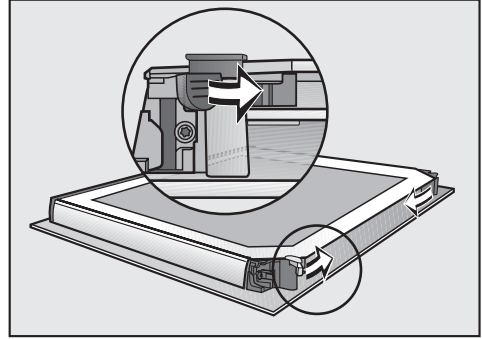

- Flip the glass pane retainers inwards to close them.

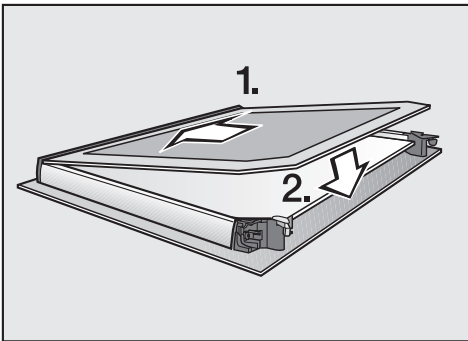

- Push the inner pane into the plastic strip and place it between the retainers.
"Miele" must be visible at the top.

Cleaning and care

To refit the door

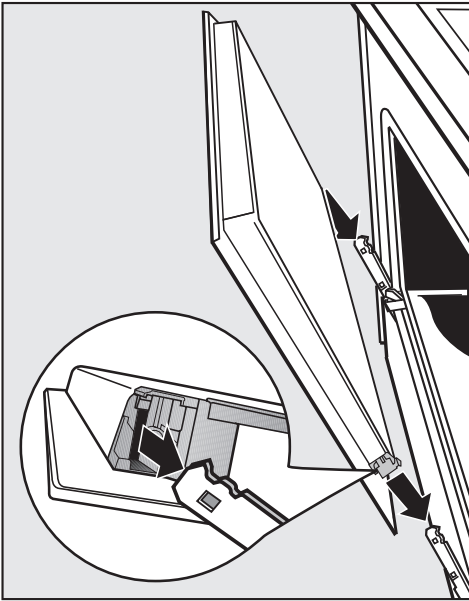

- Hold the door securely at both sides and carefully fit it back onto the hinge guides.

Make sure that the door goes back on straight.

- Open the door fully.

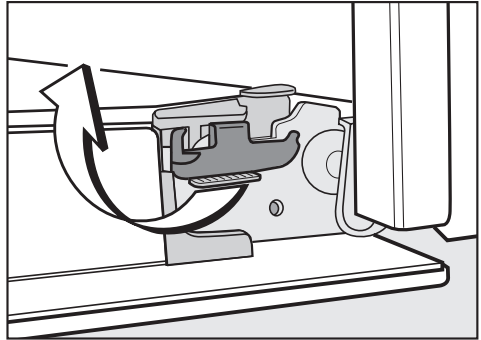

- Flip both locking clamps back up as far as they will go into a horizontal position.

It is essential that the locking clamps are flipped down when the door is refitted after cleaning. Otherwise the hinges could work loose, resulting in damage to the door.

To remove the runners

Make sure the oven heating elements are switched off and cool.
Danger of burning.

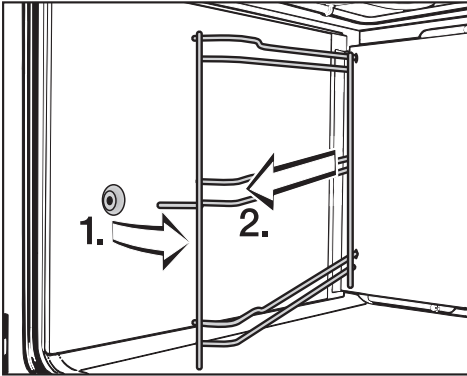

- Pull the runners forwards out of the holder and remove.

Reassemble in the reverse order, carefully ensuring all parts are correctly in place.

To remove the catalytic enamelled back panel and roof liner

Make sure the oven heating elements are switched off and cool.
Danger of burning.

See "Cleaning and care" for information on cleaning.

Back panel

- Remove the runners.
- Loosen the screws in the back panel and take it out.

The oven must not be used without the back panel fitted. This could cause considerable injury.

Reassemble in the reverse order, carefully ensuring all parts are correctly in place.

Cleaning and care

Roof liner

- Remove the runners.

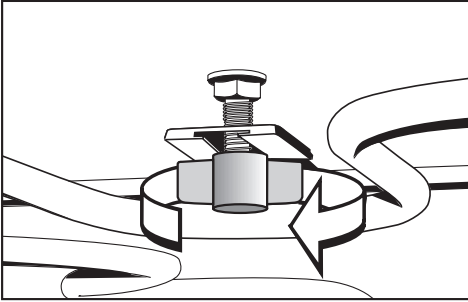

- Unscrew the wing nut.
- Gently lower the element.

Do not use force to pull it down as this can cause the element to break.

- Take out the roof liner.

Reassemble in the reverse order, carefully ensuring all parts are correctly in place.



Problem solving guide

With the aid of the following guide, minor problems can be easily corrected without contacting Miele.

 Do not attempt to open the appliance casing yourself! Installation, maintenance and repairs may only be carried out by a suitably qualified and competent person in strict accordance with current national and local safety regulations. Repairs and other work by unqualified persons could be dangerous. The manufacturer cannot be held liable for unauthorised work.

Problem	Possible cause and remedy
The display is dark.	<ul style="list-style-type: none">– Check whether the time of day display is set so that it does not show in the display (see "Settings  - P I").– Check whether the mains fuse has tripped. If it has not tripped, contact a qualified electrician or Miele.
The oven does not heat up.	<ul style="list-style-type: none">– Check if the system lock has been activated.– Check whether the mains fuse has tripped. If it has not tripped, contact a qualified electrician or Miele.
The time of day or "12:00" is flashing in the display.	There has been a power cut. Confirm the time of day with the OK sensor, or reset the time. You will have to enter programmed cooking processes again.
A noise can be heard after a cooking process.	This is not a fault. The cooling fan continues to operate after a programme has finished. It switches itself off once the oven has dropped to a certain temperature.

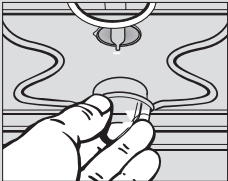
Problem solving guide

Problem	Possible cause and remedy
<p>The interior lamp is not working.</p> 	<ul style="list-style-type: none"> ■ Disconnect the appliance from the electricity supply: Switch off and unplug at the socket, or disconnect the fuse, or switch off at the isolator as appropriate. ■ Turn the lamp cover a quarter turn anti-clockwise to release it and then pull it downwards to take it out. ■ Replace it with a new lamp (Osram 66725 AM/A, 230 V, 25 W, G9). ■ Refit the lamp cover and turn it clockwise to secure it. ■ Reconnect the appliance to the mains electricity supply.
<p>Cakes and biscuits are not cooked properly after following the times given in the chart.</p>	<ul style="list-style-type: none"> – Check that the correct temperature has been set. – Check whether there has been a change to the recipe. The addition of more liquid or more eggs makes a moister mix which would need longer to cook.
<p>Cakes / biscuits are browning unevenly.</p>	<p>There will always be a slight unevenness. If browning is very uneven check that the correct temperature was set and that the correct shelf level was used.</p> <p>With conventional heat  the material and colour of the tin used plays an important role. Light coloured, shiny tins are less suitable.</p>
<p>There are spots like rust on the catalytic surfaces.</p>	<p>When roasting on the rack, the circulating air sometimes picks up spices, which are then deposited on the oven interior walls. These residues are not removed by catalytic cleaning, and should be removed while fresh with a mild solution of hot water and washing-up liquid applied with a soft brush.</p>
<p>A fault code appears in the display F + a number</p>	<p>You can rectify the following faults yourself:</p> <ul style="list-style-type: none"> – Fault 55: Safety switch-off has been triggered. The appliance will be ready for use again after it has been switched off and then back on again. <p>For all other fault codes please contact the Miele Service Department.</p>

In the event of any faults which you cannot remedy yourself, or if the appliance is under guarantee, please contact

– your Miele Dealer

or

– Miele (see back cover for address).

A call-out charge will be applied for service visits where the problem could have been resolved as described in these instructions.

When contacting Miele, please quote the model and serial number of your appliance.

These are shown on the data plate, visible on the front frame of the oven, with the door fully open.

Please note that telephone calls may be monitored and recorded to improve our service.

Optional accessories

The following accessories may come as standard with some models. They are also available to order at extra cost via the internet on www.miele-shop.com, your Miele Dealer or the Miele Spare Parts Department.

FlexiClip telescopic runners

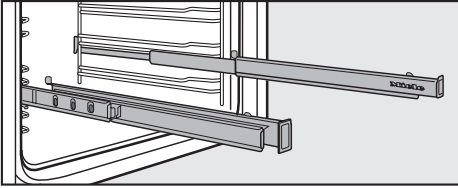

The FlexiClip telescopic runners can be used on any shelf level. Each shelf level can be drawn right out of the oven individually to give a good overview of cooking in progress.

You can fit a FlexiClip runners to all the shelf runners at the same time.

Baking tray, universal tray and rack

These items, supplied with your oven, are also available to order.

When ordering, please quote the model number of your appliance.

Pizza stone

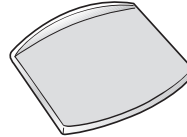

The pizza stone is ideal for items which need a well baked base such as pizza, quiche, bread, bread rolls and savoury snacks.

The baking stone is made from heat retaining fire brick and is glazed. Place it directly on the rack.

A paddle made of untreated wood is supplied with it for placing food on the pizza stone and taking it off.

Flan/Pizza dish

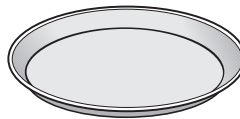

This circular pan is suitable for cooking pizzas, flat cakes made with yeast or whisked mixtures, sweet and savoury tarts, baked desserts, and can also be used for frozen cakes and pizzas.

The surface has been treated with PerfectClean enamel.

Gourmet oven dish

The gourmet oven dish can be placed in the oven directly on the runners. It has non-tip safety notches like the universal tray to prevent it being pulled out too far.

It has an anti-stick coating.

It is available in two sizes:

- HUB 5000-M (internal dimensions approx. 38 x 22 x 8 cm)

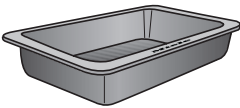

- HUB 5000-XL (internal dimensions approx. 38 x 35 x 8 cm)

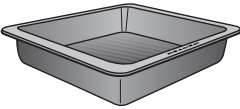

Gourmet oven dish lid

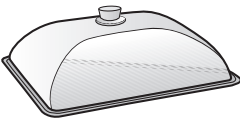
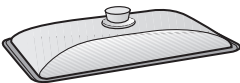

When ordering a lid, please specify the gourmet oven dish it is to be used with (HUB 5000 M or XL).

Please note:

The HUB 5000-XL gourmet oven dish will not fit in this compact oven with the lid on as it will be too high.

Catalytic enamelled roof liner

The roof liner is fitted above the top heating element.

When ordering, please quote the model number of your appliance.

Miele E-cloth

Removes grease and stains and leaves no smearing. Suitable for cleaning surfaces such as stainless steel, glass, plastic and chrome without the use of chemicals.

Miele oven cleaner

Suitable for removing stubborn soiling. It is not necessary to pre-heat the oven beforehand.

Electrical connection

All electrical work should be undertaken by a suitably qualified and competent person in strict accordance with current national and local safety regulations (BS 7671 in the UK).

Installation, repairs and other work by unqualified persons could be dangerous. The manufacturer cannot be held liable for unauthorised work.

Ensure power is not supplied to the appliance until after installation or repair work has been carried out.

The **voltage and connected load** are given on the data plate, visible below the oven interior, with the door open. Ensure that these match the household mains supply. Please quote these data, and the model and serial number when contacting Miele.

Connection of this appliance should be made via a fused connection unit or a suitable isolator, which complies with national and local safety regulations, and the on/off switch should be easily accessible after the appliance has been built in.

If the switch is not accessible after installation (depending on country) an additional means of disconnection must be provided for all poles.

For extra safety it is advisable to protect the appliance with a residual current device (RCD). Please contact a qualified electrician for advice.

When switched off there must be an all-pole contact gap of 3 mm in the

isolator switch (including switch, fuses and relays acc. to EN 60 335).

Important U.K.

The appliance is supplied for connection to a 230-240 V, 50 Hz supply with a 3-core cable.

The wires in the mains lead are coloured in accordance with the following code:

Green/yellow = earth

Blue = neutral

Brown = live

WARNING THIS APPLIANCE MUST BE EARTHED

When replacing the cable supplied with another cable or changing the connection, only cable type H 05 VV-F or H 05 RR-F with a suitable cross-sectional area (CSA) may be used (available from the Miele Customer Contact Centre).

Dimensions are give in "mm".

Appliance dimensions and unit cut-out

Installation in a base unit

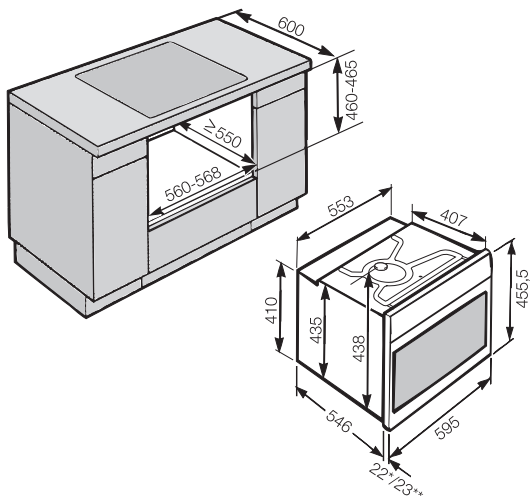

Installation in a tall unit

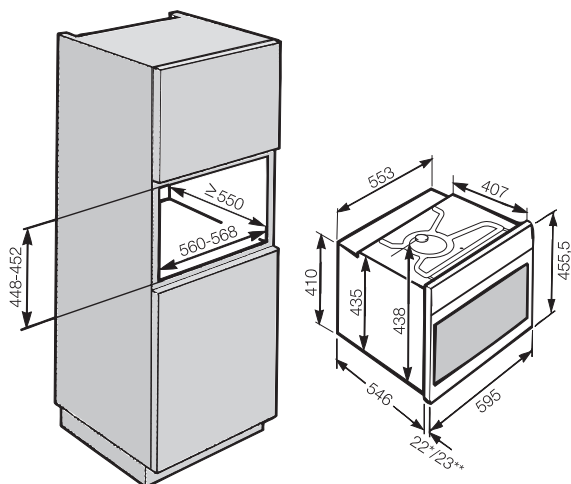

* Appliances with glass front

** Appliances with metal front

Building-in diagrams

Front dimensions

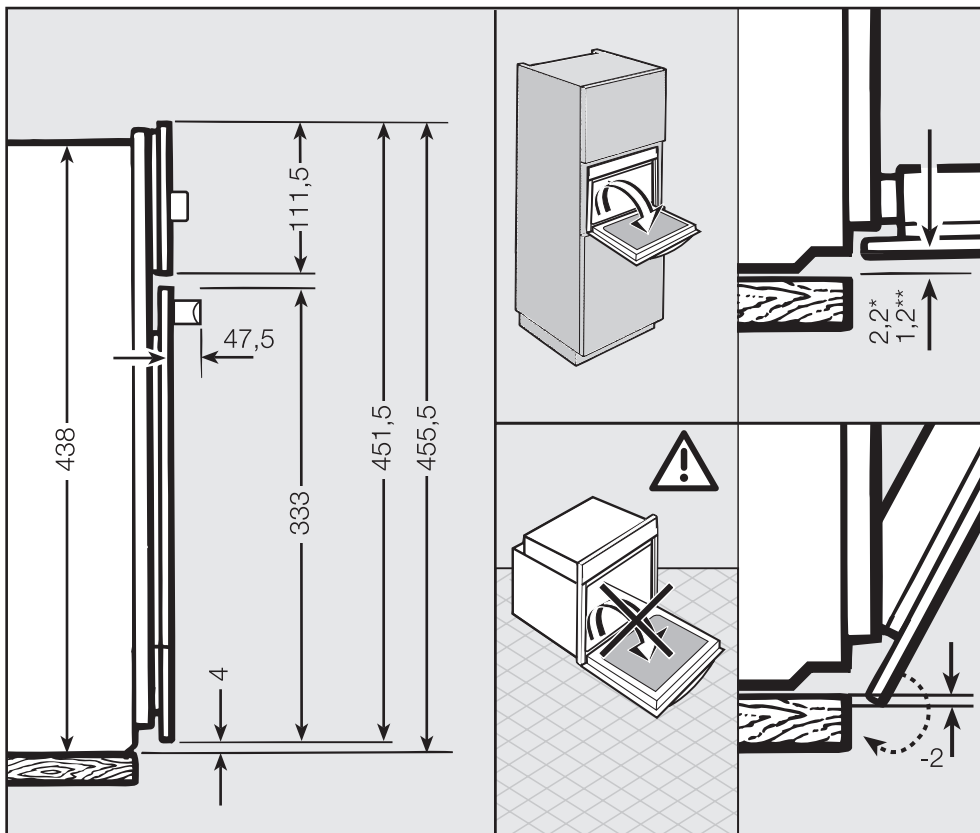

* Appliances with glass front

** Appliances with metal front

Installing the oven

 The appliance must not be operated until it has been correctly installed in its housing unit. Otherwise it poses an electric shock hazard.

Important. Do not fit insulation material inside the housing unit. This would hinder the intake of air to the appliance.

When installing the appliance do not lift it up by the door handle as this can damage the door.

Turn off the mains electricity supply to the isolator.

- Connect the mains cable from the oven to the isolator.
- Push the appliance into the oven housing unit and align it.

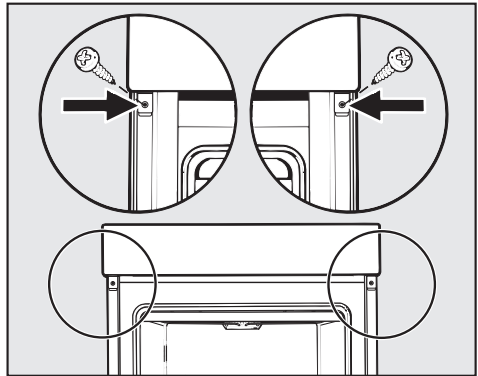

- Open the oven door and using two screws secure it to the side walls of the housing unit through the holes in the oven trim.

United Kingdom

Miele Co. Ltd.
Fairacres, Marcham Road
Abingdon, Oxon, OX14 1TW
Tel: 0845 365 0555
Fax: 0845 365 0777
Customer Contact Centre Tel: 0845 365 6600
E-mail: info@miele.co.uk
Internet: www.miele.co.uk

Australia

Miele Australia Pty. Ltd.
ABN 96 005 635 398
1 Gilbert Park Drive, Knoxfield, VIC 3180
Tel: (03) 9764 7130, Fax: (03) 9764 7149
Internet: www.miele.com.au

China

Miele (Shanghai) Trading Ltd.
1-3 Floor, No. 82 Shi Men Yi Road
Jing' an District
200040 Shanghai, PRC
Tel: +86 21 6157 3500
Fax: +86 21 6157 3511
E-mail: mieleshanghai@cn.miele.com
Internet: www.miele.cn

Miele (Hong Kong) Limited

41/F - 4101, Manhattan Place
23 Wang Tai Road
Kowloon Bay
Hong Kong
Tel: (852) 2610 1331
Fax: (852) 2610 1013
Email: mielehk@miele.com.hk

India

Miele India Pvt. Ltd.
Ground Floor, Copia Corporate Suites
Plot No. 9, Jasola
New Delhi - 110025
Tel: 011-46 900 000, Fax: 011-46 900 001
E-mail: customercare@miele.in
Internet: www.miele.in

Manufacturer: Germany - Miele & Cie. KG
Carl-Miele-Straße 29, 33332 Gütersloh



Ireland

Miele Ireland Ltd.
2024 Bianconi Avenue
Citywest Business Campus, Dublin 24
Tel: (01) 461 07 10, Fax: (01) 461 07 97
E-Mail: info@miele.ie, Internet: www.miele.ie

New Zealand

Miele New Zealand Limited
Unit L, 10-20 Sylvia Park Road
Mt. Wellington, 1060, Auckland, NZ
Tel: 0800 264 353, Fax: 0800 463 453
Internet: www.miele.co.nz

Singapore

Miele Southeast Asia
Miele Pte. Ltd.
163 Penang Road
04 - 02/03 Winsland House II
Singapore 238463
Tel: +65 6735 1191, Fax: +65 6735 1161
E-Mail: infosea@miele.com.sg
Internet: www.miele.sg

South Africa

Miele (Pty) Ltd
63 Peter Place, Bryanston 2194
P.O. Box 69434, Bryanston 2021
Tel: +27 (0) 11 548-1900
Fax: +27 (0) 11 548-1935
E-mail: info@miele.co.za
Internet: www.miele.co.za

United Arab Emirates

Miele Appliances Ltd.
P.O. Box 11 47 82
Gold & Diamond Park
Sheikh Zayed Road
Building 6 / Offices Nos. 6-214 to 6-220
Dubai
Tel: +971-4-341 84 44
Fax: +971-4-341 88 52
E-Mail: info@miele.ae
Internet: www.miele.ae

Free Manuals Download Website

<http://myh66.com>

<http://usermanuals.us>

<http://www.somanuals.com>

<http://www.4manuals.cc>

<http://www.manual-lib.com>

<http://www.404manual.com>

<http://www.luxmanual.com>

<http://aubethermostatmanual.com>

Golf course search by state

<http://golfingnear.com>

Email search by domain

<http://emailbydomain.com>

Auto manuals search

<http://auto.somanuals.com>

TV manuals search

<http://tv.somanuals.com>