

Operating instructions

Commercial dishwasher
PG 8083 SCVi



To avoid the risk of personal injury or damage to the appliance, it is **essential** that you read the operating and installation instructions before installation and use.

en - CA

M.-Nr. 09 501 370

Contents

Guide to the manual	5
Guide to the commercial dishwasher	6
Overview	6
Control panel	7
Intended use	8
Safety instructions and warnings	10
Caring for the environment	16
Disposal of the packaging	16
Disposing of your old appliance	16
Energy saving washing	17
Before using for the first time	18
To open the door	18
Closing the door	18
Display functions	19
Basic settings	20
Language	20
Water hardness	20
Before using the commercial dishwasher for the first time you will need:	21
Filling the salt reservoir	21
Refill salt indicator	23
Rinse aid	24
Adding rinse aid	24
Rinse aid indicator	25
Loading the commercial dishwasher	26
Items not recommended for dishwashing:	27
Typical load for 10 place settings with cutlery tray	28
Typical load for 16 place settings with cutlery tray	29
Upper basket	30
Foldable spikes	30
Cup rack	30
XXL cup rack	31
Glass support bar	31
Adjusting the upper basket	32
Lower basket	33
Removable MultiComfort insert	34
Glass rack	34
Glass support bar	35
Foldable spikes	35

Bottle holder	35
Cutlery	36
3D cutlery tray	36
Operating the commercial dishwasher	37
Detergent	37
Adding detergent	38
Turning the commercial dishwasher on	39
Selecting a program	39
Starting the program	39
Time display	40
Standby	40
End of program	41
Turning the commercial dishwasher off	41
Unloading the commercial dishwasher	41
Interrupting a program	42
Changing a program	42
Additional functions	43
Extra drying	43
Delay start	44
BrilliantLight	45
Cleaning and care	46
Cleaning the wash cabinet	46
Cleaning the door and the door seal	46
Cleaning the reflector panel	46
Cleaning the control panel and front of the commercial dishwasher	47
Checking the filters in the wash cabinet	48
Cleaning the filters	48
Cleaning the spray arms	50
Problem solving guide	51
Technical faults	51
Faults in the water intake or water drain	53
General problems with the commercial dishwasher	55
Noises	57
Poor cleaning results	58
Maintenance	61
Cleaning the water inlet screen	61
Cleaning the drain pump and non-return valve	62
Optional accessories	63

Contents

Program guide	64
Service	67
Repairs	67
Program updates	67
Electrical connection	68
Plumbing	71
The Miele waterproof system	71
Water intake	71
Water drainage	73
Technical data	74
Settings menu	75
Opening the "Settings "menu	75
Language 	75
Water hardness	76
Rinse aid	77
Buzzer	77
AutoOpen	78
Optimizing Standby	78
Refill messages	79
Brightness	79
Contrast	79
Filter check	79
External Dos.	79
Detergent dosage	80
Venting the Dos. system	81
High temp rinse	81
Water plus	81
Preselect progr	81
Showroom program	82
Factory default	82
To close the Settings menu	82
Noise measurement	83
General requirements for measuring noise	83
Installation requirements for measuring noise	83

Text which is highlighted or emphasized

Warnings



Warnings marked with a thick framed box and a warning symbol contain safety information concerning potential injury and damage.



Read the warnings carefully and follow the instructions and directions.

Notes

Notes contain information that is particularly important to follow and are highlighted in a thick framed box.

Additional information and comments

Additional information and comments are contained in a simple frame. They are not imperative for the operation of the commercial dishwasher.

Operating steps

Specially marked instructions indicate the steps for operating the commercial dishwasher. They explain the procedure step by step. Operating steps are identified by a black square.

Example:

- Select the desired setting and press the centre button to confirm.

Display

The information is displayed in a special character font like that in the display.

Example:

When the display shows the message  **Finished** or **AutoOpen**

Guide to the commercial dishwasher

Overview

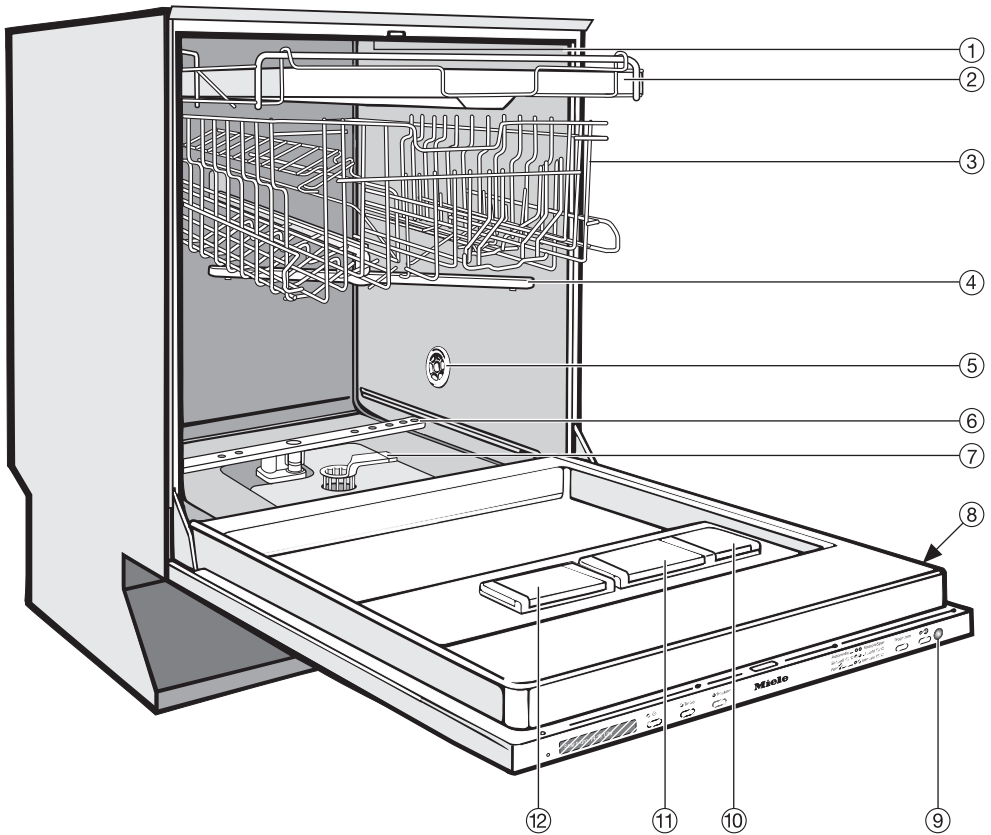

① Upper spray arm (not visible)

② Cutlery tray

③ Upper basket

④ Middle spray arm

⑤ Air inlet for drying

⑥ Lower spray arm

⑦ Filter combination

⑧ Data plate

⑨ In-operation indicator light

⑩ Rinse aid reservoir





⑪ Dual-compartment detergent dispenser

⑫ Reservoir for regenerating salt

Guide to the commercial dishwasher

Control panel



- ① Display
- ②  > button, (additional programs) with indicator light
- ③  button (Delay start) with indicator light
- ④  button + (Extra drying) with indicator light
- ⑤ Program selection
- ⑥  button (Program selector) for scrolling through the programs
- ⑦  (On/Off) button with indicator light
- ⑧ In-operation indicator light

Intended use

This commercial dishwasher complies with all current safety requirements. However, improper use can result in personal injury and material damage.

To avoid the risk of accidents and damage to the appliance, read the operating instructions carefully before using the appliance for the first time. They contain important information on installation, safety, operation and maintenance.

Keep the instructions in a safe place and pass them along to any future owner!

Intended use

▶ This commercial dishwasher with its short program running times and powerful cleaning performance is intended for commercial use in offices, lunch rooms, clubhouses, workshops, active kitchens and other similar commercial environments.

It can also be used in domestic households and in similar residential environments and other related establishments.

▶ This commercial dishwasher is not intended for continuous use.

▶ This dishwasher is not suitable for processing medical devices and laboratory glassware.

▶ This dishwasher is not suitable for high temperature sanitizing defined by Provincial Food Regulations (Sanitizing Code)

- ▶ Use this commercial dishwasher only for "Dishwashing" as defined in the Operating instructions, i.e. for cleaning dishes and cutlery. Any other use, conversion or modification is not permissible and possibly hazardous.
Miele will not be held liable for damage caused by inappropriate use or improper operation.
- ▶ This commercial dishwasher is intended for stationary indoor use only.
- ▶ The special inserts are to be used for their specific purpose only.
- ▶ Individuals who are incapable of using the appliance safely because of limited physical, sensory or mental capabilities or lack of experience or knowledge must not use this appliance without supervision or instruction by a responsible person.

Safety instructions and warnings

Proper installation

- ▶ Do NOT install the appliance in an area where there is a risk of explosion or freezing.
- ▶ To ensure the stability of undercounter commercial dishwashers, they must only be installed beneath a continuous countertop that is bolted to the adjacent cabinetry.
- ▶ In order to reduce the risk of damage from condensation, the furniture in the area around the appliance should be designed for professional use.

Technical safety

- ▶ The appliance should only be put into operation, serviced or repaired by Miele Service. Miele assumes no liability for any hazards arising from improper installation, maintenance or repairs performed by unauthorized persons!
- ▶ Untrained personnel must not be permitted to operate the commercial dishwasher. Operating personnel must receive regular training.
- ▶ Before using the appliance, check for visible external damage. Never operate a damaged commercial dishwasher. A damaged commercial dishwasher can jeopardize your safety!
- ▶ Immediately shut down a damaged or leaking commercial dishwasher and notify Miele Service.
- ▶ The appliance should only be repaired by Miele Service. Otherwise the warranty becomes null and void.
- ▶ Defective components must be replaced with genuine Miele spare parts only. Only these parts are guaranteed by Miele to comply with safety requirements.

Safety instructions and warnings

- ▶ Do not connect the appliance to the electrical power supply until all the installation work has been completed, including adjustment of the door spring.
- ▶ The electrical safety of this appliance is only ensured if it is properly grounded in compliance with applicable safety regulations. If in doubt, have the on-site wiring checked by a qualified electrician.
Miele will not be held liable for damage or injury (such as electric shock) caused by a missing or broken ground wire.
- ▶ Be sure to follow the installation instructions in this manual and in the installation diagram.
- ▶ Before connecting the appliance, ensure that the connection data on the data plate (voltage, frequency and fuse rating) match the building's electrical supply.
- ▶ There must be no electrical outlet behind the commercial dishwasher. Risk of overheating if the commercial dishwasher were to be pushed up against a plug (see Electrical connection).
- ▶ Do not connect the appliance to the power supply with a power bar or unsuitable extension cord as they do not ensure the required safety of the commercial dishwasher (and could cause overheating, for example).
- ▶ The appliance must not be installed underneath a cooktop. The high radiant temperatures could damage the commercial dishwasher. For the same reason, the commercial dishwasher must not be installed directly next to "non-kitchen" radiant appliances (e.g. open flame devices for heating purposes, etc.).
- ▶ NEVER open the appliance housing. Any interference with connections carrying voltage or changes in the electrical or mechanical set up, will endanger you and may impair the functioning of the appliance.

Safety instructions and warnings

- ▶ Do NOT use the appliance if the power cord is damaged. A damaged power cord must be replaced with a special cord. For safety reasons, the cord must be installed by Miele Service.
- ▶ Before servicing the appliance, disconnect it from the power supply.
- ▶ The plastic housing of the water connection contains an electrical valve. Do not immerse the housing in liquids.
- ▶ The intake hose contains electrical wires. Therefore, do not shorten the hose.

Proper use

- ▶ This commercial dishwasher is designed only for operation with water and detergents designed for dishwashers or professional dishwashers. Organic solvents or flammable liquids must NOT be used in the appliance.
There is a risk of explosion and/or damage through the destruction of rubber or plastic components resulting in leaks.
- ▶ Only use detergents suitable for dishwashers or commercial dishwashers. Using other detergents may damage the dishware and/or the commercial dishwasher.
- ▶ For applications where sanitizing is required use "SaniWash Program" with sanitizing at 70 °C or optional 75°C.
- ▶ Do not stand or sit on the open door. This could damage the appliance.
- ▶ The supply line to the commercial dishwasher must be bled after work has been performed on the water supply network. Failure to do so can result in damage to components.
- ▶ Do not leave the commercial dishwasher door open when the machine is not in use. You could hurt yourself on the open door.
- ▶ Beware of the high temperatures when operating this appliance. Be aware of the risk of scalding or burning when opening the door! Dishes, cutlery, baskets and inserts must first cool off. Empty any hot water remaining in hollow items into the wash cabinet.
- ▶ The water in the wash cabinet is NOT safe to drink!
- ▶ Certain pre-treatments (for example with dishwashing liquid or other detergents) as well as certain contaminants and some cleaning agents can generate foam. Foam can adversely affect the cleaning performance.

Safety instructions and warnings

- ▶ Foam escaping from the wash cabinet can damage the appliance. If any foam is escaping, cancel the program immediately!
- ▶ When using detergents and special products, always follow the manufacturer's instructions. In order to avoid material damage or potential chemical reactions (such as explosive hydrogen gas reactions), use detergents only for the applications specified by the manufacturer.
- ▶ Avoid inhaling powder detergents! Do NOT swallow detergents! Detergents can cause chemical burns to nose, mouth and throat. Seek medical help immediately if you have inhaled or swallowed any detergent. Observe the detergent manufacturer's safety instructions.
- ▶ Miele does not accept any liability for the effect of chemical cleaning agents on the dishware. Observe the detergent manufacturer's directions for storage, use and dosage.
- ▶ To prevent corrosion and damage to materials, ensure that no acids, chloride solutions or corrosive iron materials are introduced into the wash cabinet.
- ▶ Do NOT hose down the appliance or its immediate vicinity, e.g. with a water hose or pressure washer.
- ▶ Be aware of the potential for injury when utensils with sharp, pointed ends are placed upright. Position them so they cannot cause injury.
- ▶ Remove all large food and liquid residues from the tableware before loading.

Children in the vicinity

- ▶ Always supervise any children in the vicinity of the appliance. Never allow children to play with the appliance. Among other hazards, children run the risk of locking themselves in the commercial dishwasher!
- ▶ Do not allow children to operate the commercial dishwasher.
- ▶ Keep detergents away from children! If detergents are ingested, they can cause chemical burns in the mouth and throat, or even suffocation. Therefore, keep children away from the commercial dishwasher when open. There may still be detergent residues in the appliance.
Seek medical help immediately if a child has ingested any detergent.

Accessories

- ▶ Accessories may only be attached or installed if they have been expressly approved by Miele for this appliance. Adding or installing other parts will void any warranty and/or product liability claims.

The manufacturer will not be held liable for damage caused by failure to comply with the safety instructions and warnings.

SAVE THESE INSTRUCTIONS

Caring for the environment

Disposal of the packaging

The packaging protects the commercial dishwasher from damage during shipping. They have been selected for environmental friendliness and can be recycled.

The packaging comprises the following materials:

Exterior packaging:

- Corrugated cardboard made of up to 100% recycled material, or: polyethylene (PE) stretch wrap film
- Polypropylene (PP) tightening straps

Interior packaging:

- Expanding polystyrene (EPS) without chlorine or fluorine
- Floor, lid frame and support strips made of untreated natural wood harvested from forest stewardship forests
- Polyethylene (PE) protective film

Returning the packaging to the materials cycle saves raw materials and reduces waste. Your local community waste collection / recycling centre will tell you where the nearest return depot is located.

Disposing of your old appliance

Old electric and electronic equipment still contains useful materials that can be recovered. However, it may also contain harmful substances that were necessary for their function and safe use. Improperly disposing of these items in your household waste can be harmful to your health and the environment. This is why it is important NEVER to dispose of your old appliance in your regular household waste.

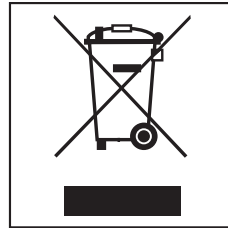

Instead, use your local community waste collection and recycling centre for electric and electronic appliances.

If the appliance is being stored prior to disposal, please make sure it is child-proof.

All the plastics in the appliance are marked with standard international symbols. This allows the separation of different plastic waste materials for recycling.

Energy saving washing

This commercial dishwasher is a water and energy saving appliance.

For best results follow these tips:

- You may connect the commercial dishwasher to a hot water line. This is particularly suitable with energy-saving water heating sources such as solar energy systems. If the hot water system is electrically heated and if loads comprise primarily glassware we recommend connecting the appliance to the cold water line.
- Make full use of the baskets' capacity without overloading. This ensures the most economical washing.
- Choose a program that best suits the degree of soiling and the type of dishes being washed.
- Use the Normal program for energy saving dishwashing. From the aspect of combined energy and water consumption, this program is the most efficient for washing normally soiled dishes.
- Observe the detergent manufacturer's recommendations for detergent dosage.

- When using powder or liquid detergent, you can reduce the amount by $\frac{1}{3}$ of the normal dosage if the baskets are only half full.

Before using for the first time

To open the door

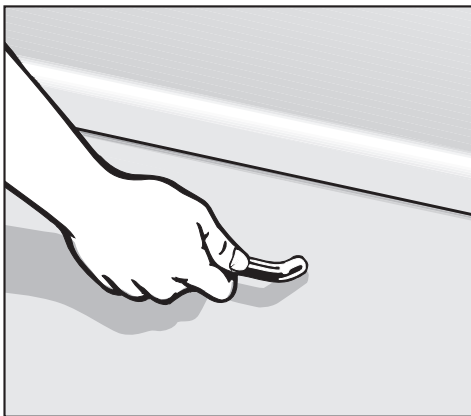

At the end of programs with a drying cycle (see "Program guide") the door will automatically open a little in order to improve the drying.

You can cancel this function (see "Settings menu - AutoOpen").

- Pull the handle.

If the door is opened during operation the commercial dishwasher will automatically stop running.

 Do not block the area in which the door opens.

Closing the door

- Push the baskets in.
- Push the door until it clicks shut.

 Keep your fingers off the door frame. You may crush your fingers.

Display functions

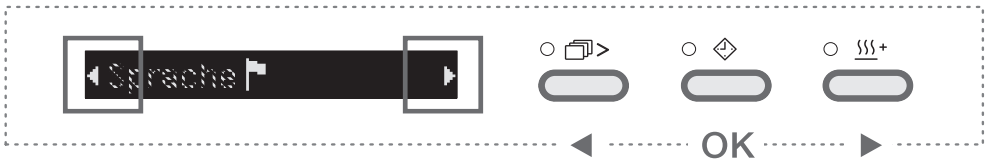

General

The following functions can be selected or set with the display:

- the wash program
- the Delay start time
- the settings

The following appears in the display while a program is running:

- the present program step
- the estimated remaining runtime
- any faults or other messages

In order to save energy, the dishwasher will switch to Standby-mode within a few minutes if no program is running and no button is pressed. After several more minutes it switches off completely (see Operating the commercial dishwasher - Standby). To turn the commercial dishwasher back on, press the  button.

Settings menu

The Settings menu allows you to set the commercial dishwasher to suit your special requirements.

You can open the Settings menu by pressing a specific button combination.

For further information see Settings menu.

The normal functions of the buttons next to the display are not active with the Settings menu, allowing you to select and confirm menu items using these buttons.

The left and right arrows in the display indicate that additional selections are available. You can choose these selections with the left or right button below the display.

Use the centre button below the display to confirm messages or settings and to switch to the next menu or submenu.

The currently selected setting is marked with a check .

Before using for the first time

Basic settings

- Press the  button to turn the commercial dishwasher on.

If the commercial dishwasher is being turned on for the first time, the welcome screen will appear.

Language

The display automatically switches to the language setting.

For details about the display, see chapter Display.

- Select the desired language and confirm with the centre button.

The selected language is marked with a ✓.

Water hardness

The display changes to the water hardness setting.

- The commercial dishwasher must be correctly programmed to match the hardness of your water.
- Your local waterworks will be able to advise you of the water hardness in your area.
- Where the water hardness fluctuates (e.g. 17 - 25 gr/gal), always use the higher value (in this example 25 gr/gal).

It is useful to know your water hardness so that you can provide the service technician with this information in the event of any service calls.



Please note your water hardness below:

_____ gr/gal

The water hardness factory setting is programmed at 15 gr/gal (270 ppm CaCO₃).

- Select the hardness of your water supply and confirm with the centre button.

See "Settings menu - Water hardness" for more information.

If the display now shows  **Add rinse aid** and  **Add salt**, press any button to confirm. The display changes to the main menu.

These basic settings are saved after the first full program cycle is completed.

The Welcome screen is no longer displayed after the first full program cycle is completed.

Before using the commercial dishwasher for the first time you will need:

- approx. 1 kg reactivation salt,
- approx. 110 ml rinse aid,
- for detergent see "Operating the commercial dishwasher". For available process chemicals from Miele contact Miele Professional.

Every commercial dishwasher is tested before leaving the factory. There may be residual water in the machine from this testing. This is not an indication that it has been previously used.

Filling the salt reservoir

To achieve good cleaning results, the commercial dishwasher needs soft water (water that is low in minerals). Hard water results in white deposits on dishware and in the dishwasher. Therefore, tap water with a hardness of 4 gr/gal (70 ppm CaCO_3) or more must be softened. This takes place automatically in the integrated water softener. The water softener requires reactivation salt. The water softener is suitable for a water hardness of up to 36 gr/gal (650 ppm CaCO_3).

See "Settings menu - Water hardness" for setting the water softener.

If the hardness of your water is always **below 4 gr/gal (= 70 ppm CaCO_3)**, you do **not need any salt**. However, you must still program your dishwasher for your water hardness.

 Do not fill the salt reservoir with dishwashing detergent (even liquid detergent). Dishwashing detergent will damage the water softener.

 Use only special, coarse-grained reactivation salt. Other types of salt may contain insoluble components which can damage the water softener.

Before using for the first time

- Only open the door **half way** when adding salt to avoid spilling it.

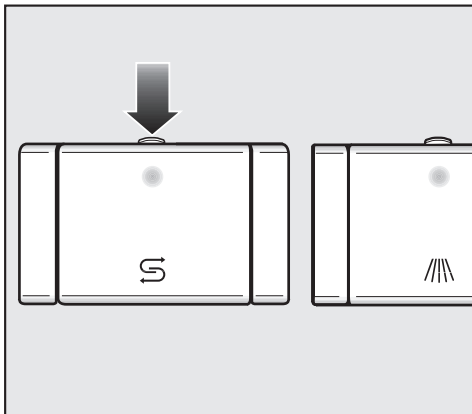

- Press the button on the top of the salt reservoir in the direction of the arrow. The cover will pop open.

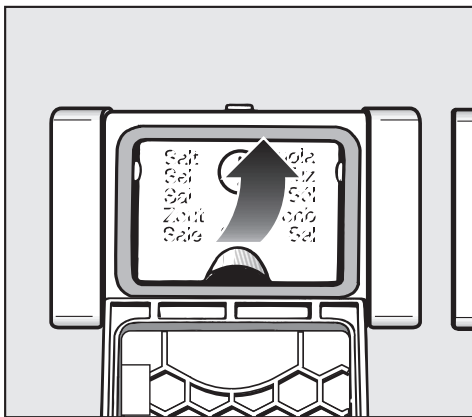

- Open the funnel.

Do **not** fill water into the salt reservoir!

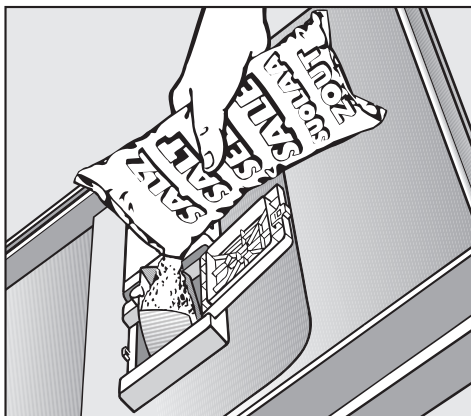

- Only add just enough salt to fill the reservoir. Depending on the type of salt, the reservoir will hold up to approx. 1 kg.

Never fill with more than 1 kg of salt.

Displaced water may run out as the reservoir is being filled.

- Clean any excess salt from the filling area and close the cover of the reservoir.
- Immediately run the "Pre-wash" program without a load in order to remove any traces of brine from the cabinet.

Refill salt indicator

- Refill the salt reservoir as soon as the  **Add salt** message is displayed (if it appears during a program, wait until the end of the program).
- Press the centre button to confirm.

The Refill salt indicator goes out.

If a sufficiently high concentration of salt has not yet formed, Refill salt may continue to be displayed after adding the salt.

In this case, confirm again with the centre button.

The Refill salt message is turned off if you have programmed the commercial dishwasher to a water hardness below 4 gr/gal (= 70 ppm CaCO₃).

 Immediately after each refill run the Pre-wash or Short program without a load in order to remove any traces of brine from the cabinet.

Before using for the first time

Rinse aid

Rinse aid helps to prevent spotting on dishes and glassware and speeds up the drying process.

The rinse aid is filled into the reservoir and the set amount will be automatically dispensed. For available process chemicals from Miele contact Miele Professional.

 Use rinse aid only. Never fill the rinse aid reservoir with regular dishwashing detergent or cleaning agent. This will damage the rinse aid reservoir.

Adding rinse aid

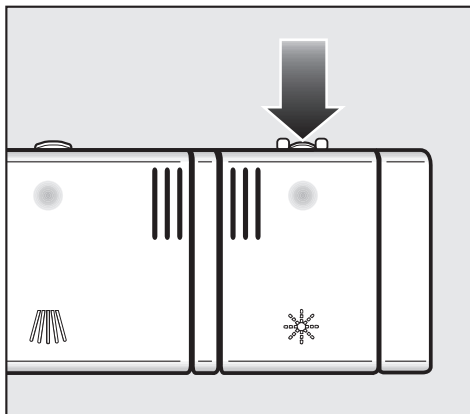

- Press the button on top of the rinse aid reservoir in the direction of the arrow. The cover will pop open.

Before using for the first time

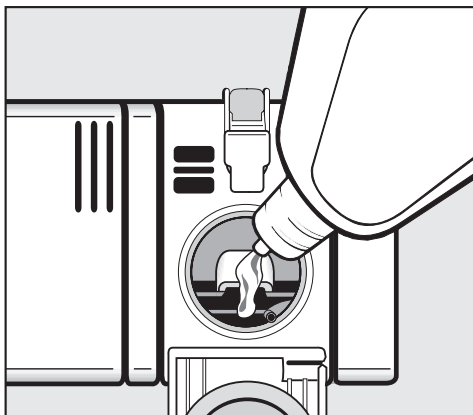

Rinse aid indicator

When the  **Add rinse aid** message appears, the reservoir only contains enough rinse aid for 2 - 3 wash programs.

- Add rinse aid soon.
- Press the centre button to confirm.

The "Refill rinse aid" message goes out.

- Pour rinse aid into the reservoir until it is visible in the opening.

The rinse aid reservoir holds approximately 110 ml.

- Close the cover until you hear it click shut, otherwise water might enter the reservoir during the wash program.
- Wipe up any spilled rinse aid to prevent over-foaming during the next wash program.

You can adjust the rinse aid dosage to optimize the results (see "Settings menu - Rinse aid").

Loading the commercial dishwasher

Tips:

Remove coarse food residues from the dishware.

There is no need to rinse items under running water!

 Do not wash items soiled with ash, sand, wax, grease or paint in the commercial dishwasher. These materials damage the commercial dishwasher.

All items can be placed anywhere in the baskets. However, note the following:

- Do not place dishes or cutlery inside other pieces. They will cover each other.
 - Load dishes so that water can reach all the surfaces. This ensures that the items will be properly cleaned!
 - Make sure that all items are securely positioned.
 - Hollow items such as cups, glasses and pots should be placed upside down in the baskets.
 - Place tall, narrow, hollow items, e.g. champagne glasses, in the center of the basket rather than in the corners. This ensures good water coverage.
- Concave items such as mugs or bowls should be placed at an angle so that the water can run off.
 - Ensure that the spray arms are not blocked by items that are too tall or that hang through the baskets. Check clearance by manually rotating the spray arms.
 - Place very small items such as lids in the cutlery tray or basket (depending on the model) so they do not fall to the bottom of the wash cabinet.

Some foods, e.g. carrots, tomatoes and ketchup, may contain natural dyes. Plastic items may discolour permanently if they come in contact with food dyes. This discolouration does not affect the stability of the plastic items.

Loading the commercial dishwasher

Items not recommended for dishwashing:

- Wooden cutlery and dishes or items with wooden parts, as they may discolour and fade. In addition, the glue used in these items is not dishwasher-proof. This may result in wooden handles coming loose.
- Hand-crafted items, antiques, valuable vases and decorative glassware are also not dishwasher-proof.
- Plastic items which are not heat resistant may become deformed.
- Copper, brass, tin and aluminium items may discolour or become dull.
- Colours painted over a glaze may fade after a number of washes.
- Fine glassware and crystal may become cloudy over time.

We recommend:

- When purchasing dishes and cutlery, make sure they are dishwasher-safe.
- Drinking glasses may become cloudy over time. Fine glassware should only be washed at low temperatures (see "Program guide") This reduces the risk of clouding.

Attention!

Silverware that was previously cleaned with a **silver polish** may still be damp or spotted at the end of a program since the water does not run off smoothly. Dry with a soft cloth.

Silver may discolour if it comes into contact with foods that contain sulphur. These include egg yolk, onions, mayonnaise, mustard, legumes, fish, fish brine and marinades.

 Aluminum components (e.g. grease filters) must not be washed with caustic alkaline commercial or industrial cleaning agents in the commercial dishwasher. These may damage the material. In extreme cases they can cause a severe explosive chemical reaction (such as explosive hydrogen gas reactions).

Loading the commercial dishwasher

Typical load for 10 place settings with cutlery tray

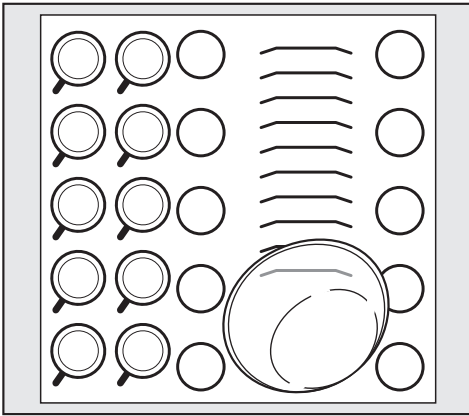

Upper basket

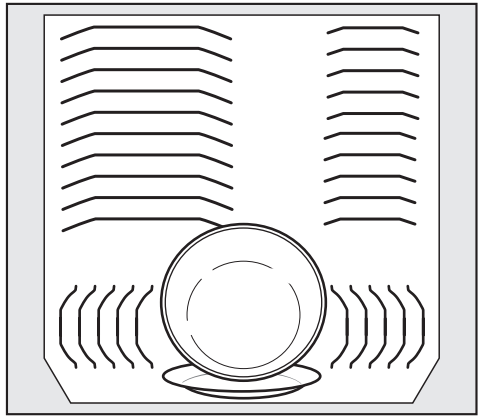

Lower basket

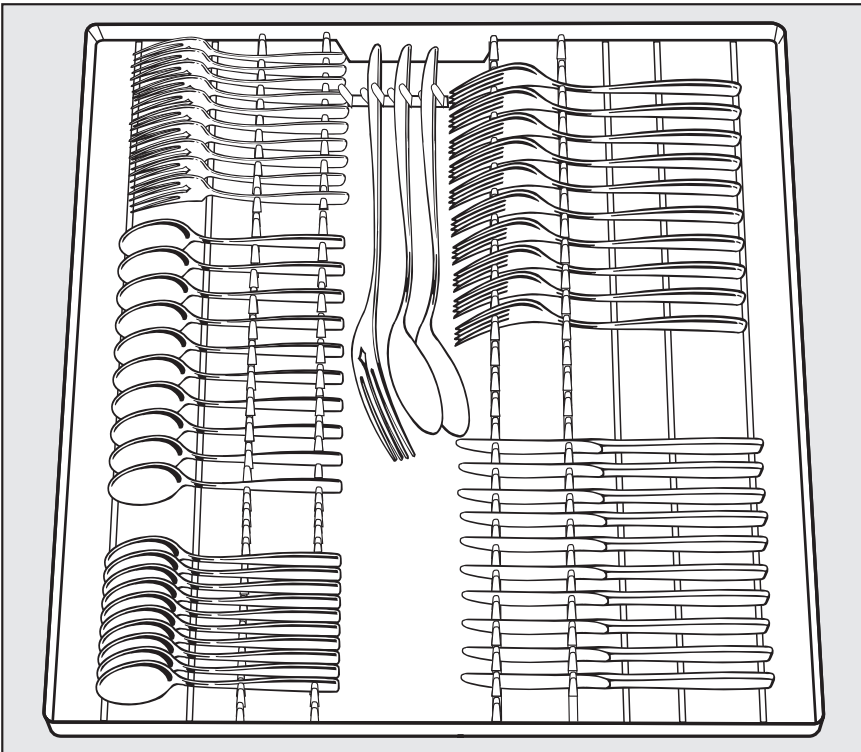

Cutlery tray

Loading the commercial dishwasher

Typical load for 16 place settings with cutlery tray

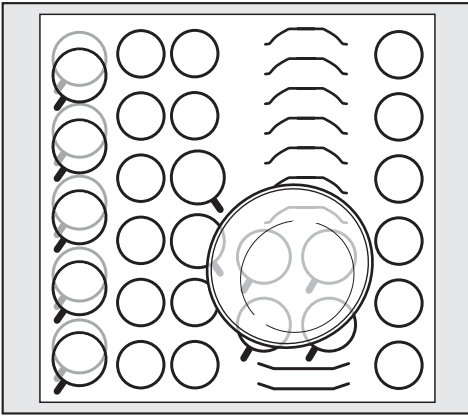

Upper basket

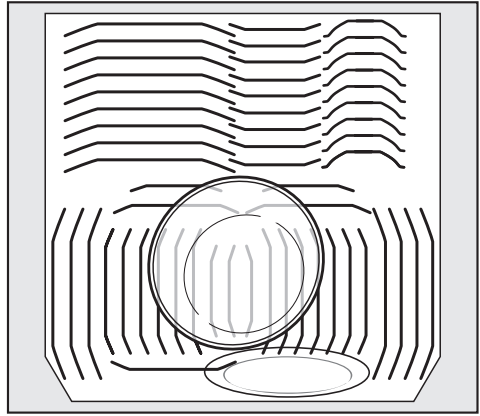

Lower basket

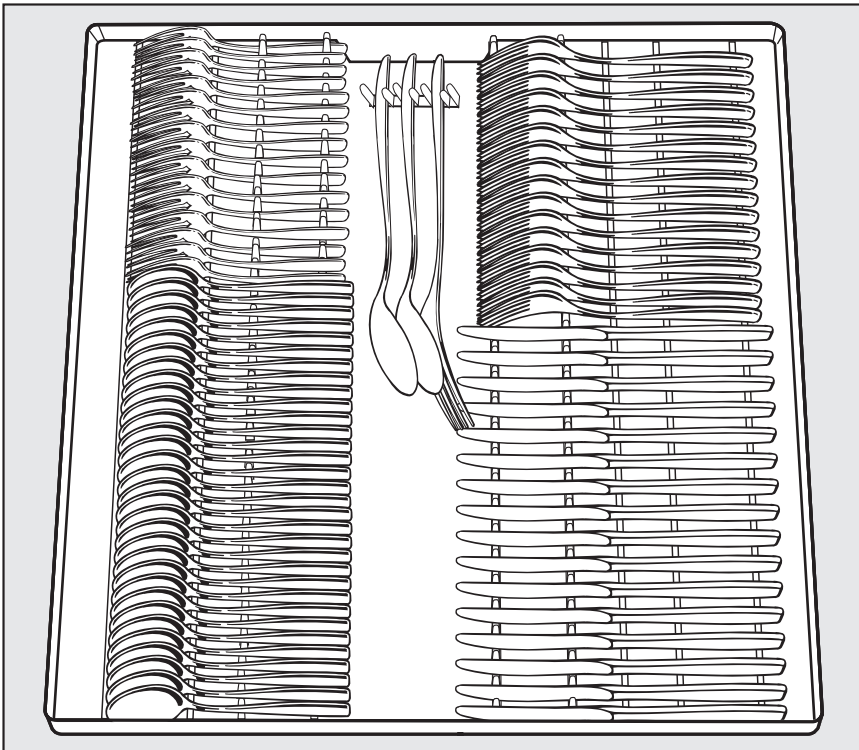

Cutlery tray

Loading the commercial dishwasher

Upper basket

 For safety reasons use the commercial dishwasher with both the upper and lower baskets inserted.

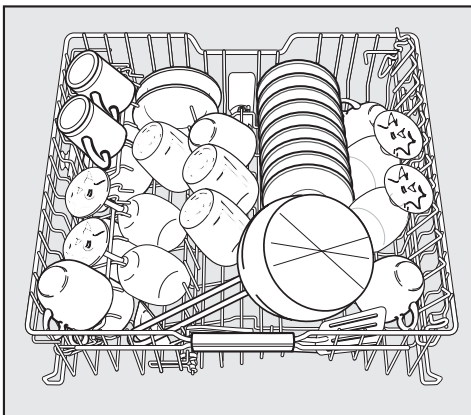

- Load the upper basket with small, lightweight or delicate items such as cups, saucers, glasses, dessert bowls, etc. Shallow pans can also be placed in the upper basket.
- Long items such as soup ladles, mixing spoons and long knives should be placed horizontally across the front of the upper basket.

Foldable spikes

The rows of spikes can be folded down to make more room for larger items such as flat pans.

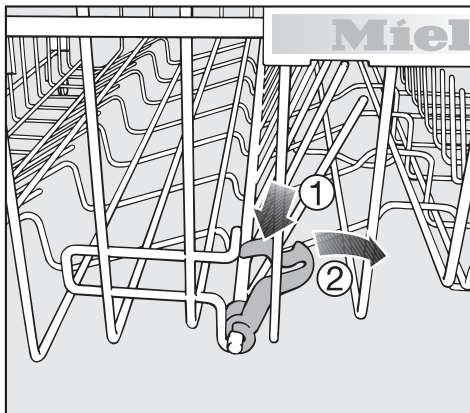

- Press the yellow lever ① and fold the spikes down ②.

Cup rack

- Fold the rack up to make room for tall items.

Glasses can be leaned against the cup rack to give them some support.

- Fold the cup rack down and lean the glasses against it.

Loading the commercial dishwasher

XXL cup rack

The cup rack can be set to two different widths so that it can also accommodate large cups.

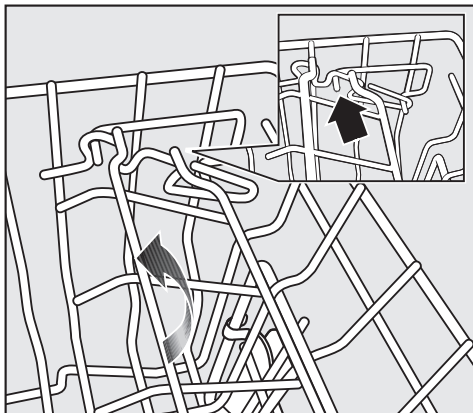

- Pull the cup rack upwards and click it back into position at the required width.

Glass support bar

The support bar will hold tall glasses and stemware securely.

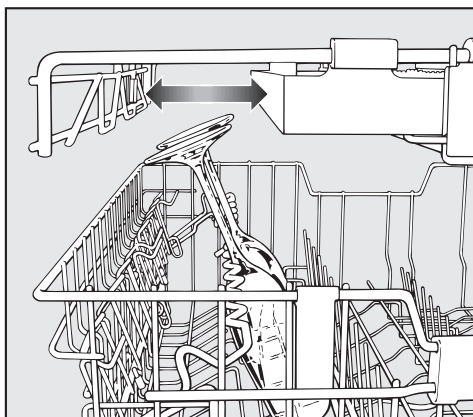

- Fold the support bar down and lean the glasses against it.

- You can also move one of the side inserts of the cutlery tray to make more room for tall glasses.

Adjusting the height:

You can set the support bar to two different heights.

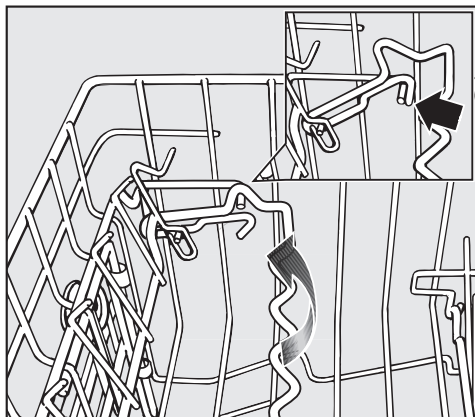

- Pull the support bar upwards and click it back into position at the required height.

Use the low setting for small glasses and tumblers.

Use the high setting for tall glasses and stemware.

Loading the commercial dishwasher

Adjusting the upper basket

In order to gain more space for taller items in the lower or upper basket, the upper basket can be adjusted to three levels of about 2 cm height difference between each level.

The upper basket can also be set at an angle with one side high and the other side low to improve water drainage. However, make sure that the basket can slide smoothly in and out of the cabinet.

- Pull the upper basket out.

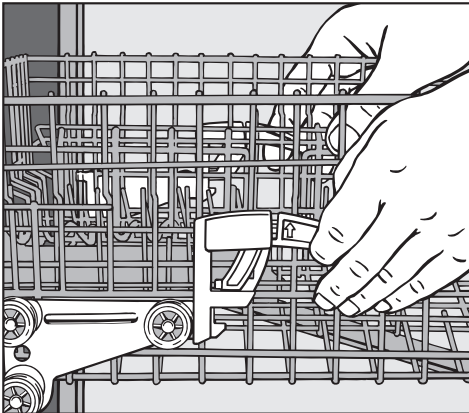

To adjust the upper basket upwards:

- Lift the basket up until it clicks into place.

To adjust the upper basket downwards:

- Pull upwards on the levers at the sides the basket.
- Adjust the basket to the desired height and then push the levers securely back down into position.

Depending on the setting of the upper basket, the following plate dimensions can be accommodated.

Dishwashers with cutlery tray

Adjusting the upper basket	Plate Ø in cm	
	Upper basket	Lower basket
Top	19	31
Middle	21	29
Bottom	23	27

Loading the commercial dishwasher

Lower basket

- Place larger and heavier items such as plates, serving platters, saucepans, bowls, etc. in the lower basket.
It can also be used for glasses, cups, small plates and saucers.

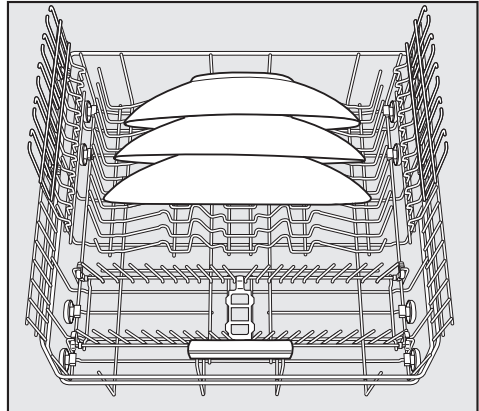
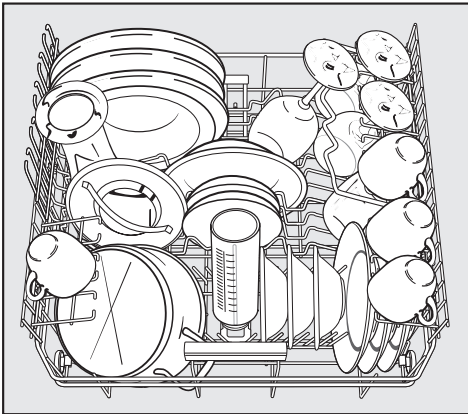

- Place very large plates in the centre of the lower basket.

When tilted, plates up to 35 cm in diameter can be accommodated.

Commercial dishwasher with a cutlery tray

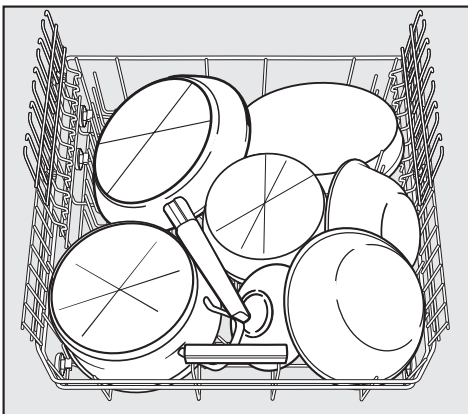

Heavily soiled items

Loading the commercial dishwasher

Removable MultiComfort insert

The rear section of the lower basket is used for washing cups, glasses, plates and pots.

You can remove the MultiComfort insert to make more room for larger items such as pots and pans.

To remove the insert

- Press the yellow handle forwards and remove the insert.

To replace the insert

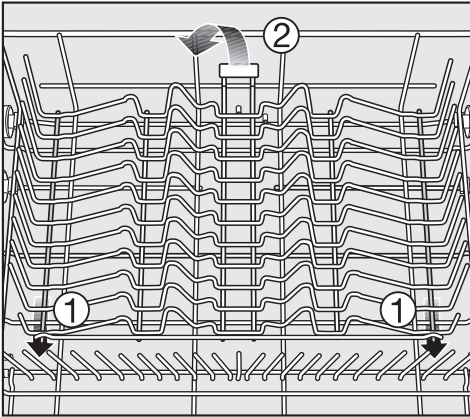

- Fit the insert into the lower basket with the hooks going under the long cross-piece ①.
- Press down on the insert until it clicks into position ②.

Glass rack

- The glass rack can be folded up to make more room for tall items.
- Stemware, e.g. wine, champagne and beer glasses, can be leaned against the glass rack or suspended from it.

The height of the glass rack is adjustable.

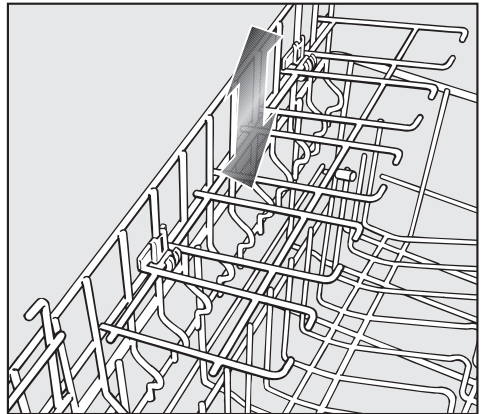

- Slide the glass rack to the desired height until the catches click into place at the top and rest on the bottom.

Loading the commercial dishwasher

Glass support bar

The support bar will hold tall glasses and stemware securely.

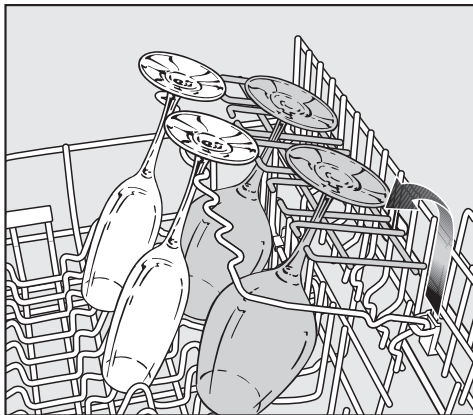

- Fold the support bar down and lean the glasses against it.

Foldable spikes

The spikes at the front are used for washing plates, soup bowls, platters, desert bowls, and saucers.

Both rows of spikes can be folded down to create more room for larger dishware, e. g. pots, pans and bowls.

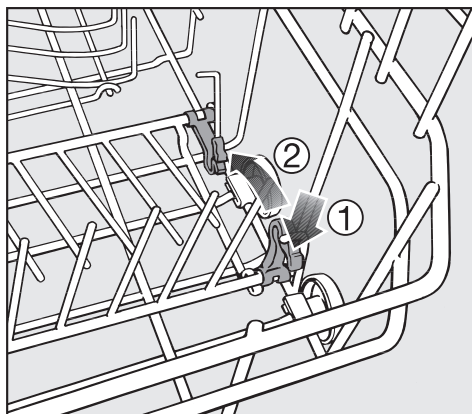

- Press the yellow lever down ① and fold the spikes down ②.

Bottle holder

The bottle holder can be used to wash narrow items, e. g. milk and baby bottles.

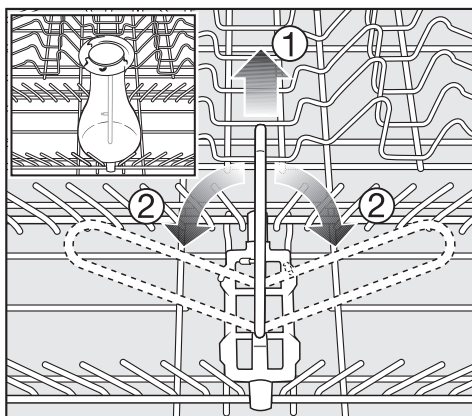

- If the bottle holder is not needed, lift it up ① and fold the sides down ②, as illustrated.

Loading the commercial dishwasher

Cutlery

3D cutlery tray

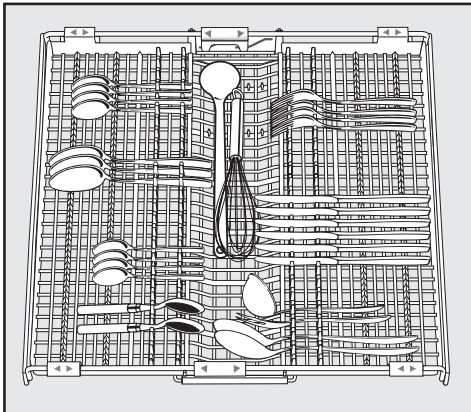

- Arrange the cutlery in the tray as shown.

To make unloading much easier, cutlery should be grouped in zones, one for knives, one for forks, one for spoons, etc.

Spoon heads should be placed in contact with at least one of the serrated retainers on the base of the cutlery tray to ensure that water runs off them freely.

The upper spray arm must not be blocked by items which are too big (e.g. cake server).

The side sections of the tray can be moved into the middle to accommodate tall items of crockery in the upper basket.

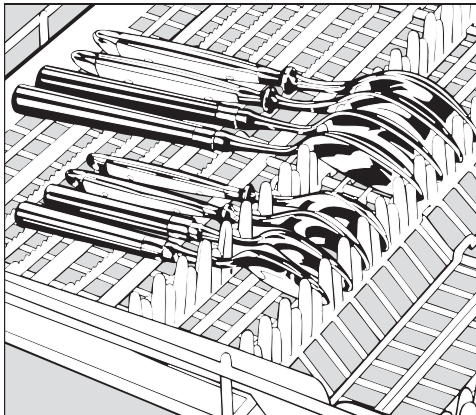

If spoon handles do not fit between the holders, then lay them the other way round.

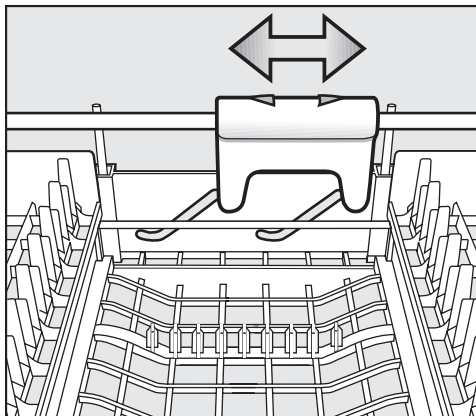

You can use the yellow slide to adjust the height of the middle section of the cutlery tray to make more room for large items of cutlery, such as serving spoons and ladles.

Operating the commercial dishwasher

Detergent

Powder detergents

Pour powder detergent into the compartments of the detergent dispenser.

Never use detergent tablets. The tabs do not dissolve completely during the short program runtimes.

- Put detergent into the dispenser compartments.

Detergent dosage

- Unless otherwise specified, depending on the degree of soiling, pour 20 to 30 g of powder detergent into compartment II. For heavily soiled dishware, pour a small amount of detergent into compartment I (see Program guide).

Failure to use the recommended amount of detergent may adversely affect the cleaning results.

Liquid detergent

This commercial dishwasher can be fitted with a dispenser pump for liquid detergent (optional accessory). It is connected externally.

Contact Miele Professional for external liquid dispensing options.

See "Settings menu - External Dos." to activate the dispenser pump and set the detergent dosage.

For special soiling or if using liquid detergent, dispensed by a liquid detergent pump, contact Miele for advice on how to adapt the detergent dosage to the particular circumstances.

Dispensing system maintenance

To ensure that the dispensing system functions reliably it should be serviced at specified intervals.

This work should only be performed by Miele Service.

The dispensing hoses in the DOS module must be replaced every **1 - 1¹/₂ years**.

Whether you use powder or liquid detergent, always observe the manufacturer's instructions.

Operating the commercial dishwasher

 Avoid inhaling powder detergents. Avoid swallowing dishwasher detergent. Detergents can cause chemical burns to nose, mouth and throat. Consult a doctor immediately if detergent has been swallowed or inhaled. Always keep detergent out of the reach of children. Keep children away from the commercial dishwasher when the door is open. There could still be detergent residues in the cabinet. Do not add detergent until you are ready to start the commercial dishwasher,

The cover is always open at the end of a program.

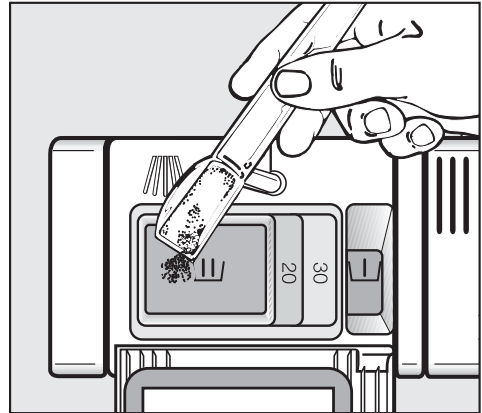

Adding detergent

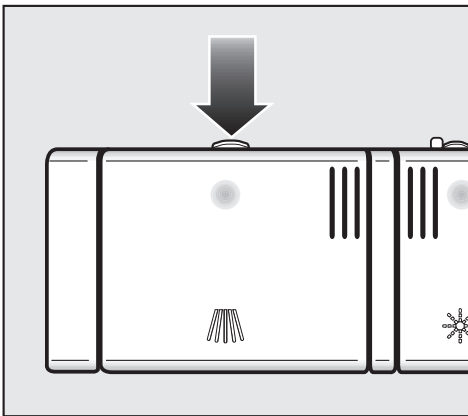

- Press the opening catch on the detergent dispenser. The cover will pop open.

- Add powder detergent or detergent tabs to the compartments and close the cover.
- Do not forget to close the detergent container. Otherwise, the detergent might clump.

Detergent dosing aid

Compartment I holds a maximum of 10 ml, compartment II holds a maximum of 50 ml of detergent.

Compartment II has dosage markings of 20 and 30. They show the quantity in ml when the door is open horizontally. Depending on the manufacturer and the grain size, the dosing aids indicate the approximate quantity in grams.

Operating the commercial dishwasher

Turning the commercial dishwasher on

- Turn on the water supply if it is off.
- Open the door.
- Make sure the spray arms can rotate freely.
- Press the  button to turn the commercial dishwasher on.

The factory-set Normal program will appear in the display and the matching indicator light will come on. After a short while, the estimated time for the selected program will appear in the display.

You can also change the setting to the program you last used to appear in the display when the machine is switched on (see Settings menu - Preselect progr.)



Selecting a program

Choose the program according to the type of dishware, soiling and sanitization requirements.

See "**Program guide**" for a description of the programs and their applications.

- Use the  button to select the desired program.

The indicator light next to the selected program comes on.

When the indicator light next to  lights up, you can select additional programs using the  > button.

You can now select additional functions (see "Additional functions").

Starting the program

- Start the program by closing the door.

The In-operation indicator light comes on to show that a program has started. If any additional functions are selected, the appropriate indicators will also light up.







Cancel a program only in the first few minutes. Otherwise important program steps (e. g. water softening) may be cancelled.

Operating the commercial dishwasher

Time display

Before the program starts, the display shows the runtime of the selected program in hours and minutes. The remaining runtime is displayed during the program.

Symbols will appear to indicate the stage of the program:

-  Pre-wash
-  Main wash
-  Interim rinse
-  Final rinse
-  Drying
-  End (Finished)

The runtime that is displayed may vary for the same program. It depends on the temperature of the incoming water, the reactivation cycle, the quantity of dishes, and other factors.

When a program is selected for the first time, the display shows an average program runtime for warm water.

The runtimes change if the electrical connection is changed.

Standby

A few minutes after the last time a button has been pressed or a few minutes after the end of the program the commercial dishwasher will switch into Standby mode to save energy. The display and the indicator lights will turn off and only the  indicator light will flash slowly.

- Press the  button to switch the display and indicators back on.

If the commercial dishwasher is not turned off after the program ends, after a few minutes in standby mode it will turn off completely (see "Settings menu - Optimizing Standby").

If Refill salt, Refill rinse aid or a fault is displayed, or while a program is running, the commercial dishwasher will not switch to Standby mode.

The refill messages can be turned off to let the commercial dishwasher go into Standby mode without first refilling (see Settings menu - Refill messages). However, fault messages cannot be turned off.

Operating the commercial dishwasher

End of program

At the end of a program, the In-operation indicator light will be visible flashing slowly with the door shut.

The program has finished when  **Finished** or **AutoOpen** appears in the display and the door is slightly ajar (if applicable).

If Extra drying was selected and AutoOpen is active, the drying fan will run for a few minutes after the program has ended.

- Open the door all the way to reset the door latch.

You can now unload the commercial dishwasher.

The In-operation indicator light will go out 10 minutes after the end of the program if the door is closed.

 If automatic door opening is switched off (see "Settings menu - AutoOpen") and you want to open the door after the program has ended, open the door all the way. This helps to prevent steam damage to the countertop because the fan stopped running.

Turning the commercial dishwasher off

At the end of a program:

- Open the door.
- Turn the commercial dishwasher off with the  button.

The commercial dishwasher will continue to use electricity until it is turned off with the  button.

The water tap should be turned off if the commercial dishwasher is not going to be used for a longer period of time, e. g. during vacation.

Unloading the commercial dishwasher

Dishes tend to break and chip more easily when they are hot. Leave the dishes in the commercial dishwasher until they are cool enough to handle before unloading them.

The dishes will cool much faster if you open the door fully when the program has ended.

Unload the lower basket first, then the upper basket and then the cutlery tray (depending on model). This will prevent water from the upper basket and cutlery tray from dripping onto dishes in the lower basket.

Operating the commercial dishwasher

Interrupting a program



A program will be interrupted as soon as the door is opened. When the door is closed again, the program will continue from where it was interrupted.

 Water in the commercial dishwasher may be hot. Risk of scalding!
Only open the door if absolutely necessary and be very careful. Before closing the door again, leave it slightly ajar for approx. 20 seconds. This will allow the temperature in the wash cabinet to settle. Close the door firmly until it clicks shut.

Changing a program

If the detergent dispenser cover has already opened, powder detergent must be added for the new program unless liquid detergent is being dispensed automatically with a dispensing module.

If a program has already started and you wish to change it:

- Open the door.
- Turn the commercial dishwasher off with the  button.
- Switch the machine on again with the  button.
- Use the program selector button to select the desired program.
- Start the program by closing the door.

The In-operation indicator light comes on to show that a program has started.

Extra drying

For better drying results and to reduce the amount of steam that escapes when the door is opened, the Extra drying function extends the fan runtime at the end of the program.

This function is not available for all programs.

When Extra drying is selected, the total program runtime will increase by approx. 20-30 minutes, depending on the program.

- Open the door.
- Press the  button to turn the commercial dishwasher on.

The  indicator light will come on.

- Select the desired program.
- Press the + button.

The + indicator light lights up if the function is available for the selected program.

- Start the program by closing the door.

Additional functions

Delay start

The start time of a program can be delayed, for instance to take advantage of cheaper electricity rates at night. You can delay the start time by 30 minutes to 24 hours. The delay is set in 30 minute increments.

When using the Delay start function, make sure that the detergent compartment is dry before adding detergent. Wipe dry if necessary. Otherwise the detergent could clump and not rinse out completely.



- Open the door.
- Press the  button to turn the commercial dishwasher on.

The  indicator light will come on.

- Use the program selector button to select the desired program.
- Press the  button.

The last Delay start time will appear in the display. The  indicator light comes on.

- Set the desired Delay start time using the  button.

If you keep the  button pressed, the time will increase automatically up to **24:00 h**. To start at 30 minutes again, press the  button twice.

- Close the door.



If you do not close the door within a few seconds after you have set the Delay start time, the program runtime will appear in the display again. You will have to set the Delay start time again.

The time starts counting down in minutes until the program start time.

When the set time is reached, the program selected will begin automatically. The in-operation control light will come on.

Starting a program before Delay start has elapsed:

A program can be started before the Delay start time has elapsed. Just do the following:

- Open the door.
- Turn the commercial dishwasher off with the  button.
- Switch the machine on again with the  button.
- Use the program selector button to select the desired program.
- Start the program by closing the door.

The In-operation  indicator light comes on to show that a program has started.

BrilliantLight

This dishwasher has interior lighting. When the door is open the lighting will switch off automatically after 15 minutes.

You can also switch off the interior lighting permanently.

- Half open the dishwasher door and quickly swing it back and forth three times. When doing this, open the door wide enough for the interior lighting to switch on and off.

The lighting will now be switched off permanently.

- To switch the lighting back on again, quickly swing the half-opened door back and forth three times again.

Cleaning and care

Check the overall condition of your commercial dishwasher regularly (approx. every 4 - 6 months). This will help to prevent problems.

 The outer surfaces of the commercial dishwasher are susceptible to scratching. Contact with unsuitable cleaning agents can alter or discolour the outer surfaces.

Cleaning the wash cabinet

The wash cabinet is largely self-cleaning, provided that the correct amount of detergent is always used.

If, however, there are limescale or grease deposits in the cabinet, these can be removed with a special dishwasher cleaner (available from Miele Service).

Washing at low temperatures can allow germs and odours to build up inside the appliance. To prevent this, run an intensive program with detergent after approx. 20 program cycles with low temperatures.

Cleaning the door and the door seal

- Wipe the door seals regularly with a damp cloth to remove food deposits.
- Wipe food and drink residues off the commercial dishwasher door. These surfaces are outside the wash cabinet and are not reached by water from the spray arms.

Cleaning the reflector panel

The reflector panel for the In-operation indicator light is situated in the coverplate underneath the worktop.

- The reflector panel should only be wiped with a damp cloth or a suitable cleaning agent designed for use on plastic.

Cleaning the control panel and front of the commercial dishwasher

 Remove any soiling immediately. Otherwise it might become impossible to remove and could cause an alteration or discolouration of the surfaces.

- The control panel should **only** be wiped with a damp cloth.
- Clean the front of the appliance with a clean sponge, dishwashing liquid and warm water. Then wipe dry with a soft cloth.
You can also use a clean, damp microfibre cloth without detergent.
- For surface disinfection use low or intermediate-level disinfectants only.

To avoid damage to the outer surface, do not use:

- Cleaning agents containing soda, ammonia, acids or chlorides,
- limescale removers,
- abrasive cleaners such as scouring powder, scouring liquid or pumice stones,
- cleaners containing solvents,
- stainless steel cleaners,
- dishwasher cleaner,
- oven sprays,
- glass cleaners,
- rough scouring sponges or brushes such as pot scrubbers,
- magic erasers,
- sharp metal scrapers,
- steam cleaning devices,
- Disinfectants containing Hydrogenperoxide, Paracetic Acid, Glutaraldehyde, Orthophthalaldehyde to prevent damage to CleanTouchSteel and fascia printing.

Cleaning and care

Checking the filters in the wash cabinet

The filter combination in the base of the wash cabinet captures large dirt particles from the wash water. This prevents them from reaching the circulation system and re-entering the cabinet through the spray arms.

 This commercial dishwasher must not be used without all the filters in place!

Collection of coarse particles may cause the filters to clog over time. The dirtier the dishware the sooner the filters need cleaning.

The message **Check filters** is factory-set to appear in the display after every 50 program cycles.

You can turn off the filter check or set the frequency to 30 to 60 program cycles (see Settings menu - Filter check).

- Check the filter combination.
- Clean it, if necessary.
- Then press the centre button to confirm the message.

The last selected program is displayed and the respective indicator light will come on.

After a short while, the estimated program runtime is displayed.

Cleaning the filters

- Turn the commercial dishwasher off.

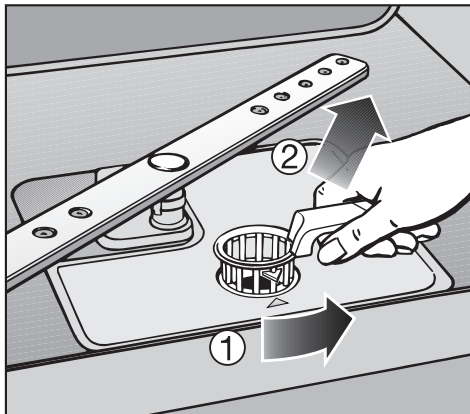

- Turn the handle towards the back to release the filter combination ①.
- Take the filter combination out ②, remove any coarse particles and rinse the filter well under running water. Use a brush if necessary.

 Ensure that large particles do not get into the circulation system and clog it.

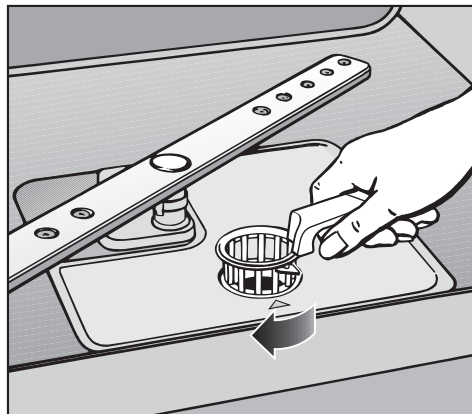
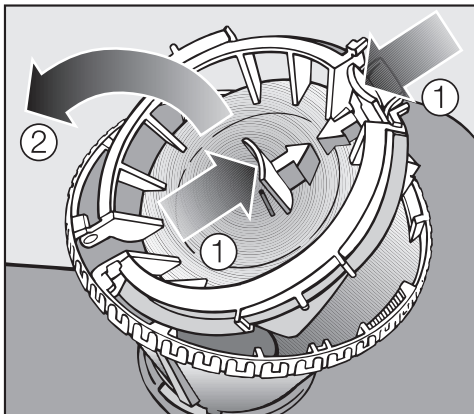

The cover must be opened to clean the inside of the filter:

- Push the clips together in the direction of the arrows as shown ①, and open the cover ②.
- Clean all parts under running water.
- Close the cover so that the lock engages.

- Replace the filter combination so that it lies flat in the bottom of the wash cabinet.
- Lock the filter in place by turning the handle forward until the arrows face each other.

 The filter combination must be inserted correctly and locked. Otherwise large dirt particles can get into the circulation system and clog it.

Cleaning and care

Cleaning the spray arms

Particles of food can get stuck in the spray arm jets and bearings. The spray arms should therefore be checked regularly (approx. every 4 - 6 months).

- Turn the dishwasher off.

Remove the spray arms as follows:

- Pull out the cutlery tray (if present).

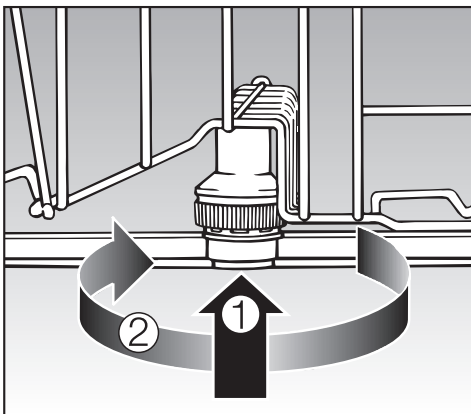

- Push the **upper** spray arm up to engage the inner ratchet and unscrew the spray arm.
- Lift the **middle** spray arm up ① to engage the ratchet and unscrew the spray arm ②.

- Remove the lower basket.

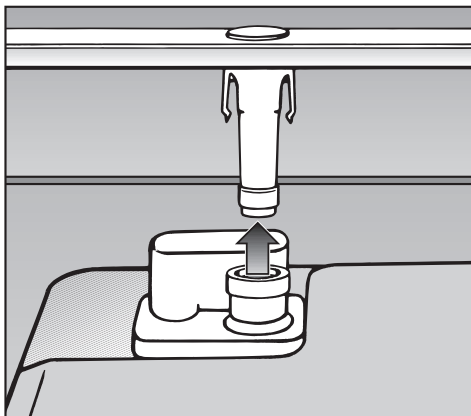

- Pull the **lower** spray arm firmly upwards to remove.

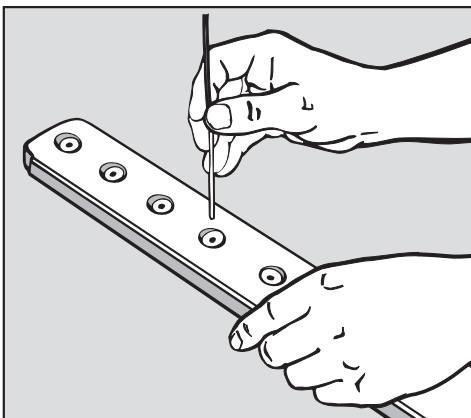

- Use a pointed object to push the food particles in the spray arm jets into the spray arm.
- Rinse the spray arms thoroughly under running water.
- Replace the spray arms and check that they rotate freely.



Problem solving guide



You can easily resolve many of the minor problems you may encounter during everyday use. This will save you time and money because you do not have to call Miele Service.

 Repairs must only be carried out by Miele Service. Unauthorized repairs could cause personal injury or damage to the machine.



Technical faults		
Problem	Possible fault	Solution
The commercial dishwasher does not start.	The door is not properly closed.	Push the door firmly shut.
	The commercial dishwasher is not plugged in.	Insert the plug.
	The circuit breaker has tripped.	Reset the circuit breaker. (See data plate for the correct fuse rating).
	The commercial dishwasher is not switched on.	Press the  button and select a program.
The commercial dishwasher stops during a program.	The circuit breaker has tripped.	<ul style="list-style-type: none"> – Reset the circuit breaker. (See data plate for the correct fuse rating). – If the circuit breaker trips again, contact Miele Service.
After the program has started, the In-operation indicator light is not visible.	The reflector panel was not correctly fitted.	Re-fit the reflector panel correctly (see Installation diagram).







Problem solving guide

Problem	Possible fault	Solution
<p>The In-operation indicator is flashing quickly. The buzzer is sounding. One of the following messages appears in the display:</p>		<p>Before fixing the fault:</p> <ul style="list-style-type: none"> - Turn the commercial dishwasher off with the  button.
<p> Fault FXX</p>	<p>There may be a technical fault.</p>	<p>After a few seconds:</p> <ul style="list-style-type: none"> - Switch the commercial dishwasher back on. - Select the desired program. - Close the door. <p>If the error message is displayed again, there is a technical fault.</p> <ul style="list-style-type: none"> - Contact Miele Service.
<p> Waterproof</p>	<p>The Waterproof system has reacted.</p>	<ul style="list-style-type: none"> - Close the water tap. - Contact Miele Service.

Faults in the water intake or water drain		
Problem	Possible fault	Solution
<p>The In-operation indicator is flashing quickly.</p> <p>The buzzer is sounding.</p> <p>One of the following messages appears in the display:</p>		
 Open water supply	The water tap is closed.	Open the water tap all the way.
 Water intake		Before fixing the fault: <ul style="list-style-type: none"> – Turn the commercial dishwasher off with the  button.
	There is a problem with the water intake.	<ul style="list-style-type: none"> – Open the water tap all the way. – Check the water inlet filter and clean it if necessary (see "Maintenance"). – The water pressure at the water connection is less than 30 kPa (4.4 psi). Consult a plumber.

Problem solving guide

Problem	Possible fault	Solution
The In-operation indicator is flashing quickly. The buzzer is sounding. The following message appears in the display:  Drain		Before fixing the fault: <ul style="list-style-type: none">– Turn the commercial dishwasher off with the  button.
	Fault in the water drainage. There might be water in the wash cabinet.	<ul style="list-style-type: none">– Clean the filter combination (see "Cleaning and care").– Clean the drain pump (see "Maintenance").– Clean the non-return valve (see "Maintenance").– Remove any kinks or high loops in the drain hose.

General problems with the commercial dishwasher		
Problem	Possible fault	Solution
The indicators and display are dark. Only the  indicator flashes slowly.	The indicators and the display turn off automatically to save energy (Standby mode).	Press the  button to come out of Standby mode.
The interior lighting does not come on when the door is opened.	The lighting has been switched off permanently.	Switch the lighting back on again (see "Additional functions, BrilliantLight").
The following fault message is displayed:  Salt container lid The buzzer sounds during the program and the In-operation indicator light flashes.	The salt reservoir cover is not properly closed.	<ul style="list-style-type: none"> – Close the salt reservoir cover. If the salt reservoir cover opened during a program: – Switch the dishwasher off and then on again with the  button. – Re-start the program.
The buzzer sounds during a program. The following fault message appears in the display:  Spray arm blocked	The middle spray arm is blocked by dishware.	Open the commercial dishwasher door and rearrange items blocking the spray arms.
	The spray arm jets of the middle arm are clogged.	<ul style="list-style-type: none"> – Turn the commercial dishwasher off with the  button. <p>Then:</p> <ul style="list-style-type: none"> – Clean the spray arm (see "Cleaning and care").

Problem solving guide

Problem	Possible fault	Solution
There are detergent residues in the dispenser at the end of a program.	The dispenser was wet when detergent was added.	Make sure the dispenser is dry before adding detergent.
The detergent dispenser cover will not close.	Detergent residue is blocking the latch.	Remove the detergent residue.
The inside of the door and/or the interior walls are wet after a program has finished.	This is caused by the drying system and does not indicate a fault.	None. The moisture evaporates after some time.
There is water in the wash cabinet at the end of a program.		Before fixing the fault: – Turn the commercial dishwasher off with the  button.
	The filter combination in the wash cabinet is clogged.	Clean the filter combination (see "Cleaning and care").
	The drain pump or non-return valve is blocked.	Clean the drain pump or the non-return valve (see "Maintenance").
	There is a kink in the drain hose.	Remove the kink from the drain hose.
Some programs run for a long time.	No fault! Certain programs have a long runtime.	Select a different program (see "Program guide").
Although AutoOpen is selected, the door remains closed at the end of the ProSpeed program. Therefore the dishware is still moist.	No fault! Because of the program's short runtime, the AutoOpen function is not available for the ProSpeed program.	To improve the drying, raise the rinse temperature (see "Setting menu - High temp rinse").

Problem solving guide

Noises		
Problem	Possible fault	Solution
There is a knocking noise in the wash cabinet.	A spray arm is hitting the dishware.	Interrupt the program and rearrange items blocking the spray arms.
There is a rattling noise in the wash cabinet.	Dishware is moving around in the wash cabinet.	Interrupt the program and rearrange loose pieces.
	A foreign object (e. g. cherry pit) has become lodged in the drain pump.	Remove the foreign object from the drain pump (see: Cleaning the drain pump and non-return valve)
There is a knocking noise from the water pipe	This may be caused by the installation or the diameter of the water pipe.	This has no effect on the functioning of the commercial dishwasher. If in doubt, contact a plumber.

Problem solving guide

Poor cleaning results		
Problem	Possible fault	Solution
The dishes are not clean.	The dishes were not loaded correctly.	See Loading the commercial dishwasher.
	The program was not suitable for the requirements.	Select a more suitable program (see Program guide).
	Not enough detergent was dispensed.	Use more detergent, or switch to another detergent.
	The spray arms are blocked by dishware.	Check by turning the spray arms and rearrange the dishes if necessary.
	The filter combination in the wash cabinet is clogged or not correctly inserted. The spray arm jets might be clogged as a result.	Clean the filter combination or insert it correctly. Clean the spray arm jets, if necessary (see Cleaning and care).
	The non-return valve is stuck in the open position. Dirty wash water will run back into the wash cabinet.	Clean the drain pump and the non-return valve (see Maintenance).
There are streaks on the glasses and cutlery. The glasses take on a bluish shimmer; the deposits can be wiped off.	The rinse aid dosage is set too high.	Reduce the dosage (see Settings menu - Rinse aid).

Problem solving guide

Problem	Possible fault	Solution
Dishes are not dry, or glasses and cutlery are spotty.	The rinse aid dosage is set too low or the rinse aid reservoir is empty.	Refill the reservoir, increase the dosage, or switch the rinse aid product when refilling (see Rinse aid).
	Dishes were taken out too soon.	Leave dishes in longer (see Operating the commercial dishwasher).
White residue is visible on the dishware. Clouding occurs on glassware and cutlery; the deposit can be wiped off.	The rinse aid dosage is too low.	Increase the dosage (see Settings menu - Rinse aid).
	The salt reservoir is empty.	Refill the salt reservoir (see: Before using for the first time - Filling the salt reservoir).
	The water softener setting is too low.	Increase the water softener setting (see Settings menu / Water softener).

Problem solving guide

Problem	Possible fault	Solution
Glasses have a brownish-blue discolouration; the deposit cannot be wiped off.	Detergent deposits.	Switch to another detergent right away.
Glasses are dull and discoloured; the deposit cannot be wiped off.	The glasses are not dishwasher-safe. Surface changes occur.	There is no remedy. Use only dishwasher safe glasses.
Tea or lipstick stains have not been completely removed.	The wash temperature of the selected program was too low.	Select a program with a higher wash temperature.
	The bleaching effect of the detergent is too low.	Switch to another detergent.
Plastic parts are discoloured.	Natural dyes, e.g. from carrots, tomatoes or ketchup, may be the cause. Not enough detergent was used or the bleaching effect of the detergent is too low.	Use more detergent (see Operating the dishwasher - Detergent). This discolouration is permanent.
There are rust stains on the cutlery.	The affected items are not corrosion resistant.	There is no remedy. Use only dishwasher safe cutlery.
	No program was started after refilling salt. Salt residues entered the wash cycle.	Always start the "Pre-rinse" program without a load after refilling salt.

Cleaning the water inlet screen

There is a screen in the screw connection of the water inlet hose to protect the water inlet valve. The screen must be cleaned when dirty, otherwise insufficient water will flow into the wash cabinet.

 The plastic housing of the water connection contains an electric valve. The housing must not be immersed in water.

Recommendation

If the water supply contains a large amount of insoluble substances, we recommend fitting a large-area filter between the tap and the water inlet hose.

This filter is available from Miele Service.

To clean the screen:

- Disconnect the commercial dishwasher from the electric power supply. Always switch the appliance off before unplugging it.
- Close the water tap.
- Unscrew the water inlet valve.

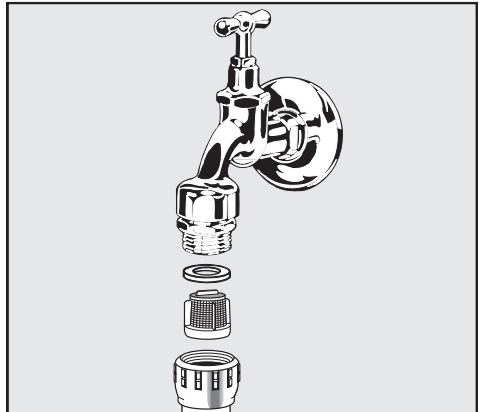

- Take the seal ring out of the screw connection.
- Use needlenose pliers to pull out the screen, then clean it.
- When removing the screen, take care not to pull out or displace the flow regulator behind it.
- Replace the screen and seal. Make sure they are positioned correctly.
- Reconnect the water inlet valve to the tap. Make sure not to cross-thread the connection.
- Turn the tap back on. If the connection leaks it might be too loose or cross-threaded. Unscrew and reconnect the water inlet valve correctly.

Maintenance

Cleaning the drain pump and non-return valve

If there is water in the wash cabinet at the end of a program, the water was not pumped out properly. The drain pump or the non-return valve might be clogged. However, they are easy to clean.

- Disconnect the commercial dishwasher from the electric power supply. Always switch the appliance off before unplugging it.
- Remove the filter combination from the wash cabinet (see Cleaning and care - Cleaning the filters).
- Scoop the water out of the cabinet using a small container.

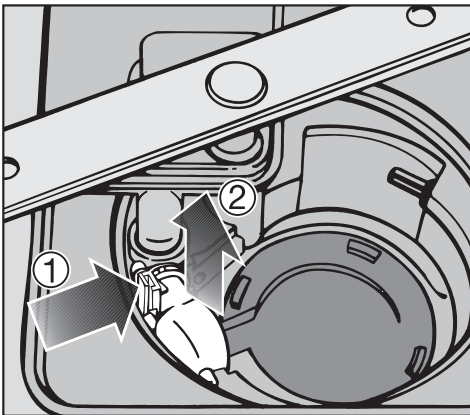

- Press the catch for the non-return valve inwards ①.
- Pull the non-return valve out ② and rinse it thoroughly under running water.
- Remove all foreign objects from the non-return valve.

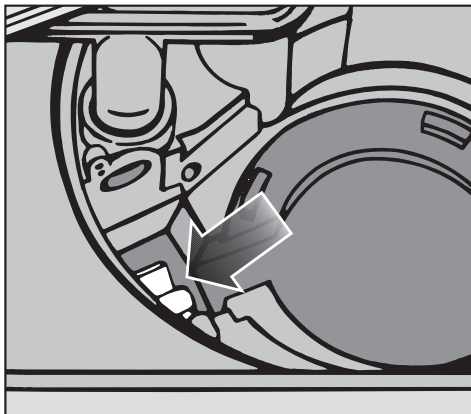

The drain pump is located beneath the non-return valve (arrow).

- Remove all foreign objects from the drain pump (glass splinters are particularly difficult to see). Turn the drain pump impeller by hand to check for objects. It is normal that the rotation of the impeller feels jerky.
- Carefully replace the non-return valve.

⚠ Make sure the catch engages correctly!





Be careful not to damage any components when cleaning the drain pump and the non-return valve.

Making better use of the commercial dishwasher

Optional accessories for this commercial dishwasher are available from Miele.

You want to...	You need...
...wash the individual parts of the Miele Cappucinatore	... a Cappucinatore insert for the upper basket
...wash additional cutlery	... a cutlery basket for the lower basket
...wash long-stemmed glasses	...a support bar for the lower basket

Program guide

Program	Application	Detergent	
		Follow the detergent manufacturer's instructions	
		Compartment I ¹⁾	Compartment II ¹⁾
 ProSpeed	For fresh, non-sticky food residues		20 - 30 g
 Universal	For normal, slightly dried food residues		20 - 30 g
 Pots & Pans	For burned-on, very adherent, very dry, starchy or albuminous ¹⁾ food residues.	10 g	20 - 30 g
 Glasses	Special glassware program		20 - 30 g
 SaniWash	Sanitizing program with 70°C or optional 75°C sanitizing.		20 - 30 g
Plastics	Special plastics program		20 - 30 g
Glass no rinse aid	Special beer glass program. (The glasses do not dry through their own heat after the program has ended and might have to be dried by hand).		20 - 30 g
Normal*)	Program for completely washing a full load of normally soiled dishware.		20 - 30 g
Rinse and Hold	For rinsing off very soiled dishware, e. g. to remove soiling in advance or to prevent residues from drying on the dishware when it is not worth running an entire program.		

*) From the aspect of combined energy and water consumption, this program is the most efficient for washing normally soiled dishes.

(Program sequence can not be altered)

¹⁾ see "Operating the commercial dishwasher - Detergent"

Program guide

Program sequence								
Pre-rinse	Main wash	Interim rinse I	Interim rinse II ²⁾	Final rinse	Drying	Extra drying	Auto Open	Water plus
	X 65°C 1 min	X 10 s	(X)	X 65°C ³⁾ 30 s		(X)	⁴⁾	(X)
	X 65°C 10 min	X 3 min	(X)	X 65°C ³⁾ 1.5 min		(X)	(X)	(X)
X 8 min	X 75°C 10 min	X 3 min	(X)	X 65°C ³⁾ 1.5 min		(X)	(X)	(X)
	X 50°C 1 min	X 3 min	(X)	X 50°C 1 min		(X)	(X)	(X)
X 8 min	X 75°C 10 min	X 3 min	(X)	X 70°C ³⁾ 3 min	X 30 min		(X)	(X)
X 10 min	X 50°C 1 min	X 5 min		X 60°C 30 s	X 45 min		(X)	
	X 50°C 1 min	X 3 min		X — ⁵⁾ 1 min				
	X 41.5°C 47 min	X 3 min		X 49.5°C 5 min	X 45 min		(X)	
	X Cold 8 min							

X = part of the program

(X) = additional, optional program steps





²⁾ Interim rinse II, must be programmed by a Miele service technician.

³⁾ Optional temperature increase to 75°C.

⁴⁾ No AutoOpen at the program end because of the short program runtime.

⁵⁾ Without rinse aid and with cold water.

Program guide

Program	Consumption ⁶⁾			Duration ⁶⁾	
	Electrical energy		Water	Cold water connection (15°C)	Water - Hot 55°C
	Cold water connection (15°C)	Water - Hot 55°C			
 ProSpeed	1.7 kWh	0.9 kWh	17 l	35 min ⁷⁾	25 min ⁷⁾
 Universal	1.7 kWh	1.0 kWh	17 l	48 min ⁷⁾	38 min ⁷⁾
 Pots & Pans	2.0 kWh	1.0 kWh	23 l	64 min ⁷⁾	52 min ⁷⁾
 Glasses	1.1 kWh	0.4 kWh	17 l	29 min ⁷⁾	20 min ⁷⁾
 SaniWash	2.3 kWh	1.3 kWh	23 l	101 min	89 min
Plastics	1.4 kWh	0.5 kWh	23 l	94 min	81 min
Glass no rinse aid	0.7 kWh	0.4 kWh	17 l	24 min	19 min
Normal*)	1.2 kWh	0.5 kWh	17 l	124 min	115 min
Rinse and Hold	0.03 kWh	0.03 kWh	6.5 l	11 min	11 min

⁶⁾ Values are calculated for a connected load of 4.2 kW. In practice, these may vary considerably due to differing conditions. The displayed runtime adjusts to the local conditions.

⁷⁾ The figure refers to the wash duration without drying.

Repairs

If you cannot fix a fault with the help of this manual, please contact:

- Miele Service.
- When contacting the service department, you will need the model and serial number of your appliance.

These can be found on the data plate along the right edge of the open door.

Program updates

The program update function keeps your appliance up to date with advances in dishwashing technology.

Program updates can only be performed by Miele Service.

Electrical connection

 All work on the electrical connection must be carried out by Miele Service.

- The electrical installation must be in compliance with current local and national safety regulations.
- The plug connection must comply with national regulations. (The electrical outlet must be accessible after the appliance has been installed.) This facilitates access for electrical safety checks, for example when the appliance is being repaired or serviced.
- If the appliance is hard wired, a multiple-pole circuit breaker must be installed. The contact opening at the main breaker must be at least 3 mm wide and lockable in the open position.
- If necessary, an equalization of the potentials must be carried out.
- If replacing the power cord, use only original Miele replacement parts or a suitable cord **with core cable ends**.
- For technical data, see the data plate or the attached wiring diagram!

The commercial dishwasher must only be operated with the voltage, frequency and fuse rating shown on the **data plate**.

A **conversion** may only be performed according to the attached **conversion diagram** and **wiring diagram**.

Converting the machine to a different type of power supply can lead to longer program runtimes resulting in increased energy consumption.

The values declared on the label will only be achieved if the machine remains in the state it was delivered in.

The **data plates** are at the back of the commercial dishwasher and along the right edge of the open door.

The **wiring diagram** comes with the commercial dishwasher.

The **conversion diagram** is attached to the base panel behind the plastic base cover.

Electrical connection

The PG 8083 SCVi comes equipped with a 10/4 AWG cord and a 120V/208-240 V, 60 Hz NEMA 14-30P plug.

If available, the dishwasher may be connected to a AC 120 V, 60Hz power supply.

Converting the machine to a different type of power supply can lead to longer program runtimes resulting in increased energy consumption.

	120V	208-240V
Rated Load (kW)	1.5	3.9-4.2
Fuse Rating	15A	30A

To connect the machine to a 120 V supply, the standard power cord must be removed and replaced by a 14/3 AWG cable of the type: S, SE, SO, SOO, ST, STO or STOO. A 2 pole, 3-wire grounding plug and receptacle are recommended (NEMA Type 5-15P).

The **conversion diagram** and **wiring diagram** are secured to the inner side of the toe kick.

Removing the toe kick

Disconnect the machine from the mains electrical supply.

- Remove the fixing screws from the toe kick and take it off.

Power connection options

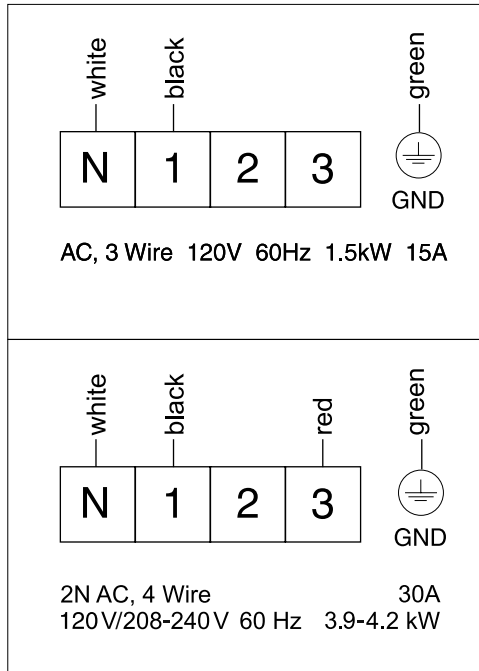

Electrical connection

Removing the base cover

The electrical terminal is located behind the front cover in the middle of the commercial dishwasher base.

 Disconnect the commercial dishwasher from the electrical power supply!

- Unscrew the 2 screws (left and right) and remove the base panel.
- Screw the base panel back on when work on the connection is finished.

Follow the installation diagram included with the commercial dishwasher!

Connecting the potential equalization

The connection screw (ψ) for potential equalization is located at the back of the commercial dishwasher.

The Miele waterproof system

Providing the dishwasher was installed correctly by a qualified technician, the waterproof system will protect you from water damage throughout the lifetime of the machine.

Water intake

 The water in the commercial dishwasher is NOT safe to drink!

- The commercial dishwasher must be connected to the water supply in accordance with local regulations.
- The water supply must at least meet the standards for drinking water. A high iron content can leave a rustfilm on dishware and the commercial dishwasher itself. When the chloride content in the domestic water supply is above 100 mg/l, the risk of corrosion damage to dishware is greatly increased.
- The commercial dishwasher can heat its own water to the temperature required by the wash program. This allows for connection of the machine to either a hot (max. 60 °C) or cold water source. For lowest energy consumption and fastest possible wash times connect the commercial dishwasher to a hot water source. All programs use hot water in the rinse cycles.
- In certain regions (e.g. mountain regions) the water composition may cause precipitates to form, requiring the use of softened water for the commercial dishwasher.
- The commercial dishwasher is equipped with a safety system for the protection of drinking water and may be connected to the water supply without a non-return valve, if national regulations permit.
- The water pressure (flow pressure at the water connection) must be between 30 und 1000 kPa (4.4 and 145 psi). If the water pressure is lower, the message **Water intake** is displayed (see Frequently asked questions). If the water pressure is higher, a pressure reducer must be installed.
- A water shut-off valve with a $\frac{3}{4}$ " thread is required for connection to the water supply. The valve should be easily accessible, because the water supply must be turned off when not in use.
- The inlet hose is 1.7m long, with a 2 cm female hose thread. A 1.5 m extension hose is available (flexible metal hose certified for a pressure of 14000 kPa/ 2031 psi). The dirt screen and the flow regulator in the threaded water connection must not be removed.

Plumbing

 To prevent damage to the commercial dishwasher, make sure all air has been bled from the supply line.

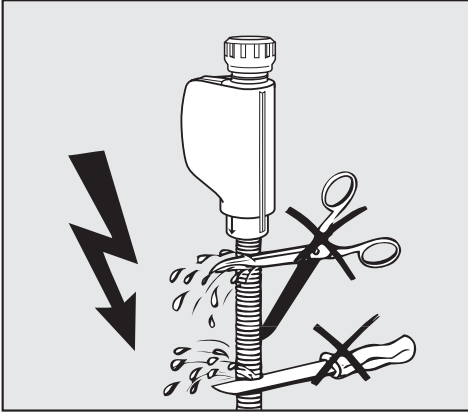

 The inlet hose must **not** be shortened or damaged in any way because it contains electrical wires (see illustration).

Water drainage

- The drain is equipped with a non-return valve which prevents waste water from flowing back into the commercial dishwasher through the drain hose.
- The commercial dishwasher drain hose should be connected to a **separate** drain for the commercial dishwasher only. If no separate drain is available, we recommend connecting it to a dual-chamber siphon.
- The commercial dishwasher is equipped with a 1.5 m flexible drain hose with an internal diameter of 22 mm. Connecting clamps are provided with the commercial dishwasher.
- An additional hose and adapter can be used to extend the drain hose. The drain hose length must not exceed 4 m and the pumping height must not exceed 1 m!
- The drainage system must be able to accommodate a minimum drainage flow of 16 l/min.
- The drain hose must not be shortened!

 Make sure the hose is not kinked, squashed or pulled too tight.

Venting the drainage system

The drain must be vented if the connection to the building's drainage system is lower than the roller guides for the lower basket in the door. Otherwise the water inside the commercial dishwasher may siphon out during the wash program.

For venting:

- Open the commercial dishwasher door completely.

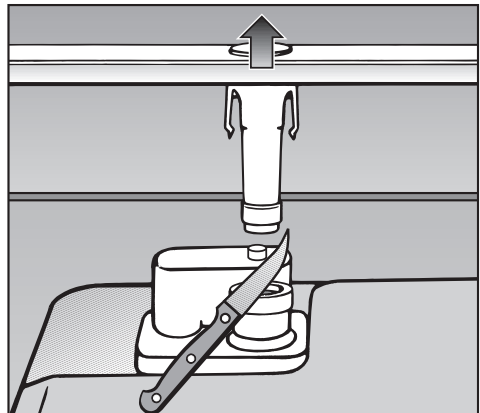





- Pull the lower spray arm up to remove.
- Cut off the cover of the vent valve in the wash cabinet.

Technical data

Model	PG 8083 SCVi
Commercial dishwasher	
Height	84.5 cm (adjustable +6.5 cm)
Installation height	Min. 84.5 cm (+ 6.5 cm)
Width	59.8 cm
Installation width	60 cm
Depth	57 cm
Weight	57.5 kg
Voltage	
Connected load	see data plate
Fuse rating	
Power consumption when switched off	0.30 W
Power consumption when not switched off	2.00 W
Water pressure (flow pressure)	30 - 1000 kPa (4.4 - 145 psi)
Cold or hot water supply	max. 60°C
Water hardness	max. 36 gr/gal
Drainage pumping height	max. 1 m
Drain hose length	max. 4 m
Power cable length	ca. 1.7 m
Capacity	16 standard table settings
Noise emissions	
Sound power level in Lw A	49 dB (A)
Sound pressure level LpA	38 dB (A)
Certifications	CSA Approval CSA Energy Certification, Energy Guide Label, Energy Star
Manufacturer's address	Miele & Cie. KG, Carl-Miele-Str. 29, 33332 Gütersloh, Germany

"Settings" menu for changing standard settings

Opening the "Settings" menu

- If the commercial dishwasher is on, press the  button to turn it off.
- Press and hold the  button.
- Turn the commercial dishwasher on with the  button and hold the  button down for at least 4 more seconds.

The first option of the Settings menu will appear in the display and all the indicator lights will come on.

See the Display functions section for details.

- Select the menu setting you wish to change.

The selected options in the submenu are marked with a check .

Language

The display can be set to different languages.

The displayed language can be changed in the **Language ** submenu.

- Select the desired language and press the centre button to confirm.

The flag after the word **Language** serves as a guide if an unfamiliar language is set. In this case, select the menu option with a flag until the **Language ** submenu is displayed.

Settings menu

Water hardness

Your commercial dishwasher comes with with a water softener.

You must set the system to the water hardness level of your water supply.

- The commercial dishwasher must be programmed to exactly match the hardness of your water.
- Your local waterworks can tell you the water hardness level in your area.
- Where the water hardness fluctuates (e.g. 17 - 25 gr/gal), always program the commercial dishwasher to the higher value (in this example 25 gr/gal).

The set water hardness is marked with a check ✓.

- Select the hardness of your water and press the centre button to confirm.

gr/gal	mmol/l	°ppm CaCO ₃	Value to set in the display
1	0,2	20	1
2	0,4	40	2
3	0,5	50	3
4	0,7	70	4
5	0,9	90	5
6	1,1	110	6
7	1,3	130	7
8	1,4	140	8
9	1,6	160	9
10	1,8	180	10
11	2,0	200	11
12	2,2	220	12
13	2,3	230	13
14	2,5	250	14
15	2,7	270	15
16	2,9	290	16
17	3,1	310	17
18	3,2	320	18
19	3,4	340	19
20	3,6	360	20
21	3,8	380	21
22	4,0	400	22
23	4,1	410	23
24	4,3	430	24
25	4,5	450	25
26	4,7	470	26
27	4,9	490	27
28	5,0	500	28
29	5,2	520	29
30	5,4	540	30
31	5,6	560	31
32	5,8	580	32
33	5,9	590	33
34	6,1	610	34
35	6,3	630	35
36	6,5	650	36

Rinse aid

For best results the rinse aid dosage can be adjusted. The dosage can be set between 0-6 ml. The factory setting is 3 ml of rinse aid.

If the dishes are spotty:

- Use a higher rinse aid setting.

If the dishes are cloudy or streaky:

- Use a lower rinse aid setting.
- Select the desired amount of rinse aid and press the centre button to confirm.

Buzzer

When the buzzer is activated, an audible tone sounds at the end of a program and when there is a fault.

Buzzer at the end of a program

You will hear the buzzer at the end of a program. It will sound four times in intervals with a noticeable pause in between. Switching the dishwasher off will switch the buzzer off.

Buzzer when there is a fault

In the event of a fault, the buzzer will sound four times in intervals with only a very short pause in between.

The buzzer which sounds when there is fault cannot be deactivated.

Setting the buzzer volume

There are seven different volume settings. If no volume is selected, the buzzer is deactivated.

- Select the desired volume and press the centre button to confirm.

Settings menu

AutoOpen

To improve drying, the door automatically opens a little at the end of a program, except for Rinse & Hold, ProSpeed and Glass no rinse aid (see Program guide).

With the Universal, Pots & Pans and Glasses programs, AutoOpen can only be activated by selecting Extra drying (see Additional functions - Extra drying).

You can also deactivate this function.

- Select the desired setting and press the centre button to confirm.

 If you have deactivated the AutoOpen function but would still like to open the door at the end of a program, make sure that you open the door completely. Otherwise steam from the commercial dishwasher could damage the edge of the countertop because the fan is no longer running.

Optimizing Standby

A few minutes after the last button is pressed or a few minutes after the end of the program the commercial dishwasher will switch to Standby mode to save energy. The display and the indicator lights are switched off and only the  flashes slowly.

If you do not turn the commercial dishwasher off when the program has ended, it will switch off automatically after several minutes in Standby.

You can also deactivate the Optimizing standby function. The display and the indicator lights do not go out, and the commercial dishwasher turns off 6 hours after the end of the program. This results in higher energy consumption.

- Select the desired setting and press the centre button to confirm.

If Refill salt, Refill rinse aid or a fault is displayed, or while a program is running, the commercial dishwasher will not switch to Standby mode.

The refill messages can be turned off without first refilling to let the commercial dishwasher go into Standby mode.
But the fault messages cannot be turned off.

Refill messages

If you want the commercial dishwasher to switch to Standby mode in spite of the Refill messages, you can switch both indicator lights off together.

- Select the desired setting and press the centre button to confirm.

Brightness

There are seven different brightness levels for the display.

- Select the desired brightness and press the centre button to confirm.

Contrast

There are seven different contrast levels for the display.

- Select the desired contrast and press the centre button to confirm.

Filter check

You can set the length of the interval between filter checks as a reminder. You can set an interval between 30 and 60 wash cycles.

The factory setting is an interval of 50 wash cycles.

You can also deactivate this function.

- Select the desired setting and press the centre button to confirm.

External Dos.

Activate automatic dispensing of liquid detergent if you have installed the optional external dosing module.

- Select the desired setting and press the centre button to confirm.

The setting will remain active until you deactivate External dos.

Contact Miele Professional for external liquid dispensing options. The dispensed dosage may only be altered by Miele Service.

Settings menu

Detergent dosage

This function becomes visible when External dos. is activated.

The detergent dosage can be set in millilitres or percent. Contact Miele Professional for the setting.

– Amount in ml

The factory setting is 30 ml.

The dosage can be set from 10 - 100 ml in 2 ml increments.

– Amount as %

The factory setting is 0.50%.

The dosage can be set from 0.17 - 1.67% in increments of 0.03 - 0.04%.

Setting the dosage:

Set the dosage according to the detergent manufacturer's recommendations.

The commercial dishwasher uses approx. 6.5 l of water for the main wash cycle.

Example 1 - Measurement in ml:

The detergent manufacturer recommends 4 ml of detergent per litre of water.

6.5 l x 4 ml/l = 26 ml.

detergent dosage in

ml/L x 0.17% x 6.5L / 10 ml

The detergent manufacturer recommends 4 ml of detergent per liter of water.

Dispensing concentration =

4ml/L x 0.17% x 6.5L / 10ml = 0.442%

- Select the desired amount of detergent or the dosage concentration and press the centre button to confirm.

Venting the Dos. system

The Dos. system will not dispense reliably if there is air in the system.

The Dos. system must be vented

- if it is being used for the first time,
- if the liquid detergent reservoir was not refilled on time and the Dos. system was sucked empty.

 To ensure that the Dos. system functions properly, prior to venting make sure that the detergent container is full enough and that the dispensing lances are firmly attached to the containers.

- Select **Start venting** and press the centre button to confirm.

The venting process begins. The remaining time appears in the display.

The Pre-rinse program is offered directly after the venting process is finished. Start the program in order to dilute and drain any detergent that escaped into the wash cabinet.

High temp rinse

For better drying, the rinse temperature can be increased. This function is not available for all programs (see Program guide).

- Select the desired setting and press the centre button to confirm.

Water plus

When selected, more water will be used for the wash cycle. This function is not available for all programs (see Program guide).

- Select the desired setting and press the centre button to confirm.

Preselect progr

You can chose whether to preset the Normal program or the last selected program when the commercial dishwasher is switched on.

- Select the desired setting and press the centre button to confirm.

Settings menu

Showroom program

Demo mode for showrooms only!

The commercial dishwasher is equipped with various demo programs for showroom use.

- **Demo with sound:**
This program activates the pumps to demonstrate the sound of the dishwasher washing (without water).
- **Demo AutoOpen:**
The door will open automatically.

To switch Demo mode on

- Select the desired option.
- Select **On** and press the centre button to confirm.
- Close the door.

The Demo begins.

To switch Demo mode off

Demo mode ends automatically after one cycle.

Factory default

If you have changed any settings from the factory default, you can reset them back to the factory default settings. An activated external dispensing module and its respective amount of detergent or dosage concentration will not be reset.

- Select **Reset to default** and press the centre button to confirm.

To close the Settings menu

You can close the Settings menu with **Close**.

- Select **Close** and press the centre button to confirm.

The last selected program is displayed briefly and the respective indicator light comes on.

After a short while, the estimated program runtime is displayed.

General requirements for measuring noise

The dishwasher must be loaded with **16 place settings** and the **Normal** program must be used.

Installation requirements for measuring noise

The dishwasher must be installed as follows:.

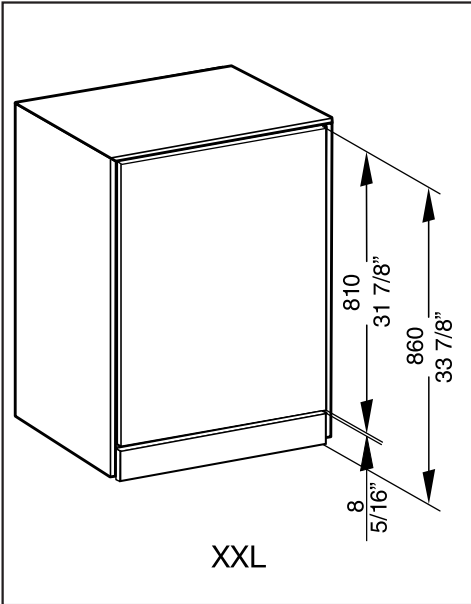

- Install the dishwasher into an appropriate housing unit.
- Secure the front panel.

Noise measurement

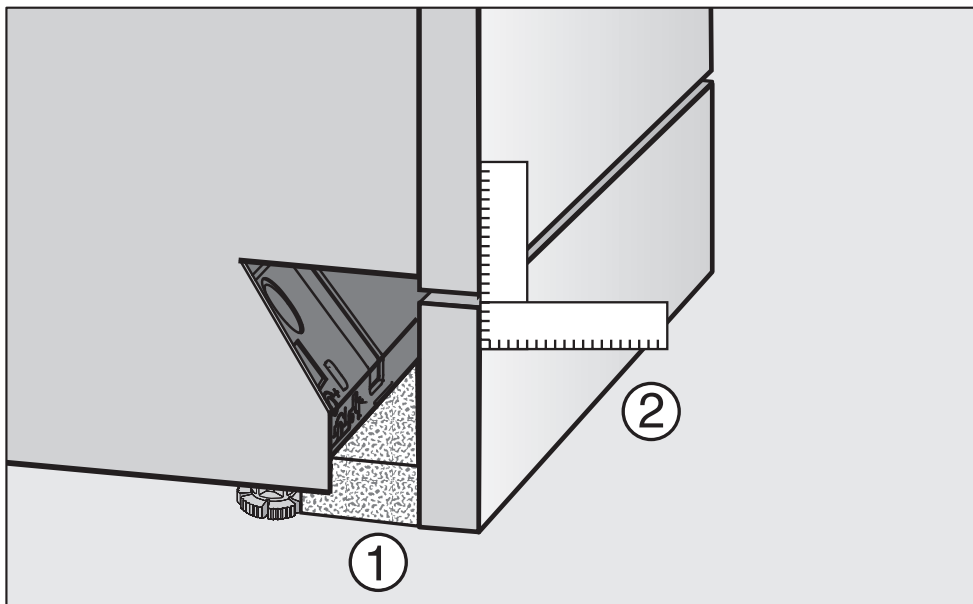

- Push the insulation mat supplied (depending on model) under the plinth until it is up against the appliance feet ①.
- Attach the toe-kick so that it is flush with the door front ②.

Miele

PROFESSIONAL

Canada **Miele Limited**

Professional Division
161 Four Valley Drive
Vaughan, ON L4K 4V8
Phone: 1-888-325-3957
Fax: 1-800-803-3366
www.mieleprofessional.ca
professional@miele.ca

Miele Professional Technical Service

Phone: 1-888-325-3957
Fax: 1-800-803-3366
serviceprofessional@miele.ca

Germany

Miele & Cie. KG
Carl-Miele-Straße 29
33332 Gütersloh



Free Manuals Download Website

<http://myh66.com>

<http://usermanuals.us>

<http://www.somanuals.com>

<http://www.4manuals.cc>

<http://www.manual-lib.com>

<http://www.404manual.com>

<http://www.luxmanual.com>

<http://aubethermostatmanual.com>

Golf course search by state

<http://golfingnear.com>

Email search by domain

<http://emailbydomain.com>

Auto manuals search

<http://auto.somanuals.com>

TV manuals search

<http://tv.somanuals.com>