

## Operating instructions

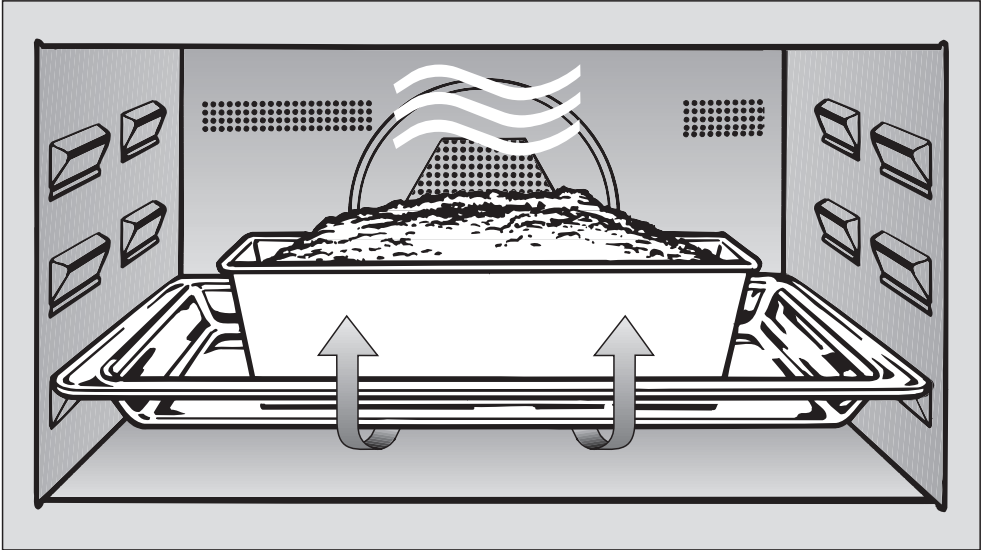

## Microwave combination oven H 4010 BM, H 4020 BM





To avoid the risk of accidents or damage to the appliance it is **essential** to read these operating instructions before it is installed or used for the first time.







M.-Nr. 06 230 140

# Contents

---

<b>Description of the appliance</b> . . . . .	4
<b>Warning and Safety instructions</b> . . . . .	6
<b>Caring for the environment</b> . . . . .	12
<b>Before using for the first time</b> . . . . .	13
Set the clock . . . . .	13
Cleaning and heating up for the first time . . . . .	13
<b>Operating modes</b> . . . . .	14
Microwave function . . . . .	14
Traditional oven functions . . . . .	15
Combination programmes . . . . .	15
<b>Suitable containers for microwave ovens</b> . . . . .	16
Material and shape . . . . .	16
Testing dishes for their suitability . . . . .	19
A cover . . . . .	20
<b>Operation</b> . . . . .	21
Controls . . . . .	21
Selecting an oven function . . . . .	21
Temperature selection . . . . .	21
<b>Timer</b> . . . . .	22
Controls . . . . .	22
-, ▲ and + buttons . . . . .	22
Display . . . . .	22
Triangle ▲ in the display . . . . .	22
Setting the time of day . . . . .	23
Setting the minute minder . . . . .	24
To set the minute minder . . . . .	24
To cancel the time set for the minute minder . . . . .	24
Programming cooking duration . . . . .	25
Switching the cooking programme off automatically . . . . .	25
Switching the oven on and off automatically . . . . .	26
End of cooking duration . . . . .	27
To check and change an entered value . . . . .	27
To cancel programmed cooking durations . . . . .	27
<b>Microwave</b> . . . . .	28
<b>Combination programmes</b> . . . . .	29
Microwave + Fan plus    . . . . .	29
Microwave + Grill   . . . . .	30

---

<b>Altering the time of day display and audible tone</b> . . . . .	31
Time of day display (P 1) . . . . .	31
Audible tone (P 2) . . . . .	32
<b>Defrosting</b> . . . . .	33
Chart for defrosting food . . . . .	34
<b>Reheating</b> . . . . .	35
Chart for reheating food . . . . .	36
<b>Cooking</b> . . . . .	37
Microwave  . . . . .	37
Fan plus  . . . . .	38
Combination programmes . . . . .	38
Cooking chart . . . . .	39
Chart for cooking, browning and crisping food . . . . .	40
<b>Defrosting and Reheating / Cooking</b> . . . . .	41
Microwave  . . . . .	41
Combination programme . . . . .	41
<b>Grilling</b> . . . . .	42
Chart for grilling . . . . .	43
<b>Baking</b> . . . . .	44
Fan plus  . . . . .	44
Combination programme . . . . .	44
Tips on baking . . . . .	45
Baking chart . . . . .	46
<b>Cleaning and care</b> . . . . .	47
E-cloth . . . . .	47
<b>Problem solving guide</b> . . . . .	51
<b>After sales service</b> . . . . .	54
<b>Electrical connection IRL, U.K., ZA</b> . . . . .	55
<b>Installation</b> . . . . .	57

# Description of the appliance

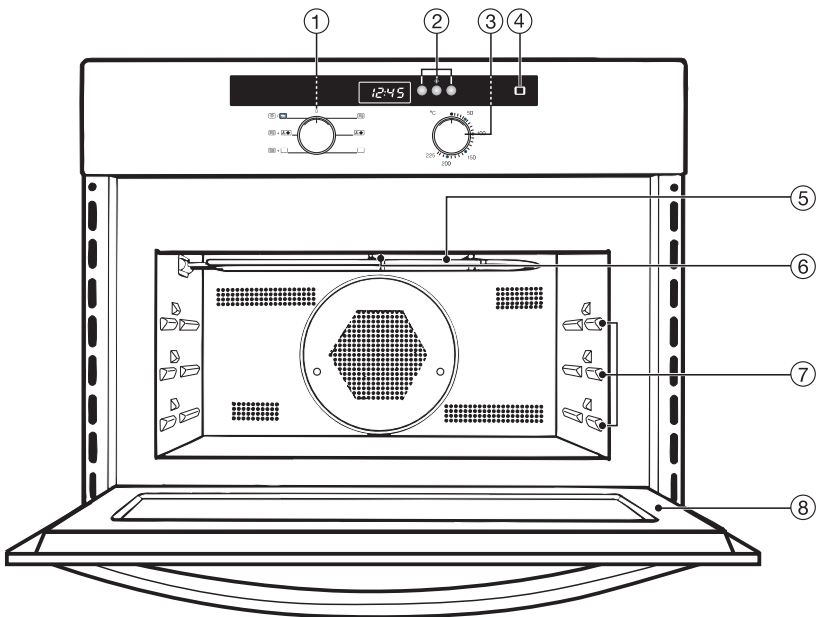
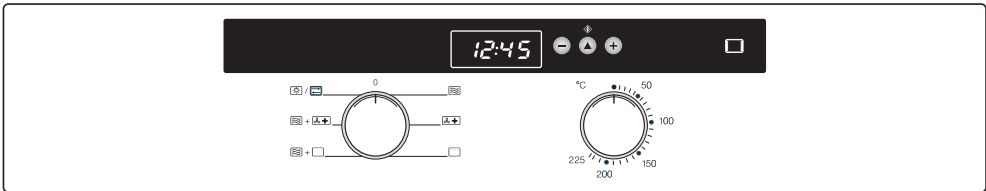

## Control panel

- ① Function selector
- ② Timer
- ③ Temperature selector
- ④ Temperature indicator light

## Oven interior

- ⑤ Grill element
- ⑥ Oven interior lighting
- ⑦ Three shelf levels
- ⑧ Oven door

## Accessories supplied

### Glass tray

The glass tray is suitable for use with all cooking functions.

### Combi rack for use with the glass tray

The combi rack must always be used with the glass tray. It can be used either way up to vary the height between it and the grill element and thus suit the cooking function and type of food being cooked.

The combi rack is designed to be compatible with microwaves. However, it must not be placed directly on the stainless steel floor of the oven, as this could cause arcing to occur.

### Boiling rod

When heating liquids, the boiling rod provided should always be placed into the container. It helps liquids to heat evenly.

# Warning and Safety instructions

---

This appliance complies with all relevant legal safety requirements. Improper use can present a risk of both personal injury and material damage.

To avoid the risk of accidents and damage to the appliance please read these operating instructions carefully before installation and before using it for the first time. They contain important notes on installation, safety, operation and care of the appliance.

Keep these operating instructions in a safe place and pass them on to any future user.

## Correct use

■ The appliance is intended for domestic use only: to cook food, and in particular to defrost, reheat, cook, bake, and to grill. Any other usage is not supported by the manufacturer and could be dangerous. The manufacturer cannot be held liable for damage caused by incorrect or improper use of the appliance.

■ Never use the appliance to store or dry items which could ignite easily. Moisture evaporates. Fire hazard.

■ This appliance is not a toy! To avoid the risk of injury, do not allow children to play on or near it or to play with the controls. Supervise its use by older children, the elderly or infirm. If allowing older children to use the appliance without supervision, please ensure that they are aware of how the oven works and understand the dangers of improper use.

## Technical safety

■ If the connection cable is damaged, the new cable must be fitted by a Miele approved service technician.

■ Do not use the microwave function of the appliance if

- the door is warped,
- the door hinges are loose,
- holes or cracks are visible in the casing, the door, the door seal or the oven interior walls.

Operating the appliance with this type of damage will result in microwave leakage and present a hazard to the user.

■ Never open the casing of the appliance.

Tampering with electrical connections or components and mechanical parts is highly dangerous and can cause operational faults or electric shock.

# Warning and Safety instructions

---

Before connecting the appliance to the mains supply make sure that the rating on the data plate corresponds to the voltage and frequency of the household supply. This data must correspond in order to avoid risk of damage to the appliance. Consult a qualified electrician if in any doubt.

Do not connect the appliance to the mains electricity supply by an extension lead. Extension leads do not guarantee the required safety of the appliance (e.g. danger of overheating).

The electrical safety of this appliance can only be guaranteed when continuity is complete between the appliance and an effective earthing system which complies with local and national safety regulations. It is most important that this basic safety requirement is present and regularly tested, and where there is any doubt, the household wiring system should be inspected by a qualified electrician. The manufacturer cannot be held liable for the consequences of an inadequate earthing system (e.g. electric shock).

The appliance must be built in before operation to ensure that no electrical components are accessible.

Installation work and repairs may only be carried out by suitably qualified and competent persons in accordance with local and national safety regulations. Repairs and other work by unqualified persons could be dangerous and the manufacturer will not be held liable.

Ensure current is not supplied to the

appliance until after maintenance or repair work has been carried out.

This equipment may only be installed in mobile installations such as ships, caravans, aircraft etc. if a risk assessment of the installation has been carried out by a suitably qualified engineer.

The appliance is only completely isolated from the electricity supply when:

- the mains fuse is withdrawn,
- or the screw-out fuse is removed (in countries where this is applicable),
- or it has been switched off at the isolator switch or at the wall socket and the plug has been withdrawn.

## Use

### General notes

Always ensure that food is sufficiently cooked or reheated. Many factors will affect the overall cooking time, including the size and amount of food, its initial temperature, changes to recipe and the shape and size of cooking container. Some foods may contain micro-organisms which are only destroyed by thorough cooking, therefore when cooking or re-heating foods, e.g. poultry it is particularly important that food is fully cooked through (at temperatures of over 70°C for more than 10 minutes). If in doubt, select a longer cooking or reheating time.

# Warning and Safety instructions

---

It is important that the heat is allowed to spread evenly throughout the food being cooked.

This can be achieved by stirring and/or turning the food, and by observing a sufficiently long standing time, which should be added to the time needed for cooking, reheating or defrosting.

Always remember that cooking, reheating and defrosting times using microwave power are usually considerably shorter than with traditional methods of food preparation (Fan plus, Grill). Excessively long cooking times can lead to food drying out and burning, or could even cause it to catch fire. Do not use the microwave function to dry breadcrumbs, flowers, herbs, grain etc. Use the Fan plus function for this type of procedure and do not leave the oven unattended.

Do not use the microwave function to heat up cushions or pads filled with cherry kernels, wheat grain, lavender or gel, such as those used in aromatherapy. These pads can ignite when heated even after they have been removed from the appliance.

Exercise caution when cooking or reheating food with a high sugar content, e.g. Christmas pudding. If heated for too long the sugar may caramelize or ignite.

Do not use full power to warm empty dishes. The lack of food or incorrect loading could cause damage to the appliance.

Do not leave the oven unattended when cooking with oils and fats as

these can be a fire hazard if allowed to overheat.

If smoke occurs in the oven, to avoid fuelling any flame do not open the oven door. Turn the function selector to "0", or switch off at the mains and remove the plug from the socket. Do not open the oven door until the smoke has dispersed.

Never heat undiluted alcohol in the oven as this can easily ignite.

Do not heat up tins in the appliance. Pressure can build up and they may explode, resulting in injury or damage.

Cover any food which is left in the oven to be kept hot, as moisture in the food could lead to corrosion damage in the oven. This also prevents the food from drying out.

Try to avoid the interior walls being splashed with food or liquids containing salt. If it does happen wipe these away thoroughly, to avoid corrosion on stainless steel surfaces.

The glass tray and the combi rack take a maximum load of 8 kg. Exceeding this weight limit can cause them damage.

Do not lean or sit on an open oven door, or place heavy items on it. This could damage the appliance. The oven door can support a maximum load of 8 kg.



# Warning and Safety instructions

Never place the hot glass tray (or any other hot cooking containers) on a cold surface, such as a tiled or granite worktop.

The glass tray or container could crack or shatter and the worktop surface could get damaged. Place it on a suitable pot rest or a wire rack.

Do not use a steam-cleaning appliance to clean this appliance. Pressurised steam could reach the electrical components and cause a short circuit.

Do not use the appliance to heat up the room. Due to the high temperatures radiated, objects left near the appliance could catch fire.

When using kitchen appliances connected to sockets near the appliance, ensure that the cable cannot get trapped in a hot oven door, which could melt the cable insulation and be dangerous.

## Microwave function

Before serving, remember to allow a sufficient standing time and then always check the temperature of the food after taking it out of the oven. The temperature of the container is not an indication of the temperature of the food or liquid in it. When heating food and drink, remember that the heat is created in the food itself and that the container will normally be cooler. The dish is only warmed by the heat of the food.

**This is particularly important when preparing food for babies, children, and the elderly or infirm.**

Always stir or shake baby milk and food after heating it up, and taste it first to make sure it is not too hot.

Never cook or reheat food or liquids in sealed containers, jars or bottles.

With baby bottles, the screw top **and** teat must be removed. Otherwise pressure builds up which can cause the bottle or container to explode posing a severe risk of injury.

When heating liquids, the boiling rod provided should always be placed into the container.

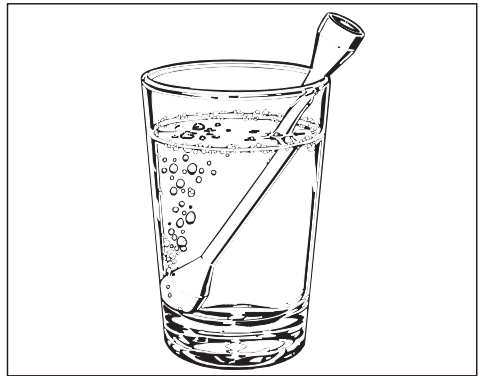

When heating liquids, milk, sauces etc., using microwave heat without the boiling rod, the boiling point of the liquid may be reached without the production of typical bubbles. The liquid does not boil evenly throughout. This so-called "boiling delay" can cause a sudden build up of bubbles when the container is removed from the oven or shaken.

# Warning and Safety instructions

---

This can lead to the liquid boiling over suddenly and explosively. Danger of burning.

The formation of bubbles can be so strong that the pressure forces the oven door open. The user could be injured and the appliance damaged.

The boiling rod ensures that the liquid boils evenly and that bubbles form at an early stage during the operation.

Do not use any containers or cutlery made from or containing metal, aluminium foil, lead crystal glassware, temperature-sensitive plastics, wooden utensils or cutlery, metal clips or wire ties. Do not use bowls with milled rims, or cream pots with the tinfoil lid only partially removed. Such items could be damaged or cause a fire hazard.

The combi rack supplied with the appliance must be used with the glass tray. It is designed to be compatible with microwaves and can therefore be used with the microwave function. Do not place it on the oven floor.

N.B. It gets hot when using the microwave function. Danger of burning.

Do not leave the oven unattended when reheating or cooking food in disposable containers made of plastic, paper or other inflammable materials. Before using single use containers make sure they are suitable for use in microwave ovens. See appropriate section.

Eggs can only be cooked in their shells using microwave heat in a specially designed egg-boiling device

available from specialist shops.

Similarly, hard-boiled eggs should not be reheated using microwave heat as this may lead to the eggs exploding, even after they have been taken out of the oven.

Eggs can be cooked without their shells using microwave heat only if the yolk membrane has been punctured several times first.

The pressure could otherwise cause the egg yolk to explode.

Danger of injury.

Do not reheat food in the oven in heat-retaining bags which are intended for use in normal ovens. These heat-retaining bags usually contain a thin layer of aluminium foil which reflects microwaves. This reflected energy can, in turn, cause the outer paper covering to become so hot that it ignites.

Food with a thick skin or peel, such as tomatoes, sausages, jacket potatoes and aubergines, should be pierced or cut in several places to allow steam to escape and prevent the food from bursting.

Ovenproof earthenware can retain a considerable amount of moisture. Earthenware and porcelain containers with hollow handles and lid knobs must only be used with the microwave function if they have vent holes, which allow the moisture to escape. Without vent holes there can be a pressure build-up, causing the container to crack or shatter, with the danger of injury.

# Warning and Safety instructions

---

■ To check food temperature, first interrupt the cooking process. Then use a thermometer specifically approved for food use to measure the temperature of the food. Never use a thermometer containing mercury or liquid, as these are not suitable for use with very high temperatures and will break very easily.

## **Traditional oven functions: Fan plus, Grill**

Caution. Danger of burning. When the oven is being used as a traditional oven it can get very hot.

■ Great care should be taken to ensure that small children do not touch the oven when it is being used. External parts of the oven such as the door glass, vents, handle and fascia panel can become quite hot. Danger of burning!

■ Wear oven gloves when placing food in the oven, turning it or removing it. When the Grill is being used, either solo or in a combination programme, the element becomes very hot and there is a danger of burning.

■ Wait until the grill element has cooled down before lowering it for cleaning. Danger of burning! Do not use force to lower it as this can cause it to break.

■ In countries where there are areas which may be subject to infestation by cockroaches or other vermin, pay particular attention to keeping the appliance and its surroundings in a clean condition at all times. Any

damage which may be caused by cockroaches or other vermin will not be covered by the guarantee.

## **Disposal of your old appliance**

■ Before disposing of your old appliance, first make it unusable. Cut off the cable and render any plug unusable. Appliances which have been built-in should be disconnected from the mains supply by a qualified person. This will prevent the appliance from being misused.

The manufacturer cannot be held liable for damage caused by non-compliance with these Warning and Safety instructions.

# Caring for the environment

---

## **Disposal of the packing material**

The transport and protective packing has been selected from materials which are environmentally friendly for disposal and can normally be recycled.

Ensure that any plastic wrappings, bags etc. are disposed of safely and kept out of the reach of babies and young children. Danger of suffocation.

Rather than just throwing these materials away, please ensure that they are recycled.

## **Disposal of your old appliance**

Old appliances contain materials which can be reclaimed or recycled. Please contact your dealer, your local waste collection centre or scrap merchant about potential recycling schemes.

Ensure that the appliance presents no danger to children while being stored for disposal. See the appropriate section in the Warning and Safety instructions.

# Before using for the first time

## Set the clock

To enter the time of day the function selector must be at "0".

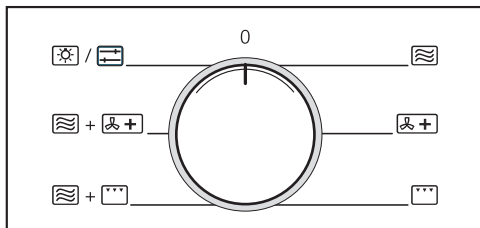

- Connect the appliance to the electricity supply.

In the timer display:

- the clock symbol will light up,
- and **12:00** and the triangle will flash underneath the symbol.

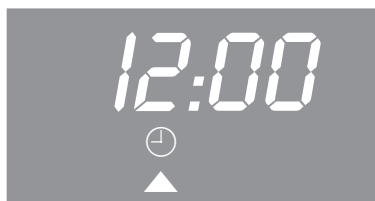

- Use the **+** or **-** button to enter the hour first of all.
- Press the **▲** button.

This confirms the hour and the minutes will then start to flash.

- Now use the **+** or **-** button to enter the minutes.
- Press the **▲** button.

When the time has been entered, the clock advances minute by minute.

## Cleaning and heating up for the first time

- Wipe out the **oven interior** using warm water and a little washing up liquid. Dry with a soft cloth.

Do not close the oven door until the oven interior is dry.

- Wash the **accessories**.

**New appliances** have a slight smell on first use. To dissipate this smell, run the oven for at least 1 hour with nothing in it.

- Select Fan plus .

The cooling fan starts and the oven interior lighting comes on.

- Set the highest temperature with the temperature selector.

The temperature selector must only be turned in a clockwise direction as far as it will go, and then back again. Do not force it right round in a clockwise direction as this would damage the selector.

The indicator light on the control panel will light up whilst the oven is heating up.

The timer can be used to set the finish time (see "Switching off automatically").

Please ensure the room is well ventilated during this operation.

# Operating modes

---

## Microwave function

Microwave cooking offers the benefits of speed, convenience and nutritional advantages when food does not require browning or crisping.

### How does the microwave oven function?

In a microwave oven there is a high-frequency tube called a magnetron. This converts electrical energy into microwaves. These microwaves are distributed evenly throughout the oven interior and rebound off the metal sides of the oven interior to reach the food from all sides.

In order for microwaves to reach the food, they must be able to penetrate the cooking utensil being used. Microwaves can penetrate porcelain, glass, cardboard and plastics but not metal. Do not, therefore, use utensils made of metal, or which contain metal, for example in the form of gold or silver trim. The metal reflects the microwaves and this could lead to the creation of sparks. The microwaves cannot be absorbed.

Microwaves pass through a suitable container and find their way directly into the food.

All food contains moisture molecules which, when subjected to microwave energy, start to oscillate 2.5 thousand million times a second. The friction caused by this vibration creates heat, which first starts developing around the outside of the food and then slowly penetrates towards the centre. The moisture, fat and sugar content of food

will affect the speed at which it is cooked.

As heat is produced directly in the food,



- food can generally be cooked without adding much liquid or cooking oil
- cooking, reheating and defrosting in a microwave oven is quicker than using conventional methods.
- nutrients, such as vitamins and minerals, are generally retained
- colour, texture and taste of food are not impaired.

Microwaves stop being produced as soon as the cooking process is interrupted or the appliance door is opened.

When the appliance is in operation, the closed, sealed door prevents microwaves escaping from the appliance.

## Traditional oven functions

This oven offers the following traditional oven functions:

- Fan plus 
- Grill 

These cook and brown the food.

### Fan plus

This system works by the circulation of heated air.

A fan in the back wall draws in the air, heats it over a ring element and blows it back into the oven cavity through the carefully spaced openings in the back panel.

The oven does not usually need to be pre-heated as the heated air reaches the food straight away. Pre-heating may be necessary for foods such as puff pastry and yeast mixtures where instant heat is required to make them rise quickly.



When using Fan plus, you can bake and roast on two different levels at the same time.

Because the fan circulates the heated air throughout the oven, lower temperatures can be used than with Conventional heating.

### Grill

The grill is ready for use when it glows red a few minutes after being switched on. Pre-heat with the oven door closed for approx. 5 minutes before starting to cook. Grill with the oven door closed.

## Combination programmes

- Microwave + Fan plus 
- Microwave + Grill 

The combination programmes enable food to be reheated and cooked quickly with even browning results.

Combining microwave power with Fan plus ensures that heat reaches food being roasted or baked very quickly. This helps reduce cooking durations and keeps energy consumption to a minimum.

In general when using the combination programmes, you should not set the microwave power level higher than 150 W for baking, and not higher than 300 W for cooking, roasting and grilling.

# Suitable containers for microwave ovens

## Microwaves

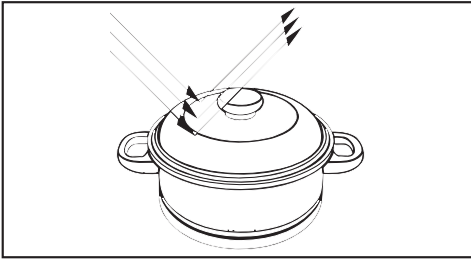

- are reflected by metal,

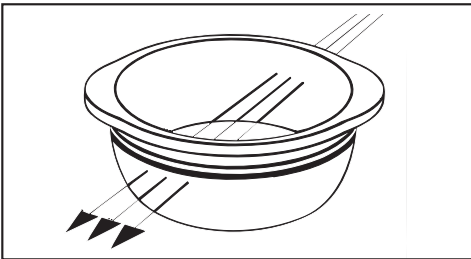

- pass through glass, porcelain, plastic and card,

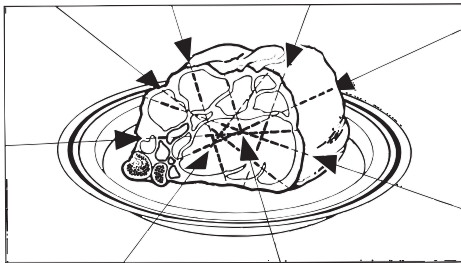

- and are absorbed by food.

When using microwave power you should always place the food / dish centrally on the glass tray and slide the tray into the first shelf level from the bottom. Placing the dish on the floor of the oven will give unsatisfactory and uneven results.

## Material and shape

The material and shape of containers used affect cooking results and times. Heat distribution is more even in round and oval shaped flat containers than in rectangular containers, providing better results.

## Metal

Metal containers, aluminium foil and metal cutlery, or china with metallic decoration such as gold rims or cobalt blue must not be used in microwave mode.

The metal reflects the microwaves, hindering the cooking process.



# Suitable containers for microwave ovens

Exceptions:

- If recommended by the producer, pre-cooked meals in aluminium foil containers can be defrosted and reheated in the appliance using microwave power. Important: Remove the lid first. However, as food is only heated from the top it is better to remove the food from the aluminium foil container and transfer it to a dish suitable for a microwave oven. The heat distribution will be more even. Do not place aluminium foil containers on the metal rack as this can cause arcing to occur and damage the oven.
- For even defrosting and to avoid overcooking unevenly shaped cuts of meat, poultry or fish, small pieces of aluminium foil may be used to mask wing-tips or other thin parts for the last few minutes of the process.

Make sure that the aluminium foil is at least 2 cm from the oven walls at all times. It must not touch the walls.

- Metal meat skewers or clamps should only be used if they are very small in comparison to the size of the cut of meat.

The **combi rack** supplied with the appliance is suitable for use with microwave power. However it must not be placed on the oven floor.

The rack can get hot.

## Glassware

Heat-resistant glass or ceramic glass are ideal for use in the microwave oven.

Crystal glass contains lead which could cause the glass to crack. Glass dishes with a milled rim are subject to the same risk. Both are unsuitable.

## Porcelain

Porcelain is a suitable material.

Do not use porcelain with gold or silver edging or items with hollow knobs or handles, as insufficient ventilation may cause pressure.

## Earthenware

Decorated earthenware is only suitable if the decoration is beneath an all-over glaze.

Earthenware can get very hot, and may crack.

## Glazes and colours

Some glazes and colours contain metals which make them unsuitable for use in a microwave oven.

# Suitable containers for microwave ovens

## Plastics

Plastics must only be used with Microwave-Solo. They must be heat-resistant to a minimum of 110 °C. Otherwise the plastic may melt and fuse with the food.

Special plastic utensils designed for use in microwave ovens are available from good retail outlets. When purchasing plasticware, make sure that it is suitable for use in a microwave oven.

Melamine is not suitable for use in this oven. Melamine absorbs microwave energy and gets hot.

Disposable containers, such as trays made from polystyrene, can only be used for very short timed warming and reheating of food.

Plastic boiling bags can be used for cooking and reheating.

They should be pierced beforehand so that steam can escape. This prevents a build-up of pressure and reduces the risk of the bag bursting.

## Roasting bags and tubes

Roasting tubes should be about 40 cm longer and roasting bags about 20 cm longer than the food being roasted, and carefully tied with string. Turn the ends over and secure them. The bag should be pierced according to the manufacturer's instructions.

Do not use metal clips, plastic clips containing metal parts or paper ties containing wire.

There is a danger that they will ignite when heated.

## Wood

Wooden dishes are not suitable. Moisture contained in the wood evaporates when exposed to microwave energy, causing the wood to dry and crack.

## Disposable containers

Only those plastic disposable containers which are specified by the manufacturer as suitable for use in a microwave oven may be used.

Do not leave the oven unattended when reheating or cooking food in disposable containers made of plastic, paper or other inflammable materials.

Disposable containers are not always recyclable or bio-degradable.

# Suitable containers for microwave ovens

## Testing dishes for their suitability

If in doubt as to whether glass, earthenware or porcelain plates or dishes are suitable for use in a microwave oven, a simple test can be performed:

- Place the container centrally on the glass tray and slide into the lowest shelf level.
- Close the door.

A microwave oven process cannot be started until the door is closed.

- Turn the function selector to microwave mode.



The display shows the highest power level (1000 W).

- Wait for 5 seconds or press the ▲ button to confirm your choice.



- Whilst triangle ▲ is flashing, enter a duration of 30 seconds using the + button.

The ◊ symbol will flash in the display to tell you to start the process.



- Press the ▲ button to start the process.

The oven interior light comes on. The time entered counts down in the display in seconds.

If a crackling noise is heard accompanied by sparks during the test, switch off the appliance immediately. Turn the function selector to "0".

Any crockery which causes this reaction is unsuitable for use with microwave power.

At the end of the 30 seconds the buzzer will sound and the ⇨ symbol will start flashing. Press any button to cancel the buzzer.

The time of day will reappear in the display. The oven interior light goes out.

If any doubt exists about the suitability of containers, please contact the supplier.

This test cannot be used to check whether items with hollow knobs or handles are suitable for use with microwave power.

# Suitable containers for microwave ovens

## A cover

- prevents too much steam escaping, especially when cooking foods which need longer to cook, such as potatoes.
- speeds up the cooking process.
- prevents food from drying out.
- prevents any loss of aroma.
- helps keep the oven interior clean.

Always use lids or covers made of microwave-safe glass or plastic, or use a clingfilm recommended for use in a microwave oven, (pierce as instructed by the manufacturer).

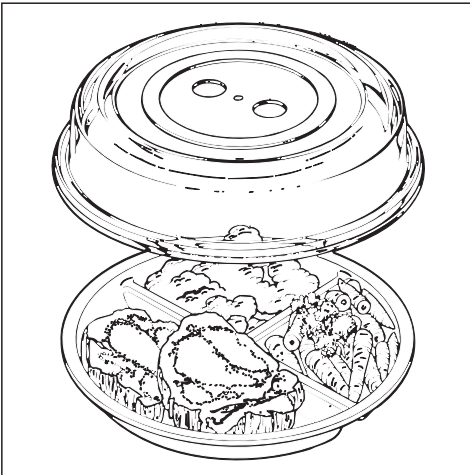

Unsuitable clingfilm can melt into the food.

Sealed glass containers, such as jars of baby food must be opened before they are placed in the oven. Do not attempt to heat them up unopened.

## Do not use a cover if

- food coated with breadcrumbs is being cooked.
- cooking meals which are to be given a crisp finish.
- using a combination programme.

The cover supplied may only be used in microwave-solo operation.

The cover can only withstand temperatures of up to 110 °C. Higher temperatures generated by grilling or fan heat could cause the plastic to distort and fuse with the food.

## Controls

The oven controls consist of an oven function selector and a temperature selector.

### Selecting an oven function

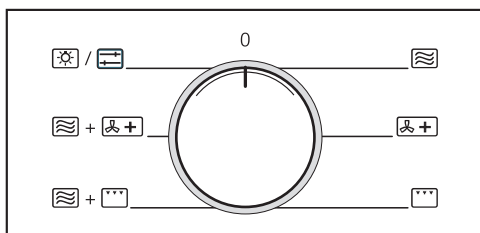

The function selector can be turned clockwise or anti-clockwise.

The following settings are available:

- Light / For switching on the oven light independently. This position is also be used for altering the time display and the buzzer tone.
- Microwave
- Fan plus
- Grill
- Microwave + Grill
- Microwave + Fan plus

### Temperature selection

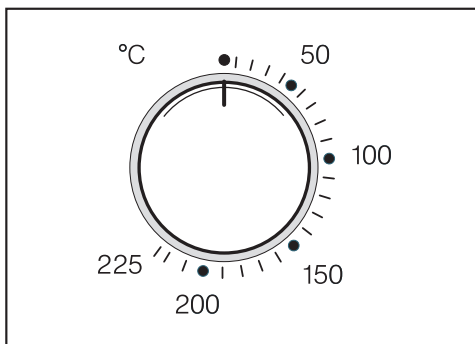

The temperature can be freely selected within the given range using the **temperature selector**.

The temperature selector must only be turned in a clockwise direction as far as it will go and then back again. Do not force it right round in a clockwise direction as this would damage the selector.

When the temperature selector is turned to a temperature setting, the temperature indicator light on the control panel will light up. It remains on whilst the oven is heating up.

When the pre-selected temperature is reached, the heating element switches itself off. When the temperature falls below that selected, the heating element switches on again automatically.

The grill temperature is set automatically and cannot be changed. The position of the temperature selector is of no relevance during grilling. The indicator light on the control panel stays on while the oven is heating up.

# Timer

The timer can:

- show the time of day,
- be used as a minute minder,
- switch the oven off, or on and off automatically.

## Controls

The timer is operated with the ▲, + and - buttons and the display.

### -, ▲ and + buttons

The ▲ button is used to scroll to the symbol for the setting you wish to select or change.

W Microwave power level

⏰ Minute minder

🕒 Time of day

⏱️ Cooking duration

➡️ End of cooking duration

You can use the - and + buttons to decrease or increase times and microwave power levels or to change the time of day display and also the buzzer.

Entries made are shown in the **display**.

## Display



The display will vary depending on which symbol the triangle ▲ is underneath

- the microwave power level in watts W
- the minute minder time set ⏰
- the time of day 🕒
- the cooking duration ⏱️
- the end of cooking duration ➡️

### Triangle ▲ in the display

When the ▲ button is pressed, the **symbols for the settings** that can be entered light up in the display.

Press the ▲ button repeatedly until triangle ▲ is underneath the required symbol in the display.

When **triangle ▲**

- **is flashing** under a symbol, the value for that setting can be entered or changed.
- **lit up** under a symbol, the value for that setting will be displayed, but changes cannot be made to it.

**Whilst triangle ▲ is flashing**, use the - or + immediately to make any changes to the setting selected:

- The **+ button** increases the value shown.
- The **- button** decreases the value shown.

Triangle ▲ will flash for approx. 5 seconds.

Settings can only be changed using the - or + buttons whilst it is flashing. If this period has elapsed, you will need to call up the required symbol again by pressing the ▲ button.

Each press on the - or + button alters the time for the microwave programmes in one-second steps, and the time for all other functions in one-minute steps.

Holding the button pressed in for longer, speeds up the change in the display.

## Setting the time of day

When the appliance is first connected to the power supply, or after a power cut, "12:00" will flash in the display.

The time of day can only be entered if the function selector is at "0".

- Turn the function selector to "0".



- Press the ▲ button repeatedly until triangle ▲ is underneath the ⊕ symbol.
- Whilst triangle ▲ is flashing, use the - or + button to enter the hour and confirm by pressing the ▲ button.

The minutes and triangle ▲ will flash.

- Now enter the minutes with the - or + button and confirm by pressing the ▲ button.

As soon as the ⊕ symbol goes out, the time set is saved.

# Timer

---

## Setting the minute minder

The minute minder can be used to time any activity in the kitchen, e.g. boiling eggs.

You can enter a time up to a maximum of 12 hours.

You can set the minute minder at the same time as another timed programmed, e.g. as a reminder to stir a dish or add seasoning etc.

## To set the minute minder



- Call up the  $\triangle$  symbol (minute minder) with the  $\blacktriangle$  button.

"0:00" appears in the display.

- Whilst triangle  $\blacktriangle$  is flashing, use the  $+$  button to enter the required time in hours:minutes.

The time entered counts down in minutes until the last minute which counts down in seconds.

The  $\triangle$  symbol continues to be visible as a reminder that the minute minder is being used.

The minute minder time will be visible counting down in the display, as long as triangle  $\blacktriangle$  is underneath the  $\triangle$  symbol.

## At the end of the time set for the minute minder

- the  $\triangle$  symbol flashes for approx. 1 minute.
- a buzzer sounds five times, if it is switched on (see "Altering the time of day display and buzzer").

## To cancel the time set for the minute minder

- Call up the  $\triangle$  symbol with the  $\blacktriangle$  button.  
Triangle  $\blacktriangle$  must be flashing underneath the symbol.
- Use the  $-$  button to set the minute minder time to "0:00".



## Programming a cooking duration

The timer can be used to switch the appliance off or on and off automatically.

It is a good idea to set the oven to switch on and off automatically for reheating meals and for roasting.

When baking, the oven should not be set to start a long time off. Otherwise batter or dough will dry out and raising agents will lose their effectiveness.

A maximum cooking duration of 12 hours can be set for the Fan plus and Grill functions.

For combination programmes with microwave mode, a maximum duration of 2 hours can be set.

For microwave solo, a maximum duration of 59:59 minutes can be set, with the exception of microwave power level 850 W (30 minutes) and 1000 W (10 minutes).

## Switching the cooking programme off automatically

When you enter a cooking duration, the oven will switch off automatically after the duration entered has elapsed.

To do this:

- Place the food in the oven.
- Set the function and the temperature or microwave power level as appropriate.

The oven light will come on and the oven will heat up.



- Call up the ⇨ symbol (cooking duration) with the ▲ button.

"0:00" appears in the display.

- Whilst triangle ▲ is flashing, use the + button to enter the required duration in hours:minutes.

If no other symbol is selected, the cooking duration will be visible counting down in the display.

# Timer

## Switching the oven on and off automatically

To use the automatic switch-on and switch-off functions on the oven, both the cooking duration and the end time must be entered.

For example:

The current time of day is 10:45. You wish a roast with a cooking duration of 1 h 30 min to be ready at 13:30.

- Place the food in the oven.
- Set the function and the temperature or microwave power level as appropriate.

The oven light will come on and the oven will heat up.

First **enter the cooking duration**:



- Call up the  $\rightarrow|$  symbol (cooking duration) with the  $\blacktriangle$  button.

"0:00" appears in the display.



- Whilst triangle  $\blacktriangle$  is flashing, use the  $+$  button to enter the required duration in hours:minutes (1:30).

Then set the **end time**:

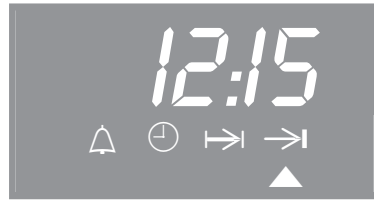

- Call up the  $\rightarrow|$  symbol with the  $\blacktriangle$  button.

The time of day plus the cooking duration entered appear in the display (10:45 + 1:30 = 12:15).



- Use the  $+$  button to change the end time to 13:30.

As soon as triangle  $\blacktriangle$  goes out, the oven light will go out and the heating will switch off.

The end time will now show in the display as long as the triangle is not moved to underneath another symbol.

As soon as the start time (13:30 - 1:30 = 12:00) is reached, the oven light will switch on, and the oven will heat up.

## End of cooking duration

At the end of the cooking duration

- the oven heating switches off automatically.
- the cooling fan will continue to run for a while.
- the  symbol flashes.
- a buzzer sounds five times, if it is switched on (see "Altering the time of day display and buzzer").

- Turn the function selector and the temperature selector to "0".

The buzzer stops and the symbol goes out.

- Remove the food from the oven.

If the function selector and the temperature selector are not moved, the buzzer (if switched on) will sound every five minutes as a reminder that the programme has finished.

This **reminder** continues for up to 30 minutes.

## To check and change an entered value

You can check or change values entered for a cooking programme at any time by calling up the relevant symbol.

## To check

- Call up the symbol for the setting to be checked.

W

The microwave power level will show in the display.



The minute minder time remaining will show in the display.



The time of day will show in the display.



The display shows the cooking duration set or the duration remaining if the programme has started.



The programme end time is displayed.

## To change

- Call up the symbol for the setting to be changed.
- Use the + or - button to change the setting.

## To cancel programmed cooking durations

- Turn the function selector to "0".

If there is a power cut, all data entered will be deleted.

# Microwave

When using microwave power you should always place the food / dish centrally on the glass tray and slide the tray into the first shelf level from the bottom.

Placing the dish on the floor of the oven will give unsatisfactory and uneven results, as no microwaves will reach the food from below.

The following power levels can be selected:

80 W, 150 W, 300 W, 450 W, 600 W, 850 W and 1000 W.

- Turn the function selector to Microwave .



The display shows a suggested power level of 1000 W.

- Whilst triangle ▲ is flashing, use the - button to alter the setting if you wish to select a lower power level.

After 5 seconds or if the ▲ button is pressed, the following will show in the display.



- Whilst triangle ▲ is flashing, use the + button to enter the required duration in minutes:seconds (e.g. 1 minute 30 seconds).

The ◁▷ symbol will flash in the display to tell you to start the process.

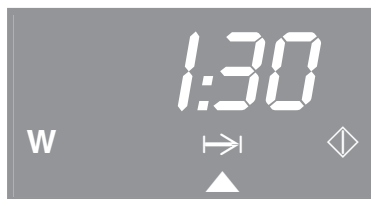

- Press the ▲ button to start the process.

If no other symbol is selected, the cooking duration will be visible counting down in the display. At the end of the cooking duration, a buzzer will sound and the ▷◁ symbol will flash. Press any button to switch the buzzer off early.

The time of day will reappear in the display. The oven light goes out.

If you wait for longer than a few seconds before starting the process, the ▷◁ symbol will appear in the display and you can then set the cooking duration end time.

# Combination programmes

Microwave mode can be combined with either Fan plus or Grill.

Before starting a combination programme you must first select the microwave power level and the time for the process.

## Microwave + Fan plus

- Turn the function selector to Microwave + Fan plus  

The display shows a suggested power level of 300 W.

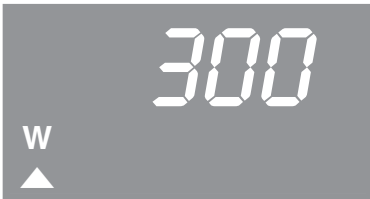

If this power level is not suitable, alter it using the - or + button.

The following power levels can be selected: 80 W, 150 W, 300 W, 450 W.

- To enter the duration press the ▲ button or wait for approx. 5 seconds until the display changes by itself.



- Use the + button to enter the required duration in hours:minutes (e.g. 1 hour 30 minutes).

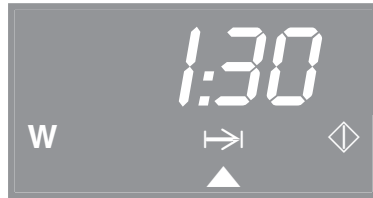

You can enter a duration of up to a maximum of 2 hours.

With a power level of **450 W**, a **maximum of 60 minutes** can be entered.

The ◊ symbol will flash in the display to tell you to start the process.

- Before starting the process, use the temperature selector to choose a temperature for the Fan plus function.

The temperature selector must only be turned in a clockwise direction as far as it will go, and then back again.

Do not force it right round in a clockwise direction as this would damage the selector.

- Press the ▲ button to start the process.

If no other symbol is selected, the cooking duration will be visible counting down in the display.

If you wait for longer than a few seconds before starting the process, the → symbol will appear in the display and you can then set the cooking duration end time.

# Combination programmes

## Microwave + Grill

- Turn the function selector to Microwave + Grill  .

The display shows a suggested power level of 300 W.

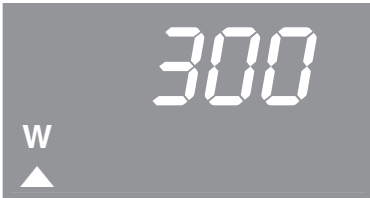

If this power level is not suitable, alter it using the - or + button.

The following power levels can be selected: 80 W, 150 W, 300 W, 450 W.

- To enter the duration press the ▲ button or wait for approx. 5 seconds until the display changes by itself.



- Use the + button to enter the required duration in hours:minutes (e.g. 1 hour 30 minutes).



You can enter a duration of up to a maximum of 2 hours.

With a power level of **450 W**, a **maximum of 60 minutes** can be entered.

The grill temperature cannot be changed.

The ◊ symbol will flash in the display to tell you to start the process.

- Press the ▲ button to start the process.

If no other symbol is selected, the cooking duration will be visible counting down in the display.

If you wait for longer than a few seconds before starting the process, the →| symbol will appear in the display and you can then set the cooking duration end time.

# Altering the time of day display and buzzer

You can alter the time of day display (Programme 1) and the buzzer (Programme 2).

The altered settings are retained after a power cut.



"P I" will appear in the display.

- Press the ▲ button.

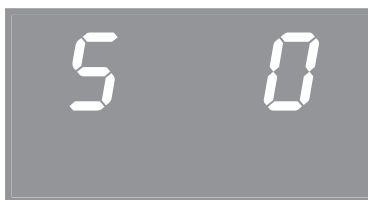

The following appears in the display:

- "5 0", if the **time of day display is switched off**.
- "5 I", if the **time of day display is switched on**.

- Use the + or - button to switch between "I" and "0".

- Press the ▲ button.

This confirms your entry.



Depending on the setting selected, the time of day will either show in the display or the display will remain dark when the function selector is turned to "0".

## Time of day display (P I)

The time of day display can be switched on or off.

When the time of day display is switched off and the function selector is turned to the "0" position, the display remains dark. The time of day continues to run in the background. It reappears when the function selector is turned to one of the functions.

To alter the setting:

- Turn the function selector to the "Light  / 



# Altering the time of day display and buzzer

---

## Buzzer (P 2)

There is a choice of 3 different tones or alternatively, the buzzer can be switched off.

To alter the setting:

- Turn the function selector to the "Light  / 

"P I" will appear in the display.

- Press the + or - button.



"P 2" will appear in the display.

- Press the ▲ button.

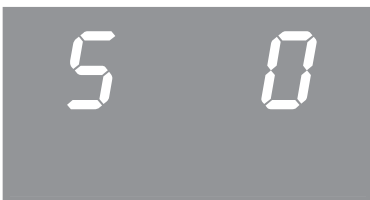

The following appears in the display:

- "5 0", if the **buzzer is switched off**.
- "5 I", if the buzzer is switched to the **quiet setting**.
- "5 2" if the buzzer is switched to the **medium setting**.
- "5 3" if the buzzer is switched to the **loud setting**.

- Use the + or - button to scroll from "0" to "3"

The corresponding buzzer will sound as you do so.

- Press the ▲ button.

This confirms your entry.

The buzzer will now sound at the setting selected (or not at all if you have switched it off) at the end of a cooking programme or minute minder time.



The microwave function can be used to defrost food gently and quickly.

The following settings are recommended as a general guide:

- 80 W  
for defrosting very delicate food, e.g. cream, butter, gateau and cheese.
- 150 W  
for defrosting everything else.

See the chart on the next page for defrosting durations.

- Remove the food from its packaging and place it in a microwave-safe container.
- Place the container centrally on the glass tray and slide into the lowest shelf level.

If defrosting a large quantity, e.g. 2 kg of fish, you can place the food directly on the glass tray and then slide it into the lowest shelf level.

Turn, stir or separate the food about half-way through the defrosting time.

## After defrosting

Allow the food to stand at room temperature long enough to allow the temperature to spread evenly throughout the food.

# Defrosting

## Chart for defrosting food

	Quantity	Microwave power settings		Standing time at room temperature * in mins.
		150 W Time in mins.	80 W Time in mins.	
<b>Dairy products</b>				
Cream	250 ml	-	13 - 17	10 - 15
Butter	250 g	-	8 - 10	5 - 10
Cheese slices	250 g	-	6 - 8	10 - 15
Milk	500 ml	14 - 16	-	10 - 15
Quark / Cream cheese	250 g	10 - 12	-	10 - 15
<b>Cakes / Pastry / Bread</b>				
Sponge cake	1 piece approx. 100 g	1 - 2	-	5 - 10
Sponge cake	300 g	4 - 6	-	5 - 10
Fruit cake	3 pieces approx. 300 g	6 - 8	-	10 - 15
Butter cake	3 pieces approx. 300 g	5 - 7	-	5 - 10
Cream cake	1 piece approx. 100 g	-	1.5	5 - 10
	3 pieces approx. 300 g	-	4 - 4.5	5 - 10
Yeast buns, puff pastries	4 pieces	6 - 8	-	5 - 10
Bread rolls	1 roll approx. 50 g	1.5 - 2	-	5 - 10
Bread rolls	4 rolls approx. 200 g	4 - 6	-	5 - 10
Sliced bread	1 slice	0.5	-	3 - 4
<b>Fruit</b>				
Strawberries, raspberries	250 g	7 - 8	-	5 - 10
Red / Blackcurrants	250 g	8 - 9	-	5 - 10
Plums	500 g	12 - 16	-	5 - 10
<b>Meat</b>				
Minced beef	500 g	16 - 18	-	5 - 10
Chicken	1,000 g	34 - 36	-	10 - 15
<b>Vegetables</b>				
Peas	250 g	8 - 12	-	5 - 10
Asparagus	250 g	8 - 12	-	10 - 15
Beans	500 g	13 - 18	-	10 - 15
Red cabbage	500 g	15 - 20	-	10 - 15
Spinach	300 g	12 - 14	-	10 - 15

\* During this time the temperature spreads evenly through the food.

**The information given in this chart is intended only as a guide.**

The microwave function is particularly suitable for reheating food.

Select the following microwave power settings to reheat food

drinks. . . . . 1000 W  
food . . . . . 850 W or 600 W  
baby food . . . . . 450 W

Food for babies and young children or the elderly must not be allowed to get too hot. We do not recommend heating or reheating foods or drinks for babies or young children in the microwave oven. Any decision to do this is the responsibility of the user, and should only be done with the utmost care. Pasteurised or sterilised cooked food should be gently heated using 450 watts, and tasted to make sure it is not too hot for a baby's palate before serving. When reheating other food or drink, heat to a high temperature and allow to cool to a suitable heat for eating. For formula milk follow the manufacturer's instructions.

Always use a lid or cover for reheating food, except when a drier finish is needed, e.g. breaded poultry/meat.

Always remove the lids from jars, e.g. jars of baby food. Remove the rubber teat and screw cap before warming baby bottles. When reheating liquids, place the boiling rod supplied with the appliance into the cup or glass. Never reheat hard boiled eggs using microwave power, even without the shell. The eggs can explode.

The time required depends largely on the nature of the food, its initial temperature and the amount to be cooked. Food taken straight from the refrigerator takes longer to reheat than food stored at room temperature.

Always ensure that food is sufficiently reheated.

If in any doubt that a sufficiently high temperature has been reached, continue reheating for a little longer.

Stir or turn food from time to time during reheating. Stir the food from the outside towards the middle, as food heats more quickly from the outside.

## After reheating

Be careful when removing a dish from the oven. It may be hot.

Although heat is not normally produced in the container itself by the microwaves (apart from stoneware), heat transfer from the food to the container may be considerable, making the container itself hot.

Allow food to stand for a few minutes at room temperature once a programme has ended to allow the heat to be distributed evenly.

After reheating food, especially food for babies and small children, stir the food or shake the container and check that the temperature does not pose any danger. Double check after it has been left to stand.

# Reheating

## Chart for reheating food

Drinks **	Quantity	Microwave power settings		Standing time at room temperature * in min.
		1000 W Time in min.	450 W Time in min.	
Coffee, drinking temperature 60 – 65 °C	1 cup, 200 ml	0:50 – 1:10	–	–
Milk, drinking temperature 60 – 65 °C	1 cup, 200 ml	1– 1:50***	–	–
Water bring to the boil	1 cup, 125 ml	1 – 1:50	–	–
Baby bottles (milk)	approx. 200 ml	–	0:50 – 1***	1
Glühwein, punch drinking temperature 60 – 65 °C	1 glass, 200 ml	0:50 – 1:10	–	–
Food ***	Quantity	Microwave power settings		Standing time at room temperature * in min.
		600 W Time in min.	450 W Time in min.	
Baby food at room temperature	1 jar, 200 g	–	0:30 – 1	1
Soup	250 ml	4 – 5	–	1
	500 ml	7 – 8	–	2
Casseroles	250 g	4 – 5	–	2
	500 g	7 – 8	–	3
	1,000 g	10 – 12	–	3
Plated meal	1 portion, 400 g	5 – 7	–	2
	2 portions, 800 g	10 – 12	–	3
Vegetables	250 g	3 – 4	–	2
	500 g	5 – 6	–	3
Roast	200 g	3 – 5	–	2
	500 g	7 – 9	–	3
Frankfurters in 250 ml water	100 g	3 – 4	–	1
Cutlets, grilled	200 g	3 – 5	–	2
Fillet of fish, grilled	200 g	3 – 4	–	2
Potato cakes	250 g	3 – 5	–	1
Gravy	250 ml	4 – 5	–	1
Sauces	250 ml	–	3***	1

\* During this time the temperature spreads evenly through the food.

\*\* Put the boiling rod in the container.

\*\*\* Times are based on an initial temperature of approx 5 °C.

For food not normally stored in a fridge assume an initial temperature of 20 °C.

All food except delicate sauces should be reheated to 70 – 75 °C. Temperature should be tested for palatability before serving to babies, young children, the elderly or infirm. See note on food and drink for babies.

**The information given in this chart is intended only as a guide.**

Microwave, traditional and combination programmes are all suitable for cooking.

## **Microwave**

This method is suitable for cooking casseroles as well as dishes with pasta, rice and semolina etc. which need water to help them swell up.

First select 850 W to bring the food up to a boil and then turn the power level down to 450 W to continue cooking or to 150 W for simmering.

## **Fan plus**

This method is recommended for cooking and steaming food such as potatoes and vegetables.

## **Microwave + Fan plus**

This method is useful when you want to shorten cooking times and have a browned finish to the dish.

## **Microwave + Grill**

This method is good for cooking food which needs a well cooked top or browned finished to it, such as macaroni cheese or pasta tuna bake.

## **Microwave**

Place the food in a microwave-safe dish and cover it.

Place the dish on the glass tray and slide into the lowest shelf level.

Add a little water to vegetables which have been kept stored. Vegetable cooking times depend on the texture of the vegetable. Fresh vegetables contain more water than vegetables which have been stored and usually cook more quickly.

Food taken straight from the refrigerator requires longer to reheat than food stored at room temperature.

Stir and turn food at least once during cooking.

Food with a thick skin or peel, such as tomatoes, sausages, jacket potatoes and aubergines, should be pierced or cut in several places to allow steam to escape and prevent the food from bursting.

Similarly, hard-boiled eggs should not be cooked using microwave power as this may lead to the eggs exploding, even after they have been taken out of the oven. Eggs can, however, be cooked using microwave heat if you have purchased special containers designed for this purpose.

Eggs can be cooked without their shells using microwave power only if the yolk membrane has been punctured several times first. The pressure could otherwise cause the egg yolk to explode.

# Cooking

---

## Fan plus +

- Slide the glass tray with the combi rack into the first shelf level from the bottom.

The following containers are suitable:

Ovenproof glass, china and earthenware pots with heat-resistant handles and knobs.

Cover dishes which are to be cooked in their own juice and/or steam, e.g. potatoes or vegetables. This also prevents the food from drying out.



Where a crisp finish is required e.g. for meat, cook without a lid.

## Combination programmes

- Place the dish on the glass tray and slide into the lowest shelf level.

Only use heat-resistant, microwave-safe crockery. No metal.

Generally you can cook without a lid when using the combination programmes.

Never use a lid when using Microwave + Grill  ! The food will not brown!

Ensure that foods such as meat and fish are thoroughly cooked for an appropriate length of time.

## Cooking chart

	Microwave power settings				Standing time at room temperature *in min.
	Quantity	850 W Time in min.	+ Time in min.	450 W Time in min.	
<b>Meat</b>					
Meatballs in gravy (400 g meat)		10 – 12			2 – 3
Stew (750 g meat)		16	+	15	2 – 3
<b>Poultry</b>					
Chicken in mustard sauce	approx. 800 g	4	+	12	2 – 3
Chicken curry	approx. 900 g	5	+	12	2 – 3
Chicken risotto	approx. 1.6 kg	10	+	15	3 – 5
<b>Fish</b>					
Fillet in sauce	approx. 900 g	8 – 10			2 – 3
Fish curry	approx. 1.5 kg	5	+	12	3 – 5
<b>Fresh vegetables</b>					
Carrots	300 g	2	+	6	2
Cauliflower florets	500 g	6	+	10	2
Peas	450 g	5	+	10	2
Peppers (sliced)	500 g	5	+	10	2
Vegetable / batons	500 g	3	+	8	2
Brussels sprouts	300 g	3	+	9	2
Asparagus	500 g	5	+	8	2
Broccoli florets	300 g	4	+	4	2
Leeks	500 g	5	+	8	2
Green beans	500 g	4	+	12	2
<b>Frozen vegetables</b>					
Peas, mixed veg.	450 g	5	+	11	2
Spinach	450 g	5	+	7	2
Brussels sprouts	300 g	4	+	6	2
Broccoli	300 g	3	+	6	2
Leeks	450 g	4	+	8	2
<b>Desserts</b>					
Cheese cake (500 g cream cheese)		10 – 12		–	–
Fruit compote (500 ml fruit juice or 500 g fruit)		6 – 8		–	–

\* During this time the temperature spreads evenly through the food.

**The information given in this chart is intended only as a guide.**

# Cooking

## Chart for cooking, browning and crisping food

	Quantity	Oven function	Time in min.
<b>Meat <sup>1)</sup></b>			
Roast ham	1,000 g	300 W + Fan plus 160 °C	approx. 65
Honey roast ham	1,000 g	Fan plus 180 °C	approx. 70
Veal roast	1,000 g	Fan plus 180 °C	approx. 120
Meat loaf	approx. 1,200 g	300 W + Fan plus 180 °C	approx. 40
<b>Poultry <sup>1)</sup></b>			
Chicken, whole	1,000 g	300 W + Fan plus 180 °C	35 – 45
Turkey thighs, 3 pieces	approx. 1,500 g	Fan plus 170 °C	approx. 120
Turkey breast	approx. 1,000 g	Fan plus 170 °C	approx. 100
<b>Snacks <sup>2)</sup></b>			
Toast with topping	4 pieces	Grill	5 – 9 <sup>3)</sup>
Baked artichoke hearts	8 – 10 pieces	Grill	8 – 10 <sup>3)</sup>
Chicken nuggets, fresh <sup>1)</sup>	approx. 1,000 g	Fan plus 190 °C	approx. 20 <sup>4)</sup>

1) lowest shelf level

2) second shelf level, rack in the highest position

3) Pre-heat the grill for 5 minutes, place food on the rack

4) Pre-heat the oven.

Slide the glass tray with the rack into the second shelf level.

**Allow a standing time at room temperature of:**

2 minutes for cooking times under 10 minutes, or approx. 5 minutes for cooking times over 10 minutes.



**The information given in this chart is intended only as a guide.**



# Defrosting and Reheating / Cooking

---

For simultaneous defrosting and reheating or cooking the following functions are suitable:

- Microwave 
- Microwave + Grill  

**Microwave** is suitable for defrosting and then reheating or cooking deep frozen ready made meals which you do not wish to brown.

**Microwave + Grill** is suitable for ready made meals which also need to be browned.



## Microwave

Deep frozen ready made meals can be defrosted and then reheated or cooked. Please follow instructions given on the packet.

Remove the food from its packaging and place in a covered microwave-safe dish for defrosting and reheating or cooking. Soups, stew and vegetables should be stirred several times during the process. Carefully separate and turn slices of meat halfway through the programme. Turn pieces of fish at the halfway stage.

Deep-frozen ready made meals in card trays which, according to manufacturer's instructions, are suitable for use in a normal oven, are normally also microwave-safe.

## Combination programme

Microwave + Grill   is suitable for cooking and then browning the top of ready made meals. Select a microwave power level of 450 watts. The grill temperature is automatically set and cannot be changed.

Put the ready made meal in a heat resistant, microwave-proof dish, and place on the glass tray. Slide the glass tray into the second shelf level. Do not cover.

Ready made meals in aluminium dishes must be placed directly on to the glass tray.

If this does not brown the food as much as you would like, next time put the dish on the rack, and slide this together with the glass tray into the first level from the bottom.

# Grilling

---

The following grill settings are suitable for browning food:

- Grill ☐
- Microwave + Grill ☐ ☐,

Grill ☐ is suitable for flat items which require a crisp finish or browning.

With Microwave + Grill ☐ ☐, the microwave power output is limited to 450 W.

## Preparing food for grilling

Meat should be rinsed under fresh running water and then patted dry. Do not season with salt before grilling, as the salt will draw the meat juices out. Lean meat can be brushed with a little oil if necessary. Do not use other types of fat as they can get too dark, burn and cause smoke. A little butter can be added to chicken if desired. Clean flat fish and slices of fish in the normal way. To enhance the taste add a little salt or squeeze a little lemon juice over the fish.

## Grilling

The grill temperature cannot be altered, the grill is either on or off.

Pre-heat the grill for approx. 5 minutes with the oven door shut before grilling. Do not engage microwave power during the pre-heating phase.

**Brush the rack with oil** and place the prepared food on the rack.

It is best to grill food of a similar thickness at the same time so that the grilling time for each item does not vary too greatly.

Place the rack on the glass tray and slide into the second or third shelf level from the bottom, depending on the type of food you are grilling.

The rack can be used either way up to achieve the best distance from the grill element.

Most items should be turned half way through cooking.

## Test to see if cooked

One way of finding out how far through a piece of meat has been cooked is to press down on it with a spoon:

- If there is very little resistance to the pressure of the spoon, it is still red on the inside ("rare").
- If there is some resistance the inside will be pink ("medium").
- If there is great resistance, it is thoroughly cooked through ("well done").

## Chart for grilling

Pre-heat the grill for approx. 5 minutes.

Flat items <sup>1)</sup>	Total grilling time in min. <sup>2)</sup>
Steak	25 – 30
Burgers	30 – 35
Sausages	20 – 25
Fish fillet	16 – 20
Toast	2 – 4
Toast with topping	5 – 9
Tomatoes	8 – 10
Peaches	7 – 10

1) Third shelf level

2) Turn half way through the grilling time.

**The information given in this chart is intended only as a guide. See the cookbook supplied with your oven and/or a good microwave or microwave combi-oven cookbook for further details on these and other foods.**

# Baking

The following settings are suitable for baking:

- Fan plus 
- Microwave + Fan plus  .

**Fan plus** is suitable for baking small cakes, swiss roll and pastries.

**Microwave + Fan plus** is suitable for doughs which require longer baking, such as rubbed in and beaten mixtures, yeast recipes and cheesecake.

## Fan plus

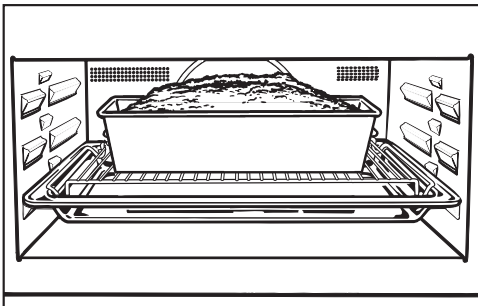

Cake tins should be placed on the first shelf level from the bottom. Place the rack with the raised section facing upwards in the glass tray. This ensures sufficient air circulation all around the tin.

When baking flat items such as biscuits you should select the second shelf level from the bottom to ensure even browning results.

When baking on two levels at the same time you should select the second and third levels from the bottom.

Most types of heat-resistant tins or dishes are suitable. Thin-walled and bright, non-reflective metal tins can be

used, but results may not be as good as with dark non-reflective tins.

Baking times should not be set too long. This can lead to the cake etc. drying out.

## Microwave + Fan plus

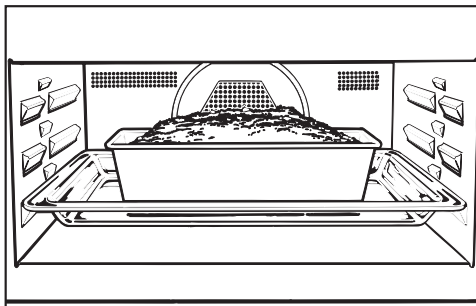

Slide the glass tray into the 1st shelf level from the bottom, and place the baking container on it.

For preference use ovenproof glass or ceramic baking dishes, as microwaves can penetrate these materials into the food being cooked. Metal tins would reflect microwaves so that they would only reach the cakes from the top, resulting in a longer cooking time.

Metal baking tins can also cause sparking. Place the tin on the glass tray, and make sure it does not touch the interior walls.

If sparking continues, do not use this tin again in microwave combination mode.

Do not use paper based containers coated with aluminium foil, such as are sometimes provided with packet cake mixes. There is the danger of these catching fire.

Switch on the microwave setting for the total cooking time. The microwave setting should not be higher than 150 W.

## Tips on baking

Temperature settings, times and microwave power settings in the Baking Chart are suggestions only. Select an average temperature and time for first attempts and adapt accordingly.

Place cakes in **rectangular tins** with the longer side across the width of the oven for optimum heat distribution and even results.

Eating food which has been cooked correctly is important for good health.

Only bake cakes, pizza, chips etc until they are golden brown. Do not allow them to become dark brown.

## To achieve even results without over-browning the food . . .

. . . when baking cakes, pastries, deep frozen foods such as chips, croquettes, frozen pizza, baguettes etc.

- always select the lowest temperature given in the recipe/cooking instructions on the packaging. Do not set a temperature higher than that recommended. Increasing the temperature may reduce the cooking time, but will lead to uneven browning, and unsatisfactory cooking results.
- Check if the food is cooked at the end of the **shortest time quoted**. To check if a cake is ready, insert a wooden skewer into the centre. It is ready if the skewer comes out clean, without dough or crumbs sticking to it.
- Place chips, croquettes and similar types of food on **baking parchment**.

# Baking

## Baking chart

	Fan plus		Microwave + Fan plus		
	Temp. in °C	Time in min.	Microwave setting in W	Temp. in °C	Time in min.
<b>Creamed mixture</b>					
Victoria sandwich	150 - 170	55 - 70	-	-	-
Farmhouse fruit cake <sup>2)</sup>	150 - 170	70 - 80	80	160	60 - 70
Muffins <sup>1)</sup>	150 - 170	25 - 35	-	-	-
Marble cake	150 - 170	60 - 70	-	-	-
Fresh fruit cake with topping (glass tray) <sup>1)</sup>	150 - 170	45 - 50	-	-	-
Fresh fruit cake (glass tray) <sup>1)</sup>	150 - 170	35 - 45	-	-	-
Fresh fruit cake (tin)	150 - 170	55 - 65	-	-	-
Flan base	150 - 170	25 - 30	-	-	-
Biscuits <sup>1)</sup>	150 - 170	20 - 30	-	-	-
<b>Whisked mixture</b>					
Tart	160 - 180	30 - 35	-	-	-
Flan base	160 - 180	25 - 30	-	-	-
Swiss roll <sup>1)</sup>	160 - 180	20 - 25	-	-	-
<b>Rubbed in mixture</b>					
Flan base	150 - 170	25 - 30	-	-	-
Streusel cake (glass tray) <sup>1)</sup>	150 - 170	40 - 50	-	-	-
Biscuits <sup>1)</sup>	150 - 170	20 - 30	-	-	-
Cheese cake	150 - 170	85 - 95	-	-	-
Apple pie	150 - 170	45 - 55	-	-	-
Apricot tart with topping	150 - 170	60 - 70	-	-	-
<b>Yeast mixtures and dough</b>					
Streusel cake (glass tray) <sup>1)</sup>	150 - 170	35 - 45	-	-	-
Fresh fruit cake (glass tray) <sup>1)</sup>	160 - 180	40 - 50	150	170	35 - 40
Stollen	150 - 170	55 - 65	-	-	-
White bread	160 - 180	40 - 50	-	-	-
Dark rye bread	140 - 160	150 - 180	-	-	-
Pizza (glass tray) <sup>1)</sup>	170 - 190	40 - 50	150	180	30 - 40
Onion tart (glass tray) <sup>1)</sup>	150 - 170	35 - 40	-	-	-
Apple turnovers <sup>1)</sup>	150 - 170	25 - 30	-	-	-
<b>Choux pastry, Eclairs <sup>1)</sup></b>					
	160 - 180	30 - 40	-	-	-
<b>Flaky pastry <sup>1)</sup></b>					
	180 - 200	20 - 25	-	-	-
<b>Meringues, Macaroons <sup>1)</sup></b>					
	120 - 140	35 - 45	-	-	-

Unless otherwise stated, the times given are for an oven which has not been pre-heated.

With a pre-heated oven shorten times by up to 10 minutes.

1) second shelf level

2) Place the dish directly on the glass tray.

**The information given in this chart is intended only as a guide. See the cookbook supplied with your oven and/or a good microwave or microwave combi-oven cookbook for further details on these and other foods.**

## Appliance front and control panel

- All surfaces and controls should be cleaned using warm water with a little washing up liquid applied with a soft sponge or cloth.
- Wipe the surfaces dry using a soft cloth.

## E-cloth

A microfibre "E-Cloth" is available from the Miele UK Spare Parts Department, which is suitable for cleaning surfaces such as stainless steel, glass, plastic and chrome without the use of chemicals.

To prevent the risk of scratches and damage to the surface structure of glass, stainless steel and aluminium fronted appliances pay particular attention to the following cleaning instructions.

## Glass fronted appliances

The appliance front and controls are susceptible to scratches and abrasions.

Avoid:

- abrasive cleaning agents, e.g. powder cleaners and cream cleaners,
- abrasive sponges, e.g. pot scourers or sponges which have been previously used with abrasive cleaning agents,
- oven sprays.

Clean the door handle and the control elements regularly, preferably after each use.

This will help prevent grease and other deposits adhering to surfaces and becoming difficult to remove.

## Aluminium fronted appliances

Aluminium is affected by the way that light falls on it, by the surrounding environment and by the angle you observe it from.

Aluminium surfaces and controls may suffer discolouration or damage if soiling is left on them for too long. Remove any soiling straight away.

The appliance front and controls are susceptible to scratches and abrasions.

Avoid:

- cleaning agents containing soda, acids or chlorides,
- abrasive cleaning agents, e.g. powder cleaners and cream cleaners,
- abrasive sponges, e.g. pot scourers or sponges which have been previously used with abrasive cleaning agents,
- stainless steel cleaners,
- cleaning agents containing descaling agents,
- dishwasher detergent,
- oven sprays.

# Cleaning and care

---

## Stainless steel fronted appliances

The appliance front and controls are susceptible to scratches and abrasions.

Please observe the separate cleaning instructions for

- stainless steel surfaces,
- stainless steel coloured controls.

## Stainless steel surfaces

Stainless steel surfaces can be cleaned using a proprietary non-abrasive cleaning agent designed specifically for use on stainless steel.

N.B. Do not use on the controls.

Avoid:

- cleaning agents containing soda, acids or chlorides,
- abrasive cleaning agents, e.g. powder cleaners and cream cleaners,
- abrasive sponges, e.g. pot scourers, or sponges which have been previously used with abrasive cleaning agents.

To help prevent re-soiling, proprietary conditioning agent for stainless steel can also be used.

Apply sparingly with an even pressure following the direction of the grain.

## Stainless steel coloured controls

The controls may suffer discolouration or damage if soiling is left on them for too long. Remove any soiling straight away.



Avoid:

- cleaning agents containing soda, acids or chlorides,
- abrasive cleaning agents, e.g. powder cleaners and cream cleaners,
- abrasive sponges, e.g. pot scourers or sponges which have been previously used with abrasive cleaning agents,
- stainless steel cleaners,
- oven sprays.

## Oven interior

The oven interior is stainless steel. The high temperatures possible when operating in a traditional oven mode can cause the steel to darken slightly.

The oven interior gets hot during use. To avoid the danger of being burnt, wait until it has cooled down before cleaning. It should be cleaned after each use. If left too long cleaning becomes unnecessarily difficult, and in extreme cases impossible.

Turn the function selector to the Light  /  setting.



Clean the oven interior using a solution of hot water and washing up liquid or mild detergent applied with a sponge, soft brush or damp cloth. Wipe dry with a soft cloth.

For more heavy soiling, heat a glass of water for 2 to 3 minutes until the water begins to boil. The steam will collect on the walls and soften the soiling. The oven interior can now be wiped clean using a little washing-up liquid if necessary.

If food has burnt on, use a mild non-abrasive cleaner or a proprietary cleaner for stainless steel, applied with a non-scouring kitchen sponge.

Do not use abrasive cleaning agents as the material is susceptible to scratching.

If using an oven spray, the manufacturer's instructions must be followed. Do not spray into any of the openings.

Do not use too much water on the cloth or sponge and do not let water or any other substance find its way into any openings.

To neutralise odours in the oven, put a cup of water with some lemon juice in the oven and simmer for a few minutes.

Residues of fruit juices as well as cake mixtures are best removed while the oven is warm.

Spilt fruit juices may cause lasting discolouration to the surfaces.

### Oven interior roof

If the oven interior roof is badly soiled, the grill element can be lowered to make cleaning easier.

Wait until the grill element has cooled down before lowering it to avoid the danger of being burnt.

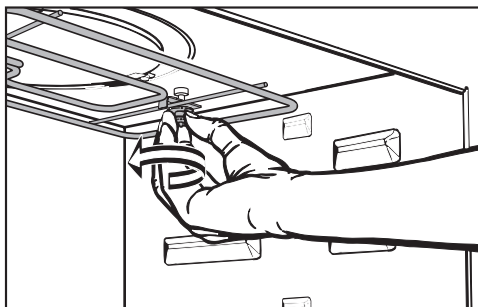

- To lower the grill element loosen and then remove the nut.

## Cleaning and care

---

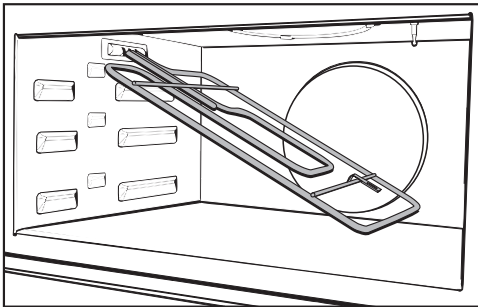

- Lower the grill element gently.

Do not use force to lower the element as this could cause damage.

- After cleaning the grill element, raise it gently back up again. Refit the nut and tighten to secure the grill element back in position.

### Door interior

Always keep the door interior clean. Do not use any scouring agents. Check the door and door seal at regular intervals for any sign of damage.

If any damage is noticed, the oven should not be used again in microwave mode until the fault has been rectified by a service technician.

### Accessories supplied

#### Combi rack

Wash and dry the rack after each use. Remove stubborn soiling with a stainless steel cleaner.

#### Glass tray

The glass tray can be washed in hot water and washing up liquid, or in the dishwasher.

Do not use scouring agents. These would scratch.

#### Boiling rod

The boiling rod can be washed in a dishwasher.

Installation work, maintenance and repairs may only be carried out by suitably qualified and competent persons in accordance with national and local safety regulations to ensure safety.

Repairs and other work by unqualified persons could be dangerous and the manufacturer will not be held liable.

Ensure current is not supplied to the appliance until after maintenance or repair work has been carried out.

Some minor problems can be corrected without contacting the Service Department.

## What to do if . . . .

### . . . the display does not light up

- Check whether,
  - the appliance is correctly plugged in at the mains socket and switched on,
  - the mains fuse has blown (call the Service Department),
  - the time display had been switched off (see "Altering the time of day display and buzzer").

### . . . a programme will not start

- Check whether,
  - the appliance door is properly shut if operating in microwave mode,
  - a power setting and time have been entered if operating in microwave mode.

### . . . the microwave / heating functions but not the interior lighting

The halogen lamp is defective and needs to be replaced:

Disconnect the appliance from the electricity supply, (switch off and unplug at the socket, or remove the fuse, or switch off at the isolator as appropriate).

- Unscrew and remove the lamp cover.
- Pull the halogen lamp out.
- Fit a new halogen lamp.

Specification:

12 V, 10 W,  
heat resistant to 300 °C,  
fitting W271, Osram, Type 64418

- Replace the cover and screw into place.
- Reconnect the appliance to the mains supply.

# Problem solving guide

---

## **... the food is not sufficiently heated or is not cooked at the end of a set time**

- Check whether,
  - after interrupting a cooking process using microwave power that you remembered to restart the programme,
  - if cooking / reheating in microwave mode the correct duration was selected for the setting chosen. The lower the power level the longer the duration.

## **... cakes or biscuits are not cooked after a recommended time**

- Check whether,
  - the correct temperature was set.
  - there were any alterations to the recipe. The addition of more liquid or more eggs makes a moister mix which would take longer to cook.

## **... cakes or biscuits are unevenly browned**

There will always be a slight unevenness.

- If browning is very uneven, check
  - whether the temperature was set too high,
  - the colour and material of the baking tins being used. Bright shiny tins are not very suitable. Try using a different tin next time.

## **... food cools down too quickly after being reheated or cooked in microwave mode.**

When cooked by microwaves, food begins to cook from the outside first, the inside of the food relying on the slower conduction of heat.

If food is cooked at a high power level it is possible that the heat may not have reached the centre of the food. Food may be warm in the middle but cool on the edge. When reheating food with different densities, such as plated meals, it is sensible to start with a low power level and lengthen the time required.

**... strange noises are heard when the microwave or microwave / combination mode is being used.**

- Check whether,
  - sparks are being created by the use of metallic crockery, (see "suitable crockery").
  - the food is covered with aluminium foil. If so, remove it.

If it is not possible to remedy a fault by following the instructions given above, contact the Service Department. On no account open the appliance casing.

This appliance should only be repaired by a suitably qualified technician trained by Miele.

## After sales service

---

In the event of any faults which you cannot easily remedy, please contact

– your Miele Dealer

or

– the Miele Service Department (see back cover for address).

When contacting your Dealer or the Service Department, please quote the model and serial number of your appliance. These are given on the data plate which is located on the front of the oven cavity.

Please note that telephone calls may be monitored and recorded to improve our service.

All electrical work should be carried out in strict accordance with national and local safety regulations by a suitably qualified and competent service technician approved by Miele.

This appliance is supplied with a mains cable and plug for connection to a 230 - 240 V, 50 Hz single phase supply.

The voltage, connected load and fuse rating (where applicable) are given on the data plate situated at the front of the oven interior. Please ensure that these match the household mains supply.

Connection should be made via a fused connection unit or a fused plug and a suitable switched socket, or via a suitable isolator which complies with national and local safety regulations, and the on/off switch should be easily accessible after the appliance has been installed.

If the socket is not accessible after installation (depending on country) an additional means of disconnection must be provided for all poles.

When switched off there must be an all-pole gap of 3 mm in the isolator switch (including switch, fuses and relays acc. to EN 60335).

For extra safety it is advisable to install a residual current device with a trip current of 30 mA (in accordance with DIN VDE 0664, VDE 0100 Section 739).

If the cable is damaged a new cable must be fitted by a Miele approved service engineer.

If the appliance is connected via an isolator switch the plug must be cut off and rendered useless. The appliance

must then be connected to the mains supply by a suitably qualified person only.

## Important U.K.

The wires in the mains lead of this appliance are coloured in accordance with the following code:

**Green/yellow = Earth**  
**Blue = Neutral**  
**Brown = Live**

As the colours of the wires in the mains lead of this appliance may not correspond with the markings identifying the terminals in your plug, proceed as follows:

The wire coloured green and yellow must be connected to the terminal in the plug which is marked with the letter E or by the earth symbol  $\perp$  or coloured green or green and yellow.

The wire coloured blue must be connected to the terminal marked with the letter "N" or coloured black. The wire coloured brown must be connected to the terminal marked with the letter "L" or coloured red (U.K.).

**WARNING**  
**THIS APPLIANCE MUST BE**  
**EARTHED**

## **Non-rewireable plugs BS 1363**

If this appliance is fitted with a non-rewireable plug, the following information applies: if the socket outlets are not suitable for the plug supplied with this product, it must be cut off and an appropriate plug fitted. The fuse carrier and fuse should be removed from the old plug and disposed of. The old plug should then be disposed of and on no account be inserted into any socket elsewhere in the house (electric shock hazard).

The fuse cover must be re-fitted when changing the fuse, and if the fuse cover is lost the plug must not be used until a suitable replacement is obtained. The colour of the correct replacement cover is that of the coloured insert in the base of the plug, or the colour that is embossed in words on the base of the plug, (as applicable to the design of plug fitted).

Replacement fuses should be ASTA approved to BS 1362 and have the correct rating. Replacement fuses and fuse covers may be purchased from your local electrical supplier.



## Building-in options

The appliance is suitable for installation:

- in a tall unit in combination with an oven
- in a tall unit on its own
- in a base unit

## Building-in dimensions

### Installation in a tall unit in combination with an oven

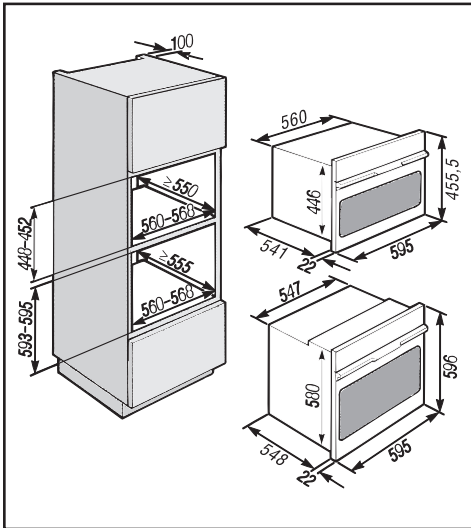

### Installation in a tall unit

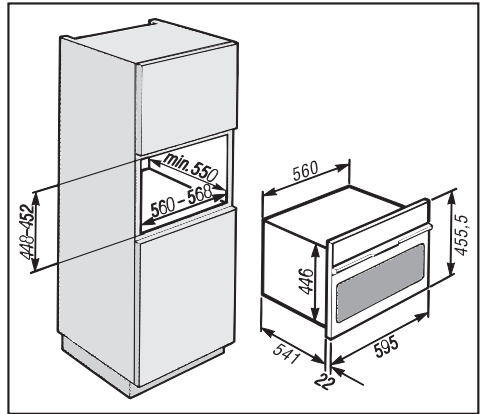

### Installation in a base unit

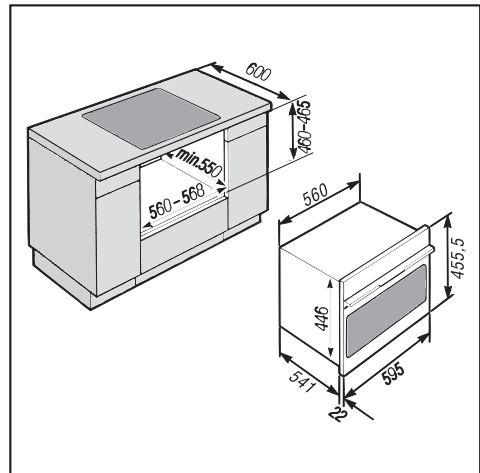

If fitted underneath a hob, the installation instructions for the hob must also be taken into account.

# Installation

---

## Installation

- Connect the appliance to the electricity supply.
- Place the oven into the oven housing unit as far as the oven trim and align.

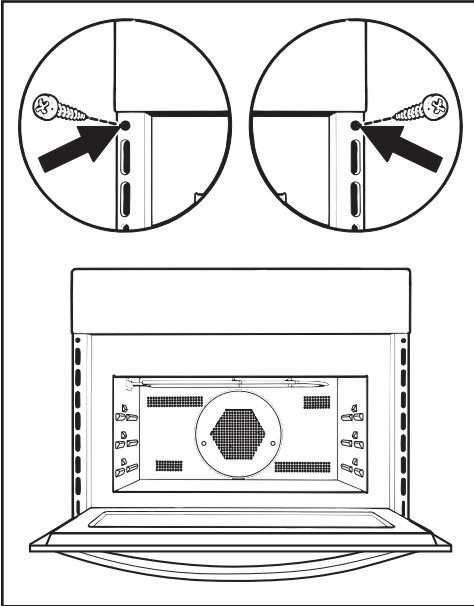

- Open the oven door, and with two screws secure the oven to the side walls of the furniture unit through the holes in the oven trim.

The oven must not be operated until it has been correctly installed in its housing unit.



**United Kingdom:**

Miele Co. Ltd.  
Fairacres, Marcham Road  
Abingdon, Oxon, OX14 1TW  
tel. Abingdon (01235) 554455  
Service Office: (01235) 554466  
fax (01235) 554477  
Internet: [www.miele.co.uk](http://www.miele.co.uk)

**Ireland:**

Miele Ireland Ltd.  
Broomhill Road, Tallaght, Dublin 24  
Tel: (01) 46 10 710, Fax: (01) 46 10 797  
Email: [info@miele.ie](mailto:info@miele.ie)  
Internet: <http://www.miele.ie>

**Australia:**

Miele Australia Pty. Ltd.  
A.C.N. 005635398  
1 Gilbert Park Drive  
Knoxfield, VIC 3180  
Telephone: (03) 9764 7100  
Fax: (03) 9764 7129  
Internet: [www.miele.com.au](http://www.miele.com.au)

**Distributor New Zealand:**

Steelfort Engineering Company. Ltd.  
500 Rangitikei Street  
Palmerston North, Priv. Bag 11045, NZ  
Telephone: (06) 350 1350  
Fax: (06) 356 1507

**South Africa:**

Miele (Pty) Ltd  
304 Tungsten Road  
Strijdom Park 2194  
P.O.Box 1654, Randburg 2125  
Tel. (011) 793-7452  
Telefax (011) 793-7447  
E-mail: [info@miele.co.za](mailto:info@miele.co.za)  
Internet: [www.miele.co.za](http://www.miele.co.za)

**Singapore:**

Miele Southeast Asia  
Miele Pte. Ltd.  
163 Penang Road  
# 04 - 02/03 Winsland House II  
Singapore 238463  
Tel : +65-67351191  
Fax: +65-67351161  
Email: [mielesea@miele.com.sg](mailto:mielesea@miele.com.sg)

**Hong Kong:**

Miele (Hong Kong) Limited  
AIA Plaza, Room 401, 4<sup>th</sup> Floor  
18 Hysan Avenue  
Causeway Bay  
Hong Kong  
Tel.: (852) 2610 1331  
Fax: (852) 2610 1013  
E-mail: [mielehk@netnavigator.com](mailto:mielehk@netnavigator.com)

## Free Manuals Download Website

<http://myh66.com>

<http://usermanuals.us>

<http://www.somanuals.com>

<http://www.4manuals.cc>

<http://www.manual-lib.com>

<http://www.404manual.com>

<http://www.luxmanual.com>

<http://aubethermostatmanual.com>

Golf course search by state

<http://golfingnear.com>

Email search by domain

<http://emailbydomain.com>

Auto manuals search

<http://auto.somanuals.com>

TV manuals search

<http://tv.somanuals.com>