

Miele

Operating instructions



Ovens

H 334 B, H 334 B KAT
H 344-2 B

To avoid the risk of accidents or damage to the appliance it is essential to read these operating instructions before it is installed or used for the first time.



M.-Nr. 05 844 950

Contents

Description of the appliance	4
H 334 B, H 344-2 B	4
H 334 B KAT	5
Features	6
Energy efficiency rating according to EN 50304	7
Accessories	7
Baking tray, grill pan and rack	7
Roasting filter	8
Caring for the environment	9
Warning and Safety instructions	10
Operation	15
Setting the clock	15
Changing the time of day	16
To show the time display all the time	17
To switch off the time of day display	17
Switching on the catalyser	18
Cleaning and heating up for the first time	18
Controls	20
Programme selector	20
Display	20
Night dimming	20
Rotary dials	21
Display – functions and symbols	22
Programming sequence	23
Description of the oven systems	24
Using the oven	25
Selecting an oven setting	25
Selecting a temperature	26
Altering the temperature	26
Using the oven	27
Rapid heat-up	28
To switch off "rapid heat-up"	28
Pre-heating the oven	29
Programming cooking times	30
Symbols in the display	31
Switching the cooking process off automatically	33
Switching on and off automatically	34

To check and change an entered time	35
To delete a time entered	35
Using the residual heat, Energy-save function	35
Setting the minute minder	36
System lock	37
Safety lock	38
Baking	40
Baking chart	42
Roasting	44
Oven roasting chart	46
Grilling	47
Grill chart	49
Defrosting	50
Cleaning and care	51
Appliance front and control panel	51
Accessories	52
Racks and side supports	52
Roasting filter	52
PerfectClean	53
Catalytic enamel surfaces	55
Cooking compartment	57
To remove the oven door	57
To dismantle the oven door	58
To refit the door	62
To remove the runners	63
To lower the upper heating element	63
To remove the catalytic enamelled back panel, side liners (if fitted) and roof liner	64
Problem solving	66
After sales service	69
Extra accessories	70
Electrical connection UK, ZA	72
Electrical connection AUS, NZ	74
Installing the oven	75

Description of the appliance

H 334 B, H 344-2 B

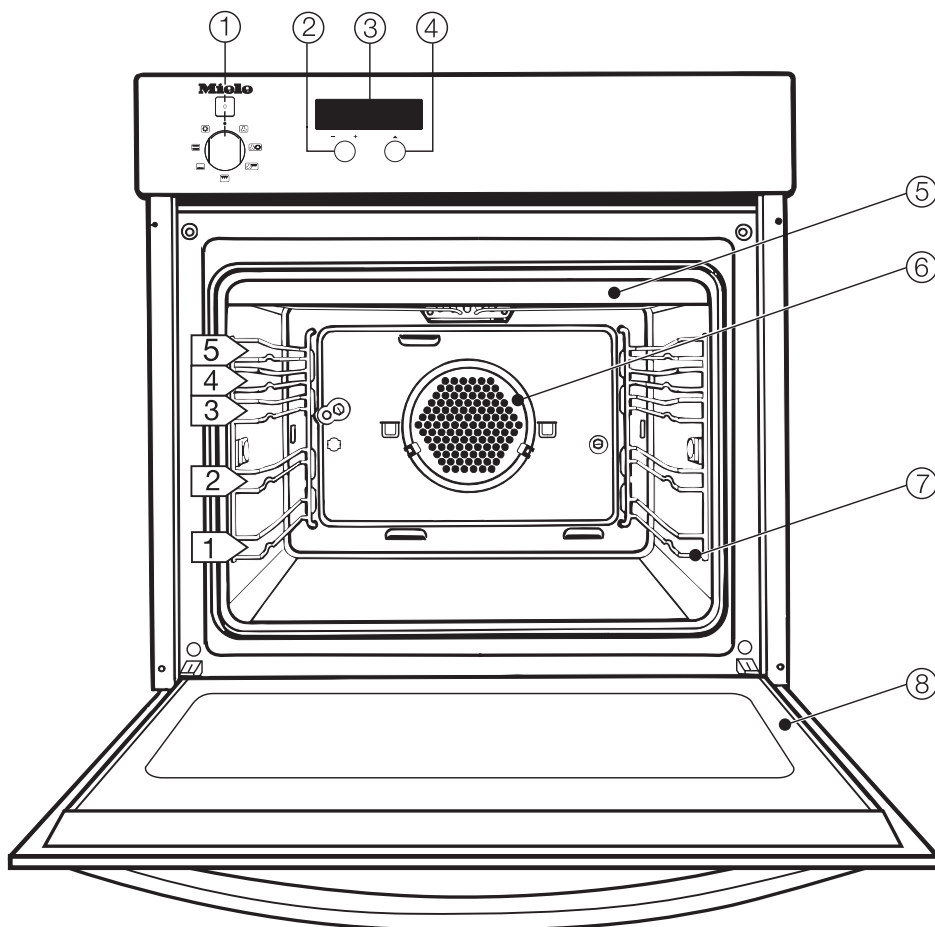

Control panel *

- ① Programme selector
- ② Input dial for entering settings
- ③ Display
- ④ Function dial for selecting oven functions

Oven interior

- ⑤ Heating element for top heat and grilling with roof liner
- ⑥ Air inlet for fan
- ⑦ Runner heights 1, 2, 3, 4, 5
- ⑧ Oven door

* depending on model

Description of the appliance

H 334 B KAT

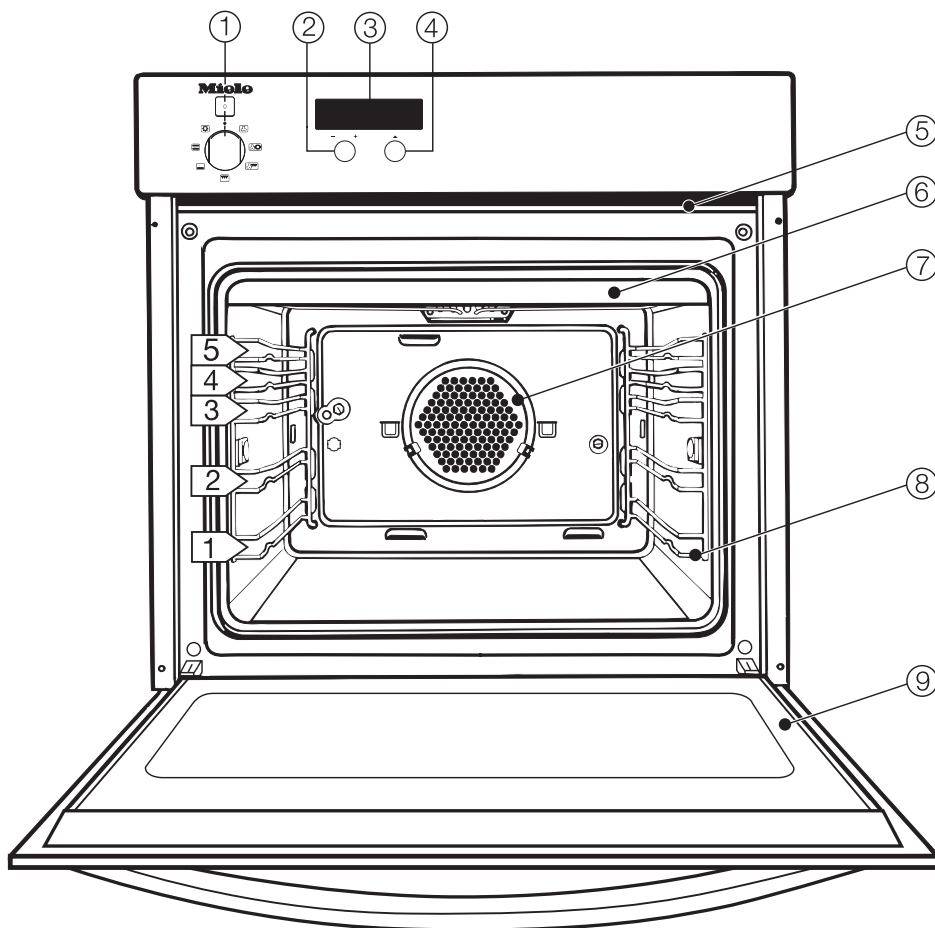

Control panel *

- ① Programme selector
- ② Input dial for entering settings
- ③ Display
- ④ Function dial for selecting oven functions

Oven interior

- ⑤ Lever for switching the catalyser on
- ⑥ Heating element for top heat and grilling with roof liner
- ⑦ Air inlet for fan
- ⑧ Runner heights 1, 2, 3, 4, 5
- ⑨ Oven door

* depending on model

Description of the appliance

Features

Electronic controls

In addition to operating the various cooking programmes to bake, roast and grill, the electronic controls also offer the following features:

- Clock display
- Minute minder
- Timer to automatically switch cooking programmes on and off with automatic use made of residual heat
- Programme lock, to prevent unintentional altering of programme settings
- System lock, to prevent the appliance being used unintentionally
- Safety cut-out

Cooling system

As soon as the oven is switched on a cooling fan is automatically engaged. The cooling fan mixes hot air from the oven cavity with cool room air before venting it out into the kitchen through vents located between the appliance door and the control panel.

The controls and door handle will get slightly warm. They are quite safe to touch.

The cooling fan will continue to run for a while after the oven has been switched off to prevent any humidity building up in the oven, on the control panel or in the oven housing unit. When the temperature in the oven has fallen sufficiently the cooling fan will switch off automatically.

Door contact switch

There is a door contact switch in the right hand door hinge.

If the door is opened during operation, the door contact switch causes the oven heating, and the fan if a "Fan" setting is being used, to be switched off.

This helps reduce the amount of heat lost from the oven cavity, e.g. when basting a roast.

PerfectClean treated surfaces

The following surfaces are all treated with PerfectClean enamelling.

- Oven interior
- Runners
- Baking tray
- Grill pan
- Anti-splash tray
- Rack

PerfectClean enamelled surfaces have very good anti-stick properties and are much easier to keep clean than conventional enamel, if cleaned regularly.

See "Cleaning and care" for more information.

Description of the appliance

Catalytic enamelled surfaces

The back panel, roof liner and side liners (if fitted) are coated with dark grey catalytic enamel. Soiling from oil and fat is burnt off these surfaces when very high temperatures are used in the oven.

This makes it easier to clean inaccessible areas of the oven. See "Cleaning and care" for more information.

Catalyser

Depending on model a catalyser is fitted into the oven's ventilation system.

It filters fat from the escaping vapours and thus reduces cooking smells.

Energy efficiency rating according to EN 50304

H 334 B, H 344-2 B

These appliances are rated energy efficiency class **B** in accordance with EN 50304. Tests were carried out using the "Fan" oven function.

H 334 B KAT

These appliances are rated energy efficiency class **B** in accordance with EN 50304. Tests were carried out using the "Fan" oven function with the catalyser switched off.

Accessories

The following accessories are supplied with this oven.

These and other accessories are also available to order from the Miele Spare Parts Dept. or your Miele Dealer. See "Extra Accessories" further on in this booklet for more details.

Baking tray, grill pan and rack

The baking tray, grill pan and rack are fitted with non-tip safety notches which prevent them being pulled right out when they only need to be partially pulled out.

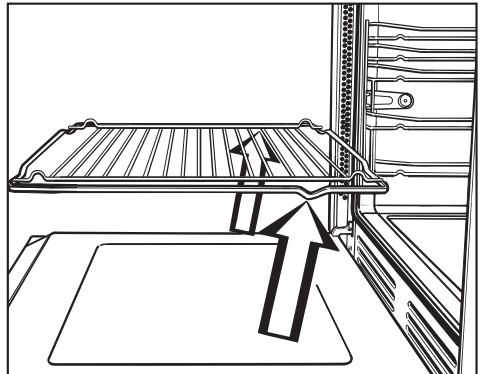

When pushing the tray, pan and rack back in, always ensure that the safety notches are at the rear of the oven (see illustration).

The tray, pan and rack can then only be taken out of the oven by raising them upwards and then pulling out.

Description of the appliance

Roasting filter

The roasting filter must be fitted in front of the fan when cooking anything fatty or where food is likely to splatter, e.g. when open roasting or grilling meat.

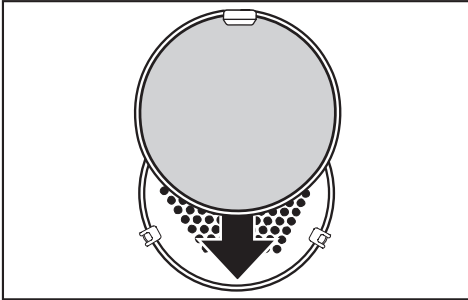

The droplets of fat caught up in the circulating air are deposited on the roasting filter. This helps to keep the oven and the area behind the interior back panel cleaner.

Do not use the roasting filter when baking. This would increase the times needed for baking and give uneven browning results.

See "Extra accessories" for a description and illustration of the **handle** and **anti-splash tray**.

Disposal of the packing material

The transport and protective packing has been selected from materials which are environmentally friendly for disposal and can normally be recycled.

Ensure that any plastic wrappings, bags etc. are disposed safely and kept out of the reach of babies and young children. Danger of suffocation!

Rather than just throwing these materials away, please ensure they are offered for recycling.

Disposal of your old appliance

Old appliances contain materials which can be reclaimed or recycled. Please contact your dealer, your local waste collection centre or scrap merchant about potential recycling schemes.

Ensure that the appliance presents no danger to children while being stored for disposal.

See the appropriate section in the Warning and safety instructions.

Warning and Safety instructions

This appliance conforms to current safety requirements. Incorrect use can, however, lead to personal injury and damage to the appliance.

Before installation and before using for the first time, read the operating instructions carefully.

They contain important notes on installation, safety, operation and care of the appliance. This way you will avoid the risk of accidents and damage to the appliance.

Keep these instructions in a safe place and pass them on to any future user.

Correct usage

The appliance is intended for domestic use to cook food, and in particular to bake, roast, defrost, cook, dry fruit etc, and to grill.

Any other usage is at the owner's risk and could be dangerous. The manufacturer cannot be held liable for damage caused by incorrect or improper use of the appliance.

Do not let children access the appliance or its controls. Supervise its use by the elderly or infirm. If allowing older children to use the appliance without supervision please ensure that they are aware of how the oven works and understand the dangers of improper use.

Technical safety

Before connecting the appliance to the mains supply make sure that the voltage and frequency correspond to the rating on the data plate, otherwise the appliance could be damaged.

Consult a competent person if in doubt.

The electrical safety of this appliance can only be guaranteed when continuity is complete between the appliance and an effective earthing system, which complies with local and national safety regulations. It is most important that this basic safety requirement is tested regularly, and if there is any doubt the household wiring system should be inspected by a qualified electrician.

The manufacturer cannot be held responsible for the consequences of an inadequate earthing system (e.g. electric shock).

The appliance must be built in before operation to ensure that no electrical components are accessible.

Never open the housing of the appliance.

Tampering with electrical connections or components and mechanical parts is highly dangerous to the user and can cause operational faults.

Warning and Safety instructions

Installation work and repairs may only be carried out by suitably qualified and competent persons in accordance with local and national safety regulations.

Repairs and other work by unqualified persons could be dangerous and the manufacturer will not be held liable.

The appliance is only completely isolated from the electricity supply when:

- the mains fuse is withdrawn
- or the screw-out fuse is removed (in countries where this is applicable)
- it is switched off at the wall socket. On appliances fitted with a plug make sure you pull only on the plug and not on the cable when disconnecting from the mains.

Ensure that current is not supplied to the appliance while maintenance or repair work is being carried out.

Do not connect the appliance to the mains electricity supply by an extension lead.

Extension leads do not guarantee the required safety of the appliance, (e.g. danger of overheating).

This equipment is not designed for maritime use or for use in mobile installations such as caravans, aircraft etc. However it may be suitable for such usage subject to a risk assessment of the installation being carried out by a suitably qualified engineer.

Use

Caution, danger of burning. High temperatures are produced by the oven.

Great care should be taken to ensure that small children do not touch the appliance when it is being used. Children's skin is far more sensitive to high temperatures than that of adults.

External parts of the oven such as the door glass, handle vent and control panel can become quite hot.

Children should not be left alone or unattended in an area where an oven is in use. They should never be allowed to sit or stand on any part of the oven or play with it.

Do not store items of interest to children in cabinets above an oven. Children climbing on to the oven to reach these items could be seriously injured.

Use of heat-resistant oven gloves is recommended when placing food in the oven, turning or removing it.

When working with "Conventional" heating or when grilling, the element in the roof of the oven gets very hot, and there is a danger of being burnt.

When cleaning the roof of the oven wait until the grill element has cooled down before lowering it. Danger of burning.

Do not use force to pull it down as this can cause the element to break.

Warning and Safety instructions

■ Do not use plastic containers. These melt at high temperatures and could damage the appliance.

■ Do not heat up unopened tins or jars of food in the oven. Pressure can build up and they may explode. This could result in injury or damage.

■ Do not push pots and pans around on the oven floor as this could damage the surface.

■ Do not lean or sit on an open oven door, or place heavy items on it. This could damage the appliance. The oven door can support a maximum load of 15 kg.

■ Make sure that nothing gets trapped between the door and the oven.

■ Cover any food which is left in the oven to be kept hot. Any moisture in the food could lead to corrosion damage in the oven. This also prevents the food from drying out.

■ If food is left in the oven after cooking, e.g. to take advantage of the residual heat, turn the temperature selector to the lowest setting. Leave the function selector at the position set. Do not switch the appliance off until the food has been removed.

Moisture in the oven could lead to condensation forming on the control panel and surrounding kitchen furniture and drops of moisture collecting under the worktop.

Condensation can:

- damage the housing unit / worktop.
- lead to moisture damage in the oven.



On models fitted with a catalyser it could also result in deposits remaining in the catalyser, causing an unpleasant smell to arise the next time the appliance is switched on.

■ Bake larger deep-frozen items such as pizzas on baking paper on the rack itself or in the pizza pan (see "Extra accessories"). Placing them on the baking tray or in the grill pan can cause the metal to distort. This distortion would increase with subsequent use.

Deep frozen foods such as oven chips or potato croquettes can be cooked on the baking tray or grill pan.

Warning and Safety instructions

■ Never add water to food on a hot baking tray or grill pan or directly onto food in a hot oven. The steam created could cause serious burns or scalding and the sudden change in temperature can damage the enamel.

■ Never line the floor of the oven with aluminium foil when using Conventional heat /Bottom heat . Do not place a dish, tin, baking tray or grill pan on the floor of the oven.

If using a grill pan made by a different manufacturer make sure that there is a gap of at least 6 cm between the bottom of the pan and the floor of the oven.

If these instructions are not observed the bottom heat will be blocked. This can cause permanent damage to the floor of the oven.

■ Protective aluminium foil panels are available in retail outlets which are supposed to protect the oven cavity from soiling and reduce the need for cleaning. If used cooking and baking times will increase considerably. They can also cause damage to the appliance (e.g. by blocking the heat).

General notes

■ Never leave the appliance unattended when cooking with oil or fats as these are a fire hazard if overheated.

■ Do not use the oven to heat up the room. Due to the high temperatures radiated, objects left near the oven could catch fire.

■ Always ensure that food is sufficiently cooked or reheated. Many factors will affect the overall cooking time, including the size and amount of food, its temperature, changes to the recipe and the shape and size of cooking container. Some foods may contain micro organisms which are only destroyed by thorough cooking at temperatures over 70°C C for a minimum of 10 minutes. When cooking or reheating foods e.g. poultry it is particularly important that food is fully cooked through. If in doubt select a longer cooking or reheating time.

It is important that the heat is allowed to spread evenly throughout the food being cooked. This can be achieved by stirring and/or turning the food, and by observing a sufficiently long standing time which should be added to the time needed for cooking, reheating or defrosting.

Warning and Safety instructions

■ When using kitchen appliances connected to sockets near the oven, ensure that the cable cannot get trapped in a hot oven door, which could melt the cable insulation and be dangerous. Danger of electric shock.

■ Never use steam cleaning apparatus to clean the appliance. The steam could attack the electrical components and cause a short circuit.

■ If using alcohol in your recipes high temperatures can cause the alcohol to vaporise and under adverse circumstances the alcohol can catch light on the hot heating elements. Alcohol should be burnt off before the dish is placed in the oven to avoid this danger.

■ In countries where there are areas which may be subject to infestation by cockroaches or other vermin, pay particular attention to keeping the appliance and its surroundings in a clean condition at all times. Any damage which may be caused by cockroaches or other vermin will not be covered by the appliance guarantee.

Disposal of your old appliance

■ Before throwing an old appliance away it must first be made unusable. Switch off and disconnect it from the power supply, cut off the cable directly behind the appliance and render any plug useless. This should be done by a competent person.

The manufacturer cannot be held liable for damage caused by non-compliance with these Warning and Safety instructions.

After installation and before using the oven for the first time:

- Set the clock.
- Switch the catalyser on, if fitted.
- Clean the appliance.
- Heat the oven up with nothing in it.

New appliances have a slight smell on first use and this procedure will dissipate the smells before you use the oven to cook any food.

To save energy the display will go dark a few seconds after setting the time.

The time continues to run unseen in the background.

The time can also be set to show constantly in the display. See "To show the time display all the time".

Setting the clock

The time can only be entered when the programme selector is at "0".

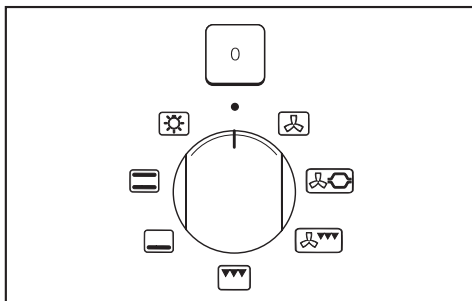

The following will appear in the display:

- The ⊕ symbol (time of day),
- "12:00" and the triangle ▲ flashing underneath the ⊕ symbol.

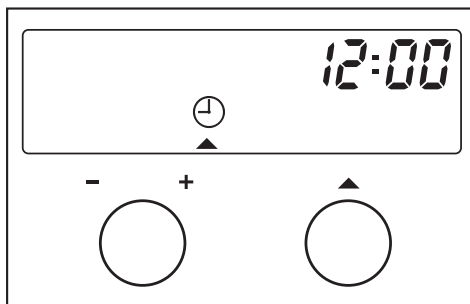

- Use the (-/+) input dial to set the time.

The clock has a 24 hour display. When the time has been entered, the display goes dark and the clock advances minute by minute in the background.

The time will appear again in the display as soon as you move the function selector.

Operation

Changing the time of day

In the following example the time of day is changed from 12:05 to 13:33.

To do this:

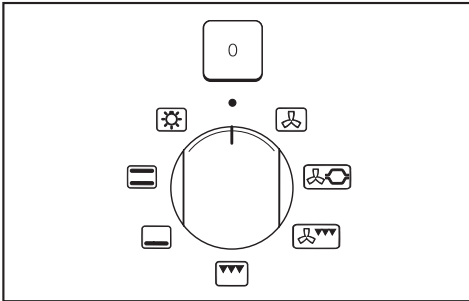

- Turn the programme selector to "0".

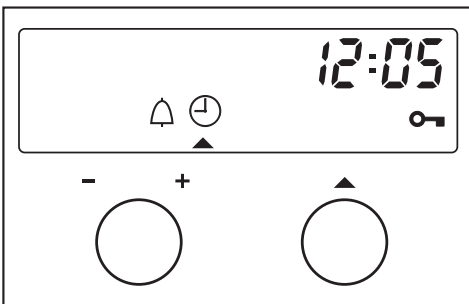

- Turn the function selector (right hand dial) until triangle ▲ is underneath the ⌚ symbol in the display.

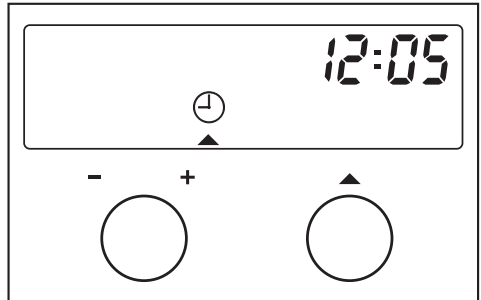

- Whilst triangle ▲ is flashing, turn the (-/+) input dial clockwise until the required time shows in the display.



The ⌚ symbol will go out after a couple of seconds and the time set stored in memory.

If the display is set to show the time, the time of day will then show in the display.

To show the time display all the time

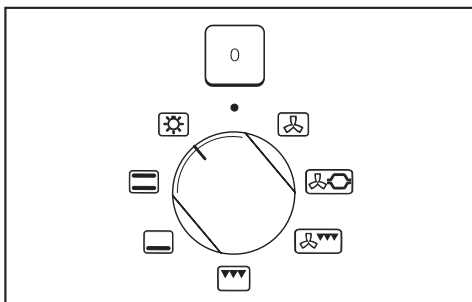

- Turn the programme selector to the Light ☀ position.

The time of day will show in the display.

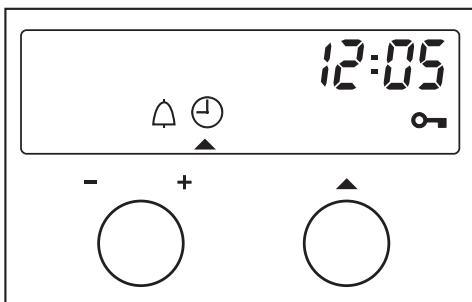

- Turn the function selector (right hand dial) until triangle ▲ is underneath the ⌚ symbol in the display.



Four horizontal bars will then appear in the display.

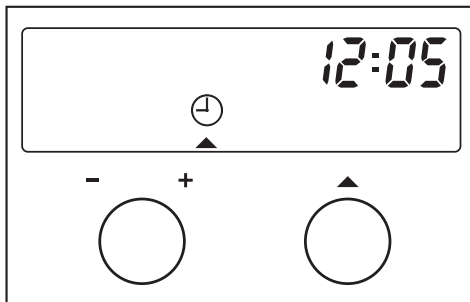

- Now turn the (-/+) input dial clockwise.

The time of day will show in the display.

- Turn the programme selector to "0".

The time of day now shows constantly in the display.

To switch off the time of day display

- Turn the programme selector to the Light ☀ position.
- Turn the function selector (right hand dial) until triangle ▲ is underneath the ⌚ symbol in the display.
- Now turn the (-/+) input dial anti-clockwise.

Four horizontal bars will then appear in the display.

- Turn the programme selector to "0".

The display will go dark and the time will continue unseen in the background.

Operation

Switching on the catalyser

Some appliances have a catalyser built-in to the ventilation system. When switched on, the catalyser removes fat particles from the air circulating in the oven and also reduces cooking smells.

The oven is delivered with the catalyser switched off (standard factory setting).

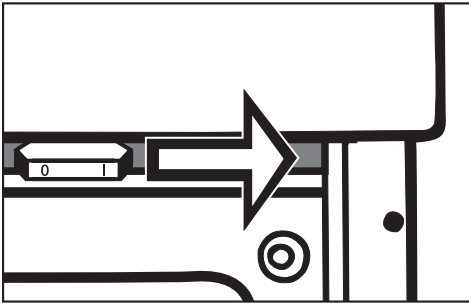

- To switch the catalyser on, please push the lever located underneath the control panel to the right to position "I".

Cleaning and heating up for the first time

Before using the appliance **heat it up once with nothing in it**. New appliances have a slight smell on first use and this procedure will dissipate the smells before you use the oven to cook any food.

Before use please remove

- any stickers from the floor of the oven, baking trays, grill pan etc.
- any cork spacers at the sides above the oven cavity.

- Wipe out the **oven interior** using warm water and a little washing up liquid. Polish dry with a soft cloth.

Do not close the oven door until the oven interior is dry.

- Rinse the **accessories**.

Then run the oven for at least 1 hour at a high temperature. To do this:

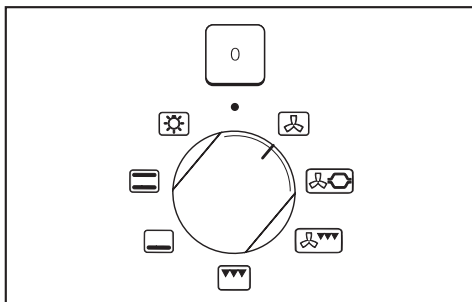

- Turn the programme selector to the Fan  position.



The suggested temperature of 160 °C appears in the display.

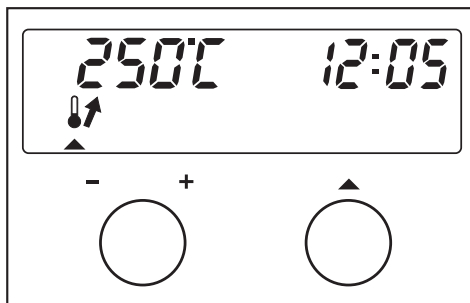

- Whilst the triangle ▲ is flashing underneath the  symbol, use the (-/+) input dial to set the temperature to its highest setting (250 °C).

Once this setting has been accepted

- the oven heating will switch on,
- and the actual temperature in the oven will show in the display.

The timer can also be used to set the finish time (see "Switching off automatically").

Please ensure the room is well ventilated during this operation.

Controls

The oven controls consist of:

- the **Programme selector**, for selecting oven functions with, e.g. Lighting ☀, Fan 🌀, Automatic roasting 🍖, ...
- the **▲ Function dial**, for selecting oven functions which require input e.g. the time of day ⌚, cooking durations ⏪, ...
- the **(-/+) Input dial**, for entering and changing settings on the oven function selected with the Function dial,
- the **Display**, where all changes and settings are visible.

Programme selector

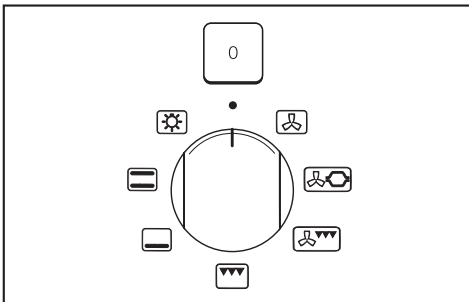

Use the programme selector to select the required programme.

The programme selector can be turned clockwise or anti-clockwise.

Display



The **bottom line** shows the **symbols** of functions where data can be changed.

To highlight these functions turn the function dial (▲).

The **triangle ▲** will appear in the display underneath the symbol of the function you have selected.

The **top line** shows:

- the time (time of day or a programmed cooking time).
- the oven temperature together with the 🔥 or 🔥/🌀 symbol.
- the key symbol 🔑 will appear if e.g. the programme selector is turned when the system lock is engaged or a cooking programme has been locked using the programme lock.
- **EH** for Residual heat being utilised.

Night dimming

Between the hours of 22:00 and 6:00 the lighting in the clock / timer display is dimmed automatically.

The display will appear dimmer during this period if the time of day is set to be on all the time.

Turning the Function or Input dial during this period will bring the timer display back on in full brightness.

Rotary dials

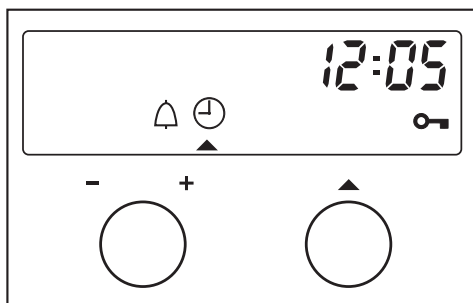

Use the **▲ Function dial**, for selecting oven functions which require input e.g. the time of day.

The **▲ Function dial** can be turned clockwise or anti-clockwise.

To select a function, turn the function dial until triangle **▲** is underneath the symbol in the display of the function you wish to make changes to.

If **triangle ▲**

- **is flashing**, alterations can be made to the settings of the function selected.
- **is lit up**, the function will be displayed, but changes cannot be made to it.

Whilst the ▲ is flashing, use the **(-/+) Input dial** immediately to make any changes:

- **Turning it clockwise**, increases the value shown or engages the function,
- **Turning it anti-clockwise**, reduces the value or switches the function off.

Triangle **▲** will flash for approx. 5 secs.

Settings can only be changed whilst it is flashing.

If this input period has elapsed you will have to use the function dial to re-select the function.

See chart for an overview of symbols in the display and their settings.













The display will change at a different rate depending on how quickly the dial is turned:

- in one minute increments
- in 10 minute increments or
- hour by hour.

Display – functions and symbols

The position of the programme selector affects the settings available using the function dial.

This chart gives an overview of these settings.

Function symbol	Programme selector position		
	Position "0"	Light 	Function
	Change the time of day	Switch the time of day on/off in the display	–
	Input minute minder time (egg timer)	Input minute minder time (egg timer)	Input minute minder time (egg timer)
	Activate/de-activate system lock	–	Lock a cooking programme
	–	–	Change the oven temperature
	–	–	Switch Rapid heat up off (only with Fan heat  , Automatic roasting  , Conventional heating )
	–	–	Enter start time
	–	–	Enter duration
	–	–	Enter end time

Programming sequence

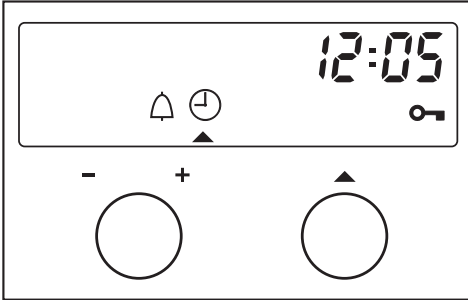

Temperatures, times and other functions are controlled using two rotary dials:

- Input dial (-/+)
- Function dial (▲).

The display will show what these dials are set to.

To change a setting on the oven:

- Turn the **programme selector** to the required position.
- Turn the **function dial** clockwise or anti-clockwise until triangle ▲ is underneath the **required** symbol in the display.
- Whilst **triangle ▲ is flashing**, use the **(-/+)** **Input dial** immediately to make any changes.

The triangle will flash for approx. 5 seconds. If this input period has elapsed you will have to use the function dial to re-select the function.

This principle applies whenever you change a setting.

See "Changing the time of day" and "Using the oven" for examples which explain this principle in detail.

Description of the oven systems

Fan Heat

This system works by the circulation of heated air.

A fan situated on the back wall of the oven sucks in the air, heats it over a ring element and blows the heated air through the carefully spaced openings in the rear panel of the oven, enabling approx. 20 °C lower temperatures to be used than with the Conventional heating system.

The oven does not usually need to be pre-heated as the heated air reaches the food straight away.

Exception: Pre-heating may be necessary for foods which cook in less than 20 minutes and for foods such as puff pastry and yeast mixtures where instant heat is required to make them rise quickly.

Using the fan heating system you can bake and roast on different levels at the same time.

Auto Roast

The oven heats initially to a high temperature (230 °C) which seals the meat to keep it succulent and tasty. As soon as this temperature has been reached, the oven temperature automatically drops back down to the pre-selected setting.

Conventional heating

With the conventional method of heating, radiant heat is directed onto the food from above and below. It is useful where a fairly long cooking time

is required and a deep colour and good rise are needed.

It is usually necessary to pre-heat the oven when using this method.

Grill

This will glow red a few minutes after switching it on and is then ready for use.

The grill element is thermostatically controlled and at times during grilling will not glow red. This is quite normal.

Pre-heat the grill for at least 5 minutes with the door shut before grilling.

Fan Grill

The hot air from the grill is distributed over the food by the fan on the rear wall of the oven. This enables a lower temperature to be selected than for conventional grilling.

The grill element is thermostatically controlled and at times during grilling will not glow red. This is quite normal.

Pre-heat the grill for at least 5 minutes with the door shut before grilling.

More practical advice about these cooking functions is given in the "Baking", "Roasting" and "Grilling" sections of this book and in the Miele cookbook supplied with this oven.

A programme must first be selected using the Programme selector and then, if necessary, the temperature changed.

The programmes on this oven have pre-set recommended temperatures to simplify operation.

Selecting an oven setting

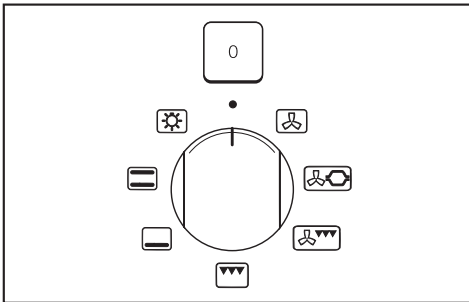

- Turn the programme dial clockwise or anti-clockwise to the required programme position.

When you do this the symbols of any functions which are available in this setting will light up in the display.

- Light ☀️
Turns on the oven light independently.
- Fan Heat 🌀
For baking or roasting on several levels at the same time.
- Auto Roast 🍖
Initial high temperature to seal meat followed by normal roasting temperature.
Not suitable for baking, except for baking freshly prepared wholemeal or rye doughs, (not packet mixes).
- Conventional 🔥
Top and bottom heat together for long, slow baking of traditional recipes, e.g. fruit cake, casseroles.
- Bottom heat 🔥
Use this setting towards the end of baking, to brown the base of a cake, quiche or pizza.
- Fan Grill 🍖
For grilling thick cuts, e.g. rolled meat, poultry.
Grill with the oven door closed.
- Grill 🔥
For grilling fish and cuts such as chops, steaks, poultry pieces, and kebabs.
Grill with the oven door closed.

Using the oven

Selecting a temperature





As soon as the programme selector is turned to a setting the following will appear in the display

- the **recommended pre-set temperature**,
- the symbols of any function that can be altered from this programme selector position.

If you are happy with the recommended pre-set temperature, the display will change a few seconds later to show this as the **target temperature**.







The oven starts to heat up.

The display will then change to show the **actual temperature** in the oven, and depending on which programme is being used the symbol  or  will also show.

The increase of temperature can be followed in the display until the target temperature is reached.

If the door is opened or the target temperature reduced during cooking, the actual temperature will also go down in the display.







The following temperatures are set at the factory:

Fan 	160 °C
Auto Roast  *	160 °C
Conventional 	190 °C
Bottom heat 	190 °C
Fan grill 	200 °C
Grill 	240 °C

* The initial boosted temperature is approx. 230 °C, which then drops down to 160 °C for continued roasting.

Altering the temperature

If the temperature recommended by the system is not suitable, it can be altered according to oven function within the following range:

Fan 	30 – 250 °C
Auto Roast 	100 – 230 °C
Conventional 	30 – 280 °C
Bottom heat 	100 – 250 °C
Fan grill 	50 – 260 °C
Grill 	200 – 300 °C

To do this:



- Using the (+/-) input dial enter the required temperature.

If you have already entered times for an automatic programme, you will first have to call up the  or  symbol on the display before you can alter the temperature.

Using the oven

Rapid heat-up

With the following programmes:

- Fan Heat 
- Auto Roast 
- Conventional 

either the top element or the fan element will come on during the heating up phase to enable the oven to reach the required temperature as quickly as possible.



Food which browns quickly should not be placed at the top of the oven when rapid heat up is being used.

The **symbol ** in the top line of the display indicates that **Rapid heat-up is switched on.**

The **symbol ** will appear in the display for all programmes which do not have rapid heat-up.

To switch off "rapid heat-up"

Rapid heat-up should not be used for some items such as pizza, biscuits and small cakes because they will brown too quickly from the top.

To switch it off:

- Call up the **symbol **.
- Reduce the temperature to 100 °C.

The arrow next to the **symbol ** will go out.

- Re-set the temperature to the setting you want.

"Rapid heat-up" is now switched off for this particular cooking process.

"Rapid heat-up" is available for the next programme once the oven function selector has been turned to "0" at the end of the programme.

Pre-heating the oven

Most dishes can be placed in a cold oven. They will then make use of the heat produced during the heating-up phase.

It is only necessary to pre-heat the oven in certain instances.

With **Fan heat** 

for foods which cook in less than 20 minutes and for foods such as puff pastries and yeast mixtures where instant heat is required to make them rise quickly.

With **Conventional heating** 

pre-heat the oven where a fairly long cooking time is required and a deep colour and a good rise are needed.

Rapid heat-up during the pre-heating phase should be switched off when baking pizza and delicate items such as biscuits and small cakes. Otherwise they will get brown too quickly.

Programming cooking times

You can set the oven to switch itself off automatically or to switch itself on and off automatically when baking and roasting.

First select the appropriate symbol:

Duration \rightarrow



Select the \rightarrow symbol to enter the duration of a cooking programme. Once the time set has elapsed, the oven will switch itself off automatically. The maximum length of time which can be set is 12:00 hours.

Start time \rightarrow



Select the \rightarrow symbol to specify the time you want cooking to start. The oven will start heating up as soon as this time is reached.

End time \rightarrow



Select the \rightarrow symbol to specify the time you want the oven to switch itself off automatically.

Programming cooking times

Symbols in the display

In addition to the ⊖ and ↓ symbols the symbols representing the duration, start and finish time are also displayed constantly if times have been entered for a cooking programme.

If you have only entered the **duration** (e. g. 1 1/2 h) , the display will show:



- The actual temperature,
- the ↓, ⊖ and ⇨ symbols.

The triangle ▲ underneath the ⇨ symbol indicates that a programme duration is being displayed. The time will count down in the display.

To view the required temperature or the time of day in the display you will have to use the function dial to move the triangle ▲ underneath the respective symbol.

As soon as the function dial is turned all functions which can be called up or altered are displayed.

To **switch a programme on and off automatically** there are several ways of entering the times:

- Duration ⇨ and End time →
- Start time ⇨ and duration ⇨
- Start time ⇨ and End time →

The time which has not been entered is calculated automatically.

The ↓ and ⊖ symbols will show in the display together with the symbols representing times entered e.g. Duration and End time:



The triangle ▲ underneath the symbol indicates the last time that was entered.

To see the other times entered move the triangle under the respective symbol.

Programming cooking times

Whilst a programme is running the following show in the display



- The actual temperature and
- Duration or End time

Shortly before the end of cooking time the oven heating switches off automatically.

The Residual heat function then comes into action.



"EC" now appears in the oven display instead of the actual oven temperature to show that the oven is in energy save mode.

The oven heating will switch on again if:

- The required temperature is altered.
- The cooking time is lengthened significantly.

At the end of cooking time

- an audible tone sounds for approx. 5 seconds.
- The →| symbol flashes,
- The cooling fan will continue running until the temperature in the oven has fallen sufficiently.

Both the audible tone and the visual display can be cancelled by:

- Turning the function dial.
If the food is not cooked to your taste, a new cooking time can be entered.
- Turning the programme selector to "0".

If the audible tone is not switched off it will continue to sound at 5 minute intervals as a **reminder** that cooking time has finished. This reminder continues for up to an hour.

Programming cooking times

Switching the cooking process off automatically

To switch a programme off automatically a duration has to be entered. The following example shows the programming for baking a cake using Fan Heat /160 °C, 45 minutes.

- Place the cake tin in the oven and close the door.
- Select a function and temperature.

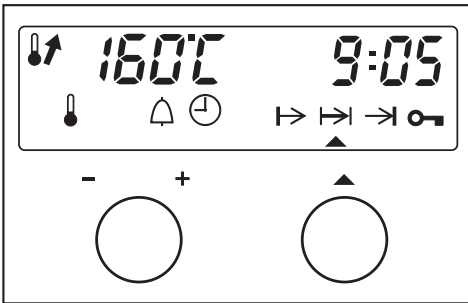

- Call up the H> symbol for duration by turning the function dial (right hand dial) until the triangle is underneath the middle arrow.



"0:00" and the actual temperature in the oven (e.g. 23 °C) will appear in the display.

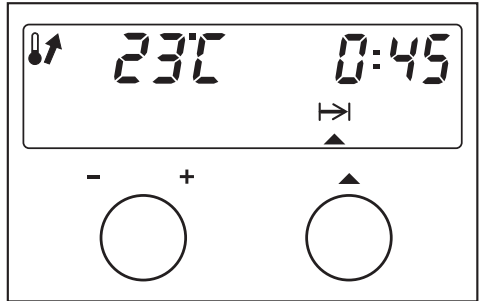

- Enter the duration in Hours:Minutes by turning the (-/+) input dial (left hand dial).

After entering the data



- the temperature rise can be followed in the display,
- as well as the duration counting down, if no other functions are called up.

Once the time set has elapsed, the oven will switch itself off automatically.

Programming cooking times

Switching on and off automatically

It is a good idea to set the oven to switch on and off automatically when roasting.

When baking the oven should not be set to start a long time off. The batter or dough will dry out and the raising agents will lose their effectiveness.

See the following example for an explanation of how to do this.

The time is 9:05. A roast needs 1 1/2 h using Auto Roast  at 160 °C and should be ready at 13:15.

- Place the roast in the oven and close the door.
- Select Auto Roast and set a temperature.

First enter the **duration** :

- Call up the  symbol for duration.

"0:00" and the actual temperature in the oven (e.g. 23 °C) will appear in the display.

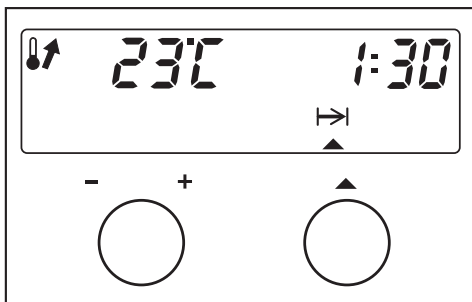

- Enter the duration (1 1/2 h) in Hours:Minutes.

Now set the **End time** :

- Call up the  symbol for End time.





The time of day plus the cooking time entered appear in the display (9:05 + 1:30 = 10:35).

- Enter the end time (13:15) in Hours:Minutes.



Once this setting has been accepted

- the oven heating and cooling fan switch off,
- the  and  symbols indicate that a programme has been set.

Programming cooking times

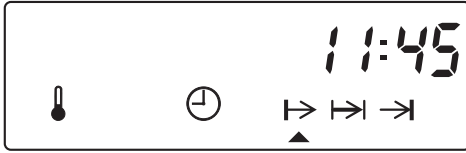

A **Start time** (11:45) will show in the display, when you call up the → symbol.

The oven will start heating up at this time and the duration will then be displayed.

Once the time set has elapsed, the oven will switch itself off automatically.

Please note the following:

In addition to the options given, you can also enter the beginning and end, or just the end, using the appropriate symbols.

To check and change an entered time

It is possible to check or change times entered for a cooking process, at any time by calling up the relevant symbol.

To delete a time entered

- Turn the programme selector to "0".

If there is a power cut all data entered will be deleted.

Using the residual heat, Energy-save function

If you have entered times for a cooking programme, the oven heating will switch off shortly before the end of the time set.

The residual heat in the oven is sufficient to complete the cooking process.

Using the residual heat in the oven saves energy.



"EC" will appear in the display to show that the oven is in energy save mode.

The cooling fan continues to run, as does the hot air fan if a "fan" setting was chosen.

Setting the minute minder

The minute minder can be used to time any activity in the kitchen, e.g. boiling eggs. (It cannot be used to switch the oven off at the end of a set time).

You can enter a time up to a maximum of 12 hours.

You can set the minute minder at the same time as another timed programme, e.g. as a reminder to baste your roast or add seasoning etc.

To enter or change a time:

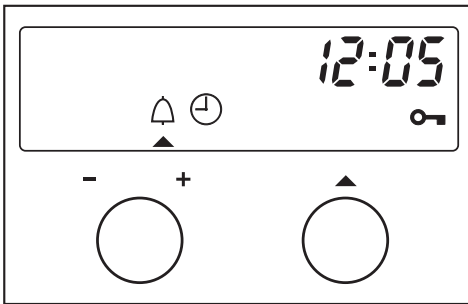



- Use the function dial to select the  symbol (minute minder).

"0:00" appears in the display.

- Enter the duration in Hours:Minutes.

The time then counts down in minutes.

The  symbol continues to be visible as a reminder that the minute minder is working.

As long as the  symbol is selected the minute minder time will be visible counting down in the display.

At the end of the set time

- an audible tone sounds for approx. 5 seconds.
- At the same time the  symbol flashes for approx. 1 minute.

To cancel the minute minder:

- Select the  symbol again. Make sure the triangle underneath the symbol is flashing.
- Use the input dial to set the time back to "0:00".

The system lock prevents the oven being switched on unintentionally, by children for example.

To activate the system lock

Please ensure that the function selector is at "0".

If it is pointing to the oven interior lighting  position, the showroom demo mode will be activated instead of the system lock. The oven can be operated as normal, but it will not heat up.

- Turn the programme selector to "0".
- Call up the  symbol.



Four horizontal bars will appear in the display.

- Turn the (-/+) input dial clockwise.



A key symbol  will appear in the display.

The oven can now not be switched on.

The key symbol  will go out after a short time.

If the programme selector is moved again the key symbol  will appear

again as a reminder that the system lock is active.

The system lock remains active even after a power cut.

To cancel the system lock

- Turn the programme selector to "0".
- Call up the  symbol.

A key symbol  will appear in the display.



- Now turn the (-/+) input dial anti-clockwise.

The system lock is de-activated when the four horizontal bars appear in the display.

Safety lock



A cooking programme can be "locked" to prevent anyone changing the settings.

Engaging the safety lock

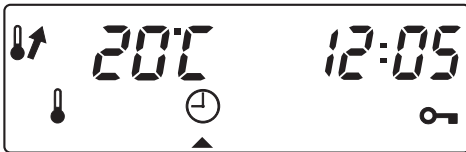
- Select the programme and set a temperature. If necessary set the cooking time.
- Call up the  symbol. Four horizontal bars will appear in the display.
- Turn the input dial in a clockwise direction until a key symbol  appears in the display.



The programme is now locked.

The key symbol  will shortly disappear and the time of day appear in the display. The  symbol in the bottom line of the display acts as a reminder that the safety lock has been engaged.

If either the function or input dial is turned, the key symbol  will appear briefly in the display in place of the time of day.

If the programme selector is turned to a different programme there will also be a continuous shrill beep.

The **cooking programme will be interrupted**, if

- the programme selector is not turned back to the original programme setting within 10 seconds.
- the programme selector is turned to "0".

Turning the programme selector to the "0" position at the end of a locked programme, or after interrupting a programme will not release the safety lock. It will act in this instance as a system lock.

In order **to start a cooking programme again** you will have to

- Turn the programme selector to "0".
- De-activate the safety lock/system lock. To do this:
Call up symbol , and turn the (-/+) input dial anti-clockwise until four horizontal bars appear in the display.

De-activating the safety lock

Temperatures and times cannot be changed during a programme if the safety lock has been activated.



To switch it off:

- Call up the  symbol.
- Turn the (-/+) input dial anti-clockwise until four horizontal bars appear in the display.

The safety lock has now been de-activated and you can change settings.

Baking

The following settings are recommended for baking:

- Fan Heat 
- Conventional 

Bakeware

For the best baking results make sure that you chose bakeware in a material suitable for the particular heating system.

Fan Heat

Most types of heat-resistant tins or dishes are suitable, including thin-walled and bright, non-reflective metal tins. Place the tin or dish on the baking tray in the oven, with the sloping edge of the tray towards the door.

Conventional

The following baking tins give an evenly browned result: Dark metal, aluminium or enamel tins with a matt finish are preferable. Heat resistant glass dishes can also be used.



Avoid bright, shiny metal tins. These reflect heat which means that the heat does not penetrate to the food effectively and will result in uneven or poor browning. In some cases the cakes might not cook properly. Place the tin or dish directly on the non-tip rack in the oven. Use one shelf position only.

Fan Heat

Several levels can be used at the same time for baking. The recommended positions are:

- 1 tray = 1st runner from the bottom
- 2 trays = 1st and 3rd runners from the bottom
- 3 trays = 1st, 2nd and, 4th runners from the bottom

If baking on three levels place tins on the grill pan on the 1st runner position and on baking trays on the other runner levels. Remember to remove the roasting filter from in front of the fan opening. Otherwise baking times would be longer and results uneven.

With Fan Heat , approx. 20 °C lower baking temperatures are needed than with the Conventional  setting.

Conventional

Only one shelf should be used for this function. If more than one shelf position is needed use Fan Heat instead.

This function is particularly good for rich fruit cakes, pastries and breads where a fairly long cooking time is required and a deep colour and good rise are needed.

It is usually necessary to pre-heat the oven when using this method.

Place tins on the rack on **runner level 2 or 3** so that the food is centrally positioned in the oven.

Tips on baking

See the Baking Chart and the Cookbook supplied with this oven for suggestions of temperatures, runner heights and times.

Place cakes in **rectangular tins** with the longer side across the width of the oven for optimum heat distribution and even results.

When baking cakes with **fresh fruit toppings** and **tall sponge cakes** place the tin in the grill pan to catch any spillages and keep the oven cleaner.

When baking anything with **a high salt content** (such as pretzels) they must be placed on baking parchment. High concentrations of salt can damage PerfectClean surfaces.

Frozen food

When baking deep frozen products such as **cakes, pizza and baguettes**, use the lowest temperature quoted on the manufacturer's packaging. Place such items on baking paper directly on the wire rack or in the pizza pan (extra accessory). Placing them on the baking tray or in the grill pan can cause the metal to distort. This distortion would increase with subsequent use.

Deep frozen foods such as **oven chips or potato croquettes** can be cooked on the baking tray or in the grill pan. Place these types of frozen foods on baking parchment and select the lowest temperature quoted on the manufacturer's packaging.

Eating food which has been cooked correctly is important for good health.

Only bake cakes, pizza, chips etc until they are golden brown. Do not allow them to become dark brown.

To achieve even results without over-browning the food

- always select the **lowest temperature** given in the recipe/cooking instructions on the packaging. Do not set a temperature higher than that recommended. Increasing the temperature may reduce the cooking time, but will lead to uneven browning, and unsatisfactory cooking results.
- Check if the food is cooked at the end of the **shortest time quoted**. To check if a cake is ready, insert a wooden skewer into the centre. It is ready if the skewer comes out clean, without dough or crumbs sticking to it.

The cooling fan will continue for a while after switching the oven off.

Always remove all accessories, trays and racks which are not being used when using the oven to get the best results and to keep cleaning of the trays to a minimum.

Baking chart

	Fan Heat 		
	Temperature in °C	rec. runner from bottom	Time in mins.
Creamed mixture			
Madeira cake	150 – 170	1	50 – 60
Rich fruit cake	–	–	–
Victoria sandwich (tin)	160 – 170	1	20 – 25
Fudge brownies (tray)	160 – 170	1	25 – 30
Date and walnut cake	–	–	–
Cookies	150 – 170	1, 3	15 – 20
Small cakes ^{1) 3)}	150 – 170	1, 2, 4	20 – 25
Whisked mixture			
Souffle ^{1) 3)}	180 – 190	2	25 – 30
Flan base ^{1) 3)}	160 – 180	1	20 – 25
Swiss roll ^{1) 3)}	160 – 180	1	20 – 25
Rubbed-in mixture			
Sweet pastry base	150 – 170	1	20 – 25
Scones	200 – 210	1, 3	20 – 25
Crumble	170	1	30 – 35
Teabread ¹⁾	160 – 180	1	60 – 115
Shortbread	160	1	20
Apple pie ¹⁾	150 – 170	1	55 – 75
Savoury pastry ²⁾	190 – 210 –	1	25 – 35
Yeast mixtures			
Wholemeal rolls	–	–	–
Lardy cake	–	–	–
Stollen	150 – 170	1	45 – 65
White bread	160 – 180	1	40 – 50
Wholemeal bread ¹⁾	190 – 210	1	60 – 70
Pizza (tray) ^{1) 3)}	170 – 190	1	40 – 50
Hot cross buns	170	1, 3	20 – 25
Choux pastry ^{1) 3)}			
Eclairs	160 – 180	1, 3	30 – 40
Flaky pastry ¹⁾	170 – 190	1, 3	20 – 25
Meringues ¹⁾			
Macaroons	120 – 140	1, 2, 4	30 – 50
Meringues	60 – 70	1	3 – 4 hours

1) Pre-heat the oven when using Conventional  heat.

2) Pre-heat the oven when using Fan Heat  and Conventional  heat.

3) Switch off "rapid heat-up".

Baking chart



Conventional heat

Temperature in °C	rec. runner from bottom	Time in mins.
160 – 180	2	50 – 60
130 – 150	2	100 – 140
–	–	–
–	–	–
160	2	105 – 120
–	–	–
180 – 200	2	12 – 15
190	2	20 – 25
180 – 200	2	15 – 20
190 – 210	2 or 3	15 – 20
180 – 200	2 or 3	15 – 20
200 – 210	2 or 3	20 – 25
170 – 180	2 or 3	30 – 35
160 – 180	2	60 – 115
–	–	–
180 – 200	1	55 – 75
230 – 250	2 or 3	25 – 35
200 – 220	2 or 3	20 – 25
200 – 220	2	25 – 35
170 – 190	2 or 3	45 – 65
190 – 210	2 or 3	40 – 50
210 – 230	2 or 3	60 – 70
190 – 210	2 or 3	40 – 50
170 – 190	2 or 3	20 – 25
190 – 210	2 or 3	25 – 35
200 – 220	2 or 3	15 – 20
130 – 150	2	30 – 50
–	–	–

**The information given in this chart is intended only as a guide.
See the cook book supplied with your oven for further details.**

Roasting

We recommend the following settings for roasting in the oven:

- Auto Roast 
- Conventional 

Roasting in a covered pot

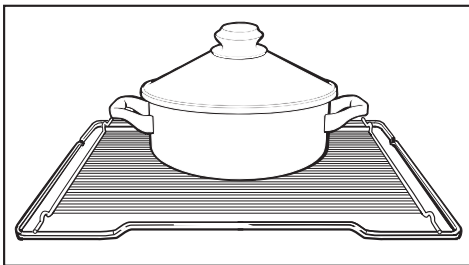

- This ensures that sufficient stock remains for making gravy.
- The oven stays cleaner, too.

Roasting pots with a lid made from earthenware, cast iron, ovenproof china or glass and roasting foil are all suitable. Make sure any lids and handles are heat-resistant.

Season the meat and place in the pot. Add some knobs of butter or margarine or a little oil or cooking fat. Add about $\frac{1}{8}$ litre of water when roasting a big lean joint of meat (2-3 kg) or roasting poultry with a high fat content.

Place the covered pot on the rack into a cold oven.

Exception:

Pre-heat the oven to the temperature suggested when roasting beef and beef fillet.

Browning only occurs towards the end of the roasting time. Remove the lid about halfway through the roasting time if a more intensive browning effect is desired.

Open roasting

Auto roast :

When roasting on the rack or in an open tin make sure the roasting filter is fitted in front of the fan in the back of the oven before starting.

Use **shelf position 1** for roasting.

Exception: With conventional  use runner level 2 for poultry or a cut of meat or fish up to 1kg.

The "Auto roast " system uses an approximately 20 °C lower roasting temperature than the "Conventional" heating system.

When roasting on the rack place the rack and anti-splash tray over the grill pan.

Season the meat and place in the grill pan.

Calculating the roasting time

The traditional British method is to allow 15 to 20 minutes to the lb, according to type of meat, plus approx. 20 minutes, adjusting length of time as roasting proceeds, to obtain the required result.

Temperature

See the **Roasting chart** for suggested **temperatures**.

Do not select a higher temperature than that advised. The meat will become brown, but will not be cooked properly inside.



Do not roast deep frozen meat. Meat should be thoroughly defrosted before roasting.

After the roasting process is finished

- Take the roast out of the oven, wrap in aluminium foil and leave to stand for about 10 minutes.
This helps retain juices when the meat is carved.

The cooling fan will continue for a while after switching off the oven.

Oven roasting chart

	rec. runner from bottom	Auto roast  1)		Conven- tional  1)	
		Temp. 2) in °C	Time in mins.	Temp. 2) in °C	Time in mins.
Beef, approx. 1 kg	1 ³⁾	180	60 – 80	200	70 – 90
Venison, approx. 1 kg	1 ³⁾	180	75 – 100	220 – 240	100 – 120
Leg of pork, approx. 1 kg	1 ³⁾	185	75 – 100	200	100 – 120
Rolled pork, approx. 1 kg	1 ³⁾	185 – 190	90 – 120	200 – 220	110 – 130
Leg of lamb, approx. 2 kg	1	180	110 – 130	200	150
Poultry 1 kg	1 ³⁾	180 – 190	60 – 80	200 – 220	70 – 90
Poultry, approx. 2 kg	1	180 – 190	100 – 110	200 – 220	110 – 120
Poultry, stuffed, approx. 2 kg	1	180 – 190	100 – 120	200 – 220	110 – 140
Poultry, approx. 4 kg	1	170 -180	160 -180	190 -210	170 -190
Whole fish, approx. 1.5 kg	1 ³⁾	160 – 180	35 – 55	200 – 220	35 – 55

Unless otherwise stated, the times given are for an oven which has not been pre-heated.

- 1) Fit the roasting filter in place
- 2) If pot roasting, set the temperature 20 °C higher.
- 3) Use runner level 2 for Conventional .

**The information given in this chart is intended only as a guide.
See the cookbook supplied with your oven for further details.**

Pre-heat the grill for at least 5 minutes with the oven door closed. Grilling with the oven door shut saves energy and minimises cooking smells.

If you grill with the door open the hot air will escape from the oven and not get cooled by the cooling fan. Control elements on the oven could get hot. Danger of burning!

Put the roasting filter in front of the fan grille in the back of the oven when using this setting.

The grill is thermostatically controlled, and at times during grilling the element will not glow red. This is normal.

Clean flat fish and slices of fish in the normal way. To enhance the taste add a little salt or squeeze a little lemon juice over the fish.

Grilling on the rack

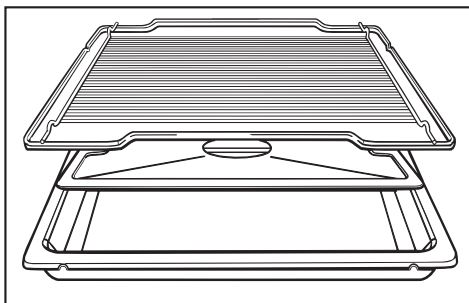

- Assemble the rack on the grill pan and use the anti-splash tray if you have one (see "Optional accessories").
- Place the food on the rack.
- Select the required grill setting.
- Set the temperature.
- Pre-heat the grill for at least 5 minutes with the door shut before grilling.
- Place the grill pan under the grill and shut the door.
 - For thin cuts use runner level 4 or 5
 - For thicker cuts use runner level 3 or 4
- Most items should be turned half way through cooking.

The oven has two grill settings:

Grill

For grilling thin cuts and for browning food.

Fan Grill

For grilling thick cuts, e.g. rolled meat, poultry.

Preparing food for grilling

Clean, wipe and season with pepper and herbs. Do not season meat with salt before grilling as this draws the juices out.

Add a little oil if necessary. Other fats quickly become black or cause the food to smoke.

Grilling

Temperature

For thin cuts of meat
(e. g. chops or steak) 275 °C

For grilling larger items,
(e. g. rolled meat, poultry) 240 °C

See the grill chart for more information.

To grill thicker pieces of food more gradually after an initial high temperature, continue grilling at a lower temperature setting to allow the food to cook through to the centre.

Grilling time

- Flat pieces of fish and meat usually need 5 – 6 minutes per side depending on their texture.
- Use the Auto roast function for thicker cuts.

Tips on grilling



It is best to grill food of a similar thickness at the same time so that the grilling time for each item does not vary too greatly.

One way of finding out how far through a piece of meat has been cooked is to press down on it with a spoon:

- If there is very little resistance to the pressure of the spoon, it is still red on the inside ("rare").
- If there is some resistance the inside will be pink ("medium").
- If there is great resistance, it is thoroughly cooked through ("well done").

Grill chart

Pre-heat the grill for at least 5 minutes with the door closed.

Food to be grilled	Runner from bottom	Grill  1)		Fan grill  1)	
		Temperature in °C	Total grill time in mins. 2)	Temperature in °C	Total grill time in mins. 2)
Flat items					
Steak	4 or 5	300	10 – 16	220	10 – 16
Kebab / mixed grill	3	220	25 – 30	220	25 – 30
Chicken kebabs	3	220	20 – 25	200 – 220	20 – 25
Burgers	4 or 5	240	14 – 20	220	16 – 20
Sausages	4 or 5	240	6 – 10	220	8 – 12
Fish fillet	4 or 5	240	12 – 16	220	12 – 16
Trout	4 or 5	200	16 – 20	220	20 – 25
Toast	4 or 5	250	2 – 4	220	3 – 5
Open toasted sandwich	4 or 5	250	7 – 9	220	4 – 6
Tomatoes	4 or 5	240	6 – 8	220	6 – 8
Thicker pieces of food					
Chicken (approx. 1 kg)	2	240	50 – 60	200 – 220	50 – 60
Rolled meat, Ø 7 cm (approx. 1 kg)	1	240	75 – 85	200	75 – 85
Leg of pork (approx. 1 kg)	1	240	100 – 120	200	100 – 120

1) Use the roasting filter when grilling.

2) Turn half way through the grilling time.

The information given in this chart is intended only as a guide. See the cookbook supplied with your oven for further details.

Defrosting

You can also use the oven for defrosting.

To defrost select Fan heat  with a maximum temperature of 50 °C.

For defrosting meat and delicate foods use the lowest possible temperature (30°C).

Please note the following

- Where possible remove the packaging and put the food to be defrosted on a baking tray or into a dish.
- All meat and poultry should be fully defrosted before cooking. Do not use the liquids from defrosting.
- When defrosting poultry put it on the rack over the grill pan to catch the defrosted liquid, so that the meat is not lying in this liquid.

Chicken, 800 g	90 – 120 mins.
Meat, 500 g	60 – 90 mins.
Meat, 1,000 g	90 – 120 mins.
Sausages, 500 g	30 – 50 mins.
Fish, 1,000 g	60 – 90 mins.
Strawberries, 300 g	30 – 40 mins.
Cake, 500 g	20 – 30 mins.
Bread, 500 g	30 – 40 mins.

Do not refreeze food once it has been thawed.

It is particularly important to observe food hygiene rules when defrosting poultry. Do not use the liquid from the defrosted poultry. Pour it away, and wash the tray, the sink and your hands. Danger of salmonella!

- Fish does not need to be fully defrosted before cooking. Defrost so that the surface is sufficiently thawed to take herbs and seasoning.

Defrosting times

The time needed for defrosting depends on the type and weight of the food, and at what temperature it was deep frozen. The following chart is for guidance only.

Appliance front and control panel

- All external surfaces and controls can be cleaned using warm water with a little washing up liquid applied with a soft sponge or cloth.
- Wipe the surfaces dry using a soft cloth.

E-Cloth

A microfibre "E-Cloth" is available from the Miele UK Spare Parts Department, Part number 98013530, which is suitable for cleaning surfaces such as stainless steel, glass, plastic and chrome without the use of chemicals. This cloth can be washed 300 times.

To prevent the risk of scratches and damage to the surface structure of glass, stainless steel and aluminium fronted appliances pay particular attention to the following cleaning instructions.

Glass fronted appliances

The appliance front and controls are susceptible to scratches and abrasion.

Avoid:

- abrasive cleaning agents, e.g. powder cleaners and cream cleaners,
- abrasive sponges, e.g. pot scourers or sponges which have been previously used with abrasive cleaning agents,
- oven sprays.

Clean the door handle and the control elements regularly, preferably after each use.

This will help prevent grease or other deposits adhering to surfaces and becoming difficult to remove.

Aluminium fronted appliances

Aluminium is affected by the way that light falls on it, by the surrounding environment and by the angle you observe it from.

Aluminium surfaces and controls may suffer discolouration or damage if acids, alkalis or soiling are left on them for too long. Remove these straight away.

The appliance front and controls are susceptible to scratches and abrasion.

Avoid:

- cleaning agents containing soda, acids or chlorides,
- abrasive cleaning agents, e.g. powder cleaners and cream cleaners,
- abrasive sponges, e.g. pot scourers or sponges which have been previously used with abrasive cleaning agents,
- stainless steel cleaners,
- cleaning agents containing descaling agents,
- dishwasher detergent,
- oven sprays.

Cleaning and care

Stainless steel fronted appliances

The appliance front and controls are susceptible to scratches and abrasion.

Please observe the cleaning instructions for

- stainless steel surfaces,
- stainless steel coloured controls

Stainless steel surfaces

Stainless steel surfaces can be cleaned using a proprietary non-abrasive cleaning agent designed specifically for use on stainless steel, or with the Miele E-Cloth.

Avoid:

- cleaning agents containing soda, acids or chlorides,
- abrasive cleaning agents, e.g. powder cleaners and cream cleaners,
- abrasive sponges, e.g. pot scourers or sponges which have been previously used with abrasive cleaning agents.

To help prevent re-soiling, a proprietary conditioning agent for stainless steel can also be used.

Apply sparingly with an even pressure following the direction of the "grain".

Stainless steel coloured controls

The controls may suffer discolouration or damage if soiling is left on them for too long. Remove any soiling straight away.

Avoid:

- cleaning agents containing soda, acids or chlorides,
- abrasive cleaning agents, e.g. powder cleaners and cream cleaners,
- abrasive sponges, e.g. pot scourers or sponges which have been previously used with abrasive cleaning agents,
- stainless steel cleaners,
- oven sprays.

If you are unsure about a particular product or need further advice please contact your nearest Miele Sales office. See back page for address.

Accessories

Do not leave accessories in the oven when they are not in use.

Racks and side supports

The stainless steel surfaces of these have been treated with PerfectClean enamel.

They should be cleaned in the same way as other surfaces coated with PerfectClean. See "PerfectClean".

Roasting filter

Clean in a solution of hot water and a little washing up liquid or in the dishwasher.

Note: some dishwasher detergents may cause the surface of the metal filter to discolour. This discolouration will not affect the functioning of the filter in any way.

PerfectClean

Before using for the first time remove any stickers from PerfectClean surfaces.

The enamelled surfaces of the oven interior, baking tray, grill pan, rack and side supports have been treated with a new type of enamelling called **"PerfectClean"**.

This surface has very good anti-stick properties which is much easier to keep clean than conventional oven enamel, if cleaned regularly.

Food can be taken off it more easily and soiling from baking and roasting is easier to remove.

The following notes on cleaning and care should ensure that the anti-stick and easy clean properties of PerfectClean last for many years.

PerfectClean surfaces can be treated as you would treat glass. If you are unsure whether a particular cleaning product is suitable for PerfectClean consider whether you could clean a window pane with the product without damaging it.

Food can be sliced or cut up on the PerfectClean surface in the same way as on a baking tray with conventional enamel.

Allow the oven and any accessories to cool down before cleaning.
Danger of burning!

Normal soiling

Clean as soon as possible after each use with a dishcloth, soft sponge (e.g. the Vileda sponge as supplied with the oven) or a soft nylon brush, and a solution of hot water and a little washing up liquid. The longer soiling is left the harder it may become to remove.

Stubborn soiling

Stubborn soiling e.g. from roasting may need to be soaked first with a damp sponge to loosen it and if necessary a scraper suitable for glass surfaces can be used to remove it.

After cleaning rinse thoroughly with clean water. The water must run off the surface easily. Any residual cleaning agents will hinder this effect.

Using oven sprays on very stubborn soiling

Some oven cleaners contain strong alkalines and / or abrasive materials. Because the enamel is designed to be easily cleaned the use of these cleaners is not recommended.

However if you still cannot get the surface clean, an oven cleaner can be used for a couple of minutes only. Do not attempt to use on a hot oven or accessories. Allow the PerfectClean surfaces to cool down to room temperature before applying oven sprays!

Cleaning and care

Remove the catalytic back panel, side liners (if fitted) and roof panel before using oven sprays. The chemicals used in oven sprays will damage catalytic enamel rendering it ineffective.

Apply a spray oven cleaner to the soiled areas. Leave to take effect for **a couple of minutes only!**

If necessary use a soft sponge (e.g. the Vileda sponge as supplied with the oven), soft nylon brush or a scraper suitable for glass surfaces to loosen the soiling.

Repeat the process if necessary.

After cleaning rinse thoroughly with clean water and then dry thoroughly.

Important

For optimum performance of the PerfectClean enamel it is important to clean the oven and accessories after each use.

The surfaces will become harder to clean and the anti-stick properties will deteriorate if soiling is not removed after each use and allowed to build-up. In extreme cases cleaning may even become impossible.

The following cause lasting damage to the surface structure and reduce the anti-stick effect and must not be used on PerfectClean surfaces:

- abrasive cleaning agents
- wire wool or metal scourers
- pot scourers
- oven cleaning pads
- sponges and cloths which have previously been used with abrasive cleaning agents.
- oven spray must not be used in a hot oven or left on for too long.
- items coated with PerfectClean enamelling must not be cleaned in a dishwasher.

Note

Soiling such as spilt juices and cake mixtures are best removed whilst the oven or tray is still warm. Exercise caution, make sure the oven is not hot - danger of burning!

Spilt fruit juices may cause lasting discolouration of the surfaces and roasting can cause matt areas to appear. Clean these following the instructions given above and do not try and use force to remove them! This discolouration is permanent but will not affect the efficiency of the enamel.

When baking items with a high salt content (e.g. continental pretzels) place them on baking parchment in the baking tray or grill pan. Sodium deposits can cause lasting discolouration to PerfectClean surfaces.

Catalytic enamel surfaces

The back panel, the roof liner and side liners (if fitted) are coated with **catalytic enamel**.

Catalytic enamel has very good self-cleaning properties.

During fan operated cooking, circulating air in the oven deposits oil and fat splashes predominantly on the back panel of the oven.

When this catalytic enamel is heated to temperatures above 200 °C, oil and grease deposits are removed automatically. The higher the temperature the more effective the process.

The oven and accessories should be cleaned after each use. Otherwise further baking and roasting will cause the deposits to bake on even harder and cleaning may become difficult and in extreme cases impossible.

Note that deposits of spices, syrups and similar substances are not removed by this process. These should be removed while fresh by hand with a mild solution of hot water and washing up liquid applied with a soft brush.

Cleaning catalytic enamel surfaces by hand

Allow the oven to cool down before cleaning. Danger of burning!

- The catalytic enamelled back panel, side liners and roof liner should be cleaned using a solution of hot water with a little washing up liquid applied with a soft nylon brush.

Do not use abrasive cleaning agents, hard brushes, scouring pads or cloths, steel wool, knives or other abrasive materials and do not use oven spray on catalytic enamel as the chemicals used in oven sprays will damage catalytic enamel, rendering it ineffective. If using oven sprays on PerfectClean oven surfaces, the catalytic back panel, side liners (if fitted) and roof liner must first be removed from the oven.

Cleaning and care

Cleaning catalytic enamel surfaces using high temperatures

If, after manual cleaning, the oven is still heavily soiled heating it to a high temperature will help remove soiling caused by oil and grease splashes from the catalytic surfaces.

Before cleaning the catalytic panels using high temperatures, make sure that all PerfectClean surfaces have been cleaned as previously described. Otherwise, the high temperatures can cause deposits on PerfectClean surfaces to become baked on and impossible to remove.

To clean using high temperatures:

- Take all accessories out of the oven.
- Select Fan Heat .
- Select the highest temperature setting.

Run the oven for approx. 1 hour. The length of time will depend on the level of soiling.

Any remaining soiling will gradually disappear with each subsequent use of the oven at high temperatures.

The timer can also be used to set the finish time (see "Switching off automatically").

Should the catalytic coating on the back panel, side liners or the roof liner become ineffective through improper use or heavy soiling, a replacement can be obtained from your Miele dealer or the Miele Spare Parts dept.

Cooking compartment

To make cleaning easier you can

- remove the oven door,
- dismantle the oven door,
- take out the runners,
- lower the top heating element,
- and take out the back panel, side liners (if fitted) and roof liner.

To remove the oven door

The oven door is connected to the oven by hinges.

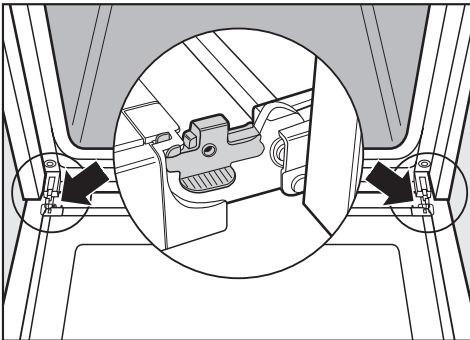

Before removing the door the locking clamps on both hinges have to be released.

- Open the door fully.

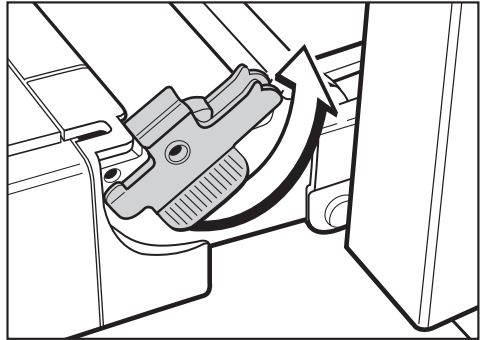

- To release the locking clamps on the hinges turn them upwards as far as they will go until they are at an angle. See illustration.
- Then lift the door upwards as far as it will go.

Do not attempt to take the door off the hinge guides when it is in a horizontal position. The guides will close and damage the appliance. There is also a danger of injury.

Cleaning and care



- Hold the door securely at both sides and lift upwards off the hinge guides.

Do not lift the door off by the handle. The handle could break.

Make sure that you lift the door off equally on both sides.

To dismantle the oven door

The oven door has seals on all sides to protect it.

In the rare event that condensate has worked its way in between the glass panes, the door can be dismantled in order to clean in between the panes.

Do not use scouring agents, hard sponges or brushes to clean the glass panes. These could damage the surface.

Do not use an oven spray. This would damage the surface of the aluminium surrounds.

- Always remove the oven door before dismantling it.
- Place the door on a protective surface (e.g. on a table cloth) to prevent it getting scratched. The door handle should line up with the edge of the table. Make sure the glass lies flat and does not get broken during cleaning.

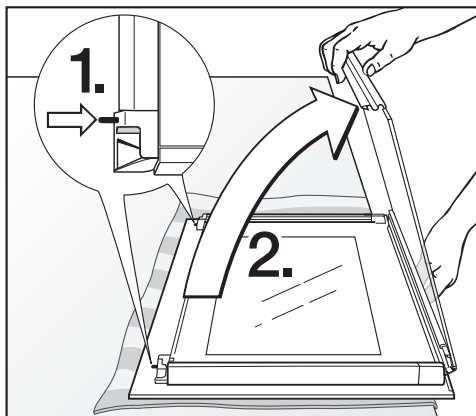

- Press the pins near the hinge guides on both sides of the door in (1) to release the inner glass pane from its retainers.

The inner pane will automatically lift upwards.

Lift up the inner glass pane (2) and release it from the aluminium guides on the outer pane.

The aluminium guides on the outer and inner glass panes are bonded to the glass and cannot be removed.

Depending on model the oven door is fitted with two or three glass panes.

On **oven doors with three panes** the middle pane can also be taken out.

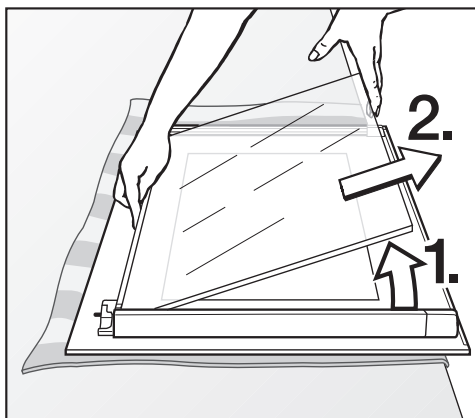

- Lift this pane up slightly before removing it.
- Clean each pane individually being extremely careful to avoid the risk of breakage.
- Put the door back together again.

Cleaning and care

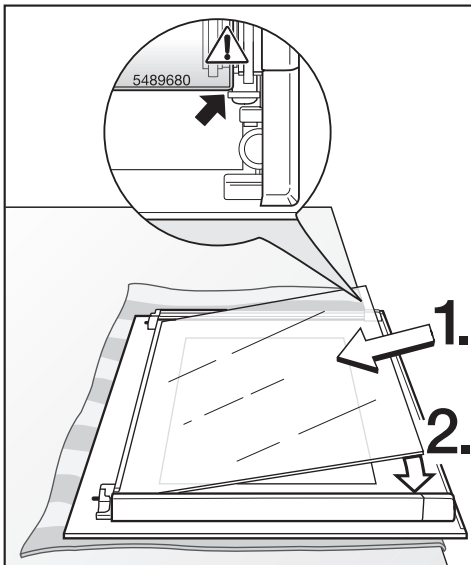

- Refit the middle pane (depending on model).

See detail on illustration.

- The panes have a different coating on each side.
The printed figure must be legible.
This ensures that the side with a heat reflective coating faces into the oven compartment.
- The pane must sit evenly on the seal and not on the screw heads in the aluminium guides.

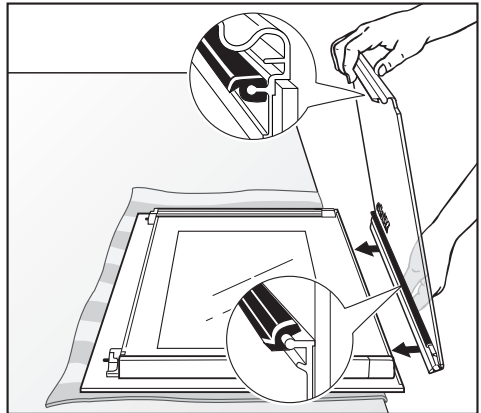

- When replacing the inner pane make sure that the aluminium guide and handle face upwards. The words "Miele CleanGlas" will then be legible.

If the seals on the inner pane have loosened during cleaning you will have to push them back into the guides making sure that the profiled part of the seal faces inwards (see detail on illustration).

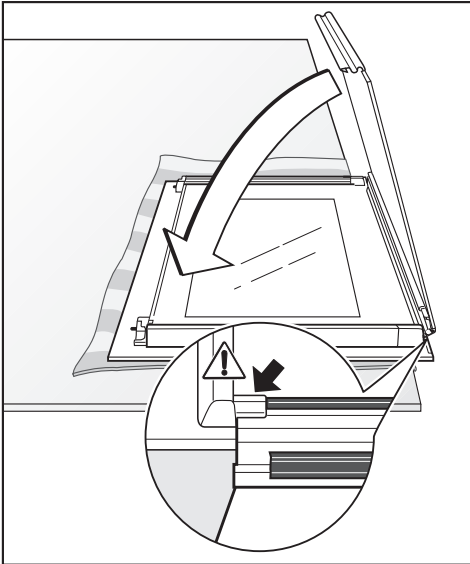

- Hook the inner glass pane into the aluminium guides on the outer pane and lower it into position. Make sure when lowering the inner pane that it does not come out of its fixings.

After lowering it into position the inner pane has to be pushed back into its retainers.

This is easier to do if you push one side into its retainer first and then do the other side.

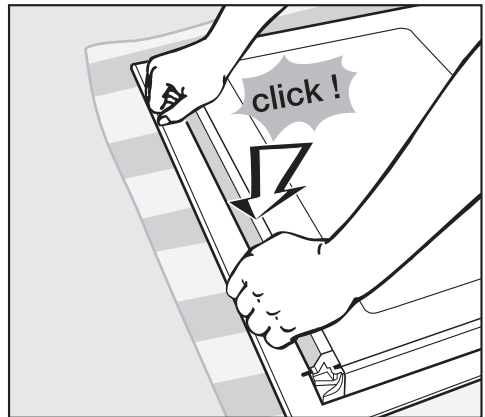

- Finally using the ball of your hand press down on the aluminium trim on the inner pane to make sure it goes back into position. You will hear a very clear "click" when doing this. The retaining pins are pushed back out when you do this.

Before putting the door back on make sure that the inner pane is sitting correctly in its retainers and that it cannot come loose and get damaged.

Cleaning and care

To refit the door

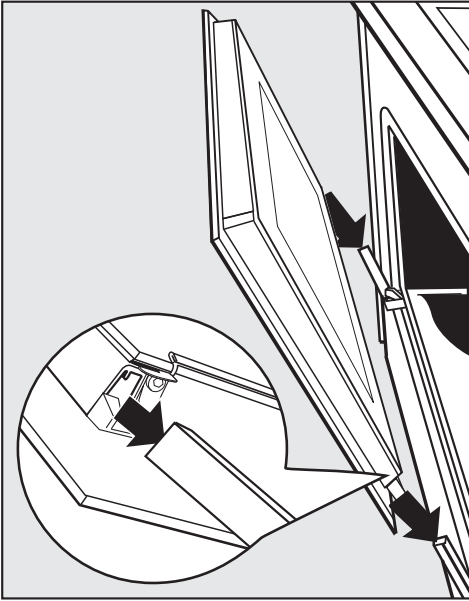

- Hold the door securely at both sides and carefully fit it back onto the hinge guides.

Make sure that the door goes back on straight.

- Open the door fully.

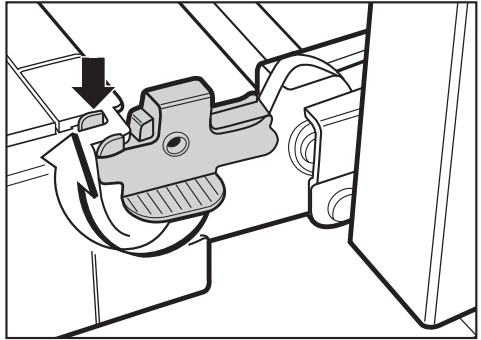

- Flip both locking clamps back up to lock them. Turn them as far as they will go into a horizontal position. Make sure that the notches on the locking clamps hook into the slots on the door as illustrated.

It is essential that the locking clamps lock securely when the door is re-fitted after cleaning. Otherwise the hinges could work loose from the hinges and this could result in damage to the door.

To remove the runners

Make sure the oven heating elements are switched off and cool. Danger of burning.

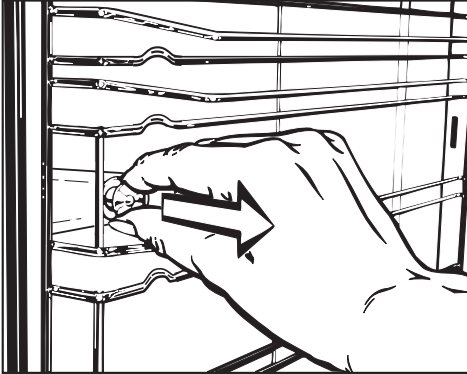

- Pull on the fixing knob to release it.

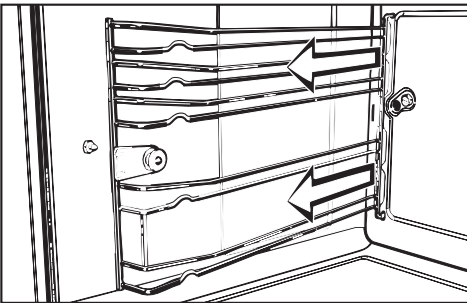

- Remove the runners.

Reassemble in the reverse order, carefully ensuring all parts are correctly in place.

To lower the upper heating element

Make sure the oven heating elements are switched off and cool. Danger of burning.

- Remove the runners.

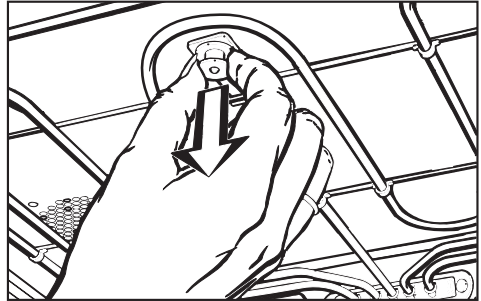

- Pull on the fixing knob to release it.

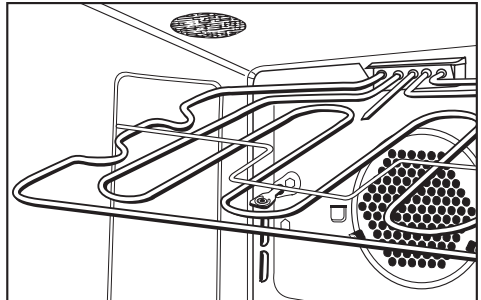

- Gently lower the element.

Do not use force to pull it down as this can cause the element to break.

Cleaning and care

To remove the catalytic enamelled back panel, side liners (if fitted) and roof liner

Make sure the oven heating elements are switched off and cool. Danger of burning.

The catalytic panels and liners can be removed for cleaning if necessary.

See "Cleaning and Care" for more information.

– Back panel

- Remove the runners.

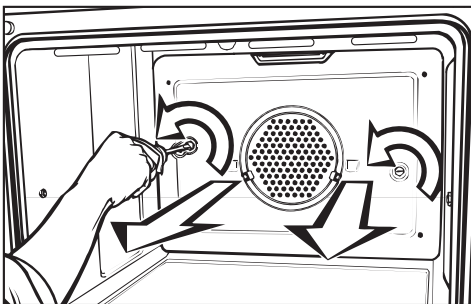

- Loosen the screws in the back panel and take it out.

The oven must not be used without the back panel fitted. This could cause considerable injury.

Reassemble in the reverse order, carefully ensuring all parts are correctly in place.

– Roof liner

- Remove the runners.
- Lower the top heating element.

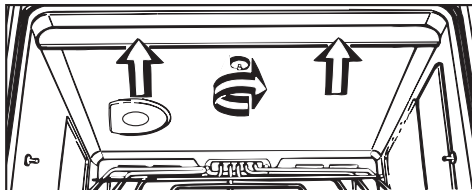

- Hold the roof liner firmly and unscrew the knurled knob.
- Take out the roof liner.

Reassemble in the reverse order, carefully ensuring all parts are correctly in place.

– Side liners

(depending on model)

- Remove the runners.
- Lift the side liners up slightly before removing them.

Reassemble in the reverse order, carefully ensuring all parts are correctly in place.

When reassembling the catalytic side liners, ensure they sit correctly.

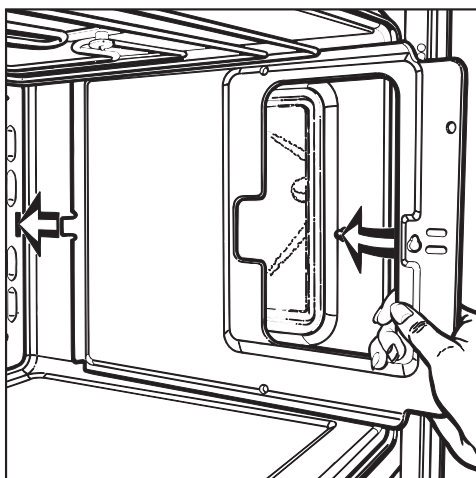

- Ease the back lug into the opening in the rear wall panel.

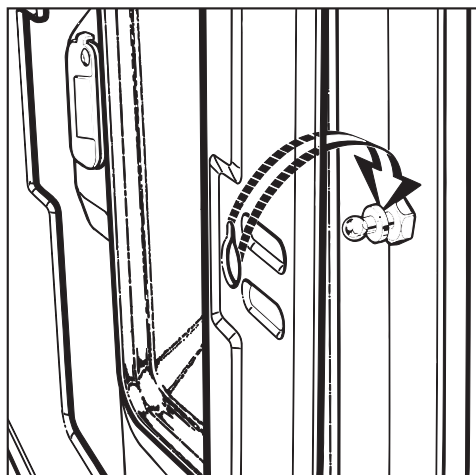

- Lift the front locating hole on to the guide pin behind the collar.

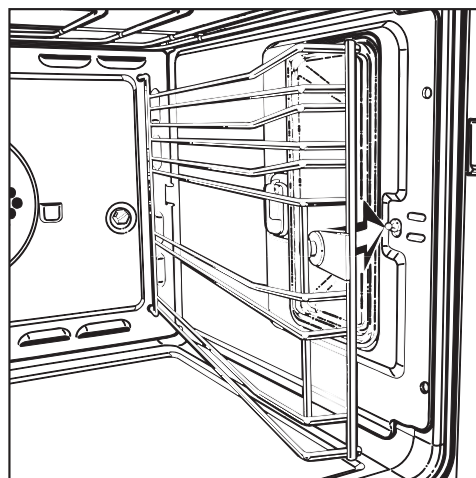
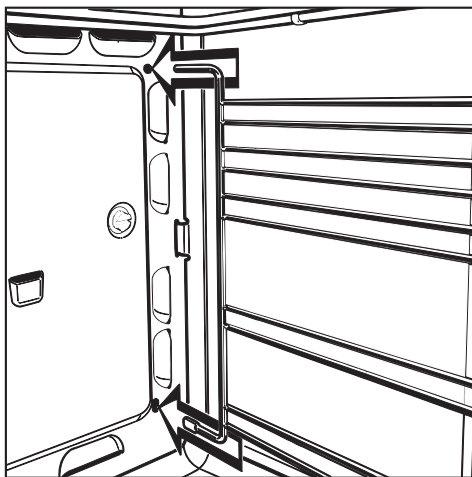

- Put the runners back into place.

Problem solving

Installation, maintenance and repairs should only be carried out by a suitably qualified and competent person in accordance with local and national safety regulations. Repairs and other work by unqualified persons could be dangerous and the manufacturer will not be held responsible.

Some minor problems can be corrected without contacting the Miele Service Department:

What to do if ...



... the oven does not heat up.

Check whether,

- the system lock has been activated.
- the mains fuse has blown. Contact a qualified electrician or the Miele Service Department.
- *MES_* appears briefly in the display when the programme selector is turned to the light  position.

The oven is set to the showroom display programme. In this setting you can select a programme as normal but the oven will not heat up.

To deactivate the showroom display programme:

- Turn the programme selector to . *MES_* will appear in the display.
- Call up the  symbol.
- Turn the input dial anti-clockwise until four horizontal bars appear in the display.

The showroom display programme has now been deactivated. The oven can now be used again as normal.

... the heating works, but not the oven lighting.

The lamp needs changing.

To change the lamp:

- Disconnect the appliance from the electricity supply. Switch off and unplug at the socket, or remove the fuse, or switch off at the isolator as appropriate.
- Remove the runners and side liners (if fitted).

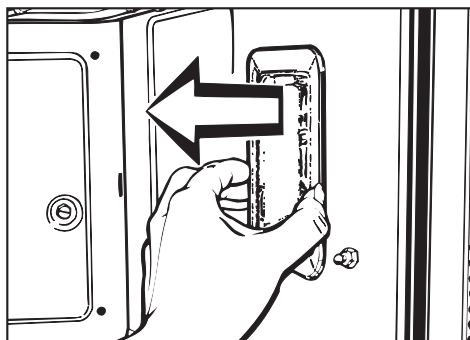

- Lift the lamp cover from its retainers.
- Change the lamp: 230-240V, 25 W, E 14, heat resistant to 300°C.
- Press the lamp cover back into its retainers.
- Replace the runners and side liners.

... there is a distinctive smell of food when using the oven.

This applies to model H 334 B KAT only:

Check the position of the lever for switching on the catalyser. If it is at the "0" position the catalyser is switched off.

To switch the catalyser on, please push the lever over to the right to position "1".

... no noise is heard when the oven door is opened during operation.

This is not a fault.

If the door is opened during operation, the door contact switch causes the oven heating, and the fan if on "Fan" setting, to be switched off.

... a noise can be heard after baking, roasting or grilling.

This is not a fault.

The cooling fan continues to run for a while after the oven has been switched off to prevent any humidity building up in the oven, on the control panel or in the oven housing unit. When the temperature has fallen sufficiently the fan switches off automatically. The temperature will fall faster when the oven door is opened partially or fully.

... cakes and biscuits are not cooked after following the times given in the chart.

Check whether,

- the correct temperature was set.
- there has been a change to the recipe. The addition of more liquid or more eggs makes a moister mix which would need longer to cook.
- the roasting filter was left in front of the fan when baking with Fan heat . In this case baking times might be lengthened by 10 to 15 minutes.

... cakes or biscuits are unevenly browned.

There will always be a slight unevenness. Product information sheets give a percentage result for standard browning tests. These refer to results for one tray.

If browning is very uneven, check when baking with **Fan Heat** :

- whether the temperature was set too high,
- whether the roasting filter was in place,
- whether the correct runner height was used.

when baking with **Conventional** :

- the colour and composition of the baking tins being used. Light coloured, shiny, or thin walled tins are less suitable,
- whether the correct runner height was used.

Problem solving

... spots like rust appear on catalytic surfaces.

When roasting on the rack, the circulating air sometimes picks up spices, which are then deposited on the oven interior walls. Such residues are not removed by catalytic cleaning, they are best removed while fresh with a mild solution of hot water and washing up liquid and a soft brush.

... there has been a power cut and "12:00" and the triangle ▲ are flashing underneath the ⌚ symbol.

All pre-set times are deleted as a result of the power failure.

- Enter the time of day again, and any other pre-set data.

... "F" and a number appear in the oven display field.

This combination indicates a fault.

- **"F55"**: the oven has automatically switched itself off during use. This is a safety feature to protect the oven if it has been operating for an exceedingly long period. The length of time depends on the oven function selected.

The oven can be used again immediately by simply turning the oven function selector to "0" and then entering the process again.

- **Any other fault messages:**
If **any other fault message** appears in the display, this will need a service visit.

In the event of any faults which you cannot remedy yourself, please contact

– Your Miele Dealer

or

– The nearest Miele Service Department (see back cover for address).

When contacting the Service Department, please quote the model and serial number of your appliance.

These are shown on the data plate, visible below the oven interior, with the door fully open.

Please note that telephone calls may be monitored and recorded to improve our service.

Extra accessories

The following accessories may come as standard with some models. They are also available at extra cost from your Dealer or the Miele Spare Parts Dept.

Telescopic baking carriage

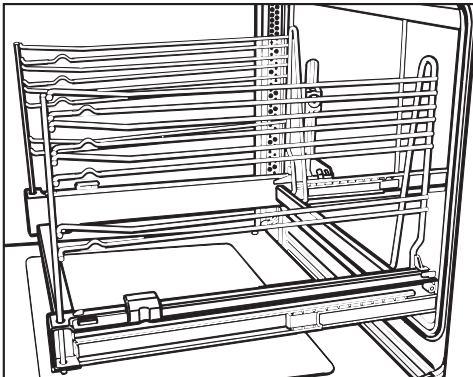

The telescopic baking carriage with 5 levels of runners can be drawn right out of the oven. This gives a good overview of all the cooking in progress.

Telescopic runners

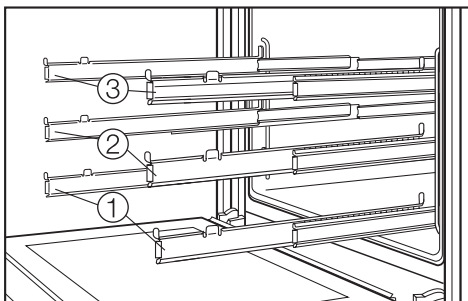

The telescopic runners provide three shelf levels.

Each shelf level can be drawn right out of the oven individually to give a good overview of cooking in progress

Anti-splash tray

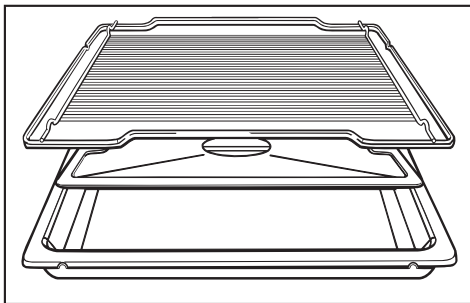

The anti-splash tray should be placed in the deep-sided grill pan when grilling or roasting. The juices from the food being cooked collect under the anti-splash tray. This prevents them from spitting and making the oven dirty. The juices can then be used for making gravy and sauces.

Handle

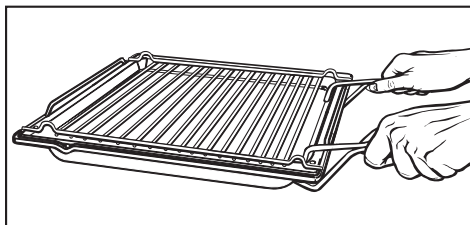
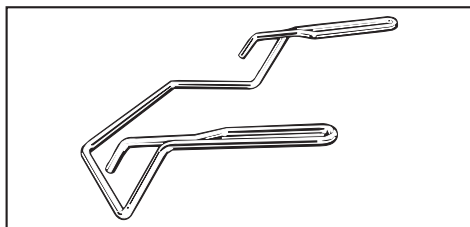

The handle makes it easier to take baking trays, grill pan and rack out of the oven, or to put them into it. The two prongs at the top go inside the pan, rack or tray and the U-shaped supports underneath.

Pizza pan

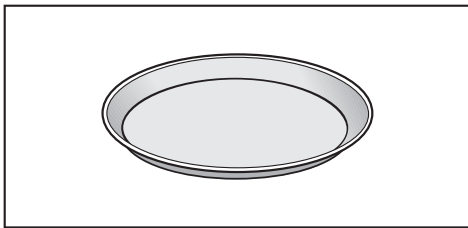

This circular pan is suitable for cooking pizzas, flat cakes made with yeast or whisked mixtures, sweet and savoury tarts, baked desserts, and can also be used for deep frozen cakes and pizzas.

Baking stone

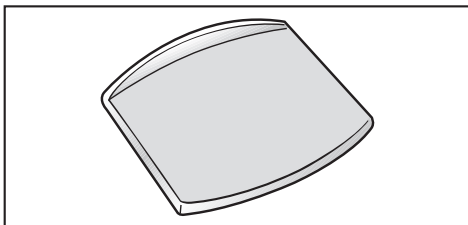

The baking stone is ideal for items which need a well baked base such as pizza, quiche, bread, bread rolls and savoury snacks.

The baking stone is made from heat retaining fire brick and is glazed. Place it directly on the rack.

A paddle made of untreated wood is supplied with it for placing food on the baking stone and taking it off.

Gourmet oven dish

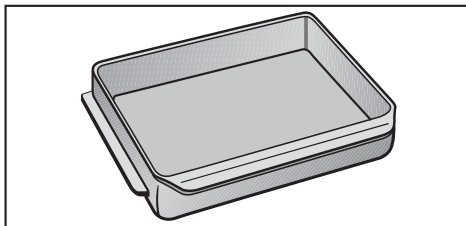

The gourmet oven dish can be placed in the oven directly on the runners. It has non-tip safety notches like the baking tray to prevent it being pulled out too far.

It has a special protective anti-stick coating.

It is available either 22 or 35 cm deep. A lid is available separately.

Catalytic side liners

If you roast or grill frequently catalytic coated side liners can be fitted in the sides of the oven to help keep the oven clean.

When ordering please state the model number of your oven and whether it is fitted with side runners or a telescopic baking carriage.

Catalyser

The catalyser is fitted into the oven's ventilation system.

It filters fat from the escaping vapours and thus reduces cooking smells.

Electrical connection UK, ZA

All electrical work should be undertaken by a suitably qualified and competent person in strict accordance with national and local safety regulations.

Installation, repairs and other work by unqualified persons could be dangerous. The manufacturer cannot be held responsible for unauthorised work.

Ensure power is not supplied to the appliance while installation or repair work is being carried out.

The **voltage, rated load and fusing** are given on the data plate, visible below the oven interior, with the oven door open. Ensure that these match the household mains supply. Please quote these data, and the model and serial number when contacting the Miele Service dept.

Connection of this appliance should be made either via a suitable isolator, which complies with national and local safety regulations, and the on/off switch should be easily accessible after the appliance has been built in.

If the socket is not accessible after installation (depending on country) an additional means of disconnection must be provided for all poles.

For extra safety it is advisable to install a residual current device with a trip current of 30 mA (in accordance with DIN VDE 0664, VDE 0100 Section 739).

When switched off there must be an all-pole contact gap of 3 mm in the isolator switch (including switch, fuses and relays acc. to EN 60 335).

Important U.K.

This appliance is supplied with a 3-core cable for connection to a single phase 230-240 V 50 Hz supply.

The wires are coloured in accordance with the following code:

Green/yellow = earth
Blue = neutral
Brown = live

In other countries check these details with your supplier.

WARNING
THIS APPLIANCE MUST BE
EARTHED

ZA

Data relating to electrical connection will be found on the data plate, visible when the oven door is open. Make sure that these figures comply with the main voltage. Connection should be made via a suitable isolator which complies with national and local regulations.

The appliance is supplied with a 3-core cable for connection to a 230-240 volt 50 Hz supply.

The fuse rating is 20 amps for the "B"-model.

The wires are coloured in accordance with the following code:

Green/yellow = earth
Blue = neutral
Brown = live

WARNING
THIS APPLIANCE MUST BE
EARTHED.

Electrical connection AUS, NZ

All electrical work should be undertaken by a competent person in strict accordance with national and local safety regulations.

The voltage and rated load are given on the data plate, visible when the oven door is open. Please ensure that these match the household mains supply. Please quote these data, and the model and serial number when contacting the Miele Service dept.

Connection of this appliance should be made via a suitable isolator which complies with national and local regulations, and which is accessible after the appliance has been built in.

WARNING
THIS APPLIANCE MUST BE
EARTHED.

Test marks Electrical Safety
. C-Tick Mark

Electrically suppressed
according to AS/NZS 1044

AUS

Wall oven

The wall oven is suitable for connection to an a.c. single phase 240 V, 50 Hz electricity supply.

The fuse rating is 16 A.

NZ

Wall oven

The wall oven is suitable for connection to an a.c. single phase 230 V, 50 Hz electricity supply.

The fuse rating is 16 A.

Installing the oven

Do not fit insulation material inside the housing unit. This would hinder the intake of air to cool the appliance.

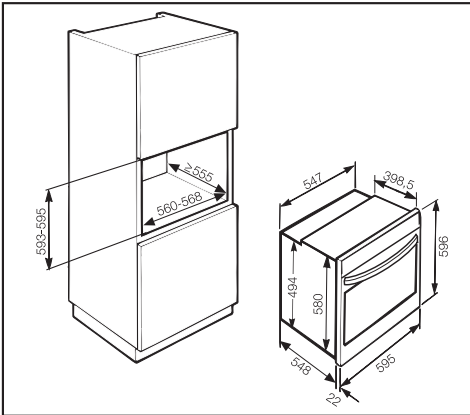

Turn off the mains electricity supply to the isolator.

- Connect the oven to the electricity supply by the isolator.
- Place the oven into the oven housing unit as far as the oven trim and align.

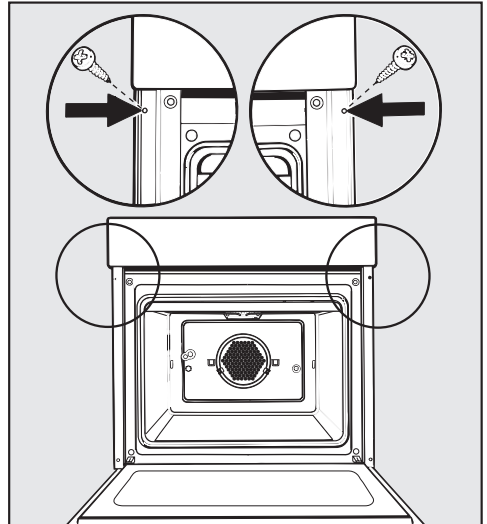

- Open the oven door and using two screws secure the oven to the side walls of the housing unit through the holes in the oven trim.

The oven must be built in to be operated.

**United Kingdom:**

Miele Co. Ltd.
Fairacres, Marcham Road
Abingdon, Oxon, OX14 1TW
tel. Abingdon (01235) 554455
Service Office: (01235) 554466
fax (01235) 554477
Internet: www.miele.co.uk

Ireland:

Miele Ireland Ltd.
Broomhill Road, Tallaght, Dublin 24
Tel: (01) 46 10 710, Fax: (01) 46 10 797
Email: info@miele.ie
Internet: <http://www.miele.ie>

Australia:

Miele Australia Pty. Ltd.
A.C.N. 005635398
1 Gilbert Park Drive
Knoxfield, VIC 3180
Telephone: (03) 9764 7100
Fax: (03) 9764 7129
Internet: www.miele.com.au

Distributor New Zealand:

Steelfort Engineering Company. Ltd.
500 Rangitikei Street
Palmerston North, Priv. Bag 11045, NZ
Telephone: (06) 350 1350
Fax: (06) 356 1507

South Africa:

Miele (Pty) Ltd
304 Tungsten Road
Strijdom Park 2194
P.O.Box 1654, Randburg 2125
Tel. (011) 793-7452
Telefax (011) 793-7447
E-mail: info@miele.co.za
Internet: www.miele.co.za

Singapore:

Miele Southeast Asia
Miele Pte. Ltd.
163 Penang Road
04 - 02/03 Winsland House II
Singapore 238463
Tel : +65-67351191
Fax: +65-67351161
Email: mielesea@miele.com.sg

Hong Kong:

Miele (Hong Kong) Limited
AIA Plaza, Room 401, 4th Floor
18 Hysan Avenue
Causeway Bay
Hong Kong
Tel.: (852) 2610 1331
Fax: (852) 2610 1013
E-mail: mielehk@netnavigator.com

Free Manuals Download Website

<http://myh66.com>

<http://usermanuals.us>

<http://www.somanuals.com>

<http://www.4manuals.cc>

<http://www.manual-lib.com>

<http://www.404manual.com>

<http://www.luxmanual.com>

<http://aubethermostatmanual.com>

Golf course search by state

<http://golfingnear.com>

Email search by domain

<http://emailbydomain.com>

Auto manuals search

<http://auto.somanuals.com>

TV manuals search

<http://tv.somanuals.com>