

Quick reference guide

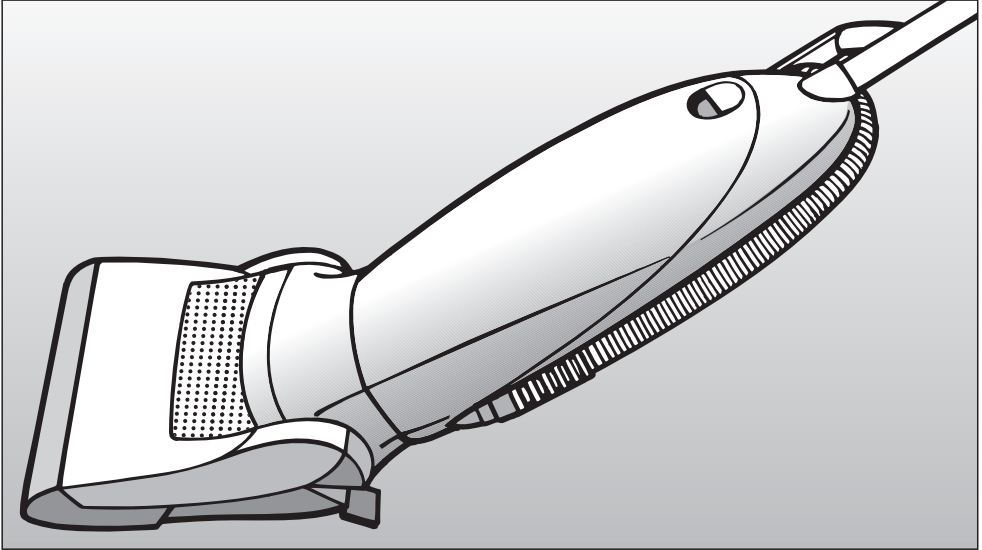

Upright Vacuum Cleaner S 7000

en - US, CA

To prevent accidents and machine damage, read the attached operating instructions before installation and use.

M.-Nr. 07 450 370

Using the vacuum cleaner

Assembling the vacuum cleaner

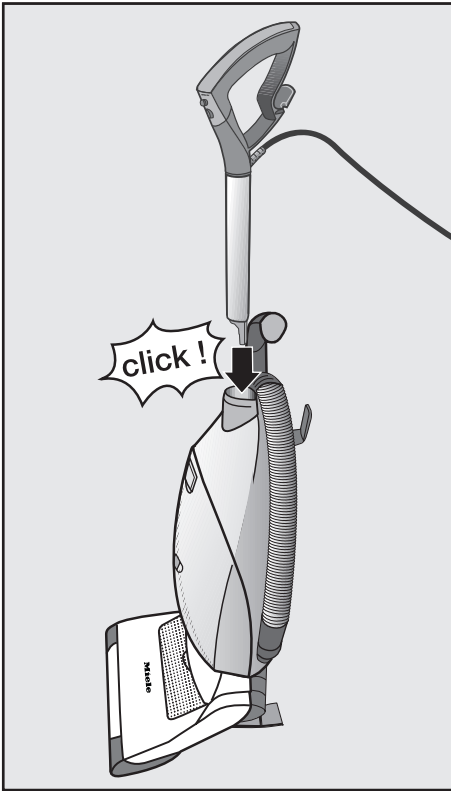

Releasing the body of the vacuum cleaner

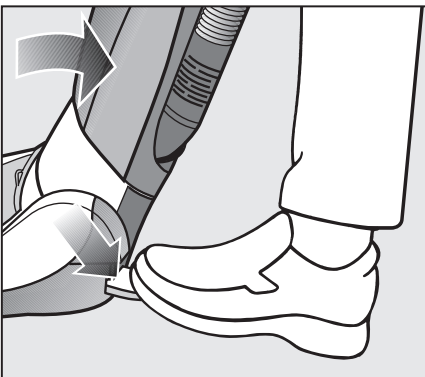

Releasing / Rewinding the power cord

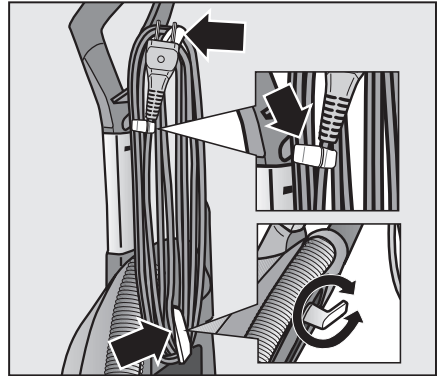

Align cord with notch

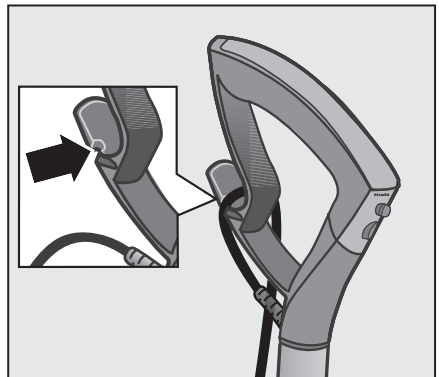

Turning the vacuum cleaner On/Off

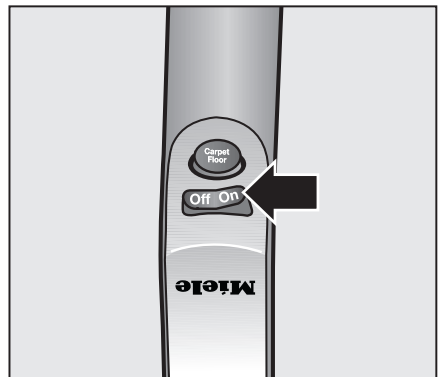

Using the vacuum cleaner

Selecting the flooring type

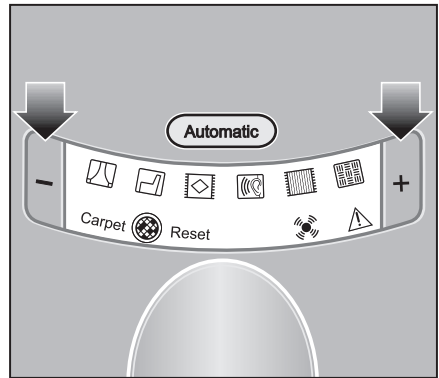
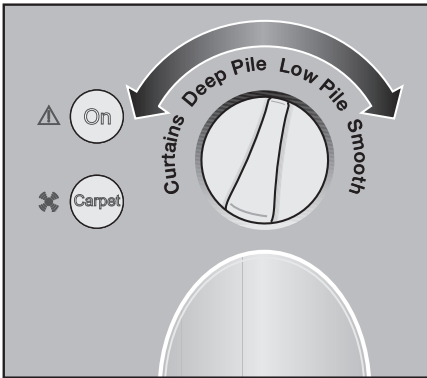

Turning the Powerbrush On/Off

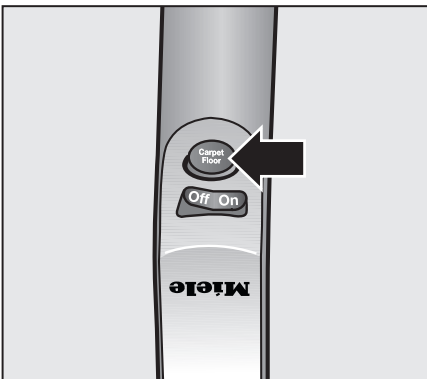

Fitting the vacuum Hose and Wand

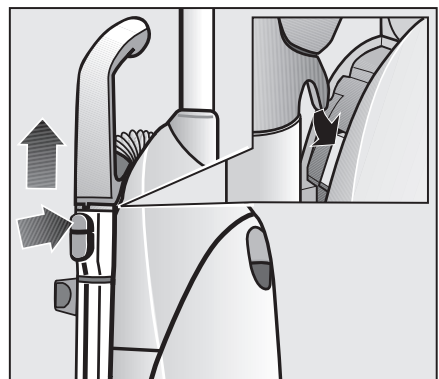

Telescopic wand

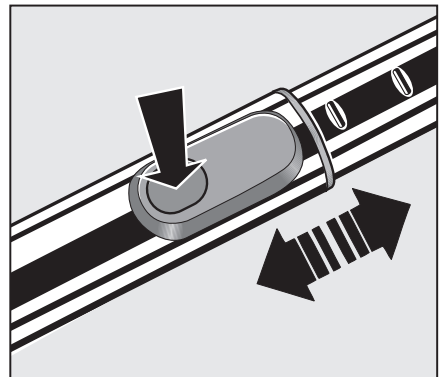
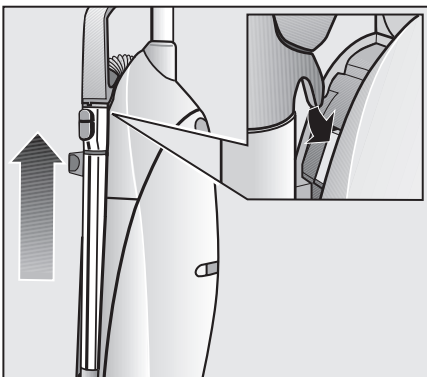

Using the vacuum cleaner / Maintenance

Included accessories



Lifting the head of the vacuum

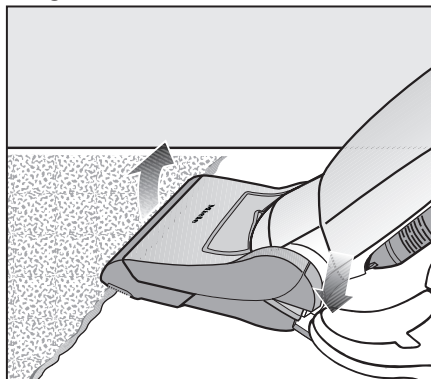

Airflow indicator

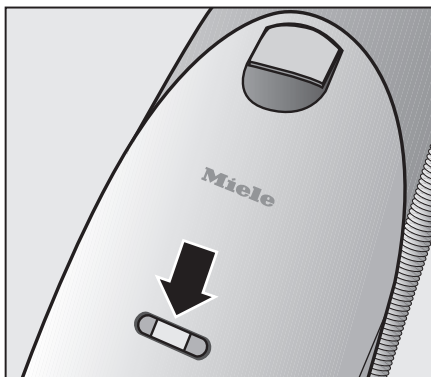

Opening the dust compartment

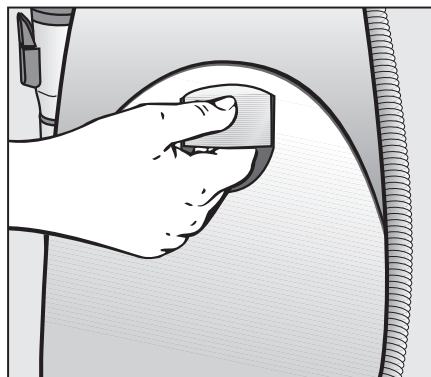

Releasing the dustbag

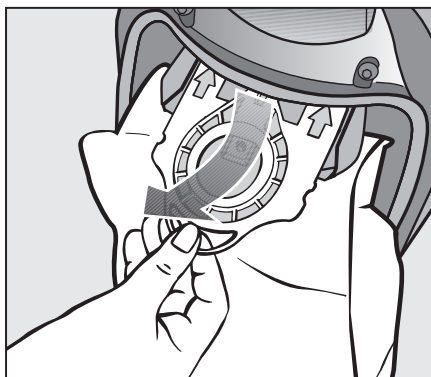

Inserting the dustbag

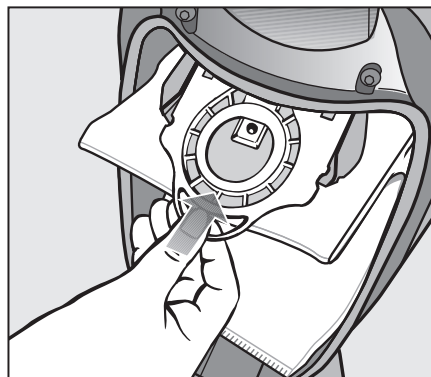

Please read the operating instructions to see how to change the exhaust filters.

Free Manuals Download Website

<http://myh66.com>

<http://usermanuals.us>

<http://www.somanuals.com>

<http://www.4manuals.cc>

<http://www.manual-lib.com>

<http://www.404manual.com>

<http://www.luxmanual.com>

<http://aubethermostatmanual.com>

Golf course search by state

<http://golfingnear.com>

Email search by domain

<http://emailbydomain.com>

Auto manuals search

<http://auto.somanuals.com>

TV manuals search

<http://tv.somanuals.com>