

Operating Instructions

Vacuum Cleaner
S183, S184

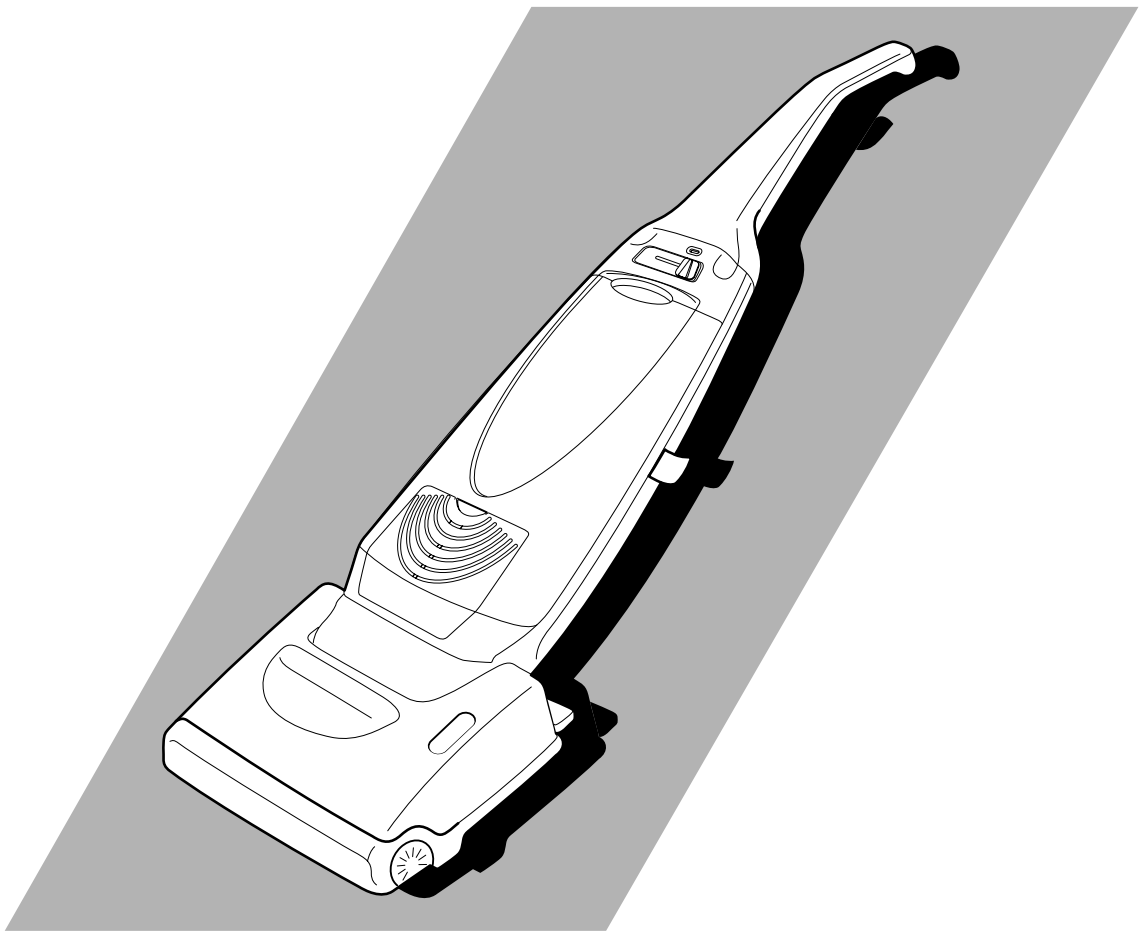

Miele[®]

Please carefully study these Operating Instructions before attempting to operate the unit and note the listed Important Safety Instructions.

IMPORTANT SAFETY INSTRUCTIONS

When using this vacuum cleaner, basic precautions should always be followed , including the following:

READ ALL INSTRUCTIONS BEFORE USING THIS VACUUM CLEANER

WARNING To reduce the risk of fire, electric shock, or injury:

- Do not leave vacuum cleaner unattended when it is plugged in. Unplug it from the outlet when not in use and before servicing.
- Electric shock could occur if used outdoors or on wet surfaces.
- Do not allow to be used as a toy. Close attention is necessary when used by or near children.
- Use only as described in this manual. Use only manufacturer's recommended attachments.
- Do not use with damaged cord or plug. If the vacuum cleaner is not working as it should, has been dropped, damaged, left outdoors, or dropped into water, bring it to a service center.
- Do not pull or carry by cord, use the cord as a handle, close a door on the cord, or pull the cord around sharp edges or corners. Do not run the vacuum cleaner over the cord. Keep the cord away from heated surfaces.
- Do not unplug by pulling on cord. To unplug, grasp the plug, not the cord.
- Do not handle the plug or vacuum cleaner with wet hands.
- Do not put any object into the openings. Do not use with any opening blocked. Keep openings free of dust, lint, hair, and anything that may block or reduce air flow.
- Keep hair, loose clothing, fingers, and all parts of body away from openings and moving parts.
- Do not pick up anything that is burning or smoking, such as cigarettes, matches or hot ashes.
- Do not use without dust bag and/or filters in place.
- Turn off all controls before unplugging.
- Use extra care when cleaning on stairs.
- Do not use to pick up flammable or combustible liquids such as gasoline or use in areas where they may be present.

SAVE THESE INSTRUCTIONS

THIS VACUUM CLEANER IS INTENDED FOR HOUSEHOLD USE ONLY

Notice- Before you plug in your Vacuum Cleaner, make sure that the voltage indicated on the rating plate located at the rear of the vacuum cleaner is the same as your local supply.

IDENTIFICATION OF MAIN PARTS

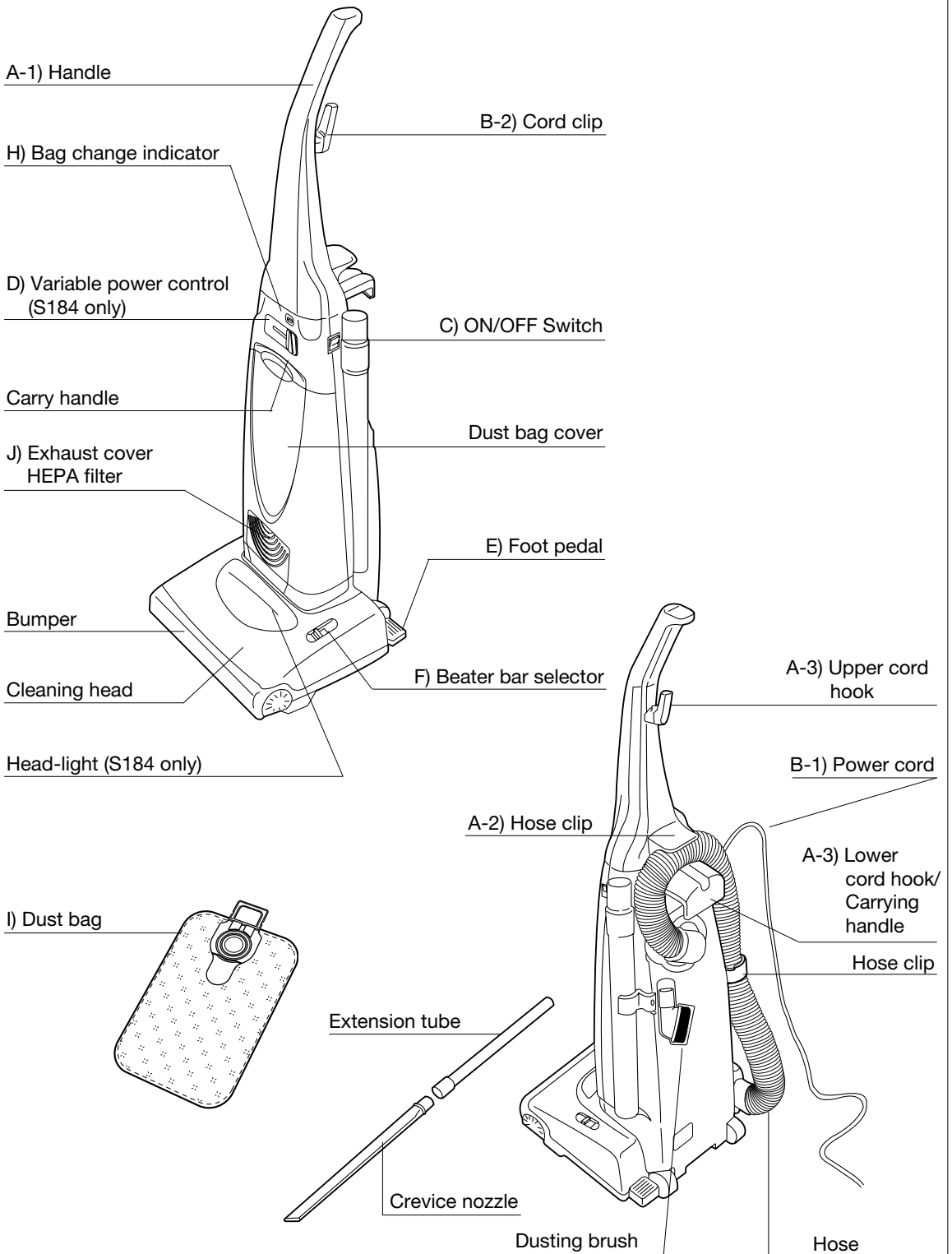

HOW TO ASSEMBLE / OPERATE YOUR CLEANER

A) HANDLE ASSEMBLY

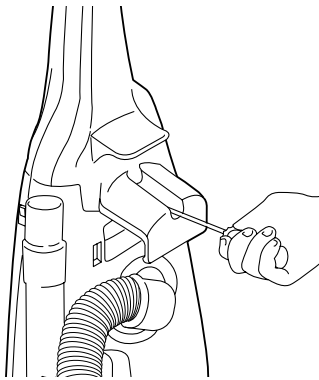

- 1) Insert the base of the handle into the top of the body of the machine as shown. Push down the handle and tighten the screw.

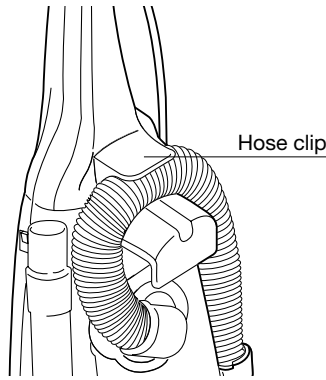

- 2) Set the hose around the hose clip.

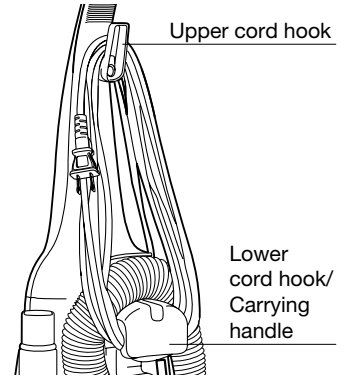

- 3) Turn the upper cord hook to the upright position and wind the power cord around the upper and lower cord hooks.

IMPORTANT: Do not over tighten the screw.

B) POWER CORD STORAGE

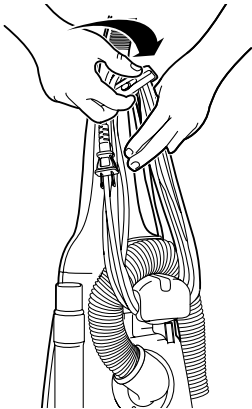

- 1) Turn the upper hook to release the power cord for instant use.

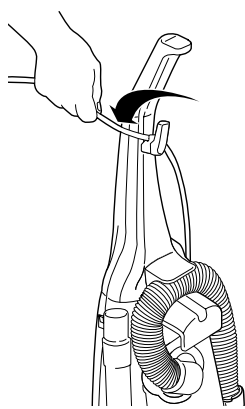

- 2) Set the power cord into the cord clip to help secure it during use

NOTE: To reduce the risk of electric shock, this appliance has a polarized plug (one blade is wider than the other). This plug will fit in a polarized outlet only one way. If the plug does not fit fully in the outlet, reverse the plug. If it still does not fit, contact a qualified electrician to install the proper outlet. Do not change the plug in any way.

To avoid any possible damage to the power cord, never run over the cord or allow it to become caught in the rotary brush.

C) ON / OFF SWITCH

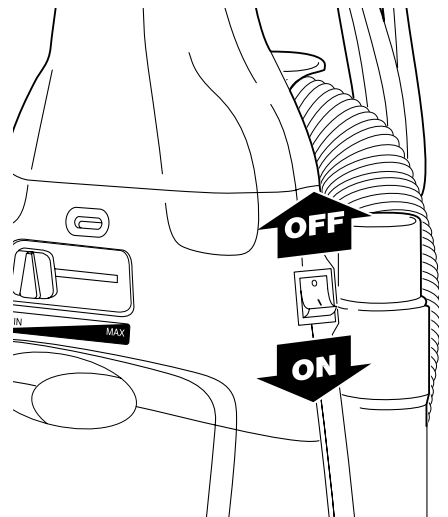

To start or stop the vacuum cleaner, push the switch to "I" to turn it **ON**, and to "O" to turn it **OFF**.

D) VARIABLE POWER CONTROL (S184 Only)

This vacuum cleaner incorporates a variable power control to allow you to select the power most suitable for your cleaning needs.

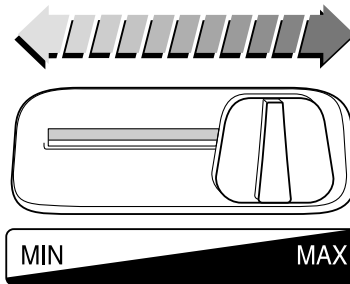

MIN: To clean curtains and soft furnishings with tool attached.

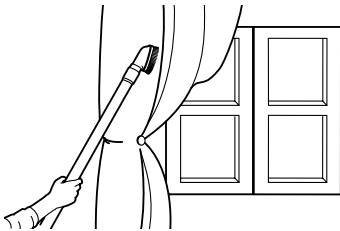

MAX: To continuously clean with high suction power.

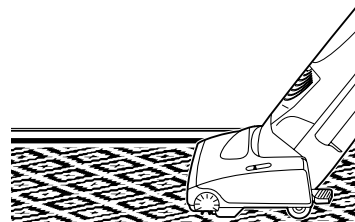

E) USING THE FOOT PEDAL TO ADJUST THE VACUUM HEIGHT

To lower the body of the cleaner, step on the pedal at the left rear corner of the vacuum cleaner.

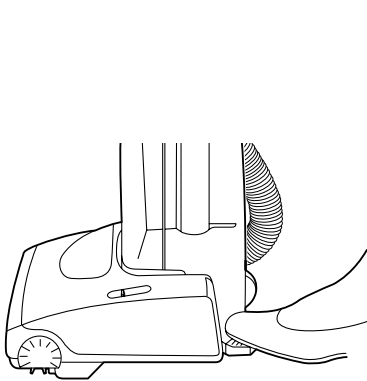

1. Upright position

The handle should be in an upright position when cleaning tools are used.

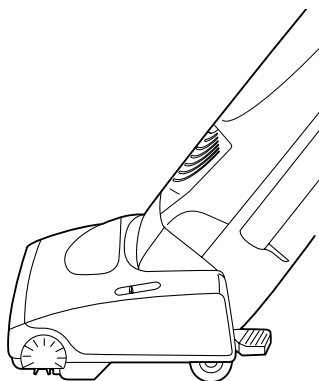

2. Middle position

For normal cleaning, press the foot pedal and pull back the handle to a comfortable angle.

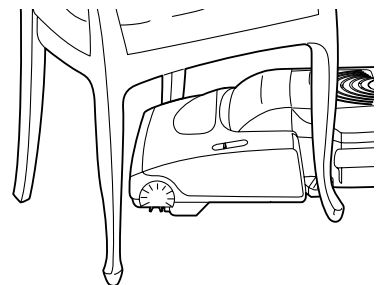

3. Low position

For cleaning under furniture, press the pedal a second time. The handle may now be lowered almost to the floor as shown.

F) BEATER BAR SELECTOR

When cleaning carpeted floor, slide the selector to the "BEATER BAR" position. To stop the beater bar while using accessories, slide the selector to the "STOP" position.

NOTE: The vacuum cleaner should be running when changing the position of the BEATER BAR SELECTOR.

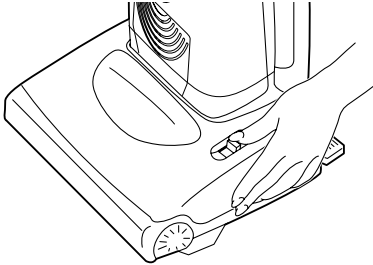

BEATER BAR ON OR OFF

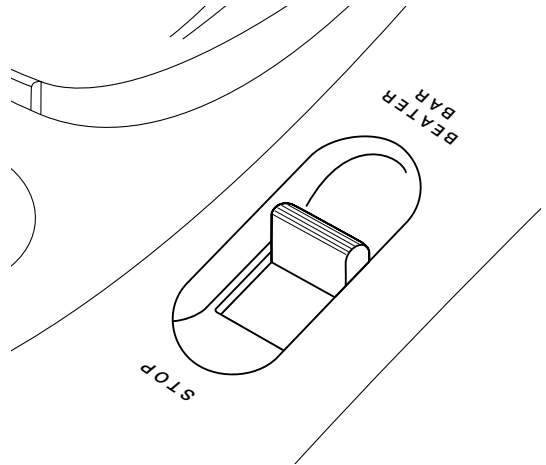

G) HOW TO USE THE ACCESSORIES

- 1) To use the accessories keep the vacuum cleaner upright and slide the BEATER BAR SELECTOR to the "STOP" position.
- 2) Pull the hose out of the intake port at the lower left of the vacuum, and release it from the hose clip. Connect the desired accessory as illustrated below.

NOTE: When finished using the accessory, re-insert the hose end into the intake port and place the hose under the clip. The accessories can also be returned to their storage locations.

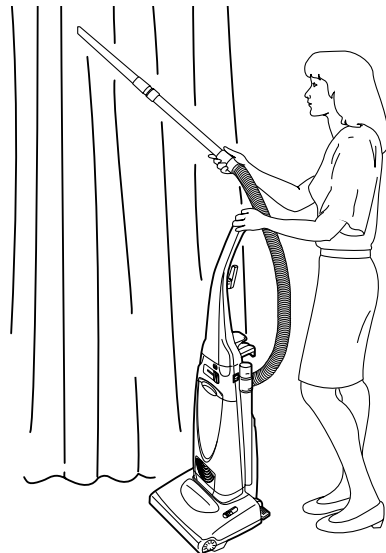
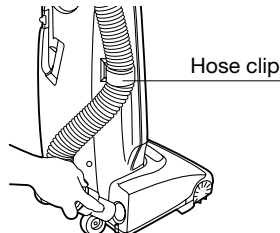
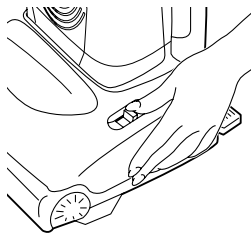

CAUTION: While using the accessories, hold the handle as shown above to avoid pulling the cleaner over.

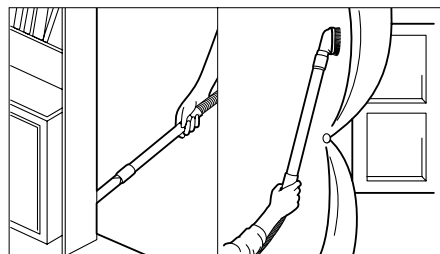
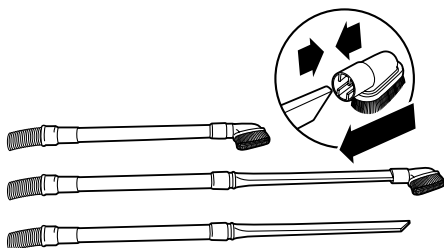

H) BAG CHANGE INDICATOR

The bag change indicator located on the front of your cleaner normally indicates when the dust bag should be changed. In order to maintain the best efficiency, it should be changed when the yellow mark appears in the window.

NOTE: if the yellow mark appears after the bag has been replaced, check to see if the hose or suction tube is clogged (see BLOCKAGES). Due to the smaller intake, the yellow mark may also appear when using the crevice tool.

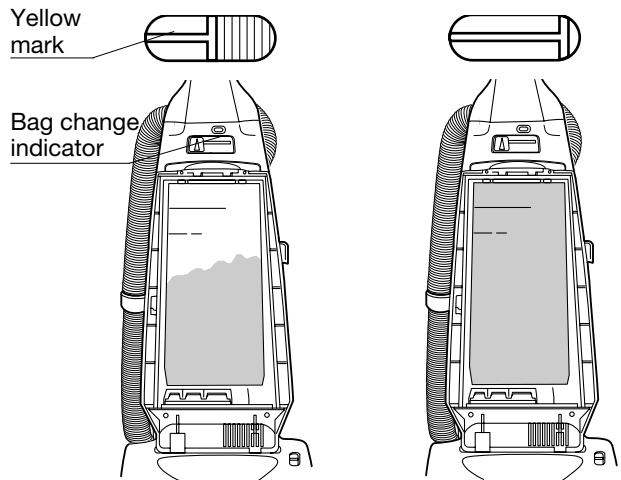

CAUTION: DISCONNECT THE CLEANER FROM THE OUTLET BEFORE PERFORMING THE OPERATIONS BELOW

I) REPLACING THE DUST BAG

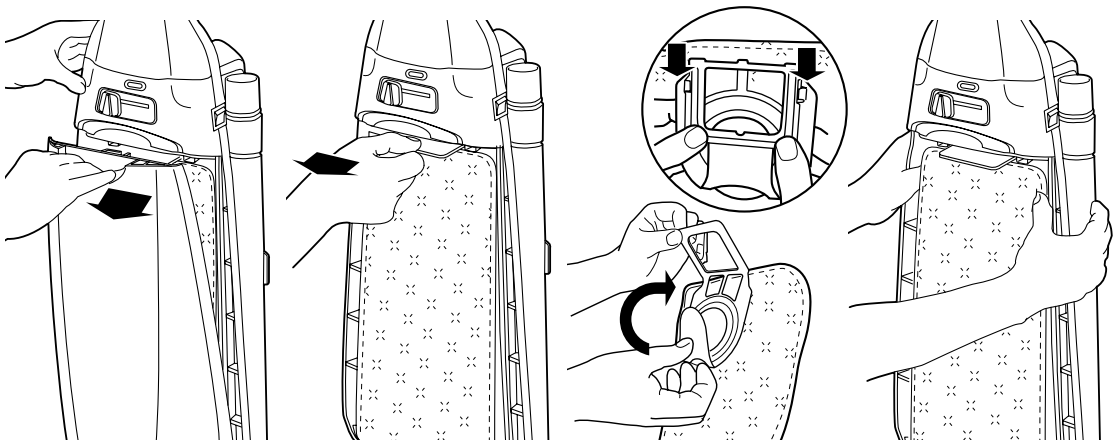

- 1) Remove the dust cover by pulling it forwards.
- 2) Grip the handle of the dust bag and pull the bag out of the dust compartment.
- 3) Close dust bag tab to avoid dust leakage and put it away.
- 4) Install the new dust bag by placing the hole over the exhaust port and pressing it into place as shown.

NOTE: If the dust bag is installed incorrectly, the dust cover will not close.

IMPORTANT: For maximum vacuum efficiency, dust bags should be changed regularly.

**We recommend the use of genuine Miele dust bags only
Part # 5294740 Type Z**

J) CHANGING FILTERS

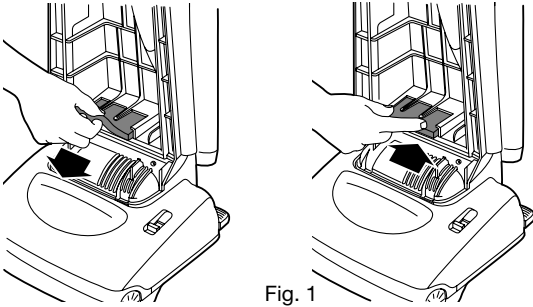

Fig. 1

In addition to the dust bag, the vacuum cleaner contains two filters; a central filter that protects the motor (fig.1) and a HEPA filter that removes particles from the exhausted air (fig.2). The HEPA filter should be changed every six months or whenever it becomes dirty. The central filter should be changed or rinsed out whenever the HEPA filter is replaced.

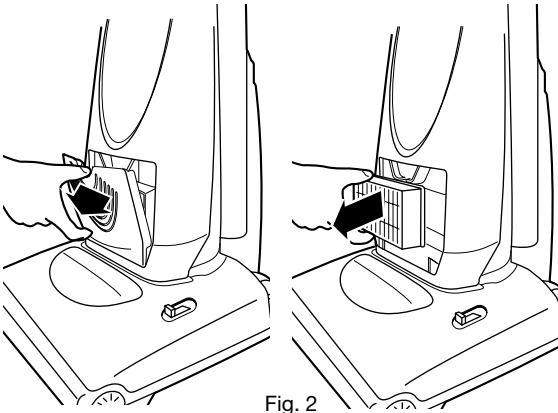

Fig. 2

CENTRAL FILTER (Fig. 1)

Part # F0391100

To remove, slide the central filter forward out of its housing.

IMPORTANT: If the central filter has been rinsed out, make sure it is dry before re-installing it.

HEPA FILTER (Fig. 2)

Part # S02Z6000

To change the HEPA filter.

- 1) Remove the exhaust cover.
- 2) Take out the HEPA filter and replace with a new one.

IMPORTANT: Do not forget to re-install the filters before use.

TROUBLE SHOOTING GUIDE

Before returning the vacuum cleaner to a Miele Service Center, check the following items:

Problem	Check Point	Cause / Remedy
Motor doesn't run. (no noise is heard at all)	<ul style="list-style-type: none"> • Cord connection. 	<ul style="list-style-type: none"> • Plug cord into outlet correctly.
Motor runs but no suction.	<ul style="list-style-type: none"> • Hose inlet clogged. • Check the bag change indicator. • Dust bag broken or clogged. • Central filter. 	<ul style="list-style-type: none"> • If there is a clog, remove it. • If it shows full, replace the dust bag. • If the dust bag is broken, replace it. • If the central filter is full of dust, clean or replace it.
Beater bar does not rotate.	<ul style="list-style-type: none"> • Beater bar selector. • Beater bar / housing. • Belt broken or loose. 	<ul style="list-style-type: none"> • Select the correct position. • If there is an obstruction, remove it. • Replace the belt.

IMPORTANT NOTE: Before replacing any part always, DISCONNECT THE CLEANER FROM THE ELECTRICAL SUPPLY.

BLOCKAGES

If your cleaner stops picking up dust, or the Bag Change Indicator shows "Full" while the dust bag is still empty, a blockage may have occurred.

To remove the obstruction, proceed as follow:

Remove the hose from the suction inlet by turning the hose to the right and pulling it out (Fig. 1). Clear any obstruction from the hose and/or suction inlet using a blunt instrument, taking care not to damage the hose. If the obstruction occurs in the suction pipe, it can be removed with care as shown in Fig. 2.

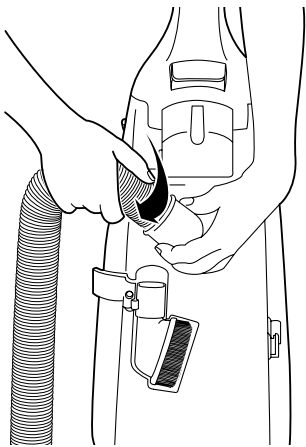

Fig. 1

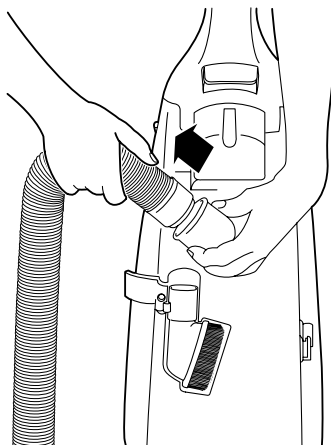

Fig. 2

Suction pipe inlet

MAINTENANCE FOR THE BEATER BAR

DO NOT USE YOUR FINGERS OR HANDS TO REMOVE OR CLEAN THE BEATER BAR.

When it is necessary to remove thread, string, hair etc., which has wound around the beater bar, cut across them with a pair of scissors, making sure not to cut the brush.

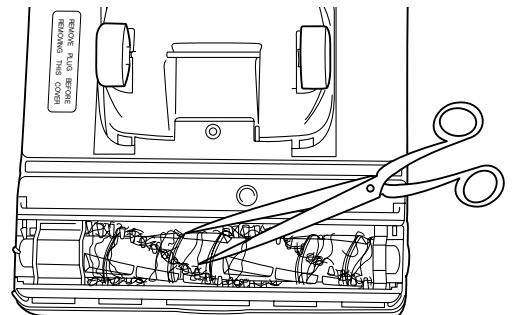
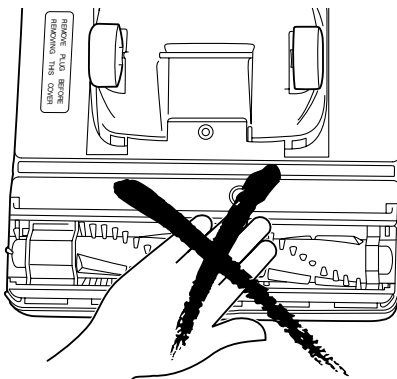

SERVICING AND REPAIRS

Use only genuine Miele replacement parts.

DISCONNECT THE CLEANER FROM THE ELECTRICAL SUPPLY

If you have any questions, contact your local dealer / service agent.

Any service needed other than that described in these Operating Instructions should be performed by a Miele Service Center, only.

To replace any of the following parts, place the vacuum cleaner in the horizontal position by using the pedal. Then turn it over exposing the underside.

HOW TO REPLACE - DRIVE BELT (Part # S01Z6000) AND BEATER BAR ASSEMBLY (Part # R98Z6064)

1. Remove the 4 screws from the base plate and lift it off. (Fig. 1)
2. Release the belt from the motor shaft and lift the beater bar assembly to remove the belt. (Fig. 2)
3. To reassemble the beater bar, return the belt to the motor shaft and beater bar pulley. Re-insert the bar into its supports and turn the beater bar to ensure that the belt is seated correctly. (Fig. 3)
4. Replace the base plate, and re-fasten the screws securely.

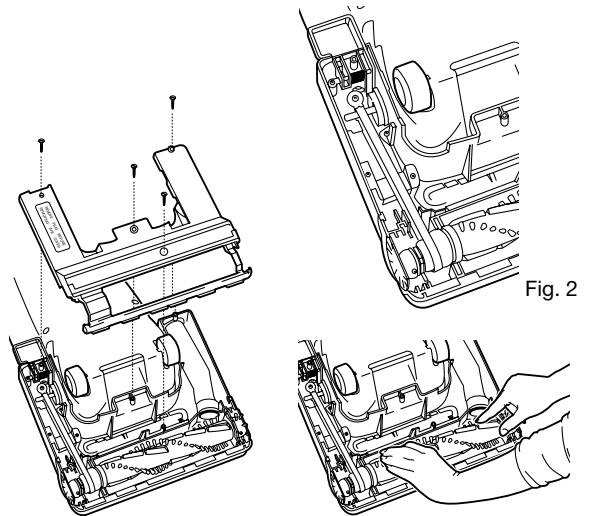

Fig. 1

Fig. 2

Fig. 3

HOW TO REPLACE - BEATER BAR / SIDE BRUSHES / SHAFT SUPPORT A-B

1. First remove the base plate, drive belt and beater bar assembly (as illustrated above).
2. Remove the 2 screws at both ends of the beater bar assembly and separate the different parts as shown in the exploded view.
3. Replace any damaged part and reassemble in the reverse order.

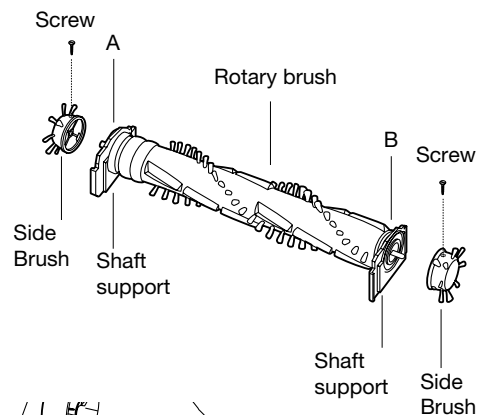

REPLACING THE HEAD-LIGHT BULB (S184 only)

1. Remove the base plate, release the head-light assembly and lift it off. (Fig. 1)
2. Remove the old bulb, and replace it with a new one (Fig. 2)
(Consult your dealer / service agent for a suitable replacement bulb).
3. Re-insert the head-light assembly and the base plate.

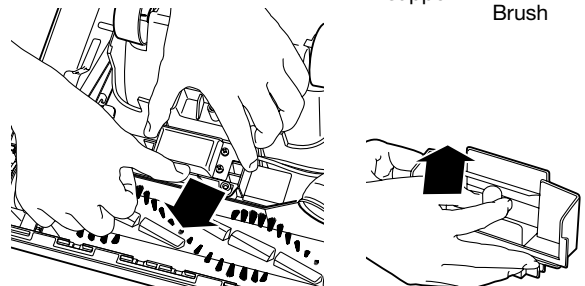

Fig. 1

Fig. 2

CORD CARE

To avoid damaging the power cord, never run over the cord or allow it to become caught in the beater bar when using the vacuum cleaner.

Hold any excess cord in your free hand while vacuuming in order to avoid running over the cord.

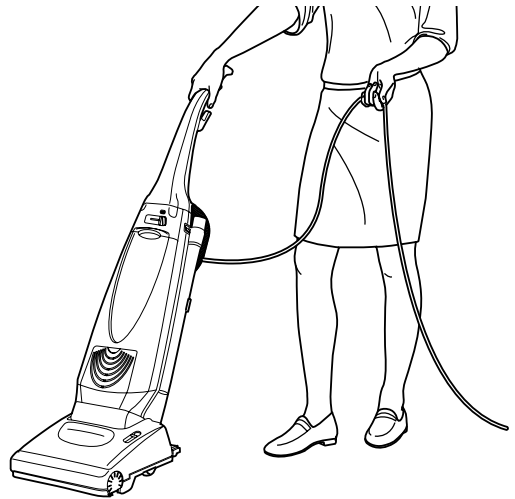
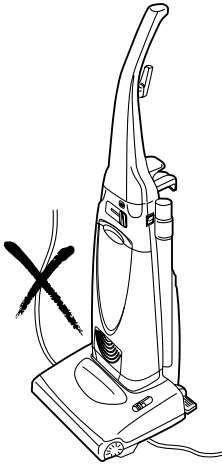

STORING THE APPLIANCE

To store the vacuum:

- 1) Return the vacuum cleaner to the upright position.
- 2) Turn off the vacuum cleaner.
- 3) Unplug it from the electrical supply.
- 4) Replace the hose and accessories.
- 5) Store the cord as outlined in "POWER CORD STORAGE".

Store the cleaner away from heat sources, such as radiators, fires or direct sunlight.

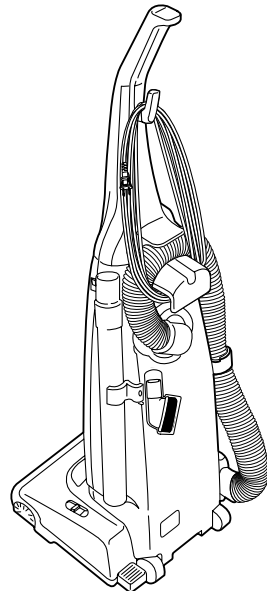



National Headquarters

MIELE, INC.

9 INDEPENDENCE WAY

PRINCETON, NJ 08540

Phone: (609) 419-9898

or (800) 843-7231

Fax: (609) 419-4298

www.miele.com

Showroom Locations

National Headquarters

Miele, Inc.

9 Independence Way

Princeton, NJ 08540

Phone: (609) 419-9898

Fax: (609) 419-4298

Southwest

Miele, Inc.

1400 Turtle Creek Boulevard

Suite 177

Dallas, TX 75207

Phone: (214) 752-9000

Fax: (214) 752-6307

MidWest

Miele, Inc.

3100 West Dundee Road

Suite 901

Northbrook, IL 60062

Phone: (847) 714-9433

Fax: (847) 714-9434

Southeast

Miele, Inc.

7680 Nort Federal Highway

Boca Raton, FL 33487

Phone: (561) 995-8030

Fax: (561) 995-8083

West Coast

Sierra Showroom

Sobel Building

680 Eighth Street

Suite 169-A

San Francisco, CA 94103

Phone: (415) 241 68 20

Fax: (415) 241 73 17

Southern California

Miele, Inc.

Southern California Showroom

189 North Robertson Blvd

Beverly Hills, CA 90211

Phone: (310) 855-9470

Fax: (310) 358-0238

New England

Miele, Inc.

New England Showroom

555 Washington Street

Wellesley, MA 02482

Phone: (781) 431-2225

Fax: (781) 431-0003

Toll free (Wellesley area only):

(877) 53 MIELE (64353)

Canadian Head Office

MIELE, LTD

55G East Beaver Creek Road

Richmond Hill

Ontario, L4B 1ES

Téléphone: (800) 565-6435

Téléphone: (905) 707-1171

Fax: (905) 707-0177

Showroom Locations

Quebec

Miele, Ltd

400 Laurier Ave, West

Suite 600

Montreal, Quebec H2V 2K7

Téléphone: (877) 635-4353

ou (514) 277-1818

Fax: (514) 277-1838

British Columbia

Miele, Ltd

3731 North Fraser Way

Unit 200

Burnaby, British Columbia V5J 5J2

Téléphone: (604) 434-1300

Fax: (604) 434-1309

Free Manuals Download Website

<http://myh66.com>

<http://usermanuals.us>

<http://www.somanuals.com>

<http://www.4manuals.cc>

<http://www.manual-lib.com>

<http://www.404manual.com>

<http://www.luxmanual.com>

<http://aubethermostatmanual.com>

Golf course search by state

<http://golfingnear.com>

Email search by domain

<http://emailbydomain.com>

Auto manuals search

<http://auto.somanuals.com>

TV manuals search

<http://tv.somanuals.com>