

# Operating and installation instructions

## Cooker hood

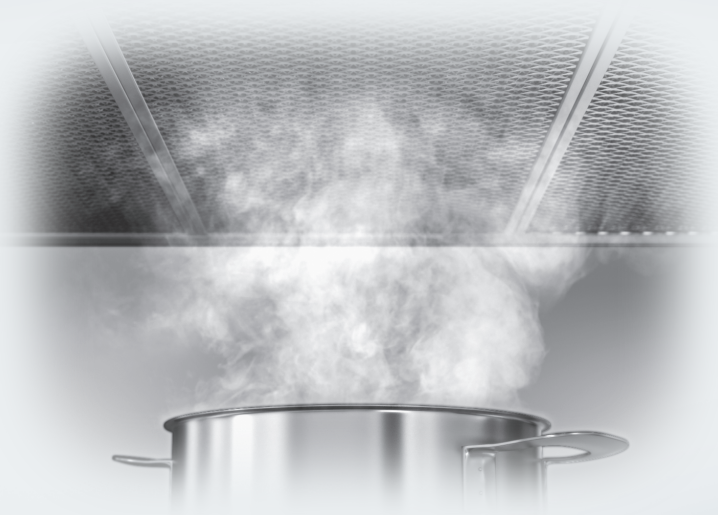

To prevent the risk of accidents or damage to the appliance, it is **essential** to read these instructions before it is installed and used for the first time.

# Contents

---

<b>Warning and Safety instructions</b> .....	4
<b>Caring for the environment</b> .....	13
<b>Modes of operation</b> .....	14
Con@ctivity 2.0 function .....	15
<b>Guide to the appliance</b> .....	16
<b>Operation (Automatic mode)</b> .....	18
Cooking with Con@ctivity 2.0 (Automatic mode).....	18
Leaving automatic mode temporarily.....	20
Returning to automatic mode .....	20
<b>Operation (Manual mode)</b> .....	21
Cooking without Con@ctivity 2.0 (Manual mode) .....	21
Switch the fan on .....	21
Select the power level.....	21
Selecting the run-on time.....	21
Switching the fan off .....	21
Switching the hob lighting on/off.....	21
Power management .....	22
<b>Operation (Automatic and Manual modes)</b> .....	23
Operating hours counters .....	23
Altering the operating hours counter for the grease filters .....	23
Activating and altering the charcoal filter operating hours counter .....	24
Reading the filter operating hours counter .....	24
<b>Energy saving tips</b> .....	25
<b>Cleaning and care</b> .....	26
Casing .....	26
Important for appliances with glass surfaces .....	26
Grease filter .....	27
Charcoal filter.....	29
Resetting the charcoal filter operating hours counter.....	30
Disposing of the charcoal filter .....	30
<b>Installation</b> .....	31
Before installation .....	31
Protective foil .....	31
Installation instructions .....	31
Assembly parts .....	32
Appliance dimensions.....	34

# Contents

---

Safety distance between hob and cooker hood (S).....	35
Installation recommendations.....	36
<b>Connection for air extraction</b> .....	37
Condensate trap .....	38
Silencer .....	38
<b>Electrical connection</b> .....	40
<b>Activating Con@ctivity 2.0</b> .....	41
Installing the Con@ctivity 2.0 Stick.....	41
Activating Con@ctivity 2.0 .....	41
Activating the cooker hood.....	41
Activating the hob.....	42
Activation failed .....	42
Deactivating Con@ctivity 2.0 .....	42
<b>After Sales / Guarantee</b> .....	43
Position of the data plate .....	43
<b>Technical data</b> .....	44
Conformity declaration.....	44
Data sheet for domestic cooker hoods .....	45
Data sheet for domestic cooker hoods .....	46

## Warning and Safety instructions

---

This appliance complies with all relevant local and national safety requirements. Inappropriate use can, however, lead to personal injury and damage to property.

To avoid the risk of accidents and damage to the appliance, please read these instructions carefully before using it for the first time. They contain important notes on the safety, installation, use and maintenance of the appliance. Miele cannot be held liable for non-compliance with these instructions.

Keep these instructions in a safe place and ensure that all users are familiar with the contents. Pass them on to any future owner of the appliance.

### Correct application

- ▶ This cooker hood is intended for use in domestic households and similar working and residential environments.
- ▶ The cooker hood is not intended for outdoor use.
- ▶ It must only be used as a domestic appliance to extract vapours and remove odours from cooking. Any other usage is not supported by the manufacturer and could be dangerous.
- ▶ Where a recirculation cooker hood is fitted above a gas hob, please ensure that there is an adequate supply of fresh air into the room in which it is installed. Please seek the advice of a qualified gas fitter (e.g. GasSafe in the UK) if necessary.

▶ The cooker hood can only be used by people with reduced physical, sensory or mental capabilities, or lack of experience and knowledge, if they are supervised whilst using it, or have been shown how to use it in a safe way and recognise and understand the consequences of incorrect operation.

### **Safety with children**

▶ Children under 8 years of age must be kept away from the cooker hood unless they are constantly supervised.

▶ Children 8 years and older may only use the cooker hood unsupervised if they have been shown how to use it safely and recognise and understand the consequences of incorrect operation.

▶ Children must not be allowed to clean or maintain the cooker hood unsupervised.

▶ Please supervise children in the vicinity of the cooker hood and do not let them play with it.

▶ Danger of suffocation. Packaging, e.g. plastic wrappings, must be kept out of the reach of babies and children. Whilst playing, children could become entangled in packaging or pull it over their head and suffocate.

### **Technical safety**

▶ Unauthorised installation, maintenance and repairs can cause considerable danger for the user. Installation, maintenance and repairs must only be carried out by a Miele authorised technician.

▶ A damaged appliance can be dangerous. Check it for visible signs of damage. Do not use a damaged appliance.

▶ The electrical safety of this appliance can only be guaranteed when correctly earthed. It is essential that this standard safety requirement is met. If in any doubt please have the electrical installation tested by a qualified electrician.

## Warning and Safety instructions

---

- ▶ Reliable and safe operation of this cooker hood can only be assured if it has been connected to the mains electricity supply.
- ▶ Before connecting the appliance to the mains supply, ensure that the connection data on the data plate (voltage and frequency) match the mains electricity supply. This data must correspond in order to avoid the risk of damage to the appliance. Consult a qualified electrician if in any doubt.
- ▶ Do not connect the appliance to the mains electricity supply by a multi-socket unit or an extension lead. These are a fire hazard and do not guarantee the required safety of the appliance.
- ▶ For appliances with an external motor fitted (...EXT models) the connection of the two units must be made using the connection cable and the plug connectors.  
These models may only be combined with a Miele external motor.
- ▶ For safety reasons, this appliance may only be used after it has been built in.
- ▶ The cooker hood must not be used in a non-stationary location (e.g. on a ship).
- ▶ Tampering with electrical connections or components and mechanical parts is highly dangerous to the user and can cause operational faults.  
Only open the housing as described in the instructions given in the installation sheet and in the Cleaning and care section of this booklet. Under no circumstances should any other parts of the housing be opened.
- ▶ The manufacturer's warranty will be invalidated if the appliance is not repaired by a Miele approved service technician.
- ▶ Miele can only guarantee the safety of the appliance when genuine original Miele replacement parts are used. Faulty components must only be replaced by Miele spare parts.

## Warning and Safety instructions

---

- ▶ If the electrical connection cable is faulty it must only be replaced by a Miele authorised service technician to protect the user from danger.
- ▶ During installation, maintenance and repair work, the appliance must be disconnected from the mains electricity supply.

# Warning and Safety instructions

Using at the same time as other heating appliances that depend on the air from the room

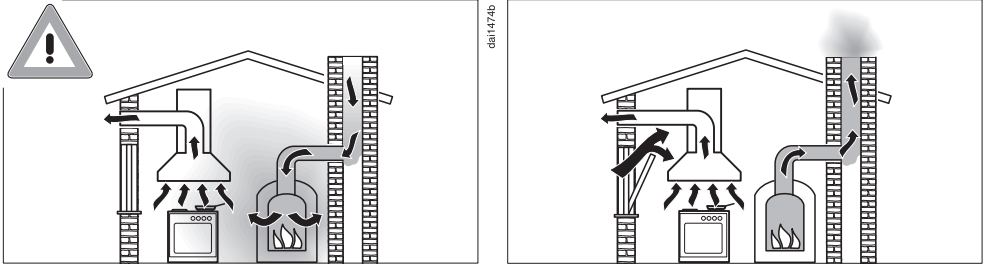

## ⚠ Warning - danger of toxic fumes

Great care should be taken when using the cooker hood at the same time and in the same room or area of the house as another heating appliance which depends on the air in the room.

Such appliances include gas, oil, wood or coal-fired boilers and heaters, continuous flow or other water heaters, gas hobs, cookers or ovens which draw air in from the room and duct exhaust gases out through a chimney or extraction ducting.

When used in extraction mode, with or without an external motor fitted, or in recirculation mode with a recirculation box installed outside the room, the appliance draws air in from the room in which it is installed and from neighbouring rooms.

If there is insufficient air, an underpressure will occur. The heating appliance will be starved of oxygen, impairing combustion. Harmful gases could be drawn out of the chimney or extraction ducting back into the room, with potentially fatal consequences.



## Warning and Safety instructions

In order to ensure safe operation, and to prevent gases given off by the heating appliances from being drawn back into the room when the cooker hood and the heater are in operation simultaneously, an underpressure in the room of 0.04 mbar (4 pa) is the maximum permissible.

Ventilation can be maintained by air inlets which cannot be blocked, in windows, doors or outside wall vents, or by other technical measures, such as ensuring that the cooker hood can only be switched on when the heating appliance is switched off or vice versa. A ventilation brick alone is not generally sufficient to ensure safe ventilation.

The overall ventilation condition of the dwelling must be taken into account. If in any doubt, the advice of a competent builder or, for gas a qualified gas fitter (registered with an official gas safety body in accordance with national safety regulations, GasSafe in the UK) must be sought.

If the cooker hood is used in recirculation mode, where the air is directed back into the room in which it is located, operating a heating appliance which depends on the room air at the same time is no cause for concern.

## Warning and Safety instructions

---

### Correct use

- ▶ Never use a naked flame beneath the cooker hood. To avoid the danger of fire, do not flambé or grill over a naked flame. When switched on, the cooker hood could draw flames into the filter. Fat deposits could ignite, presenting a fire hazard.
- ▶ The cooker hood can become damaged when exposed to excessive heat.
  - When using the cooker hood over a gas hob, ensure that any burners in use are always covered by a pan. Switch the cooking zone off when a pan is removed, even for a short time.
  - Select a pan which is suitable for the size of the burner.
  - Regulate the flame so that it does not burn up the sides of the pan.
  - Avoid overheating the pan (e.g. when cooking with a wok).
- ▶ Always switch the cooker hood on when a cooking zone is in use, otherwise condensation may collect in the hood, which could cause corrosion.
- ▶ When cooking with oil or fat, chip pans and deep fat fryers etc, do not leave the pans unattended. Never leave an open grill unattended when grilling. Overheated oil and fat can ignite and could set the cooker hood on fire.

## Warning and Safety instructions

---

- ▶ Do not use the cooker hood without the filters in place. This way you will avoid the risk of grease and dirt getting into the appliance and hindering its smooth operation.
- ▶ There is a risk of fire if the cooker hood is not cleaned as described in these operating instructions.
- ▶ The cooker hood can get very hot during cooking due to heat rising from the hob.  
Do not touch the housing or the grease filters until the cooker hood has cooled down.

### Correct installation

- ▶ Refer to the cooker or hob manufacturer's instructions as to whether a cooker hood may be operated above the cooker/hob.
- ▶ Safety regulations prohibit the fitting of a cooker hood over solid fuel stoves.
- ▶ Insufficient distance between the cooker or hob and the cooker hood can result in damage to the hood.  
The minimum safety distances between the top of the cooker or hob and the bottom of the cooker hood given in the "Installation" section must be maintained, unless the hob manufacturer states that a greater distance is required.  
If more than one cooking appliance is fitted beneath the cooker hood, and they have different minimum safety distances to the cooker hood, select the greater distance.
- ▶ The distances given in "Installation" must be observed when fitting the cooker hood.

## Warning and Safety instructions

---

- ▶ Exhaust ducting must be of non-inflammable material. Suitable material is available from Miele specialist dealers or the Miele Spares Dept.
- ▶ The appliance must not be connected to a chimney or flue which is in use. Neither should it be connected to ducting which ventilates rooms with fireplaces.
- ▶ If exhaust air is to be extracted into a chimney or ventilation duct no longer used for other purposes, seek professional advice.

### Cleaning and care

- ▶ Do not use a steam cleaning appliance to clean this appliance. The steam could reach electrical components and cause a short circuit.
- ▶ You could injure yourself on the open vapour canopy. Only open it when necessary.

### Accessories

- ▶ Only use genuine original Miele accessories with this appliance. Using accessories from other manufacturers will invalidate the guarantee, and Miele cannot accept liability.

### Disposal of the packing material

The packaging is designed to protect the appliance from damage during transportation. The packaging materials used are selected from materials which are environmentally friendly for disposal and should be recycled.

Recycling the packaging reduces the use of raw materials in the manufacturing process and also reduces the amount of waste in landfill sites.

### Disposal of your old appliance

Electrical and electronic appliances often contain valuable materials. They also contain materials which, if handled or disposed of incorrectly, could be potentially hazardous to human health and to the environment. They are, however, essential for the correct functioning of your appliance. Please do not therefore dispose of it with your household waste.

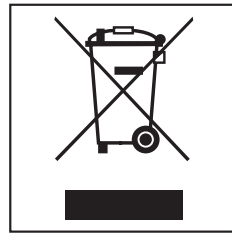

Please dispose of it at your local community waste collection / recycling centre or contact your Dealer for advice.

Ensure that it presents no danger to children while being stored for disposal.

# Modes of operation

Depending on the model of the cooker hood, the following options are available:

## Extraction mode

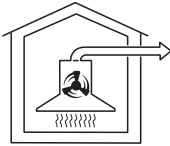

da10094a

The air is drawn in and cleaned by the grease filter and directed outside.

## Non-return flap

The non-return flap is designed to prevent the exchange of room and outside air taking place.

The flap is closed when the cooker hood is switched off.

When the cooker hood is switched on, the non-return flap opens for the cooking vapours to be blown directly outside.

If the on-site ventilation system does not have a non-return flap, the non-return flap supplied must be fitted in the exhaust socket in the motor unit.

## Recirculation mode

Recirculation mode cooker hoods require charcoal filters. These are available as optional accessories: see "Technical Data".



da10094b

The air is drawn in and cleaned first by the grease filter and then by a charcoal filter. The cleaned air is then recirculated back into the kitchen.

## Operation with an external motor

(...EXT model cooker hoods)

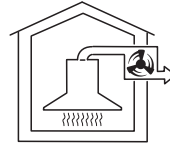

da10094c

Cooker hoods set up for operation with an external motor have to be connected to a Miele external motor located in a suitable position outside the room in which the cooker hood is installed. The external motor is linked to the cooker hood via a connection cable and then operated using the controls on the cooker hood.

## Con@ctivity 2.0 function

### Automatic control

The cooker hood has a communication facility which enables the automatic operation of the cooker hood depending on the operational state of the hob.

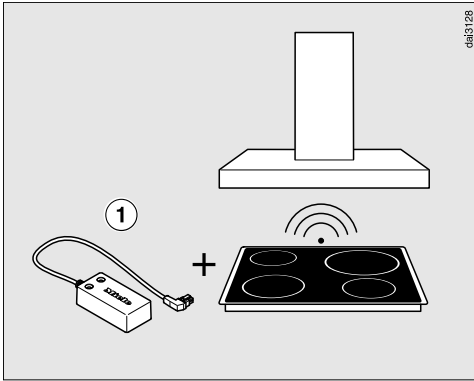

To make use of the communication facility the hob must be fitted with a Con@ctivity 2.0 Stick ①.

Refer to the installation instructions for the Con@ctivity 2.0 Stick to check whether it is compatible with your hob.

To use the Con@ctivity 2.0 function, a wireless connection must be established between the hob and the cooker hood (see "Activating Con@ctivity 2.0").

The hob transmits information about its operational status via a wireless signal to the cooker hood.

- When the hob is switched on, the hob lighting comes on independently and then after a short time the fan also comes on.
- During cooking the cooker hood automatically sets the power level according to the number of cooking zones in operation and their power levels.
- After switching the hob off the fan and the hob lighting will switch off automatically after a specified period of time.

See "Operation" for detailed information about this function.

# Guide to the appliance

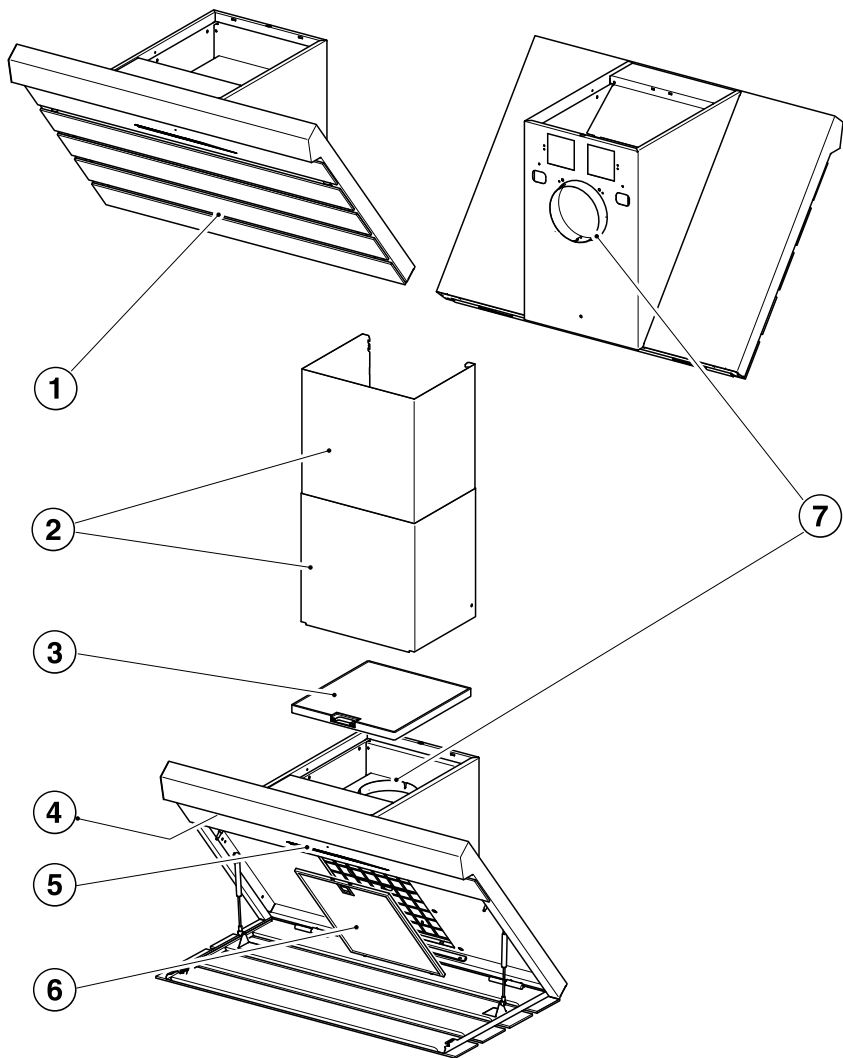

8

9

10

11

12

13



- ① Drop-down vapour canopy
- ② DADC 6000 tower  
Available as an optional accessory for concealing extraction ducting to the ceiling.
- ③ Charcoal filter  
Accessory required for recirculation mode
- ④ Hob lighting
- ⑤ Controls  
The symbols act as sensor controls. To select a function, touch the control. An audible tone sounds briefly to confirm selection.
- ⑥ Grease filter
- ⑦ Exhaust socket  
Extraction ducting can be directed through the back of the cooker hood or upwards to the ceiling.
- ⑧ Sensor control for switching the fan on and off
- ⑨ Sensor control for hob lighting
- ⑩ Sensor controls for selecting the fan power level
- ⑪ Sensor control for the run-on option
- ⑫ Operating hours sensor control for the grease filter
- ⑬ Operating hours sensor control for the charcoal filter

# Operation (Automatic mode)

When Con@ctivity 2.0 is activated, the cooker hood always works in automatic mode (see "Activating Con@ctivity 2.0").

To operate the cooker hood manually, see "Cooking without Con@ctivity 2.0".

## Cooking with Con@ctivity 2.0 (Automatic mode)

- Switch a cooking zone on at the power level you want.

The cooker hood lighting will come on.

After a few seconds the fan will come on, first at power level **2**, then it will switch immediately to power level **1**.

The cooker hood selects the power level automatically during cooking.

This is determined by the total output of the hob, i.e, the number of cooking zones in operation and the power levels selected.

- If you select a higher power level or are using several cooking zones, the cooker hood will switch to a higher power level.
- When you reduce the power level or the number of cooking zones on the hob, the cooker hood power level is also reduced.

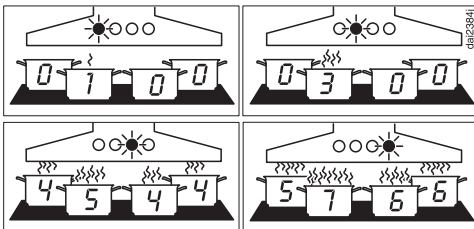

Examples for power levels 1 to 4

## Reaction time

The cooker hood reacts with a slight delay because altering the power level on the hob does not immediately result in a reduction or increase in cooking vapours.

Because the hob transmits the information to the cooker hood at intervals, this can also cause delays.

The reaction can vary from a few seconds to a couple of minutes.

## Cooking process

- If for example you switch on a cooking zone at the highest power level to heat a pan for frying and reduce the power level after approx. 60 to 90 seconds\*, a cooking process is recognised (\*60 seconds to 5 minutes for a HiLight hob).

The cooker hood switches itself on and when the hob power level has been reduced, the hood switches to power level 3 and remains at that level for approx. 5 minutes.

After that the cooker hood power level is determined automatically by the Con@ctivity function.

- You can select another power level manually before then.

## Switching off

- Switch off all cooking zones.

The cooker hood fan will reduce its power level over the next few minutes and will eventually switch itself off.

This helps to neutralise any lingering vapours and odours in the air.

- From the intensive setting 4, the fan switches immediately to level 3.
- If the fan is operating at level 3, it will switch to level 2 after approx. 1 minute.
- From level 2, the fan switches to level 1 after 2 minutes.
- After 2 minutes at level 1 the fan switches itself off.
- After another 30 seconds the lighting switches off.

The cooking process is then finished.

# Operation (Automatic mode)

---

## Leaving automatic mode temporarily

To leave automatic mode temporarily during cooking:

- Manually select a different power level, or
- Manually switch the cooker hood off, or
- Activate the run-on option  on the cooker hood. The fan will switch off after the selected time and the lighting remains switched on.

The cooker hood can now be operated manually (see "Cooking without Con@ctivity 2.0").

## Returning to automatic mode

The cooker hood returns to automatic mode:

- if the cooker hood has not been used for approx. 5 minutes after selecting a power level manually, or
- if the manually selected fan power level corresponds to the automatic one again, or
- if the cooker hood fan and the hob have been switched off for at least 30 seconds.  
Automatic mode will resume next time the hob is switched on.
- If you wish to operate the cooker hood manually for a complete cooking process, switch on the cooker hood fan **before** switching on the hob.  
If the cooker hood and the hob have been switched off for at least 30 seconds after cooking, automatic mode will resume the next time the hob is switched on.

## Cooking without Con@ctivity 2.0 (Manual mode)

The cooker hood can be operated manually if:

- Con@ctivity 2.0 is not activated.
- You have temporarily deactivated Con@ctivity 2.0 (see "Leaving automatic mode temporarily").

## Switch the fan on

- Touch the On/Off control ①.

The fan will come on at power level **2**.

## Select the power level

For light to heavy cooking vapours and odours, select from power levels **1** to **3**.

When frying or cooking food with a very strong aroma, select the Intensive setting **IS**.

- Select the power level required by touching a control from **1** to **IS**.





## Reducing power on the intensive setting

If Power management is activated (default), the fan automatically switches to level **3** after 5 minutes.

## Selecting the run-on time

It is advisable to run the fan for a few minutes after cooking has finished to neutralise any lingering vapours and odours in the air.

With the run-on option the fan switches itself off automatically after a pre-selected time.

- After you have finished cooking, touch the run-on option control .
- Once: the fan will switch itself off after 5 minutes (**5**  lights up).
- Twice: The fan will switch itself off after 15 minutes ( **15** lights up).
- If you touch the run-on option control  again, the fan will remain on (**5**  **15** will go out).

## Switching the fan off

- Use the On/Off control ① to switch the fan off.

## Switching the hob lighting on/off

The hob lighting can be switched on and off independently of the fan.

- Touch the hob lighting control .

# Operation (Manual mode)

---

## Power management



The cooker hood features a power management system to help save energy. The fan power level is reduced and the lighting is switched off automatically.

- If the Intensive setting is selected, the fan automatically switches to level 3 after 5 minutes.
- From levels 3, 2 or 1 the power will be reduced by one level after 2 hours and then in 30 minutes stages until the fan finally switches off.
- The hob lighting will switch off automatically after 12 hours.

You can deactivate Power management.

This can however result in increased electricity consumption.

## Switching Power management on/off

- Switch off the fan and the lighting.
- Touch the run-on option control  for approx. 10 seconds, until **1** lights up in the power level display.
- Then touch in turn,
  - the lighting control ,
  - the **1** and then
  - the lighting control  again.

If Power management is switched on, the **1** and **IS** indicators will light up constantly.

If it is switched off, **1** and **IS** will flash.

- Touch **1** to switch Power management off.

The **1** and **IS** indicators will flash.

- Touch **IS** to switch it on.

The **1** and **IS** indicators will light up constantly.

- Confirm the setting with the run-on option control 



All the indicator lamps will go out

If you do not confirm within 4 minutes, the cooker hood will revert to the old setting.

# Operation (Automatic and Manual modes)

## Operating hours counters



The number of hours the appliance has been in operation is stored in memory.

When the Grease filter symbol  or the Charcoal filter symbol  lights up, the operating hours counters are signalling that the filters need to be cleaned or changed. Further information about cleaning and changing the filters and resetting the operating hours counter can be found under "Cleaning and care".

## Altering the operating hours counter for the grease filters

You can set the operating hours counter for the grease filter to suit the type of cooking you do.

The grease filter operating hours counter is set at the factory for 30 hours.

- Select a shorter time of 20 hours if you fry a lot.
- If you only cook occasionally we recommend that you still select a short time because grease which has built up gradually over a long period of time will harden on the filter and make cleaning more difficult.
- Select a longer time of 40 or 50 hours if you use very little fat for cooking.
- Use the On/Off control  to switch the fan off.
- Touch the run-on option control  and the Grease filter control  at the same time.

The Grease filter symbol  and one of the fan power level indicators will flash.

Fan power level indicators **1** to **IS** show the time set:

<b>1</b> .....	20 hours
<b>2</b> .....	30 hours
<b>3</b> .....	40 hours
<b>IS</b> .....	50 hours

- Touch the relevant control to select the duration required.
- Confirm your choice by touching the Grease filter control .

All the indicator lamps will go out



If you do not confirm within 4 minutes, the cooker hood will revert to the old setting.

# Operation (Automatic and Manual modes)

## Activating and altering the charcoal filter operating hours counter

Charcoal filters are needed for recirculation mode.

The operating hours counter for the charcoal filter needs to be activated once and the operating hours counter needs to be set to suit the kind of cooking you do:

- Use the On/Off control  to switch the fan off.
- Touch the run-on option control  and the Charcoal filter control  at the same time.

The Charcoal filter symbol  and one of the fan power levels will flash.

Fan power level indicators **1** to **IS** show the time set:

<b>1</b> .....	120 hours
<b>2</b> .....	180 hours
<b>3</b> .....	240 hours
<b>IS</b> .....	Deactivated



- Touch the relevant control to select the duration required.
- Confirm your choice by touching the Charcoal filter control .

All the indicator lamps will go out.

If you do not confirm within 4 minutes, the cooker hood will revert to the old setting.

## Reading the filter operating hours counter

To check the percentage of time set already used

- Touch the On/Off control  to switch the fan on.
- Press and hold the Grease filter control  or the Charcoal filter control .

One or more of the power level indicators will flash.

The number of fan power level indicators flashing shows the percentage of the operating time which has already been used up.

<b>1</b> .....	25 %
<b>1 and 2</b> .....	50 %
<b>1 to 3</b> .....	75 %
<b>1 to IS</b> .....	100 %

The number of operating hours used remains in the memory, even when the appliance is switched off or there is a power cut.



This cooker hood operates very efficiently and economically. The following will help you to save even more energy when using it:

- Ensure that there is sufficient ventilation in the kitchen when cooking. In extraction mode, if there is insufficient air flow the cooker hood cannot operate efficiently and this causes increased operating noise levels.
- Always cook with the lowest possible setting. This produces fewer cooking vapours, so you can use a lower cooker hood power level and therefore benefit from reduced energy consumption.
- Use the Con@ctivity function. The cooker hood will switch on and off automatically at the optimum power level for the cooking you are doing, which ensures low energy consumption.
- If you are operating the cooker hood manually, please note the following:
  - Check the power level selected on the cooker hood. A lower power level is generally sufficient for the majority of cooking. Only use the intensive setting when necessary.
  - When a large volume of cooking vapours are being produced, switch to a high power level in good time. This is more efficient than operating the cooker hood for longer to try to capture cooking vapours which have already been distributed throughout the kitchen.
- Make sure that you switch the cooker hood off after use. If cooking vapours and odours still need to be removed from the kitchen air after cooking, use the run-on function. The fan will switch off automatically after the selected run-on time.
- Clean or change the filters at regular intervals. Heavily soiled filters reduce performance, increase the risk of fire and are unhygienic.

# Cleaning and care

---

## Casing

### General information

The surfaces and controls are susceptible to scratches and abrasion.

Please observe the following cleaning instructions.

- All external surfaces and controls can be cleaned using hot water with a small amount of washing-up liquid applied with a well wrung-out soft sponge or cloth.
- After cleaning, wipe the surfaces dry using a soft cloth.

Do not use:

- cleaning agents containing soda, acids, chlorides or solvents,
- abrasive cleaning agents, e.g. powder cleaners or cream cleaners and abrasive sponges, as well as pot scourers or sponges which have been used previously with abrasive cleaning agents. These will damage the surface material.

### Important for appliances with stainless steel surfaces

- Stainless steel surfaces can be cleaned with a proprietary non-abrasive cleaning agent designed specifically for use on stainless steel.
- To help prevent re-soiling, a proprietary conditioning agent for stainless steel (available from Miele) can also be used. Follow the manufacturer's instructions on the packaging.

### Important for appliances with glass surfaces

- Glass surfaces can be cleaned using a proprietary non-abrasive cleaning agent designed specifically for use on glass.

## Grease filter

The re-usable metal grease filter in the appliance removes solid particles from the kitchen vapours (grease, dust, etc) preventing soiling of the cooker hood.

 An oversaturated filter is a fire hazard.

## Cleaning interval

Grease which is left to accumulate over time will harden and become difficult to remove. The grease filter should therefore be cleaned at least every 3 - 4 weeks.

The operating hours counter reminds you to clean the filter regularly. The grease filter symbol  will light up.

- You can set the operating hours counter for the grease filter to suit the type of cooking you do (see "Operation").

## Removing a grease filter

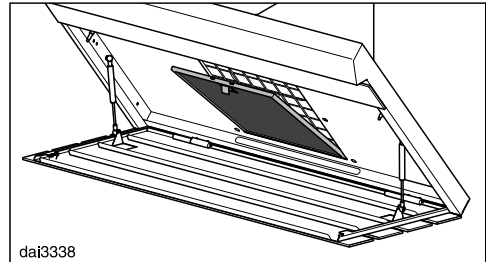
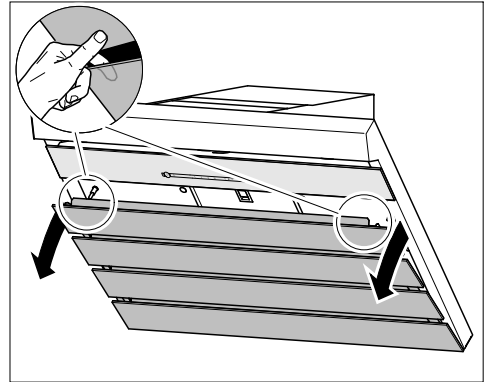

- Insert your finger at the top edge of the second slat (see diagram) and pull the vapour canopy out of the catch.

The canopy will swing open.

Putting pressure on the open canopy can damage it. Do not lean on or against the canopy.

- To take out the grease filter, release the locking clip on the filter, swing the filter forwards by approx. 45°, unhook it at the back and remove it.
- Close the canopy.

# Cleaning and care

---

## Cleaning the grease filter by hand

- Clean the filter with a soft nylon brush in a mild solution of hot water and a small amount of washing-up liquid. Do not use "neat" washing up liquid.

## Unsuitable cleaning agents

Unsuitable cleaning agents can cause damage to the surface of the filters if used regularly.

Do not use:

- cleaning agents containing descaling agents
- powder cleaners, cream cleaners
- aggressive multi-purpose cleaning agents or spray cleaners for grease
- oven sprays

## Cleaning the grease filter in a dishwasher

- Place the filter as upright as possible in the lower basket, or at an angle, ensuring the spray arm is not obstructed.
- Use a proprietary household dishwasher detergent.
- Select a dishwasher programme with a wash temperature between 50°C and 65°C.

Depending on the cleaning agent used, cleaning a filter in a dishwasher can cause permanent discolouration to internal surfaces. However, this will not affect the functioning of the filter in any way.

## After cleaning

- After cleaning, leave the filter to dry on an absorbent surface before replacing it.
- When removing the filter for cleaning, clean off any residues of oil or fat from the now accessible casing and the interior surfaces of the canopy to prevent the risk of these catching fire.

- Replace the grease filter, making sure that the locking clip is facing outwards.

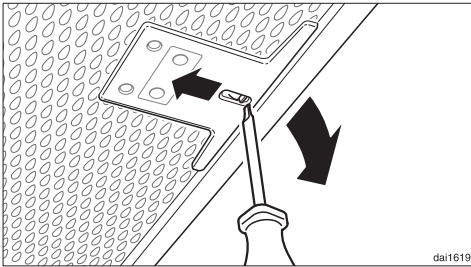

- If the grease filter is inadvertently replaced the wrong way round, insert a small screwdriver blade into the slit to disengage the clip.
- Close the canopy and press it on the right and left into the catch.

## Resetting the grease filter operating hours counter

After cleaning, the operating hours counter needs to be re-set.

- Whilst the fan is switched on, press the Grease filter control  for approx. 3 seconds, until only the 1 is flashing.

The Grease filter symbol  goes out.

If you want to clean the grease filters before the operating hours counter has reached its maximum,

- Touch the Grease filter control  for approx. 6 seconds, until only the 1 is flashing.

## Charcoal filter

Recirculation cooker hoods must be fitted with a charcoal filter in addition to the grease filter. This is designed to absorb cooking odours.

It is fitted in the top of the cooker hood.

Replacement charcoal filters can be obtained from Miele, your Miele dealer or via the internet at [www.miele-shop.com](http://www.miele-shop.com). See "Technical data" for type and reference number.

## Fitting/replacing a charcoal filter

- Take the charcoal filter out of its packaging.

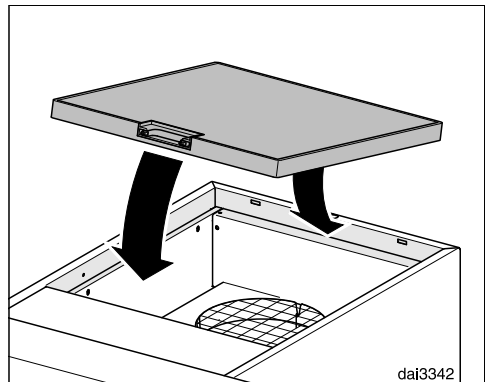

- Fit the charcoal filter into the holder in the top of the cooker hood.
- When fitting for the first time, activate the operating hours counter (see "Operation").

# Cleaning and care

---

## When to change the charcoal filter

- Always replace the charcoal filter when it no longer absorbs kitchen odours effectively. It should, however be replaced at least every 6 months.

The charcoal filter operating hours symbol  will light up to remind you to change the charcoal filter regularly.

- The charcoal filter operating hours counter needs to be activated before using for the first time (see "Operation").

## Resetting the charcoal filter operating hours counter

After changing the charcoal filter, the operating hours counter needs to be reset.

- Touch the Charcoal filter control  for approx. 3 seconds with the cooker hood switched on until only the indicator light for level 1 is flashing.

The Charcoal filter symbol  will go out.

If you want to clean the charcoal filter **before** the operating hours counter has reached its maximum:

- Touch the Charcoal filter control  for approx. 6 seconds until only the indicator light for level 1 is flashing.

## Disposing of the charcoal filter

- Used charcoal filters can be disposed of with the normal household waste.

## Before installation

 Before installation, it is important to read the information given on the following pages as well as the "Warning and Safety instructions" at the beginning of this booklet.

## Protective foil

The housing components have protective foil around them to protect them from transport damage.

- Please remove this foil before fitting the housing components. It can be peeled off easily.

## Installation instructions

See enclosed Installation sheet for instructions on how to install this appliance.

# Installation

## Assembly parts

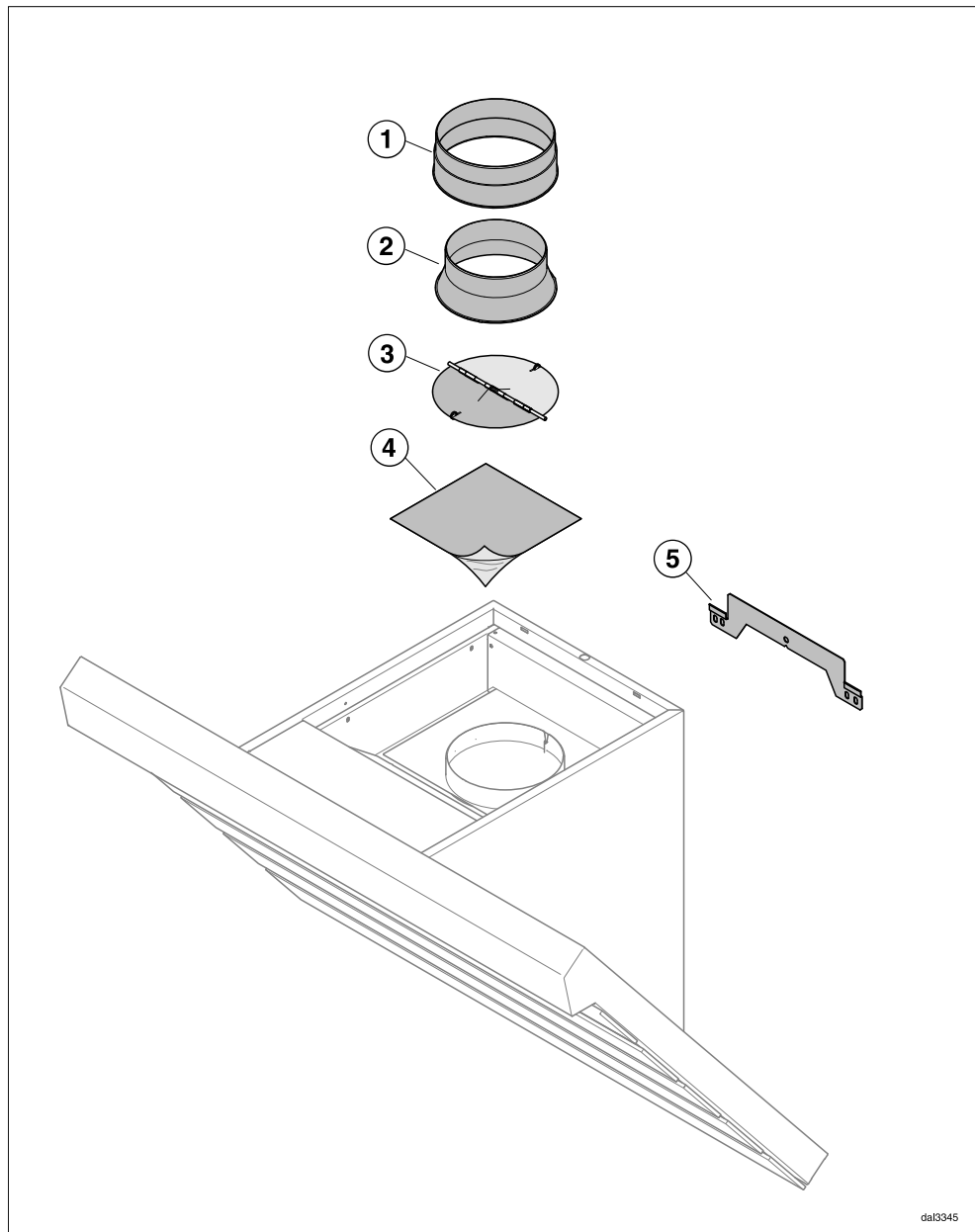

dal3345



- ① **1 exhaust connection**  
for exhaust ducting  $\varnothing$  150 mm
- ② **1 reducing collar**  
for exhaust ducting  $\varnothing$  125 mm
- ③ **1 non-return flap**  
for installation in the exhaust socket of the fan motor (not for recirculation mode). The non-return flap may already be fitted depending on model.
- ④ **Cover foil**  
for use when changing extraction ducting direction
- ⑤ **Wall bracket**  
for securing the cooker hood to the wall

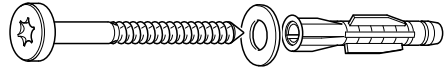

5559-D066805-15h

**5 screws 5 x 60 mm** and  
**5 plugs 8 x 50 mm**  
**3 washers 6.4 mm**  
for securing to the wall.

The screws and plugs are designed for use in solid walls only. For other types of wall construction, alternative fixings will be required. Make sure the wall is able to take the weight of the cooker hood.

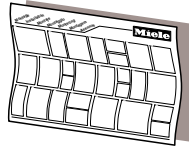

dflms3m16

## Installation instructions

# Installation

## Appliance dimensions

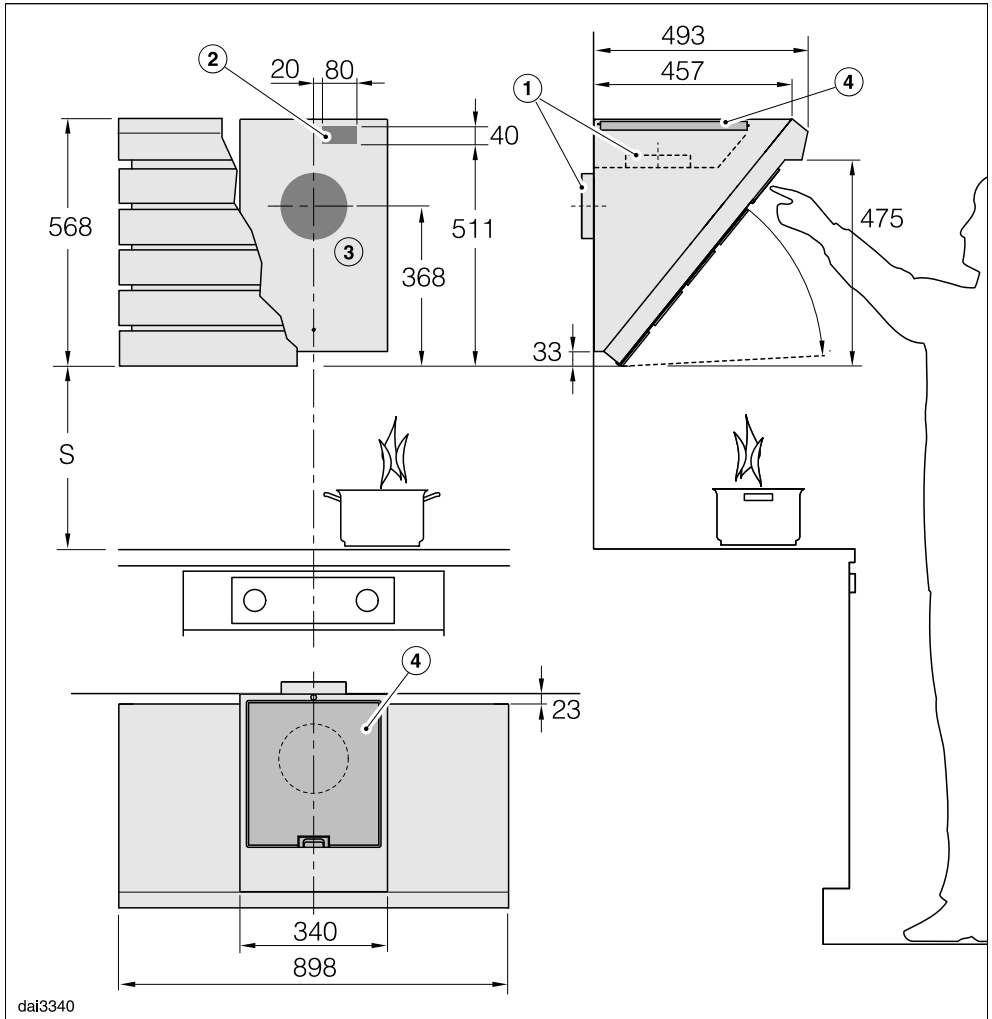

The diagram is not drawn to scale.

- ① Extraction ducting to the rear, or alternatively upwards.
- ② Cut-out for cooker hoods with hard-wired connection rather than a plug.
- ③ 200 mm  $\varnothing$  cut-out ensures sufficient space through the wall for the extraction ducting to flex.

- ④ Ventilation outlet for recirculation mode. A gap of at least 300 mm must be maintained between the top of the cooker hood and the ceiling or any furniture above it.

Connection for air extraction Ø150 mm, or Ø125 mm with reducing collar.

Please observe installation positions for the socket and for the ducting outlet shown on the relevant drawings when using the DADC 6000 tower.

## Safety distance between hob and cooker hood (S)

When planning the installation height of your cooker hood, the minimum safety distance between the top of a cooker or hob and the bottom of the cooker hood is as follows, unless a greater distance is specified by the manufacturer of your cooking appliance.

See "Warning and Safety" instructions for further information.

Cooking appliance	Minimum distance S
Electric hob	450 mm
Electric grill, deep fat fryer (electric)	650 mm
Multi-burner gas hob, total output ≤ 12.6 kW, no burner > 4.5 kW	650 mm
Multi-burner gas hob, total output > 12.6 kW and ≤ 21.6 kW, no burner > 4.8 kW.	760 mm
Multi-burner gas hob, total output > 21.6 kW, or multi-burner gas hob where one burner > 4.8 kW.	Not possible
Single burner gas hob, output ≤ 6 kW.	650 mm
Single burner gas hob, output > 6 kW and ≤ 8.1 kW.	760 mm
Single burner gas hob, output > 8.1 kW	Not possible

# Installation

---

## Installation recommendations

- Account should also be taken of the height of the person who will be using the hood most often. They should have sufficient space to work comfortably at the hob, and be able to reach the hood controls with ease.
- Please be aware that if positioned too high, extraction will be inefficient.
- To achieve optimum vapour extraction, the cooker hood must cover the hob. It should be positioned centrally over the hob, not to the side of it.
- The hob should be no wider than the cooker hood, and if possible, it should be narrower.
- The installation area must be easily accessible. The cooker hood should be easily accessible and easy to dismantle in the event that service is required. This should be taken into consideration when planning the position of cupboards, shelves, ceilings or features in the vicinity of the cooker hood.

## Connection for air extraction

**⚠** If this cooker hood is used at the same time as a heating appliance that relies on oxygen from the same room there is a risk in certain circumstances of toxic fumes building up.

It is essential that the "Warning and Safety" instructions are observed.

The cooker hood should be installed according to local and national building regulations. Seek approval from the building inspector where necessary.

- Ensure that all connections are strong and airtight.

Remember that any constriction of the air flow will reduce extraction performance and increase operating noise.

- If the exhaust is ducted through an outside wall, a telescopic wall vent or a roof vent (available as an optional accessory) is recommended.

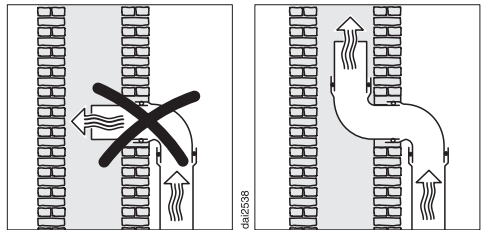

- To achieve the most efficient air extraction with the lowest noise levels, please note the following:
  - To ensure efficient air extraction, the diameter of the exhaust ducting should not be less than 150 mm.
  - If flat ducting is being used, the cross section must not be smaller than the cross sectional area of the exhaust socket.
  - The exhaust ducting should be as short and straight as possible.
  - Only use wide radius bends.
  - The exhaust ducting must not be kinked or compressed.
- If the exhaust air is to be ducted into a flue, the ducting must be directed in the flow direction of the flue.
- When ducting is horizontal it must be laid to slope away at at least 1 cm per metre. This is to ensure that condensate cannot drain back into the appliance.
- If the exhaust ducting is to run through rooms, ceiling space etc. where there may be great variations in temperature between the different areas, the problem of condensation will need to be addressed. The exhaust ducting will need to be suitably insulated.

# Connection for air extraction

## Condensate trap

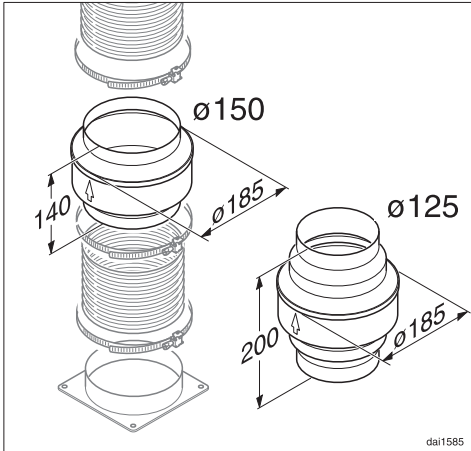

In addition to insulating the exhaust ducting, we recommend that a suitable condensate trap is also installed to collect and evaporate any condensate which may occur.

Condensate traps for 125 mm or 150 mm ducting are available as optional accessories.

A condensate trap can only be fitted in extraction ducting which is directed upwards out of the cooker hood.

- When installing a condensate trap, ensure that it is positioned vertically and as closely as possible above the exhaust socket. The arrow on the housing indicates the direction of air-flow.

A condensate trap is integrated in cooker hoods which are designed for connection to an external motor (model.....EXT).

## Silencer

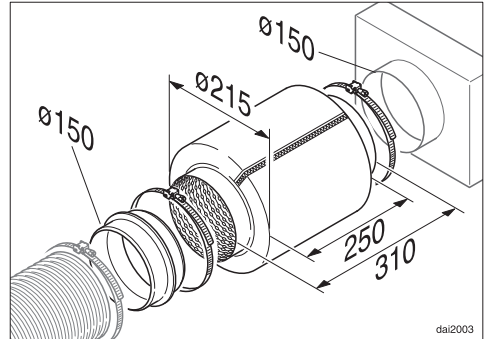

To achieve even further reductions in noise levels, a special silencer (optional accessory) can be fitted in the ducting system.

## Extraction mode

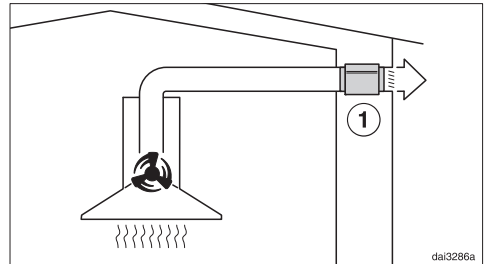

The silencer not only reduces noise from the motor outside the house, but also sounds from outside (e.g. traffic noise). For this reason the silencer must be positioned as close as possible to the ducting exit ①.

## Recirculation mode

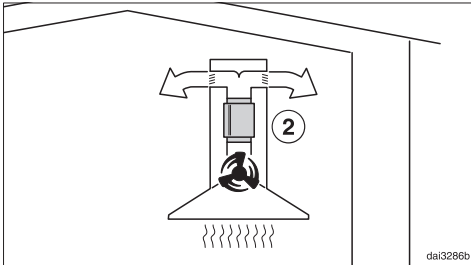

The silencer needs to be positioned between the exhaust socket and the directional unit ②. Ensure there is adequate space for fitting it.

## Extraction mode with external motor

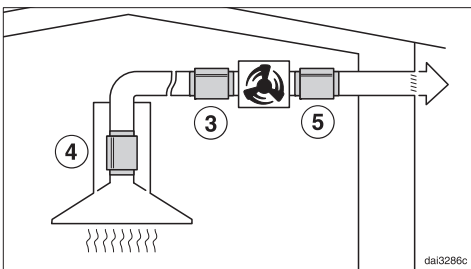

To minimise noise from the motor in the kitchen, the silencer should be positioned in front of the external motor ③ if possible, or, if the ducting is long, above the exhaust socket on the cooker hood ④. In the case of an external motor located inside the house, fitting a silencer behind the external motor ⑤ reduces the noise of the motor outside the house.

# Electrical connection

All electrical work should be undertaken by a suitably qualified and competent person in strict accordance with current national and local safety regulations (BS 7671 in the UK).  
Installation, repairs and other work by unqualified persons could be dangerous, for which the manufacturer cannot be held liable. Ensure power is not supplied to the appliance until after installation or repair work has been carried out. Do not connect the appliance to the mains electricity supply by an extension lead. These do not guarantee the required safety of the appliance.

**The connection data is given on the data plate.** This is visible when the grease filters have been removed. Ensure that this data matches the household mains supply.

Connection of this appliance should be made via a suitable isolator or a double pole fused spur connection unit which complies with national and local safety regulations and the On-Off switch should be easily accessible after the appliance has been built in. When switched off there must be an all-pole contact gap of 3 mm in the switch (including switch, fuses and relays according to EN 60335).

If the switch is not accessible after installation (depending on country), an additional means of disconnection must be provided for all poles. For extra safety it is advisable to protect the appliance with a suitable residual current device (RCD). Contact a qualified electrician for advice.

### Important

This appliance is supplied for connection to an a.c. 230 V single phase 50 Hz supply. The wires in the mains lead are coloured in accordance with the following code:

- Green/yellow .....earth
- Blue.....neutral
- Brown .....live

**WARNING:  
THIS APPLIANCE MUST BE  
EARTHED**



## Installing the Con@ctivity 2.0 Stick

In order to use the Con@ctivity 2.0 function, the hob must first be fitted with the Con@ctivity 2.0 Stick.

- Please read the separate installation instructions supplied with the Con@ctivity 2.0 Stick.

## Activating Con@ctivity 2.0



Wireless connection must be activated between the hob and the cooker hood before the Con@ctivity 2.0 function can be used.

Both appliances must be installed and operational.

Wireless connection must be activated on the cooker hood and the hob at the same time. Activation on the cooker hood is described below.

Activation on the hob is described in the relevant Operating and installation instructions. Please refer to the Operating instructions before starting. Activate the cooker hood first, then the hob.

## Activating the cooker hood

- The hob and cooker hood must be switched off.
- Touch the run-on option control  for approx. 10 seconds, until **1** lights up in the power level display.
- Then touch in turn,
  - the **1** control,
  - then the **IS** control,
  - then the lighting control .

The cooker hood is now in signing on/off mode.

If a wireless connection has not yet been established **2** and **3** will flash at the same time.

If a wireless connection has already been established, **2** and **3** will light up constantly (Con@ctivity 2.0 is already activated or a remote control is signed on).

- Touch the **IS** control to activate Con@ctivity 2.0.

The search for a signal will start.

- Meanwhile, start activating the hob.

# Activating Con@ctivity 2.0

---

## Activating the hob

- **While** the cooker hood is searching for a signal, start activating the hob. More information about this can be found in the Operating instructions for the hob.
- When the hob registers that connection has been established, confirm activation on the cooker hood with the run-on option control **5**  **15**. All indicators will go out.
- Confirm activation on the hob.

Con@ctivity 2.0 is now ready to use.

If you do not confirm within 4 minutes, activation will not take place.

You only need to carry out the activation procedure once. If the appliances are disconnected from the electricity supply, during a power cut for example, they will still remain activated.

## Activation failed

- If connection cannot be established despite activating the Con@ctivity function on the cooker hood and hob, the function must be deactivated on both appliances and then the procedure repeated.

## Deactivating Con@ctivity 2.0

- Deactivation on the cooker hood is carried out in the same way as activation, selecting the **1** control instead of the **IS** control.
- To deactivate the hob, please refer to the Operating instructions supplied with it.

Please bear in mind that disabling the signal will also disable any remote control function and this will have to be activated again.

In the event of a fault which you cannot remedy yourself, please contact your Miele dealer or the Miele Service Department.

Contact details for Miele are given at the back of this manual. N.B. A call-out charge will be applied to service visits where the problem could have been resolved as described in these instructions.

When contacting your dealer or Miele, please quote the model and serial number of your appliance. These are shown on the data plate.

### **Position of the data plate**

The data plate is visible after removing the grease filter.

### **Guarantee: U.K.**

In the U.K., the appliance is guaranteed for 2 years from the date of purchase. However, you must activate your cover by calling 0330 160 6640 or registering online at [www.miele.co.uk](http://www.miele.co.uk).

### **Guarantee: Other countries**

For information on the appliance guarantee specific to your country please contact Miele. See end of this booklet for contact details.

## Technical data

Fan motor*	90 W
Hob lighting	3 x 3 W
Total connected load*	99 W
Voltage, frequency	AC 230 V, 50 Hz
Fuse rating	5 A
Mains connection cable length	1.5 m
Weight	
DA 6796 W	30 kg
DA 6796 W EXT	27 kg

\* For EXT models, the connected load will depend on the type of external motor fitted.  
Length of connection cable to external motor: 1.9 m  
Recirculation mode requires charcoal filter DKF 25-1 (available to order)

## Conformity declaration

Miele hereby declares that the cooker hoods listed at the end of this booklet comply with the basic requirements and other relevant regulations of Guideline 1999/5/EC.

A copy of the full Declaration of Conformity can be obtained from the address at the end of this booklet.

## Data sheet for domestic cooker hoods

In acc. with delegated regulation (EU) No. 65/2014 and regulation (EU) No. 66/2014

<b>MIELE</b>	
<b>Model name / identifier</b>	DA 6796 W
Annual Energy Consumption ( $AEC_{hood}$ )	34,1 kWh/year
Energy efficiency class	
A+ (most efficient) to F (least efficient)	A+
Energy efficiency index ( $EEl_{hood}$ )	43,8
Fluid Dynamic Efficiency ( $FDE_{hood}$ )	35,6
Fluid Dynamic Efficiency class	
A (most efficient) to G (least efficient)	A
Lighting Efficiency ( $LE_{hood}$ )	31,1 lx/W
Lighting Efficiency class	
A (most efficient) to G (least efficient)	A
Grease Filtering Efficiency	67,1 %
Grease Filtering Efficiency class	
A (most efficient) to G (least efficient)	D
Airflow at best efficiency point	334,9 m <sup>3</sup> /h
Air flow (min. speed)	240 m <sup>3</sup> /h
Air flow (max. speed)	400 m <sup>3</sup> /h
Air flow (intensive or boost setting)	640 m <sup>3</sup> /h
Max. air flow ( $Q_{max}$ )	640 m <sup>3</sup> /h
Air pressure at best efficiency point	402 Pa
Airborne acoustical A-weighted sound power emissions (min. speed)	42 dB
Airborne acoustical A-weighted sound power emissions (max. speed)	53 dB
Airborne acoustical A-weighted sound power emissions (intensive or boost setting)	63 dB
Electrical power input at best efficiency point	105,0 W
Power consumption in off mode ( $P_o$ )	W
Power consumption in standby mode ( $P_s$ )	0,15 W
Nominal power of lighting system	9,0 W
Average illumination of the lighting system on the cooking surface	280 lx
Time increase factor	0,7

# Technical data

## Data sheet for domestic cooker hoods

In acc. with delegated regulation (EU) No. 65/2014 and regulation (EU) No. 66/2014

<b>MIELE</b>	
<b>Model name / identifier</b>	DA 6796 W EXT
Annual Energy Consumption ( $AEC_{hood}$ )	6,6 kWh/year
Energy efficiency class	
A+ (most efficient) to F (least efficient)	A+
Energy efficiency index ( $EEl_{hood}$ )	32,4
Fluid Dynamic Efficiency ( $FDE_{hood}$ )	
Fluid Dynamic Efficiency class	
A (most efficient) to G (least efficient)	-
Lighting Efficiency ( $LE_{hood}$ )	31,1 lx/W
Lighting Efficiency class	
A (most efficient) to G (least efficient)	A
Grease Filtering Efficiency	%
Grease Filtering Efficiency class	
A (most efficient) to G (least efficient)	-
Airflow at best efficiency point	m <sup>3</sup> /h
Air flow (min. speed)	m <sup>3</sup> /h
Air flow (max. speed)	m <sup>3</sup> /h
Air flow (intensive or boost setting)	m <sup>3</sup> /h
Max. air flow ( $Q_{max}$ )	m <sup>3</sup> /h
Air pressure at best efficiency point	Pa
Airborne acoustical A-weighted sound power emissions (min. speed)	dB
Airborne acoustical A-weighted sound power emissions (max. speed)	0 dB
Airborne acoustical A-weighted sound power emissions (intensive or boost setting)	dB
Electrical power input at best efficiency point	W
Power consumption in off mode ( $P_o$ )	W
Power consumption in standby mode ( $P_s$ )	0,15 W
Nominal power of lighting system	9,0 W
Average illumination of the lighting system on the cooking surface	280 lx
Time increase factor	

## United Kingdom

Miele Co. Ltd.  
Fairacres, Marcham Road  
Abingdon, Oxon, OX14 1TW  
Customer Contact Centre Tel: 0330 160 6600  
E-mail: mielecare@miele.co.uk  
Internet: www.miele.co.uk

## Australia

Miele Australia Pty. Ltd.  
ACN 005 635 398  
ABN 96 005 635 398  
1 Gilbert Park Drive, Knoxfield, VIC 3180  
Tel: 1300 464 353  
Internet: www.miele.com.au

## China

Miele (Shanghai) Trading Ltd.  
1-3 Floor, No. 82 Shi Men Yi Road  
Jing' an District  
200040 Shanghai, PRC  
Tel: +86 21 6157 3500, Fax: +86 21 6157 3511  
E-mail: info@miele.cn, Internet: www.miele.cn

## Miele (Hong Kong) Limited

41/F - 4101, Manhattan Place  
23 Wang Tai Road  
Kowloon Bay, Hong Kong  
Tel: (852) 2610 1331, Fax: (852)2610 1013  
Email: mielehk@miele.com.hk

## India

Miele India Pvt. Ltd.  
Ground Floor, Copia Corporate Suites  
Plot No. 9, Jasola  
New Delhi - 110025  
Tel: 011-46 900 000, Fax: 011-46 900 001  
E-mail: customercare@miele.in, Internet: www.miele.in

## Ireland

Miele Ireland Ltd.  
2024 Bianconi Avenue  
Citywest Business Campus, Dublin 24  
Tel: (01) 461 07 10, Fax: (01) 461 07 97  
E-Mail: info@miele.ie, Internet: www.miele.ie

## Manufacturer: Miele & Cie. KG

Carl-Miele-Straße 29, 33332 Gütersloh, Germany

# Miele

## Malaysia

Miele Sdn Bhd  
Suite 12-2, Level 12  
Menara Sapura Kencana Petroleum  
Solaris Dutamas No. 1, Jalan Dutamas 1  
50480 Kuala Lumpur, Malaysia  
Phone: +603-6209-0288  
Fax: +603-6205-3768

## New Zealand

Miele New Zealand Limited  
IRD 98 463 631  
Level 2, 10 College Hill  
Freemans Bay, Auckland 1011, NZ  
Tel: 0800 464 353  
Internet: www.miele.co.nz

## Singapore

Miele Pte. Ltd.  
163 Penang Road  
# 04 - 03 Winsland House II  
Singapore 238463  
Tel: +65 6735 1191, Fax: +65 6735 1161  
E-Mail: info@miele.com.sg  
Internet: www.miele.sg

## South Africa

Miele (Pty) Ltd  
63 Peter Place, Bryanston 2194  
P.O. Box 69434, Bryanston 2021  
Tel: (011) 875 9000, Fax: (011) 875 9035  
E-mail: info@miele.co.za  
Internet: www.miele.co.za

## United Arab Emirates

Miele Appliances Ltd.  
P.O. Box 11 47 82  
Gold & Diamond Park, Sheikh Zayed Road  
Building 6 / Offices Nos. 6-214 to 6-220  
Dubai  
Tel: +971-4-341 84 44  
Fax: +971-4-341 88 52  
E-Mail: info@miele.ae  
Internet: www.miele.ae

DA 6796 W  
DA 6796 W EXT



en-GB

M.-Nr. 10 096 570 / 03



## Free Manuals Download Website

<http://myh66.com>

<http://usermanuals.us>

<http://www.somanuals.com>

<http://www.4manuals.cc>

<http://www.manual-lib.com>

<http://www.404manual.com>

<http://www.luxmanual.com>

<http://aubethermostatmanual.com>

Golf course search by state

<http://golfingnear.com>

Email search by domain

<http://emailbydomain.com>

Auto manuals search

<http://auto.somanuals.com>

TV manuals search

<http://tv.somanuals.com>