

Miele

Operating and installation instructions

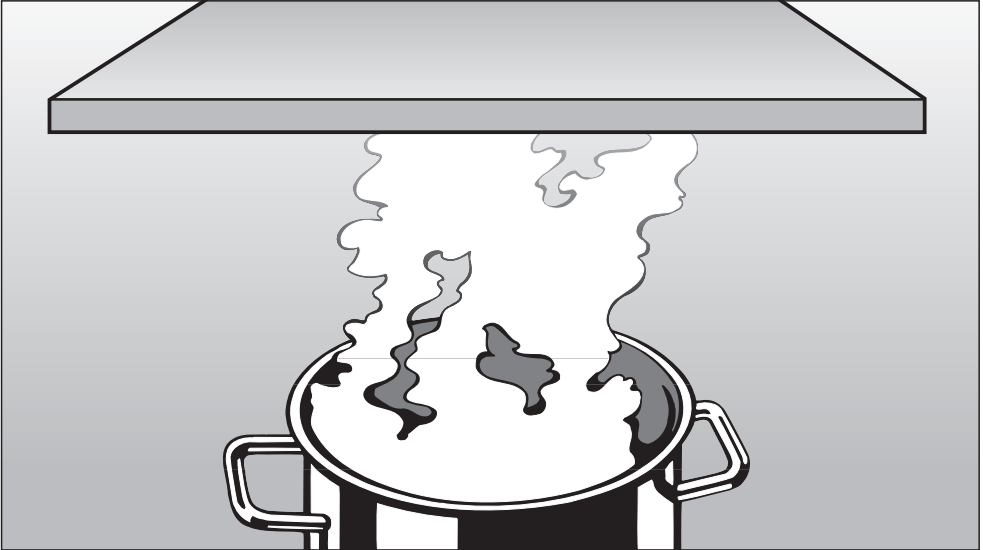

Ventilation System

DA 251

DA 252-3

DA 259-3

To prevent accidents
and machine damage,
read these instructions

before

installation or use.



M.-Nr. 05 802 960

Table of Contents

IMPORTANT SAFETY INSTRUCTIONS	3
Functional description	7
Guide to the appliance	8
Operation	10
Turning on the fan	10
Selecting the power level.	10
Delayed Shut Down	10
Turning off the fan	11
Turning the lighting on / off	11
Dimming the lighting	11
Indirect lighting	11
Grease filter timer.	12
Checking the grease filter timer	12
Reprogramming the grease filter timer	13
Cleaning and Care	14
Cleaning the casing.	14
Grease filters	15
Changing the light bulbs	16
Indirect lighting	16
After Sales Service	17
Installation instructions	19
Caring for the environment	20
Plywood backing	21
Installation accessories	22
Electrical data.	24
Appliance dimensions and Installation	25
Air extraction	27
Condensate trap	28

IMPORTANT SAFETY INSTRUCTIONS

Read these Operating Instructions carefully before installing or using the Ventilation System.

This appliance is intended for residential use only. Use the appliance only for its intended purpose. The manufacturer cannot be held responsible for damages caused by improper use of the hood.

This appliance complies with current safety requirements. Improper use of the appliance can lead to personal injury and material damage.

READ AND SAVE THESE INSTRUCTIONS

CAUTION

For General Ventilating Use Only.
Do Not Use To Exhaust Hazardous
Or Explosive Materials And Vapors.

■ This appliance is designed to vent cooking smoke and odors only.

■ Be certain your appliance is properly installed and grounded by a qualified technician.

To guarantee the electrical safety of this appliance, continuity must exist between the appliance and an effective grounding system. It is imperative that this basic safety requirement be met. If there is any doubt, have the electrical system of the house checked by a qualified electrician. The manufacturer can not be held responsible for damages caused by the lack, or inadequacy of, an effective grounding system.

■ Before connecting the appliance to the power supply make sure that the voltage and frequency listed on the data plate correspond with the household electrical supply. This data must correspond to prevent machine damage. Consult a qualified electrician if in doubt.

■ Installation work and repairs should only be performed by a qualified technician in accordance with all applicable codes and standards. Repairs and other work by unqualified persons could be dangerous and the manufacturer will not be held responsible.

IMPORTANT SAFETY INSTRUCTIONS

■ This equipment is not designed for maritime use or for use in mobile installations such as caravans or aircraft. However, under certain conditions it may be possible for an installation in these applications. Please contact the nearest Miele dealer or the Technical Service Department with specific requirements.

■ Before servicing or cleaning the unit, switch power off at the service panel and lock the service disconnecting means to prevent power from being switched on accidentally. When the service disconnecting means can not be locked, securely fasten a prominent warning device, such as a tag, to the service panel.

■ Before discarding an old appliance, unplug it from the power supply and remove the power cord and any doors to prevent hazards.

Use

■ Do not allow children to play with or operate the appliance or its controls. Supervise its use by the elderly or infirm.

■ Be careful when preparing a flambé beneath the hood. Flames may be drawn up into the hood by the suction or grease filters may catch fire.

■ Never operate gas burners without pots.

■ Do not leave cooking surfaces unattended while in use. Overheated food, oil and grease can catch fire.

■ Do not use the hood without the grease filters in place.

■ Clean the grease filters regularly. Dirty filters are a fire hazard.

■ Do not use a steam cleaner to clean the hood. Steam could penetrate electrical components and cause a short circuit.

■ In areas subject to infestation by cockroaches or other pest, keep the appliance and its surroundings clean at all times. Any damage caused by cockroaches or other pest will not be covered under warranty.

■ Always turn on the hood when using the cooktop to prevent damage from condensation.

IMPORTANT SAFETY INSTRUCTIONS

WARNING - TO REDUCE THE RISK OF A RANGE TOP GREASE FIRE:

 Never leave surface units unattended at high settings. Boilovers cause smoking and greasy spillovers may ignite. Heat oils slowly on low or medium settings.

 Always turn the hood "ON" when cooking at high heat or when cooking flaming foods.

 Clean ventilating fans frequently. Grease should not be allowed to accumulate on the fan or filter.

 Use proper pan size. Always use cookware appropriate for the size of the surface element.

WARNING TO REDUCE THE RISK OF INJURY TO PERSONS IN THE EVENT OF A RANGE TOP GREASE FIRE, OBSERVE THE FOLLOWING:

 **SMOTHER FLAMES** with a close fitting lid, cookie sheet, or metal tray, then turn off the burner.

BE CAREFUL TO PREVENT BURNS. If the flames do not go out immediately, **EVACUATE AND CALL THE FIRE DEPARTMENT.**

 **NEVER PICK UP A FLAMING PAN** - You may be burned.

 **DO NOT USE WATER**, including wet dishcloths or towels - a violent steam explosion will result.

 Use an extinguisher **ONLY** if:

- You know you have a Class ABC extinguisher, and you already know how to operate it.
- The fire is small and contained in the area where it started.
- The fire department is being called.
- You can fight the fire with your back to an exit.

IMPORTANT SAFETY INSTRUCTIONS

Installation

 **WARNING**
To reduce the risk of fire only use metal ductwork.

 When installing the hood, follow the recommended minimum safety distances between a Miele cooktop and the hood:

- 22" (55 cm) above electric cooktops,
- 26" (65 cm) above gas cooktops,
- 26" (65 cm) above an open grill.

If local building codes require a greater safety distance, follow their requirement.

For non-Miele cooking appliances maintain the safety distances recommended by the appliance manufacturer in their instructions. If there is more than one appliance beneath the hood and they have different minimum safety distances always select the greater distance.

 Be careful not to damage hidden electrical wiring or plumbing when cutting or drilling into the wall or ceiling.

 Do not use an extension cord to connect the appliance to electricity. Extension cords do not guarantee the required safety of the appliance, (e.g. danger of overheating).

 Do not install this hood over cooktops burning solid fuel.

 Any fittings, sealant, or materials used to install the ductwork must be made of approved non-flammable materials.

 Never connect an exhaust hood to an active chimney, dryer vent, vent flue, or room ventilating ductwork. Seek professional advice before connecting an exhaust hood vent to an existing, inactive chimney or vent flue.

 Ducted fans must always be vented outdoors.

 Make sure that the airflow in the room is sufficient for combustion and exhausting of all non-electric heating appliances (water heaters, gas cooktops, gas ovens, etc.), otherwise backdrafts may occur. Follow the heating manufacturer's guidelines and safety standards or those published by the National Fire Protection Association (NFPA), or the American Society for Heating, Refrigeration and Air Conditioning Engineers (ASHRAE). If in doubt, consult an experienced professional.

The ventilation hood works by air extraction. The air is drawn in and cleaned by the grease filters and directed outside.

The hood comes equipped with a **non-return flap**. This flap automatically closes when the hood is turned off so that no exchange of outside air and room air can occur. When the hood is turned on, the air pressure of the exhaust fan automatically opens the flap blowing the inside air and cooking odors outside.

Guide to the appliance

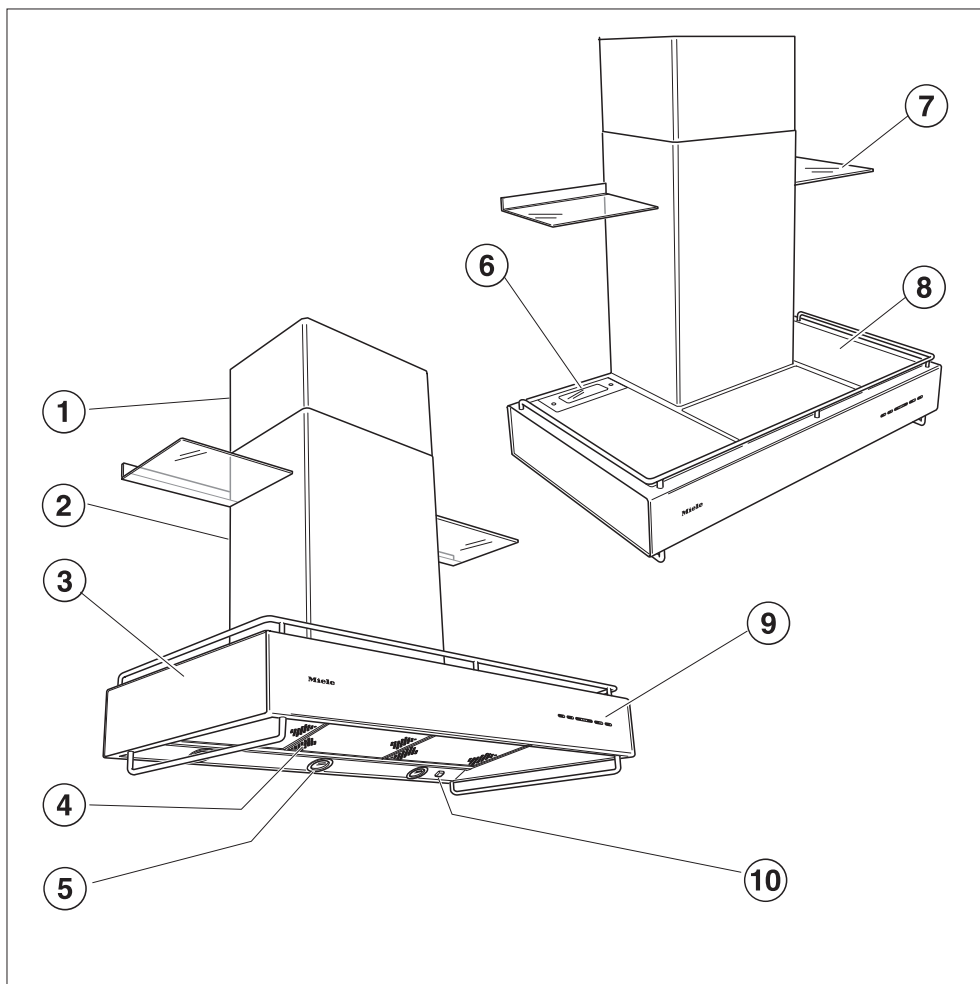

da100707a

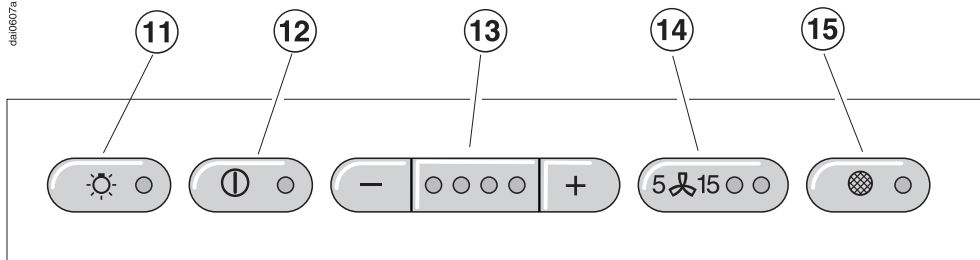

① **Chimney extension**

② **Chimney**

③ **Canopy**

④ **Grease filter**

⑤ **Overhead lighting**

⑥ **Indirect lighting**

⑦ **Glass shelves**

Each holds up to 8 lbs.

⑧ **Canopy storage surface**

Max weight on entire surface not to exceed 17 lbs.

⑨ **Control panel**

⑩ **Indirect lighting switch**

⑪ **Light button**

This button turns the light on and off and also dims the light.

The lighting can be used independently of the fan.

⑫ **On/Off button**

⑬ **Fan power level buttons**

Four fan speed selection.

⑭ **Delayed Shut Down**

This button activates the Delayed Shut Down feature. The fan can be set to turn off automatically after either 5 or 15 minutes.

⑮ **Grease filter button**

The indicator next to the grease filter button lights when the grease filters need to be cleaned. This button is also used:

- to reset the grease filter timer after cleaning the grease filters (see "Cleaning and Care").
- to show how long the grease filters have been in use (see "Operation / Grease filter timer").
- to change the number of hours counted by the grease filter timer (see "Operation / Reprogramming the grease filter timer").

Operation

Turning on the fan





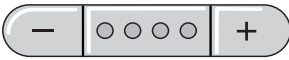

- Press the On/Off button.

The fan runs at power level "2".
The On/Off indicator lights.

Selecting the power level



- Use the   controls to select the desired power level.

 = increases the fan speed
 = decreases the fan speed

Level "1" to "3" (green indicators) are usually sufficient for normal cooking.

Intensive setting

Level "4" (yellow indicator) should be used for a short period when frying or cooking food with a strong aroma.

Fan performance

The maximum air flow capacity is 625 cfm. Factors such as narrow duct diameter and bends will affect this value.

Level 1 operates at 40% capacity
Level 2 operates at 60% capacity
Level 3 operates at 80% capacity
Level 4 operates at 100% capacity

Delayed Shut Down

If odors or smoke remain in the kitchen after cooking has been completed, the Delayed Shut Down feature can be selected to allow the hood to continue running for either 5 or 15 minutes.



- Press the Delayed Shut Down button while the fan is still running.

Press once = 5 minute delay
(left indicator lights)

Press twice = 15 minute delay
(right indicator lights)

To cancel the Delayed Shut Down feature press the button again.

Turning off the fan



- Press the On/Off button to turn the fan off.

The indicator goes out.

Automatic Safety Shut Off

The fan will be turned off automatically 10 hours after the last button was activated. The lighting however, will remain on.

- Pressing the On/Off button will turn the fan back on.

Turning the lighting on / off

The overhead lighting can be turned on and off independently of the fan.



- Press the light button **briefly** to turn on the lighting.

The light button indicator illuminates.

- Press the light button **briefly** again to turn off the lighting.

The light button indicator will go out.

Dimming the lighting

The brightness of the lighting can be adjusted.

- While the lighting is turned on, press the light button.
The lighting will dim until the button is released.
- If the button is pressed again, the lighting will brighten until the button is released.

If the button is pressed continuously, the light will cycle between bright and dark.

- Press the light button again to turn off the lighting.

Indirect lighting



- Press the indirect lighting switch to "I".

Operation

Grease filter timer

A timer monitors the hours of fan operation. The indicator for the grease filter will light after 30 hours of operation. The grease filters must then be cleaned.

After the grease filters have been cleaned and put in place, the grease filter timer must be reset.



- To do this, press the grease filter button for about 3 seconds.

The indicator will go out.

Checking the grease filter timer

To check the percentage of time already used:



- Press the On/Off button to turn the fan on.



- Press the grease filter button.



The number of flashing  indicators show the percentage of programmed hours that have been used.

- 1 indicator = less than 25 %
- 2 indicators = less than 50 %
- 3 indicators = less than 75 %
- 4 indicators = less than 100 %

This information will remain stored in memory in the event of a power failure.

Reprogramming the grease filter timer

The grease filter timer is preset to 30 hours. This time can be lengthened or shortened to 20, 30, 40 or 50 hours.

- A time of 20 hours should be programmed in kitchens with frequent pan or deep frying.
- A time of 20 hours should also be programmed if the kitchen is only used occasionally. Otherwise grease which has accumulated over a long period of time will harden on the filters making cleaning more difficult.

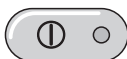

- Press the On/Off button to turn off the fan.



- Press the Delayed Shut Down and grease filter buttons at the same time.



The indicator for the grease filter and one of the indicators will flash.

The lit indicator shows the programmed time:

- 1st indicator from the left = 20 hours
- 2nd indicator from the left = 30 hours
- 3rd indicator from the left = 40 hours
- 4th indicator from the left = 50 hours.

- Use the or button to select the desired time.



- Store the selection by pressing the grease filter button.

If the procedure is not stored within 4 minutes of programming, the hood will automatically default to the "old" data.

Cleaning and Care

Before cleaning or servicing the hood, disconnect it from the power supply by either removing the fuse, unplugging it from the outlet or manually "tripping" the circuit breaker.

Cleaning the casing

 Never use abrasive cleaners, scouring pads, steel wool or caustic (oven) cleaners on the hood. They will damage the surface.

- All external surfaces and controls can be cleaned with warm water and liquid dish soap applied with a soft sponge.
- Wipe dry using a soft cloth.

Do not use too much water when cleaning the controls. Water could penetrate into the electronics and cause damage.

- Glass surfaces can be cleaned using glass cleaner.

Avoid:

- cleaning agents containing soda, acids or chlorides,
- abrasive cleaning agents e.g. powder or cream cleansers,
- abrasive sponges, e.g. pot scourers or sponges which have been previously used with abrasive cleaning agents.

These will damage the surface.

Stainless steel

Stainless steel surfaces can be cleaned using a non-abrasive stainless steel cleaner.

To help prevent resoiling, a conditioner for stainless steel can also be used. Apply sparingly with even pressure.

Stainless steel colored controls

These controls may become discolored or damaged if not cleaned regularly.

Do not use a stainless steel cleaner on these controls.

Grease filters

The reusable metal grease filters remove solid particles from the vented kitchen air (grease, dust, etc).

The grease filters should be cleaned every 3 - 4 weeks or whenever the grease filter indicator lights.

A dirty filter is a fire hazard.

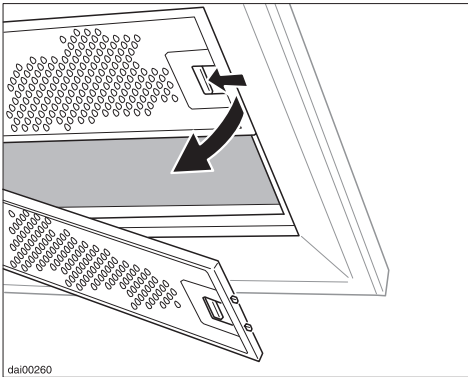

- To remove the grease filters press the locking clips in towards the middle of the filter. Holding carefully, lower and remove the filter.

- Clean the filters
 - **by hand:** use a scrub brush in warm water with a mild detergent.
 - **in a dishwasher:** place the filters vertically in the lower basket, making sure that the spray arm is not blocked.

Depending on the detergent, cleaning the grease filters in a dishwasher may cause permanent discoloration of the filter surface. Performance of the filter will not be affected by this discoloration.

- After cleaning, the filters can be placed on a towel to air dry.
- While the filters are removed, clean any dirt or grease from the filter casing to prevent the risk of fire.

When putting the grease filters back make sure that the locking clips are visible facing down towards the cooking surface.

If the filters are incorrectly installed, insert a small screwdriver into the slit along its edge to disengage it from the casing.

- After returning the grease filters, press the grease filter button for 3 seconds to reset the timer. The indicator light will go out.
- If the grease filters are cleaned before the grease filter timer has reached its maximum, the grease filter button should be pressed for 6 seconds to reset the counter to zero.

Cleaning and Care

Changing the light bulbs

Before changing the light bulbs, disconnect the hood from the power supply by either removing the fuse, unplugging it, or manually "tripping" the circuit breaker.

When in use halogen bulbs become extremely hot, and they can burn your hands. Do not attempt to change the bulbs until they have had sufficient time to cool down. Do not touch the bulb surface. Fingerprints or body oils deposited on the bulb will decrease the life of the bulb. Please follow the bulb manufacturer's instructions.

Never use the lighting without the lamp cover, ①, in place. The glass is specially made to filter harmful light rays.

Indirect lighting

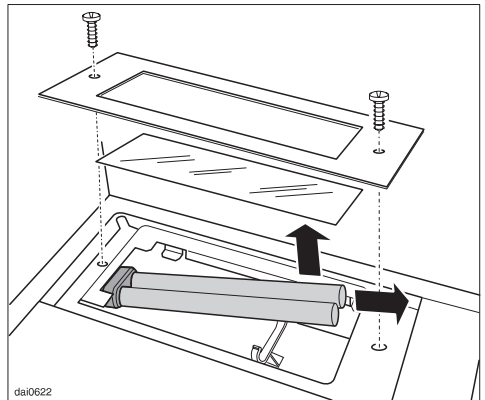

Overhead light

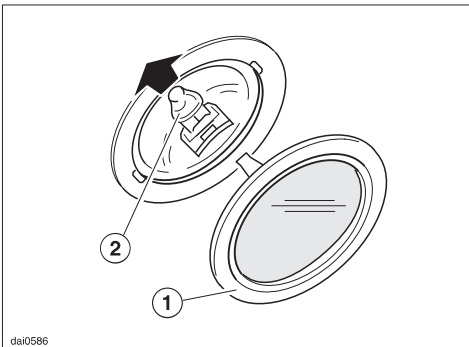

- Remove the two screws securing the light cover.
- Carefully raise the front of the bulb and pull it out of its socket.
- Insert the new bulb into the socket and lower it into its holder.
- Replace the light cover and the two screws.

- To change the halogen bulb first remove the lamp cover, ①.
- Pull the bulb, ②, out of its socket and replace with a new one.
- Now return the lamp cover, ①.

In the event of a fault which you can not correct yourself please contact:

– Your Miele Dealer

or

– The Miele Technical Service
Department

USA 1-800-999-1360
techserv@mieleusa.com

CDN 1-800-565-6435
service@miele.ca

When contacting the Technical Service Department, please quote the model and serial number of your appliance. These are shown on the data plate which is visible when the grease filter is removed.

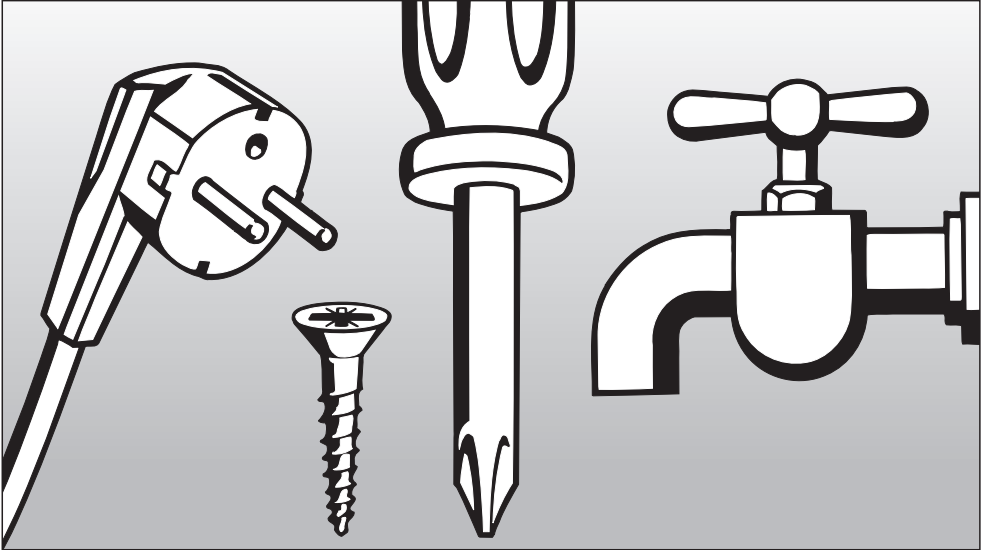

Installation Instructions

Caring for the environment

Disposal of packing material

The cardboard box and packing materials protect the appliance during shipping. They have been designed to be biodegradable and recyclable. Please recycle.

To prevent suffocation of children, ensure that any plastic wrappings, bags etc. are disposed of safely and kept out of their reach.

Disposal of an old appliance

Old appliances may contain materials that can be recycled. Please contact your local recycling authority about the possibility of recycling these materials.

Before discarding an old hood, unplug it from the outlet and cut off its power cord to prevent hazards.

The majority of the weight of the installed ventilation system will be supported by the canopy. Its mounting bracket must be firmly attached to the stud framing behind the drywall. If studs are not located in the required locations, a plywood backing (min. $\frac{1}{2}$ " (13 mm) thick) spanning at least two studs must be installed. Failure to adequately support the weight as stated may result in the ventilation system falling off the wall, causing personal injury and property damage.

(If plywood backing is not needed, proceed to "Appliance dimensions and Installation")

To install a plywood backing board

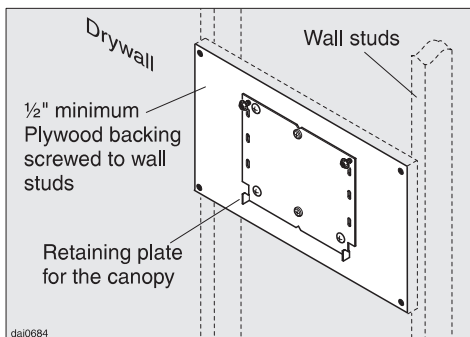

- Determine and mark the location of the retaining plate for the canopy as outlined on the Installation sheet.
- Make a cutting line 3" (76 mm) above and 3" (76 mm) below the outline of the retaining plate.

- Find the studs to the left and right of the mounting location by tapping the wall or using a stud finder.
- Mark the center of each of the studs with a vertical line.

Be careful not to damage any wiring or plumbing that may be located behind the wall. Make sure that the power supply to the area being worked in has been turned off at the breaker panel before cutting into the wall.

- Cut out the drywall along the marked lines and replace it with plywood of a matching thickness (min. $\frac{1}{2}$ " (13 mm) thick). Tape the joints and refinish the wall.
- See enclosed installation sheet for instructions on how to install the appliance.

Installation accessories

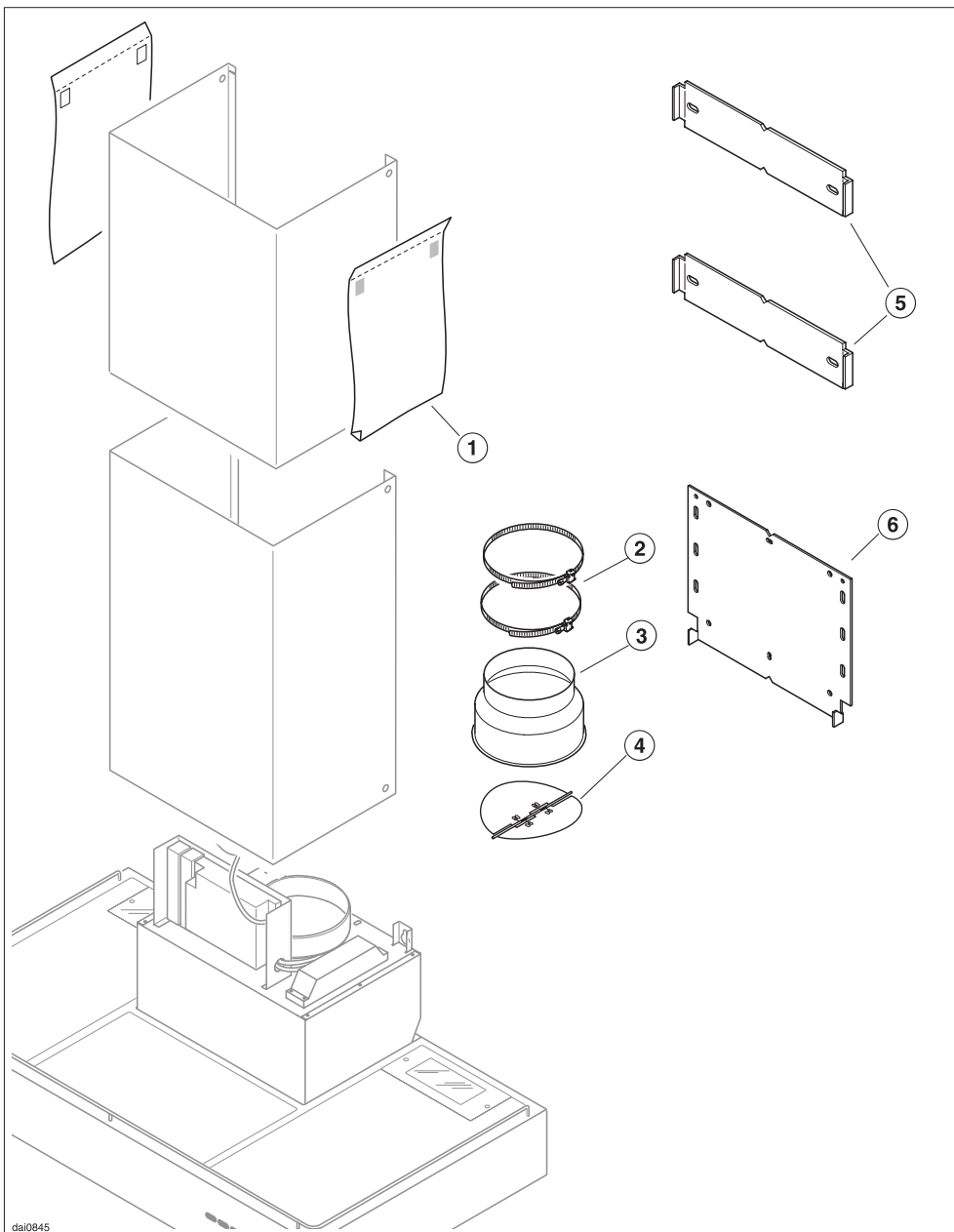

Installation accessories

① **2 protective shields**

prevent scratches to the chimney during installation.

② **2 hose clips** for securing the exhaust ducting.

③ **1 reducing collar** for use with a 5" (125 mm) exhaust ducting.

④ **1 non-return flap**

⑤ **Upper and middle retaining plate** for securing the chimney extension.

⑥ **Lower retaining plate** for securing the canopy.



4 screws 5 x 60 mm
4 washers 5.3 mm

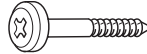

6 screws 5 x 40 mm

(The wall anchors included in the packaging are not for use in USA/CDN.)



2 M 6 locking nuts for securing the motor assembly.



4 screws 3.9 x 7.5 mm for securing the chimney and the chimney extension.

CAUTION:
During the installation process please be careful of sharp edges that can cause harm.

Electrical data

All electrical work should be performed by a qualified electrician in strict accordance with national and local safety regulations.

Installation, repairs and other work by unqualified persons could be dangerous. The manufacturer can not be held responsible for unauthorized work.

Ensure that power to the appliance is OFF while installation or repair work is performed.

Verify that the voltage, load and circuit rating information found on the data plate (located behind the grease filters), match the household electrical supply before installing the hood.

If there is any question concerning the electrical connection of this appliance to your power supply, please consult a licensed electrician or call Miele's Technical Service Department.

USA 1-800-999-1360

CDN 1-800-565-6435

WARNING:
THIS APPLIANCE MUST BE
GROUND

Important

The hood comes equipped with a 5 ft (1.5 m) power cord with a NEMA 5-15 molded plug for connection to a 120 VAC, 60 Hz, 15 A power outlet.

Maximum load

DA 252-3 456 W

DA 251, DA 259-3 436 W

Lighting

DA 252-3 4 x 20 W

DA 251, DA 259-3 3 x 20 W

Indirect lighting 2 x 13 W

Voltage 120 V

Frequency 60 Hz

Circuit rating 15 A

Appliance dimensions and Installation

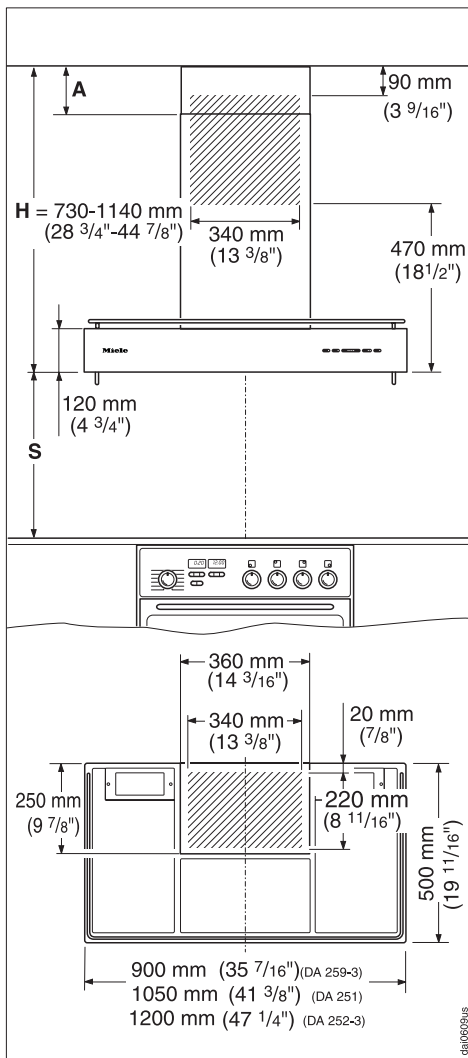

Do not install this hood over any appliance that burns solid fuel stove.

The **minimum safety distance** allowed between the top of a Miele cooking surface and the bottom of the hood **S** is:

- 22" (55 cm) above electric cooktops
- 26" (65 cm) above gas cooktops
- 26" (65 cm) above an open grill

For non-Miele cooking appliances maintain the safety distances recommended by the cooktop manufacturer in their installation and operating instructions.

If there is more than one appliance beneath the hood and they have different minimum safety distances always select the greater distance.

See "Warning and Safety instructions" for further information.

26" (65 cm) is recommended for all installations to allow for optimum work space under the hood.

Read the entire installation procedure and determine height **S** before beginning the installation. If the hood is fitted flush to the ceiling make sure that the remaining distance to the ceiling is not greater or less than appliance height **H**.

To fit the chimney, distance **A** between the top of the chimney and the ceiling must be at least $\frac{7}{8}$ " (20 mm).

 Cut out area in wall or ceiling for entrance of 6" (150 mm) ductwork or 5" (125 mm) ductwork with a reducing collar.

Appliance dimensions and Installation

If the standard unit height **H** is not suitable to the kitchen's ceiling height, longer optional chimney extensions are available from your Miele dealer or Miele's Technical Service Department.

Standard unit **H**. $28 \frac{3}{4}'' - 44 \frac{7}{8}''$
. 730 mm - 1140 mm

DATK 252/259 - 850 $44 \frac{7}{8}'' - 61''$
. 1140 mm - 1549 mm

 **WARNING**

Danger of toxic fumes.

Gas cooking appliances release carbon monoxide that can be harmful or fatal if inhaled.

The exhaust gases extracted by the hood should be vented outside of the building only.

Do not terminate the exhaust ducts in attics, garages, crawlspaces, etc.

To reduce the risk of fire, only use metal ductwork.

Please read and follow the **"IMPORTANT SAFETY INSTRUCTIONS"** to reduce the risk of personal injury. Follow all local building codes when installing the hood.

Exhaust ducting and connections

- The ducting should be as short and straight as possible, and the number of sharp bends should be minimized.
- For most efficient air extraction, the diameter of the ductwork should not be less than 6" (150 mm). Use of flat ducts also reduces the air extraction efficiency.
- Noise levels of the hood will increase if flat ducts or round ducts of less than 6" (150 mm) in diameter are used.
- Use smooth or flexible pipes made from approved non-flammable materials for exhaust ducting.
- Where the ductwork is horizontal, it must slope away from the hood at least $\frac{1}{8}$ " per foot (1cm per meter) to prevent condensation dripping into the appliance.
- If the exhaust is ducted through an outside wall, a Miele Telescopic Wall Vent can be used.

Air extraction

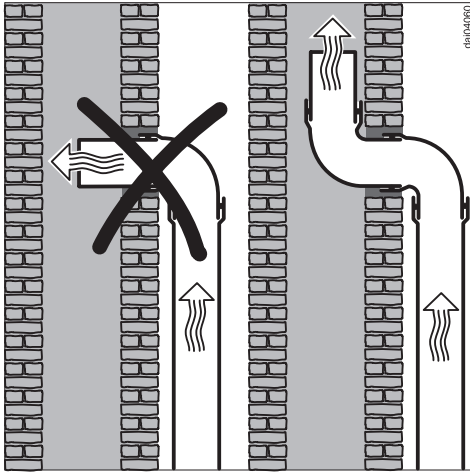

Condensate trap

Important:

If the ductwork runs through rooms, ceilings, garages, etc. where temperature variations exist, it may need to be insulated to reduce condensation. In some cases, a condensate trap may also be required to collect and evaporate any condensate which may occur.

When installing a condensate trap, ensure that it is positioned vertically and if possible directly above the exhaust outlet.

- If the exhaust is ducted into an inactive flue, the air must be expelled parallel to the flow direction of the flue.

Never connect an exhaust hood to an active chimney, dryer vent, vent flue, or room venting ductwork. Seek professional advice before connecting an exhaust hood vent to an existing, inactive chimney or vent flue.



Miele, Inc.

National Headquarters

9 Independence Way
Princeton, NJ 08540
Phone: 800-843-7231
609-419-9898
Fax: 609-419-4298
www.mieleusa.com

Technical Service & Support

Nationwide

Phone: 800-999-1360
Fax: 888-586-8056

Mid-West Region

Phone: 800-666-6740
Fax: 847-714-9434

South-East Region

Phone: 561-995-8030
Fax: 561-995-8083

West-Coast Region

Phone: 800-245-8215
Fax: 415-241-6822

Miele Limited

National Headquarters

55G East Beaver Creek Road
Richmond Hill, ON L4B 1E5
Phone: 800-565-6435
905-707-1171
Fax: 905-707-0177
www.miele.ca
info@miele.ca (general enquiries)
service@miele.ca (tech. service)

Technical Service & Support

Ontario Region

Phone: 905-707-1171
Fax: 905-707-0177

Quebec Region

Phone: 877-636-4353
Fax: 514-277-1838

British Columbia Region

Phone: 604-434-1300
Fax: 604-434-1309

Free Manuals Download Website

<http://myh66.com>

<http://usermanuals.us>

<http://www.somanuals.com>

<http://www.4manuals.cc>

<http://www.manual-lib.com>

<http://www.404manual.com>

<http://www.luxmanual.com>

<http://aubethermostatmanual.com>

Golf course search by state

<http://golfingnear.com>

Email search by domain

<http://emailbydomain.com>

Auto manuals search

<http://auto.somanuals.com>

TV manuals search

<http://tv.somanuals.com>