

Operating and Installation Instructions

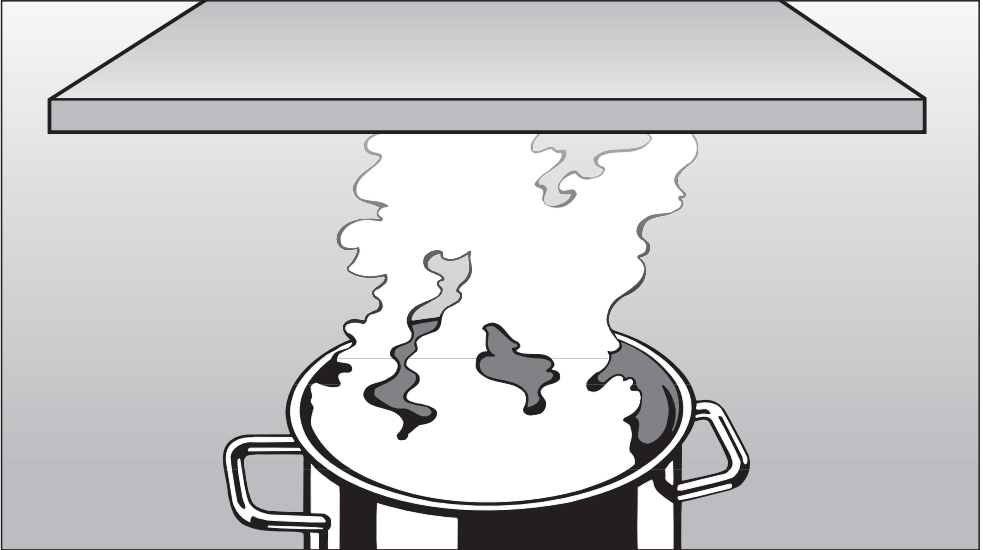

Ventilation System DA 5000 D



To prevent accidents
and machine damage,
read these instructions

before

installation or use.

en - US, CA

M.-Nr. 07 197 930

IMPORTANT SAFETY INSTRUCTIONS	4
Guide to the appliance	8
Functional description	10
Operation	11
Turning on the fan ①	11
Selecting the performance level	11
Delayed shut down "5  15"	12
Turning off the fan ①	12
Direct lighting 	12
Indirect lighting	13
Safety cut-off	13
Grease filter timer 	13
Sensor button tone	14
Cleaning and care	15
Grease filter	16
Re-setting the grease filter timer	17
Changing the halogen light bulbs	18
Changing the fluorescent light bulb	19
After Sales Service	20
Installation instructions	21
Caring for the environment	23
Installation	24
Installation instructions	24
Installation accessories	24
Structural support	25
Electrical data	26
Technical data	27
Appliance dimensions	28
Air extraction	29

IMPORTANT SAFETY INSTRUCTIONS

Read these Operating Instructions carefully before installing or using the Ventilation System.

This appliance is intended for residential use only. Use the appliance only for its intended purpose. The manufacturer cannot be held responsible for damages caused by improper use of the hood.

This appliance complies with current safety requirements. Improper use of the appliance can lead to personal injury and material damage.

READ AND SAVE THESE INSTRUCTIONS

CAUTION

Use only for general ventilation. Do not use to exhaust hazardous or explosive materials and vapors.

► This appliance is designed to vent cooking smoke and odors only.

► Be certain your appliance is properly installed and grounded by a qualified technician.

To guarantee the electrical safety of this appliance, continuity must exist between the appliance and an effective grounding system. It is imperative that this basic safety requirement be met. If there is any doubt, have the electrical system of the house checked by a qualified electrician. The manufacturer cannot be held responsible for damages caused by the lack, or inadequacy, of an effective grounding system.

► Before connecting the appliance to the power supply make sure that the voltage and frequency listed on the data plate correspond with the household electrical supply. This data must correspond to prevent machine damage. If in doubt consult a qualified electrician.

► Installation work and repairs should only be performed by a qualified technician in accordance with all applicable codes and standards. Repairs and other work by unqualified persons could be dangerous and the manufacturer will not be held responsible.

IMPORTANT SAFETY INSTRUCTIONS

► This equipment is not designed for maritime use or for use in mobile installations such as recreational vehicles or aircraft. However, under certain conditions it may be possible for an installation in these applications. Please contact the nearest Miele dealer or the Miele Technical Service Department with specific requirements.

► Before servicing or cleaning the unit, switch power off at the service panel and lock the service disconnecting means to prevent power from being switched on accidentally. If the service disconnecting means cannot be locked, securely fasten a prominent warning device, such as a tag, to the service panel.

► Before discarding an old appliance, disconnect it from the power supply and remove the power cord to prevent hazards.

Use

► Do not allow children to play with or operate the appliance or its controls. Supervise use by the elderly or infirm.

► Do not flambé or grill with an open flame beneath the hood. Flames could be drawn up into the hood by the suction and the grease filters may catch fire.

► Never operate gas burners without cookware. Turn the burner off when not in use. Adjust the burner so that the flames do not extend beneath the cookware. Do not overheat the cookware, e.g. when using a wok. The hood can be damaged due to excessive heat from the burners and the cookware.

► Do not use the hood without the grease filter in place.

► Clean the grease filter regularly. Dirty filters are a fire hazard.

► Do not use a steam cleaner to clean the hood. Steam could penetrate electrical components and cause a short circuit.

► Always turn on the hood when using the cooktop to prevent damage from condensation.

IMPORTANT SAFETY INSTRUCTIONS

WARNING - TO REDUCE THE RISK OF A COOKTOP GREASE FIRE:

- ▶ Never leave surface units unattended at high settings. Boil-overs cause smoking and greasy spillovers may ignite. Heat oils slowly on low or medium settings.
- ▶ Always turn the hood on when cooking at high heat.
- ▶ Clean ventilating fans frequently. Grease should not be allowed to accumulate on fan or filter.
- ▶ Use proper pan size. Always use cookware appropriate for the size of the surface element.

WARNING TO REDUCE THE RISK OF INJURY TO PERSONS, IN THE EVENT OF A COOKTOP GREASE FIRE, OBSERVE THE FOLLOWING:

- ▶ **SMOTHER FLAMES** with a close fitting lid, cookie sheet, or metal tray then turn off the burner.
BE CAREFUL TO PREVENT BURNS. If the flames do not go out immediately, **EVACUATE AND CALL THE FIRE DEPARTMENT.**
- ▶ **NEVER PICK UP A FLAMING PAN**
You may be burned.
- ▶ **DO NOT USE WATER**, including wet dishcloths or towels - a violent steam explosion will result.
- ▶ Use a fire extinguisher **ONLY** if:
 - You have a class ABC extinguisher, and you know how to operate it.
 - The fire is small and contained in the area where it started.
 - The fire department is being called.
 - You can fight the fire with your back to an exit.

IMPORTANT SAFETY INSTRUCTIONS

Installation

▶ **WARNING**

To reduce the risk of fire only use metal duct work.

▶ Any fittings, sealant, or materials used to install the duct work must be made of approved non-flammable materials.

▶ Provided a larger distance is not given by the manufacturer of the cooktop, follow the minimum safety distances between a cooktop and the bottom of the hood:

- 22" (550 mm) above electric cooktops,
- 30" (762 mm) above gas cooktops,
- 26" (650 mm) above an open electric grill or an open electric boiler/fryer.

If local building codes require a greater safety distance, follow their requirement.

If there is more than one appliance beneath the hood and they have different minimum safety distances always select the greater distance.

- ▶ Do not install this hood over cooktops burning solid fuel.
- ▶ Be careful not to damage hidden electrical wiring or plumbing when cutting or drilling into the wall or ceiling.
- ▶ Do not use an extension cord to connect the appliance to electricity. Extension cords do not guarantee the required safety of the appliance, (e.g. danger of overheating).

▶ Never connect an exhaust hood to an active chimney, dryer vent, vent flue, or room ventilating duct work. Seek professional advice before connecting an exhaust hood vent to an existing, inactive chimney or vent flue.

▶ Ducted fans must always be vented outdoors.

▶ Make sure that the airflow in the room is sufficient for combustion and exhausting of all non-electric heating appliances (water heaters, gas cooktops, gas ovens, etc.), otherwise back drafts may occur. Follow the heating manufacturer's guidelines and safety standards or those published by the National Fire Protection Association (NFPA) or the American Society for Heating, Refrigeration and Air Conditioning Engineers (ASHRAE). If in doubt, consult an experienced professional.

Guide to the appliance

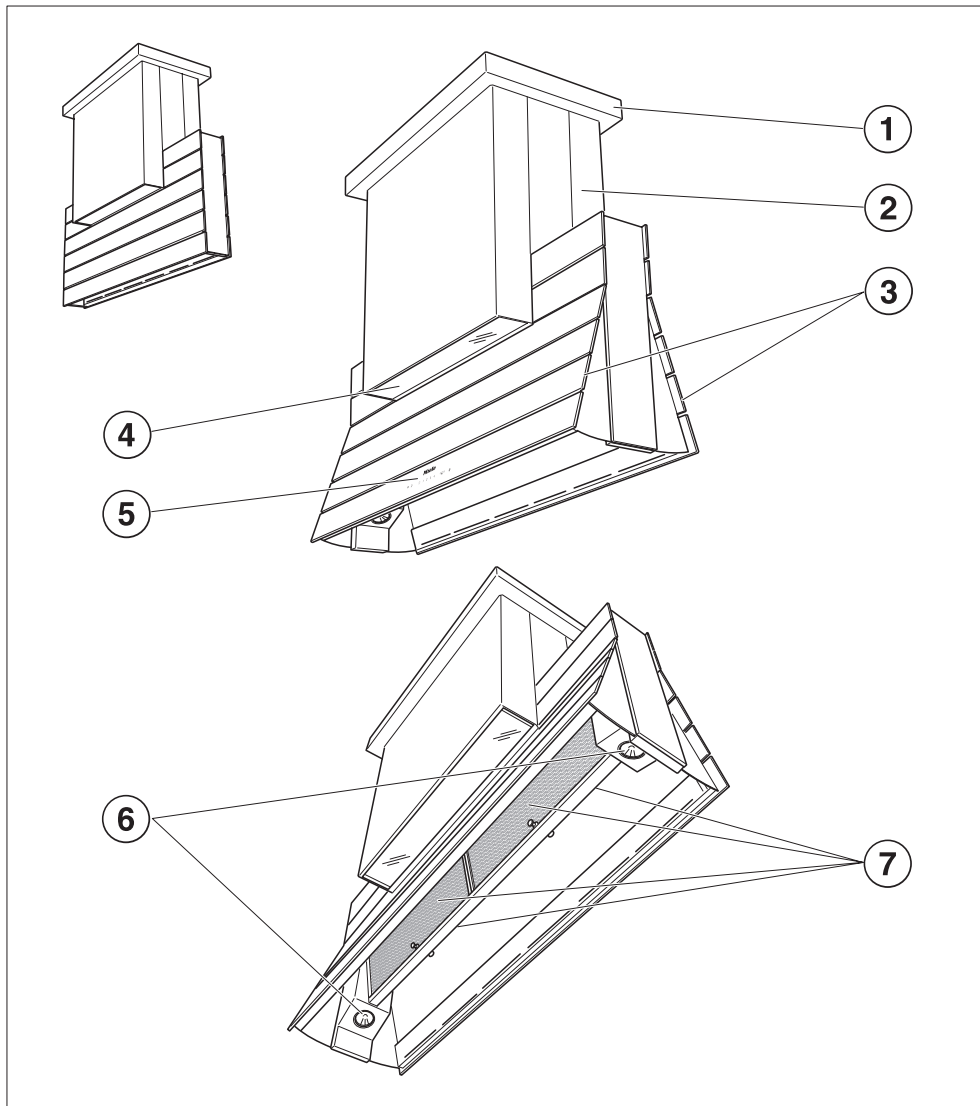

6482203

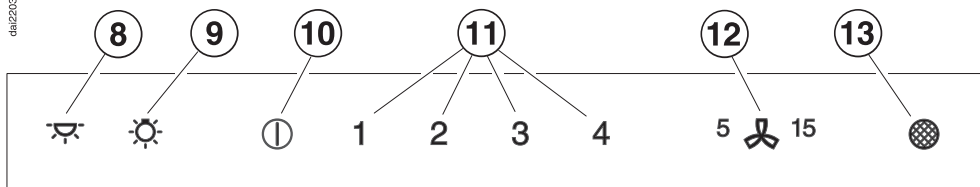

① Covering frame

② Chimney

③ Canopy

The canopy opens as soon as the fan is turned on.

④ Indirect lighting

⑤ Control panel

The symbols serve as sensor buttons. To select a function, touch the sensor button. A brief tone is heard as confirmation.

⑥ Direct lighting

⑦ Grease filter

Sensor buttons

⑧ Indirect lighting

⑨ Direct lighting

Use this button to switch the direct lighting On/Off, and to adjust the brightness.

The lighting can be used independently from the fan.

⑩ Fan On/Off

⑪ Fan power selection

⑫ Delayed shut down

This button activates the Delayed Shut Down feature. The fan can be set to turn off automatically after 5 or 15 minutes.

⑬ Grease filter

This sensor button will light up when the grease filter needs to be changed.

This sensor button is also used:

- to reset the grease filter timer after cleaning the grease filters (see "Cleaning and care").
- to check how long the grease filters have been in use (see Operation / Grease filter timer").
- to change the number of hours counted by the grease filter timer (see Operation / Grease filter timer").

Functional description

The ventilation hood works by **air extraction**. The air is drawn in and cleaned by the grease filter and directed outside.

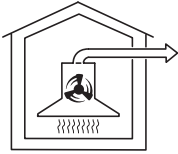

The hood comes equipped with a **non-return flap**. This flap automatically closes when the hood is turned off so that no exchange of outside air and room air can occur. When the hood is turned on, the air pressure of the exhaust fan automatically opens the flap blowing the inside air and cooking odors outside.

Turning on the fan ①

- Touch the "①" sensor button.

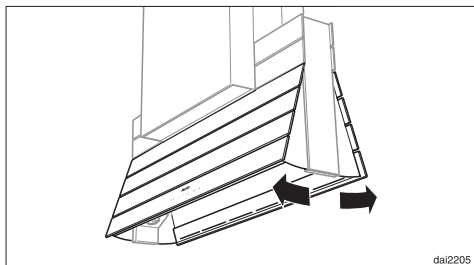

The fan switches on to level "2".
The sensor buttons "①" and "2" light.
The canopy now opens.

Selecting the performance level

Typically, levels "1" to "3" are sufficient for regular cooking needs.

- Touch the sensor button "1", "2" or "3" to select the desired power level.

Intensive setting

- To remove intensive vapors or odors, for example when pan-frying, select power level "4" temporarily.

Automatically switching back the intensive setting

The intensive level "4" can be programmed to automatically switch back to level "3" after 10 minutes.

- Turn off the fan and lights.
- Press and hold the "5  15" sensor button for approx. 10 seconds, until the sensor button "1" lights up.
- Press the following buttons one after another,
 - the "☼" sensor button,
 - the "1" sensor button, and
 - the "☼" sensor button again.

If the function is not activated, the sensor buttons "1" and "4" will flash.

- To activate the function, touch the "4" sensor button.
The sensor buttons "1" and "4" will light, without flashing.
To de-activate, touch sensor button "1".
- Confirm the process by touching the "5  15" sensor button.

If the procedure is not confirmed within 4 minutes of programming, the hood will automatically default to the "old" data.

Operation

Delayed shut down "5 15"

If odors or smoke remain in the kitchen after cooking has been completed, the Delayed Shut Down feature can be selected to allow the hood to continue running for either 5 or 15 minutes.

- While the fan is still running, touch the "5  15" sensor button:

Press once : the fan automatically turns off after 5 minutes ("5" lights).

Press twice : the fan automatically turns off after 15 minutes ("15" lights).

To de-activate the delay feature, touch the button again. The fan will not automatically switch off.

Turning off the fan

- Touch the "" sensor button to turn off the fan.

The canopy now closes.

- If you would like the canopy to remain open after the fan is shut off (for example, for cleaning), press and hold the active fan level for approx. 5 seconds while the fan is running, until the fan shuts off. The canopy remains open.
To turn it back on, select any fan level.

Direct lighting

The lighting can be used independently from the fan.

Direct lighting on

- To turn on, briefly touch the "" sensor button.

The lighting comes on at maximum brightness.

Dimming the lighting

The brightness of the lighting can be adjusted.

- With the lighting on, press and hold the "" sensor button.
The lighting will dim until the button is released.
- If the button is pressed again, the lighting will brighten until the button is released.

If the button is pressed continuously, the light will cycle between bright and dark.

Direct lighting off

- Briefly touch the "" sensor button to turn off the light.

Indirect lighting

Touch the "☾" sensor button to turn the indirect lighting On/Off.

Safety cut-off

If the exhaust hood is left unattended for more than 10 hours, the fan automatically turns off. The lighting remains on.

- Touch the "⌚" sensor button to turn the fan back on again.

Grease filter timer

The appliance records how many hours the exhaust hood has been in operation.

The grease filter timer will signal when the grease filter needs to be cleaned.

After approx. 30 hours of operation, or the pre-selected operating time, the "⊗" sensor button will light. This means it is time to clean the grease filter.

After cleaning, the timer will need to be re-set (see "Cleaning and care").

Checking the grease filter timer

To check the percentage of time already used:

- Touch the "⌚" sensor button to turn on the fan.
- Hold down the "⊗" sensor button.

One or more of the sensor buttons "1" to "4" will flash.

The number of flashing sensor buttons indicates the percentage of operating time already passed.

Sensor button "1"	=	25 %
Sensor buttons "1" and "2"	=	50 %
Sensor buttons "1" to "3"	=	75 %
Sensor buttons "1" to "4"	=	100 %

This information will remain stored in memory in the event of a power failure.

Operation

Reprogramming the grease filter timer

The grease filter timer is preset to 30 hours. This time can be lengthened or shortened to 20, 30, 40, or 50 hours depending on your cooking habits.

- A time of 20 hours should be programmed in kitchens with frequent pan or deep frying.
- A time of 20 hours should also be programmed if the kitchen is only used occasionally. This will help to prevent grease which has accumulated over a long period of time from hardening on the filters making cleaning more difficult.
- If you typically use very little fat for cooking, an interval of 40 or 50 hours can be selected.

To reprogram the timer:

- Touch the "1" sensor button to turn off the fan.
- Touch the sensor buttons "5" and "15" and "15" at the same time.

The sensor button "15" and one of the sensor buttons "1" to "4" will flash.

The sensor buttons "1" to "4" show the amount of time set:

Sensor button "1" = 20 hours
Sensor button "2" = 30 hours
Sensor button "3" = 40 hours
Sensor button "4" = 50 hours

- To select a shorter time, touch the sensor button "1".
To select a longer time, touch the sensor button "4".
Hold the sensor button until the desired time is set.
- Confirm the process by touching the "15" button.

All the lights go out.

If the procedure is not confirmed within 4 minutes of programming, the hood will automatically default to the "old" data.

Sensor button tone

Whenever you select a feature with the sensor buttons, a brief tone is heard.

You can de-activate this tone if desired.

- Touch the "1" sensor button to turn off the fan.
- Simultaneously, press and hold the sensor buttons "4" and "15" for approx. 5 seconds, until a brief tone is heard. The tone is now turned off for all functions.
- To re-activate the tone, follow the same steps.

If the exhaust hood is disconnected from the power supply, or after a power interruption, the tone is automatically re-activated, regardless of the previous settings.

Before cleaning or servicing the hood, disconnect it from the power supply by either removing the fuse, unplugging it from the outlet, or manually "tripping" the circuit breaker.

Cleaning the casing

Warning: Never use abrasive cleaners, scouring pads, steel wool or caustic (oven) cleaners on the hood. They **will** damage the surface.

Read the following instructions to avoid damage.

- All external surfaces and controls should be cleaned with warm water and liquid dish soap applied with a soft sponge.
- Wipe dry using a soft cloth.

Do not use too much water when cleaning the controls. Water could penetrate the electronics and cause damage.

Avoid:

- cleaning agents containing soda, acids or chlorides,
- abrasive cleaning agents, e.g. powder or cream cleansers,
- abrasive sponges, i.e. pot scourers or sponges which have been previously used with abrasive cleaning agents.

These will damage the surface.

Stainless steel

Stainless steel surfaces can be cleaned using a non-abrasive stainless steel cleaner.

To help prevent resoiling, a conditioner for stainless steel can be applied.

Cleaners are available from Miele.

Glass surfaces

Glass surfaces can be cleaned using a glass cleaner.

Cleaning and care

Grease filter

The reusable metal grease filters remove solid particles from the vented kitchen air (grease, dust, etc) and help keep the exhaust hood clean.

At the latest, clean the grease filter when the "⊗" sensor button lights up.

The grease filters should be cleaned every 3 - 4 weeks or when the grease filter indicator lights.

A dirty filter is a fire hazard.

To remove the grease filter, first open the canopy.

- Touch the "⊕" sensor button to turn on the fan.

The fan switches to level "2".

The canopy opens.

- Press and hold the "2" sensor button for approx. 5 seconds, until the fan turns off. The canopy remains open.

Be sure to support the grease filter so that it does not fall onto the cooktop.

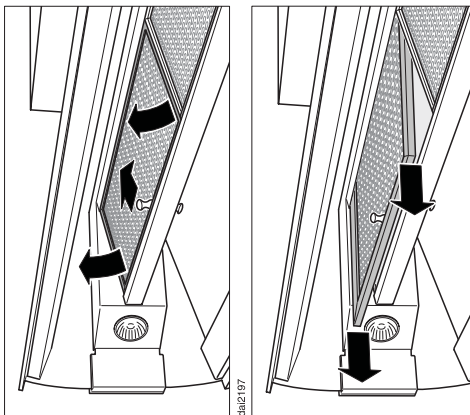

- Press slightly upward on the grease filter handle to release it from the lower rail, pivot forward and lower it downward.

Cleaning the grease filter

- **By hand:** use a scrub brush with a solution of warm water and mild dish soap. Do not use the pure detergent, aggressive all purpose cleaners, oven sprays, abrasive cleaning agents or limescale removers. They could damage the filter.
- **In a dishwasher:** place the filter vertically in the lower basket, making sure that the spray arm is not blocked. Use a hot temperature program, e.g. "Heavy Soil" or "Pots and pans". Use the recommended amount of dishwasher detergent. Overuse could damage the filter.

Depending on the detergent, cleaning the grease filters in a dishwasher may cause permanent discoloration of the filter surface. Performance of the filter is not affected by this discoloration.

- After cleaning, the filters can be placed on a towel to air dry.
- While the filters are removed, clean any dirt or grease from the filter casing.

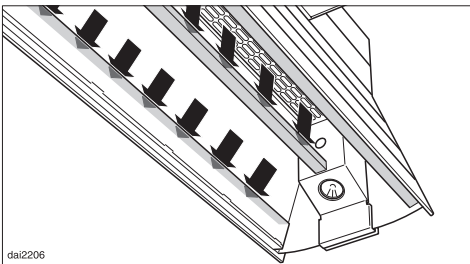

- There is a groove on both sides of the canopy, to collect grease. These grooves and the retainers for the grease filter should be cleaned every time the filter itself is cleaned.
- Put the grease filter back in place.
- Touch any sensor button from "1" to "4". The fan turns back on.

Re-setting the grease filter timer

Each time you clean the grease filter re-set the counter.

- Touch the "1" sensor button to turn on the fan.
- Press and hold the "⊗" sensor button for approx. 3 seconds, until only the sensor button "1" is flashing. The light for sensor button "⊗" will go out.

If you clean the grease filter **before** the counter reaches the maximum number of hours:

- Press and hold the "⊗" sensor button for approx. 6 seconds, until only sensor button "1" is flashing.

Cleaning and care

Changing the halogen light bulbs

To change the halogen bulbs, first open the canopy.

- Touch the "⓪" sensor button.

The fan turns on to level "2".
The canopy opens.

- Press and hold the "2" sensor button for approx. 5 seconds, until the fan turns off. The canopy remains open.

Disconnect the exhaust hood from the power supply by either removing the fuse, unplugging it, or manually "tripping" the circuit breaker.

- Remove the grease filter from the appliance, see "Cleaning and care / Grease filter".

When in use halogen bulbs become extremely hot, use caution. Do not attempt to change the bulbs until they have had sufficient time to cool.

Do not touch the bulb surface. Fingerprints or body oils deposited on the bulb will decrease its life. Follow the bulb manufacturer's instructions.



- Through the opening above the light, press the lighting unit slightly downward.
- Then turn the halogen light to the left to remove it from the fixture.

Use the same bulb type as a replacement.

- Screw the new halogen bulb into the fixture and press it upward.
- Put the grease filter back in place.
- Re-connect the exhaust hood to the power supply.
The canopy will now close.

Changing the fluorescent light bulb

Disconnect the exhaust hood from the power supply by either removing the fuse, unplugging it, or manually "tripping" the circuit breaker.

To prevent damage to the glass cover and the cooking surface, be sure to securely handle the glass cover.

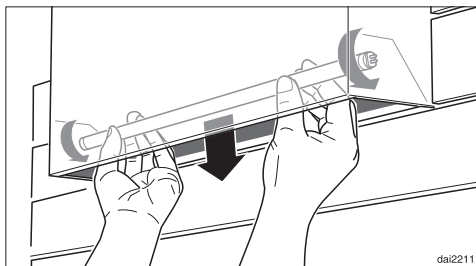

- Rotate the fluorescent tube approx. 180° and downward to remove.

Use the same type of tube as a replacement.

- Replace the lighting in the reverse order.

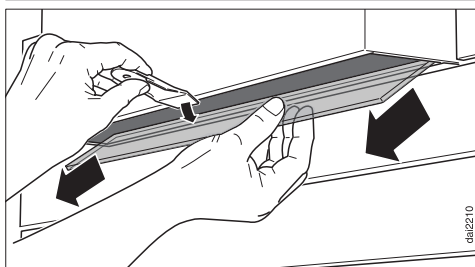
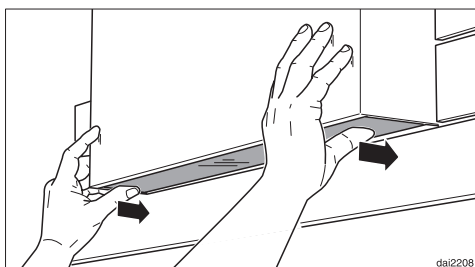

- Shift the glass cover toward the back slightly, then tilt the front down and remove. If needed, use a tool to tilt the glass cover downward.

After Sales Service

Repairs

In the event of a fault which you cannot easily fix yourself, please contact the Miele Technical Service Department.

- When contacting Technical Service, please quote the model and serial number of your appliance.

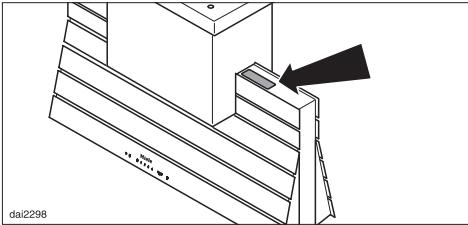

These are shown on the data plate which is visible on top of the canopy.

MieleCare

(USA only)

MieleCare, our Extended Service Contract program, gives you the assurance of knowing that your appliance investment is covered by 5 years of worry free ownership.

MieleCare is the only Extended Service Contract in the industry that guarantees repairs by a Miele Authorized Service Provider using genuine Miele parts. Only genuine Miele parts installed by factory trained professionals can guarantee the safety, reliability, and longevity of your Miele appliance.

Please note that unless expressly approved in writing by Miele's Service department, Extended Service Contracts offered by other providers for Miele products will not be recognized by Miele. Our goal is to prevent unauthorized (and untrained) service personnel from working on your Miele products, possibly doing further damage to them, you and/or your home.

To learn more about **MieleCare** Extended Service Contracts, please contact your appliance dealer or visit us online at:

<http://store.miele.com>

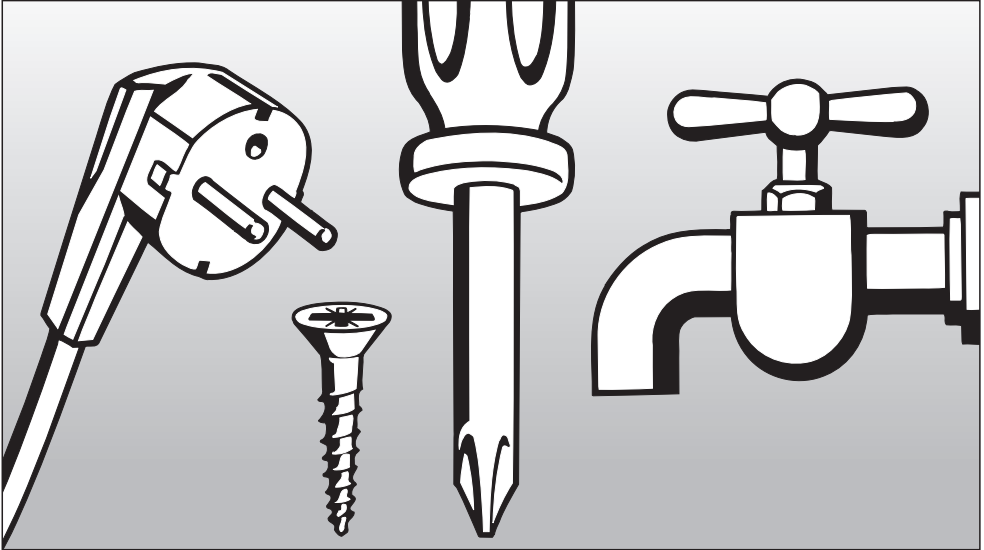

Installation Instructions

Disposal of packing material

The cardboard box and packing materials protect the appliance during shipping. They have been designed to be biodegradable and recyclable. Please recycle.

To prevent suffocation of children, ensure that any plastic wrappings, bags, etc. are disposed of safely and kept out of their reach.

Disposal of an old appliance

Old appliances may contain materials that can be recycled. Please contact your local recycling center about the possibility of recycling these materials.

Before discarding an old hood, unplug it from the outlet and cut off its power cord to prevent hazards.

Installation

Installation instructions

- See the enclosed Installation Instruction sheet.
- Please read the "Important Safety Instructions" and Installation instructions before installing the hood.

Installation accessories

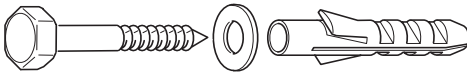

8 screws 8 x 60 mm with
8 washers to secure the ceiling plate to the ceiling.

(S10 wall anchors included in the packaging are not for use in USA/CDN)



2 screws M4 x 8 mm for securing the chimney.



8 leveling sheets to correct any variance in the ceiling.

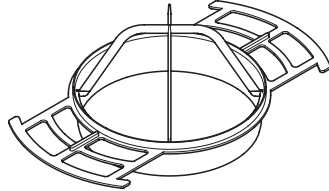

1 exhaust nozzle

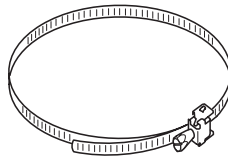

1 hose clamp to secure the ducting.

The ceiling mounting plate will support the weight of the hood. This ceiling plate must be attached to rigid structural framing that is supported in its entirety by the ceiling joists, or to the ceiling joists directly. Do not attach the plate directly to the ceiling with anchors, toggle bolts, etc.

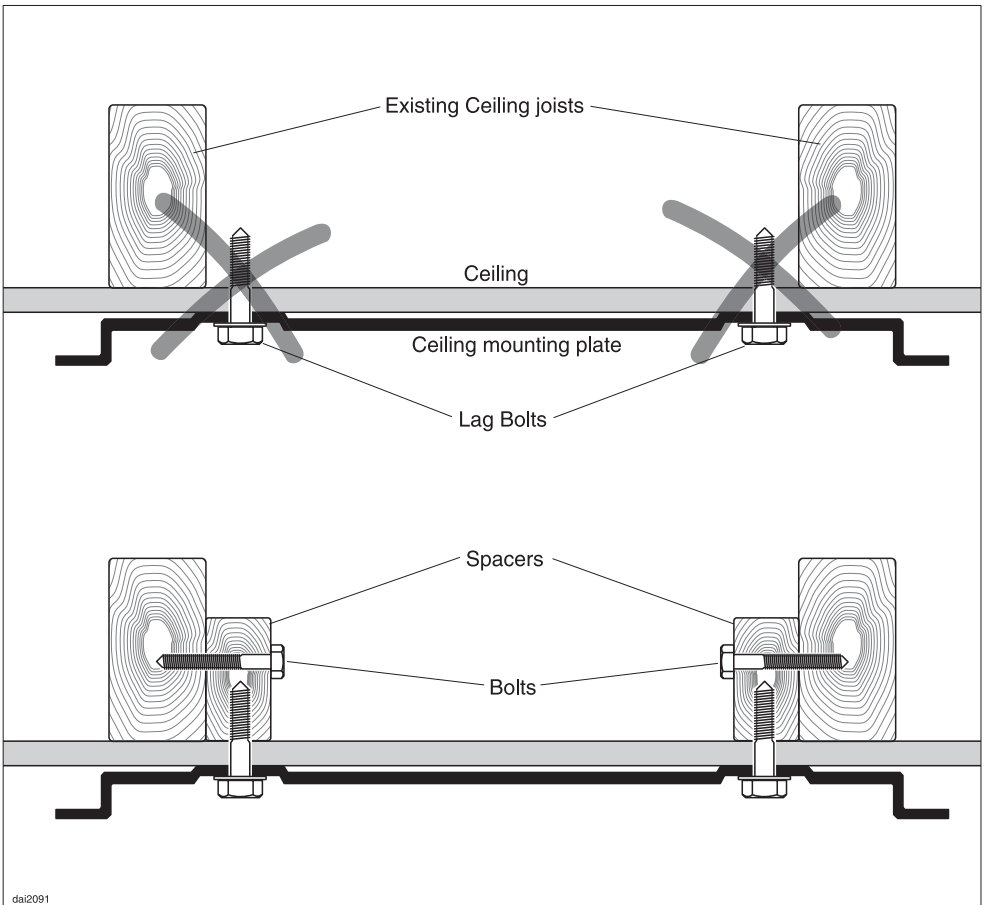

Electrical data

All electrical work should be performed by a qualified electrician in strict accordance with national and local safety regulations. Installation, repairs and other work by unqualified persons could be dangerous. The manufacturer can not be held responsible for unauthorized work. Ensure that power to the appliance is OFF while installation or repair work is performed.

- Verify that the voltage, load and circuit rating information found on the data plate (located behind the grease filter), match the household electrical supply before installing the hood.

If there is any question concerning the electrical connection of this appliance to your power supply, please consult a licensed electrician or call Miele's Technical Service Department. See back cover for contact information.

WARNING: THIS APPLIANCE MUST BE GROUNDED

Important
To increase security before the machine is installed, it is recommended to install a protective switch (30 mA).

Important

The hood must be hard wired accordingly:

Black/Red wire: connect to L1 (live)

White wire: connect to N (neutral)

Green wire: . . connect to GND (ground)

Technical data

Total connected load.	772 W
– fan motor.	640 W
– canopy drive.	4 W
– direct lighting	2 x 50 W
– indirect lighting	2 x14 W
Power supply voltage.	120 V
Frequency	50 Hz
Circuit rating.	10 A
Weight	132 lbs (60 kg)

Appliance dimensions

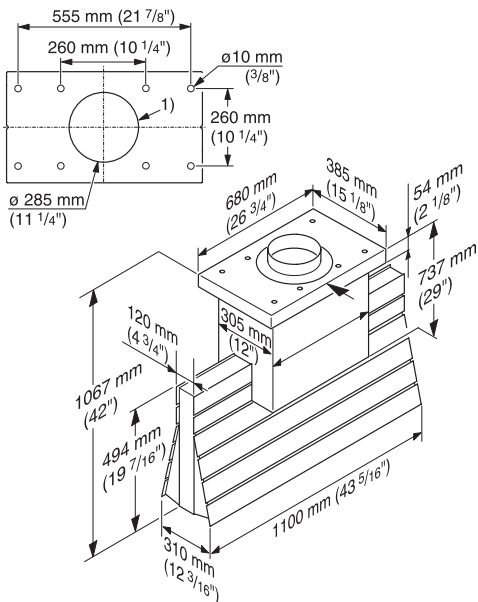

1) Feed-through for the duct work and the power cord

Exhaust connection $\varnothing 7 \frac{7}{8}$ " (200 mm)

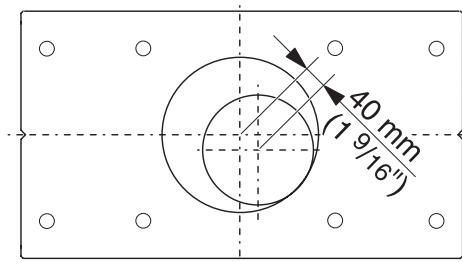

The exhaust connection is adjustable. This makes installation possible if the exhaust opening in the ceiling is not centered directly above the cooking surface. A maximum variance of $1 \frac{9}{16}$ " (40 mm) in each direction is possible.

Do not install this exhaust hood over cooktops burning solid fuel.

Provided a larger distance is not given by the manufacturer of the cooktop, follow the minimum safety distances between a cooktop and the bottom of the hood:

- 22" (550 mm) above electric cooktops,
- 30" (762 mm) above gas cooktops,
- 26" (650 mm) above an open electric grill or an open electric boiler/fryer.

If local building codes require a greater safety distance, follow their requirement.

If there is more than one appliance beneath the hood and they have different minimum safety distances always select the greater distance.

See "Important Safety Instructions" for further information.

CAUTION:
During the installation process, please be careful of sharp edges that can cause harm.

 **WARNING**

Danger of toxic fumes.

Gas cooking appliances release carbon monoxide that can be harmful or fatal if inhaled. The exhaust gases extracted by the hood should be vented outside of the building only.

Do not vent exhaust air into spaces within walls or ceilings, or in attics, crawl spaces or garages.

To reduce the risk of fire, only use metal duct work.

Please read and follow the **"IMPORTANT SAFETY INSTRUCTIONS"** to reduce the risk of personal injury. Follow all local building codes when installing the hood.

Exhaust ducting and connections

- The ducting should be as short and straight as possible, and the number of sharp bends should be minimized.
- For most efficient air extraction, the diameter of the duct work should not be less than $7 \frac{7}{8}$ " (200 mm). Use of flat ducts also reduces the air extraction efficiency.
- Noise levels of the hood will increase if flat ducts or round ducts of less than $7 \frac{7}{8}$ " (200 mm) in diameter are used.
- Use smooth or flexible pipes made from approved non-flammable materials for exhaust ducting.
- Where the duct work is horizontal, it must slope away from the hood at least $\frac{1}{8}$ " per foot (1 cm per meter) to prevent condensation dripping into the appliance.

Air extraction

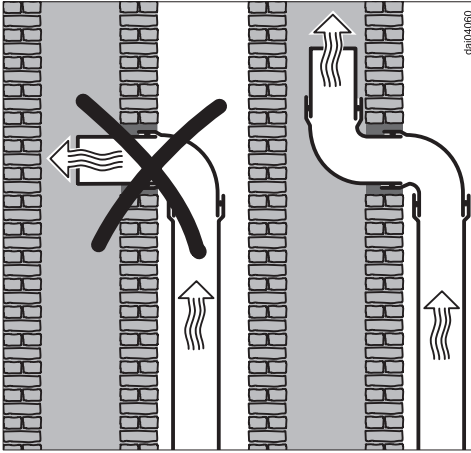

- If the exhaust is ducted into an inactive flue, the air must be expelled parallel to the flow direction of the flue.

Important

If the duct work runs through rooms, ceilings, garages, etc. where temperature variations exist, it may need to be insulated to reduce condensation.

**Please have the model and serial number
of your appliance available before
contacting Technical Service.**

The Miele logo is displayed in a bold, white, serif font against a solid black rectangular background.

**U.S.A.
Miele, Inc.**

National Headquarters

9 Independence Way
Princeton, NJ 08540
Phone: 800-843-7231
609-419-9898
Fax: 609-419-4298
www.miele.com

**Technical Service & Support
Nationwide**

Phone: 800-999-1360
Fax: 888-586-8056
TechnicalService@mieleusa.com

**Canada
Miele Limited**

Headquarters and Showroom

161 Four Valley Drive
Vaughan, ON L4K 4V8
Phone: 800-643-5381
905-660-9936
Fax: 905-532-2290
www.miele.ca
info@miele.ca (general enquiries)
professional@miele.ca (commercial
enquiries)

MieleCare National Service

Phone: 800-565-6435
905-532-2272
Fax: 905-532-2292
service@miele.ca (technical enquiries)

Free Manuals Download Website

<http://myh66.com>

<http://usermanuals.us>

<http://www.somanuals.com>

<http://www.4manuals.cc>

<http://www.manual-lib.com>

<http://www.404manual.com>

<http://www.luxmanual.com>

<http://aubethermostatmanual.com>

Golf course search by state

<http://golfingnear.com>

Email search by domain

<http://emailbydomain.com>

Auto manuals search

<http://auto.somanuals.com>

TV manuals search

<http://tv.somanuals.com>