

Operating and installation instructions

Cooker hood

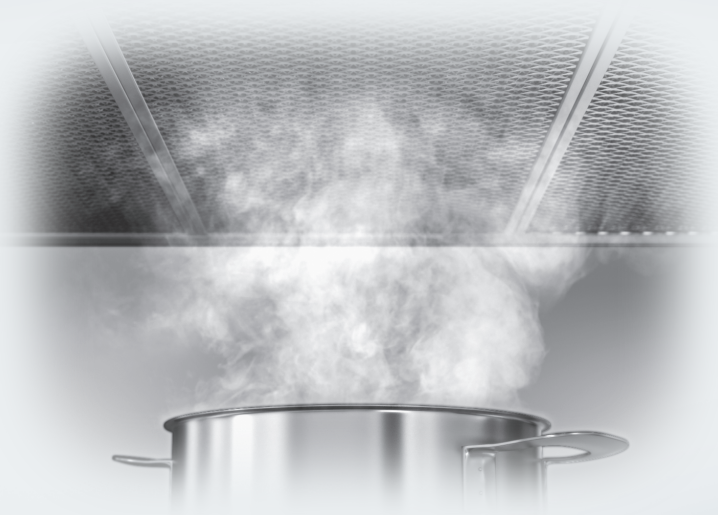

To prevent the risk of accidents or damage to the appliance, it is **essential** to read these instructions before it is installed and used for the first time.

Contents

Warning and Safety instructions	4
Caring for the environment	13
Modes of operation	14
Con@ctivity 2.0 function.....	15
Guide to the appliance	16
Operation (Automatic mode)	18
Cooking with Con@ctivity 2.0 (Automatic mode).....	18
Leaving automatic mode temporarily.....	20
Returning to automatic mode.....	20
Operation (Manual mode)	21
Cooking without Con@ctivity 2.0 (Manual mode).....	21
Switching the fan on.....	21
Selecting the power level.....	21
Selecting run-on time.....	21
Switching the fan off.....	21
Switching the hob lighting on / off.....	21
Power management.....	22
Operation (Automatic and Manual modes)	23
Operating hours counter.....	23
Altering the operating hours counter for the grease filters.....	23
Reading the filter operating hours counter.....	24
Cleaning and care	25
Housing.....	25
Grease filters.....	25
Resetting the grease filter operating hours counter	27
After Sales / Guarantee	28
Position of the data plate.....	28
Installation	29
Before installation.....	29
Protective foil.....	29
Installation instructions.....	29
Dismantling.....	29
Assembly parts.....	30
Appliance dimensions.....	32
Safety distance between hob and cooker hood.....	33
Installation recommendations.....	34

Contents

Drilling diagram for wall mounting.....	34
Connection for air extraction	35
Condensate trap.....	36
Silencer.....	36
Electrical connection	38
Activating Con@ctivity 2.0	39
Installing the Con@ctivity 2.0 Stick.....	39
Activating Con@ctivity 2.0.....	39
Activating the cooker hood.....	39
Activating the hob.....	39
Activation check.....	39
Technical data	41
Conformity declaration.....	41

Warning and Safety instructions

This appliance complies with all relevant local and national safety requirements. Inappropriate use can, however, lead to personal injury and damage to property.

To avoid the risk of accidents and damage to the appliance, please read these instructions carefully before using it for the first time. They contain important notes on the safety, installation, use and maintenance of the appliance. Miele cannot be held liable for non-compliance with these instructions.

Keep these instructions in a safe place and ensure that all users are familiar with the contents. Pass them on to any future owner of the appliance.

Correct application

- ▶ This cooker hood is intended for use in domestic households and similar working and residential environments.
- ▶ The cooker hood is not intended for outdoor use.
- ▶ It must only be used as a domestic appliance to extract vapours and remove odours from cooking. Any other usage is not supported by the manufacturer and could be dangerous.
- ▶ The cooker hood can only be used by people with reduced physical, sensory or mental capabilities, or lack of experience and knowledge, if they are supervised whilst using it, or have been shown how to use it in a safe way and recognise and understand the consequences of incorrect operation.

Safety with children

- ▶ Children under 8 years of age must be kept away from the cooker hood unless they are constantly supervised.
- ▶ Children 8 years and older may only use the cooker hood unsupervised if they have been shown how to use it safely and recognise and understand the consequences of incorrect operation.

Warning and Safety instructions

- ▶ Children must not be allowed to clean or maintain the cooker hood unsupervised.
- ▶ Please supervise children in the vicinity of the cooker hood and do not let them play with it.
- ▶ Danger of suffocation. Packaging, e.g. plastic wrappings, must be kept out of the reach of babies and children. Whilst playing, children could become entangled in packaging or pull it over their head and suffocate.

Warning and Safety instructions

Technical safety

- ▶ Unauthorised installation, maintenance and repairs can cause considerable danger for the user. Installation, maintenance and repairs must only be carried out by a Miele authorised technician.
- ▶ A damaged appliance can be dangerous. Check it for visible signs of damage. Do not use a damaged appliance.
- ▶ The electrical safety of this appliance can only be guaranteed when correctly earthed. It is essential that this standard safety requirement is met. If in any doubt please have the electrical installation tested by a qualified electrician.
- ▶ Before connecting the appliance to the mains supply, ensure that the connection data on the data plate (voltage and frequency) match the mains electricity supply. This data must correspond in order to avoid the risk of damage to the appliance. Consult a qualified electrician if in any doubt.
- ▶ Do not connect the appliance to the mains electricity supply by a multi-socket unit or an extension lead. Extension leads are a fire hazard and do not guarantee the required safety of the appliance.
- ▶ For appliances with an external motor fitted (...EXT models) the connection of the two units must be made using the connection cable and the plug connectors.
These models may only be combined with a Miele external motor.

Warning and Safety instructions

- ▶ For safety reasons, this appliance may only be used after it has been built in.
- ▶ The cooker hood must not be used in a non-stationary location (e.g. on a ship).
- ▶ Tampering with electrical connections or components and mechanical parts is highly dangerous to the user and can cause operational faults.
Only open the housing as described in the instructions given in the installation sheet and in the Cleaning and care section of this booklet. Under no circumstances should any other parts of the housing be opened.
- ▶ The manufacturer's warranty will be invalidated if the appliance is not repaired by a Miele approved service technician.
- ▶ Miele can only guarantee the safety of the appliance when genuine original Miele replacement parts are used. Faulty components must only be replaced by Miele spare parts.
- ▶ If the electrical connection cable is faulty it must only be replaced by a Miele authorised service technician to protect the user from danger.
- ▶ During installation, maintenance and repair work, the appliance must be disconnected from the mains electricity supply.

Warning and Safety instructions

Using at the same time as other heating appliances that depend on the air from the room

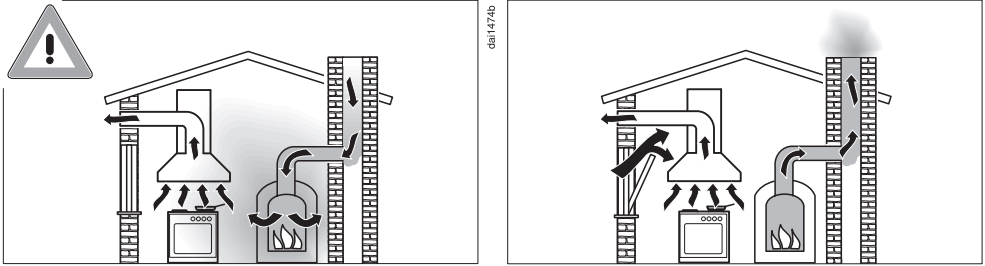

Warning - danger of toxic fumes

Great care should be taken when using the cooker hood at the same time and in the same room or area of the house as another heating appliance which depends on the air in the room. Such appliances include gas, oil, wood or coal-fired boilers and heaters, continuous flow or other water heaters, gas hobs, cookers or ovens which draw air in from the room and duct exhaust gases out through a chimney or extraction ducting.

When used in extraction mode, with or without an external motor fitted, the appliance draws air in from the room in which it is installed and from neighbouring rooms.

If there is insufficient air, an underpressure will occur. The heating appliance will be starved of oxygen, impairing combustion. Harmful gases could be drawn out of the chimney or extraction ducting back into the room, with potentially fatal consequences.

Warning and Safety instructions

In order to ensure safe operation, and to prevent gases given off by the heating appliances from being drawn back into the room when the cooker hood and the heater are in operation simultaneously, an underpressure in the room of 0.04 mbar (4 pa) is the maximum permissible.

Ventilation can be maintained by air inlets which cannot be blocked, in windows, doors or outside wall vents, or by other technical measures, such as ensuring that the cooker hood can only be switched on when the heating appliance is switched off or vice versa. A ventilation brick alone is not generally sufficient to ensure safe ventilation.

The overall ventilation condition of the dwelling must be taken into account. If in any doubt, the advice of a competent builder or, for gas a qualified gas fitter (registered with an official gas safety body in accordance with national safety regulations, GasSafe in the UK) must be sought.

Warning and Safety instructions

Correct use

- ▶ Never use an open flame beneath the cooker hood. To avoid the danger of fire, do not flambé or grill over an open flame. When switched on, the cooker hood could draw flames into the filter. Fat deposits could ignite, presenting a fire hazard.
- ▶ The cooker hood can become damaged when exposed to excessive heat.
 - When using the cooker hood over a gas hob, ensure that any burners in use are always covered by a pan. Switch the cooking zone off when a pan is removed, even for a short time.
 - Select a pan which is suitable for the size of the burner.
 - Regulate the flame so that it does not burn up the sides of the pan.
 - Avoid overheating the pan (e.g. when cooking with a wok).
- ▶ Always switch the cooker hood on when a cooking zone is in use, otherwise condensation may collect in the hood, which could cause corrosion.
- ▶ When cooking with oil or fat, chip pans and deep fat fryers etc, do not leave the pans unattended. Never leave an open grill unattended when grilling. Overheated oil and fat can ignite and could set the cooker hood on fire.
- ▶ Do not use the cooker hood without the filters in place. This way you will avoid the risk of grease and dirt getting into the appliance and hindering its smooth operation.
- ▶ The filters should be regularly cleaned or changed as appropriate. Saturated filters are a fire hazard.
- ▶ The cooker hood can get very hot during cooking due to heat rising from the hob. Do not touch the housing or the grease filters until the cooker hood has cooled down.

Correct installation

- ▶ Refer to the cooker or hob manufacturer's instructions as to whether a cooker hood may be operated above the cooker/hob.
- ▶ Safety regulations prohibit the fitting of a cooker hood over solid fuel stoves.
- ▶ Insufficient distance between the cooker or hob and the cooker hood can result in damage to the hood.
The minimum safety distances between the top of the cooker or hob and the bottom of the cooker hood given in the "Installation" section must be maintained, unless the hob manufacturer states that a greater distance is required.
If more than one cooking appliance is fitted beneath the cooker hood, and they have different minimum safety distances to the cooker hood, select the greater distance.
- ▶ The distances given in "Installation" must be observed when fitting the cooker hood.
- ▶ Exhaust ducting must be of non-inflammable material. Suitable material is available from Miele specialist dealers or the Miele Spares Dept.
- ▶ The appliance must not be connected to a chimney or vent flue which is in use. Neither should it be connected to ducting which ventilates rooms with fireplaces.
- ▶ If exhaust air is to be extracted into a chimney or ventilation duct no longer used for other purposes, seek professional advice.

Cleaning and care

- ▶ Do not use a steam cleaning appliance to clean this appliance. The steam could reach electrical components and cause a short circuit.

Warning and Safety instructions

Accessories

▶ Only use genuine original Miele accessories with this appliance. Using accessories from other manufacturers will invalidate the guarantee, and Miele cannot accept liability.

Disposal of the packing material

The packaging is designed to protect the appliance from damage during transportation. The packaging materials used are selected from materials which are environmentally friendly for disposal and should be recycled.

Recycling the packaging reduces the use of raw materials in the manufacturing process and also reduces the amount of waste in landfill sites.

Disposal of your old appliance

Electrical and electronic appliances often contain valuable materials. They also contain materials which, if handled or disposed of incorrectly, could be potentially hazardous to human health and to the environment. They are, however, essential for the correct functioning of your appliance. Please do not therefore dispose of it with your household waste.



Please dispose of it at your local community waste collection / recycling centre or contact your Dealer for advice.

Ensure that it presents no danger to children while being stored for disposal.

Modes of operation

Depending on the model of the cooker hood, the following options are available:

Air extraction

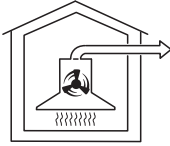

The air is drawn in and cleaned by the grease filters and directed outside.

Non-return flap

The non-return flap is designed to prevent the exchange of room and outside air taking place.

The flap is closed when the cooker hood is switched off.

When the cooker hood is switched on, the non-return flap opens for the cooking vapours to be blown directly outside.

If the on-site ventilation system does not have a non-return flap, the non-return flap supplied must be fitted in the exhaust socket in the motor unit.

Operation with an external motor

(...EXT model cooker hoods)

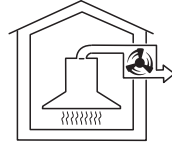

A Miele extraction fan is installed in a location of your choice outside the room for cooker hoods which are designed to be connected to an external motor. The external motor is connected to the cooker hood by means of a control cable and is operated by Con@ctivity 2.0 or by the controls on the cooker hood.

Con@ctivity 2.0 function

Automatic control

The cooker hood has a communication facility which enables the automatic operation of the cooker hood depending on the operational state of the hob.

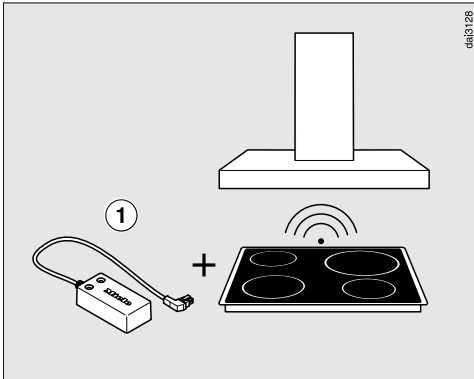

To make use of the communication facility the hob must be fitted with a Con@ctivity 2.0 Stick ①.

Refer to the installation instructions for the Con@ctivity 2.0 Stick to check whether it is compatible with your hob.

To use the Con@ctivity 2.0 function, a wireless connection must be established between the hob and the cooker hood (see "Activating Con@ctivity 2.0").

The hob transmits information about its operational status via a radio signal to the cooker hood.

- When the hob is switched on, the hob lighting comes on independently and then after a short time the fan also comes on.
- During cooking the cooker hood automatically sets the power level according to the number of cooking zones in operation and their power levels.
- After switching the hob off the fan and the hob lighting will switch off automatically after a specified period of time.

See "Operation" for detailed information about this function.

Guide to the appliance

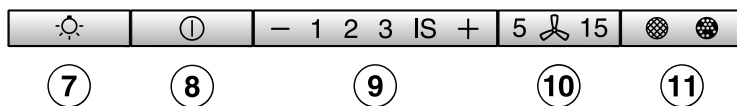
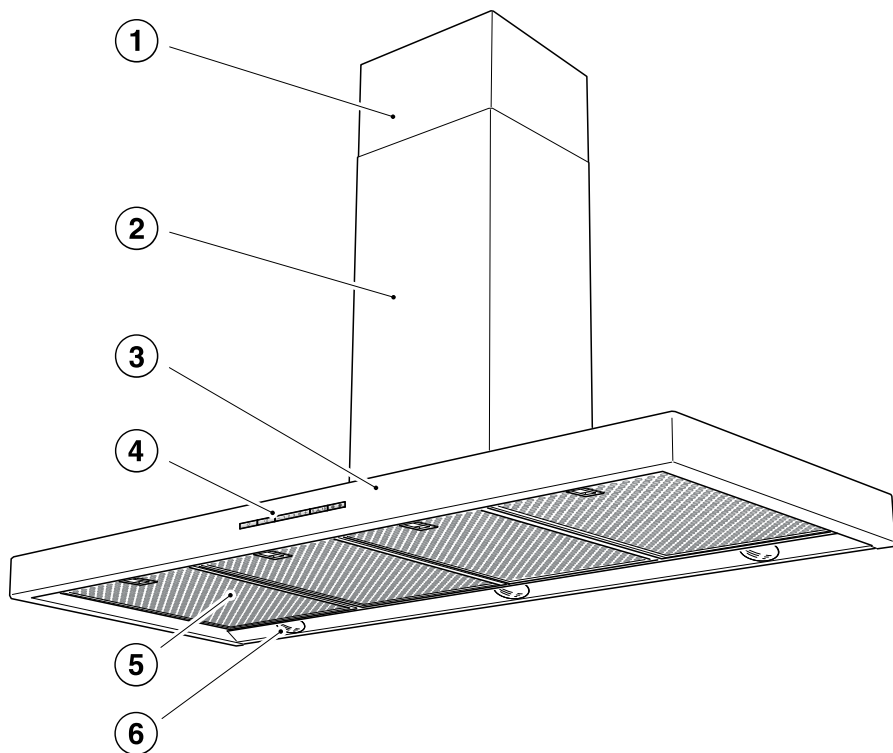

- ① Telescopic extension piece
- ② Tower
- ③ Canopy
- ④ Controls
- ⑤ Grease filters
- ⑥ Hob lighting
- ⑦ Control for the hob lighting
- ⑧ On/Off control for the fan
- ⑨ Controls to select the fan power level
- ⑩ Control for the run-on option
- ⑪ Operating hours control

Operation (Automatic mode)

When Con@ctivity 2.0 is activated, the cooker hood always works in automatic mode (see "Activating Con@ctivity 2.0").

To operate the cooker hood manually, see "Cooking without Con@ctivity 2.0".

Cooking with Con@ctivity 2.0 (Automatic mode)

- Switch a cooking zone on at the power level you want.

The cooker hood lighting will come on.

After a few seconds the fan will come on, first at power level **2**, then it will switch immediately to power level **1**.

The cooker hood selects the power level automatically during cooking.

This is determined by the total output of the hob, i.e, the number of cooking zones in operation and the power levels selected.

- If you select a higher power level or are using several cooking zones, the cooker hood will switch to a higher power level.
- When you reduce the power level or the number of cooking zones on the hob, the cooker hood power level is also reduced.

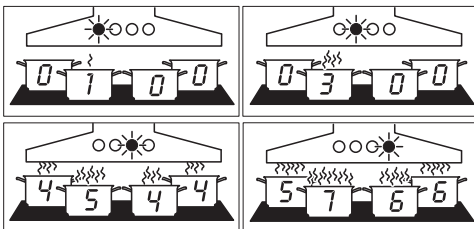

Examples for power levels **1** to **4**

Reaction time

The cooker hood reacts with a slight delay because altering the power level on the hob does not immediately result in a reduction or increase in cooking vapours.

Because the hob transmits the information to the cooker hood at intervals, this can also cause delays.

The reaction can vary from a few seconds to a couple of minutes.

Cooking process

- If for example you switch on a cooking zone at the highest power level to heat a pan for frying and reduce the power level after approx. 60 to 90 seconds*, a cooking process is recognised (*60 seconds to 5 minutes for a HiLight hob).

The cooker hood switches itself on and when the hob power level has been reduced, the hood switches to power level 3 and remains at that level for approx. 5 minutes.

After that the cooker hood power level is determined automatically by the Con@ctivity function.

- You can select another power level manually before then.

Switching off

- Switch off all cooking zones.

The cooker hood fan will reduce its power level over the next few minutes and will eventually switch itself off.

This helps to neutralise any lingering vapours and odours in the air.

- From the intensive setting IS the fan switches immediately to level 3.
- From level 3, it switches to level 2 after approx. 1 minute.
- From level 2 it switches to level 1 after approx. 2 minutes.
- After 2 minutes at level 1 the fan switches itself off.
- After another 30 seconds the lighting switches off.

The cooking process is then finished.

Operation (Automatic mode)

Leaving automatic mode temporarily

To leave automatic mode temporarily during cooking:

- Manually select a different power level, or
- Manually switch the cooker hood off, or
- Activate the run-on option  on the cooker hood. The fan will switch off after the selected time and the lighting remains switched on.

The cooker hood can now be operated manually (see "Cooking without Con@ctivity 2.0").

Returning to automatic mode

The cooker hood returns to automatic mode:

- if the cooker hood has not been used for approx. 5 minutes after selecting a power level manually, or
- if the manually selected fan power level corresponds to the automatic one again, or
- if the cooker hood fan and the hob have been switched off for at least 30 seconds.
Automatic mode will resume next time the hob is switched on.
- If you wish to operate the cooker hood manually for a complete cooking process, switch on the cooker hood fan **before** switching on the hob.
If the cooker hood and the hob have been switched off for at least 30 seconds after cooking, automatic mode will resume the next time the hob is switched on.

Cooking without Con@ctivity 2.0 (Manual mode)

The cooker hood can be operated manually if:

- Con@ctivity 2.0 is not activated.
- You have temporarily deactivated Con@ctivity 2.0 (see "Leaving automatic mode temporarily").

Switching the fan on

- Press the On/Off control .

The fan will switch on at level **2**. The  symbol and **2** will light up in the power level display.

Selecting the power level

For light to heavy cooking vapours and odours, select from power levels **1** to **3**.

When frying or cooking food with a very strong aroma, select the Intensive setting **IS**.

- For a lower power level, press the "-" control, or "+" for a higher level.



Reducing power on the intensive setting

If Power management is activated (default), the fan automatically switches to level **3** after 5 minutes.

Selecting run-on time

It is advisable to run the fan for a few minutes after cooking has finished to neutralise any lingering vapours and odours in the air.

With the run-on option the fan switches itself off automatically after a pre-selected time.

- After you have finished cooking, press the run-on option control **5**  **15**
 - Once: the fan will switch off after 5 minutes (**5** will light up).
 - Twice: the fan will switch off after 15 minutes (**15** will light up).
 - If you press the run-on option control **5**  **15** again, the fan will remain on (**5**  **15** will go out).

Switching the fan off

- Use the On/Off control  to switch the fan off.

The  symbol will go out.

Switching the hob lighting on / off

The hob lighting can be switched on and off independently of the fan.

- To do this, press .

The  symbol will light up when the hob lighting is switched on.



Operation (Manual mode)

Power management

The cooker hood features a power management system for switching off the lighting and reducing the fan power level automatically.

- If the Intensive setting has been selected the cooker hood will automatically switch down to power level 3 after 5 minutes.
- From levels 3, 2 or 1 the power will be reduced by one level after 2 hours and then in 30 minutes stages until the fan finally switches off.
- The hob lighting will switch off automatically after 12 hours.

Switching Power management on /off

- Switch off the fan and the lighting.
- Press the run-on option control **5**  **15** for approx. 10 seconds, until **1** lights up in the power level display.
- Then press in turn,
 - the lighting control ,
 - the "-" control and then
 - the lighting control  again.

If Power management is switched on, the **1** and **IS** indicators will light up constantly.

If it is switched off, **1** and **IS** will flash.

- Press "-" to switch Power management off.

The **1** and **IS** indicators will flash.

- To switch it on, press "+".

The **1** and **IS** indicators will light up constantly.

- Confirm the setting with the run-on option control **5**  **15**.

All the indicators will go out

If you do not confirm within 4 minutes, the cooker hood will revert to the old setting.

Operation (Automatic and Manual modes)

Operating hours counter





The number of hours the appliance has been in operation is stored in memory.

When the Grease filter symbol , lights up, the operating hours counter is signalling that the filters need to be cleaned or changed. Further information about cleaning and changing the filters and resetting the operating hours counter can be found under "Cleaning and care".

Altering the operating hours counter for the grease filters

You can set the operating hours counter for the grease filters to suit the type of cooking you do.



The grease filter operating hours counter is set at the factory for 30 hours.

- Select a shorter time of 20 hours if you roast or fry a lot.
- If you only cook occasionally we recommend that you still select a short time because grease which has built up gradually over a long period of time will harden on the filters and make cleaning more difficult.
- Select a longer time of 40 or 50 hours if you use very little fat for cooking.
- Use the On/Off control  to switch the fan off.
- Press the run-on control  **15** and the operating hours control   at the same time.

The grease filter symbol  and one of the fan power level indicators flash.

Fan power level indicators **1** to **IS** show the time set:

1	20 hours
2	30 hours
3	40 hours
IS	50 hours

- Press the "-" symbol for a shorter operating time, or the "+" symbol to select a longer operating time.
- Confirm the selection by pressing the operating hours control  .



All the indicators will go out

If you do not confirm within 4 minutes, the cooker hood will revert to the old setting.

Operation (Automatic and Manual modes)

Reading the filter operating hours counter

To check the percentage of time set already used

- Press the On/Off control  to switch the fan on.
- Press and hold the operating hours control .

The grease filter symbol  lights up.

One or more of the power level indicators will flash.

The number of fan power level indicators flashing shows the percentage of the operating time which has already been used up.

- 1** 25 %
- 1 and 2** 50 %
- 1 to 3** 75 %
- 1 to IS** 100 %

The number of operating hours used remains in the memory, even when the appliance is switched off or there is a power cut.

Housing

General information

The surfaces and controls are susceptible to scratches and abrasion.

Please observe the following cleaning instructions.

- All external surfaces and controls can be cleaned using hot water with a small amount of washing-up liquid applied with a well wrung-out soft sponge or cloth.

Do not use too much water when cleaning the controls.

Water could penetrate into the electronics and cause damage.

- After cleaning, wipe the surfaces dry using a soft cloth.

Do not use:

- cleaning agents containing soda, acids, chlorides or solvents,
- abrasive cleaning agents, e.g. powder cleaners or cream cleaners and abrasive sponges, as well as pot scourers or sponges which have been used previously with abrasive cleaning agents. These will damage the surface material.

Important for appliances with stainless steel surfaces

(This information does not apply to the controls).

- Stainless steel surfaces can be cleaned with a proprietary non-abrasive cleaning agent designed specifically for use on stainless steel.

- To help prevent re-soiling, a proprietary conditioning agent for stainless steel (available from Miele) can also be used. Follow the manufacturer's instructions on the packaging.

Special instructions for appliances with lacquered housing

(Special order finish)

- Please observe the general notes on cleaning earlier in this section.

It is very difficult to clean this type of surface without causing minor marks to the surface material. This can become particularly noticeable if there is halogen lighting in the kitchen.

Important for the controls

Do not leave soiling on the controls for any length of time.

Otherwise they may suffer discolouration or damage.

Remove soiling straight away.

- Please observe the general notes on cleaning earlier in this section.

Do not use stainless steel cleaning agents on the controls.

Grease filters

The re-usable metal grease filters in the appliance remove solid particles (grease, dust, etc.) from the kitchen vapours, preventing soiling of the cooker hood.

 An oversaturated filter is a fire hazard.

Cleaning and care

Cleaning interval

The grease filters should be cleaned regularly (at least every 3 - 4 weeks) to avoid a build-up of grease.

Clean them immediately if the Grease filter operating hours symbol  lights up.

- You can set the operating hours counter for the grease filters to suit the type of cooking you do (see "Operation").

Removing a grease filter

The grease filter can fall out when you are handling it.

This can result in damage to the filter and the hob below.

Make sure you hold the filter securely at all times when handling it.

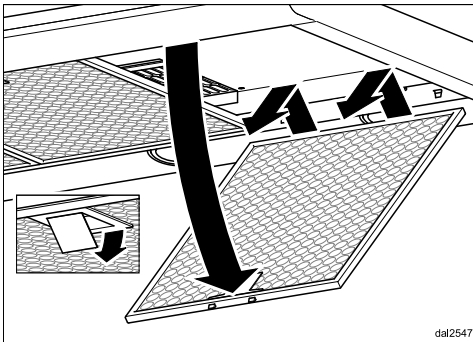

- To take out a grease filter, release the locking clip on the filter, lower the filter approx. 45°, unhook it at the back and remove it.

Cleaning the grease filters by hand

- Clean the filters with a soft nylon brush in a mild solution of hot water and a small amount of washing-up liquid. Do not use "neat" washing up liquid.

Unsuitable cleaning agents

Unsuitable cleaning agents can cause damage to the surface of the filter if used regularly.

Do not use:

- cleaning agents containing descaling agents
- powder cleaners, cream cleaners
- aggressive all-purpose cleaning agents or spray cleaners for grease
- oven sprays

Cleaning the grease filters in the dishwasher

- Place the filters as upright as possible in the lower basket, with the short sides upright, ensuring the spray arm is not obstructed.
- Use a proprietary household dishwasher detergent.
- Select a dishwasher programme with a wash temperature between 50°C and 65°C.

Depending on the cleaning agent used, cleaning the filters in a dishwasher can cause permanent discolouration to the surface. However, this will not affect the functioning of the filters in any way.

After cleaning

- After cleaning, leave the filters to dry on an absorbent surface before replacing them.
- When removing the filters for cleaning, also clean off any residues of oil or fat from the now accessible housing to prevent the risk of these catching fire.
- Replace the grease filters, making sure that the locking clips are facing down towards the hob.

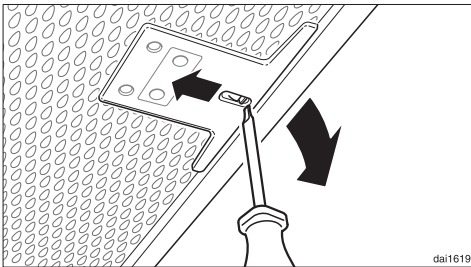

- If a grease filter is inadvertently replaced upside down, insert a small screwdriver blade into the slit to disengage the clip.

Resetting the grease filter operating hours counter

After cleaning, the operating hours counter needs to be re-set.

- Whilst the fan is switched on, press the operating hours control  for approx. 3 seconds, until only the **1** is flashing.

The grease filter symbol  goes out.

If you want to clean the grease filter before the operating hours counter has reached its maximum,

- Press the operating hours control  for approx. 6 seconds, until only the **1** is flashing.

After Sales / Guarantee

In the event of a fault which you cannot remedy yourself, please contact your Miele dealer or the Miele Service Department.

Contact details for Miele are given at the back of this manual. N.B. A call-out charge will be applied to service visits where the problem could have been resolved as described in these instructions.

When contacting your dealer or Miele, please quote the model and serial number of your appliance. These are shown on the data plate.

Position of the data plate

The data plate is visible after removing the grease filters.

Guarantee

The appliance is guaranteed for 2 years from the date of purchase. For further information on the appliance guarantee specific to your country please contact Miele.

In the UK, you must activate your cover by calling 0845 365 6640 or registering online at www.miele.co.uk.

Before installation

 Before installation, it is important to read the information given on the following pages as well as the "Warning and Safety instructions" at the beginning of this booklet.

Protective foil

The housing components have protective foil around them to protect them from transport damage.

- Please remove this foil before fitting the housing components. It can be peeled off easily.

Installation instructions

See enclosed Installation sheet for instructions on how to install this appliance.

Dismantling

Should the appliance ever need to be dismantled, follow the installation instructions in reverse order as described on the installation sheet. A lever is supplied to assist with the removal of the tower.

- After unscrewing the two fixing screws on the tower,

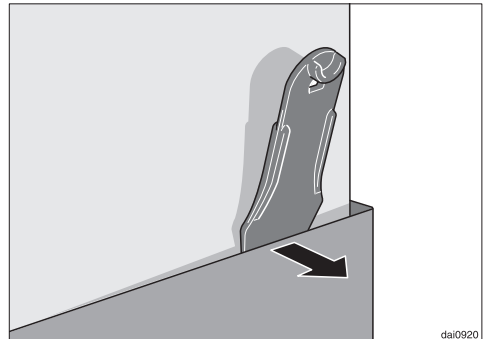

- push the lever between the tower and the extension piece
- then lever the tower out of its fixings.

Installation

Assembly parts

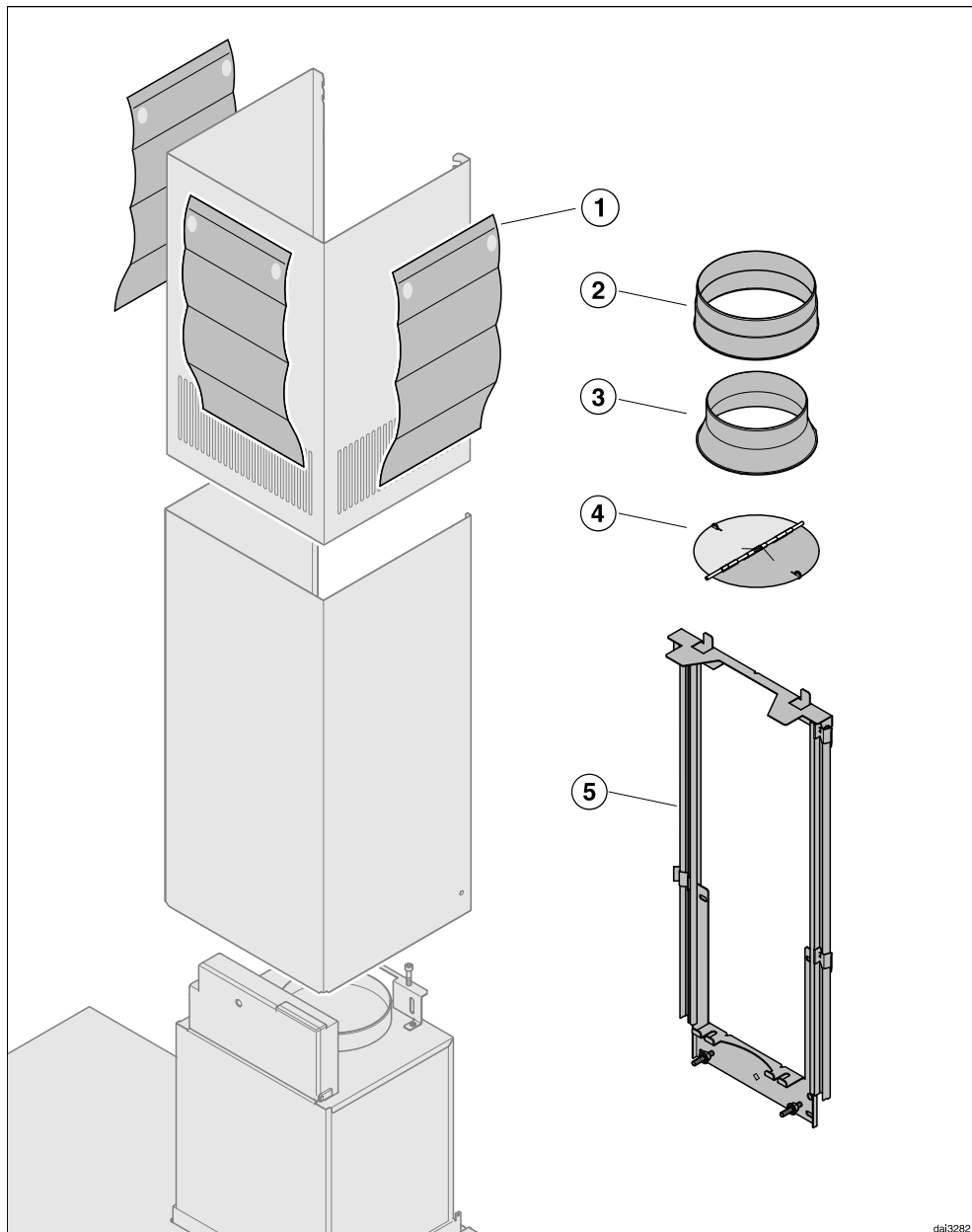

dai3282

- ① **3 protective sheets**
for use when fitting the tower
- ② **1 exhaust connection**
for exhaust ducting \varnothing 150 mm
- ③ **1 reducing collar**
for exhaust ducting \varnothing 125 mm
- ④ **1 non-return flap**
for fitting into the exhaust connection on the motor unit
- ⑤ **Telescopic wall bracket**
for securing the cooker hood to the wall



6 screws 5 x 60 mm and
6 plugs 8 x 50 mm
for securing the wall bracket

The screws and plugs are designed for use in solid walls only. For other types of wall construction, alternative fixings will be required. Make sure the wall is able to take the weight of the cooker hood.



2 x M 6 self-tapping nuts
for securing the appliance



2 screws 3.9 x 7.5 mm
for securing the tower

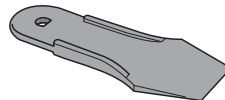

1 lever
for dismantling the tower

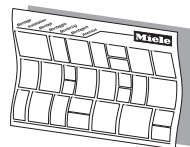

Installation instructions

Installation

Appliance dimensions

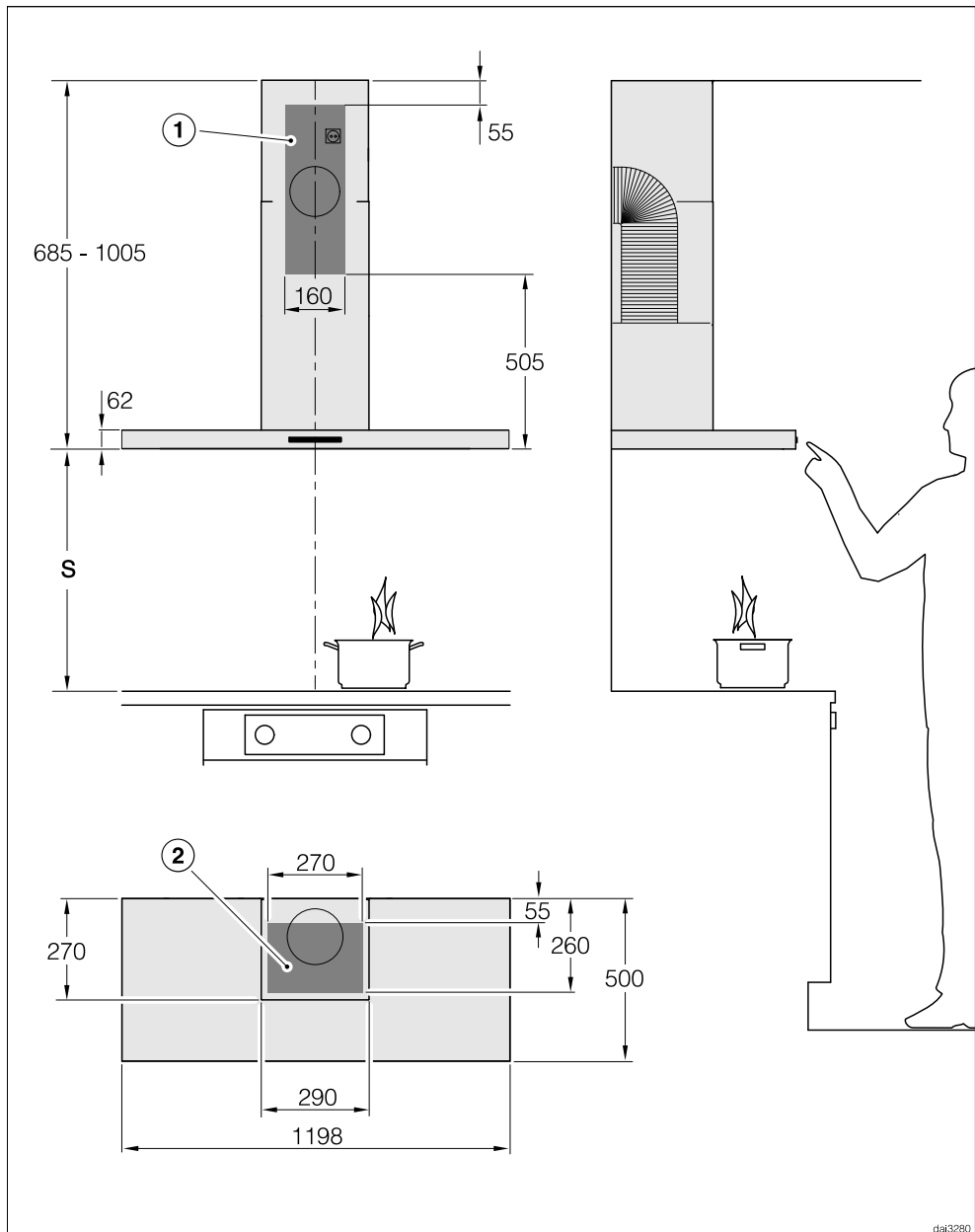

The diagram is not drawn to scale.

- ①② The shaded area represents the wall or ceiling area for the vent cut-out, for fitting the connection socket and on EXT models for feeding the connection cable through to the external motor.

Connection for air extraction \varnothing 150 mm, or \varnothing 125 mm with reducing collar.

Safety distance between hob and cooker hood

When planning the installation height of your cooker hood, the minimum safety distance between the top of a cooker or hob and the bottom of the cooker hood is as follows, unless a greater distance is specified by the manufacturer of your cooking appliance.

See "Warning and Safety" instructions for further information.

Cooking appliance	Minimum distance S
Electric hob	450 mm
Electric grill	650 mm
Deep fat fryer (electric)	650 mm
Multi-burner gas hob with a maximum total output of 12.6 kW, no burner exceeding 4.5 kW.	650 mm
Multi-burner gas hob with a total output of more than 12.6 kW, or a multi-burner gas hob where one burner exceeds 4.5 kW.	760 mm
Single gas burner with a maximum output of 6 kW.	650 mm
Single gas burner with output exceeding 6 kW.	760 mm

Installation

Installation recommendations

- When deciding on the safety distance between the hob and cooker hood, please note that a distance of 650 mm above electric cookers/hobs may be preferable to give more working space under the hood.
- Account should also be taken of the height of the person who will be using the hood most often. They should have sufficient space to work comfortably at the hob, and be able to reach the hood controls with ease.
- Please be aware that if positioned too high, extraction will be inefficient.
- To achieve optimum vapour extraction, the cooker hood must cover the hob. It should be positioned centrally over the hob, not to the side.
- The hob should be no wider than the cooker hood, and if possible, it should be narrower.
- The installation area must be easily accessible. The cooker hood should be easily accessible and easy to dismantle in the event that service is required. This should be taken into consideration when planning the position of cupboards, shelves, ceilings or features in the vicinity of the cooker hood.

Drilling diagram for wall mounting

- Please follow the directions given in the installation instructions supplied for drilling.

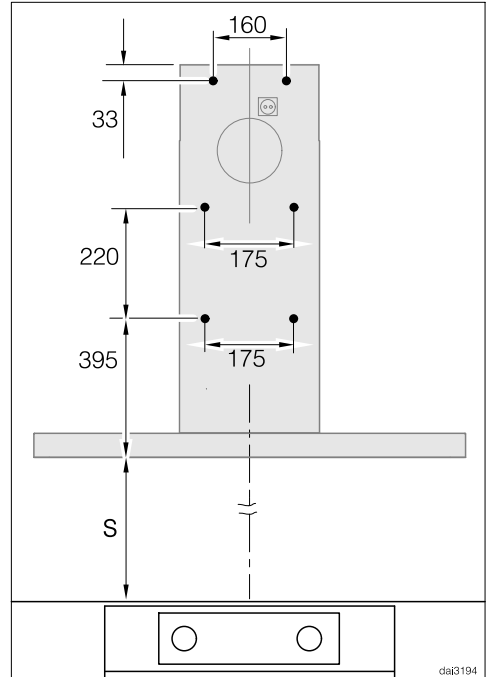

- For pre-installation of a back wall where the holes have to be pre-drilled, please refer to the drilling distances in the drawing above (screws \varnothing 5 mm).

Connection for air extraction

⚠ Before installation, it is important to read the information given on the following pages as well as the "Appliance dimensions" and the "Warning and Safety instructions" at the beginning of this booklet. This is particularly crucial when using the cooker hood at the same time as a heating appliance that relies on oxygen from the same room, which could result in the build-up of toxic fumes.

It is essential that the "Warning and Safety" instructions are observed. The cooker hood should be installed according to local and national building regulations. Seek approval from the building inspector where necessary.

- The exhaust ducting should be as short and straight as possible.
- Only use wide radius bends.
- The exhaust duct must not be kinked or compressed.
- Ensure that all connections are strong and airtight.

Remember that any constriction of the air flow will reduce extraction performance and increase operating noise.

- If the exhaust is ducted through an outside wall, a telescopic wall vent or a roof vent (available as an optional accessory) is recommended.

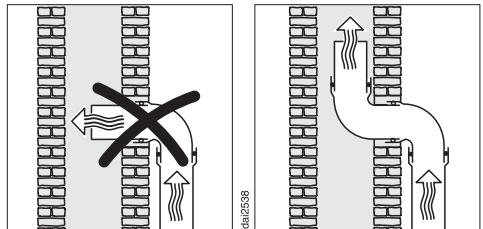

- If the exhaust air is to be ducted into a vent flue, the ducting must be directed in the flow direction of the flue.
- When ducting is horizontal it must be laid to slope away at at least 1 cm per metre. This is to ensure that condensate cannot drain back into the appliance.
- If the exhaust ducting is to run through rooms, ceiling space etc. where there may be great variations in temperature between the different areas, the problem of condensation

- Use smooth or flexible ducting made from approved non-flammable materials for exhaust ducting.
- When using an external motor, make sure that the exhaust ducting is sufficiently rigid. The external motor can cause an underpressure which can result in the exhaust ducting distorting.
- To achieve the most efficient air extraction with the lowest noise levels, please note the following:
 - To ensure efficient air extraction, the diameter of the exhaust ducting should not be less than 150 mm.
 - If flat ducting is being used, the cross section must not be smaller than the cross sectional area of the exhaust connection.

Connection for air extraction

will need to be addressed. The exhaust ducting will need to be suitably insulated.

Condensate trap

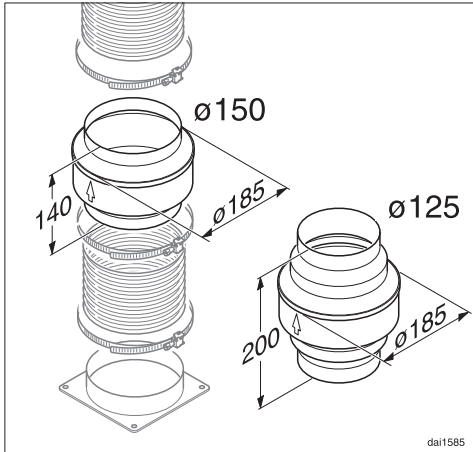

In addition to insulating the exhaust ducting, we recommend that a suitable condensate trap is also installed to collect and evaporate any condensate which may occur.

Condensate traps are available for 125 mm or 150 mm ducting.

- When installing a condensate trap, ensure that it is positioned vertically and if possible directly above the exhaust connection. The arrow on the housing indicates the direction of air-flow.

The condensate trap is integrated in cooker hoods which are designed for connection to an external motor (model.....EXT).

Silencer

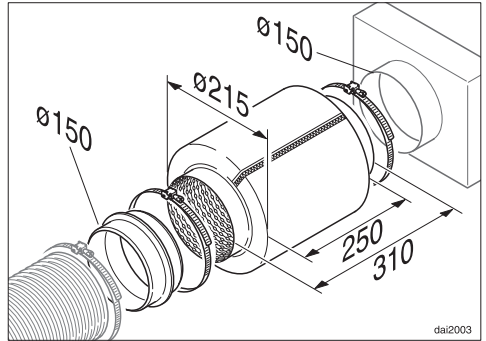

To achieve even further reductions in noise levels, a special silencer (optional accessory) can be fitted in the ducting system.

Air extraction

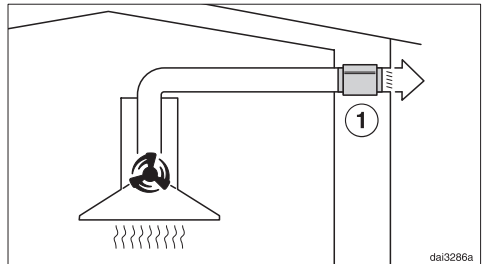

The silencer not only reduces noise from the motor outside the house, but also sounds from outside (e.g. traffic noise). For this reason the silencer must be positioned as close as possible to the ducting exit ①.

Air extraction with external motor

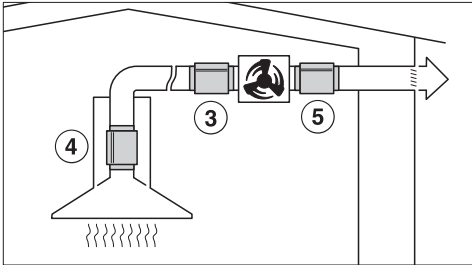

To minimise noise from the motor in the kitchen, the silencer should be positioned in front of the external motor ③ if possible, or, if the ducting is long, above the exhaust connection inside the hood ④. In the case of an external motor located inside the house, fitting a silencer behind the external motor ⑤ reduces the noise of the motor outside the house.

Electrical connection

All electrical work should be undertaken by a suitably qualified and competent person in strict accordance with current national and local safety regulations (BS 7671 in the UK).

Installation, repairs and other work by unqualified persons could be dangerous, for which the manufacturer cannot be held liable. Ensure power is not supplied to the appliance until after installation or repair work has been carried out. Do not connect the appliance to the mains electricity supply by an extension lead. These do not guarantee the required safety of the appliance.

The connection data is given on the data plate. This is visible when the grease filters have been removed. Ensure that this data matches the household mains supply.

Connection of this appliance should be made via a suitable isolator or a double pole fused spur connection unit which complies with national and local safety regulations and the On-Off switch should be easily accessible after the appliance has been built in. When switched off there must be an all-pole contact gap of 3 mm in the switch (including switch, fuses and relays according to EN 60335).

If the switch is not accessible after installation (depending on country), an additional means of disconnection must be provided for all poles. For extra safety it is advisable to protect the appliance with a suitable residual current device (RCD). Contact a qualified electrician for advice.

Important

This appliance is supplied for connection to an a.c. 230 V single phase 50 Hz supply. The wires in the mains lead are coloured in accordance with the following code:

Green/yellowearth
Blue.....neutral
Brown..... live

**WARNING:
THIS APPLIANCE MUST BE
EARTHED**

Installing the Con@ctivity 2.0 Stick

In order to use the Con@ctivity 2.0 function, the hob must first be fitted with the Con@ctivity 2.0 Stick.

- Please read the separate installation instructions supplied with the Con@ctivity 2.0 Stick.

Activating Con@ctivity 2.0

Wireless connection must be activated between the cooker hood and the hob before Con@ctivity 2.0 can be used.

Both appliances must be installed and operational.

You only need to carry out the activation procedure once. If the appliances are disconnected from the electricity supply, during a power cut for example, they will still remain activated.

To establish the wireless connection, the cooker hood and hob must be activated at the same time. First activate the cooker hood, then the hob.

Activating the cooker hood

- Switch off the fan, hob lighting and hob.
- Press the run-on option control **5**  **15** for approx. 10 seconds until the indicator for power level **1** lights up.
- Then press in turn,
 - the "-" control,
 - then the "+" control,

- then the lighting control .

If Con@ctivity 2.0 is not activated, **2** and **3** will flash at the same time.

- Press "+" to activate Con@ctivity 2.0.

2 will light up constantly and **3** will flash. The search for a wireless connection is started.

- Meanwhile, start activating the hob.

Activating the hob

- **While** the cooker hood is searching for wireless connection, start activating the hob. More information about this can be found in the operating instructions for the hob.

When connection has been established, **2** and **3** will light up constantly on the cooker hood.

- Confirm activation of the cooker hood with the run-on option control **5**  **15**. All indicators will go out.

- Confirm activation of the hob.

Con@ctivity 2.0 is now ready to use.

If you do not confirm your selection within 4 minutes, activation will not take place.

Activation check

To check whether Con@ctivity 2.0 is activated on the cooker hood:

- Switch off the fan and hob lighting.
- Press the run-on option control **5**  **15** for approx. 10 seconds until the indicator for power level **1** lights up.

Activating Con@ctivity 2.0

- Then press in turn,
 - the "-" control,
 - then the "+" control,
 - then the lighting control .

If Con@ctivity 2.0 is activated, **2** and **3** will light up constantly.

If Con@ctivity 2.0 is not activated, **2** and **3** will flash at the same time.

- To exit the check, press the run-on option control **5**  **15**. All indicators will go out.
- To check whether Con@ctivity is activated on the hob, see the operating instructions for the hob.
- If connection cannot be established despite activating the Con@ctivity function on the cooker hood and hob, the function must be deactivated on both appliances and then the procedure repeated.

Technical data

Fan motor*	200 W
Hob lighting	3 x 3 W
Total connected load*	209 W
Voltage	AC 230 V
Fuse rating	5 A
Mains connection cable length	1.5 m
Weight	
DA 422-6	27 kg
DA 422-6 EXT	24 kg
Extraction power* according to EN 61591, extraction ducting \varnothing 125/150 mm	
Level 1	180/200 m ³ /h
Level 2	280/300 m ³ /h
Level 3	380/400 m ³ /h
Intensive setting	580/640 m ³ /h

* For EXT models, the connected load and extraction power will depend on the type of external motor fitted.

Length of connection cable to external motor: 1.9 m

Conformity declaration

Miele hereby declares that the cooker hoods listed at the end of this booklet comply with the basic requirements and other relevant regulations of Guideline 1999/5/EC.

A copy of the full Declaration of Conformity can be obtained from the address at the end of this booklet.

United Kingdom

Miele Co. Ltd.

Fairacres, Marcham Road
Abingdon, Oxon, OX14 1TW

Tel: 0845 365 0555

Customer Contact Centre Tel: 0845 365 6600

E-mail: info@miele.co.uk

Internet: www.miele.co.uk

Australia

Miele Australia Pty. Ltd.

ABN 96 005 635 398

1 Gilbert Park Drive, Knoxfield, VIC 3180

Tel: 1300 464 353, Fax: (03) 9764 7149

Internet: www.miele.com.au

China

Miele (Shanghai) Trading Ltd.

1-3 Floor, No. 82 Shi Men Yi Road

Jing' an District

200040 Shanghai, PRC

Tel: +86 21 6157 3500, Fax: +86 21 6157 3511

E-mail: info@miele.cn

Internet: www.miele.cn

Miele (Hong Kong) Limited

41/F - 4101, Manhattan Place

23 Wang Tai Road

Kowloon Bay

Hong Kong

Tel: (852) 2610 1331, Fax: (852) 2610 1013

Email: mielehk@miele.com.hk

India

Miele India Pvt. Ltd.

Ground Floor, Copia Corporate Suites

Plot No. 9, Jasola

New Delhi – 110025

Tel: 011-46 900 000, Fax: 011-46 900 001

E-mail: customercare@miele.in, Internet: www.miele.in

Ireland

Miele Ireland Ltd.

2024 Bianconi Avenue

Citywest Business Campus, Dublin 24

Tel: (01) 461 07 10, Fax: (01) 461 07 97

E-Mail: info@miele.ie, Internet: www.miele.ie

Manufacturer: Miele & Cie. KG

Carl-Miele-Straße 29, 33332 Gütersloh, Germany

Miele

Malaysia

Miele Sdn Bhd

Suite 12-2, Level 12

Menara SapuraKencana Petroleum

Solaris Dutamas No. 1, Jalan Dutamas 1

50480 Kuala Lumpur, Malaysia

Phone: +603-6209-0288

Fax: +603-6205-3768

New Zealand

Miele New Zealand Limited

8 College Hill

Freemans Bay, Auckland 1011, NZ

Tel: 0800 264 353, Fax: 0800 463 453

Internet: www.miele.co.nz

Singapore

Miele Southeast Asia

Miele Pte. Ltd.

163 Penang Road

04 - 02/03 Winsland House II

Singapore 238463

Tel: +65 6735 1191, Fax: +65 6735 1161

E-Mail: infosea@miele.com.sg

Internet: www.miele.sg

South Africa

Miele (Pty) Ltd

63 Peter Place, Bryanston 2194

P.O. Box 69434, Bryanston 2021

Tel: (011) 875 9000, Fax: (011) 875 9035

E-mail: info@miele.co.za

Internet: www.miele.co.za

United Arab Emirates

Miele Appliances Ltd.

P.O. Box 11 47 82

Gold & Diamond Park

Sheikh Zayed Road

Building 6 / Offices Nos. 6-214 to 6-220

Dubai

Tel: +971-4-341 84 44

Fax: +971-4-341 88 52

E-Mail: info@miele.ae, Internet: www.miele.ae

DA 422-6
DA 422-6 EXT



en-GB

M.-Nr. 09 704 890 / 00

Free Manuals Download Website

<http://myh66.com>

<http://usermanuals.us>

<http://www.somanuals.com>

<http://www.4manuals.cc>

<http://www.manual-lib.com>

<http://www.404manual.com>

<http://www.luxmanual.com>

<http://aubethermostatmanual.com>

Golf course search by state

<http://golfingnear.com>

Email search by domain

<http://emailbydomain.com>

Auto manuals search

<http://auto.somanuals.com>

TV manuals search

<http://tv.somanuals.com>