

Miele

NOVOTRONIC

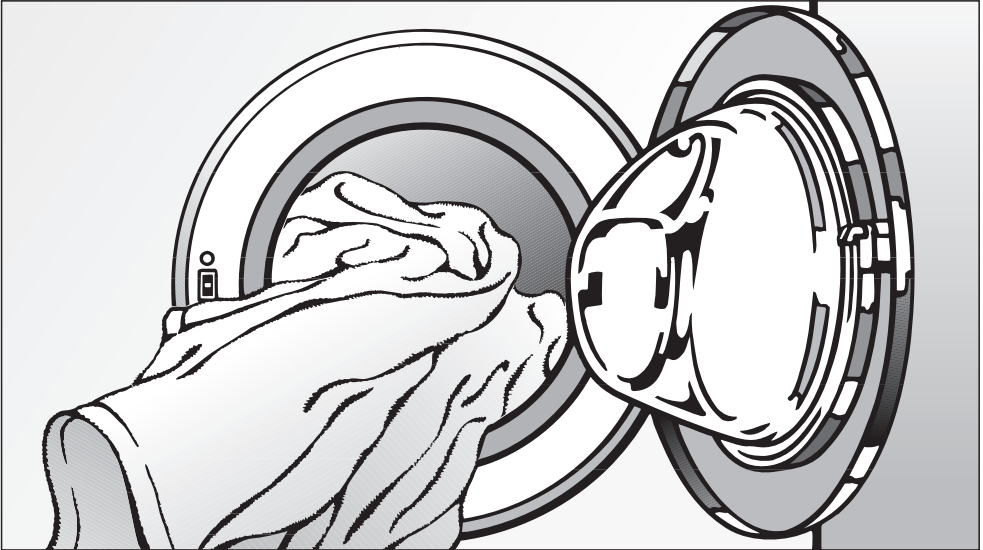

Operating Instructions for the W 1926 Washing Machine

To prevent accidents
and machine damage,
read these Operating Instructions
before installation or use.



M.-Nr. 04 955 390

Contents

Guide to the machine	3
Important safety instructions	5
Preparation for use	
Help protect our environment	6
Operating Instructions	
Optimal usage	7
Preparing the Laundry	8
End of Program	10
Changing the program sequence	11
Adding detergent.	12
Adding fabric softener or starch	13
Program selection	14
Program sequence	16
Textile care symbols.	18
Additional options	19
Delay start/Time remaining indicator	20
USER MAINTENANCE Instructions	
Cleaning and care	21
Problem solving guide	25
After sales service	30
INSTALLATION INSTRUCTIONS	
Installation	31
Plumbing Connections.	36
Electrical connection	37
Programmable functions	38
Technical data	43

Guide to the machine

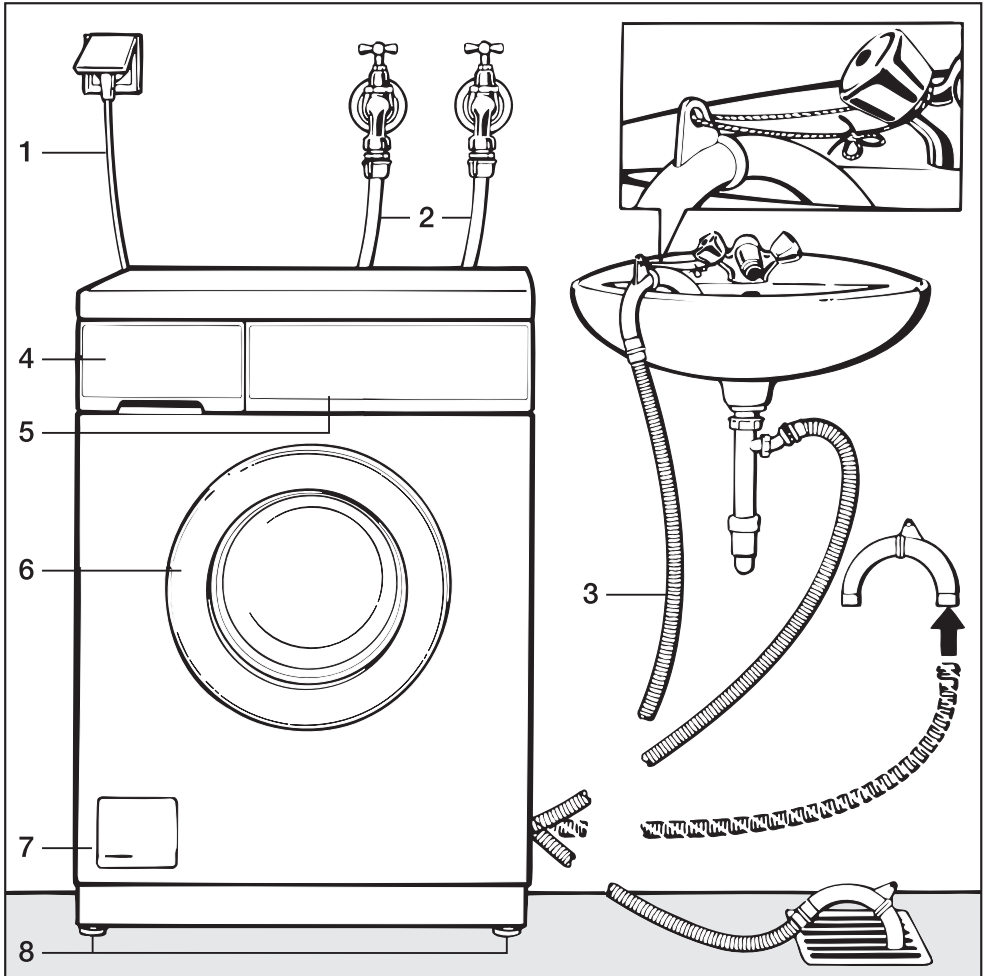

- | | |
|---|---|
| 1 Supply cable | 5 Control panel |
| 2 High pressure intake hoses | 6 Drum door |
| 3 Flexible drain hose, with detachable swivel elbow | 7 Access panel for lint filter and drain pump |
| 4 Detergent dispenser drawer | 8 Four height adjustable legs |

Guide to the machine

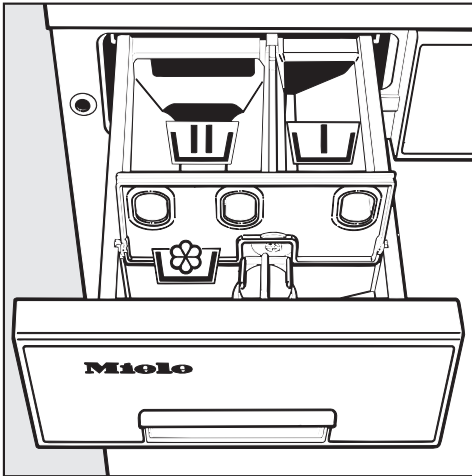

Detergent dispenser drawer

- Compartment - for the pre-wash.
- Compartment - for the main wash.
- Compartment (with lid) - for fabric softener or starch.

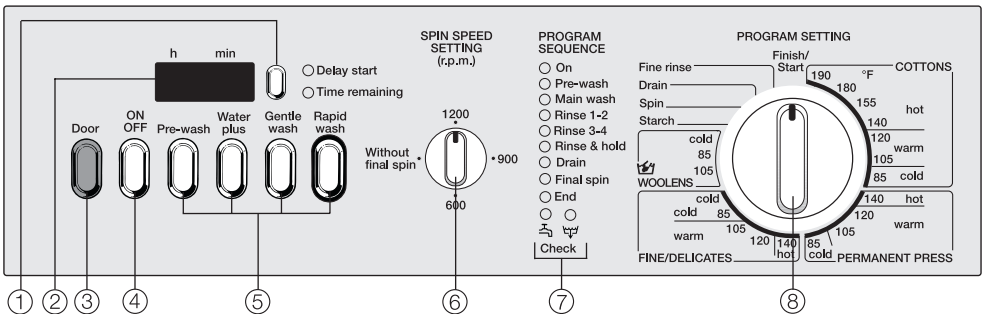

- ① "Delay start" button.
- ② Time display "hours, mins".
- ③ "Door" button; opens the drum door.
- ④ "ON/OFF" button; Turns the machine on and off or interrupts a program. The "On" lamp illuminates.
- ⑤ Pushbuttons for additional functions.
- ⑥ SPIN SPEED SELECTOR switch.
- ⑦ PROGRAM SEQUENCE indicators (LED indicator lamps).
- ⑧ PROGRAM SELECTOR switch.

Important safety instructions

WARNING - To reduce the risk of fire, electric shock, or injury to persons while using your appliance, follow basic safety precautions, including the following:

1. Read the instructions before using the appliance.
2. Do not wash materials that have been previously cleaned or soaked in gasoline, dry cleaning solvents, or other flammable or explosive substances. Do not add gasoline, dry cleaning solvents, or other flammable or explosive substances to the wash water. These substances give off vapors that could ignite or explode.
3. Do not allow children to play on or in the appliance. Close supervision is necessary when the appliance is used near children.
4. Before discarding an old appliance unplug the unit and remove the power cord. Also, remove the door to the wash compartment to prevent it from becoming a hazard.
5. Do not reach into the appliance if the drum is moving.
6. This appliance should never be installed or stored outdoors.
7. Do not tamper with the controls.
8. Do not repair or replace any part of the appliance, or attempt any servicing unless specifically recommended in these Operating instructions.
9. Do not add gasoline, dry-cleaning solvents, or other flammable or explosive substances to the wash water. These substances give off vapors that could ignite or explode.
10. Under certain conditions, hydrogen gas may be produced in a hot water system that has not been used for 2 weeks or more. **HYDROGEN GAS IS EXPLOSIVE.** If the hot water system has not been used for such a period, before using the washing machine, turn on all hot water faucets and let the water flow from each for several minutes. This will release any built up hydrogen gas. As the gas is flammable, do not smoke or use an open flame during this time.

SAVE THESE INSTRUCTIONS

For installation and grounding instructions, refer to the Electrical Connection Section of this manual.

Help protect our environment

Warning - To reduce the risk of fire, electric shock, or injury to persons, read the IMPORTANT SAFETY INSTRUCTIONS before operating this appliance.

Disposal of the packing material

The transport and protective packing is mostly manufactured from the following recycled or recyclable materials:

- corrugated paper/cardboard
- - CFC free polystyrene
- polystyrene foil (transparent)
- Untreated wood
- Polypropylene (PP) strapping

Rather than throwing these materials away, please take them to your community recycling center.

Disposal of your old appliance

Old appliances contain materials that can be recycled. Please contact your local recycling center about the possibility of recycling these materials.

Before discarding an old appliance, unplug it from the outlet and cut off its power cord and remove any doors to prevent it from becoming a hazard.

Before using the first time

Since all Miele washing machines are tested for proper operation before leaving the factory, some residual water may be left inside.

As this water is not visible, we recommend you perform the following steps before you use your new machine for the first time, or if it has been in storage for more than a few weeks between uses.

- Do not put any laundry in the machine.
- Add a small amount of detergent to compartment .
- Turn "On" the machine.
- Press the "Rapid wash" button.
- Turn the dial to "COTTONS 140°F".

The machine will start to run and will flush out any residual water that may be inside.

The key to good wash results is finding the correct combination of detergent and temperature, and then allowing the washing machine to optimize their usage through its programming. Program lengths can vary for this reason.

The fully electronic controls offer a combination of simple operation with many optional features. For instance, since a main wash generally gives good results for a normal load, the pre-wash cycle has been made a user selectable option, saving time, water and energy over older full cycle machines.

With the „Hydromatic“ system, the drum can revolve at various speeds. Faster and slower agitation speeds along with pauses for soaking, combine to ensure excellent wash results.

The automatic load control feature ensures the correct water level for the type of fabric and load being washed (even though it may appear as if there is too little water in the drum!).

Operational noise, no matter what program is selected, is minimized through the use of an accurately balanced drum and special sound insulation.

Economy

To conserve energy the following tips:

- The automatic load control feature will adjust the water level for loads up to 13 lbs (6kg). Washing with the maximum load specified for each program water and energy saves.
- Use the correct amount of detergent required for the water hardness in your area. Miele recommends the use of powder detergents, as their characteristics allow them to perform better in this machine than liquid detergents.

If the wash is not heavily stained, select a lower temperature than indicated on the wash care label.

Preparing the Laundry

The headings numbered (1, 2, 3, ...) show the operating sequence and can be used as a brief guide.

Before washing

1 Prepare the wash load

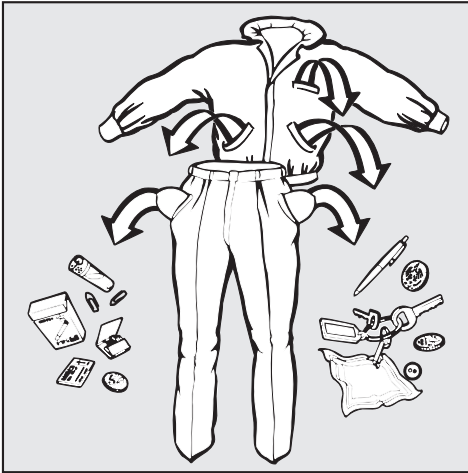

- Empty all pockets.

Foreign objects accidentally left in pockets (e.g. nails, coins, paper clips, etc.) can damage clothes and the machine.

- Sort the laundry

Only wash items that are labeled machine washable by the manufacturer. Some garments will have a Fabric care label in the collar or side seam. If so, sort the laundry by care label and color.

Dark fabrics often contain “excess dye” and should be washed separately several times before being included in a mixed load.

Delicate fabrics should be washed separately using the FINE/DELICATES program.

Only wash wool or wool mixtures if they are labeled machine washable on the textile care label.

- Pre-treat the laundry

Badly soiled areas (e.g. collars and cuffs) and water soluble stains can be pre-treated with bar soap, stain remover, or detergent mixed into a solution or paste.

Do not use detergents containing solvents in the machine.

- For curtains: Remove any lead weights or strips.

Woolens and knitted garments should be turned inside out if recommended by the manufacturer.

2 Press the “Door” button to open the door

3 Load the machine

Unfold the laundry and place it in the drum. For best results we recommend washing mixed loads consisting of both large and small items. This improves washing effectiveness and helps distribute the load evenly to keep the machine stable and reduce noise during spinning.

Recommended load sizes are noted below:

COTTONS 13 lbs (6.0 kg)

PERMANENT PRESS . . . 6.5 lbs (3.0 kg)

FINE/DELICATES 3.5 lbs (1.5 kg)

WOOLENS 4.5 lbs (2.0 kg)

FINE RINSE 6.5 lbs (3.0 kg)

4 Close the machine door

Make sure there are no clothes caught between the drum door and seal.

5 Add detergent

See the “Adding detergent” section for details.

To start a program

1 Turn the program selector to Finish / Start

2 Press the “ON/OFF” button

3 Press any desired “Additional function” pushbuttons

(See the “Delay start” section if this feature is desired.)

4 Select the final spin speed

5 Turn the program selector to the desired program

The program selector can be turned to the left or the right.

End of Program

After washing

- 1 Turn the program selector switch to “Finish/Start”
- 2 Press the “ON/OFF” button.
- 3 Press the “Door” button.

Do not attempt to remove laundry from the machine if the drum is turning. You may seriously injure yourself. If the drum turns with the door open, contact the Miele Service Department.

- 4 Remove the wash.

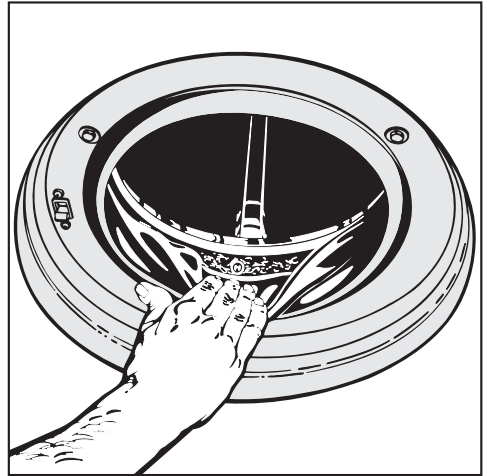

- 5 Check the folds in the door seal for any small articles such as buttons or nails which may be lodged there.

Make sure the drum is empty by manually turning it completely around. Items inadvertently left in the machine may be damaged (e.g. shrink) or cause discoloration of other laundry during the next wash cycle.

- 6 Close the drum door.

Changing the program sequence

To cancel a program:

- Turn the program selector to “Finish/Start”.

To interrupt a program:

- Press the “ON/OFF” button.

To continue the program, turn the machine back on.

To change an incorrectly selected program:

- Turn the program selector switch to “Finish/Start”.

When only the “On” lamp is lit, a new program can be selected.

To change a program which has been “locked” using the Child Safety feature, see the “Programmable functions” section.

To omit a program stage:



A program stage must first be reached to be omitted. When the sequence indicator lamp of the program stage you would like to omit illuminates:

- Turn the program selector to “Finish/Start”



As soon as the program sequence indicator lamp for the stage you wish to enter starts flashing:

- Turn the program selector switch to the desired program.

Adding detergent

Powder detergent should be added to compartment  (main wash) and compartment  (pre wash, if selected) at the beginning of each wash cycle. Due to the design of the Miele 1/3 to 1/2 the manufacturer's recommended amount of detergent is plenty for excellent wash results.

Do not use chlorine bleach!

Water is taken in through compartment  during the main wash. If your water is extremely hard (above 400 ppm calcium carbonate) and compartment  is too small for the amount of detergent needed, a service technician can re-program the machine so that water and detergent can also enter through compartment .

For small loads:

- Proportionately reduce the amount of detergent used for each small load.
- Check the wash results and the condition of the laundry.
- If the laundry is not clean or if it is gray or hard to the touch, add slightly more detergent the next time you use the machine.

It is important to use the correct amount of detergent, because...

...too little detergent can result in:

- gray laundry
- grease/stains not being removed
- lime deposits on the heating elements and drum (in hard water areas).



...too much detergent can result in:

- excessive foam
- insufficient agitation
- poor cleaning and rinsing results.

Water Softeners

If you wish to use a water softener to cut down on detergent usage in hard water areas:

- add the amount of detergent necessary for a soft water area.
- Add the specified amount of water softener according to the manufacturer's instructions.

Always add the detergent first, in compartments  and  followed by the softener, to ensure that both are properly dispensed.

Adding fabric softener or starch

If fabric softener is desired, it will work more effectively and be gentler on the clothes if it is dispensed in the final rinse cycle of the wash, rather than in the dryer with softener sheets. To automatically dispense fabric softener:

- Open the lid of compartment .

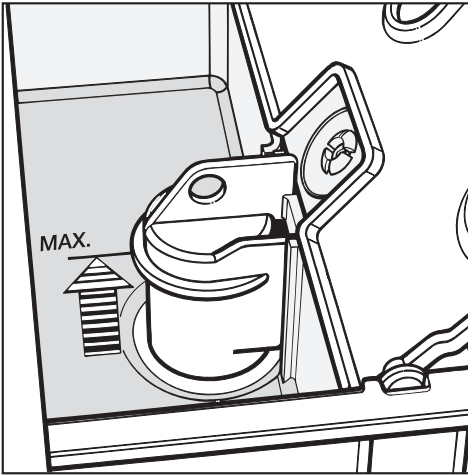

- Pour an amount of liquid fabric softener into compartment  according to the manufacturer's instructions. Do not exceed the maximum fill level marked inside the compartment, as the excess will prematurely activate the siphon and be wasted.
- Close the compartment lid and push in the dispenser drawer.

The softener will automatically be dispensed during the final rinse cycle.

At the end of the program a small amount of water will normally remain in compartment . A high water level in this compartment, however, may indicate that the dispenser drawer was opened, or the siphon is clogged. In this case, the siphon tube should be cleaned (see "Cleaning and Care").

Starch

Starching can be performed separately (see below) or can be included in any wash program as part of the final rinse.

Never mix fabric softener and starch together in compartment . This can clog the dispenser.

If starch is used for shirts, blouses, table cloths, napkins, etc., pour the liquid starch into compartment  (use the same procedure as for fabric softener).

Using the "Starch" program to dispense liquid starch.

- Prepare the starch solution according to the manufacturer's instructions and pour it into compartment .
- Use the normal water level (Water Plus button "out") when starching so that the solution will have the maximum effect.

"Without final spin" can be selected to reduce fabric creasing.

Program selection

Program	Temperature range	Fabric
COTTONS For cotton fabrics without special finishes.	85 - 105°F 105 - 120°F 140 - 190°F	For dark colored items. For light colored items. Exclusively white items.
PERMANENT PRESS For cotton blends, polyester blends and synthetics such as acrylic, nylon and ramie.	85° 105 - 120°F 140°F	For dark fabrics which are a blend or 100% synthetic fabrics. For light colored cotton or synthetic items. For white polyester/cotton items.
FINE/DELICATES For synthetics, machine washable silks, lace or crocheted (non-woolen) items, curtains and knits.	cold - 85°F 105 - 120°F 140°F	For dark colored silks and all synthetic items (lingerie). For light colored silks and lace tablecloths. For white cotton lace and crocheted items.
WOOLENS For all machine washable woolens and wool blends. 	cold	Use detergents made specifically for wool. Reduce or turn off the spin speed for „Hand wash only“ or non-wool items.
Starch	cold	For tablecloths, napkins, aprons and shirts.
Spin		For spinning wet items not washed in the machine (hand washed). Such items must be suitable for machine spinning.
Drain		For use when the laundry is to be removed wet for drip drying. Normally used in conjunction with „Without final spin“.
Fine rinse		For hand washed items that can be gently rinsed, and if desired, spun.

Program selection

max. load	Additional options available	Normal wash cycle	Rapid wash cycle
13 lbs 6 Kg	Pre-wash Water plus Gentle wash	Available	Available
6.5 lbs 3 Kg	Pre-wash Water plus Gentle wash	Available	Available
3.5 lbs 1.5 Kg	Pre-wash Gentle wash	Available	Available
4.5 lbs 2.0 Kg		Available	–
13 lbs 6.0 Kg		Available	
		Available	–
		Available	–
6.5 lbs 3.0 Kg		Available	–

Program sequence

	COTTONS	PERMANENT PRESS	FINE/ DELICATES
Pre-wash	Selectable ⁽¹⁾	Selectable ⁽¹⁾	Selectable ⁽¹⁾
Main wash	● ⁽¹⁾	● ⁽¹⁾	●
Interim rinse	●	●	–
Graduated rinse	–	●	●
Number of rinses	4	3	3
Rinse and interim spin	●	–	–
Graduated spin rpm	max. 800 ⁽²⁾	–	–
Final spin rpm	max. 1200	max. 900 ⁽²⁾	max. 600 ⁽²⁾
„Without final spin“ available	●	●	●
„Gentle wash“	Selectable	Selectable	Selectable
Wash rhythm	normal	normal	normal
Water level - wash - rinse	low ⁽¹⁾ low(1)	low ⁽¹⁾ high	high high
Approx. running time (Normal cycle)	1h 48 min	1 h 07 min	53 min

Explanations:

- Cycle included
- Cycle not included

Interim rinse:

Additional water flows into the drum, and the suds are cooled slightly.

Graduated rinse:

The suds are cooled at the end of the wash cycle by incoming water, and drained in intervals. This minimizes the danger of creasing by avoiding sudden temperature changes.

(1) Increased water level:

The water level can be increased from the normal level to a higher level by pressing the „Water plus“ button.

(2) Maximum spin speed is automatically set by the machine.

Program sequence

WOOLENS	Starch	Spin	Fine rinse
–	●	–	–
●	–	–	–
–	–	–	–
–	–	–	–
2	–	–	2
–	–	–	–
–	–	–	–
max. 1200	max. 1200	max. 1200	max. 900 ⁽²⁾
●	●	–	●
–	●	–	–
Woolens	normal	–	–
low	low	–	–
low	–	–	high
38 min	18 min	7 min	14 min

Graduated spin:

The speed is gradually increased, until the final spin speed is reached.

Final spin:

The maximum spin speed is held constant for a fixed period of time.

In the program PERMANENT PRESS, WOOLENS and Fine rinse the spin speed is automatically limited to 900 rpm and in the FINE/DELICATES program to 600 rpm, even if the selector has been set to a higher speed. A lower speed can also be selected.

Woolens:

Wool is susceptible to damage when it is wet. Agitation times during this program are shorter, and the drum rotation is slower.

„Without final spin“:

At the end of the final rinse the wash remains suspended in water if the SPIN SPEED SETTING is set to „Without final spin“. This helps to reduce creasing if the laundry will not be removed immediately upon completion of the cycle.

Textile care symbols

Some clothing manufacture's place textile care symbols on their products. The following is an explanation of some of these symbols.

Washing (°C)

 COTTONS

 PERMANENT PRESS

 FINE/DELICATES

 WOOLENS

The significance of the bar beneath the wash tub is:

no bar normal (maximum) agitation;
 used in the Cottons program

bar reduced (medium) agitation;
 used in the Permanent Press, Gentle wash, or Delicates program.

broken bar minimal agitation;
 used in the Woolens program



Hand wash



do not wash



dry clean only



do not dry clean



suitable for chlorine bleaching



not suitable for chlorine bleaching

Tumble dry



at normal temperature



at low temperature



do not tumble dry

Ironing



hot iron



medium hot iron



cool iron



do not iron

Temperature Conversion Chart

°C	30	40	50	60	70	80	90
°F	85	105	120	140	155	180	190

By using the pushbuttons to select one or more additional options, basic programs can be tailored to the type of laundry being washed.

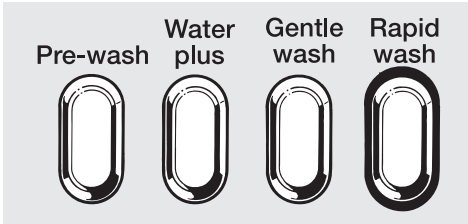

When the “Door” button is pressed, the other buttons will spring out, cancelling any additional options.

“Pre-wash”

- Use for heavily soiled or stained laundry items.
- Available in the “COTTONS”, “PERMANENT PRESS” and “FINE / DELICATES” programs.

The required amount of detergent should be added to compartment **L**.

“Water plus”

Slightly increases the water level, best used;

- For particularly delicate fabrics in addition to the “Gentle wash” option,
- In hard water areas, if additional water is required for dispensing detergent,
- In soft water areas to enhance washing and rinsing results.
- By people who are allergic to detergents.

The “Water plus” option is available in the following programs:

- The wash and rinse cycle in COTTONS.
- The wash cycle in PERMANENT PRESS.

“Gentle wash”

- Drum movement is reduced by half for gentle washing of slightly soiled laundry items, or delicate fabrics which otherwise tend to pill.

Available in the “COTTONS” and “PERMANENT PRESS” programs.

“Rapid wash”

- Offers a quick wash cycle (approx. 38 minutes)
- Can be used with or without a pre-wash. “Rapid wash” is available in all programs.

To operate:

- 1 Push in the ON/OFF button to turn on the machine.
- 2 Push in the Pre-wash button if desired.
- 3 Push in the Rapid wash button. Notice the thick gray ring surrounding the button. This gray ring corresponds to the gray ring surrounding the COTTONS, PERMANENT PRESS, and FINE / DELICATES programs on the Selector switch. As long as the program selected is within this ring, the actual wash times will be close to what is displayed.
- 4 Choose the desired program and the machine will start.

Delay start/Time remaining indicator

Time display “H:min”

The Time display has a dual function.

- It shows the time remaining in the wash program, and
- it shows the programmed “Start delay” remaining before the program begins.

Remaining time

The display will count down the time remaining in the wash program in one minute increments as soon as:

- A program is selected, or
- The time delay reaches zero.

Delay Start

Upon turning on the machine, the “Delay start” lamp will be blinking. The start of the program can be delayed up to 9 hours and 30 minutes.

Entering the start delay:

- Press the button to the left of the “Delay start” lamp as many times as necessary until the desired time delay appears. Each time the button is pressed, the delay will increase by 30 minutes.

Select the program

- The display will begin counting backwards in one minute increments. The “Delay start” lamp will remain lit.

Program start

- When the delay time reaches zero, the “Time remaining” lamp will illuminate, and the “Delay start” lamp will go out. The display will now show the time remaining in the wash program.

Deleting the start delay

- When the display reaches “9 h 30 min”, press the button to the left of the “Delay start” lamp and the delay will be deleted.

To clean the washing machine:

- Clean the casing using a mild non-abrasive detergent or soap and water, and wipe dry with a soft cloth.
- Clean the control panel with a damp cloth.
- If necessary, the drum can be cleaned using a stainless steel cleaner according to the manufacturer's instructions. A stainless steel cleaner specially formulated for use in washing machines is available from the Miele Technical Service Department.

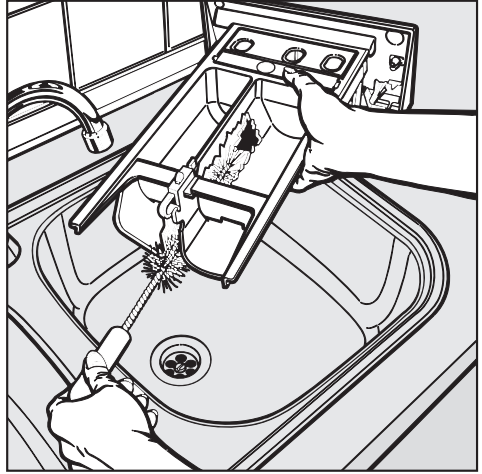

Do not use abrasive cleaners or solvents.

- Clean the dispenser compartments and the fabric softener duct.

Cleaning the detergent drawer

Should the detergent drawer become clogged or dirty, it can be cleaned as follows:

- Pull the drawer out until it stops.

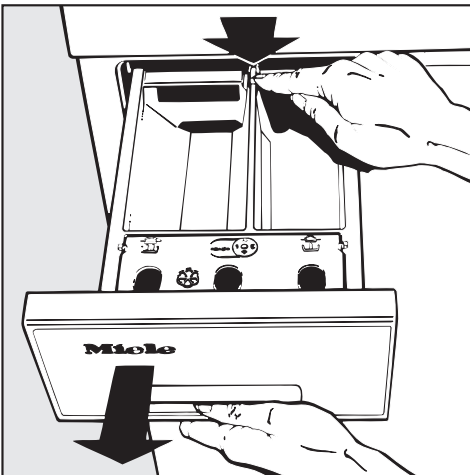

- Press down the red release lever and pull the drawer out of the machine.

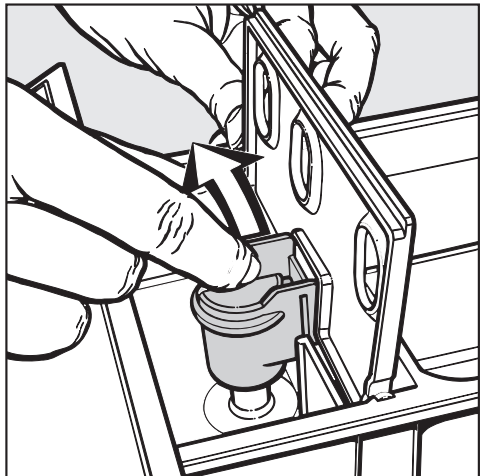

- Remove the siphon tube from compartment  and rinse in warm water.

Cleaning and care

Cleaning the drain pump and lint trap

Occasionally small objects, (buttons, coins, etc.), may find their way into the lint trap. If the machine does not drain completely, the lint trap should be checked to ensure that it is free of foreign objects.

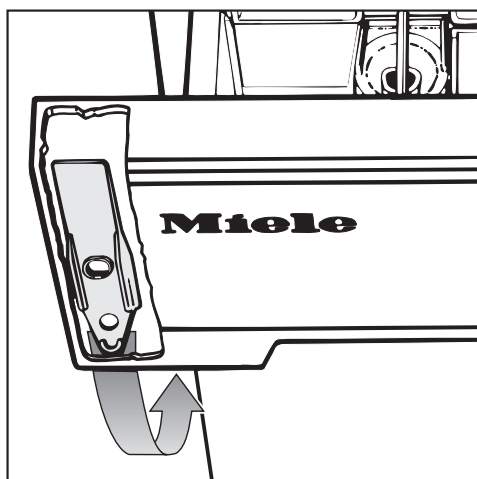

To clean the lint trap, remove the tool from behind the detergent dispenser drawer.

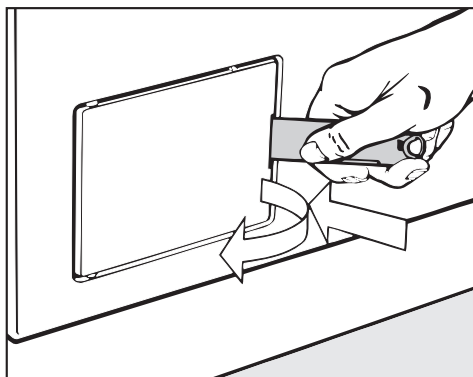

- Open the lint trap door.

- Place a 2 quart (2l) capacity container underneath the drain tube.

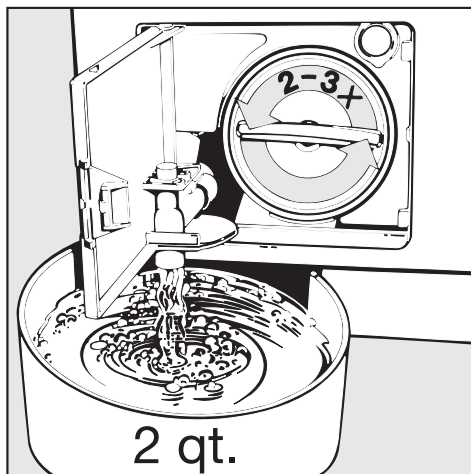

- Turn the lint trap lid counterclockwise 2 - 3 times. Do **not** remove it. Approx. 2 quarts (2 l) of water will drain out of the hose.

If the main drain hose is clogged, more water will be retained in the machine (**max. 6.5 gal/25l**). In this case, tighten the lint trap lid and empty the dish before repeating the procedure as often as necessary.

Caution: If laundry has been washed at a high temperature, the water draining out of the machine will still be hot! Stop and allow it to cool before proceeding.

- Once the flow of water stops, remove the lint trap and clean it.

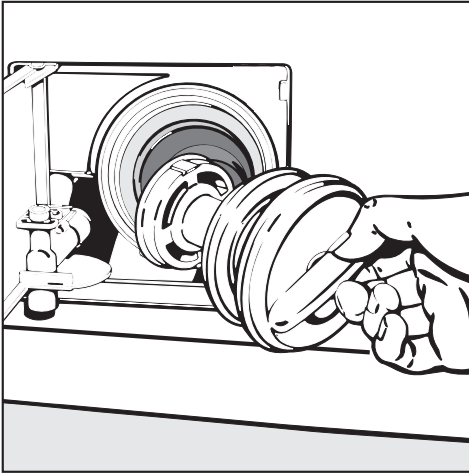

- Remove any foreign objects (e.g. buttons, coins, etc.) or lint.
- Turn the drain pump impeller (in the back of the chamber) by hand to check that it rotates freely.

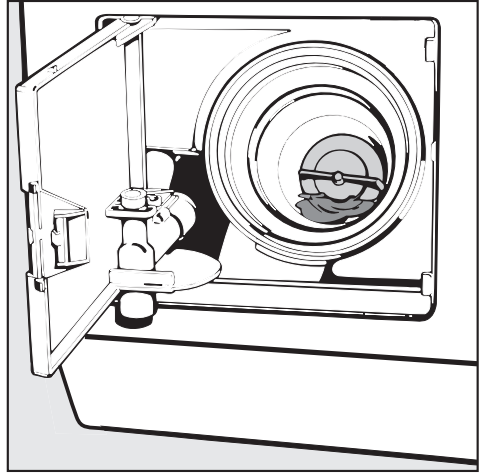

- Clean the inside of the lint trap housing.

Remove any detergent deposits or foreign objects from the thread of the filter housing and filter unit before replacing the lint trap.

Cleaning and care

Cleaning the water inlet filters.

The washing machine has two water inlet filters to protect each inlet valve.

To clean the filter in the inlet hose:

- Turn off the valve.
- Carefully unscrew the inlet hose from the valve by turning the connector counterclockwise using a wrench if necessary.
- Remove the rubber seal from the connector.

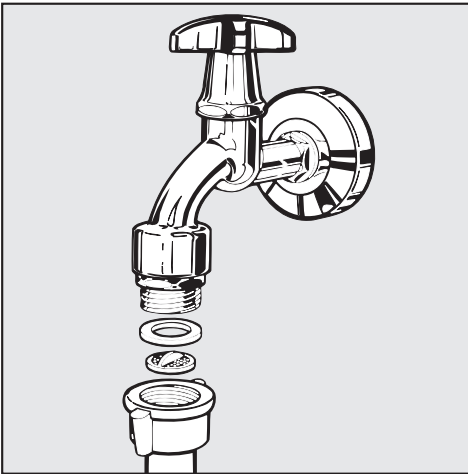

- Using needle nose pliers, grasp the plastic filter and pull it out of the hose connector. Clean the filter under running water and carefully remove any large particles.
- Replace the filter and seal and reconnect the hose. Slowly turn on the valve and check for leaks.

Inspect the inlet hose regularly. The hose should be replaced if there are small cracks in the surface, or if it has been otherwise damaged or cut.

If a replacement is necessary, use only a genuine Miele inlet hose as other hoses may burst under pressure.

To clean the filter in the inlet valve:

- Using a wrench, carefully loosen and remove the plastic hose connector on the inlet valve.

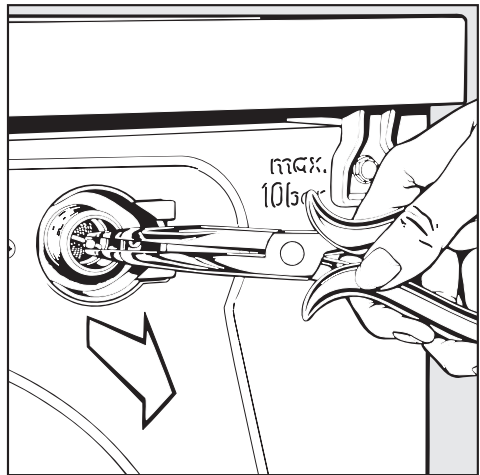

- Using needle nose pliers, withdraw the plastic filter by pulling on the bar (see illustration). Rinse under water to clean, and then replace.

The two filters - one at the pressure hose/valve connection and one at the inlet connection to the solenoid valve - must not be removed.

Any work done on the electrical components of this appliance should only be performed by a qualified technician in accordance with all local and national codes and regulations. Unauthorized repairs may result in personal injury and machine damage.

What to do if, . . .	Cause . . .	Remedy . . .
. . . The program does not start?	There is no power. The "ON" indicator lamp has not lit up.	Check that.: – the door is properly closed. – the machine is plugged in. – the fuse or circuit breaker has not tripped.
	There is power and the "ON" indicator lamp is on, but the program selector has not been turned to the "Finish / Start" position.	– Turn the program selector to the "Finish / Start" position. – Select a program.
. . . The "Check ㄱ / ㄴ" indicator lamps are flashing?	The "Check ㄱ" indicator lamp is flashing, and the program has started. The water inlet is blocked.	– The inlet valve is not opened far enough. – The inlet hose is kinked. – The water pressure is too low. Call the Technical Service Dept.
	The "Check ㄴ" indicator lamp is flashing. The drain is blocked.	– Clean the drain pump and lint trap. – Has the drain hose been installed too high? (max drain height = 4 feet)

Problem solving guide

What to do if, . . .	Cause . . .	Remedy . . .
. . . the “Pre-wash”, “Main wash” or “Rinse 1-2” indicator lamp is flashing?	There is an internal problem.	Restart the program. If the indicator lamp starts flashing again, call the Service Dept.
. . . The “Rinse & hold” indicator lamp is flashing?	The spin speed selector has been set to “Without final spin”.	Select a spin speed setting.
. . . The “Final spin” indicator lamp is flashing?	The final spin has not taken place. The machine detected an imbalance.	<ul style="list-style-type: none"> – Redistribute the laundry load. – Select a spin speed. – Turn the program selector to “Spin”.
. . . The “ON” indicator lamp is flashing?	The child-safety feature is activated, and the program has been changed.	Go back to the program originally selected.
. . . The wash is too wet after the final spin?	The spin speed selected was too low.	Select a higher spin speed next time.
	The load was not evenly distributed in the drum, and the laundry was spun at a reduced speed to protect the machine.	Mix large and small items in a load to avoid imbalance.
	The drain pump or lint trap is clogged.	Clean the drain pump or lint trap.
. . . The machine shakes during the spin cycle?	The four feet are not resting evenly on the floor.	Level the machine (see Installation Section).
	The shipping struts have not been removed.	Remove the shipping struts.

Problem solving guide

What to do if, . . .	Cause . . .	Remedy . . .
. . . In spite of adequate water supply, the water flows slowly into the machine?	A water inlet filter is blocked.	Clean the water inlet filters.
. . . Large residues of detergent remain in the dispenser drawer?	The water pressure is too low.	<ul style="list-style-type: none"> – Clean the filters in the water inlet system. – It may help to select “Water plus”.
	Detergent used with a water softener tends to become sticky.	Pour detergent into the dispenser before adding any water softener.
. . . Fabric softener is not completely dispensed or water remains in the  compartment?	The dispenser drawer was not pushed in when the fabric softener was being dispensed.	Make sure the drawer is in all the way.
	The siphon tube is either incorrectly positioned or clogged.	Clean the siphon tube.
. . . There is an excessive build-up of foam?	Use only a low-sudsing detergent at the appropriate temperature.	<ul style="list-style-type: none"> – Follow recommendations on the package. – Take the water hardness into account. – Use less detergent for lightly soiled or small loads.
. . . Lime deposits appear on the drum surface?	Not enough detergent has been used.	<ul style="list-style-type: none"> – Use a decalcifier suitable for use in washing machines. A product called “Quick” is available from the Miele Technical Service Dept. – Use the correct amount of detergent for the water hardness in your area.

Problem solving guide

What to do if, . . .	Cause . . .	Remedy . . .
. . . Grey greasy particles cling to washed laundry?	Insufficient detergent was used to break down the particles of grease in heavily soiled laundry.	<ul style="list-style-type: none"> – Add more detergent. – Before washing the next load run a COTTONS 120°F program with detergent but without a load to clean the machine.
. . . Liquid detergent does not give the desired result?	Liquid detergents do not contain bleaching agents. They do not remove stains as well as powdered detergents containing non-chlorinated bleaches.	<ul style="list-style-type: none"> – Use a general purpose powder detergent containing a bleaching agent. – Pre-treat stains with a stain remover.
. . . After washing pilling appears on the fabric?	This is a normal occurrence of everyday wear with some fabrics.	These fabrics must be handled with care. Wash them using the DELICATES program and/or select „Gentle wash“ in the future.

Opening the drum door during a power failure

To prevent water from spilling on to the floor, make certain the machine is drained before opening the door.

- Turn off the washing machine.
- Open the lint trap door and drain any water as described in the Cleaning and care section.

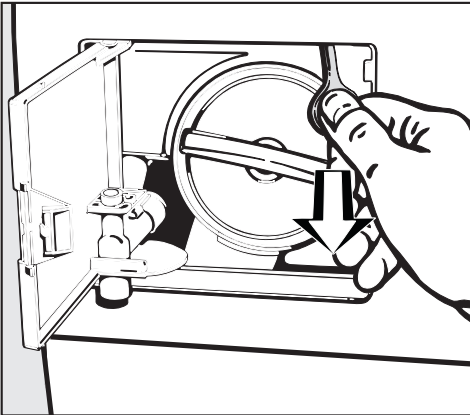

- Pull down the ring in the upper right corner of the access area, and the door will open.

Never reach into a rotating drum! Always make sure the drum is stationary before reaching in to remove laundry. Reaching into a moving drum is extremely dangerous.

To check water pressure

- Place a bucket under the water supply valve.
- Turn on the valve.

If 1 gallon (3.8 l) of water flows into the bucket in 15 seconds the water pressure is adequate.

Electricity

- If there is any doubt about the electrical supply or connection, consult a qualified electrician.

After sales service

If problems occur that cannot be easily fixed, or if the appliance is under warranty, please contact:

- The nearest Miele Technical Service Department (see back cover).

When contacting the Technical Service Department, please have the model and Serial numbers of your appliance available, both which can be found on the dataplate visible above the front glass on the inside of the door.

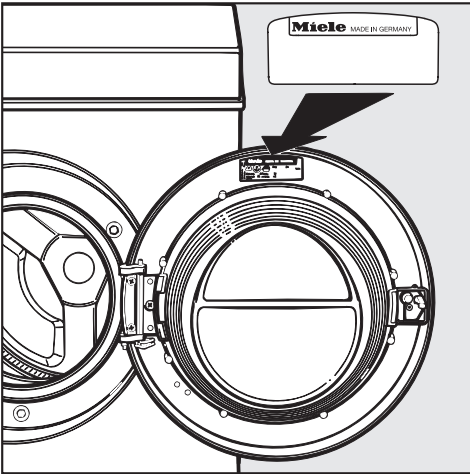

INSTALLATION INSTRUCTIONS

Installation surface

Experience has shown that a concrete floor is the most suitable surface for a washing machine. Concrete floors are less prone to vibration during the spin cycle than wooden floors.

Please note the following points:

- The machine must be level and securely positioned.
- To avoid vibration during spinning, the machine should not be installed on soft floor coverings.
- If installation must be on a wooden joist floor, we recommend the use of a plywood base at least 1 1/4" thick by 23 5/8" X 23 5/8" wide (30mm X 600mm X 600mm). Ideally the base should be large enough to span several joists and should be anchored to the joists and not just the floorboards.
- As a general rule, we recommend the installation of the machine (or washer/dryer stack) in the corner of a room where the stability of the floor is greatest.
- If the machine is installed on a raised platform, it should be secured using retaining clips (available from the Miele Technical Service Dept.). If installed on a masonry or concrete base, the base should be provided with a rim 1/2" to 3/4" (12-20 mm) high.

Installation

Lift the machine from its shipping pallet and move it to the installation site.

Please note:

- Do not lift the machine by the drum door.
- Ensure that the machine feet and the floor are dry to prevent slippage during the spin cycle.

Removing the shipping struts

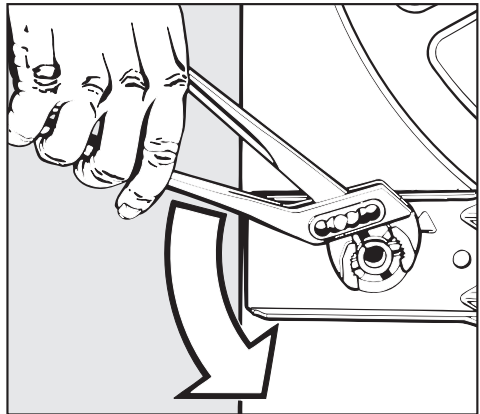

- Turn the left shipping strut 90° counterclockwise.

INSTALLATION INSTRUCTIONS

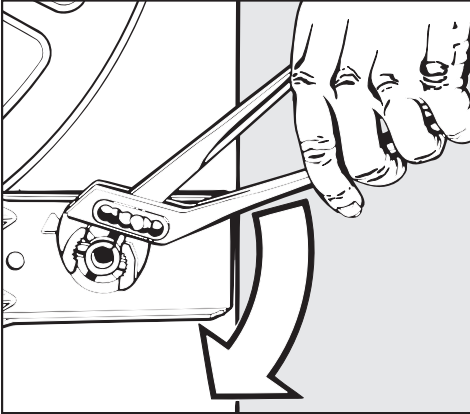

- Turn the right shipping strut 90° clockwise.

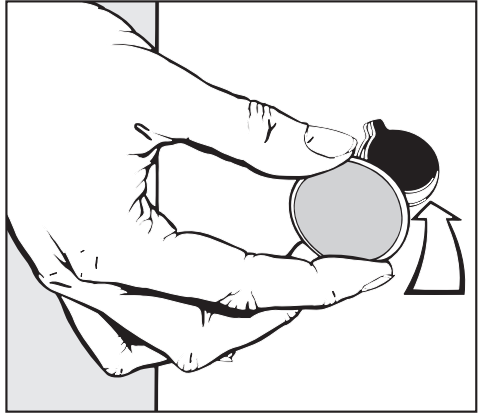

- Plug the two holes with the plastic caps provided.

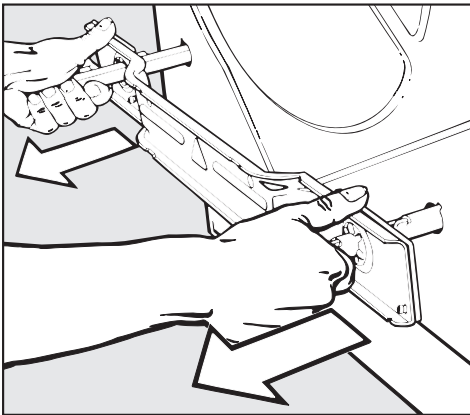

- Withdraw the two struts together with the support plate.

Movement of the machine without the shipping struts in place should be kept to a minimum.

The shipping struts should be stored in a safe place for future use. They must be reinstalled before the machine is moved. Reinstallation can be performed by reversing the above procedure.

INSTALLATION INSTRUCTIONS

Leveling the machine

To ensure smooth operation, it is **essential** that the machine is level.

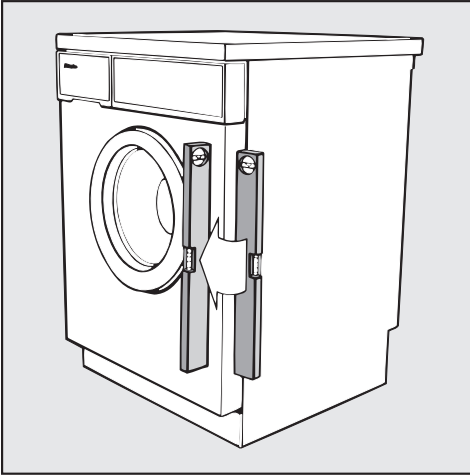

Failure to level the machine can result in the machine “banging” in the spin cycle or “walking” across the floor during operation. Energy and water use will also increase.

Adjust the four leveling feet as follows:

- Tip the machine slightly and place a support, such as a block of wood, underneath it.

BEWARE : The washing machine is heavier than it looks! When tipping the machine, be careful that it does not slip or slide along the floor. Take care not to injure yourself or damage any surrounding furniture.

- Unscrew each of the four feet as much as necessary by turning both the foot **1** as well as the locking ring **2** to the left using a screwdriver (see illustration).
- Remove the supports, stand the machine on its feet and check to see if it is level.

Repeat this procedure as often as necessary until the machine stands level.

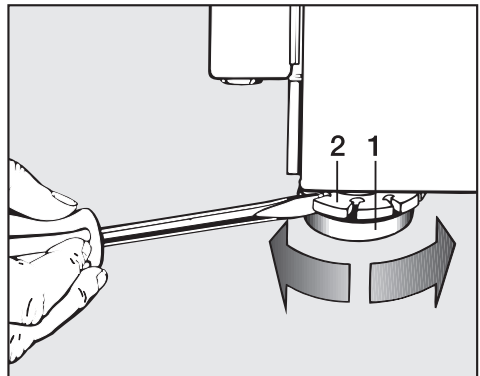

- Once level, hold the foot **1** immobile using a wrench while turning the locking ring **2** to the right using a screwdriver. Turn each locking ring until it is tight against the bottom of the machine frame.

All four locking rings must be tight against the bottom of the machine. In addition, check to see that the feet were not inadvertently unscrewed while tightening the rings. Running a machine that is not level or whose feet are not tight may cause damage to both the machine and its surrounding area.

INSTALLATION INSTRUCTIONS

If a countertop is placed over the washer, at least a 1/4 gap must be left between the top of the machine and bottom of the countertop; and nothing should be within 1/2" of any other side of the washing machine.

Washer / Dryer Stack

This Miele washing machine can be installed as part of a washer dryer stack in combination with a Miele tumble dryer. The dryer can only be stacked on top of the washer and never vice versa.

For this purpose, a stacking kit is available from the Miele Technical Service department or your Miele dealer.

A washer and dryer should never be stacked without using the proper stacking kit. Doing so is extremely dangerous, as the dryer may vibrate off of the washing machine during use.

INSTALLATION INSTRUCTIONS

Any residual water left in the machine from the factory testing process can be flushed out as follows:

- Do not put any laundry in the machine.
- Place 1/4 of the recommended amount of detergent in compartment **W**.
- Turn on the machine.
- Press the “Rapid wash” button.
- Turn the program selector to the “COTTONS 140°F” program.
- Any residual water will be flushed out during the wash program.

Water hardness reminder

The amount of detergent needed to wash clothes depends on various factors, including the water hardness in your area. You can set the water hardness dial in the detergent dispenser as a reminder.

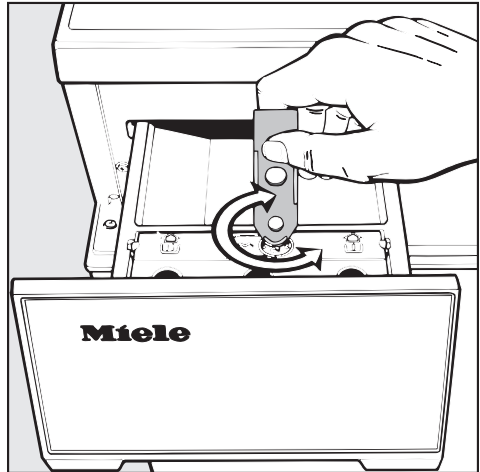

- Turn the dial to the desired setting. Use the tool supplied with the machine. It is located behind the detergent drawer, on the left hand side (see Cleaning and Care).
1 = soft, 4 = very hard water

Plumbing Connections

Connect the cold water intake hose (blue mark) to the cold water valve and the hot water intake hose (red mark) to the hot water valve.

Turn on the valves and check for leaks. The water pressure must be within 15-145 psi (1-10 bar). If the water pressure is greater than 145 psi (10 bar), a pressure reducer must be installed. If the water pressure is below 15 psi (1 bar), insufficient water may be available for a complete fill.

The water intake hoses are equipped with screen filters. Please do not remove these filters.

Please note

If the machine is being connected to a cold water supply **only**, both the hot and cold water intake hoses should be attached to the cold water valve through the use of a Y adapter (available at any hardware store). Both hoses **must** be connected to a water source, or the machine will not function properly. **Do not** connect the washer to hot water only.

Connection to the drain system

The 5 ft. (1.5 m) drain hose may be connected as follows:

- 1. Directly into a sink:** hook the hose over the edge of the sink and secure it firmly (e.g. by tying the hose to the water faucet).
- 2. To a stand pipe:** place the drain hose into a 1 1/2" (38 mm) stand pipe and firmly secure it.
- 3. To a floor drain:** The machine is equipped with an airgap/anti-siphoning system so that no minimum drain height is required.
 - The machine drains using a pump with a maximum delivery height of 4 ft. (1.2 m).
 - Make sure there are no kinks in the drain hose.
 - If desired, the drain hose may be extended to 15 ft. (4.5 m) maximum.

GROUNDING INSTRUCTIONS

This appliance must be grounded.

In the event of a malfunction or breakdown, grounding will reduce the risk of electric shock by providing a path of least resistance for the electric current. This appliance is equipped with a cord having an equipment grounding conductor and plug. The plug must be plugged into an appropriate outlet that is properly installed and grounded in accordance with all local codes and ordinances.

Warning

Improper connection of the equipment-grounding conductor can result in the risk of electric shock. Check with a qualified electrician if you are in doubt as to whether the appliance is properly grounded.

Do not modify the plug provided with the appliance; if it will not fit the outlet, have the proper outlet installed by a qualified electrician.

ELECTRICAL INSTRUCTIONS

This installation should be done by an experienced and qualified technician, in accordance with local codes and regulations.

The washing machine is supplied with a 5 ft long, 4 wire cord, ending in a NEMA 14-30 P plug, ready for connection to a 120 V/240V (208 V) 60 Hz, AC power supply.

The proper outlet can be purchased from any electrical supply dealer or from the Miele Technical Service Dept. Ask for a NEMA 14-30 R receptacle.

“EASY INSTALLATION KIT”

If you don't have a dedicated 4 wire, 120 V/240 V (208 V), 15 Amp line for this appliance, but you have a 3 or 4 wire, 240 V (208 V), 30 Amp line, you can use an optional “Easy Installation Kit”, which will allow you to connect this appliance to that line.

For more information on the electrical connection and the “Easy Installation Kit” please contact

- the nearest Miele Technical Service Department.

Programmable functions

Warning - To reduce the risk of fire, electric shock, or injury to persons, read the IMPORTANT SAFETY INSTRUCTIONS before operating this appliance.

The following additional functions can be programmed into the machine if desired:

A High water level (only in “Cottons” rinses)

Where rinse results are particularly important (e.g. Soap allergies).

B 5th Rinse in the “Cottons” program

For soft water areas (up to 135 ppm calcium carbonate).

In soft water areas, a higher water level can be selected in addition to a 5th rinse cycle, if required.

C Extra water intake through compartment

A 10 second water intake through compartment  during the main wash can be added.

D Program Lock (Child Safety Feature)

When activated, the washing machine will ignore any changes made after the first three minutes of operation. For example, if the Program Selector is moved to a different setting or an additional function is selected after the first three minutes, the “On” lamp will flash, notifying you that the Child Safety Feature has been activated. The program will, however, continue uninterrupted. This prevents children from inadvertently changing or stopping a wash program by playing with the dials.

If the Program Selector is turned to its original position, the “On” lamp will stop flashing.

To change a program once the Program Lock is activated:

- Turn the Program Selector to “Finish/Start”.

After about 30 seconds, the sequence indicator lamps will start flashing in succession. A new program can be selected as soon as the “On” lamp is the only one remaining lit.

E Additional rinse in Rapid wash

For soft water areas.

For an extra thorough rinse.

The functions described above can be programmed by the owner using the steps shown on the following pages.

Programmable functions

Step 1:

Turn off the machine, close the door, and release all pushbuttons. Set the Program Selector Switch to "Finish/Start".

Step 2: Perform steps 2 and 3 within 4 seconds.

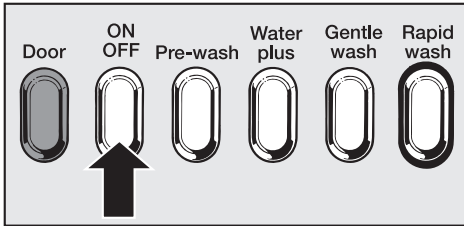

- Press the "ON/OFF" button

Step 3:

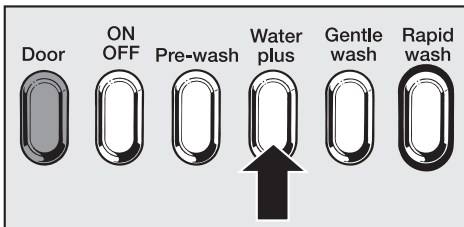

- Press the "Water plus" button 4 times (i.e. press in and out twice)

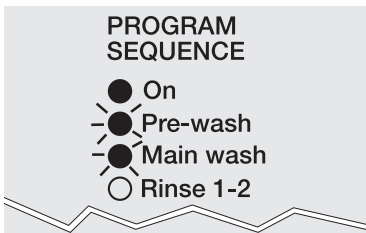

The "ON" lamp will illuminate and the "Pre-wash" and "Main wash" lamps will flash.

Programmable functions

Step 4: Select the desired function:

Desired function:
A High water level

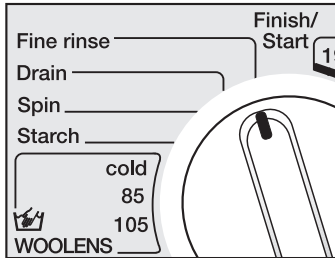

- Set the Program Selector to “Fine rinse”. Continue with **Step 5** to activate.

B 5th rinse cycle

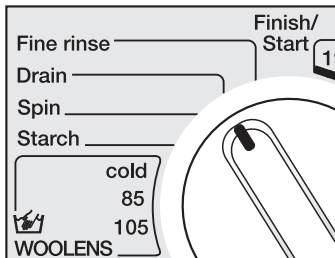

- Set the Program Selector to “Drain”. Continue with **Step 5** to activate.

C Water intake through compartment

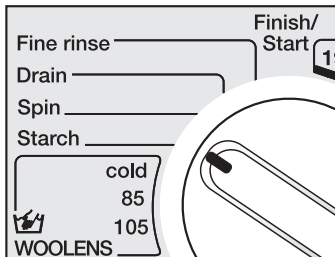

- Set the Program Selector to “Starch”. Continue with **Step 5** to activate.

D Program Lock (Child safety feature)

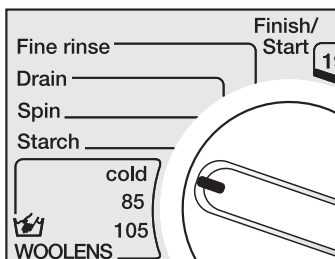

- Set the Program Selector to “WOOLENS cold”. Continue with **Step 5** to activate.

Programmable functions

ⓔ Additional rinse in Rapid wash

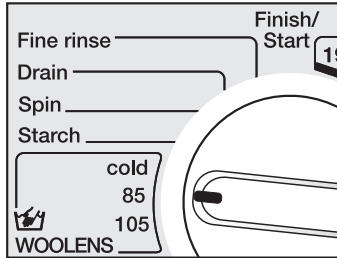

- Set the Program Selector to “WOOLENS 85°”. Continue with **Step 5** to activate.

Step 5: activate the function

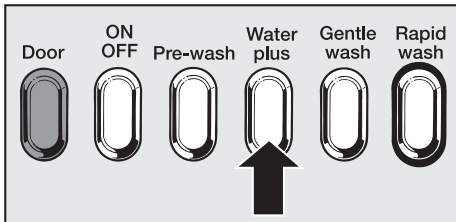

- Press the “Water plus” button twice (i.e. in and out once) to toggle the function “ON/OFF”.

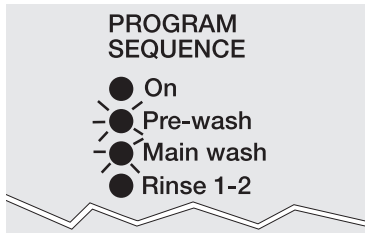

The “Rinse 1-2” lamp will illuminate when the function is activated.

Step 6: to store in memory

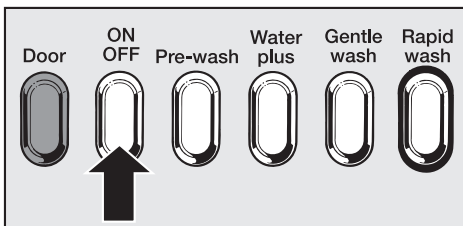

- Press the “ON/OFF” button.

Programmable functions

To check if the function has been stored:

- Perform **Steps 1 to 4**.

If the "Rinse 1-2" lamp lights up, the programmable function is active.

- Press the "ON/OFF" button. This finishes the check of the programmable function.

If, after Step 2, the selector switch is accidentally turned to a setting other than one of the three shown:

- If the "Rinse 1-2" indicator does not light up - no function was activated
- If the "Rinse 1-2" indicator lights up - proceed as in "Deleting the additional functions".

Exception: the "Rinse 1-2" indicator lamp will light up if the switch is set to "COTTONS 190°F".

Deleting the additional functions:

Follow the same instructions given under "To activate the additional functions", steps 1 to 5.

When the "Rinse 1-2" lamp goes out;

- Press "ON/OFF".

The additional function has now been deleted.

1.1 Dimensions

Height	33 ¹ / ₂ " + 1/ ₂ " / -1/ ₄ "	(850 mm + 10 / -0,5 mm)
Width	23 ⁵ / ₈ "	(600 mm)
Depth (including distance from wall)	28 ¹ / ₄ "	(715 mm)
Weight	252 lbs.	(114 kg)
Capacity	13 lbs.	(6 kg) dry laundry
Rated load	2.8 kW	
Circuit breaker	15 Amp	
Water pressure	14.5-145 p.s.i.	(1-10 bar)
Maximun drain height	4.0 ft.	(1.2 m)
Drain hose diameter	1" I.D.	(25 mm)
Maximum drain length	15 ft.	(4.5 m)
Power supply	120 V/240 V (208 V)	single phase 60 Hz, AC
Max floor load	682 lbs	3030 Newton

Technical data

1.2 Specifications

Hot and cold water hoses come equipped with 3/4" female hose thread connections.

Drainage is via a 5 ft. long (1.5 m), 1 1/4" OD hose.

This washing machine is supplied with a 5 foot long cable with plug for connection to a 120/240 V (208 V) 60 Hz (3-pole-4 wire grounding) power supply.

Program duration (approximate):

Cottons without prewash	190°F	1 h 48 min
Rapid wash - Cottons (3.5 lbs)	140°F	38 min

Spin speed:

W 1926 from 600 to 1200 rpm

Detergent dispenser:

Automatic for:
Pre-wash
Main wash
Fabric softener or starch

Temperature control: Variable from cold to 190°F



Miele, Inc.

National Headquarters

9 Independence Way
Princeton, NJ 08540
Phone: 800-843-7231, 609-419-9898
Fax: 609-419-1435
Technical Service: 800-999-1360
www.mieleusa.com

New England Showroom

555 Washington Street
Wellesley, MA 02482
Phone: 781-431-2225
Fax: 781-431-0003

Southeast Regional Headquarters

6400 Congress Avenue
Suite 1700
Boca Raton, FL 33487
Phone: 561-995-8030
Fax: 561-995-8083

West Coast Regional Headquarters

680 Eighth Street
Suite 168 - Sobel Building
San Francisco, CA 94103
Phone: 800-245-8215
415-241-6820
Fax: 415-241-6822

WEST COAST REGIONAL SERVICE 800-245-8215

Southern California Showroom

189 North Robertson Blvd.
Beverly Hills, CA 90211
Phone: 310-855-9470
Fax: 310-358-0238

Mid West Regional Headquarters

3100 West Dundee Road
Suite 901
Northbrook, IL 60062
Phone: 847-714-9433
Fax: 847-714-9434

Miele Limited

Canadian Head Office

55G East Beaver Creek Road
Richmond Hill
Ontario L4B 1E5
Phone: 905-707-1171
Toll-Free: 1-800-565-6435
Fax: 905-707-0177

Internet: www.miele.ca
E-Mail: info@miele.ca
(general enquiries)
E-Mail: service@miele.ca
(technical service)

BC Regional Sales Office

3731 North Fraser Way
Unit 200
Burnaby
British Columbia V5J 5J2
Phone: 604-434-1300
Fax: 604-434-1309

Quebec Regional Sales Office

400 Laurier Avenue West
Suite 600
Montreal
Quebec H2V 2K7
Phone: 514-277-1818
Toll-Free: 1-877-636-4353
Fax: 514-277-1838

Free Manuals Download Website

<http://myh66.com>

<http://usermanuals.us>

<http://www.somanuals.com>

<http://www.4manuals.cc>

<http://www.manual-lib.com>

<http://www.404manual.com>

<http://www.luxmanual.com>

<http://aubethermostatmanual.com>

Golf course search by state

<http://golfingnear.com>

Email search by domain

<http://emailbydomain.com>

Auto manuals search

<http://auto.somanuals.com>

TV manuals search

<http://tv.somanuals.com>