

## Operating instructions for Washing machine PREMIER 300

To avoid the risk of accidents or damage to the machine it is **essential** to read these operating instructions before it is installed or used for the first time.



M.-Nr. 06 020 330

# Caring for our environment

---

## **Disposal of the packing material**

The transport and protective packing has been selected from materials which are environmentally friendly for disposal and can normally be recycled.

Ensure that any plastic wrappings, bags etc. are disposed of safely and kept out of the reach of babies and young children. Danger of suffocation!

Rather than just throwing these materials away, please ensure they are offered for recycling.

## **Disposal of your old appliance**

Old appliances contain materials which can be recycled. Please contact your dealer, your local waste collection centre or scrap merchant about potential recycling schemes.

Ensure that the appliance presents no danger to children while being stored for disposal. See the appropriate advice in the "Warning and safety instructions".

<b>Caring for our environment</b> . . . . .	2
Disposal of the packing material . . . . .	2
Disposal of your old appliance . . . . .	2
<b>Warning and safety instructions</b> . . . . .	6
<b>Description of the appliance</b> . . . . .	9
Special programmes . . . . .	9
Delicates and Silks  programmes . . . . .	9
Water plus system . . . . .	9
Future updates (PC) . . . . .	10
Control panel . . . . .	11
Important control panel features . . . . .	12
Programme selector . . . . .	12
Additional option buttons . . . . .	12
"Spin" button with indicator lights . . . . .	12
<b>Before using for the first time</b> . . . . .	13
<b>Washing environmentally and economically</b> . . . . .	14
<b>How to wash correctly</b> . . . . .	15
Brief instructions . . . . .	15
Programme chart . . . . .	16
Before washing . . . . .	20
Selecting a programme . . . . .	21
Additional options . . . . .	22
At the end of a programme . . . . .	24
Adding or removing laundry after a programme has started . . . . .	25
Interrupting a programme . . . . .	26
Altering a programme once selected . . . . .	26
Skipping a programme stage . . . . .	26
To cancel or select a different programme . . . . .	26
Programme sequence . . . . .	27

# Contents

---

<b>Detergent</b> . . . . .	29
Water softeners . . . . .	29
Washing with several components . . . . .	29
Fabric conditioners and liquid starch . . . . .	30
Automatic dispensing of fabric conditioner or liquid starch to laundry at the end of a programme . . . . .	30
Adding fabric conditioner separately . . . . .	30
Adding starch separately . . . . .	30
Colour run and dye removers/dyes . . . . .	30
<b>Cleaning and care</b> . . . . .	31
E-Cloth . . . . .	31
Extra cleaning . . . . .	31
Cleaning the detergent dispenser drawer . . . . .	32
Cleaning the fluff (drain) filter and pump . . . . .	33
Cleaning the water inlet filters . . . . .	35
To clean the filter in the union in the open end of the inlet hose: . . . . .	35
To clean the filter in the water inlet valve . . . . .	35
<b>Problem solving guide</b> . . . . .	36
The programme does not start. . . . .	36
The wash programme stops and a fault indicator light comes on. . . . .	37
A fault indicator light comes on but the wash programme continues as normal. . . . .	38
General problems or an unsatisfactory wash result . . . . .	39
The drum door does not open when you press the Door button. . . . .	41
Opening the drum door in the event of a power failure . . . . .	42
Customer contact . . . . .	43

<b>Installation and connection</b> . . . . .	44
Front view . . . . .	44
Rear view . . . . .	45
Installation surface . . . . .	46
Installing the washing machine . . . . .	46
Removing the transit fittings . . . . .	46
Re-fitting the transit bars . . . . .	48
Levelling the machine . . . . .	49
Screwing out and adjusting the feet . . . . .	49
Building under a continuous worktop/in a kitchen run . . . . .	50
Washer and Dryer stack . . . . .	50
The Miele water protection system . . . . .	51
Connection to the water supply . . . . .	52
Connection to the drainage system . . . . .	53
Electrical connection U.K. . . . .	54
<b>Consumption data</b> . . . . .	56
<b>Technical data</b> . . . . .	57
<b>Programmable functions</b> . . . . .	60
Water plus system . . . . .	60
Gentle action . . . . .	62
Top-up rinse for <i>Cottons</i> . . . . .	63
Memory function . . . . .	64
Soak . . . . .	65

# Warning and safety instructions

---

Read the operating instructions before using this machine for the first time. They contain important information about the safety, use and maintenance of the machine. This way you will avoid the risk of accidents and damage to the machine. Keep these operating instructions in a safe place and ensure that new users are familiar with the content. Pass them on to any future owner of the machine.

## Correct usage

Only use the washing machine to wash items which are specified by the manufacturer to be machine-washable on the wash-care label, and textiles composed of hand-washable wool or wool blend fabrics as well as satin, lace, silk and other hand-washable garments.

Any other applications may be dangerous. The manufacturer is not liable for damage resulting from improper use or operation.

This appliance is not a toy! To avoid the risk or injury do not allow children to play on or near it or to play with the controls. Supervise its use by the elderly or infirm.

## Technical safety

Before setting up the machine, check it for any externally visible damage. Do not install and use a damaged machine.

Before connecting the machine, ensure that the connection data on

the data plate (fusing, voltage and frequency) match the mains electricity supply. If in any doubt, consult a qualified electrician.

The electrical safety of this appliance can only be guaranteed when continuity is complete between the machine and an effective earthing system which complies with local and national regulations. It is most important that this basic safety requirement is present and regularly tested and where there is any doubt the household wiring system should be inspected by a qualified electrician.

The manufacturer cannot be held liable for the consequences of an inadequate earthing system (e.g. electric shock).

Do not connect the appliance to the mains electricity supply by an extension lead. Extension leads do not guarantee the required safety of the appliance (e.g. danger of overheating).

The machine is built in accordance with current safety requirements. Unauthorised repairs could result in unforeseen dangers for the user, for which the manufacturer cannot accept liability. Repairs should only be undertaken by a Miele approved technician. Ensure current is not supplied to the appliance while maintenance or repair work is being carried out.

The machine is only completely isolated from the electricity supply when:

- it is switched off at the wall socket and the plug is withdrawn, or
- it is switched off at the mains, or
- the mains fuse is withdrawn.

# Warning and safety instructions

---

■ This machine must only be connected to the on-site water supply using a new hose kit. Old hoses must not be re-used. Check the hose regularly for signs of wear and tear. Change in good time to avoid the risk of leaks and subsequent damage.

■ Faulty components must only be replaced by genuine Miele original spare parts. Only when these parts are fitted can the safety standards of the machine be guaranteed.

■ If the connection cable is faulty it must only be replaced by a Miele approved service technician to protect the user from danger.

■ In countries where there are areas which may be subject to infestation by cockroaches or other vermin, pay particular attention to keeping the appliance and its surroundings in a clean condition at all times. Any damage which may be caused by cockroaches or other vermin will not be covered by the appliance guarantee.

## Use

■ This equipment is not designed for maritime use or for use in mobile installations such as caravans, aircraft etc. However it may be suitable for such usage subject to a risk assessment of the installation being carried out by a suitably qualified engineer.

■ Do not install your washing machine in rooms where temperatures below freezing may occur. Frozen hoses may burst under pressure. The reliability of the electronic control unit may be impaired at temperatures below freezing point.

■ Before using the machine for the first time, check that the transit fitting at the rear of the machine has been removed (see section on "Installation"). During spinning, a transit fitting which is still in place may result in damage to both the machine and adjacent furniture or appliances.

■ Turn off the stopcock if the machine is to be left for any length of time (e.g. holiday), especially if there is no floor drain (gully) in the immediate vicinity.

■ Flooding danger.

■ If hooking the drain hose into a wash basin, check that the water can drain off quickly enough to prevent the sink from overflowing. Make sure the drain hose is secure, so that the force of the water flowing out of the hose does not dislodge it. Otherwise this will result in flooding.

■ Take care to ensure that foreign objects (e.g. nails, pins, coins, paper clips) do not find their way into the machine with the laundry. These may damage components of the machine (e.g. suds container, drum), which in turn can result in damage to the laundry.

# Warning and safety instructions

---

■ If the correct amount of detergent is dispensed, the machine should not need to be descaled. If, however, you do wish to descale the machine only use proprietary non-corrosive descaling agents and strictly observe the instructions on the packaging. If in doubt, contact the Miele Customer Service Dept. or your Miele Dealer.

■ Textiles which have been pre-treated in solvent based cleaning agents must be thoroughly rinsed in clean water before being washed in the machine.

■ Never use solvent based cleaning agents in this machine, as this may result in damage to component parts and create toxic fumes. Such detergents also pose a fire and explosion hazard.

■ Only use dyes specified by the manufacturer as being suitable for use in a domestic washing machine. Always observe the manufacturer's instructions carefully.

■ Colour run and dye removers contain sulphur compounds which can cause damage such as corrosion. Do not use these products in this machine.

■ For machines with a 'porthole' door, remember that the porthole glass will be hot when washing at very high temperatures. Do not let children touch it.

■ Always make sure the drum is stationary before reaching in to remove washing. Reaching into a moving drum is extremely dangerous.

## Accessories

■ Accessory parts may only be fitted when expressly approved by Miele. If other parts are used, guarantee, performance and product liability claims will be invalidated.





## Disposal of your old machine

■ Before discarding an old machine, switch it off at the wall socket and unplug it. Render the plug useless. Cut off the cable directly behind the appliance to prevent misuse. This should be done by a competent person.

■ The manufacturer cannot be held liable for damage caused by non-compliance with these Warning and Safety instructions.



## Special programmes

- Programme for hand-washable fabrics (Silks )  
Hand-washable fabrics which crease easily but do not contain wool can be washed in the *Silks*  programme (30°C temperature only).
- Programme for hand-washable fabrics (Woollens )  
Hand-washable or machine-washable wool or wool blend fabrics can be washed in the *Woollens*  programme. If the garment care label does not specify a temperature, wash using the cold setting.
- Programme for small loads (Quick wash)  
This is a *Cottons* programme for very lightly soiled fabrics.
- Programme for mixed fabrics (Mixed wash)  
Suitable for small loads of garments made from man-made fibres and cotton garments which can be washed together. Sort according to colour.
- Rinse programme (Separate rinse)  
Articles are only rinsed and spun in the machine.

## Delicates and Silks programmes

In these programmes the laundry is washed and spun very gently to reduce creasing and the amount of ironing required, thus providing "Easy care" for your laundry.

## Water plus system

The water level for washing and rinsing is increased. For *Cottons* programmes an additional rinse can also be selected.

# Description of the appliance

---

## Future updates (PC)

The indicator or check light marked PC allows a service engineer to update your machine in future years.

When, for example, new programmes are developed or new fabrics are introduced, a service engineer will be able to modify existing programme cycles accordingly.

Miele will provide information when such possibilities become available.

## Control panel

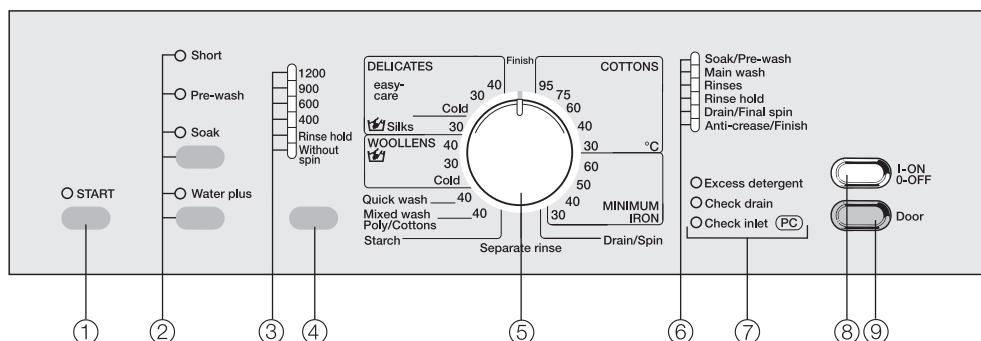

### ① **Start button**

starts the wash programme

### ② **Additional option buttons**

Additional options can be added to the basic programme.

Use the top button to select either the *Short*, the *Pre-wash* or the *Soak* option. Use the lower button to select the *Water plus* option.

Indicator light on = option selected

Indicator light off = option not selected

### ③ **Indicator lights**

for spin speeds, Rinse hold or Without spin

### ④ **Spin button**

for selecting the final spin speed, Rinse hold or Without spin

### ⑤ **Programme selector**

for selecting the wash programme and temperature for that programme.

The programme selector can be turned clockwise or anti-clockwise.

### ⑥ **Programme sequence indicator lights**

show which section of the wash programme has been reached.

### ⑦ **Check lights**

### ⑧ **I-On/O-Off button**

for switching the machine on or off or interrupting a programme

### ⑨ **Door button**

opens the machine door

# Description of the appliance

---

## Important control panel features

### Programme selector

The programme selector is used to set the basic wash programme and the temperature for that programme.

### Additional option buttons

Additional options can be added to the basic programme.

Use the top button to select either the *Short*, the *Pre-wash* or the *Soak* option.

Use the lower button to select the *Water plus* option.

The indicator light will come on to show that the additional option has been selected.

If an additional option is chosen, which is incompatible with the basic programme, it cannot be selected.

### "Spin" button with indicator lights

The maximum spin speed which can be selected depends on the basic programme chosen.

Maximum spin speed	Basic programme
1200	Cottons, Quick wash, Drain/spin, Starch
1200	Woollens, Separate rinse
900	Minimum iron, Mixed wash
600	Delicates
400	Silks

### Select the spin speed.

Press the "Spin" button to select a different spin speed. However, you cannot select a spin speed higher than the maximum allowed for the basic wash programme chosen.

The indicator lights show the speed selected.

### You can also omit the final spin

■ Press the "Spin" button to reach:

– Rinse hold

The laundry is not spun and remains suspended in the final rinse water. This reduces creasing if the laundry is not going to be removed from the drum immediately after the end of the programme.

To continue the programme select a spin speed. When the programme is finished the *Anti-crease/Finish* light will come on. Turn the programme selector to the *Finish* position and press the *door* button to open the door and remove the laundry.

– Without spin

The laundry is not spun after the final rinse. After the water has been drained away the machine goes straight into the anti-crease stage. Spinning between the rinses is also omitted in this setting (rinse and interim spin).

Before using the machine for the first time ensure that it is correctly installed and connected. See the relevant section under "Installation". Also check that the fluff filter is securely tightened. Otherwise there is a risk of water leakage during use.

For safety reasons spinning is not possible until the machine has been prepared for using for the first time. To activate the spinning function you must run a wash programme without laundry and without detergent.

Using detergent could result in an excessive build-up of foam.

This also activates the ball valve. The ball valve prevents detergent escaping from the suds container into the sump during a wash programme, thus making maximum use of the detergent.

- Turn on the stopcock.
- Press the *I-On/O-Off* button in.
- Turn the programme selector to *Cottons 40°C*.
- Press the "Spin" button repeatedly to select *Without spin*.
- Press *Start*.

When this programme has finished turn the programme selector to *Finish*. Your washing machine is ready for using for the first time.

## Washing environmentally and economically

---

- Water consumption and energy usage are determined by the size of the load. Load to the maximum recommended for the programme selected.
- To save energy wash normally and lightly soiled laundry at lower temperatures. The 95°C Cottons programme is probably only needed in exceptional circumstances, e.g. for oil based stains or where a very hot wash is required.
- Use the *Mixed wash* or the *Quick wash* programme for smaller amounts of laundry.
- A main wash (programme without pre-wash) is sufficient for cleaning normally soiled laundry.
- By using the additional option *Soak* for heavily soiled laundry you can select a lower temperature in the main wash.
- Use the additional option *Soak* instead of *Pre-wash* with heavily soiled laundry.  
If *Soak* is followed immediately by a main wash the same suds are used.
- Use the *Short* wash option for normally or very lightly soiled laundry.
- Do not exceed the amount of detergent recommended by the manufacturer on the packaging.
- Reduce the amounts of detergent with smaller loads, (e.g. with a half load, approx. one third less detergent).
- Select the highest suitable spin speed in the wash programme when tumble drying afterwards.
- Load recognition and automatic rinsing can cause the duration of a programme to vary greatly. The main wash may be shortened and a rinse cycle omitted depending on the amount of laundry.

## Brief instructions

### Please note:

To help familiarise yourself with how to use your washing machine please read the sections "Before washing", "Selecting a programme" and "At the end of a programme" in detail.

- 1 Sort the laundry into colours and fabric types

### Selecting a programme:

- 2 Switch on the washing machine
- 3 Open the drum door
- 4 Load the drum
- 5 Close the drum door
- 6 Select a programme
- 7 Select a spin speed
- 8 Select any additional option required
- 9 Add detergent
- 10 Press the *Start* button













### At the end of a programme:

- 11 Open the drum door
- 12 Remove the laundry
- 13 Switch off the washing machine
- 14 Turn the programme selector to the *Finish* position
- 15 Close the drum door

See the "Programme chart" in the next section for information on which programmes to use for different fabric types.









# How to wash correctly

## Programme chart



<b>Cottons</b>     	
Fabric	Cottons and linen fabrics, e.g. bed linen, table linen, towelling, jeans, underwear, T-shirts, nappies.
Additional options	Short, Pre-wash, Soak, Water plus
Notes	<ul style="list-style-type: none"> <li>– Only use the <i>Cottons 95°C</i> programme for heavily soiled and incontinent laundry.</li> <li>– For heavily soiled laundry and/or soiling which has been left unwashed for some time, select the <i>Soak</i> additional option.</li> <li>– For laundry with large amounts of dirt (e.g. dust, sand) use the <i>Pre-wash</i> additional option.</li> <li>– For lightly soiled laundry select the <i>Short</i> additional option.</li> <li>– For dark coloured fabrics use a detergent for coloured fabrics, or liquid detergent.</li> </ul>
Detergent	Powder detergent, detergent for coloured fabrics, liquid detergent, tablet detergent and liquid tab detergent. See also "Detergent" section.
Max. load	5 kg
<u>Note for test institutes:</u> Programme setting for testing according to EN 60456 standard: <b>Cottons 60°C</b>	
<b>Minimum iron</b>       	
Fabric	For garments made of synthetic fibres, mixed fibres and for easy care cotton shirts and blouses.
Additional options	Short, Pre-wash, Soak, Water plus
Notes	<ul style="list-style-type: none"> <li>– For heavily soiled laundry and/or soiling which has been left unwashed for some time, select the <i>Soak</i> additional option.</li> </ul>
Detergent	Powder detergent, detergent for coloured fabrics, liquid detergent, detergent for delicates. See also "Detergent" section.
Max. load	2.5 kg









## How to wash correctly

<b>Delicates</b>   	
Fabric	For delicate garments made of synthetic fibres, mixed fibres and for easy care cotton shirts and blouses. Curtains, including net curtains, specified as machine-washable by the manufacturer.
Additional options	Short, Pre-wash, Soak
Notes	<ul style="list-style-type: none"> <li>– Laundry remains relatively crease-free for easier ironing.</li> <li>– Dust in curtains usually makes using a programme with <i>Pre-wash advisable</i>.</li> <li>– For curtains made from delicate fabrics, reduce the spin speed or select Without spin.</li> </ul>
Detergent	Liquid detergent for delicates. See also "Detergent" section.
Max. load	1 kg
<b>Silks</b>  	
Fabric	Hand-washable fabrics with no wool content, e.g. satin, lace and silk.
Additional options	Water plus
Notes	<ul style="list-style-type: none"> <li>– Laundry remains relatively crease-free for easier ironing.</li> <li>– Place socks, tights, bras etc. in a washing bag.</li> </ul>
Detergent	Liquid detergent for delicates. See also "Detergent" section.
Max. load	1 kg
<b>Woollens</b>    + cold	
Fabric	Machine-washable or hand-washable wool or wool blend fabrics. Please note that hand-washable garments will not shrink, stretch, matt or felt beyond the accepted tolerance of the item. If the care label does not specify a temperature wash using the cold setting.
Detergent	Liquid detergent for machine washable woollens. See also "Detergent" section.
Max. load	2 kg



# How to wash correctly

<b>Quick wash </b>	
Fabric	Very lightly soiled fabrics, which can be washed in the Cottons programme.
Additional option	Water plus
Notes	<ul style="list-style-type: none"> <li>– Add less detergent (half load).</li> <li>– If fabrics have a high proportion of man-made fibres it is advisable to programme the machine for "Gentle Action". See "Programmable functions". Note that this programme is not suitable for delicate items.</li> </ul>
Detergent	Powder detergent, detergent for coloured fabrics, liquid detergent.
max. load	2.5 kg
<b>Mixed wash  </b>	
Fabric	Small loads of garments made from man-made fibres and cotton garments which can be washed together. Sort according to colour.
Additional options	Short, Pre-wash, Soak, Water plus
Notes	If fabrics have a high proportion of man-made fibres it is advisable to programme the machine for "Gentle Action". See "Programmable functions".
Detergent	Powder detergent, detergent for coloured fabrics, liquid detergent.
max. load	3 kg
<b>Starch</b>	
Fabric	Table cloths, napkins, overalls, uniforms.
Notes	– The laundry should be washed but not treated with fabric conditioner. Use liquid starch.
max. load	5 kg
<b>Separate rinse</b>	
Fabric	Articles which have been washed by hand and only need to be rinsed and spun in the machine. Do not use for woollens.
max. load	5 kg
<b>Drain/Final spin</b>	
Notes	<ul style="list-style-type: none"> <li>– To drain only: select <i>Without spin</i>.</li> <li>– Do not use for woollens.</li> </ul>
max. load	5 kg





## Important - other care symbols

	Hand wash (If no temperature is specified use the lowest temperature or cold)
	Do not wash
	Dry clean
	Do not dry clean
	Suitable for chlorine bleaching
	Do not use chlorine bleach





## Tumble dry

	At normal temperature
	At low temperature
	Do not tumble dry

## Ironing

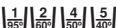
	Hot iron
	Medium hot iron
	Cool iron
	Do not iron

N.B. If you have any textiles with the older wash care labels, select a programme according to the label below:

	Cottons
	Minimum iron
	Delicates
	Woollens

# How to wash correctly

## Before washing

### 1 Sort the laundry

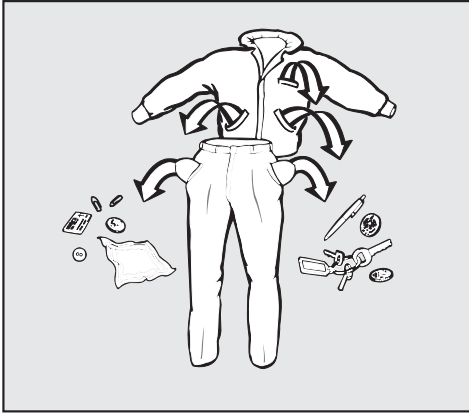

- Empty all pockets.

⚠ Foreign objects (e.g. nails, coins, paper clips, etc.) can cause damage to garments and components in the machine.

- Badly soiled areas, e.g. collars and cuffs, and water soluble stains can be pre-treated with bar soap, liquid detergent or detergent mixed into a solution or paste.

With particularly stubborn stains ask your dry cleaner for advice.

⚠ Do not use solvent-based cleaning agents in this machine.

- Sort the laundry by colour and by care label symbol. Most garments have a textile care label in the collar or side seam.

Dark textiles often contain excess dye and should be washed separately several times before being washed together with other garments. Always wash whites and coloureds separately.

Delicate textiles should be washed separately in a delicates programme (use a washing bag where appropriate).

- Curtains:  
Remove lead weights and strips or place in a laundry bag.
- Underwiring and collar stiffeners:  
Any loose wiring in bras, shirt collar stiffeners, etc. should be removed or sewn in.
- Knitted garments, trousers and jeans, T-shirts and sweat shirts:  
Turn inside out, if recommended by the manufacturer.
- Close any zips, fasten hooks and eyes etc before washing.
- Fasten duvet covers to prevent smaller items rolling up inside them.

⚠ Do not wash any items in this machine which are specified by the manufacturer as **not washable** on the care label. (☒ symbol)

# How to wash correctly

## Selecting a programme

### 2 Switch on the washing machine

- Press in the *I-On/0-Off* button.

### 3 Open the drum door

- Press the *Door* button and open the drum door.

### 4 Load the drum

- Unfold the laundry and load loosely in the drum. To achieve best results it is advisable to make up mixed loads consisting of both large and small items. This improves the washing effect and helps distribute the load evenly to keep the machine stable and reduce the noise level during spinning.

To save energy and water try to load the maximum amount for the programme selected. However, be careful not to overload the machine. Overloading reduces the wash result and causes more creasing.

### 5 Close the drum door with a gentle swing.

Make sure that no garments are caught between the drum door and seal.

### 6 Select a programme

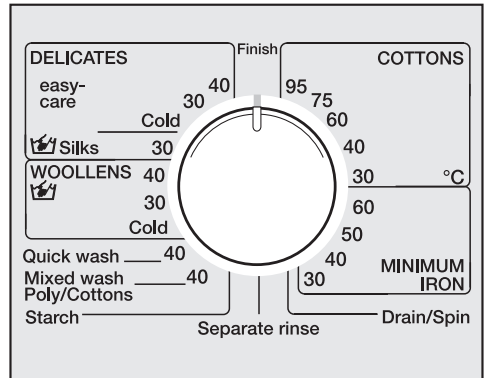

- Turn the programme selector to the required programme.

### 7 Select a spin speed

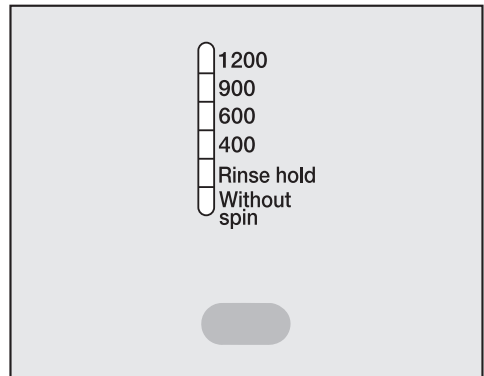

- Press the "Spin" button repeatedly until the indicator light for the spin speed you want comes on.

In some programmes the maximum spin speed is limited. The machine will not allow a higher spin speed to be selected.

# How to wash correctly

## Additional options

### ⑧ Select additional option(s) if required.

Additional options can be selected as long as they are compatible with the basic programme being used.

Each press of the top button selects the additional option in the following order: *Short*, *Pre-wash*, *Soak*, no selection.

Use the lower button to select or deselect the *Water plus* option

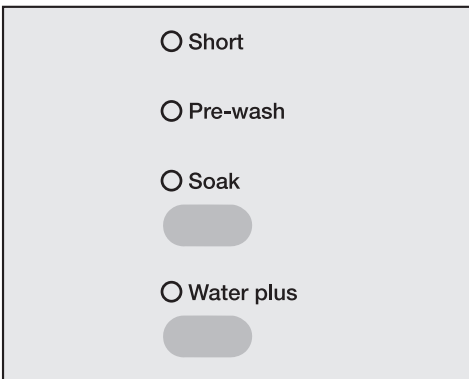

- Press the appropriate additional option button. Press the top button repeatedly until the indicator light for the additional option you want comes on.

## Short

For lightly soiled items.

## Pre-wash

For heavily soiled laundry and items with dried on stains.

## Soak

For heavily soiled and stained items with protein stains (e.g. blood, fats and oils, cocoa).

- A length of time of between 30 minutes and 2 hours can be programmed in 30 minute increments for the soak process.
- The machine is set ex-works with a soak period of 2 hours.

To programme in a different soak period see "Programmable functions - Soak".

## Water plus

If you want to increase the water level for a wash process you can choose one of the four options for the *Water plus* button. The options are explained in the section on "Programmable functions - Water plus system".

The machine is set at the factory so that the water level in the main wash and rinses will be increased if the *Water plus* button is pressed.

# How to wash correctly

## 9 Add detergent

It is important to dispense the correct amount, because . . .

. . . too little results in the following:



- Laundry will not be properly clean and will in time become grey and hard to the touch.
- Greasy particles cling to the laundry.
- Limescale deposits on the heater elements.

. . . too much results in the following:

- Excessive foam which causes a low level of agitation and poor wash, rinse and spin results.
- High water consumption (an additional rinse cycle will automatically switch in).
- A burden to the environment.

## Liquid detergent

Liquid detergent should be dispensed using a ball provided by the manufacturer for programmes without a pre-wash.

For programmes with a pre-wash you will need to purchase a special container from the Miele Spare Parts department which sits in the main wash compartment  of the detergent dispenser drawer. Add liquid detergent to this container for the main wash and to compartment  for the pre-wash.



- Pull out the detergent drawer and place detergent in the compartments as follows:

 = Detergent for Pre-wash (if selecting Pre-wash, add  $\frac{1}{4}$  of the total amount recommended). This compartment is also used for starch formulations when starching separately.

 = Detergent for the main wash including Soak

 = Fabric conditioner or liquid starch.

- Close the detergent drawer.

See section on "Detergent" for further information on detergent and the amount to dispense.

## 10 Press the **Start** button.

This starts the programme.

# How to wash correctly

## At the end of a programme

When the *Anti-crease/Finish* indicator light comes on the laundry can be removed from the drum. (This light stays on at the end of the programme and remains on until the selector is turned back to the *Finish* position).

### 11 Open the drum door

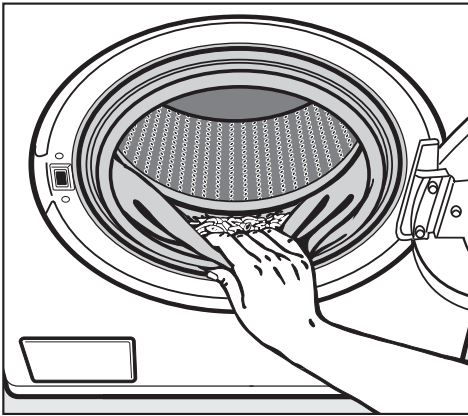

- Press the *Door* button.

### 12 Remove the laundry.

 Only remove laundry from the machine once the drum has stopped turning. Reaching into a moving drum is extremely dangerous and could result in injury.

- Check the folds in the door seal for any small articles, e.g. buttons which may be lodged there.

Check that all items have been removed from the drum. Items left in the drum could discolour other items in the next wash or become discoloured themselves.

### 13 Switch off the washing machine.

- Press and release the *I-On/O-Off* button and turn the programme selector to *Finish*. The *Anti-crease/Finish* light will then go out.

### 14 Close the drum door

Otherwise there is the danger of objects being placed inadvertently in the drum. If these remained unnoticed and were washed in the next load, they could damage the laundry.



### **Adding or removing laundry after a programme has started**

Laundry can be added or removed after the programme has started when using the following programmes:

- Cottons
  - Minimum iron
  - Quick wash
  - Mixed wash
  - Starch
- Press the *Door* button in and hold it until the door springs open.
  - Add or remove items.
  - Close the door.

The programme will continue automatically.

### **The door cannot be opened, if:**

- the suds temperature is above **55°C**.
- the water is above a certain level.
- the programme has reached the *Final spin* stage.

# How to wash correctly

---

## Interrupting a programme

- Switch the washing machine off with the *I-On/0-Off* button.

To continue with the same programme:

- Switch the washing machine back on again with the *I-On/0-Off* button.

## Altering a programme once selected

The machine will accept the following changes after a programme has started:

- at any time after the start, the spin speed can be changed within the limits for the programme.
- up to 6 minutes after the start, the *Water plus* additional option can be selected or de-selected and a different temperature can be selected for the programme in use.

After the start of a programme it is no longer possible to select a different programme.

If the programme selector is moved, the indicator light *Anti-crease/Finish* will start flashing. However, the programme sequence remains unaffected. The indicator light will go out again when the programme selector is moved back to the programme previously chosen.

## Skipping a programme stage

- Turn the programme selector to *Finish*.

As soon as the programme sequence indicator light for the programme stage you want the programme to continue at starts flashing:

- Turn the programme selector back again to the appropriate programme within 4 seconds.

## To cancel or select a different programme

- Switch the washing machine off with the *I-On/0-Off* button.
- Turn the programme selector to *Finish*.

The programme has now been cancelled.

- Switch the washing machine back on with the *I-On/0-Off* button.
- Select a different programme.
- Press the *Start* button.

## Programme sequence

This washing machine has fully electronic controls with automatic load recognition. This machine takes in the right amount of water required for the programme depending on the amount of laundry and its absorbency rate. This means that programme cycles and durations shown in the display can vary.

The programme sequences outlined below are based on the basic programme with a full load. Additional options which can be selected have not been taken into account.

The programme sequence indicator lights show the stage the programme has reached.

### Cottons

#### Main wash

Water level: low

Wash rhythm: normal

#### Rinses

Water level: medium

No of rinses: 2 or 3<sup>1)</sup>

#### Spinning

Rinse and interim spin<sup>2)</sup>: yes

Final spin: yes

### Minimum iron

#### Main wash

Water level: low

Wash rhythm: normal

#### Rinses

Water level: high

No of rinses: 2 or 3<sup>1)</sup>

#### Spinning

Rinse and interim spin<sup>2)</sup>: yes

Final spin: yes

### Delicates

#### Main wash

Water level: high

Wash rhythm: Gentle action

#### Rinses

Water level: high

No of rinses: 3

#### Spinning

Rinse and interim spin: no

Final spin: yes

### Silks

#### Main wash

Water level: medium

Wash rhythm: Silks

#### Rinses

Water level: medium

No of rinses: 2

#### Spinning

Rinse and interim spin: no

Final spin: yes

# How to wash correctly

## Woollens

### Main wash

Water level: medium

Wash rhythm: Woollens

### Rinses

Water level: medium

No of rinses: 2

### Spinning

Rinse and interim spin<sup>2)</sup>: yes

Final spin: yes

## Quick wash

### Main wash

Water level: low

Wash rhythm: normal

### Rinses

Water level: medium

No of rinses: 2

### Spinning

Rinse and interim spin<sup>2)</sup>: yes

Final spin: yes

## Mixed wash

### Main wash

Water level: low

Wash rhythm: normal

### Rinses

Water level: high

No of rinses: 2

### Spinning

Rinse and interim spin<sup>2)</sup>: yes

Final spin: yes

## Starch

Water level: low

Wash rhythm: normal

Final spin: yes

## Separate rinse

Water level: high

No of rinses: 2

Final spin: yes

## Special features in the programme sequences:

### Anti-crease:

At the end of every programme, with the exception of the *Woollens* programme, the anti-crease action switches on for a maximum of 30 minutes. The door can be opened and laundry removed at any time during the anti-crease phase.

<sup>1)</sup> A third rinse takes place automatically if:

- there is too much foam in the drum
- a spin speed of lower than 700 rpm has been selected.
- *Without spin* has been selected

<sup>2)</sup> Rinse and interim spin:

There is a spin between the rinses.

Omitting rinse and interim spin:

Select *Without spin* on the spin speed display.

All modern detergents produced for automatic washing machines are suitable, including liquid, compact (concentrated), tablets, liquid tablets and special application detergents. Use dispensing aids, e.g. balls, if these are supplied with the detergent. Tablets are suitable for full loads but note that it may be impractical to reduce tablets by proportion to suit smaller loads! Woollens and knitwear containing wool mixtures and hand-washable garments should be washed using a detergent specifically designed for washing woollens.

Silk should be washed using a liquid detergent specifically designed for washing woollens. Do not use biological detergents on silk as the enzymes may damage the silk! Instructions for use and recommended amounts for a full load are given on the detergent packaging.

- Add detergent to the compartments as follows:

 = Detergent for pre-wash (if selecting a pre-wash add  $\frac{1}{4}$  of the total amount recommended). This compartment is also used for starch formulations when starching separately.

 = Detergent for the main wash including Soak.

 = Fabric conditioner or liquid starch.

### The right amount to dispense will depend on the following:

- The quantity of laundry.

- The soiling level of the laundry.

#### Lightly soiled

No visible dirt or stains. Possibly slight body odour.

#### Normally soiled

Visibly dirty and/or just a few slight stains.

#### Heavily soiled

Stains and soiling clearly visible.

- The water hardness level.

Check with your local water supplier if you do not know the water hardness level in your area.

## Water softeners

A water softener can be used to cut down on the use of detergents in extremely hard water areas. Dispense according to the amount specified on the packaging. First add detergent and then the water softener.

Use a quantity of detergent as for soft water.

Miele do not recommend connecting the machine to a household water softener.

## Washing with several components

If you wash using several components (e.g. special application detergents), we recommend always dispensing the agents into compartment  in the following order:

1. Detergent
  2. Water softener
  3. Stain remover
- This way the agents are distributed more efficiently.

# Detergent

## Fabric conditioners and liquid starch

Fabric conditioners make garments soft and fluffy to handle and help prevent static cling when tumble drying.

Starch stiffens and gives body to items of laundry, e.g. shirts, tablecloths and bed linen.

- Dispense according to the amount specified on the packaging.

## Automatic dispensing of fabric conditioner or liquid starch to laundry at the end of a programme



- Add the fabric conditioner or liquid starch to compartment ☼. **Do not exceed the maximum level mark.**

The conditioner or liquid starch is automatically dispensed in the last rinse. At the end of the programme a small amount of water remains in the fabric conditioner compartment ☼.

If starching frequently, the dispenser compartment and especially the siphon tube and conditioner channel will need regular cleaning to remove any residual starch. See "Cleaning the detergent dispenser drawer". Do not add starch formulations or viscous liquid starch to the ☼ compartment as it will clog it up. See "Adding starch separately".

## Adding fabric conditioner separately

- Add fabric conditioner to compartment ☼.
- Turn the programme selector to *Starch*.
- Select a spin speed.
- Press the *Start* button.

## Adding starch separately

Use the separate *Starch* programme when using starch formulations or viscous liquid starch.

- Prepare and measure the starch in accordance with the manufacturer's instructions.
- Add starch to compartment ▮.
- Turn the programme selector to *Starch*.
- Select a spin speed.
- Press the *Start* button.

## Colour run and dye removers/dyes

- Do not use colour run or dye removers in this washing machine.
- Dyes suitable for use in domestic washing machines can be used. However, please note that the salt used in the dyeing process can cause corrosion to stainless steel components in the machine if you dye frequently. Always observe the manufacturer's instructions carefully.

 Disconnect the appliance from the mains electricity supply and withdraw the plug from the socket prior to cleaning the machine.

- Clean the casing with a mild non-abrasive detergent or soap and water. Wipe dry with a soft cloth.
- Clean the fascia panel with a damp cloth and wipe dry with a soft cloth.
- The drum can be cleaned using a suitable proprietary stainless-steel cleaning agent.

 Do not use solvents, abrasive cleaners, glass cleaners or all-purpose cleaning agents. These might damage plastic surfaces and other components because of the chemicals they contain. The washing machine must not be hosed down.

### Extra cleaning

Carry out a hot wash (70°C or above) with powder detergent approx. every 6 weeks to help prevent deposits building up in the machine. These can occur when washing is mainly done at low temperatures, and also lead to unpleasant smells. If you have no reason to wash occasionally at this high temperature, then run a Cottons 95°C programme with detergent but no laundry at regular intervals.

### E-Cloth

A microfibre "E-Cloth" is available from the Miele UK Spare Parts Department, Part number 98013530, which is suitable for cleaning surfaces such as stainless steel, glass, plastic and chrome without the use of chemicals. It can be washed 300 times.

# Cleaning and care

## Cleaning the detergent dispenser drawer

Remove detergent residues regularly.

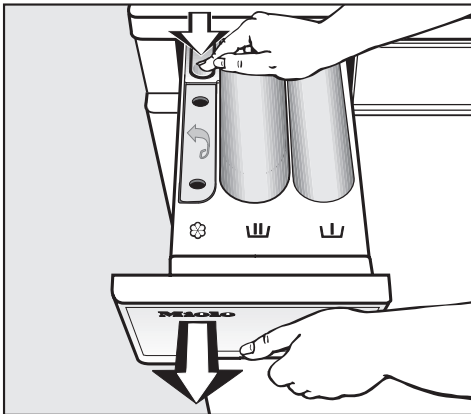

- Pull out the detergent dispenser drawer until a resistance is felt. Press down the release catch and at the same time pull the drawer right out of the machine.
- Clean the detergent drawer with warm water.

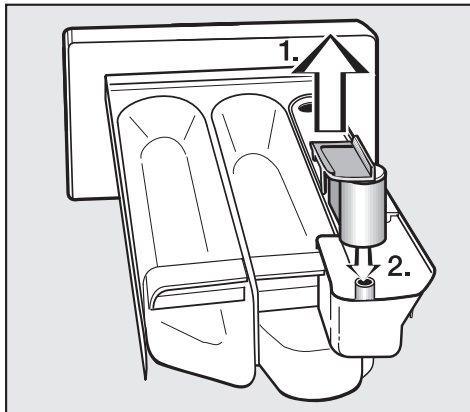

- Clean the siphon.
  1. Remove the siphon from compartment ⌘. Wash under running warm water. Clean the siphon tube in the same way.
  2. Replace the siphon.

Over time, detergent residue can build up in the water jets in the top of the detergent drawer housing.

- Before replacing the detergent drawer, use a bottle brush or similar to clean them out.



## Cleaning the fluff (drain) filter and pump

Check the fluff filter initially after 3-4 washes to ascertain how often it is likely to require cleaning.

With normal cleaning approx. 2 litres of water run out.

If the drain outlet is blocked, up to 25 litres of water will be retained in the machine.

**⚠ Caution:** if laundry has been washed at a high temperature, water draining out of the machine will still be hot. Danger of scalding!

There is a filter flap opener located behind the detergent drawer fascia panel (see illustration).

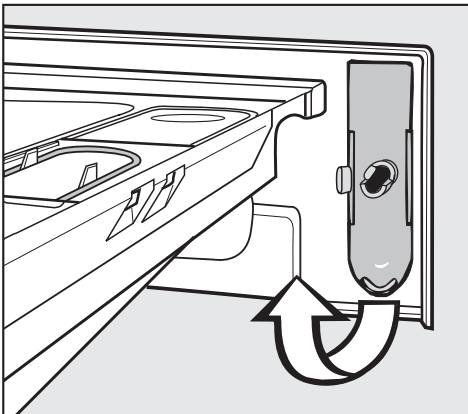

- Remove the opener.

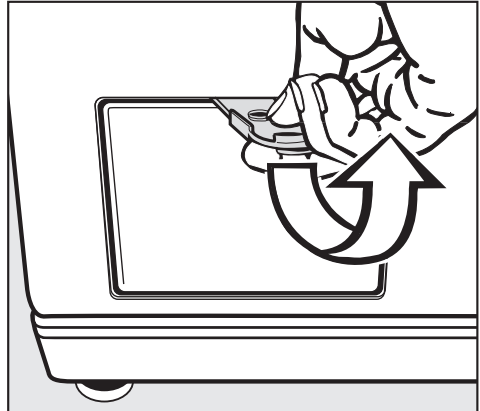

- Use it to open the access flap.

## Procedure for draining the machine

- Place a suitable container under the access flap.

When draining water from the machine, do **not** unscrew the fluff filter completely or take it right out.



- Unscrew the fluff filter lid until water runs out.

To stop the flow of water:

- Tighten the fluff filter back up again.

## Cleaning and care

Once the flow of water ceases:

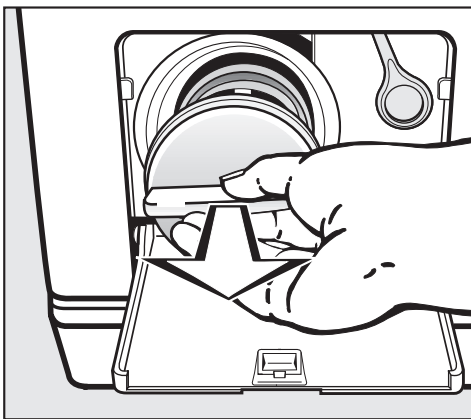

- Remove the fluff filter completely.
- Clean the fluff filter thoroughly.

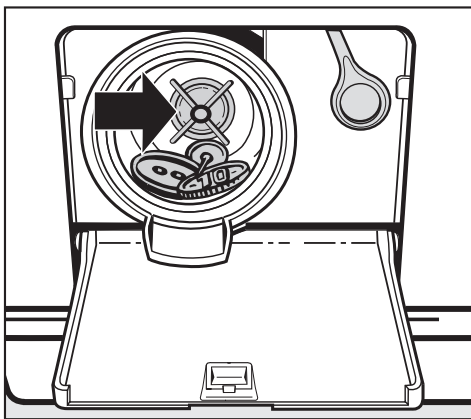

- Remove any foreign objects (e.g. buttons, coins, etc) and fluff. Turn the impeller by hand to check that it is free to rotate. Any foreign object causing an obstruction should be removed.

- Clean the inside of the fluff filter housing. Remove any deposits of limescale and detergent or foreign objects from the thread of the filter housing and filter unit (as these objects can cause a leakage of water). Deposits of limescale are often a sign of underdosage of powder.
- Put the fluff filter back in place and secure.

 Make sure the fluff filter is securely tightened. Otherwise there is a risk of water leakage during use.

### After cleaning

- Pour approx. 2 litres of water into the detergent dispenser compartment  to reactivate the ball valve.

## Cleaning the water inlet filters

The washing machine has two filters to protect the inlet valves.

These filters should be checked every six months or so, or more often if there are frequent interruptions to the water supply.

### To clean the filter in the union in the open end of the inlet hose:

- First turn off the stopcock.
- Unscrew the threaded union connecting the free end of the inlet hose to the stopcock.

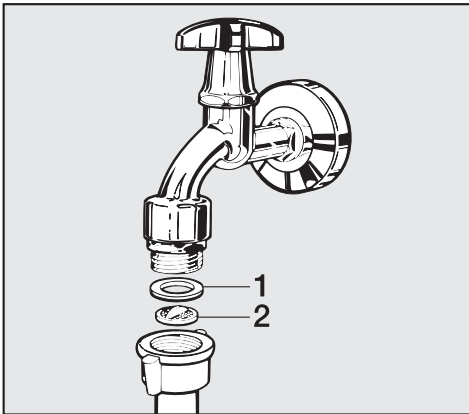

- Remove the rubber seal **1** from the recess.
- Using pointed pliers, take hold of the plastic filter bar **2**, remove the filter and clean.
- Put the filter and seal back in the reverse order and reconnect the hose.
- Turn on the stopcock and check the connection is watertight. If it leaks, tighten the connection.

### To clean the filter in the water inlet valve

- Using pliers, carefully loosen the ribbed plastic nut on the inlet valve and unscrew.

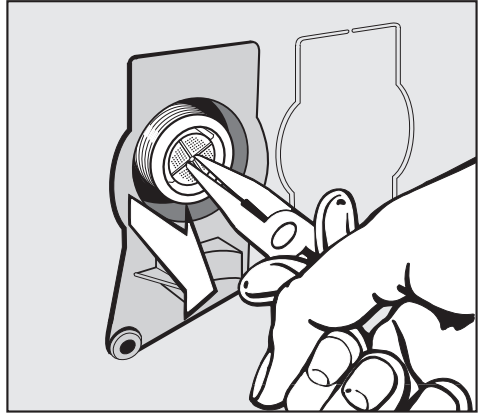

- Use water pump pliers to withdraw the plastic filter by the bar (see illustration). Clean, put back and secure.

The two filters **must** be put back in place after cleaning.

# Problem solving guide

---

With the help of the following notes minor faults in the performance of the appliance, some of which may result from incorrect operation, can be put right without contacting the Service Department.

 Repair work to electrical appliances should only be carried out by a suitably qualified person in accordance with local and national safety regulations. Unauthorised repairs could be dangerous.

## The chart is divided into the following sections to help you:

- The programme does not start.
- The wash programme stops and a fault indicator light comes on.
- A fault indicator light comes on but the wash programme continues as normal.
- General problems or an unsatisfactory wash result.
- The drum door does not open when you press the Door button.

### The programme does not start.

<b>Fault indicator</b>	<b>Possible cause</b>	<b>Remedy</b>
<b>The <i>Anti-crease/Finish</i> indicator light is not on, or the <i>Start</i> indicator light is not flashing.</b>	There is no power.	Check that <ul style="list-style-type: none"><li>- the mains plug is plugged in.</li><li>- the fuse or circuit breaker has not tripped.</li></ul>
<b>The programme does not start when <i>Drain/Final spin</i> has been selected.</b>	The washing machine has not been prepared for using for the first time.	Prepare the machine as described in "Before using for the first time".

### The wash programme stops and a fault indicator light comes on.

Fault indicator	Possible cause	Remedy ❶
<b>The <i>Check drain</i> light flashes.</b>	The water outlet is blocked.	Clean the fluff (drain) filter and drain pump.
	The drain hose has been fixed too high.	The maximum drain height is 1 m.
<b>The <i>Check inlet</i> light flashes.</b>	The water inlet is blocked.	Open the stopcock.
	The filter in the water inlet hose is dirty.	Clean the filter.
<b>The <i>Check inlet</i> and <i>Check drain</i> lights flash.</b>	The water protection system has reacted.	Call the Service Department.
<b>The <i>Soak/Pre-wash</i> or <i>Rinses</i> indicator light flashes in the programme sequence.</b>	There is a fault.	Start the programme again. If the fault indicators occur again, contact the Service Department.

- ❶ To switch off the fault indicator: Switch off the machine with the *I-On/O-Off* button and turn the programme selector to *Finish*

## Problem solving guide

### A fault indicator light comes on but the wash programme continues as normal.

Fault indicator	Possible cause	Remedy ❶
The <i>Check drain</i> light flashes.	The drain outlet is restricted.	Clean the fluff (drain) filter and drain pump.
The <i>Check inlet</i> light flashes.	The water inlet is restricted.	Check whether <ul style="list-style-type: none"> <li>– the stopcock is opened wide enough.</li> <li>– the inlet hose is kinked.</li> </ul>
	The filter in the inlet hose is dirty.	Clean the filter.
The <i>Excess detergent check</i> light comes on.	Excessive foam has built up during washing.	Use less detergent next time and follow the recommendation on the packaging.
The <i>Main wash</i> indicator light flashes in the programme sequence display.	There is a fault.	Start the programme again. If the fault indicator occurs again, contact the Service Dept.
The <i>Anti-crease/Finish</i> indicator light flashes in the programme sequence display.	The position of the programme selector was altered after the start of the programme. Turn the programme selector back to the programme previously chosen.	

❶ To switch off the fault indicator: Switch off the machine with the *I-On/O-Off* button and turn the programme selector to *Finish*

### General problems or an unsatisfactory wash result

Problem	Possible cause	Remedy
<b>The machine shakes during the spin cycle.</b>	The four feet are not resting evenly on the floor.	Level the machine. See advice on installation.
<b>The laundry has not been spun satisfactorily.</b>	The spin speed selected was too low.	Select a higher spin speed next time.
<b>The pump makes strange noises.</b>	These do not indicate a fault. They occur at the end of a pump sequence as a normal part of the operation.	
<b>Large residues of detergent remain in the dispenser drawer.</b>	The water supply pressure is too low.	<ul style="list-style-type: none"> <li>– Clean the filter in the water inlet system.</li> <li>– It may be useful to press the <i>Water plus</i> button.</li> </ul>
	Washing powder used with water softener tends to become sticky.	Pour washing powder into the dispenser before adding any water softener.
<b>Fabric conditioner is not completely dispensed or too much water remains in the  compartment.</b>	The siphon is either incorrectly positioned or clogged.	Clean the siphon, see "Cleaning and care - Cleaning the detergent drawer".

## Problem solving guide

Problem	Possible cause	Remedy
<p><b>Liquid detergent does not give the required result.</b></p>	<p>Liquid detergents do not contain bleaching agents. They do not remove fruit, coffee and tea stains.</p>	<ul style="list-style-type: none"> <li>– Use a general purpose washing machine powder containing a bleaching agent.</li> <li>– Pour stain removers into compartment <b>III</b> of the dispenser drawer and liquid detergent into a dispenser ball.</li> <li>– Never put stain removers and liquid detergent together in the dispenser drawer.</li> </ul>
<p><b>Grey, greasy particles cling to washed laundry.</b></p>	<p>Insufficient amounts of detergent were used to break down the particles of grease in heavily soiled laundry.</p>	<ul style="list-style-type: none"> <li>– Add more detergent.</li> <li>– Before washing the next load run a <i>Cottons 95°C</i> programme with powder detergent but without a load. (See also "Extra cleaning" in Cleaning and Care).</li> </ul>
<p><b>There are white residues which look like powder detergent on dark coloured laundry.</b></p>	<p>The detergent contained compounds (zeolites) to aid water softening which are not soluble in water. These have ended up on the laundry.</p>	<ul style="list-style-type: none"> <li>– Try and brush off the residues with a soft brush once the laundry is dry.</li> <li>– Use a liquid detergent to wash dark coloured textiles. Liquid detergents usually contain no zeolites.</li> </ul>



## Problem solving guide

### The drum door does not open when you press the Door button.

Problem	Remedy
<b>The machine is not connected to the electricity supply.</b>	Put the plug in the socket and switch on.
<b>The washing machine is not switched on.</b>	Switch the machine on with the <i>I-On/O-Off</i> button.
<b>Power cut.</b>	Open the drum door as described in the section "Opening the door in the event of a power failure".
<b>The door was not correctly engaged.</b>	Press hard against the lock side of the drum door and then press the <i>Door</i> button.
<b>There is still water in the drum and the machine is unable to drain.</b>	Clean the fluff (drain) filter and the drain pump.
For safety reasons the drum door cannot be opened if the suds temperature is higher than 55°C.	

## Problem solving guide

### Opening the drum door in the event of a power failure

- Switch the washing machine off.

There is a lever behind the detergent drawer panel.

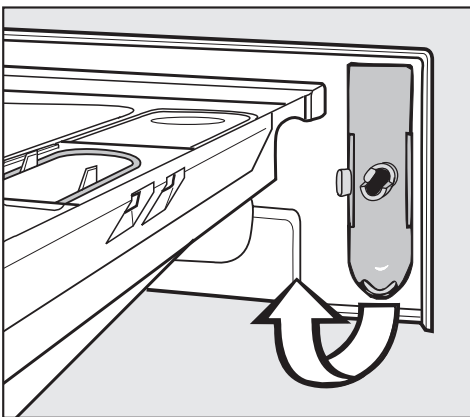

- Remove the lever.

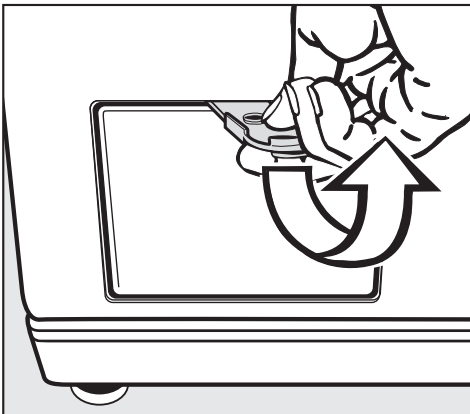

- Use it to open the access flap.

- Drain the water as described in the "Cleaning the fluff filter and pump" section of "Cleaning and care".

 Always make sure that the drum is stationary before reaching into the machine to remove laundry. Reaching into a moving drum is extremely dangerous.

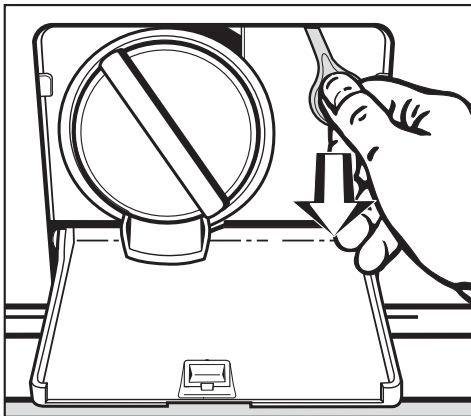

- Pull the emergency release downwards (see illustration). The drum door will open.

## Customer contact

In the event of any faults which you cannot remedy yourself please contact

- Your Miele dealer or
- Your nearest Miele Service Department (see back cover for the address).

When contacting the Service Department, please quote the model and serial number of your appliance, both of which are shown on the data plate visible at the top inside of the door above the porthole glass when the door is open.

Please note that telephone calls may be monitored and recorded to improve our service.

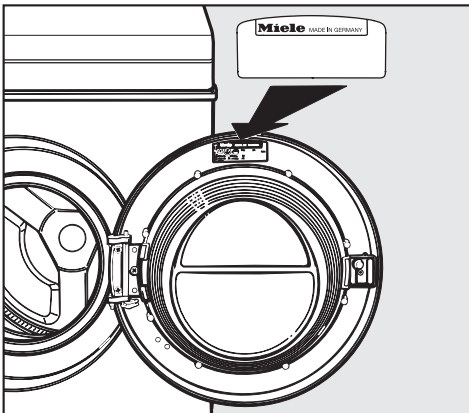

# Installation and connection

## Front view

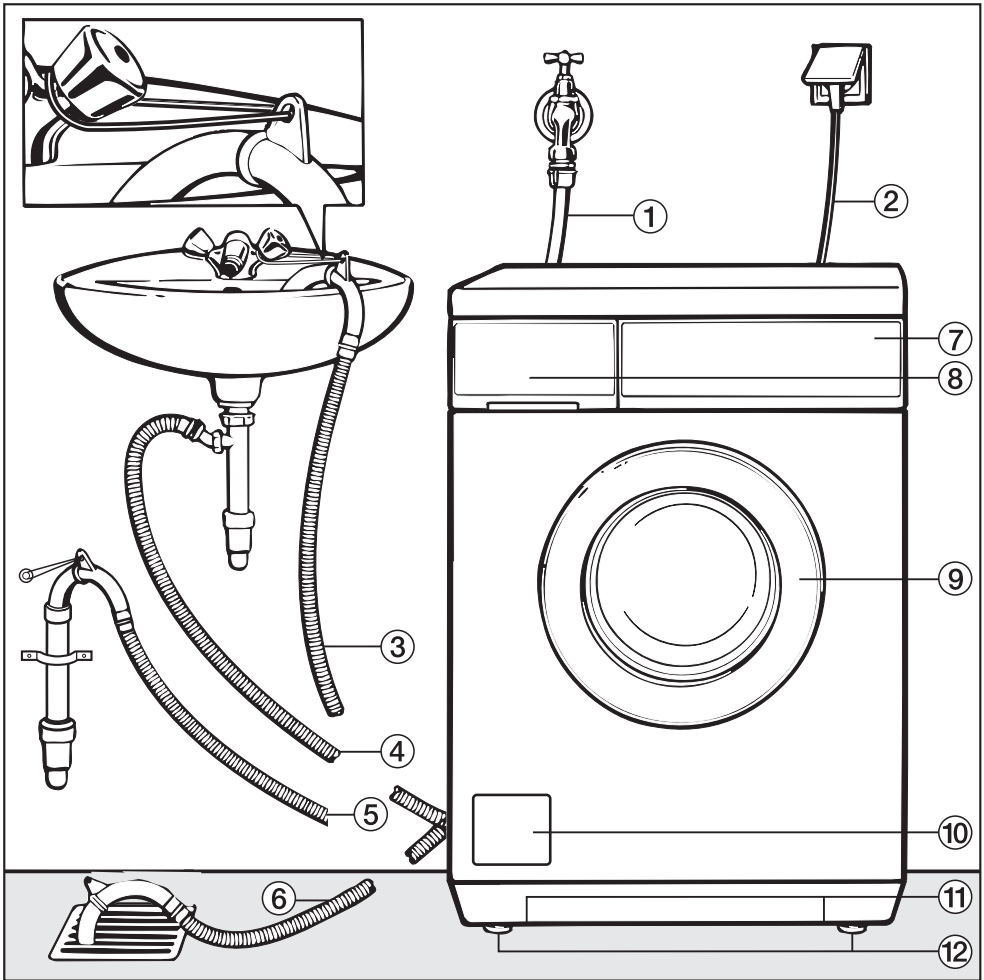

① Inlet hose (tested to withstand pressure of at least 7,000 kPa)

② Electricity supply cable

③ - ⑥ Flexible drain hose (with detachable swivel elbow)

⑦ Fascia panel with controls

⑧ Detergent dispenser drawer

⑨ Drum door

⑩ Flap for fluff filter, drain pump and emergency release

⑪ Handle recesses for moving the machine

⑫ Four height adjustable feet

## Rear view

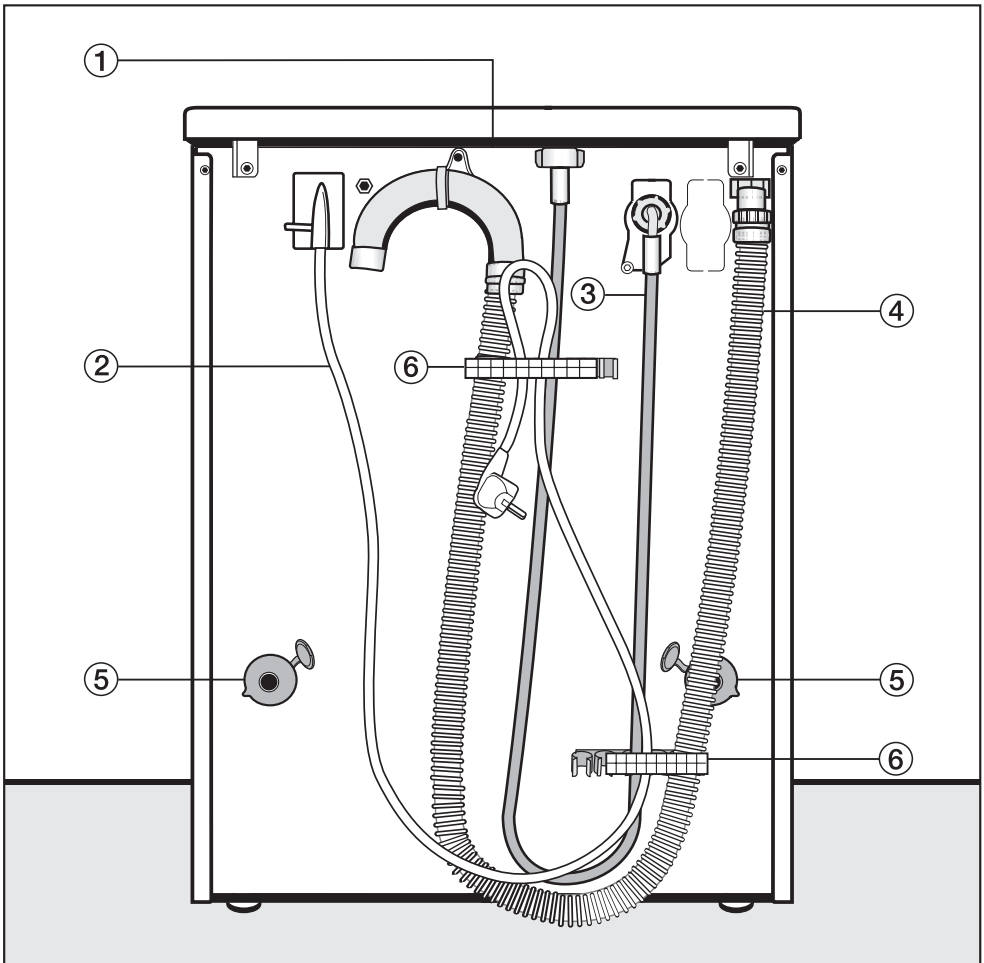

- ① Protruding lid edge for holding when moving the machine
- ② Electricity supply cable
- ③ Inlet hose (tested to withstand pressure of at least 7,000 kPa)
- ④ Drain hose
- ⑤ Transit bar covers
- ⑥ Restraining clip for:
  - Inlet hose
  - Drain hose
  - Electricity supply cable
  - Transit bars when removed

# Installation and connection

## Installation surface

A concrete floor is the most suitable installation surface for a washing machine, being far less prone to vibration during the spin cycle than wooden floorboards or a carpeted surface.

Please note the following points:

- The machine must be level and securely positioned.
- To avoid vibrations during spinning, the machine should not be installed on soft floor coverings.

If installing on a wooden joist floor:

- We recommend a plywood base (at least 59x52x3 cm). The base should span several joists and be bolted to the joists and not only to the floorboards. Check for the presence of pipes and cables.

If possible, install the machine in a corner, as this is usually the most stable part of the floor.

⚠ If the machine is installed on a raised plinth, it **has to be** secured against slippage during spin using retaining clips (available from the Miele Spare Parts Dept).

## Installing the washing machine

To manoeuvre the machine out of its packing case to its installation site hold it by the edge of the lid where it protrudes to the rear of the washing machine as well as by the handle recesses at the front.

Please note:

- Do not lift the machine by the drum door.

⚠ Ensure that the machine feet and the floor are dry to prevent the machine from slipping during the spin cycle.

## Removing the transit fittings

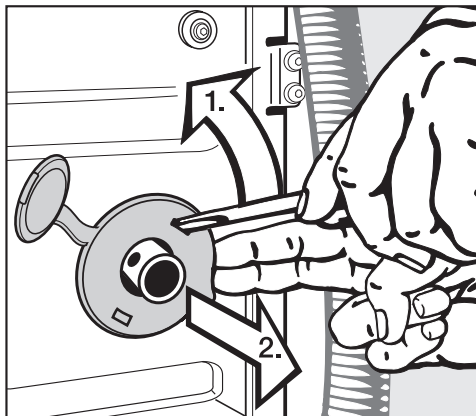

- To remove the left and right covers
  1. Use a screwdriver to prise out the cover as illustrated.
  2. Pull the cover forwards to remove.

## Installation and connection

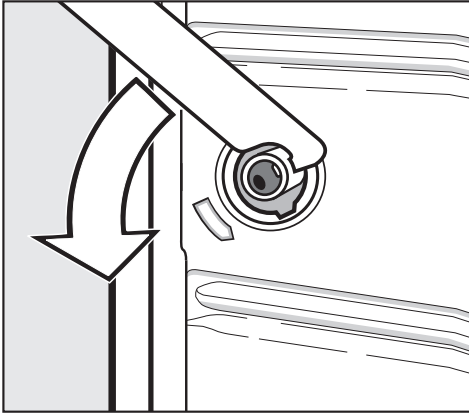

- Using the spanner supplied turn the left-hand transit bar 90°, then

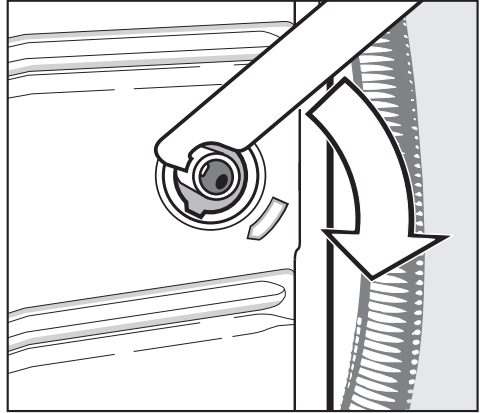

- Turn the right-hand transit bar 90°, then

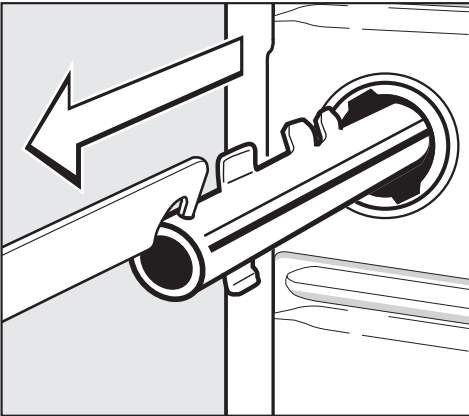

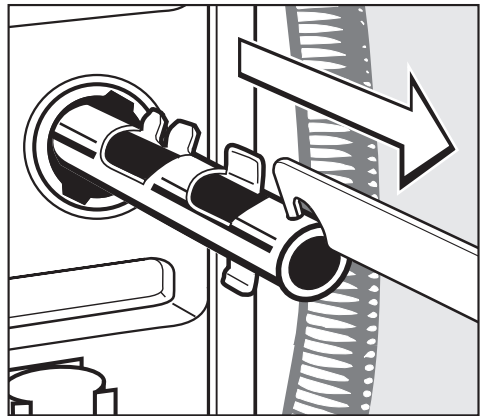

- withdraw the transit bar.

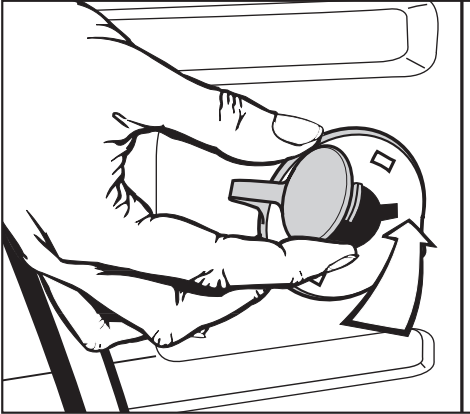

- withdraw the transit bar.

## Installation and connection



 The washing machine must not be moved without the transit bars in place. Store the transit bars as shown or keep them in a safe place for future use. They must be re-fitted if the machine is to be moved again (e.g. when moving house).

### Re-fitting the transit bars

Re-fitting is carried out by reversing the procedure.

- Fit the covers on to the two holes. Then plug the holes as shown with the caps.

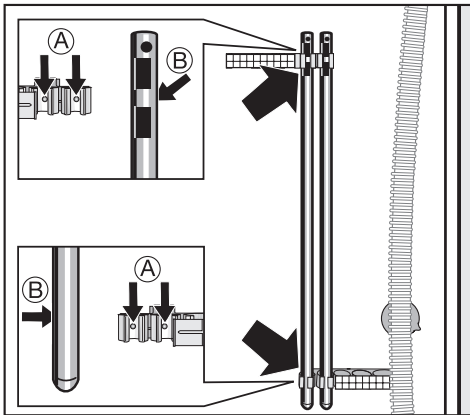

- Secure the transit bars to the back of the washing machine. Make sure that holes (B) are fitted over retainers (A).



## Levelling the machine

The machine must stand perfectly level on all four feet to ensure safe and proper operation.

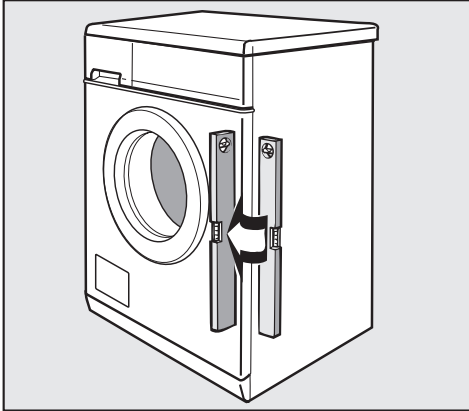

Incorrect installation may increase electricity and water consumption and may cause the machine to move about.

## Screwing out and adjusting the feet

The four adjustable screw feet are used to level the machine. All four feet are screwed in when the machine is delivered.

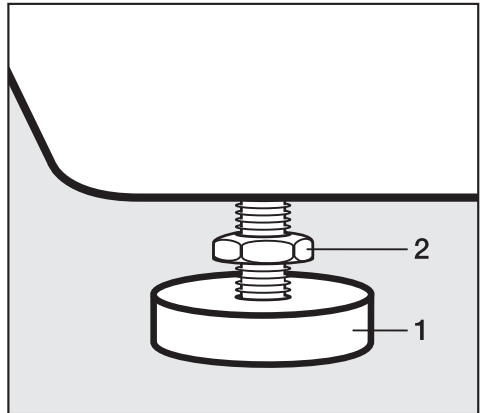

- Using the spanner supplied turn counter nut **2** in a clockwise direction. Then turn counter nut **2** together with foot **1** to unscrew.
- Use a spirit level to check the machine is standing level.
- Hold foot **1** securely with a pipe wrench. Turn counter nut **2** again using the spanner supplied until it sits firmly up against the housing.

 All four counternuts must be firmly up against the housing. Please also check this for the feet which did not need adjustment. Otherwise there is the danger of the machine moving about.

# Installation and connection

## Building under a continuous worktop/in a kitchen run

- A special building under conversion kit\* is required.  
The machine lid must be replaced by a cover plate. To ensure electrical safety the cover plate must be fitted.

### N.B.

If you wish to push your machine under a worktop and there is space to do this **without removing the lid**, the conversion kit is not necessary. Otherwise the conversion kit is essential.

- For installation under a work surface 900/910 mm from the floor, a raising kit\* is required.
- Connections for electricity, water and drainage should be installed in such a way that they remain accessible when the machine is in place.

Fitting instructions are supplied with the conversion kit.

All parts marked\* are available from the Miele Spare Parts or Sales Department.

The fitting of building under kits and stacking kits must only be undertaken by qualified and competent persons, in accordance with the instructions supplied with the kit.

## Washer and Dryer stack

A Miele tumble dryer can be stacked with the washing machine. A stacking kit\* is necessary and can be purchased from the Miele Spare Parts Department.

### Please note

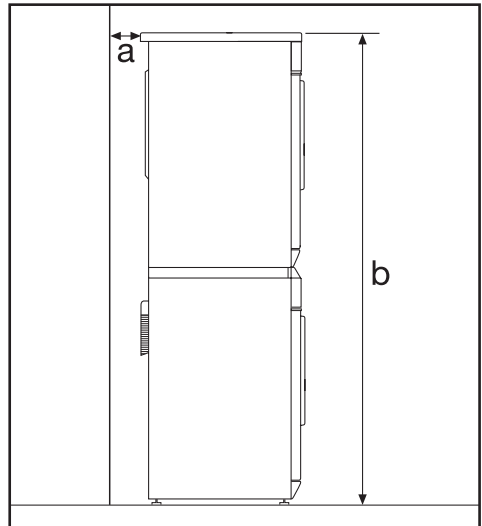

**a** Safety distance to wall:  
at least 2 cm

**b** Height:  
Stacking kit with pull-out shelf:  
approx. 169 cm  
Stacking kit without pull-out shelf:  
approx. 170 cm

## Replacing the lid

If the lid has been removed in order to fit a stacking kit or cover plate, ensure that, if the lid is replaced, it fits securely into the rear holders. Otherwise, it is not properly secure for transport.

## The Miele water protection system

The Miele water protection system protects the washing machine from water damage.

The system consists of three main components:

- 1) the inlet hose
- 2) the electronic unit and the washing machine housing
- 3) the drain hose

### 1) Inlet hose

The inlet hose can withstand pressure of more than 7,000 kPa.

### 2) Electronic unit and washing machine housing

- Sump

Any leaking water is collected in a sump in the base of the appliance. A float switches off the safety valves, preventing any more water flowing into the machine and water in the suds container is pumped away.

- Overflow protection

This prevents the washing machine taking in too much water. If the water level exceeds a certain level, the drain pump switches in and pumps the excess water away.

### 3) Drain hose

The drain hose is protected by a ventilation system which prevents the washing machine from being emptied completely.

# Installation and connection

## Connection to the water supply

The machine should be connected to a mains water supply in accordance with local and national safety regulations. The German authorities do not require it to have a non-return valve as the washing machine has been designed to comply with DIN regulations.

The machine is designed to operate with a flow pressure of between 100 kPa and 1,000 kPa. If it is higher than 1,000 kPa it is essential to fit a reducer valve.

Connection to the mains water supply should incorporate a mains stopcock with  $\frac{3}{4}$ " thread. The stopcock should be fitted by a qualified plumber.

 The connection point is subject to mains water pressure. Turn on the stopcock slowly and check for leaks. Correct the position of the washer and union if appropriate.

The washing machine is **not** suitable for connection to a hot water supply and connection to a household water softener is not recommended.

In order to protect the water inlet valve, the two dirt filters - one in the open end of the inlet hose, one at the inlet point in the machine must not be removed.

## Extension hose

- Longer hoses 2.5 or 4.0 m in length are available from your Miele dealer or the Miele Spare Parts Department as optional extras.

## Maintenance and care

Only use a genuine Miele hose should you ever need a replacement or extension. These are tested to withstand pressure of at least 7,000 kPa.

## Connection to the drainage system

The machine drains via a drain pump with a delivery head of 1 metre\*.

The drain hose must not be kinked as this restricts drainage. The swivel elbow at the end of the hose can be turned in either direction, or can be detached if required, with a sharp twist and pull.

If required, the drain hose can be extended to a length of 5 m. The necessary parts can be purchased from the Miele Spare Parts Department or your Miele dealer.

\* For a delivery head of more than 1 m (up to a maximum of 1.8 m) a second duo-drain pump is available with the corresponding kit from the Miele Spare Parts Department or your Miele Dealer.

### Drain hose connection:

1. Direct into a sink or basin:

Please note the following

- Hook the hose over the edge and secure.
  - Make sure that the water can drain away freely without hindrance. Otherwise there is a risk of water overflowing or of some of the drained water being sucked back into the machine.
2. Connected securely to a plastic drain pipe with a rubber nipple. There is no need to use a non-return valve.
  3. Connected securely to a standpipe.
  4. Connected securely to a floor gully.

# Installation and connection

---

## Electrical connection U.K.

All electrical work should be carried out only by a suitably qualified and competent person, in strict accordance with national and local safety regulations.

The appliance is supplied with a mains cable with moulded plug for connection to a 230-240V mains supply. **The voltage, rated load and fuse rating are given on the data plate.** Please ensure these match the household mains supply.

Connection should be made via a fused plug and suitable switched socket which is easily accessible after installation.

For extra safety it is advisable to install a residual current device (RCD), with a trip current of 30 mA (in accordance with DIN VDE 0664, VDE 0100 Section 739).

Do not connect via an extension lead.

### Important

The wires in the mains lead are coloured in accordance with the following code:

Green/yellow = earth

Blue = neutral

Brown = live

Where it is necessary to change plugs, if the colours of the wires in the mains lead of this appliance do not correspond with the coloured markings identifying the terminals of your plug, proceed as follows:

The wire which is coloured green and yellow must be connected to the terminal in the plug which is marked with the letter E or by the earth symbol  or coloured green, or green and yellow.

The wire which is coloured blue must be connected to the terminal in the plug which is marked with the letter N or coloured black.

The wire which is coloured brown must be connected to the terminal in the plug which is marked with the letter L or coloured red.

## **WARNING: THIS APPLIANCE MUST BE EARTHED**

Ensure power is not supplied to the appliance while installation work is being carried out.

## **Non-rewireable plugs BS 1363**

If this machine is fitted with a non-rewireable plug, the following information applies:



If the socket outlets are not suitable for the plug supplied with the product, it must be cut off and an appropriate plug fitted. The fuse carrier and fuse should be removed from the old plug and disposed of.

The old plug should then be disposed of and on no account be inserted into any socket elsewhere in the house (electric shock hazard).

The fuse cover must be refitted when changing the fuse, and if the fuse cover is lost, the plug must not be used until a suitable replacement is obtained. The colour of the correct replacement cover is that of the coloured insert in the base of the plug, or the colour that is embossed in words on the base of the plug (as applicable to the design of plug fitted).

Replacement fuses should be ASTA approved to BS 1362 and have the correct rating. Replacement fuses and fuse covers may be purchased from your local electrical supplier or Service agent.

# Consumption data

Programme (without any additional options or programmable functions)	Load	Consumption data			
		Energy in kWh	Water in litres	Duration	
				normal	Short
<b>Cottons</b>					
95°C	5.0 kg	1.70	45	1 h 47 min	1 h 32 min
60°C <sup>1)</sup>	5.0 kg	0.95	45	1 h 56 min	1 h 26 min
40°C	5.0 kg	0.50	45	1 h 56 min	1 h 26 min
<b>Minimum iron</b>					
40°C	2.5 kg	0.45	49	1 h 16 min	1 h 01 min
<b>Delicates</b>					
30°C	1.0 kg	0.35	65	59 min	49 min
<b>Silks </b>					
30°C	1.0 kg	0.24	39	37 min	–
<b>Woolens </b>					
30°C	2.0 kg	0.23	35	40 min	–

<sup>1)</sup> EN 60456 test programme

Consumption data can vary from the nominal values given depending on water pressure, water hardness, water inlet temperature, room temperature, type and volume of load, fluctuations in the electricity supply and any additional options selected.

N.B.

Consumption data obtained from a machine tested in Germany.



## Technical data

Height	85.0 cm
Width	59.5 cm
Depth	58.0 cm
Depth with door open	94.5 cm
Weight	93 kg
Maximum floor load	1600 Newton (approx. 160 kg)
Capacity	5 kg dry laundry
Voltage	see data plate
Rated load	see data plate
Fuse rating	see data plate
Consumption data	see "Consumption data"
Water flow pressure min.	100 Pa (1 bar)
Water flow pressure max.	1.000 Pa (10 bar)
Inlet hose length	1.60 m
Drain hose length	1.50 m
Connection cable length	1.60 m
Drain pump head max.	1.00 m
Drain pump length max.	5.00 m
Test certificates awarded	Radio/TV suppression, VDE



## Programmable functions for changing standard settings

# Programmable functions

---

The programmable functions can be used to tailor washing programmes to suit your individual requirements.

The programmable functions are activated with the help of the *Start* button and the programme selector.

## Water plus system

Selecting the *Water plus* additional option increases the water intake in the programmes listed below.

The water intake is increased in the wash and rinse stages and in the - *Cottons* programme an extra rinse cycle is introduced.

There are four different settings which can be programmed to alter the water intake for the following programmes:

- Cottons
- Minimum iron
- Quick wash
- Mixed wash
- Silks

The programmed setting is then activated by pressing the *Water plus* additional option button.

## The settings are as follows:

### Setting 1:

an increase in the rinse water level for the programmes listed (except for Silks).

### Setting 2:

an increase in the water level in the main wash and rinses for the programmes listed (the washing machine is delivered with setting 2 programmed as standard).

### Setting 3:

an extra rinse cycle in the *Cottons* programme only.

### Setting 4:

an increase in the water level in the main wash and rinses for the programmes listed and also an extra rinse cycle in the *Cottons* programme. This setting should be programmed in if laundry is too hard after drying and if someone in the household suffers from a detergent allergy.

Steps ❶ to ❷ on the following page describe how to programme and store a setting in memory.

## Programmable functions

### Follow steps ① to ⑦ to programme and store a setting in memory.

Before you begin, first ensure that:

- The washing machine is switched off.
- The machine is properly closed.
- The programme selector is at *Finish*.

① Press the *Start* button and keep it pressed in whilst carrying out steps ② to ③.

② Switch the machine on with the *I-On/O-Off* button.

③ Wait until the *Start* indicator light comes on . . .

④ . . . and then release the *Start* button.

⑤ Turn the programme selector to the *Cottons 75°C* position:

The *Soak/Pre-wash* sequence indicator light will briefly flash twice in 2 second intervals, to show that factory Setting 2 is stored in memory.

⑥ Each subsequent press on the *Start* button selects a different setting.

The *Soak/Pre-wash* sequence indicator light will flash:

- **x 1** = Setting 1  
higher rinse water level selected
- **x 2** = Setting 2  
higher water level in the main wash and rinses (factory setting)
- **x 3** = Setting 3  
extra rinse in the *Cottons* programme
- **x 4** = Setting 4  
higher water level in the main wash and rinses and an extra rinse in the *Cottons* programme

⑦ Switch the washing machine off with the *I-On/O-Off* button.

The *Water plus* button has now been allocated the setting you have chosen. This setting will remain in memory until another setting is programmed.

# Programmable functions

---

## Gentle action

Activating gentle action reduces the drum action. Slightly soiled items are washed more gently. It should be activated for garments with a single bar under the care label and for articles which feel too hard after they have been dried.

Gentle action can be used with the *Cottons*, *Quick wash*, *Starch* and *Mixed wash* programmes.

If "Gentle action" is programmed into the machine, every wash cycle in these programmes will be carried out with gentle action rhythm.

The washing machine is delivered with "Gentle action" de-activated.

### Follow steps ① to ⑦ to programme and store in memory.

Before you begin, first ensure that:

- The washing machine is switched off.
- The machine is properly closed.
- The programme selector is at *Finish*.

- ① Press the *Start* button and keep it pressed in whilst carrying out steps ② to ③.
- ② Switch the machine on with the *I-On/O-Off* button.
- ③ Wait until the *Start* indicator light comes on . . .
- ④ . . . and then release the *Start* button.
- ⑤ Turn the programme selector to the *Cottons 60°C* position:

If the *Soak/Pre-wash* sequence indicator light:

**does not flash** = Gentle action **has not been activated.**

**flashes** = Gentle action **has been activated.**

- ⑥ Press the *Start* button to activate or deactivate the Gentle action option.
- ⑦ Switch the washing machine off with the *I-On/O-Off* button.

The setting you have selected is now stored in memory and will remain so until you alter it.

### Top-up rinse for *Cottons*

When this is activated, additional water flows into the drum at the end of the main wash and the suds are cooled down. Hot suds can damage plastic drainage pipes.

Top-up rinse takes place when temperatures of 95°C and 75°C are selected.

Top-up rinse should be activated:

- to prevent the danger of scalding if the drain hose is hooked over the edge of a sink or basin.
- where the drainage pipes do not comply with DIN 1986.

The washing machine is delivered with the Top-up rinse for *Cottons* deactivated.

### Follow steps ① to ⑦ to programme and store in memory.

Before you begin, first ensure that:

- The washing machine is switched off.
- The machine is properly closed.
- The programme selector is at *Finish*.

- ① Press the *Start* button and keep it pressed in whilst carrying out steps ② to ③.
- ② Switch the machine on with the *I-On/O-Off* button.
- ③ Wait until the *Start* indicator light comes on . . .
- ④ . . . and then release the *Start* button.
- ⑤ Turn the programme selector to the *Cottons 40°C* position:

If the *Soak/Pre-wash* sequence indicator light:

**does not flash** = the Top-up rinse for Cottons **has not been activated.**

**flashes** = the Top-up rinse for Cottons **has been activated.**

- ⑥ Press the *Start* button to activate or deactivate the Top-up rinse for *Cottons* option.
- ⑦ Switch the machine off with the *I-On/O-Off* button.

The setting you have selected is now stored in memory and will remain so until you alter it.

# Programmable functions

---

## Memory function

If an additional option(s) is selected for a programme, and / or the spin speed is altered, the machine stores these changes in memory at the start of a programme.

When that particular programme is chosen again, the display will show the additional option(s) and / or spin speed which have been stored for that programme in the memory.

The washing machine is delivered with the memory function deactivated.

### Follow steps ① to ⑦ to programme and store in memory.

Before you begin, first ensure that:

- The washing machine is switched off.
- The machine is properly closed.
- The programme selector is at *Finish*.

- ① Press the *Start* button and keep it pressed in whilst carrying out steps ② to ③.
- ② Switch the machine on with the *I-On/O-Off* button.
- ③ Wait until the *Start* indicator light comes on . . .
- ④ . . . and then release the *Start* button.
- ⑤ Turn the programme selector to the *Cottons 30°C* position:

If the *Soak/Pre-wash* sequence indicator light:

**does not flash** = the Memory function **has not been activated**.

**flashes** = the Memory function **is activated**.

- ⑥ Press the *Start* button to activate or deactivate the Memory function option.
- ⑦ Switch the machine off with the *I-On/O-Off* button.

The setting you have selected is now stored in memory and will remain so until you alter it.



### Soak

A length of time of between 30 minutes and 2 hours can be programmed in 30 minute increments for the soak process.

If the soak button is pressed the selected soak time will be carried out for the period selected before the wash programme is run.

The machine is set as standard to a two hour soak time.

### Follow steps ① to ⑦ to programme and store in memory.

Before you begin, first ensure that:

- The washing machine is switched off.
- The machine is properly closed.
- The programme selector is at *Finish*.

① Press the *Start* button and keep it pressed in whilst carrying out steps ② to ③.

② Switch the machine on with the *I-On/O-Off* button.

③ Wait until the *Start* indicator light comes on . . .

④ . . . and then release the *Start* button.

⑤ Turn the programme selector to the *Minimum iron 60°C* position:

The *Soak/Pre-wash* sequence indicator light will briefly flash once every 2 seconds, to show that a soak time of 2 hours is stored in memory.

⑥ Each subsequent press on the *Start* button selects a different setting.

If the *Soak/Pre-wash* sequence indicator light:

- **flashes x 1** = the soak time is 2 hours
- **flashes x 2** = the soak time is 1 hour 30 minutes
- **flashes x 3** = the soak time is 1 hour
- **flashes x 4** = the soak time is 30 minutes

⑦ Switch the machine off with the *I-On/O-Off* button.

The *Soak* button has now been allocated the setting you have chosen. This setting will remain in memory until another setting is programmed.





**United Kingdom:**

Miele Co. Ltd.  
Fairacres, Marcham Road  
Abingdon, Oxon, OX14 1TW  
tel. Abingdon (01235) 554455  
Service Office: (01235) 554466  
fax (01235) 554477  
Internet: [www.miele.co.uk](http://www.miele.co.uk)

**Ireland:**

Miele Ireland Ltd.  
Broomhill Road, Tallaght, Dublin 24  
Tel: (01) 46 10 710, Fax: (01) 46 10 797  
Email: [info@miele.ie](mailto:info@miele.ie)  
Internet: <http://www.miele.ie>

**Australia:**

Miele Australia Pty. Ltd.  
A.C.N. 005635398  
1 Gilbert Park Drive  
Knoxfield, VIC 3180  
Telephone: (03) 9764 7100  
Fax: (03) 9764 7129  
Internet: [www.miele.com.au](http://www.miele.com.au)

**Distributor New Zealand:**

Steelfort Engineering Company. Ltd.  
500 Rangitikei Street  
Palmerston North, Priv. Bag 11045, NZ  
Telephone: (06) 350 1350  
Fax: (06) 356 1507

**South Africa:**

Miele (Pty) Ltd  
304 Tungsten Road  
Strijdom Park 2194  
P.O.Box 1654, Randburg 2125  
Tel. (011) 793-7452  
Telefax (011) 793-7447  
E-mail: [info@miele.co.za](mailto:info@miele.co.za)  
Internet: [www.miele.co.za](http://www.miele.co.za)

**Singapore:**

Miele Southeast Asia  
Miele Pte. Ltd.  
163 Penang Road  
# 04 - 02/03 Winsland House II  
Singapore 238463  
Tel : +65-67351191  
Fax: +65-67351161  
Email: [mielesea@miele.com.sg](mailto:mielesea@miele.com.sg)

**Hong Kong:**

Miele (Hong Kong) Limited  
AIA Plaza, Room 401, 4<sup>th</sup> Floor  
18 Hysan Avenue  
Causeway Bay  
Hong Kong  
Tel.: (852) 2610 1331  
Fax: (852) 2610 1013  
E-mail: [mielehk@netvigator.com](mailto:mielehk@netvigator.com)

## Free Manuals Download Website

<http://myh66.com>

<http://usermanuals.us>

<http://www.somanuals.com>

<http://www.4manuals.cc>

<http://www.manual-lib.com>

<http://www.404manual.com>

<http://www.luxmanual.com>

<http://aubethermostatmanual.com>

Golf course search by state

<http://golfingnear.com>

Email search by domain

<http://emailbydomain.com>

Auto manuals search

<http://auto.somanuals.com>

TV manuals search

<http://tv.somanuals.com>