

Miele

NAVITRONIC

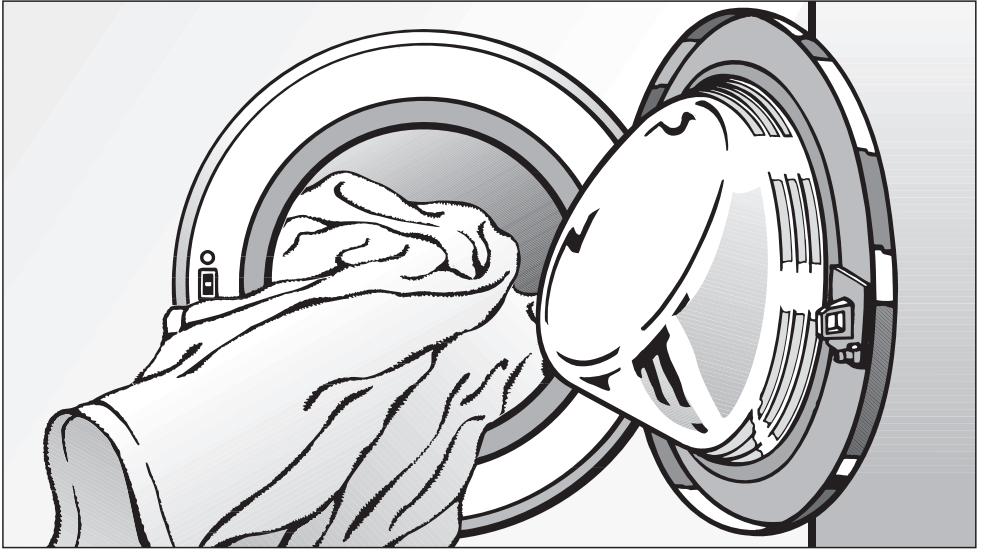

Operating instructions for Washing machine W 2888 WPS

To avoid the risk of accidents or damage to the machine it is **essential** to read these instructions before it is installed and used for the first time.



M.-Nr. 06 559 470

Caring for our environment

Disposal of the packing material

The transport and protective packing has been selected from materials which are environmentally friendly for disposal and can normally be recycled.

Ensure that any plastic wrappings, bags etc. are disposed of safely and kept out of the reach of babies and young children. Danger of suffocation!

Rather than just throwing these materials away, please ensure they are offered for recycling.

Disposal of your old appliance or machine

Electrical and electronic appliances / machines often contain materials which, if handled or disposed of incorrectly, could be potentially hazardous to human health and to the environment. They are, however, essential for the correct functioning of your appliance or machine. Please do not therefore dispose of your old machine or appliance with your household waste.

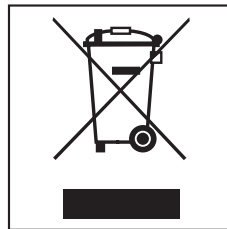



Please dispose of it at your local community waste collection / recycling centre and ensure that it presents no danger to children while being stored for disposal.

It should be unplugged or disconnected from the mains electricity supply by a competent person. The plug must be rendered useless and the cable cut off directly behind it to prevent misuse. See the "Warning and Safety" section of this booklet for further details.

Caring for our environment	2
Disposal of the packing material	2
Disposal of your old appliance or machine	2
Warning and safety instructions	6
Operating the washing machine	9
Control panel	9
Displays	10
Before using for the first time	12
Reminder to remove transport struts	12
Running your first programme	13
Calibrating the load sensor to zero	13
Washing environmentally and economically	14
Energy and water consumption	14
Detergent	14
Choosing the correct Extra options (Soak, Pre-wash, Intensive)	14
When drying with a tumble dryer	14
How to wash correctly	15
Brief instructions	15
Favourite programmes	19
Selecting/changing a favourite	19
Saving a favourite programme	21
Extras	22
Water plus	22
Intensive	22
Rinse hold	23
Soak	23
Pre-wash	23
Adding detergent	24
Timer	25
Spinning	26
Final spin speed	26
Rinse and interim spin	26
To omit the final spin (Rinse hold)	26
To omit rinse and interim spin and the final spin	26
Programme chart	27
Programme sequence	32

Contents

Changing the programme sequence	34
To cancel a programme	34
To interrupt a programme	34
To change a programme	34
Adding or removing laundry after a programme has started	35
Electronic programme locking	36
Detergent	37
Water softeners	37
Washing with several components	37
Fabric conditioners and liquid starch	38
Automatic dispensing of fabric conditioner or liquid starch to laundry at the end of a programme	38
Adding fabric conditioner separately	38
Adding starch separately	38
Colour run and dye removers / dyes	38
Cleaning and care	39
E-Cloth	39
Extra cleaning	39
Cleaning the detergent dispenser drawer	40
Cleaning the filter in the water inlet	41
Problem solving guide	42
What to do, if	42
The programme does not start	42
Problems with the load size indicator	43
General problems	44
An unsatisfactory wash result	45
The drum door cannot be opened by pressing the  button	46
Opening the drum door in the event of a blocked drain outlet and/ or power failure	47
Blocked drain outlet	47
Opening the drum door	48
Changing the lamp for the drum lighting	49
After sales service	50
Future updates (PC)	50
Appliance guarantee	50
Optional accessories	50

Installation and connection	51
Front view	51
Rear view	52
Installation surface	53
Installing the washing machine	53
Removing the transit fittings	53
Re-fitting the transit bars	55
Levelling the machine	56
Screwing out and adjusting the feet	56
Washer and Dryer stack	57
The Miele Waterproof system	58
Connection to the water supply	59
Connection to the drainage system	61
Electrical connection U.K.	62
Consumption data	63
Note for test institutes:	63
Technical data	64
Settings menu 	66
To open the Settings menu	66
Language 	66
Time of day	67
Water plus	68
Gentle action	68
Suds cooling	69
Lock	70
Temperature	72
Buzzer	72
Keypad tones	73
Display contrast	73
Stand-by	74
Memory	75
Miele@home	75
To close the Settings menu	75

Warning and safety instructions

To avoid the risk of accidents and damage to the machine please read these instructions carefully before using it for the first time. They contain important information on its safety, use and maintenance. Keep these operating instructions in a safe place and ensure that new users are familiar with the content. Pass them on to any future owner of the machine.

Correct usage

Only use the washing machine to wash items which are specified by the manufacturer to be machine-washable on the wash-care label, and textiles composed of hand-washable wool or wool blend fabrics as well as satin, lace, silk and other hand-washable garments. Any other applications may be dangerous. The manufacturer is not liable for damage resulting from improper use or operation.

Technical safety

Before setting up the machine, check it for any externally visible damage. Do not install and use a damaged machine.

Before connecting the machine, ensure that the connection data on the data plate (voltage and connected load) match the mains electricity supply. If in any doubt, consult a qualified electrician.

The electrical safety of this machine can only be guaranteed when continuity is complete between the machine and an effective earthing system which complies with local and national regulations. It is most important that this basic safety requirement is present and regularly tested and where there is any doubt the household wiring system should be inspected by a qualified electrician. The manufacturer cannot be held liable for the consequences of an inadequate earthing system (e.g. electric shock).

Do not connect the machine to the mains electricity supply by an extension lead. Extension leads do not guarantee the required safety of the machine (e.g. danger of overheating).

The machine is built in accordance with current safety requirements. Unauthorised repairs could result in unforeseen dangers for the user, for which the manufacturer cannot accept liability. Repairs should only be undertaken by a Miele approved technician.

Ensure current is not supplied to the appliance until after maintenance or repair work has been carried out.

The machine is only completely isolated from the electricity supply when:

- it is switched off at the wall socket and the plug is withdrawn, or
- it is switched off at the mains, or
- the mains fuse is withdrawn.

Warning and safety instructions

■ The Miele "Water protection system" protects from water damage provided the following conditions have been met:

- the machine is correctly plumbed in and connected to the electricity supply.
- if a fault has been identified, the machine must be examined by a competent person before further use, and repaired if necessary.

■ Faulty components must only be replaced by genuine Miele original spare parts. Only when these parts are fitted can the safety standards of the machine be guaranteed.

■ If the connection cable is faulty it must only be replaced by a Miele approved service technician to protect the user from danger.

■ In countries where there are areas which may be subject to infestation by cockroaches or other vermin, pay particular attention to keeping the machine and its surroundings in a clean condition at all times. Any damage which may be caused by cockroaches or other vermin will not be covered by the machine guarantee.

Use

■ This equipment may only be used in mobile installations such as ships, caravans, aircraft etc. if a risk assessment of the installation has been carried out by a suitably qualified engineer.

■ Do not install your washing machine in rooms where temperatures below freezing may occur. Frozen hoses may burst under pressure. The reliability of the electronic control unit may be impaired at temperatures below freezing point.

■ Before using the machine for the first time, check that the transit fitting at the rear of the machine has been removed (see section on "Installation"). During spinning, a transit fitting which is still in place may result in damage to both the machine and adjacent furniture or appliances.

■ Turn off the stopcock if the machine is to be left for any length of time (e.g. holiday), especially if there is no floor drain (gully) in the immediate vicinity.

■ **Flooding danger**
If hooking the drain hose into a wash basin, check that the water can drain off quickly enough to prevent the sink from overflowing. Make sure the drain hose is secure, so that the force of the water flowing out of the hose does not dislodge it. Otherwise this will result in flooding.

■ Take care to ensure that foreign objects (e.g. nails, pins, coins, paper clips) do not find their way into the machine with the laundry. These may damage components of the machine (e.g. suds container, drum), which in turn can result in damage to the laundry.

Warning and safety instructions

■ If the correct amount of detergent is dispensed, the machine should not need to be descaled. If, however, you do wish to descale the machine only use proprietary non-corrosive descaling agents and strictly observe the instructions on the packaging. If in doubt, contact the Miele Customer Service Dept. or your Miele Dealer.

■ Textiles which have been pre-treated in solvent based cleaning agents must be thoroughly rinsed in clean water before being washed in the machine.

■ Never use solvent based cleaning agents in this machine, as this may result in damage to component parts and create toxic fumes. Such detergents also pose a fire and explosion hazard.

■ Only use dyes specified by the manufacturer as being suitable for use in a domestic washing machine. Always observe the manufacturer's instructions carefully.

■ Colour run and dye removers contain sulphur compounds which can cause damage such as corrosion. Do not use these products in this machine.

■ Always make sure the drum is stationary before reaching in to remove washing. Reaching into a moving drum is extremely dangerous.

Safety with children

■ This machine is not a toy! To avoid the risk of injury do not allow children to play on or near it or to play with the controls. Supervise its use by the elderly or infirm, and supervise children whilst you are operating the machine.

■ For machines with a 'porthole' door, remember that the porthole glass will be hot when washing at very high temperatures. Do not let children touch it.

Accessories

■ Accessory parts may only be fitted when expressly approved by Miele. If other parts are used, guarantee, performance and product liability claims will be invalidated.

Disposal of your old machine

■ Before discarding an old machine, switch it off at the wall socket and unplug it. Render the plug useless. Cut off the cable directly behind the appliance to prevent misuse. This should be done by a competent person.

■ The manufacturer cannot be held liable for damage caused by non-compliance with these Warning and Safety instructions.

Operating the washing machine

Control panel

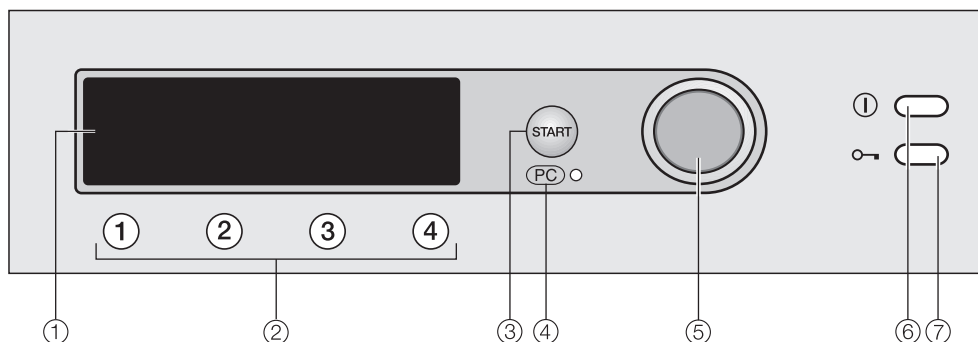

① Display

See the following pages for more information.

② Short cut buttons

For selecting an individual washing programme quickly. These buttons can be programmed to select your own favourite wash programmes.

③ Start button

④ PC / Optical interface

This is used by service technicians to run diagnostic checks on your machine and can also be used to update programming data in the future.

⑤ Multi-function selector

This is used to select menu options (by turning it) and to confirm your selection (by pressing it).

⑥ ① button

For switching the washing machine on and off.

⑦ Key button

Opens the machine door.

Operating the washing machine

Displays

Entry menu

1	COTTONS UNI.	60°C	PROG. SELECTION ...
2	MINIMUM IRON	40°C	SETTINGS ▸ ...
3	DELICATES	40°C	
4	WOOLLENS 	40°C	15:00

When the machine is switched on, the entry menu (with factory default settings) appears and *Prog. Selection* is highlighted.

Multi-function selector

Turning the multi-function selector moves the highlighting to the next menu option.

Pressing the multi-function selector selects the highlighted menu option.

Short cut buttons

Pressing a short cut button selects one of the four favourite programmes, which appear on the left of the display. You can customise the favourite programmes to suit your own requirements.

The short cut buttons have different functions in the other menus. Where this is the case, an arrow ▼ will appear in the display above the short cut button, together with a description of its function .

Programme selection

There are two ways of selecting a programme:

- Option 1: Select the *Prog. Selection* menu in the display and confirm your selection by pressing the multi-function selector.
- Option 2: Press short cut button ①, ②, ③ or ④. This will automatically take you into the main menu of that programme.

Operating the washing machine

Programme Selection menu



You can use the multi-function selector to select any programme. The highlighting will move up or down depending on the direction the multi-function selector is turned in. The ▼▲ arrows on the right of the display, indicate further options. Pressing the multi-function selector takes you to the main menu of the wash programme selected.

Wash programme main menu

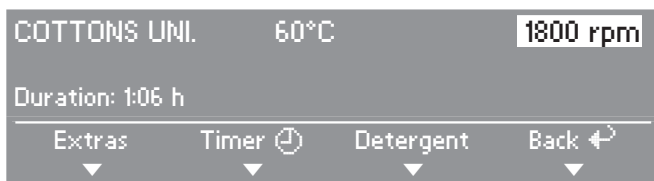

Turn the multi-function selector to select and highlight the programme, temperature and spin speed. Pressing the multi-function selector selects the highlighted option and opens the relevant sub-menu.

The sub-menus *Extras*, *Timer* and *Detergent* can be opened by pressing the short cut button directly below them.

You return to the entry menu by pressing short cut button ④ below *Back*.

Settings menu

The Settings menu is used to alter the washing machine's electronics to suit different requirements. See "Settings menu" for more details.

Before using for the first time

Before using the machine for the first time ensure that it is correctly installed and connected. See "Installation and connection". Also check that the drain filter is securely tightened to prevent the risk of water leaks during use.

The washing machine has a sensor which measures the amount of laundry in the drum. This determines the amount of detergent required. To allow the load size indicator to function correctly, you must first run a wash programme without any laundry and without detergent.

- Open the stopcock.
- Press the ① button in.

If the washing machine is being switched on for the first time, the welcome screen will appear.

The welcome screen will not appear again once a programme lasting longer than 1 hour has been completed.

Reminder to remove transport struts

To avoid the risk of damage, the transport struts must be removed before the washing machine is used for the first time. See "Installation and connection" for instructions on how to do this.

- Remove the transport struts (if this has not already been done by your fitter). Then confirm that you want to continue by pressing short cut button ④.

Setting the time of day

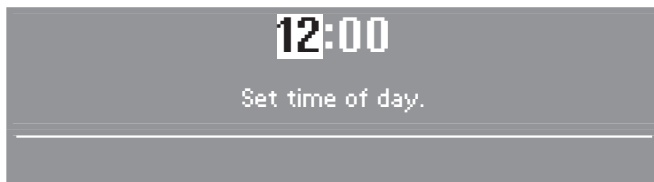

- Set the hour with the multi-function selector and confirm this setting. Now set the minutes. Once this has been confirmed, the time of day is saved in memory and the display goes back to the entry menu.

Before using for the first time

Running your first programme



- Press short cut button ①.

The main menu for Cottons Universal appears

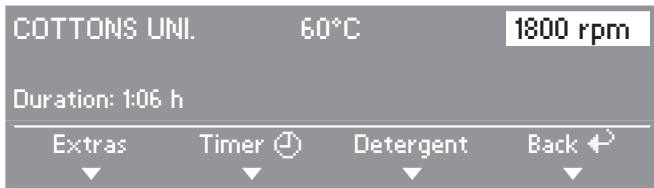

- Press the flashing *Start* button.
- Switch the washing machine off at the end of the programme.

The load sensor must then be calibrated to zero as you would with bathroom scales.

Calibrating the load sensor to zero

- Switch the washing machine on.
- Open the drum door.
- Press short cut button ③ in until the display shows: **Zero setting OK**
- Switch the washing machine off.

The drum settles a little during the first few washes and will take 3 or 4 wash cycles to reach its true position. For this reason, please re-calibrate the sensor to zero after each of the first few wash cycles.

The machine is now ready for use.

Washing environmentally and economically

Energy and water consumption

- Water consumption and energy usage are determined by the size of the load.
To make the most out of your machine load the maximum dry load for the programme you are using.
- Use the *Automatic* and *Quick wash* programmes for small loads.
- If smaller loads are washed using the *Cottons Hygiene* and the *Cottons Universal* programmes, the automatic load recognition system will reduce the amount of water, time and energy used. This may mean that the time left shown in the display is adjusted during the course of the wash programme.
- Instead of using *Cottons Hygiene 95°*, use *Cottons Universal 60°* and select the Extra option *Intensive*. This will give an energy saving of between 35% and 45%. The programme duration will be longer. This combination is sufficient for most levels of soiling. For stubborn or old stains, use the Extra option *Soak*.

Detergent

- Do not exceed the amounts of detergent recommended by the manufacturer on the packaging.
- Reduce the amount of detergent for smaller loads (use the Detergent sub-menu).

Choosing the correct Extra options (Soak, Pre-wash, Intensive)

Select:

a wash programme without any Extra options for light to normal soiling where there are no obvious marks.

a wash programme with the Extra option *Intensive* for normal to heavily soiled laundry with visible staining.

- Use the Extra option *Soak* instead of *Pre-wash*. If *Soak* is followed immediately by a main wash the same suds are used.

When drying with a tumble dryer

- Selecting the highest possible spin speed for the wash programme will save energy when drying in a tumble dryer afterwards.

Brief instructions

The headings numbered ①, ②, ③, . . . show the operating sequence and can be used as brief instructions.

① Sort the laundry

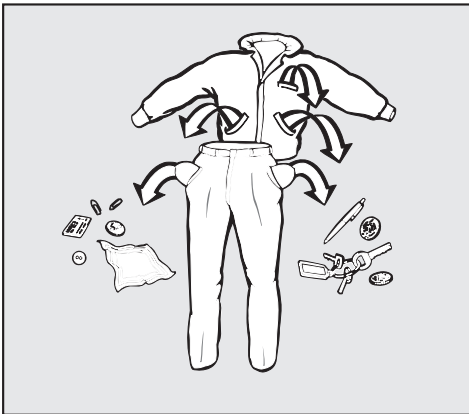

- Empty all pockets.

⚠ Foreign objects (e.g. nails, coins, paper clips, etc.) can cause damage to garments and components in the machine.

- Badly soiled areas, stains etc. should be removed as soon as possible, preferably whilst still fresh. Spillages should be carefully dabbed off using a soft colourfast cloth. Do not rub!

Badly soiled areas can be pre-treated with liquid detergent, stain removers etc. first, following the manufacturer's instructions. With particularly stubborn stains ask your dry cleaner for advice.

⚠ Do not use solvent-based cleaning agents in this machine.

- Sort the laundry by colour and by care label. Most garments have a textile care label in the collar or side seam.

Dark textiles often contain excess dye and should be washed separately several times before being included in a mixed load. Always wash whites and coloureds separately.

- Curtains: Remove lead weights first or place in a laundry bag.
- Underwiring and collar stiffeners: Any loose wiring in bras, shirt collar stiffeners, etc. should be removed or sewn in.
- Knitted garments, trousers and jeans, T-shirts and sweat shirts: Turn inside out, if recommended by the manufacturer.
- Close any zips, fasten hooks and eyes etc before washing.
- Fasten duvet covers etc. to prevent small items from being rolled up inside them.

Do not wash any items in this machine which are specified by the manufacturer as **not washable** on the care label. (☒ symbol)

How to wash correctly

2 Switch on the washing machine

The interior drum lighting will come on.

3 Select a programme

You can select a programme either by:

- using the appropriate short cut button to select one of the four frequently used programmes, or
- by going into the *Prog. Selection* menu.

If required, you can then select any *Extra* and/or *Delay start* from the relevant sub-menu.

4 Load the drum

- Press the  button to open the drum door.
- Unfold the laundry and load loosely in the drum. Mixing both large and small items gives better wash results and also helps distribute the load evenly during spinning.

The load size and the detergent indicators will appear.

The display shows the amount of laundry loaded in the drum as a % (in 25% steps) of the maximum load permissible for the programme selected. Please refer to "Adding detergent" for more information.

The most efficient use of energy and water is achieved when a full load is washed. However, do not overload as this causes creases and reduces cleaning efficiency.

Make sure that no garments are caught between the drum door and seal.

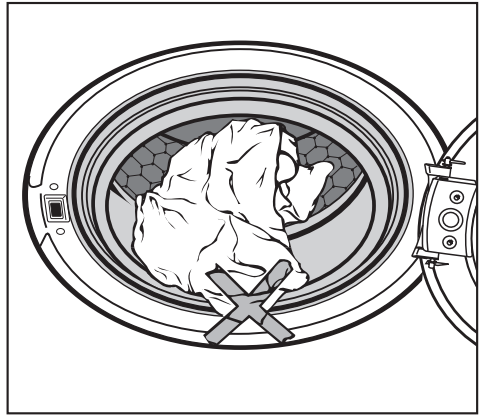

- Shut the door with a firm swing.

How to wash correctly

5 Add detergent

The percentage amounts in the display will help you to add the correct percentage amount of detergent recommended by the manufacturer.

40%	Add slightly less than half the amount recommended . . .
50%	Add half the amount recommended . . .
60%	Add slightly more than half the amount recommended . . .
75%	Add three quarters of the amount recommended . . .
100%	Add the full amount

You also need to take the level of soiling and water hardness into account.

too little detergent results in:

- Laundry not getting properly clean and with time it may become grey and hard to the touch.
- Greasy particles clinging to the laundry.
- Limescale deposits on the heater elements.

too much detergent results in:

- Excessive foam which causes a low level of agitation and poor wash, rinse and spin results.
- High water consumption (an additional rinse cycle will automatically switch in).
- A burden to the environment.

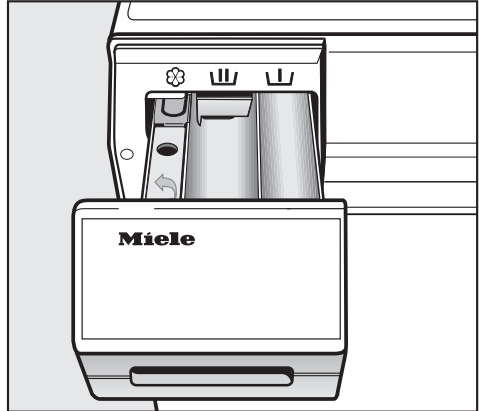

- Pull out the detergent drawer and add detergent to the compartments as follows:



Detergent for the pre-wash (add $\frac{1}{4}$ of the total amount recommended). This compartment is also used for starch formulations when starching separately.



Detergent for the main wash including Soak



Fabric conditioner or liquid starch.

- Close the detergent drawer.

See "Detergent" for further information on detergent and the amount to dispense.

How to wash correctly

6 Start the programme

- Press the flashing *Start* button.

The estimated programme duration will appear in the display. This will count down in one minute steps. During the first 10 minutes the washing machine measures how much water is being absorbed by the laundry. The programme duration may be longer or shorter depending on this absorbency rate.

The programme sequence is also shown in the display. The washing machine shows you when each section of the programme is reached.

The drum lighting switches off once the programme has started.

Once washing is in progress, you can press one of the short cut buttons to select or de-select additional options, or call up other information as follows:

- Button ① *Extras*: you can select or de-select the *Intensive* and/or *Rinse hold Extra* options up to 5 minutes after the programme has started.
- Button ② *Timer* ⌚: you can call up the current time of day and the estimated end time of the programme.
- Button ③ *Save*: to save the current programme as a favourite.
- Button ④ *Cancel*: to cancel the current programme. The suds are pumped away immediately.

7 Remove the laundry

Anti-crease and *Finish* will flash alternately in the display to indicate that the programme has finished.

- Press the  button to open the drum door.
- Remove the laundry.

Only remove laundry from the machine once the drum has stopped turning. Reaching into a moving drum is extremely dangerous and could result in injury.

Check that all items have been removed from the drum. Items left in the drum could discolour other items in the next wash or become discoloured themselves.

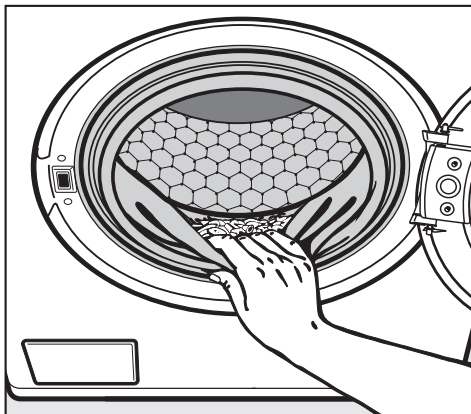

- Check the folds in the door seal for any small articles, e.g. buttons which might be lodged there.
- Switch the washing machine off with the ① button.
- Close the drum door. Otherwise there is the danger of objects being placed inadvertently in the drum. If these remained unnoticed and were washed in the next load, they could damage the laundry.

Favourite programmes

You can programme the short cut buttons to call up the four wash programmes you use most frequently.

You can do this at the same time as starting a wash programme.

Selecting/changing a favourite

- Switch the machine on.

Entry menu



- Press short cut button .

Main menu



- Turn the multi-function selector to highlight the part you want to change: Programme, Temperature or Spin speed and confirm your selection by pressing the multi-function selector.

Depending on the option highlighted selected, the following will be displayed:

– Programme selection



Use the multi-function selector to select the programme you want and confirm your selection. The main menu will reappear.

Favourite programmes

Important:

If you do not make a selection in the sub-menu within approx. 20 seconds, the display will revert to the main menu.

– Temperature selection

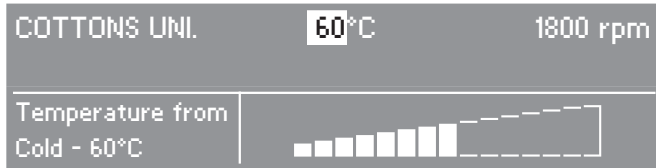

- Use the multi-function selector to select the temperature you want and confirm your selection. The main menu will reappear.

– Spin speed selection

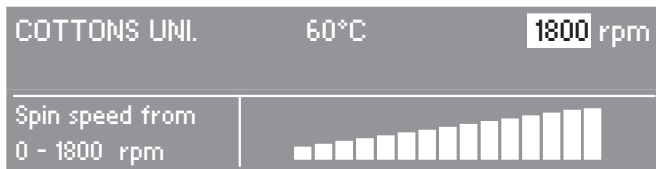

- Use the multi-function selector to select the spin speed you want and confirm your selection. The main menu will reappear.

Selecting Extras

- Press short cut button . This opens the *Extras* sub-menu.

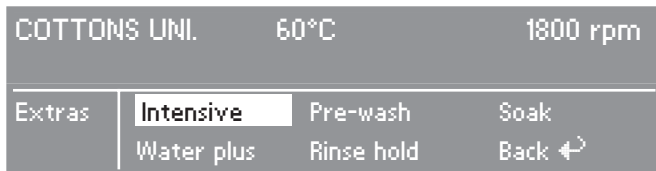

- Use the multi-function selector to select the Extra you want and confirm your selection. The main menu will reappear. Repeat the process if you want to select another extra. See "Extras" for more information.

Saving a favourite programme

All the settings you have selected are now shown in the main menu.

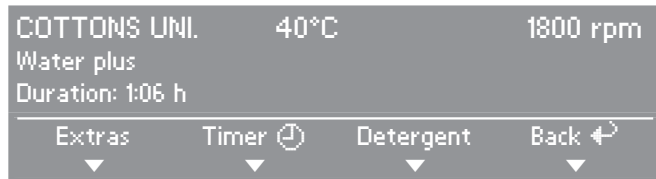

- Start the programme by pressing the *Start* button.

In a few seconds the option *Save* will appear in the display above short cut button ③.

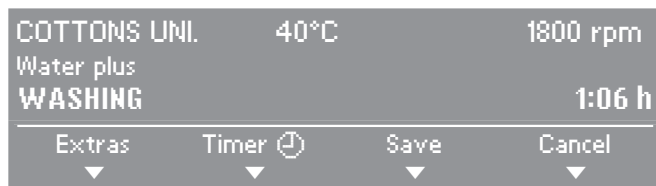

- Press short cut button ③.

Select a short cut button

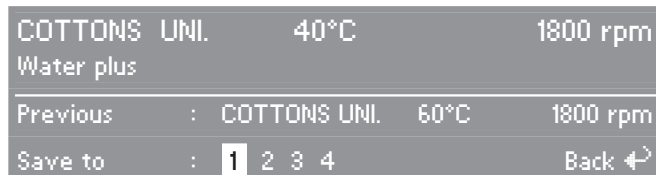

- Use the multi-function selector to select the number you want and confirm your selection. Your settings have now been saved as favourite programmes and will appear in the Entry menu.

If you do not want to run this programme immediately:

- Press short cut button ④ = Cancel

Repeat the procedure if you want to customise additional favourite programmes, and save them to short cut buttons which have not yet been used.

Extras

You can use the *Extras* to augment the basic wash programmes.

To open the Extras sub-menu

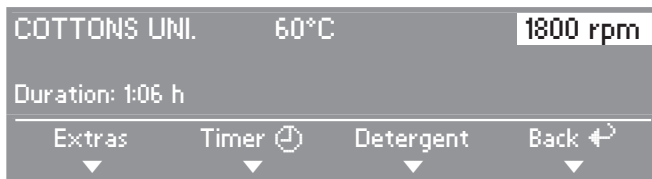

- Press short cut button ①.

Selecting Extras

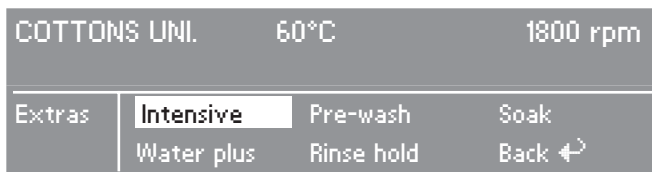

- Use the multi-function selector to select the Extra you want and confirm your selection.
 - Repeat the process if you want to select another Extra.
 - A tick will appear to show that an Extra has been selected.

Water plus

The machine is set at the factory so that the water level in the main wash and rinses will be increased if the *Water plus* Extra is selected.

However, you can select other settings for *Water plus*. These are described in "Settings".

Intensive

For normal to heavy soiling or where staining is visible.

The duration of the main wash is increased.

Rinse hold

The laundry is not spun after the last rinse and remains suspended in the final rinse water. This reduces creasing if the laundry is not going to be removed from the drum immediately after the end of the programme.

Soak

For heavily soiled and stained items with protein stains (e.g. blood, fats and oils, cocoa).

A length of time of between 30 minutes and 6 hours can be chosen, in 30 minute periods for the "Soak" process.

To select the soak time

COTTONS UNIL.		60°C	1800 rpm
15:00	Finish:	16:33	
	Soak time:	0:30	h

- Use the multi-function selector to select the soak time you want and confirm your selection.
- The soak time selected will be added to the running time of the wash programme.

To delete the soak time

- Set the soak time to 0:00 h and confirm your selection.

Pre-wash

For laundry with large amounts of dirt (e.g. dust, sand).

Adding detergent

The washing machine has a sensor which measures the amount of laundry placed in the drum. The *Detergent* sub-menu shows the percentage of the maximum load which has been placed in the drum. The maximum load will depend on the programme chosen.

In addition to the load size percentage, the amount of detergent required is also displayed as a % figure.

To open the Detergent sub-menu

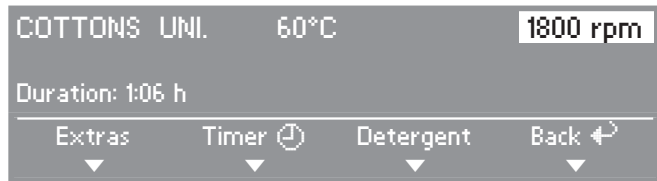

■ Press short cut button ③.

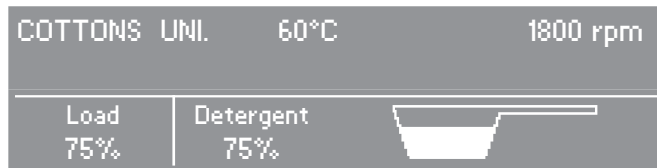

The load is shown in the display in 25% steps. Loads of less than 25% or an empty drum are shown as <25%. If the amount of laundry exceeds the maximum load, >100% will flash in the display. Note: >100% will not appear in the display if you have overloaded a *Cottons Hygiene* or *Cottons Universal* programme.

To exit from the Detergent sub-menu

Press the multi-function selector to return to the main menu.

You can use the timer to set the end time of a programme. You can also delay the start of a programme from 30 minutes up to a maximum of 24 hours, allowing you to make use of night-time economy electricity rates, for example.

To open the Timer sub-menu

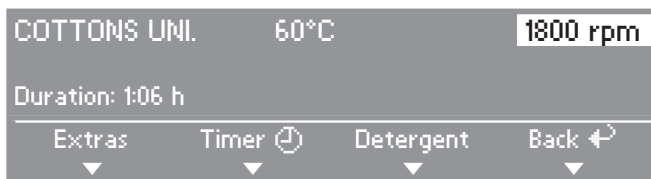

- Press short cut button ②.

To select a delay start time

You can enter the end time for a programme in 30 minute stages.



- Use the multi-function selector to select the programme end time (when the first 30 minute stage is entered, the programme end time will be adjusted to the next full or half hour). Confirm your selection. The start of the programme will now be delayed in parallel with the programme end time you have selected.

To start the timer

- Press the *Start* button.

The delay start time will be shown counting down in minutes.

To cancel the timer

- Press short cut button ④.

The actual load size can only be determined accurately by the machine once the programme has started. The programme end time may, therefore, be a bit later or earlier than first indicated.

Spinning

Final spin speed

Programm	U/min
Cottons Hygiene	1800
Cottons Universal	1800
Minimum Iron	900
Delicates	600
Automatic	900
Quick wash	1600
Woollens	1200
Silks	400
Starch	1500
Separate rinse	1200
Spin	1800
Denim	900
Shirts	600
Outer wear	800

You can reduce the final spin speed. You cannot select a final spin speed higher than that shown in the chart above.

Rinse and interim spin

There is a spin after the main wash and between the rinses. A reduction in the final spin speed will also reduce the interim spin speed. If a spin speed of less than 700 rpm is selected in the *Cottons Hygiene* and the *Cottons Universal* programmes, an additional rinse is introduced.



To omit the final spin (Rinse hold)

■ Select *Rinse hold* from the *Extras* sub-menu. The laundry will not be spun and will remain suspended in the final rinse water. This reduces creasing if the laundry is not going to be removed from the drum immediately after the end of the programme.

– To start the final spin:

The washing machine will display the maximum spin speed possible. You can select a spin speed lower than this. Start the final spin by pressing the *Start* button.







– To end the programme:

Press the  button. The water will drain away. Press the door button  again, to open the door.

To omit rinse and interim spin and the final spin

■ Select *Without spin* from the *Extras* sub-menu. The laundry is not spun after the final rinse. The water will drain away and the machine will go straight into the anti-crease stage. An additional rinse is introduced if this setting is selected with the *Cottons Hygiene*, *Cottons Universal*, *Minimum Iron*, *Automatic* and *Quick wash* programmes.







Programme chart

Cottons Hygiene 70°C to 95°C		  
Fabric	Cottons and linen fabrics, e.g. bed linen, table linen, nappies, underwear.	
Notes	<ul style="list-style-type: none"> – Suitable for heavily soiled laundry. – For heavy soiling or where staining is visible, select <i>Intensive</i>. – For laundry with stubborn soiling and/or soiling which has been left unwashed for some time, select <i>Soak</i>. – For laundry with large amounts of dirt (e.g. dust, sand), select <i>Pre-wash</i>. 	
Extras	Water plus, Intensive, Rinse hold, Soak or Pre-wash	
Detergent	Powder detergent, detergent for coloured fabrics, liquid detergent, tablet detergent and liquid tab detergent.	
Max. load	5.0 kg	
Cottons Universal cold to 60°C		   
Fabric	Cottons or cotton mix fabrics, e.g. T-shirts, trousers.	
Notes	<ul style="list-style-type: none"> – For heavy soiling or where staining is visible, select <i>Intensive</i>. – For laundry with stubborn soiling and/or soiling which has been left unwashed for some time, select <i>Soak</i>. – For laundry with large amounts of dirt (e.g. dust, sand), select <i>Pre-wash</i>. – For dark coloured fabrics use a detergent for coloured fabrics, or liquid detergent. 	
Extras	Water plus, Intensive, Rinse hold, Soak or Pre-wash	
Detergent	Powder detergent, detergent for coloured fabrics, liquid detergent, tablet detergent and liquid tab detergent	
Max. load	5.0 kg	
<p>Note for test institutes:</p> <p>For testing in accordance with EN 60456 you must select the <i>Intensive Extra</i> option.</p>		

Programme chart

Minimum iron cold to 60°C		30/40/50/60/30/40/50/60
Fabric	For garments made of synthetic fibres, mixed fibres and for easy care cotton shirts and blouses.	
Notes	– For heavy soiling or where staining is visible, select <i>Intensive</i> .	
Extras	Water plus, Intensive, Rinse hold, Soak or Pre-wash	
Detergent	Powder detergent, detergent for coloured fabrics, liquid detergent, detergent for delicates, tablet detergent and liquid tab detergent.	
Max. load	2.5 kg	
Note for test institutes: For testing in accordance with EN 60456 you must select the <i>Intensive Extra</i> option.		
Delicates cold to 60°C		30/40/50/60
Fabric	For delicate garments made of synthetic fibres, mixed fibres and easy care cotton shirts and blouses. Curtains, including net curtains, specified machine-washable by the manufacturer.	
Notes	– For heavy soiling or where where staining is visible, select <i>Intensive</i> . – For curtains which crease easily, reduce the spin speed or select Without spin.	
Extras	Intensive, Rinse hold, Soak or Pre-wash	
Detergent	Liquid detergent for delicates.	
Max. load	1.0 kg	
Automatic cold to 40°C		30/40/30/40
Fabric	Mixed loads of garments suitable for the <i>Cottons Universal</i> and <i>Minimum iron</i> programmes. Sort according to colour.	
Notes	– For heavy soiling where staining is visible, select <i>Intensive</i> .	
Extras	Water plus, Intensive, Rinse hold, Soak or Pre-wash	
Detergent	Powder detergent, detergent for coloured fabrics, liquid detergent	
Max. load	3.0 kg	







Programme chart

Quick wash cold to 40°C  	
Fabric	Small loads of lightly soiled laundry which can be washed in a <i>Cottons Universal</i> programme.
Extras	Water plus, Rinse hold
Detergent	Powder detergent, detergent for coloured fabrics, liquid detergent
Max. load	2.5 kg
Woollens  cold to 40°C  	
Fabric	Machine-washable or hand-washable wool or wool blend fabrics. If the care label does not specify a temperature wash using the cold setting.
Extras	Rinse hold
Detergent	Liquid detergent for machine-washable woollens.
Max. load	2.0 kg
Silks  cold to 30°C 	
Fabric	Hand-washable fabrics with no wool content, e.g. satin, lace and silk.
Notes	– Place socks, tights, bras etc. in a washing bag.
Extras	Water plus, Rinse hold
Detergent	Liquid detergent for delicates.
Max. load	2.0 kg
Starch	
Fabric	Table cloths, napkins, overalls, aprons.
Notes	– The laundry should be washed but not treated with fabric conditioner.
Extras	Rinse hold
Max. load	5.0 kg
Separate rinse	
Fabric	Articles which have been washed by hand and only need to be rinsed and spun in the machine.
Extras	Rinse hold
Max. load	5.0 kg



Programme chart

Spin	
For spinning fabrics. Please make sure you select the appropriate spin speed. Do not use for woollens.	
Denim cold to 40°C	
Fabric	Denim fabrics, e.g. jeans, skirts, shirts.
Notes	<ul style="list-style-type: none"> – Wash dark garments inside out. – Denim often contains excess dye and will run during the first few washes. Wash light and dark coloured items separately.
Extras	Rinse hold
Detergent	Detergent for coloured fabrics, liquid detergent, detergent for delicates
Max. load	2.0 kg
Shirts cold to 60°C	
Fabric	Shirts and blouses
Notes	<ul style="list-style-type: none"> – Pre-treat colours and cuffs if necessary. – Wash silk blouses in the <i>Silks</i> programme.
Extras	Rinse hold
Detergent	Powder detergent, detergent for coloured fabrics, liquid detergent, tablet detergent and liquid tab detergent
Max. load	1.5 kg
Outer wear cold to 40°C	
Fabric	Outer wear made from micro-fibres such as Gore-Tex®, SYMPATEX®, WINDSTOPPER® etc.
Notes	<ul style="list-style-type: none"> – Zip up jackets before washing. – Do not use fabric conditioner.
Extras	Rinse hold
Detergent	Follow manufacturer's instructions regarding detergent on the garment care label.
Max. load	2.0 kg





Important - other care symbols

	Hand wash (If no temperature is specified use the lowest temperature or cold)
	Do not wash
	Dry clean
	Do not dry clean
	Suitable for chlorine bleaching
	Do not use chlorine bleach

























Tumble dry

	At normal temperature
	At low temperature
	Do not tumble dry

Ironing

	Hot iron
	Medium hot iron
	Cool iron
	Do not iron

Programme sequence

	Main wash		Rinses		Spinning	
	Water level	Wash rhythm	Water level	No of rinses	Rinse and interim spin	Final spin
Cottons Hygiene		Ⓐ		2-3 ¹⁾	✓ ²⁾	✓
Cottons Universal		Ⓐ		2-3 ¹⁾	✓ ²⁾	✓
Minimum iron		Ⓐ		2-3 ³⁾	✓ ²⁾	✓
Delicates		Ⓑ		3	–	✓
Automatic		Ⓐ		2	✓ ²⁾	✓
Quick wash		Ⓐ		2	✓ ²⁾	✓
Woollens		Ⓒ		2	✓ ²⁾	✓
Silks		Ⓓ		2	–	✓
Starch	–	–		1	–	✓
Separate rinse	–	–		2	–	✓
Denim		Ⓐ		3	–	✓
Shirts		Ⓐ		2	–	✓
Outer wear		Ⓑ		3	✓ ⁴⁾	✓

 = Low water level

 = Medium water level

 = High water level

Ⓐ = Normal wash rhythm

Ⓑ = Gentle action

Ⓒ = Woollens

Ⓓ = Silks

Please continue reading for further details about the programme sequences.

This washing machine has fully electronic controls with automatic load recognition. It takes in the right amount of water required for the programme depending on the amount of laundry and its absorbency rate. This means that programme cycles and durations can vary.

The programme sequences outlined below are based on the basic programme with a full load. Extras which can be selected have not been taken into account.

The programme sequence display shows the stage the programme has reached.

Special features in the programme sequences:

Anti-crease:

At the end of every programme, with the exception of *Woolens*, the drum continues to turn at intervals for up to 30 minutes to help prevent creasing. The door can be opened and laundry removed at any time during the anti-crease phase.

1) A third rinse is carried out if:

- there is too much foam in the drum
- a spin speed lower than 700 rpm has been selected.
- *Without spin* has been selected

2) There is a spin after the main wash and between the rinses.

3) A third rinse is carried out if:

Without spin has been selected

4) In the *Outdoor* programme laundry is only spun after the main wash.

Changing the programme sequence

To cancel a programme

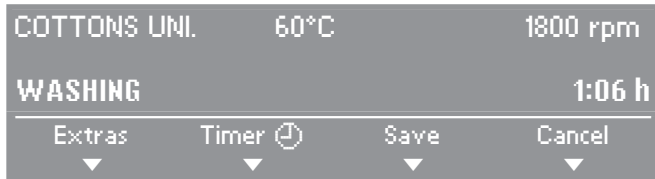

You can cancel a programme at any time after it has started by pressing short cut button ④ *Cancel*.

The suds will be pumped away.

- Open the drum door before starting a new programme.

To interrupt a programme

- Switch the washing machine off with the ① button.

To continue with the same programme:

- Switch the washing machine back on again with the ① button.

To change a programme

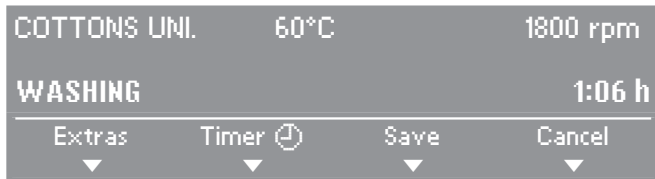

- Once a programme has started, you can change the spin speed up until the final spin begins.
- Up to 5 minutes after a programme has started: you can change the temperature and also you can select or deselect *Intensive* and/or *Rinse hold* by using short cut button ① to bring up the *Extras* sub-menu.

Changing the programme sequence

Adding or removing laundry after a programme has started

Laundry can be added or removed after the programme has started when using the following programmes:

- Cottons Hygiene
- Cottons Universal
- Minimum iron
- Quick wash
- Automatic
- Starch
- Press the door button  to open the door.
- Add or remove items.
- Close the drum door.

The programme will continue automatically.

Please note:



Once a programme has started the machine cannot recognise any adjustment to the load.

For this reason, if laundry is added or removed after the start of a programme, the machine will always complete the programme cycle for a full load.

This can alter the programme running time shown in the display.

The door cannot be opened, if:

- the suds temperature is above **55°C**.
- the water is above a certain level.
- the programme has reached the *Spin* stage.
- the electronic programme lock has been activated.

If you press the  button when the above conditions are present,  **System locked!** will light up in the display.

Electronic programme locking

Programme locking prevents the machine from being opened and/or the programme being cancelled during a wash programme.

To activate programme locking

- Once the programme has started, press the *Start* button for at least 6 seconds until the following appears in the display:



The machine will now not accept any changes and the programme will proceed through to the end.

Programme locking is deactivated automatically at the end of the programme.

To deactivate programme locking

- Press the *Start* button for at least 6 seconds until the following appears in the display:

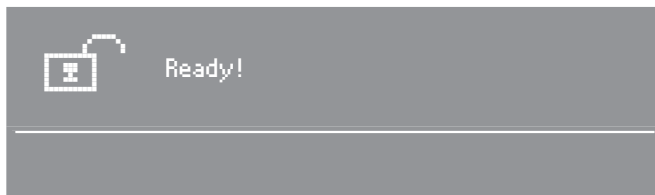



All modern detergents produced for automatic washing machines are suitable, including liquid, compact (concentrated), tablets, liquid tablets and special application detergents. Use dispensing aids, e.g. balls, if these are supplied with the detergent. Tablets are suitable for full loads but note that it may be impractical to reduce tablets for smaller loads. Some tablets do not dissolve as rapidly as others and may not be suitable for Quick wash programmes.

Silks, woollens and knitwear containing wool mixtures and hand-washable garments should be washed using a liquid detergent specifically designed for washing woollens. Do not use biological detergents on silk as the enzymes may damage the silk!

Instructions for use and recommended amounts for a full load are given on the detergent packaging.

Liquid detergent should be dispensed using a ball provided by the manufacturer for programmes without a pre-wash.

For programmes with a pre-wash you will need to purchase a special container from the Miele Spare Parts department which sits in the main wash compartment  of the detergent dispenser drawer. Add liquid detergent to this container for the main wash and to compartment  for the pre-wash.

The right amount to dispense will depend on the following:

- The quantity of laundry (follow the machine's dispensing recommendation and reduce the amount of detergent with smaller loads as indicated on the display)
- The soiling level of the laundry.
 - Lightly soiled No visible dirt or stains. Possibly slight body odour.
 - Normally soiled Visibly dirty and/or just a few slight stains.
 - Heavily soiled Stains and soiling clearly visible.
- The water hardness level. Check with your local water supplier if you do not know the water hardness level in your area.

Water softeners

A water softener can be used to cut down on the use of detergents in extremely hard water areas. Dispense according to the amount specified on the packaging. First add detergent and then the water softener. Use a quantity of detergent as for soft water. Miele do not recommend connecting the machine to a household water softener.

Washing with several components

If you wash using several components (e.g. special application detergents), dispense them into compartment  in the following order:

1. Detergent
2. Water softener
3. Stain remover

This way the agents are distributed more efficiently.

Detergent

Fabric conditioners and liquid starch

Fabric conditioners make garments soft and fluffy to handle and help prevent static cling when tumble drying.

Starch stiffens and gives body to items of laundry, e.g. shirts, tablecloths and bed linen.

- Dispense according to the amount specified on the packaging.

Automatic dispensing of fabric conditioner or liquid starch to laundry at the end of a programme

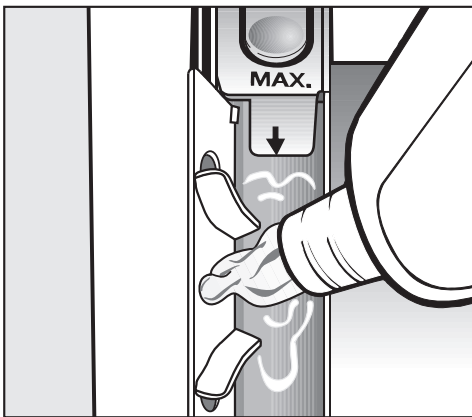

- Add the fabric conditioner or liquid starch to compartment ☼. **Do not exceed the maximum level mark.**

The conditioner or liquid starch is automatically dispensed in the last rinse. At the end of the programme a small amount of water remains in the fabric conditioner compartment ☼.

If starching frequently, clean the dispenser compartment and especially the siphon tube and conditioner channel regularly. See "Cleaning the detergent dispenser drawer". Do not add starch formulations or viscous liquid starch to the ☼ compartment as it will clog it up. See "Adding starch separately".

Adding fabric conditioner separately

- Add fabric conditioner to compartment ☼.
- Select the Starch programme.
- Press the *Start* button.

Adding starch separately

- Prepare the starch solution in accordance with manufacturer's instructions on the packaging.
- Add the starch formulation to compartment ☾.
- Select the Starch programme.
- Press the *Start* button.

Colour run and dye removers / dyes

- Do not use colour run or dye removers in this washing machine.
- Dyes suitable for use in domestic washing machines can be used. However, please note that the salt used in the dyeing process can cause corrosion to stainless steel components in the machine if you dye frequently. Always observe the manufacturer's instructions carefully.

 Disconnect the machine from the mains electricity supply and withdraw the plug from the socket prior to cleaning the machine.

- Clean the casing with a mild non-abrasive detergent or soap and water. Wipe dry with a soft cloth.
- Clean the fascia panel with a damp cloth and wipe dry with a soft cloth.
- The drum can be cleaned using a suitable proprietary stainless-steel cleaning agent following the manufacturer's instructions on the packaging.

 Do not use solvents, abrasive cleaners, glass cleaners or all-purpose cleaning agents. These might damage plastic surfaces and other components because of the chemicals they contain. The washing machine must not be hosed down.

Extra cleaning

Carry out a hot wash (70°C or above) with powder detergent approx. every 6 weeks to help prevent deposits building up in the machine. These can occur when washing is mainly done at low temperatures, and also lead to unpleasant smells. If you have no reason to wash occasionally at this high temperature, then run a Cottons 95°C programme with detergent but no laundry at regular intervals.

E-Cloth

A microfibre "E-Cloth" is available from the Miele UK Spare Parts Department, which is suitable for cleaning surfaces such as stainless steel, glass, plastic and chrome without the use of chemicals. It can be washed 300 times.

Cleaning and care

Cleaning the detergent dispenser drawer

Remove detergent residues regularly.

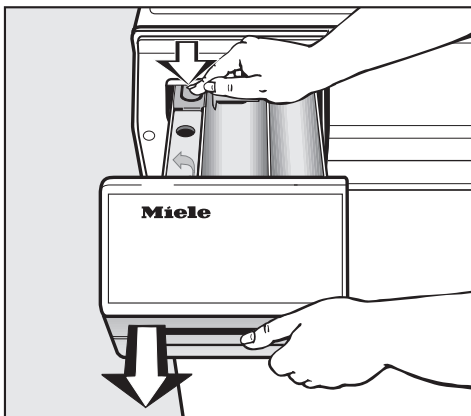

- Pull out the detergent dispenser drawer until a resistance is felt. Press down the release catch and at the same time pull the drawer right out of the machine.
- Clean the detergent drawer with warm water.

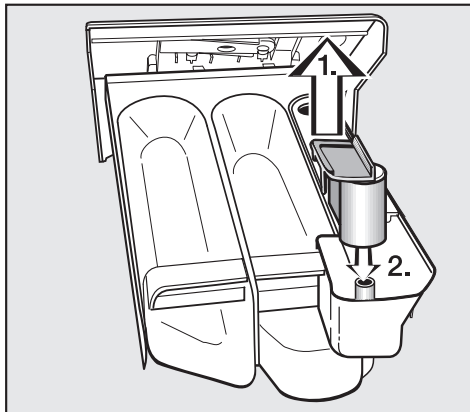

- Clean the siphon.
 1. Remove the siphon from compartment ⌘. Wash under running warm water. Clean the siphon tube in the same way.
 2. Replace the siphon.

Over time, detergent residue can build up in the water jets in the top of the detergent drawer housing.

- Before replacing the detergent drawer, use a bottle brush or similar to clean them out.

Cleaning the filter in the water inlet

The washing machine has a filter to protect the water inlet valve.

The accessible filter in the union in the open end of the inlet hose should be checked every six months, or more often if there are frequent interruptions to the external water supply.

- First turn off the stopcock.
- Unscrew the threaded union connecting the free end of the inlet hose to the stopcock.

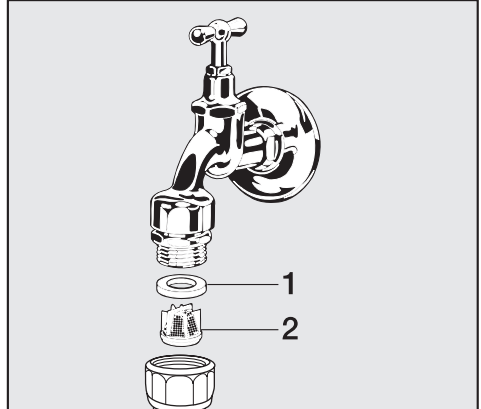

- Remove the rubber seal **1** from the recess.
- Using pointed pliers, take hold of the plastic filter bar **2** and remove.
- Clean the plastic filter.
- Put the filter and seal back in the reverse order and reconnect the hose.

Turn on the stopcock and check the connection is watertight. If water drips out, tighten the connection.

Never forget to put the filter back in place after cleaning.

Problem solving guide

What to do, if . . .

With the help of the following notes, minor faults in the performance of the appliance, some of which may result from incorrect operation, can be put right without contacting the Service Department.

 Repair work to electrical appliances should only be carried out by a suitably qualified person in accordance with local and national safety regulations. Repairs and other work by unqualified persons could be dangerous. The manufacturer cannot be held liable for unauthorised work.



The programme does not start

Problem	Possible cause	Remedy
The display remains dark.	There is no power to the machine.	Check whether <ul style="list-style-type: none">– the mains plug is plugged in and switched on.– the fuse or circuit breaker has tripped.
The display shows: Machine locked Enter lock code.	The electronic system lock has been activated.	Enter the code for the system lock and confirm the entry. Deactivate the system lock if you do not wish this message to appear the display the next time the machine is switched on.
There is a fault message in the display.	A programme cannot be started while there is a fault message in the display.	<ul style="list-style-type: none">– Note what is shown in the display.– Switch the washing machine off and then back on again with the  button. The fault message will be deleted.
The display is dark and the <i>Start</i> button is flashing slowly.	The display has switched off automatically to save energy (Stand-by mode).	Press one of the short cut buttons. Stand-by comes to an end.

Problems with the load size indicator

Problem	Possible cause	Remedy
<p>The display indicates a load of < 25% even though the drum is full.</p>	<p>There was already laundry in the drum when the washing machine was switched on. This has decalibrated the sensor from the zero setting.</p>	<ul style="list-style-type: none"> ■ To recalibrate the sensor to the zero setting: <ul style="list-style-type: none"> – Remove the laundry from the drum and leave the door <u>open</u>. – Switch off the washing machine. – Switch on the washing machine. – Press short cut button ③ in until the display shows: Zero setting OK.
<p>The display indicates a load greater than < 25%, even though the drum is empty.</p>	<p>The load size sensor has been decalibrated from the zero position.</p>	<p>If the display continues to indicate a load greater than < 25%, recalibrate the sensor to zero (see above section).</p>





Problem solving guide

General problems		
Problem	Possible cause	Remedy
The machine shakes during the spin cycle.	The machine feet are not level.	Level the machine (see "Installation").
The pump makes strange noises.	This is not a fault! These noises occur at the end of a pump sequence as a normal part of the operation.	
Large amounts of detergent residue remain in the detergent dispenser drawer.	The water pressure is too low.	<ul style="list-style-type: none"> – Clean the filter in the water inlet. – It may be useful to select the <i>Water plus Extra</i>.
	Powder detergent used in conjunction with water softeners tends to become sticky.	In future, add washing powder into the dispenser drawer first, and then add the water softener.
Fabric conditioner is not completely dispensed or too much water remains in the  compartment.	The siphon tube is not correctly positioned, or is clogged up.	Clean the siphon, (see "Cleaning and care" - "Cleaning the detergent dispenser drawer").
The display is in a different language.	A different language has been selected in <i>Settings</i>  <i>Language</i>  .	Set the language you want. The flag symbol will guide you.
The laundry has not been spun satisfactorily.	The spin speed selected was too low.	Select a higher spin speed next time.
When laundry is dry it feels hard to the touch.	Too vigorous wash action.	Programme in gentle action and more water.
	Not enough detergent used.	Increase detergent dose to prevent limescale build up in laundry.
	No fabric conditioner used.	Use fabric conditioner in last rinse.

An unsatisfactory wash result

Problem	Possible cause	Remedy
Liquid detergent does not give the required result.	Liquid detergents usually contain no bleaching agents. They do not remove fruit, coffee and tea stains.	<ul style="list-style-type: none"> – Use a general purpose detergent containing a bleaching agent. – Pour stain removers into compartment  of the dispenser drawer and liquid detergent into a dispenser ball. – Never put stain removers and liquid detergent together in the dispenser drawer.
Grey, greasy particles cling to washed laundry.	Insufficient amounts of detergent were used to break down the particles of grease in heavily soiled laundry.	<ul style="list-style-type: none"> – Use more detergent. – Before washing the next load run a <i>Cottons 95°C</i> programme with powder detergent but without a load.
A stale smell is in the drum and on laundry.	Low temperature washing.	Before washing the next load run a <i>Cottons 95°C</i> programme with powder detergent but without a load.
White residues which look like powder detergent are seen on dark textiles after washing.	The detergent contained compounds (zeolites) to aid water softening which are not soluble in water. They have ended up on the laundry.	<ul style="list-style-type: none"> – Try and brush off the residues with a soft brush once the laundry is dry. – Wash dark textiles using a detergent which contains no zeolites. Liquid detergents usually contain no zeolites.
Clothes are coming out creased.	Programme was overloaded.	– Reduce quantity of clothes in drum.
	The wrong programme was used.	<ul style="list-style-type: none"> – Check care labels and the programme chart. – Use easy iron conditioners.

Problem solving guide

The drum door cannot be opened by pressing the  button	
Possible cause	Remedy
The machine is not connected to the electricity supply and / or is not switched on.	Insert the plug in the socket and switch on and / or switch the machine on with the  button.
The electronic programme lock has been activated.	Deactivate programme locking as described in "Electronic programme locking".
The electronic system lock has been activated.	Deactivate the system lock as described in the <i>Settings</i>  menu.
Power cut	Open the drum door as described in the next section.
The door was not correctly engaged.	Press hard against the lock side of the drum door and then press the  button.
There is still water in the drum and the machine is unable to drain.	Clean the drain filter and drain pump as described in the next section.
For safety reasons the drum door cannot be opened if the suds temperature is higher than 55°C.	

Opening the drum door in the event of a blocked drain outlet and/or power failure

- Switch the washing machine off.

There is a lever behind the detergent drawer fascia panel.

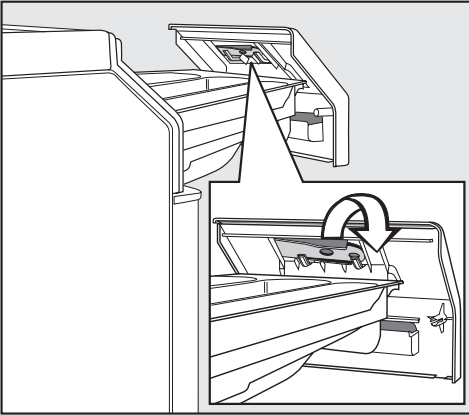

- Remove the lever.

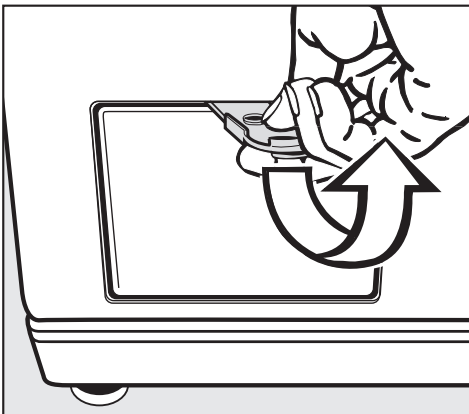

- Use it to open the access flap.

Blocked drain outlet

If the drain outlet is blocked, up to 25 litres of water will be retained in the machine.

⚠ Caution: if laundry has been washed at a high temperature, water draining out of the machine will still be hot. Danger of scalding!

Procedure for draining the machine

- Place a suitable container under the access flap.

When draining water from the machine, do **not** unscrew the drain filter completely or take it right out.



- Unscrew the drain filter lid until water runs out.

To interrupt the flow of water:

- Tighten the drain filter back up again.

Problem solving guide

Once the flow of water ceases:

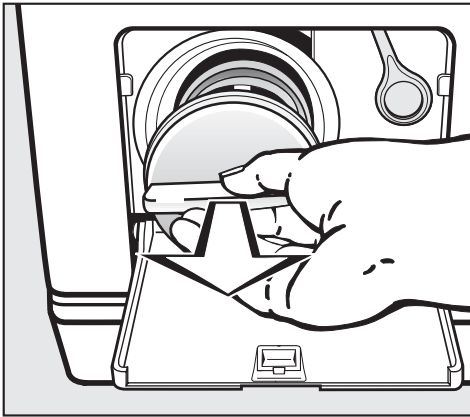

- Remove the drain filter completely.
- Clean it thoroughly.

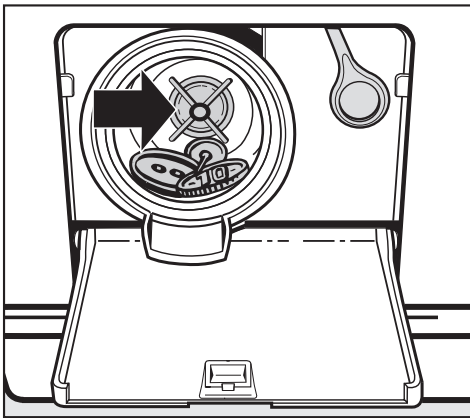

- Remove any foreign objects (e.g. buttons, coins, etc.) and fluff from the filter housing. Turn the impeller by hand to check that it rotates freely. Any foreign object causing an obstruction should be removed.
- Put the drain filter back in place and secure.

 Make sure the drain filter is securely tightened. Otherwise there is a risk of water leakage during use.

Opening the drum door

 Always make sure that the drum is stationary before reaching into the machine to remove laundry. Reaching into a moving drum is extremely dangerous.

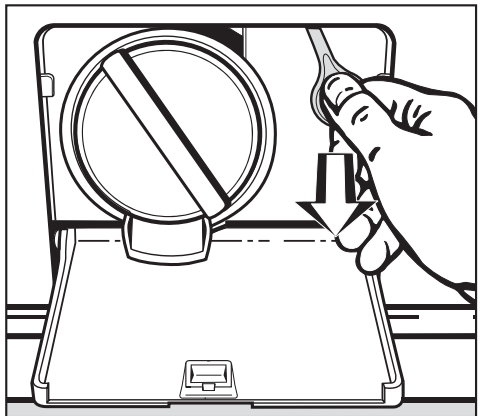

- Pull the emergency release downwards (see illustration). The drum door will open.

Changing the lamp for the drum lighting

The washing machine will still operate with no lamp in place or if the lighting is faulty.

- Remove the yellow lever from behind the detergent drawer fascia panel as described previously.
- Switch the washing machine on and open the drum door.
- Now disconnect the washing machine from the electricity supply, see "Warning and Safety instructions".

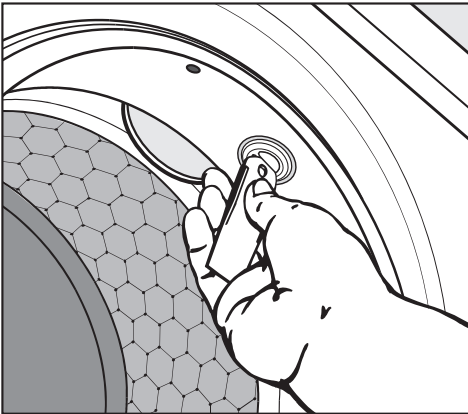

- Insert the lever into the slot in the drum lighting unit (see illustration) and turn anti-clockwise (a quarter turn) until you feel a resistance.
- Pull out the loosened unit with your fingers.

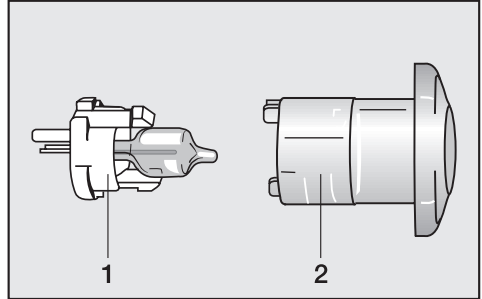

- Press the two prongs to separate the plastic holder **1** from the protective cover **2**.
- Remove the faulty lamp from the plastic holder.

The new lamp must be of the same type (G4) with a maximum power output of 5 watts/12 volts.

The lamps are available from an electrical retailer, your Miele Dealer or from the Miele Spare Parts Department.

- Insert the new lamp into the plastic holder.
- Carefully fit the plastic holder and the protective cover together.
- Insert the lighting unit back into the socket and turn it clockwise to secure it.

It is absolutely essential for the correct functioning of the washing machine that the drum lighting unit is fitted correctly in position.

After sales service

In the event of any faults which you cannot remedy yourself, please contact:

- your Miele dealer or
- the Miele Service Department (see back cover for contact details).

When contacting your Dealer or the Service Department, please quote the model and serial number of your appliance, both of which are shown on the data plate visible above the porthole glass when the door is open.

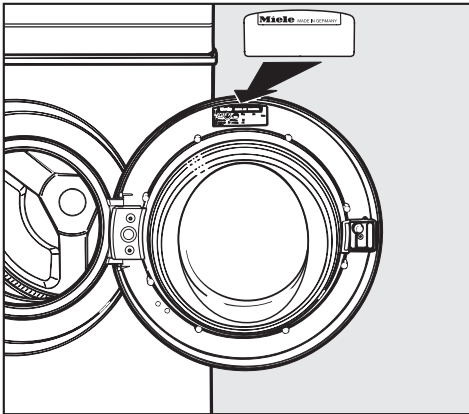

Future updates (PC)

The indicator or check light marked PC is the interface used by Miele service technicians during servicing work for testing purposes and for updating the machine's programme data.

Appliance guarantee

Please see the guarantee card supplied with your machine.

Optional accessories

Optional accessories for this washing machine are available from your Miele Dealer or from the Miele Spare Parts Department.

Please note that telephone calls may be monitored and recorded to improve our service.

Installation and connection

Front view

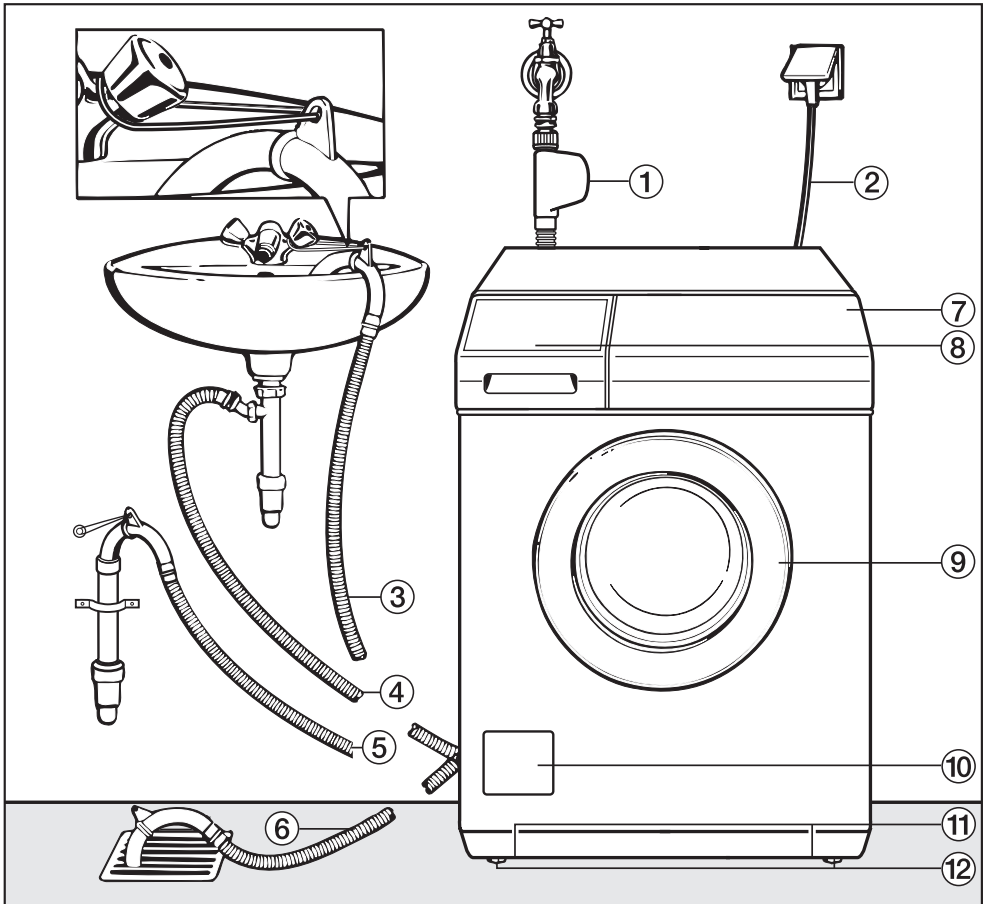

① Inlet hose with "Waterproof" system

② Electricity supply cable

③ - ⑥ Flexible drain hose (with detachable swivel elbow)

⑦ Facia panel with controls

⑧ Detergent dispenser drawer

⑨ Drum door

⑩ Access to drain filter, drain pump and emergency release

⑪ Handle recesses for moving the machine

⑫ Four height adjustable feet

Installation and connection

Rear view

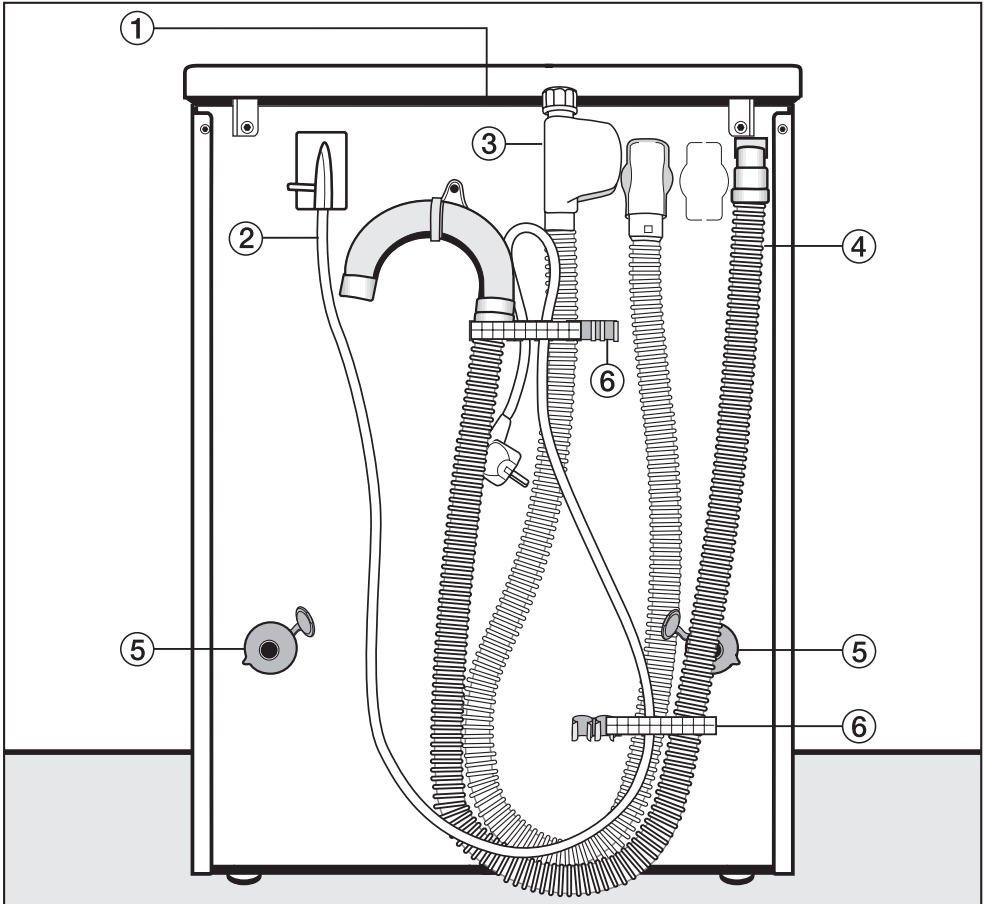

- ① Protruding edge for holding when moving the machine
- ② Electricity supply cable
- ③ Inlet hose with "Waterproof" system
- ④ Drainage hose

- ⑤ Transit bar covers
- ⑥ Restraining clip for:
 - Inlet hose
 - Drain hose
 - Electricity supply cable
 - Transit bars when removed

Installation surface

A concrete floor is the most suitable installation surface for a washing machine, being far less prone to vibration during the spin cycle than wooden floorboards or a carpeted surface.

Please note the following points:

- The machine must be level and securely positioned.
- To avoid vibrations during spinning, the machine should not be installed on soft floor coverings.

If installing on a wooden joist floor:

- We recommend a plywood base (at least 59x52x3 cm). The base should span several joists and be bolted to the joists and not only to the floorboards. Check for the presence of pipes and cables.

If possible, install the machine in a corner, as this is usually the most stable part of the floor.

⚠ If the machine is installed on a raised plinth, it **has to be secured** against slippage during spinning using retaining clips (available from the Miele Spare Parts Dept).

Installing the washing machine

To manoeuvre the machine out of its packing case to its installation site hold it by the edge of the lid where it protrudes to the rear of the washing machine as well as by the handle recesses at the front.

Please note:

- Do not lift the machine by the drum door.

⚠ Ensure that the machine feet and the floor are dry to prevent the machine from slipping during the spin cycle.

Removing the transit fittings

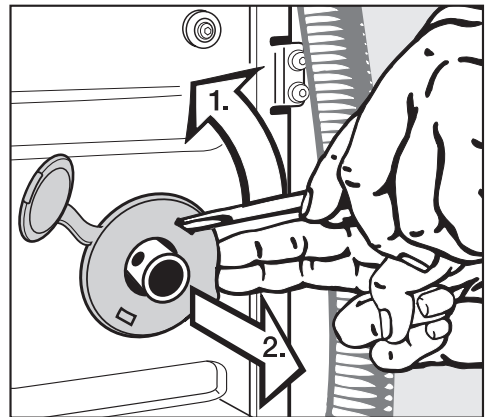

- To remove the left and right covers

1. Use a screwdriver to prise out the cover as illustrated.
2. Pull the cover forwards to remove.

Installation and connection

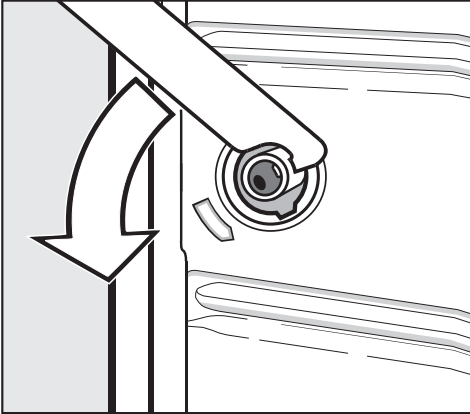

- Using the spanner supplied turn the left-hand transit bar 90°, then

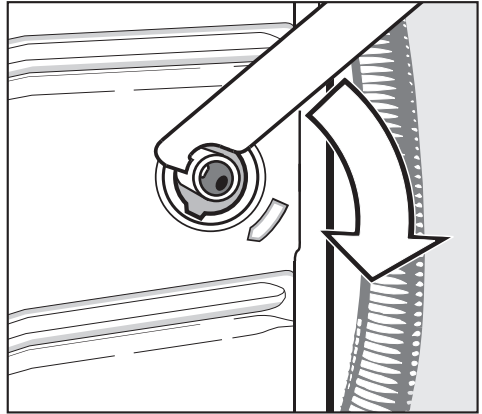

- Turn the right-hand transit bar 90°, then

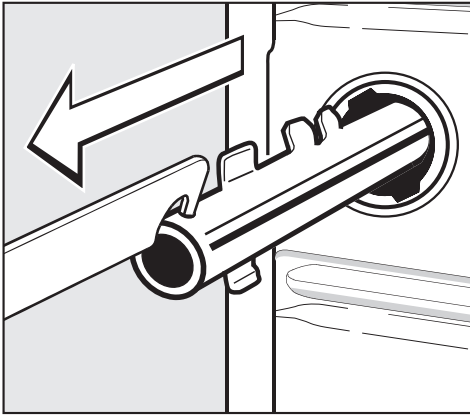

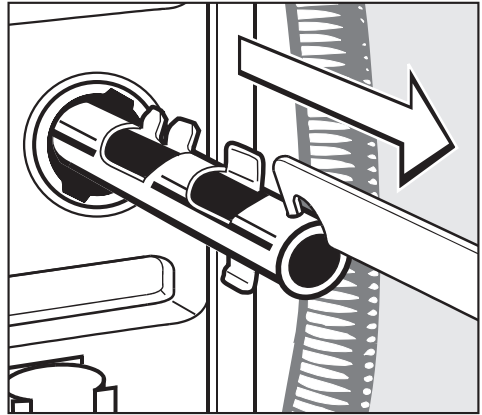

- withdraw the transit bar.

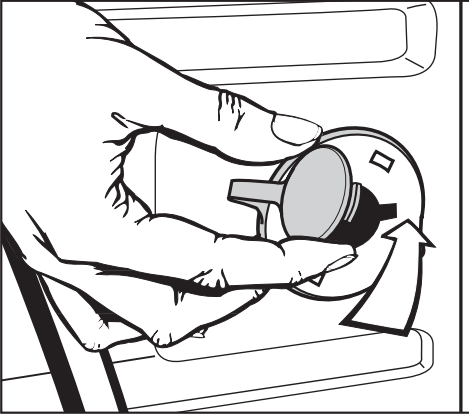

- withdraw the transit bar.

Installation and connection



 The washing machine must not be moved without the transit bars in place.

Store the transit bars as shown or keep them in a safe place for future use. They must be re-fitted if the machine is to be moved again (e.g. when moving house).

Re-fitting the transit bars

Re-fitting is carried out by reversing the procedure.

- Fit the covers on to the two holes. Then plug the holes as shown with the caps.

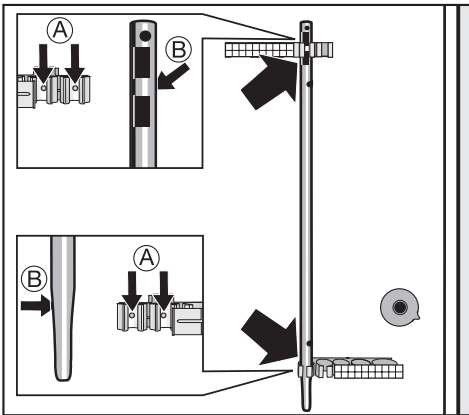

- Secure the transit bars to the back of the washing machine. Make sure that holes **B** are fitted over retainers **A**.

Installation and connection

Levelling the machine

The machine must stand perfectly level on all four feet to ensure safe and proper operation.

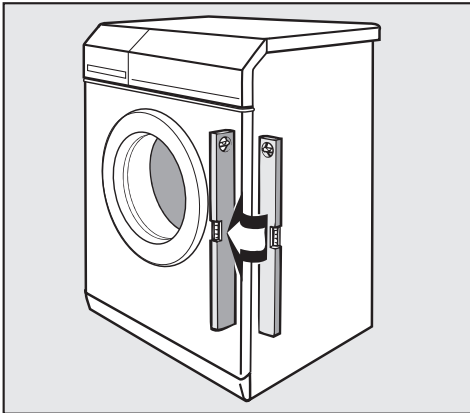

Incorrect installation may increase electricity and water consumption and may cause the machine to move about.

False values may also show in the Load and Detergent display.

Screwing out and adjusting the feet

The four adjustable screw feet are used to level the machine. All four feet are screwed in when the machine is delivered.

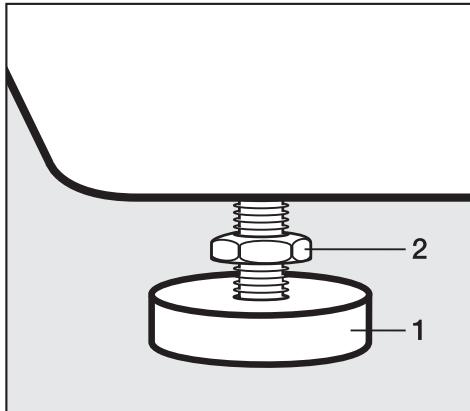

- Using the spanner supplied turn counter nut **2** in a clockwise direction. Then turn counter nut **2** together with foot **1** to unscrew.
- Use a spirit level to check the machine is standing level.
- Hold foot **1** securely with a pipe wrench. Turn counter nut **2** again using the spanner supplied until it sits firmly up against the housing.

 All four counternuts must be firmly up against the housing. Please also check this for the feet which did not need adjustment. Otherwise there is the danger of the machine moving about.

This washing machine is not suitable for building under a worktop.

Washer and Dryer stack

A Miele tumble dryer can be stacked with the washing machine. A stacking kit* is necessary and can be purchased from the Miele Spare Parts Department.

Please note:

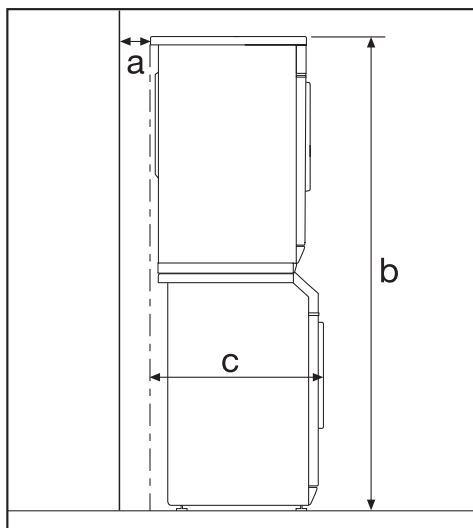

- a** Safety distance to wall:
at least 2 cm
- b** Height: Stacking kit with
pull-out shelf: approx. 172 cm
stacking kit without
pull-out shelf: approx. 170 cm
- c** Depth of the washer-dryer stack:
approx. 63 cm

Installation and connection

The Miele Waterproof system

The Miele Waterproof system protects the washing machine from water damage.

The system consists of three main components:

- 1) the inlet hose
- 2) the electronic unit and the washing machine housing
- 3) the drain hose

1) Inlet hose

- The inlet hose is fitted with an additional electrical safety valve which works like an automatic stopcock and is housed in the inlet hose connection box.
- It is pressure tested to between 7,000 and 10,000 kPa.
- The inlet hose has a protective sleeve.

Any leaking water from the inlet hose is fed into the sump through this protective sleeve. A float switches off the safety valve, preventing any more water from flowing into the machine and water in the suds container is pumped away.

2) Electronic unit and washing machine housing

- Sump

Any leaking water is collected in a sump in the base of the machine. A float switches off the safety valves, preventing any more water from flowing into the machine and water in the suds container is pumped away.

- Overflow protection

This prevents the washing machine taking in too much water. If the water level exceeds a certain level, the drain pump switches in and pumps the excess water away.

3) Drain hose

The drain hose is protected by a ventilation system which prevents the washing machine from being emptied completely.

Connection to the water supply

 The plastic casing of the safety valve contains electrical components. The Waterproof system must only be connected to its own stopcock. It must not be connected to mixer taps or similar and must not be fitted in areas where there is the risk of water or other liquids reaching it.

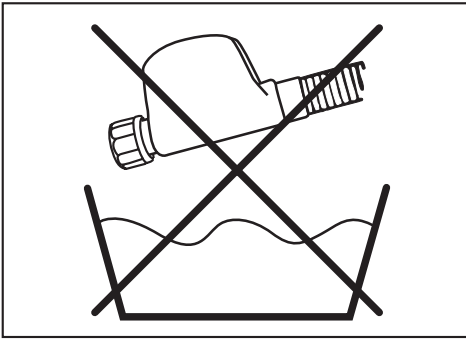

Do not get wet.

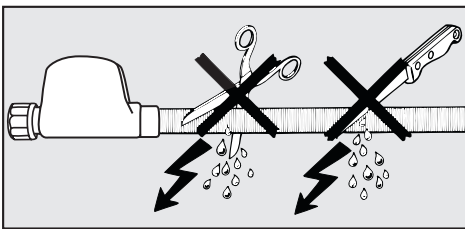

The protective sleeve of the hose must not be damaged or kinked.

The machine should be connected to a mains water supply in accordance with local and national safety regulations. The German authorities do not require it to have a non-return valve as the washing machine has been designed to comply with DIN regulations.

The machine is designed to operate with a flow pressure of between 100 and 1,000 kPa. If it is higher than 1,000 kPa it is essential to fit a reducer valve.

Connection to the mains water supply should incorporate a mains stopcock with $\frac{3}{4}$ " thread. The stopcock should be fitted by a qualified plumber.

 The connection point is subject to mains water pressure. Turn on the stopcock slowly and check for leaks. Correct the position of the washer and union if appropriate.

The washing machine is **not** suitable for connection to a hot water supply and connection to a household water softener is not recommended.

Installation and connection

Maintenance and care

If you intend to unscrew the Miele Waterproof system hose from the stopcock it is essential to disconnect the machine from the electricity supply first.

Only use a **Miele Waterproof system** hose should you need a replacement.

In order to protect the water inlet valve, the dirt filter in the water inlet valve connection must not be removed.

Extension hose

A 1.5 metre long (metal) extension hose is available from your Miele dealer or the Miele Spare Parts Department as an optional extra.

This hose is tested to withstand pressures of up to 14,000 kPa and can be used as a flexible extension to the water supply.

N.B. Using this hose renders the Waterproof system safety valve on the inlet hose ineffective.

Connection to the drainage system

The machine drains via a drain pump with a delivery head of 1 metre*.

The drain hose must not be kinked as this restricts drainage. The swivel elbow at the end of the hose can be turned in either direction, or can be detached if required, with a sharp twist and pull.

If required, the drain hose can be extended to a length of 5 m. The necessary parts can be purchased from the Miele Spare Parts Department or your Miele dealer.

* For a delivery head of more than 1 m (up to a maximum of 1.8 m) a second duo-drain pump is available with the corresponding kit from the Miele Spare Parts Department or your Miele Dealer.

Drain hose connection:

1. Direct into a sink or basin:

Please note the following

- Hook the hose over the edge and secure.
 - Make sure that the water can drain away freely without hindrance. Otherwise there is a risk of water overflowing or of some of the drained water being sucked back into the machine.
2. Connected securely to a plastic drain pipe with a rubber nipple. There is no need to use a non-return valve.
 3. Connected securely to a standpipe.
 4. Connected securely to a floor gully.

Installation and connection

Electrical connection U.K.

All electrical work should be carried out by a suitably qualified and competent person, in strict accordance with national and local safety regulations.

Ensure power is not supplied to the appliance until after installation work has been carried out.

The appliance is supplied with a mains cable with moulded plug ready for connection to a 230-240V mains supply. **The voltage and connected load are given on the data plate.**

Please ensure these match the household mains supply. The fuse rating is quoted on the plug.

Connection should be made via a suitable switched socket which is easily accessible after installation.

For extra safety it is advisable to install a residual current device (RCD), with a trip current of 30 mA (in accordance with DIN VDE 0664, VDE 0100 Section 739).

Do not connect via an extension lead. Extension leads do not guarantee the required safety of the appliance (e.g. danger of overheating).



Non-rewireable plugs BS 1363

The fuse cover must be refitted when changing the fuse, and if the fuse cover is lost, the plug must not be used until a suitable replacement is obtained. The colour of the correct replacement cover is that of the coloured insert in the base of the plug, or the colour that is embossed in words on the base of the plug (as applicable to the design of plug fitted).

Replacement fuses should be ASTA approved to BS 1362 and have the correct rating. Replacement fuses and fuse covers may be purchased from your local electrical supplier.

**WARNING: THIS APPLIANCE
MUST BE EARTHED**

Consumption data

	Load	Consumption data			
		Energy in kWh	Water in litres	Duration	
				Normal	Intensive
Cottons Hygiene					
95°C	5.0 kg	1.70	42	1 h 51 mins	2 h 06 mins
Cottons Universal					
60°C ¹⁾	5.0 kg	0.85	42	–	1 h 59 mins
60°C	5.0 kg	0.85	42	1 h 30 mins	1 h 59 mins
40°C ¹⁾	5.0 kg	0.49	42	–	1 h 59 mins
40°C	5.0 kg	0.49	42	1 h 30 mins	1 h 59 mins
Minimum iron					
40°C ¹⁾	2.5 kg	0.44	49	–	1 h 19 mins
40°C	2.5 kg	0.44	49	1 h 04 min	1 h 19 mins
Delicates					
30°C	1.0 kg	0.33	65	49 mins	59 mins
Silks 					
30°C	1.0 kg	0.24	39	36 mins	–
Woolens 					
30°C	2.0 kg	0.22	35	39 mins	–
Automatic					
40°C	3.0 kg	0.30 - 0.60	30 - 50	59 mins	1 h 14 mins
Quick wash					
40°C	2.5 kg	0.30	30	30 mins	–
Denim					
40°C	2.0 kg	0.50	45	1 h 00 min	–
Shirts					
60°C	1.5 kg	0.90	55	1 h 12 mins	–
Outer wear					
40°C	2.0 kg	0.43	57	1 h 03 mins	–

¹⁾EN 60456 test programme

Note for test institutes:

For testing in accordance with EN 60456 you must select the *Intensive Extra*.

Consumption data can vary from the nominal values given depending on water pressure, water hardness, water inlet temperature, room temperature, type and volume of load, fluctuations in the electricity supply and any Extras selected.

Technical data

Height	85.0 cm
Width	59.5 cm
Depth	58.0 cm
Depth with door open	97.5 cm
Weight	94 kg
Maximum floor load	1600 Newton (approx. 160 kg)
Capacity	5 kg dry laundry
Voltage	see data plate
Rated load	see data plate
Fuse rating	see data plate
Consumption data	see "Consumption data"
Water flow pressure minimum	100 kPa (1 bar)
Water flow pressure maximum	1000 kPa (10 bar)
Inlet hose length	1.60 m
Drain hose length	1.50 m
Connection cable length	1.60 m
Drain pump head max.	1.00 m
Drain pump length max.	5.00 m
Lamp for drum lighting	Type G4 (5 Watt/12 Volt)
Test certificates awarded	Radio / TV suppression, VDE

Settings menu for changing standard settings

The Settings menu is used to alter the washing machine's electronics to suit changing requirements.
Settings can be altered at any time.

Settings menu

To open the Settings menu



- Select *Settings*  from the entry menu and confirm your selection with the multi-function selector.

Select Settings

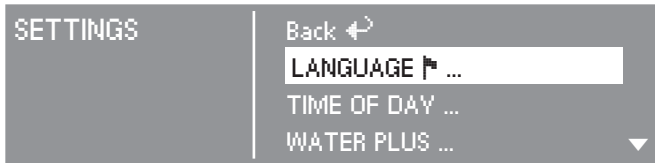

- Select the setting you want to change and confirm your selection.

If you do not make a selection in the sub-menu within approx. 20 seconds, the menu display will revert to the *Settings* menu.

Language

The display shows several different languages.

You can select one of the languages displayed via the *Languages*  sub-menu.

The flag after the word *Languages* acts as a guide to prevent a language which will not be understood from being set.

A tick will appear beside the language to show that it has been set.

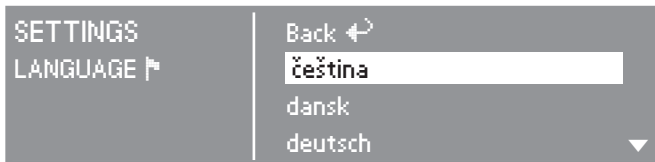

- Select the language you want and confirm your selection.

Time of day

First select either a 24 hour or 12 hour clock. Then set the current time of day.

To select a 24 hour or 12 hour clock.

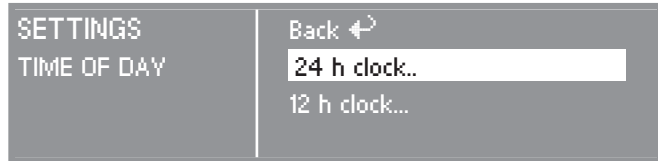

- Select the clock option you want and confirm your selection.

The display will then switch to the time of day setting.

To set the time of day

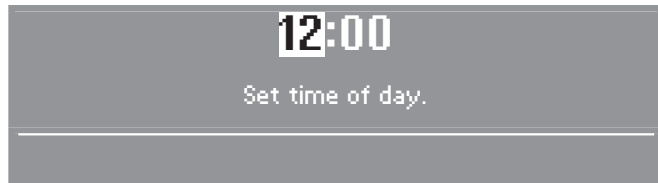

- Use the multi-function selector to select the hour and confirm your selection. Now set the minutes. Confirm the selection again to save the time of day in memory.

The time of day can be changed at any time later on by:



- Highlighting the time of day in the Settings menu and confirming your selection.

Settings menu

Water plus

This setting is used to select the water intake setting for the *Water plus* Extra option.

There are three different options:

Water +

The water intake is increased in the wash and rinse stages of the programmes (the washing machine is delivered with this setting programmed as standard).

Additional rinse

An additional rinse is introduced in the *Cottons Hygiene*, *Cottons Universal*, *Minimum iron*, *Automatic*, *Quick wash* and *Silks* programmes.

Water + and Additional rinse

- The water intake is increased in the wash and rinse stages and an additional rinse is also introduced in the *Cottons Hygiene*, *Cottons Universal*, *Minimum iron*, *Automatic*, *Quick wash* and *Silks* programmes.

A tick will appear beside the option to show that it has been set.

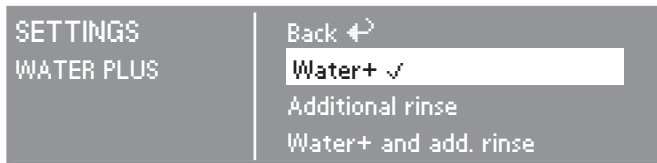

- Select the option you want and confirm your selection.

Gentle action

Activating gentle action reduces the drum action and is suitable for washing slightly soiled items more gently.

Gentle action can be activated for the *Cottons Hygiene*, *Cottons Universal* and the *Minimum iron* programmes.

- The washing machine is delivered with the *Gentle action* setting deactivated.

A tick will appear beside the option to show that it has been set.

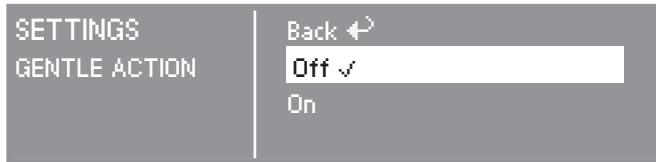

- Select the option you want and confirm your selection.

Suds cooling

When this is activated, additional water flows into the drum at the end of the main wash to cool the suds down. Hot suds can damage plastic drainage pipes.

Suds cooling takes place when the *Cottons Hygiene* programme is selected.

Suds cooling should be activated:

- to prevent the danger of scalding if the drain hose is hooked over the edge of a sink or basin.
- where the drainage pipes do not comply with DIN 1986.

The washing machine is delivered with Suds cooling deactivated.

A tick will appear beside the option to show that it has been set.

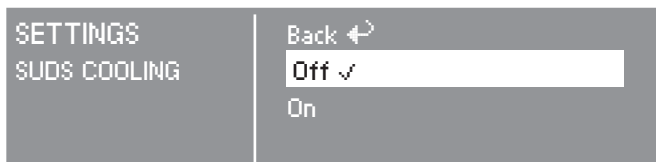

Select the option you want and confirm your selection.

Settings menu 🚩

Lock

The system lock prevents your machine being used without your knowledge.

When the system lock has been activated, you have to enter a code after switching the washing machine on. Otherwise the washing machine cannot be operated.

To activate the lock

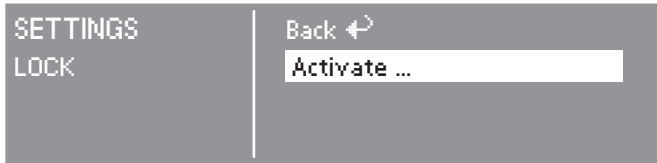

- Select *activate* and confirm your selection.

To enter the lock code

The display will now request that a code is entered. The code is **125** and cannot be altered.

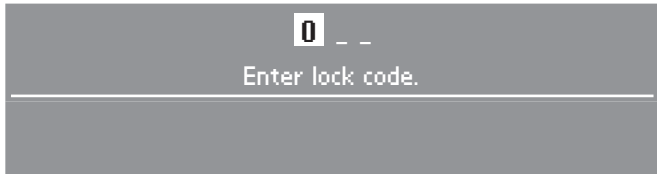

- Turn the multi-function selector until the number **1** appears. Confirm your selection of this number. Now set the second number.

Repeat the process until all three numbers have been entered.

After the last number has been entered, you must confirm the code with OK.

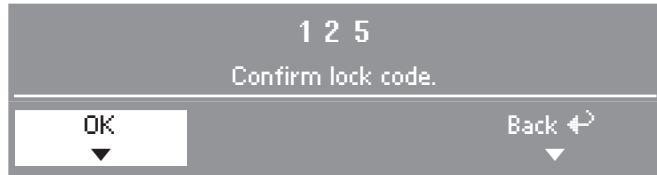

- Confirm lock code by pressing short cut button .



- Switch the washing machine off.

To unlock the washing machine

When the washing machine is switched on again, the display will request the lock code.

- Enter lock code **125** as described above and confirm the entry.

To deactivate the lock

Proceed as for activating the lock.

Settings menu 🏠

Temperature

You can choose for the temperature to be displayed as °C/Celsius or °F/Fahrenheit.

A tick will appear beside the option to show that it has been set.

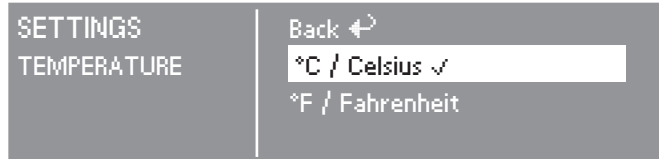

- Select the option you want and confirm your selection.

Buzzer

When the buzzer function has been activated, an audible tone sounds at the end of a programme or when Rinse hold is reached.

There are three different options:

Off = the buzzer is switched off but sounds at maximum volume if there is a fault (the washing machine is delivered with this option set as standard).

Normal = the buzzer sounds at the end of a programme or when Rinse hold is reached.

Loud = the buzzer sounds louder at the end of a programme or when Rinse hold is reached.

A tick will appear beside the option to show that it has been set.

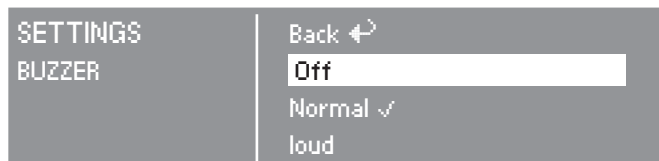

- Select the option you want and confirm your selection.

Keypad tones

An audible tone sounds when the *Start* button, a short cut button or the multi-function selector is pressed.

The washing machine is delivered with the keypad tone switched off.

A tick will appear beside the option to show that it has been set.

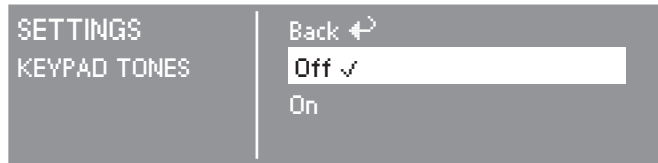

- Select the option you want and confirm your selection.

Display contrast

There are ten different display contrast settings.

The machine is delivered with the display contrast on Setting 5.

The display contrast will change as soon as a different setting is chosen.



- Set the display contrast you require.

Settings menu

Stand-by

To save energy, the display goes out after 10 minutes and the *Start* button flashes slowly.

There are two options:

On

Stand-by comes on:

- if a programme is not selected after the machine has been switched on.
- after a programme has started.
- at the end of a programme.

Not in current Prog. (the machine is delivered with this option selected)

Stand-by comes on:

- if a programme is not selected after the machine has been switched on.

Operating the multi-function selector or one of the short cut buttons switches the display back on again.

A tick will appear beside the option to show that it has been set.

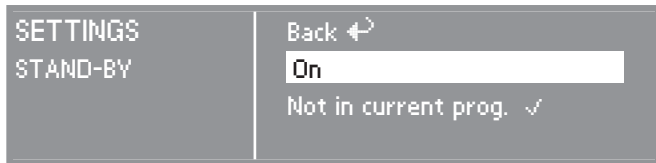

- Select the option you want and confirm your selection.

Memory

If an Extra has been selected for a programme, or the recommended temperature or spin speed has been altered, the machine will store the changes in memory at the start of a programme.

The next time this programme is selected these settings will appear in the *Programme selection* menu.

The memory function is not active when favourite programmes are selected using the short cut buttons.

The machine is delivered with the memory function deactivated.

A tick will appear beside the option to show that it has been set.

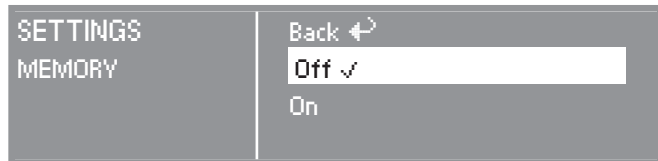

- Select the option you want and confirm your selection.

Miele@home

The Miele@home setting is not activated on this machine. It is not possible to retro-fit it for Miele@home either.

To close the Settings menu

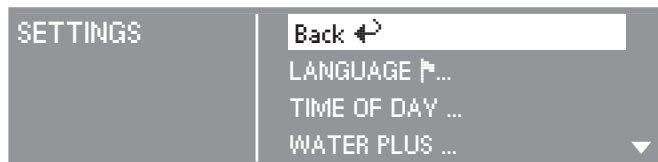

Select *Back* and confirm your selection. The display will return to the entry menu.

United Kingdom:

Miele Co. Ltd.
Fairacres, Marcham Road
Abingdon, Oxon, OX14 1TW
tel. Abingdon (01235) 554455
Service Office: (01235) 554466
fax (01235) 554477
Internet: www.miele.co.uk

Ireland:

Miele Ireland Ltd.
Broomhill Road, Tallaght, Dublin 24
Tel: (01) 46 10 710, Fax: (01) 46 10 797
Email: info@miele.ie
Internet: <http://www.miele.ie>

Australia:

Miele Australia Pty. Ltd.
A.C.N. 005635398
1 Gilbert Park Drive
Knoxfield, VIC 3180
Telephone: (03) 9764 7100
Fax: (03) 9764 7129
Internet: www.miele.com.au

Distributor New Zealand:

Steelfort Engineering Company. Ltd.
500 Rangitikei Street
Palmerston North, Priv. Bag 11045, NZ
Telephone: (06) 350 1350
Fax: (06) 356 1507

South Africa:

Miele (Pty) Ltd
63 Peter Place
Bryanston 2194
P.O. Box 69434
Bryanston 2021
Tel.: (011) 548 1900
Telefax (011) 548 1935
Internet: www.miele.co.za
E-mail: info@miele.co.za

Singapore:

Miele Southeast Asia
Miele Pte. Ltd.
163 Penang Road
04 - 02/03 Winsland House II
Singapore 238463
Tel : +65-67351191
Fax: +65-67351161
Email: infosea@miele.com.sg

Hong Kong:

Miele (Hong Kong) Limited
AIA Plaza, 24th Floor
18 Hysan Avenue
Causeway Bay
Hong Kong
Tel.: (852) 2610 1331
Fax: (852) 2610 1013
E-mail: mielehk@miele.com.hk

Free Manuals Download Website

<http://myh66.com>

<http://usermanuals.us>

<http://www.somanuals.com>

<http://www.4manuals.cc>

<http://www.manual-lib.com>

<http://www.404manual.com>

<http://www.luxmanual.com>

<http://aubethermostatmanual.com>

Golf course search by state

<http://golfingnear.com>

Email search by domain

<http://emailbydomain.com>

Auto manuals search

<http://auto.somanuals.com>

TV manuals search

<http://tv.somanuals.com>