

Millennium *Stereo One-Fifty*

Integrated Modeling Amplifier

Johnson
Amplification

User's Guide

Please visit Johnson Amplification on the World Wide Web at <http://www.digitech.com>

H A Harman International Company

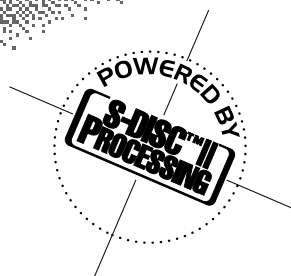



CAUTION

RISK OF ELECTRIC SHOCK
DO NOT OPEN



ATTENTION: RISQUE DE CHOC ELECTRIQUE - NE PAS OUVRIR

WARNING: TO REDUCE THE RISK OF FIRE OR ELECTRIC SHOCK DO NOT EXPOSE THIS EQUIPMENT TO RAIN OR MOISTURE

The symbols shown above are internationally accepted symbols that warn of potential hazards with electrical products. The lightning flash with arrowpoint in an equilateral triangle means that there are dangerous voltages present within the unit. The exclamation point in an equilateral triangle indicates that it is necessary for the user to refer to the owner's manual.

These symbols warn that there are no user serviceable parts inside the unit. Do not open the unit. Do not attempt to service the unit yourself. Refer all servicing to qualified personnel. Opening the chassis for any reason will void the manufacturer's warranty. Do not get the unit wet. If liquid is spilled on the unit, shut it off immediately and take it to a dealer for service. Disconnect the unit during storms to prevent damage.

WARNING

FOR YOUR PROTECTION, PLEASE READ THE FOLLOWING:

WATER AND MOISTURE: Appliance should not be used near water (e.g. near a bathtub, washbowl, kitchen sink, laundry tub, in a wet basement, or near a swimming pool, etc). Care should be taken so that objects do not fall and liquids are not spilled into the enclosure through openings.

POWER SOURCES: The appliance should be connected to a power supply only of the type described in the operating instructions or as marked on the appliance.

GROUNDING OR POLARIZATION: Precautions should be taken so that the grounding or polarization means of an appliance is not defeated.

POWER CORD PROTECTION: Power supply cords should be routed so that they are not likely to be walked on or pinched by items placed upon or against them, paying particular attention to cords at plugs, convenience receptacles, and the point where they exit from the appliance.

SERVICING: To reduce the risk of fire or electric shock, the user should not attempt to service the appliance beyond that described in the operating instructions. All other servicing should be referred to qualified service personnel.

FOR UNITS EQUIPPED WITH EXTERNALLY ACCESSIBLE FUSE RECEPTACLE: Replace fuse with same type and rating only.

U.K. MAINS PLUG WARNING

A moulded mains plug that has been cut off from the cord is unsafe. Discard the mains plug at a suitable disposal facility. **NEVER UNDER ANY CIRCUMSTANCES SHOULD YOU INSERT A DAMAGED OR CUT MAINS PLUG INTO A 13 AMP POWER SOCKET.** Do not use the mains plug without the fuse cover in place. Replacement fuse covers can be obtained from your local retailer. Replacement fuses are 13 amps and **MUST** be ASTA approved to BS1362.

ELECTROMAGNETIC COMPATIBILITY

This unit conforms to the Product Specifications noted on the **Declaration of Conformity**. Operation is subject to the following two conditions:

- this device may not cause harmful interference, and
- this device must accept any interference received, including interference that may cause undesired operation. Operation of this unit within significant electromagnetic fields should be avoided.
- use only shielded interconnecting cables.

SAFETY INSTRUCTIONS

NOTICE FOR CUSTOMERS IF YOUR UNIT IS EQUIPPED WITH A POWER CORD.

WARNING: THIS APPLIANCE MUST BE EARTHED.

The cores in the mains lead are coloured in accordance with the following code:

GREEN and YELLOW - Earth BLUE - Neutral BROWN - Live

As colours of the cores in the mains lead of this appliance may not correspond with the coloured markings identifying the terminals in your plug, proceed as follows:

- The core which is coloured green and yellow must be connected to the terminal in the plug marked with the letter E, or with the earth symbol, or coloured green, or green and yellow.
- The core which is coloured blue must be connected to the terminal marked N or coloured black.
- The core which is coloured brown must be connected to the terminal marked L or coloured red.

This equipment may require the use of a different line cord, attachment plug, or both, depending on the available power source at installation. If the attachment plug needs to be changed, refer servicing to qualified service personnel who should refer to the table below. The green/yellow wire shall be connected directly to the unit's chassis.

CONDUCTOR		WIRE COLOR	
L	Line	Brown	Black
N	Neutral	Blue	White
	Earth Grnd.	Green/Yel.	Green

WARNING: If the ground is defeated, certain fault conditions in the unit or in the system to which it is connected can result in full line voltage between chassis and earth ground. Severe injury or death can then result if the chassis and earth ground are touched simultaneously.

LITHIUM BATTERY WARNING

CAUTION!

This product may contain a lithium battery. There is danger of explosion if the battery is incorrectly replaced. Replace only with an Eveready CR 2032 or equivalent. Make sure the battery is installed with the correct polarity. Discard used batteries according to manufacturer's instructions.

ADVARSEL!

Lithiumbatteri - Eksplosjonsfare. Ved utskifting benyttes kun batteri som anbefalt av apparatfabrikanten. Brukt batteri returneres apparatleverandøren.

ADVARSEL!

Lithiumbatteri - Eksplosjonsfare ved feilagtig håndtering. Utskiftning må kun ske med batteri av samme fabrikat og type. Levér det brukte batteri tilbake til leverandøren.

VAROITUS!

Paristo voi räjähtää, jos se on virheellisesti asennettu. Vaihda paristo ainoastaan laitevalmistajan suosittelemaan tyyppiin. Hävitä käytetty paristo valmistajan ohjeiden mukaisesti.

WARNING!

Explosionsfara vid felaktigt batteribyte. Använd samma batterityp eller en ekvivalent typ som rekommenderas av apparatillverkaren. Kassera använt batteri enligt fabrikantens instruktion.

DECLARATION OF CONFORMITY

Manufacturer's Name: ***Johnson Amplification***
Manufacturer's Address: 8760 S. Sandy Parkway
Sandy, Utah 84070, USA

declares that the product:
Product Name: ***Johnson Millennium Stereo 150***
Product Options: All

conforms to the following Product Specifications:

Safety: EN 60065 (1993)
IEC 65 (1985) with Amendments 1, 2 & 3

EMC: EN 55013 (1990)
EN 55020 (1991)

Supplementary Information:

The product herewith complies with the requirements of the Low Voltage Directive 73/23/EEC and EMC Directive 89/336/EEC as amended by Directive 93/68/EEC.

Johnson Amplification

President of Johnson Amplification
8760 S. Sandy Parkway
Sandy, Utah 84070, USA
Tel: 801.566.8800
Fax: 801.566.7005

Effective June 15, 1997

European Contact: Your Local Johnson Amplification Sales and Service Office or

International Sales Office
3 Overlook Drive #4
Amherst, New Hampshire 03031, USA
Tel: 603.672.4244
Fax: 603.672.4246

Quick Start

For those of you who prefer to burn now and read later, we've included this Quick Start section to get you up and running.

Connect Cables:

Connect guitar into the **Bright** or **Normal** input jacks. If an extension cabinet is to be used, connect an un-shielded speaker cable to the extension speaker cabinet output (located on the rear panel of the Millennium) and run into the desired extension speaker cabinet (such as the Johnson Amplification 2-12 HB) with a 4ohm minimum requirement per channel .

Connect J-3 Multi-Function Footswitch:

Connect the included J-3 Footswitch to the J-3 insert on the rear panel of the Millennium. The three footswitches can be programmed to perform several functions. From the factory, the footswitches will A-B Channel Switch and change presets Up and Down.

Connect Johnson Amplification J-12 Foot Controller (if applicable)

Connect the output of the optional Johnson Amplification J-12 to the Foot Controller jack found on the rear of the Millennium. Make sure that connection is made before applying power to the Millennium.

WARNING: DO NOT CONNECT ANYTHING BUT THE OPTIONAL JOHNSON AMPLIFICATION J-12 FOOT CONTROLLER TO THE FOOT CONTROLLER JACK ON THE REAR PANEL! DOING SO MAY DAMAGE THE DEVICE.

MIDI control of the Millennium can be done by connecting MIDI controller devices to the MIDI In jack on the rear panel.

Apply Power:

Note: When applying power to the Millennium, it is recommended that the **<Input>** and **<Master Volume>** be turned down prior to powering up the unit.

Adjust Input and Output:

Use the **<Input>** level knob on the front panel to adjust the Input level, so that the loudest guitar signal occasionally lights the clip LED indicator. Now adjust the **<Master Volume>** level knob on the front panel of the Millennium to the desired output level .

Select Preset:

Begin playing your guitar, and choose any preset using the **<Preset/Effect>** wheel. User Presets 1-100 are duplicates of the Factory Presets. They are user-programmable. You can modify and store them as you want. Factory Presets 1-100 are not user-programmable and cannot be overwritten.

Table of Contents

Safety Information
 Declaration of Conformity.....i
 Quick Start.....ii
 Table of Contentsiii

Section 1 - Introduction

Congratulations1
 Included Items.....1
 Product Features1
 Warranty2
A Quick Tour of the Millennium.....3
 The Front Panel.....3
 The Rear Panel.....7
 Integrated Amplifier Modeling8
 A-B channel switching8
 The Digital Effects Section9
 Digital Effects9
 Real-Time Modifiers9
 Basic Specs10
 Programmable FX Loop10
 Signal Flow.....10
 Foot Controller Compatibility.....11
 Module Types12
 Module Sizes12

Section 2 - Setting Up

Making Connections13
 Millennium into Extension Speaker Cabinets13
 Millennium direct with the XLR Programmable Speaker Cabinet
 Emulator14
Getting Around the Operating System.....15
 Preset Mode.....15
 FX Edit Mode.....15
 Utility Mode.....15
 Assign Mode15
Getting Sounds16
Selecting A Preset19
Using the Tuner.....19

Section 3 - Editing Presets

Naming/Storing Presets21
Editing a Preset23
 Editing Integrated Amplifier Modules23
 Editing the Analog Wah Module25
 Editing the Noise Gate module.....26
 Selecting FX Configurations27
 Editing Digital FX27
 Changing Effect Modules28
 Selecting Effect Defaults28
 Adjusting FX Module Parameters28
 Custom Defaults28
 Comparing Changes29

Section 4 - Editing Modules

Storing/Naming Defaults	30
Editing a Module	31
Output Module Functions.....	32
Effect Module Size and Type List	33
Effect Default List	34
Effect Library	35
Amplifier Section	
Analog Wah	35
Amplifier Models	35
Noise Gate	36
Digital Effects Section	
Reverbs	37
Chorus & Flangers.....	40
Phasers	44
Rotary Speaker Simulator	45
Tremolo & Auto Panner	46
Pitch Shifters	47
Detuners	48
Delays	50
Equalizers	51
Multi Effect Modules	53
Whammy Effects	54
Auto Wah	55

Section 5 - Advanced Topics

Assigning Modifiers	56
MIDI CC.....	56
LFO	56
Dynamic.....	56
External Expression Pedals	57
Linking a Parameter to a Modifier	57
Setting up an LFO and a Dynamic Modifier	58
Morphing Pedal Assignments	59
Volume Pedal Assignment.....	60
MIDI Functions	
MIDI Channels	62
MIDI Merging	62
MIDI Receive Map	62
MIDI Transmit Map.....	62
SysEx Device Channels	63
SysEx Dumps.....	64
Preset Dump	64
Bulk Dump	65
System Dump	65
Other Utility Functions	
Resetting to Factory Settings.....	66
Global-Local Cabinet Emulator.....	66
Output Mode.....	67
J-3 Footswitch Set-Up	67

Section 6 - Using the Johnson Amplification J-12 Foot Controller

Configuring the Pedalboard68
 Connecting the J-1268
 Expression Pedal Names68
 Assigning Functions69
 Preset to Footswitches69
 Parameters to Footswitches/Expression Pedal70
 Other Footswitch Functions71
 Assigning MIDI Control to the Exp. Pedal71
 Toggle MIDI CC71
 Assigning CC Numbers to Expression Pedals72
 CC Transmit Channel73
 Other Pedalboard Tidbits75
 Bank Up/Tuner & Bank Down/Bypass Footswitches.....75
 Using the Tuner75
 Naming Banks75
 Un-Linking or Viewing Assignments76

Section 7 - Appendix

Factory Preset List77
 Preset Descriptions79
 Effect Configuration Chart85
 Harmony Interval Charts.....86
 Specifications.....87
 MIDI Implementation Chart88

SysEx Implementation Guide89
 MIDI Basics89
 General Format90
 Procedures90
 Request One Preset - 01(h)91
 Receive One Preset - 42(h)91
 Request Bulk Dump - 49(h)91
 Receive Bulk Dump - 57(h)91
 Request Utility Settings - 11(h)91
 Receive Utility Settings - 12(h)92
 Request Parameter Value - 17(h)92
 Receive Parameter Value - 18(h)92
 Request All Current Parameter Values - 23(h)92
 Receive All Current Parameter Values for current preset ...93
 Request Module Configuration-25(h)93
 Respond Module Configuration-26(h)93
 Receive Key Scan Code - 54(h)94
 Receive Key Accepted - 56(h)94
 Select One Preset - 1F(h).....94
 Reset Preset - 20(h)95
 Reset Device - 21(h).....95
 Reset Factory Settings - 22(h)95
 Request User Defaults - 13(h)95
 Receive User Defaults - 14(h)95
 Key Scan Codes96
 SysEx Preset Dump Example97
 FX Modules and Parameter Codes98

Section-1 Introduction

Congratulations...

... you are now the proud owner of a Johnson Millennium Stereo 150 Amplifier, the most powerful, flexible, and easy-to-use Integrated Modeling Amplifier ever produced. Your Millennium has set the new standard for all other Amplifiers/Multi-effect processors to follow.

This owner's manual is your key to understanding the powerful world of the Millennium. Read it carefully. After you've had time to familiarize yourself with the unit, try experimenting with unusual effect combinations. You are certain to achieve sounds never thought possible before. Good luck, and thank you for choosing Johnson Amplification.

Your Millennium was carefully assembled and packaged at the factory. Before you proceed any further, make sure the following items are included:

- *(1) Owner's Manual*
- *(1) Johnson Amplification Millennium Stereo 150 Amplifier*
- *(1) J-3 Multi-Function Footswitch*
- *(1) Johnson Amplification warranty card*

Please save all packing materials. They were designed to protect the unit from damage during shipping. In the unlikely event that the unit requires service, use only the factory supplied carton to return the unit.

Millennium Features:

- *150 Watts (75 per side) power- amp section*
- *2 - Vintage 30 Celestion speakers*
- *Exclusive Johnson Amplification Integrated Amplifier Modeling which instantly lets you access the some of most popular Vintage and Modern Amplifier types available*
- *Dual Tube Preamp (12AX7)*
- *Full bandwidth effects (20-20kHz)*
- *24-bit signal path, 48-bit internal data path*
- *Up to 4 digital effects at once*
- *S-DISC II ® Processing*
- *Flexible, easy-to-use effect routing*
- *Effects can be repeated in a chain, (e.g. EQ + flange + EQ + pitch shift)*
- *Instant module access*
- *Exclusive Dynamic Parameter Control*
- *Programmable Speaker Cabinet Emulator XLR outputs*
- *Chromatic tuner*
- *Full MIDI Implementation*
- *All effects and parameters available for MIDI continuous control*
- *2 Expression Pedal insertion jacks to add external CC pedals for additional assigning options*
- *A-B Channel switching*
- *J-3 Multi-function footswitch (included)*
- *Upgradable System Software (via the MIDI In port)*
- *Optional Johnson Amplification J-12 foot controller with 2 built-in Expression Pedals for ultimate programmability and control.*

We at **Johnson Amplification** are very proud of our products and back-up each one we sell with the following *warranty*:

1. *The warranty registration card must be mailed within ten days after purchase date to validate this warranty.*
2. *Johnson Amplification warrants this product, when used solely within the U.S., to be free from defects in materials and workmanship under normal use and service.*
3. *Johnson Amplification liability under this warranty is limited to repairing or replacing defective materials that show evidence of defect, provided the product is returned to Johnson Amplification WITH RETURN AUTHORIZATION, where all parts and labor will be covered up to a period of one year. A Return Authorization number may be obtained from Johnson Amplification by telephone. The company shall not be liable for any consequential damage as a result of the product's use in any circuit or assembly.*
4. *Proof-of-purchase is considered to be the burden of the consumer.*
5. *Johnson Amplification reserves the right to make changes in design, or make additions to, or improvements upon this product without incurring any obligation to install the same on products previously manufactured.*
6. *The consumer forfeits the benefits of this warranty if the product's main assembly is opened and tampered with by anyone other than a certified Johnson Amplification technician or, if the product is used with AC voltages outside of the range suggested by the manufacturer.*
7. *The foregoing is in lieu of all other warranties, expressed or implied, and Johnson Amplification neither assumes nor authorizes any person to assume any obligation or liability in connection with the sale of this product. In no event shall Johnson Amplification or its dealers be liable for special or consequential damages or from any delay in the performance of this warranty due to causes beyond their control.*

Johnson Amplification™, S-DISCII™, Whammy™, and Silencer II™ are registered trademarks of the Harman Music Group Incorporated.

NOTE: The information contained in this manual is subject to change at any time without notification. Some information contained in this manual may also be inaccurate due to undocumented changes in the product or operating system since this version of the manual was completed. The information contained in this version of the owner's manual supersedes all previous versions.

A Quick Tour of the Millennium

The Front Panel

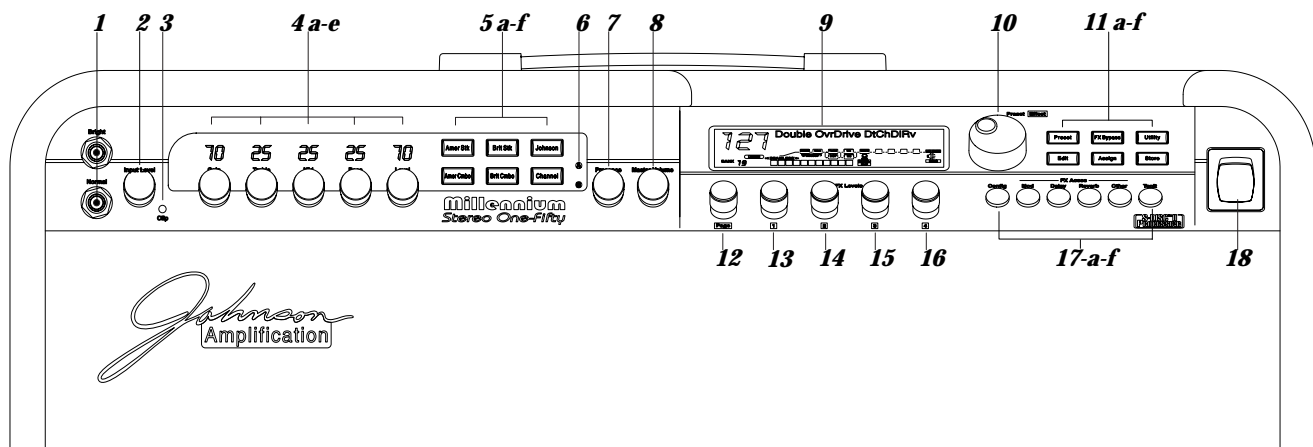

1) **Bright and Normal Inputs** - The 1/4" inputs of the Millennium allow you to select between Bright (top) and Normal (bottom). The Bright produces a slightly brighter sound, where as the Normal input provides a normal input color.

2) **Input level Control** - This knob controls the overall input level of the Millennium. A recommended setting for this knob would be to turn the level up enough so that the Millennium clip LED occasionally lights.

3) **Clip LED**- This Clip LED tells you that the input level is set too high and there is internal input level clipping.

4) **Amp Controls**- These 5 knobs control all of the Amplifier EQs and levels. These controls are as follows:

4a) **Gain** - This knob controls the overall distortion gain level of the Amplifier models that use distortions, and controls the volume of Amplifier Models that have clean tones. Values range from 0.0 to 10.

4b) **Treble** - This knob is used to control the Treble frequency of the selected preset. Values range from 0.0 to 10.

4c) **Mid** - This knob is used to control the Mid frequency of the selected preset. Values range from 0.0 to 10.

4d) **Bass** - This knob is used to control the Bass frequency of the selected preset. Values range 0.0 to 10.

Amplifier EQ Note: Due to the special Integrated Amplifier Modeling features of the Millennium, every time a different Integrated Amplifier model is called up, the EQs take on the characteristics of the selected Amplifier Models. Some the Amplifier Models that use do not certain tones controls, have a dash in the display, indicating that the frequency is not used.

4e) **Level** - This knob is used to control the overall output level of the preset. Values range from 0.0 to 10.

5) Amplifier Model Buttons- These buttons let you instantly select (and move through the menu of the d Amplifier model with successive presses) one of the many Modeled Amplifiers and switch channels within the selected Amplifier setting. The buttons are as follows:

5a) American Stack - This button is used to instantly call up the American Stack Amplifier modules.

5b) British Stack - This button is used to instantly call up the British Stack Amplifier modules.

5c) Johnson - This button is used to instantly call up the Johnson Amplifier Custom amplifier modules.

5d) American Combo - This button is used to instantly call up the American Combo amplifier modules.

5e) British Combo - This is used to call up the British Combo Amp modules.

5f) A-B Channel switcher - This button allows you to channel switch within the selected Amplifier modules.

6) A-B Channel LED indicators - These two LEDs indicate which channel of the selected Amplifier Model is being used.

7) Contour Control - This knob is used to control the tone contour within the Power Amp section of the Millennium.

8) Master Output - This knob is used to control the overall output of the Millennium.

9) Display - This large custom display is where you receive most of the information you need to optimize performance of the Millennium. This display has several functions and they are as follows:

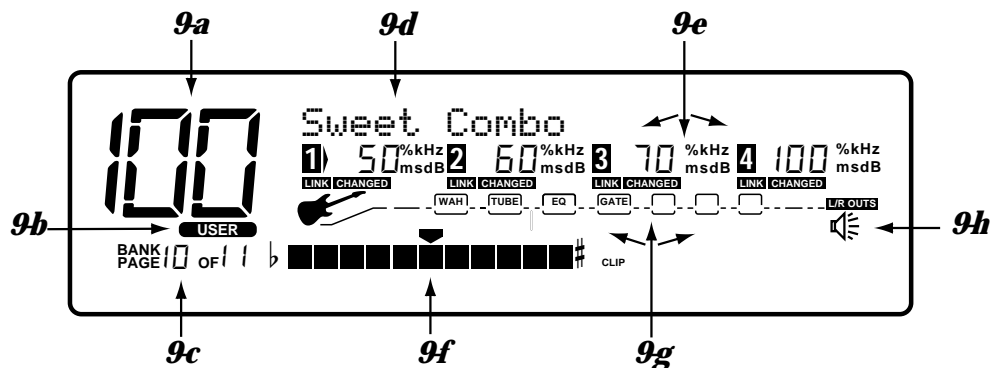

9a) Preset Number - The three large digits located in the upper left corner of the display indicate which Preset is currently selected. This indicator will also display the currently selected note while the Millennium is in Tuner Mode.

9b) Factory / User indicators - Located directly below the Preset number, the Factory and User preset icons indicate whether the current preset resides in the Factory or User Bank. To toggle between the Factory and User Presets simply press the <Preset> button.

9c) Bank / Page Indicators - Located in the bottom left hand corner of the display, the Bank/Page indicators display:

- The J-12 Bank number in which the current program resides in Preset Mode (*Note: This is only displayed when the Johnson Amplification J-12 foot controller is connected*).
- The page which is currently selected in various editing modes.

9d) Information Line - The row of 24 characters in the top line of the display indicates more detailed information about specific functions and items such as: Preset names, Parameter names and Utility information.

9e) Parameter Data Sections - Immediately below the information line, are four parameter data sections. They correspond with knobs <1> through <4> on the front panel. Each section displays the current value of the indicated parameter.

A **LINK** icon in each group tells whether the indicated Parameter is linked for expression control. When a parameter has been modified, the **CHANGED** icon will appear under the parameter that has been modified and the <Store> button will light to indicate a change has been made to the preset, but not stored.

9f) Input Level / Clip Meters / Tune Indicator- An Input Level and Clip meter is located in the bottom center of the display. This meter shows the guitar signal level, and uses a peak detector action to display the highest levels at the input. The **CLIP** icon at the end of the meter, indicates if the the input signal is being clipped at the Analog input section (pre-digital). The **DIGITAL CLIP** icon indicates that there is clipping in the digital effects domain. This meter is also used to show note activity while the Millennium is in Tuner Mode

9g) Effect Routing Matrix - The Effect Routing Matrix shows the signal flow of the currently selected preset through the amp and effect sections. This matrix includes boxes that represent each effect module along with lines that indicate how those effects are connected to inputs, outputs and each other. If an effect module is bypassed, a line appears through that module's box in the Matrix.

**When in FX Edit mode, the box that represents the currently selected effect module will flash.*

9h) Speaker Cabinet Emulator Icon - When the **SPEAKER** icon appears in the display, this indicates that the Speaker Cabinet Simulator is engaged in the XLR outputs located on the rear panel.

10) Preset/Effect Wheel - Changes Presets (in Preset Mode) or selects effect modules (in FX Edit Mode).

11 a-f) Function Buttons - These 6 buttons are used for primary function and edits of the Millennium. Their functions are as follows:

11a) Preset Button - This button always puts the Millennium in Preset mode with a single press. Pressing the Preset button while in Preset mode twice toggles between User and Factory presets.

11b) FX Bypass - This button bypasses all digital effects in the Millennium.

11c) Utility - This button enters the Utility mode of the Millennium.

11d) FX Edit - When pressed, the Millennium enters the Wah module or the last edited module.

11e) Assign - This button is used to assign parameters to the J-12 footswitches, MIDI control and dynamic modifiers.

11f) Store - This button is used to copy and/or store and name modified presets.

12) Mix/Page Knob - This button controls the effect mix level of the Millennium when it is in Preset mode. When the Millennium is in Edit or Utility mode, this button takes you to the next or previous page of the selected menu.

- 13) Speed/1 Knob** - This knob controls the Speed of modulation effects when the unit is in Preset mode. In Edit or Utility mode, it controls the number 1 parameter that appears in the display.
- 14) Depth/2 Knob** - This knob controls the Depth of modulation effects when the unit is in Preset mode. In Edit or Utility mode, it controls the number 2 parameter that appears in the display.
- 15) Delay/4 Knob** - This knob controls the overall level of Delay when delay is used in the selected Preset. In Edit or Utility mode, it controls the number 3 parameter that appears in the display.
- 16) Reverb Knob** - This knob controls the overall level of Reverb when a Reverb Module is used in the selected Preset. In Edit or Utility mode, it controls the number 4 parameter that appears in the display.
- 17 a-f) FX Library Buttons:**
- 17a) [Config]** - Enters Edit mode at the configuration screen. You can use the **<Speed/1>** knob to select any one the 15 different effect configurations.
- 17b) [Mod]** - Enters Edit mode and selects the first available Modulation module in the Preset. Successive presses move to the next available Modulation module. Pressing and Holding the button while editing an effect will load the first Modulation effect in the effect list.
Modulation effects available: Dual Chorus, Quad Chorus, Octal Chorus, Dual Flange, Dual Phaser, Rotary Speaker Simulator, Stereo Tremolo, Auto Panner, Chorus/Delay and Flange/Delay.
- 17c) [Delay]** - Enters Edit mode and selects the first available Delay module in the Preset. Successive presses move to the next available Delay Module. Pressing and Holding the button while editing an effect will load the first Modulation effect in the effect list. **Delay Effects available:** Delay, Dual Delay, Quad Delay, Stereo Delay, Stereo Dual Delay, Stereo Quad Delay, Long Delay, Analog Delay, Stereo Analog Delay, Chorus/Delay and Flange/ Delay.
- 17d) [Reverb]** - Enters Edit mode and selects the first available Reverb module in the Preset. Successive presses move to the next available Reverb module. Pressing and Holding the button while editing an effect will load the first Modulation effect in the effect list. **Reverb Effects available:** Pre Delay, Reverb, Dual Reverb, Stereo Dual Reverb, Stereo Reverb, Gated Reverb, Spring Tank and Room Echo.
- 17e) [Other]** - Enters FX Edit mode and selects the first available Digital Effect Modules not included in above selections. Successive presses move to the next available Digital Effect Module until finally reaching the Master Mix Module. Pressing and Holding the button while editing an effect will load the first Modulation effect in the effect list. **Modules available in the Other section:** Dual Detune, Quad Detune, Octal Detune, Smooth Pitch Shift, Dual Pitch Shift, Quad Pitch Shift, Octal Pitch Shift, Stereo Pitch Shift, Stereo Dual Pitch Shift, Whammy, Harmony, Compressor, Auto Wah, GEQ 8, GEQ 15, GEQ 31, St GEQ 8, PEQ 3, PEQ 6 and St PEQ 6.
- 17f) [TapIt]** -The TapIt button is used to set the delay time of repeats. To use the TapIt button, simply press the TapIt button twice at the desired tempo and the delay module will automatically recalibrate the delay time. A great option with the TapIt delay time function is that the TapIt function can be assigned to be controlled by a footswitch on the J-3 or J-12 foot controller.
- 18) Power Switch** - Turns the unit on and off. It is always a good idea to turn the Master Volume Output down when applying power or shutting the Millennium down

The Rear Panel

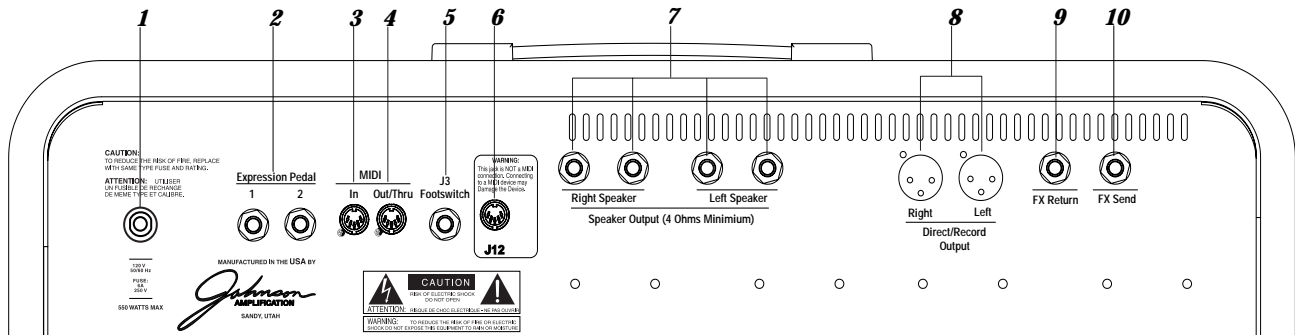

1) **Fuse**- 100, 120 VAC 6 Amp fuse is inserted here.

2) **Expression Pedal 1 and 2 jacks** - This is the insert point for an external expression pedal. Standard volume or voltage controller pedals can be used in these inserts. Once inserted, this expression pedal can be linked to control any parameter of the Millennium. For more about assigning expression pedals, see pg. 57.

Notice: When using the Millennium with the Johnson Amplification J-12 foot controller, the 1/4 Expression Pedal inputs on the rear of the unit are referred to as EXP 3 and EXP4. When the Millennium is used alone, the Expression Pedal Inputs are referred to as EXP 1 and EXP 2.

3) **MIDI IN** - The MIDI IN port allows the Millennium to respond to incoming MIDI information.

4) **MIDI OUT/THRU** - This port allows the Millennium to send out or pass MIDI data to other devices.

5) **J-3 Footswitch jack** - This is the insert point for the J-3 Multi-function footswitch.

6) **Johnson Amplification J-12 Foot Controller Input** - This is a 5-pin DIN plug for connecting the optional Johnson Amplification J-12 foot controller. Connection of the J-12 should be made before the Millennium is turned on.

IMPORTANT: CONNECTING A DEVICE OTHER THAN THE J-12 OR CONTROL ONE CAN DAMAGE THE UNIT.

7) **Left and Right Extension Speaker outputs** - These 4 outputs are used to connect additional speaker cabinets. Up to 4 extension speaker cabinets can be connected to the Millennium. Make sure that the extension cabinet being connected has at least a 4 ohm load resistance per channel. The ohm load resistance effects how much power the extension cabinet receives from the Millennium.

8) **Direct XLR outputs** - These XLR outputs are used for recording direct or for sending the output signal to a live mixing console. When using the XLR outputs, the speakers within the amplifier can be disconnected.

9) **Loop Return Jack** - This is the effects loop mono return jack. Connect the output of an external effect device here.

10) **Loop Send Jack** - This is the effects loop send jack.

Integrated Amplifier Modeling

Vintage and Modern Amp Models: There is really no need to have numerous vintage or modern amplifiers in storage or cluttering up space. The Millennium's unique Integrated Amplifier modeling puts almost every amplifier tone under the hood. This feature gives you re-creations of many great Amplifiers including: Vintage Vox™ AC-30 top boosts, mid 70s' Marshalls™ Master lead, Mesa Boogie™ Dual Rectifier stack and combos and Mark II stack and combo, Matchless™ DC-30s and Fender™ Twins and Soldano™ SLOs. To call up any of these Amplifier modelings, simply press any one of the 5 Amplifier Model buttons on the front panel and the selected Amplifier model is instantly called up.

Johnson Amplifier Models: The Johnson Amplifier Models offer amplifier tones that you never thought possible out of stock (un-modified) amplifiers. We at Johnson Amplification have basically taken the best of all Amplifiers and performed the custom mods on them. This means that you can now have the custom Marshall™ with the higher gain stages, or that Soldano™ with more low end, yet remains ultra quiet. And, if having these custom amp modifications were not enough, the Johnson Amplifier custom modules give you the ability to combine two Amplifier paths on the right and the left at the same time to produce "mammoth" guitar tones when a Morphing Expression pedal is assigned.

A-B channel switching: To give each modeled Amplifier in the Millennium even more flexibility, we have included A-B channel switching in each of the Amp models. This is a great function to use for adding distortion or boosting for solos. The A-B channel selector is conveniently located on the front panel of the Millennium and can be given expression pedal assignment for quick switching on the floor or via a MIDI device.

Amplifier Model Types

The following describes the Amplifier Model selections when any one of the six Amplifier model and Channel buttons (shown below) are pressed. Successive presses of each button will take you through the menu of available Amp types for each Amplifier model.

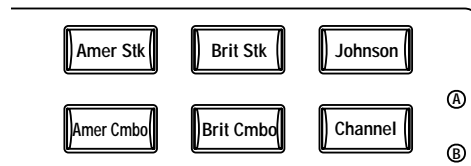

American Stack: Dual Rectifier, Boogie MK II, Soldano SLO

American Combo: '65 Blk Face Twin, Twin Reverb Brite, Matchless DC-30 -1, Matchless DC-30 -2, Boogie MK II Combo, Rectif Combo

British Stack: Marshall Master 1, Marshall Master 2, Marshall JCM 800, Hot Rod Marshall MSTR

British Combo: '63 AC 30 Top boost, '63 TBoost Dirty, A/C TB Cln/Drty, Marsh JCM 800 Cmbo

Johnson: JohnsonCln/Dirty, JohnsonDrt/HiGain, JohnsonCln/HiGain, Fender/Soldano, Fender/HotMarshall, Fender/MatchDrt, Fender/Rectifier, Matchless/Soldano, Matchless/HotMarshall, Match/Rectifier, Vox/Marshall, Vox/Matchless, Vox/Rectifier, Overdrive, Fuzz, Heavy Sustain, Clean/Fuzz, Low Gain/Fuzz, High Gain/Fuzz

Channel: Pressing this button will toggle between the 2 channels within every amplifier model.

Fender™, Marshall™, Mesa Boogie™, Matchless™, Soldano™ and Vox™ are all registered trademarks and are in no way associated with Johnson Amplification.

Digital Effects

Not only is the Millennium a great stand-alone Guitar Amplifier, but it also has a world class digital multi-effect section that includes almost every Studio-quality effect imaginable.

Effects include:

- Reverbs (Natural & Spring)
- Choruses
- Tremolos
- Rotary Speaker Simulation
- Phasers
- Flangers
- Digital Compressor
- Auto panners
- Analog/Digital Delays
- Whammy Effects
- Chromatic Pitch Shifters
- Intelligent Pitch Shifter
- Detuners

Real Time Parameter Modifiers: Modifiers are unique tools that can be used to dramatically alter your sound based on information from signal amplitude, the settings of a Low Frequency Oscillator (LFO) or MIDI Continuous Controller information.

Every Preset in the Millennium has a set of modifiers. Up to 16 Modifier links can be assigned to control parameters. There are 5 types of Modifiers that can be linked to a parameter: Foot Switch, Expression Pedal, MIDI CCs, LFOs, and Dynamic (signal level dependent).

MIDI CCs: When you use MIDI CCs, your Millennium responds to CC numbers 0-127 and CHP (channel pressure or aftertouch).

For example, you can have a synth's modulation wheel (usually MIDI CC#1) control the Input level of a reverb and chorus in one Preset, while the delay feedback may be controlled in another. For more information on MIDI CCs, please see pg. 56.

LFOs: When you use LFOs, parameter values can be controlled automatically between a defined minimum and maximum setting at a user-definable rate. Your Millennium has 2 user definable LFOs in each preset that can use unique speeds and waveforms, and can be assigned to any Parameter.

For example, you can create an auto panner without using an auto panner module. Simply link an effect's output pan parameter to the LFO modifier and the LFO will move that parameter back and forth. This modifier can be a very useful weapon in the ongoing battle of new sound creation. For more information on LFOs, please see pg. 56.

Dynamic Modifiers: When you use Dynamic Modifiers, the parameter values are controlled in relation to the dynamics of the input signal. The possibilities are nearly endless. For more information on Dynamic Modifiers, please see pg. 56.

For example, you could link the Dynamic Modifier of a Preset to control a chorus level. It doesn't sound like much on paper, but imagine the expressiveness of this type of effect on a lead. As you play the guitar harder, the chorus becomes less apparent. Play softly and the chorus increases. ALL IN REAL TIME!

For more information on using modifiers see the "Assigning Modifiers" section. on page 56

Basic Specifications

2 Inputs, Up to 4 Extension Speaker Outputs and XLR Cabinet Emulation Outputs

With the Millennium, the input section offers both a Bright and Normal input, and up to 4 extension speaker cabinets can be connected to the Millennium. The Bright and Normal Inputs give you the best of both worlds. Using the Bright Input produces a hotter and louder tone, where the Normal Input will produce a more natural coloring of the tone. The Millennium's four Extension speaker cabinet outputs give you the ability to drive up to 4 extension speaker cabinets with the Millennium, producing a wall of sound. And if that weren't enough, the Millennium also offers separate XLR Cabinet Emulation outputs for recording or running direct.

Programmable Mono FX Loop

For those of you that feel the need to add additional effects to the already extensive menu of sounds, the Millennium provides a line level programmable FX loop. The signal leaves the Millennium after the Wah section and returns just before the Amplifier Modeling paths.

Foot Controller Compatibility

Although the Millennium has incredible flexibility on its own, we at Johnson Amplification have made the Millennium compatible to use with the Johnson Amplification J-12 foot controller, or the Digitech Control One. The optional J-12 can help you maximize the potential of your Millennium. Since the J-12 “talks” to the Millennium using a proprietary communication protocol, it offers better response time and capabilities not available with conventional MIDI pedalboard controllers.

The Johnson Amplification J-12 foot controller

The Johnson Amplification J-12 foot controller offers continuous control in real time over the all aspects of your tone when used in conjunction with the Millennium 150. The J-12 offers 12 heavy duty metal footswitches and two built in expression pedals which can be assigned to control any parameter of the Millennium in a heavy duty steel chassis. For more on the J-12 foot controller, please see pg. 69.

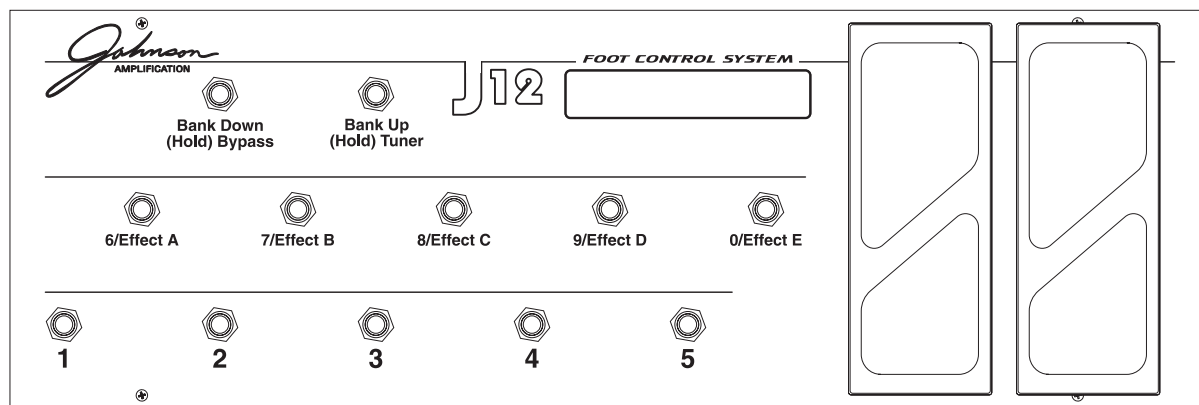

The J-3 foot switch

The Johnson Amplification J-3 footswitch offers three footswitches that can be assigned to perform several different functions. Out of the box, the J-3 will change presets Up and Down and will A-B channel switch. Changing these footswitch functions is done on Pages 14 and 15 of the Utility menu. For more information on J-3 foot switch assignments, please see pg. 67.

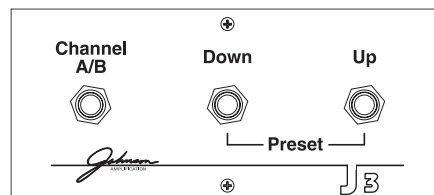

The Digitech Control One foot controller (Not Shown)

The Digitech Control One foot controller offers 12 footswitches for preset and parameter control. It also features a built-in Expression pedal. The Control One also gives you the option of adding another expression control (via the external expression pedal jack which is located on the rear of the Control One foot controller).

Module Types

Each effect in the digital FX section is contained in separate effect blocks referred to as “Modules”. There are three basic types of FX Modules used by the Digital FX section of the Millennium

- Mono FX module
- Dual FX module
- Stereo FX module

The figure below illustrates how signals are routed through each type of FX Module. Although all three Modules are shown with stereo inputs, they can still be used with a mono source. The mono source would just be routed to both sides of the module’s inputs. Notice how the Dual FX Module maintains a stereo image, while the mono FX Module always sums the signal

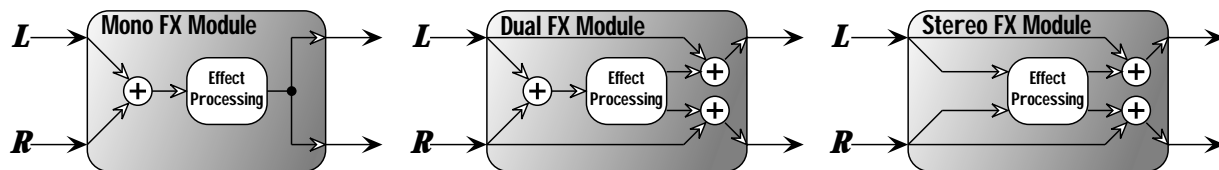

Module Sizes

These modules vary in size ranging from 1/4 size to Full. In order to achieve the nearly endless combinations of effects and routings, we’ve supplied you with four different module sizes and they are as follows:

- Full (module type = FUL)
- 3/4 (module type = 3-4)
- Half (module type = HLF)
- Quarter (module type = 4th)

Dividing the S-DISC II’s processing power allows your Millennium to produce up to 4 digital effects at one time. The figure below represents how the S-DISC II can be divided to accommodate a wide variety of effect routing.

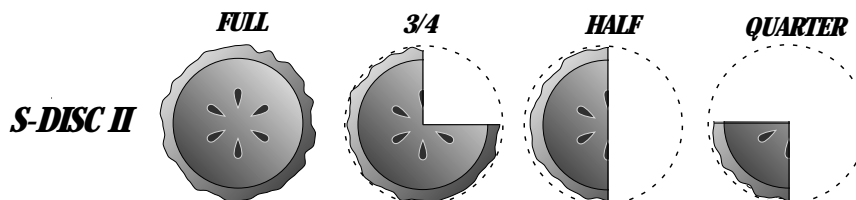

A Full module type offers effects with more flexibility and power than the Half modules, and so on, but all four sizes of FX Modules feature high quality effects, so you don’t have to worry if you need to divide the S-DISC II pie four ways. For a complete list of these FX Types please see the Editing Modules section. For a complete list of effect configurations please see Appendix on page 85

Section-2 Setting Up

Making Connections

Your Millennium can be connected in several different ways to meet the requirements of specific applications. The following diagrams offer some different ways your Millennium can be connected.

NOTE: *In the following diagrams, we have shown use of the external FX loop.*

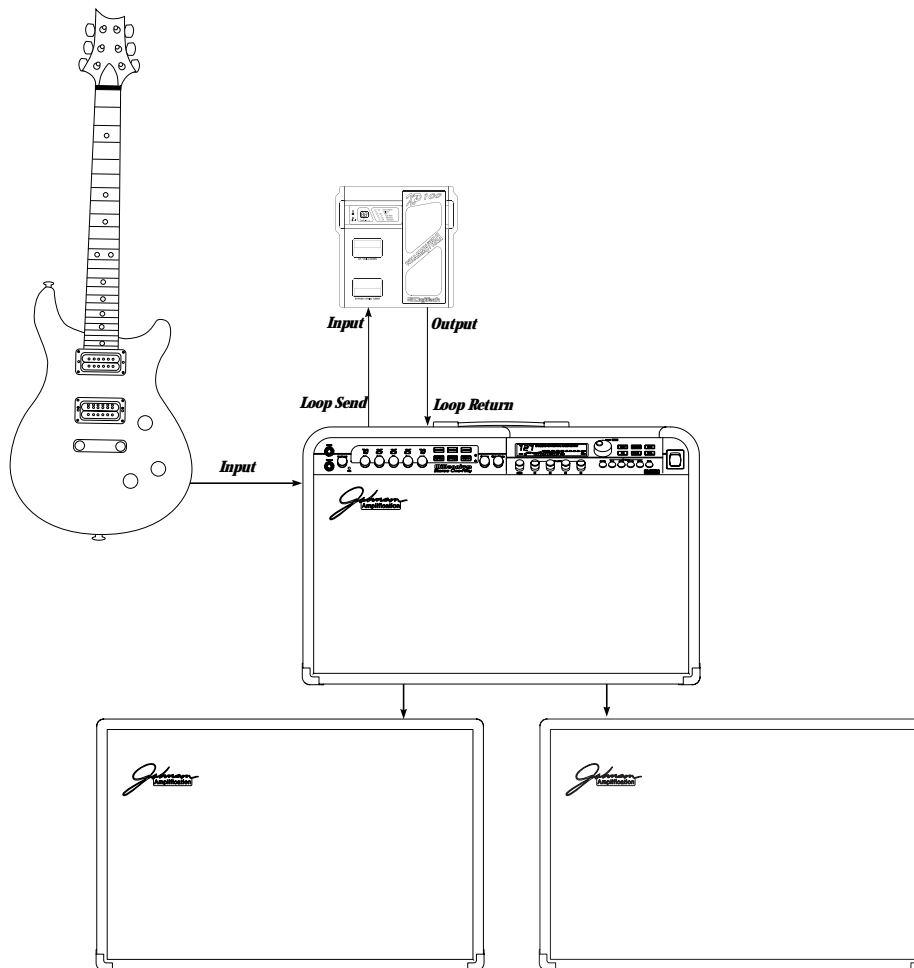

Millennium into Two 2x12 Extension Speaker Cabinets

For those of you out there that feel that “bigger is better”, this set-up should work quite nicely for you. First plug into either the Normal or Bright input. Using the Bright input will produce a slightly brighter tone. From the left and right extension cabinet outputs (located on the rear of the Millennium), use an un-shielded speaker cable and run into the input jacks of the Johnson 2X12 extension cabinets. Using a set-up such as this will let you produce that classic Stack Sound. This is also a great set-up to produce lush and thick stereo effects.

Always make sure that the extension speaker cabinet being used has minimum input load resistance of 4 ohms.

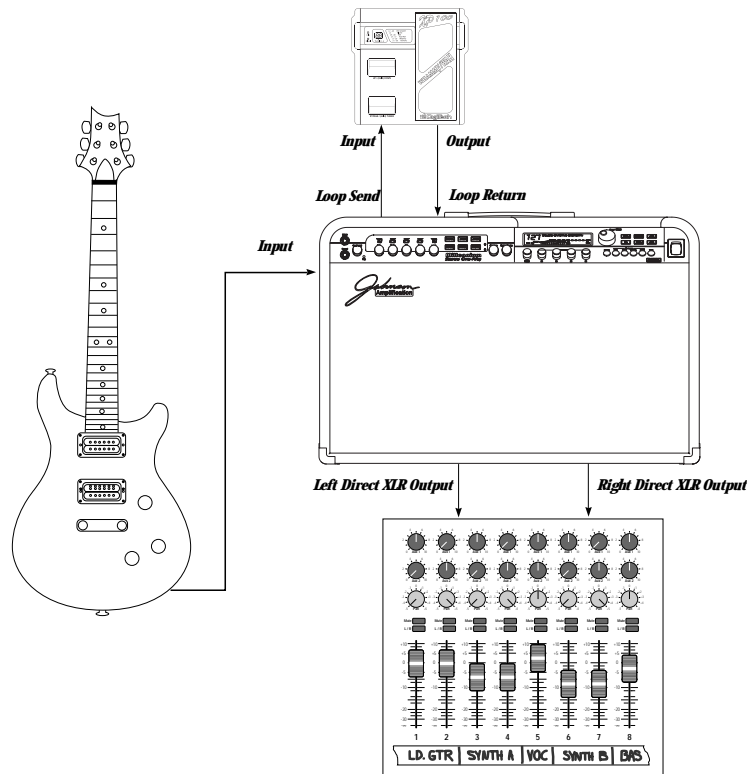

Running Direct with the Programmable Cabinet Emulator XLR Direct Outs

The Millennium offers you two ways to record guitar tracks. With the first, you can do classic recordings by placing a microphone in front of the speakers of the Millennium. Or, you can use the XLR direct output to record direct to a mixing console. When running direct, the Millennium's speakers can be disconnected so the only signal being heard is that being run to the board.

Now you can run out of the Millennium to the mixing board using the following XLR cabinet functions:

XLR Cabinet Emulation functions

Engaging the XLR cabinet Emulator is done in Page 2 of the Utilities menu. To get there, press the **<Utilities>** button. Now use the **<Page>** knob and turn to page 2. Once there, you can globally enable (global on) or disable (global off) the Emulator or enable local settings (local on) by turning the **<4>** knob. To set up local (Presets dependent) emulation on page 2 of the Output/Master mix module in edit mode

To Exit this mode, simply press the **<Preset>** button.

At this point, you will want to run from either Left or Right XLR outputs (or both for a stereo mix), into the selected inputs of the Mixer. You can set the Output mode to either Stereo (splitting the signal into a stereo soundfield) or Mono (summing the stereo signal) on page 1 of the Utilities menu by using the **<2>** knob to select the mode.

As usual, it is a good idea to check all of the cables being used when making connections to ensure that good contact is being made. Notice that once the XLR Speaker Cabinet Emulator is turned On, the **SPEAKER** icon will appear in the display.

Getting Around In the Operating System

The menu structure of your Millennium has been specially designed to be easy to use. The display shows the information you need, but to make things even easier for you, illumination of the front panel buttons offers additional operating information.

The front panel buttons give you information in one of two ways:

- 1 - If the button is dim, its function is inactive. Pressing a dim button causes it to light brightly and its function becomes the active item in the display. If the dim button doesn't light after you press it, the button is unavailable.
- 2 - If the button is bright, its function is active.

Preset Mode

Preset mode allows you to scroll through the Factory and User presets using the **<Preset/Effect>** wheel. When your Millennium is turned on, it sets itself to Preset mode. Preset mode is active when the **<Preset>** button is lit and a Preset name is present on the information line (top line) of the display.

FX Edit Mode

This mode allows you to edit:

1. Digitally controlled Analog Wah
2. FX loop
3. Amp Models
4. Noise Gate
5. Selecting Effect Configurations
6. FX Modules
7. Output Mode of your Presets

Use the **<Edit>** button to enter the FX Edit mode.

A helpful hint: If you look at the Effect Routing Matrix while you press the FX **<Edit>** button, the currently selected module will flash.

Your Millennium uses "Pages" to navigate within an effect. A "Page" is a group of up to four effect parameters that appear on the screen at one time. Use the **<Mix/Page>** knob to move through the pages in the menu. Note that as you scroll through the pages, the page indicator in the lower left corner of the display changes to show the currently displayed page number.

Utility Mode

From the initial power-up of the unit, access to all of the menu pages of the utility mode can be made by simply pressing the **<Utility>** button located on the front panel of the unit. From this point, the display will tell you that you are in the Utility mode and you can scroll through the options by turning the **<Mix/Page>** knob.

Assign Mode

Once the Millennium is in assign mode, all modifier assignments can be made. This assign mode gives you the ability to assign dynamic modifiers, foot switches and expression pedals to almost any parameter in the Millennium. Access to this function is located on the front panel or in the utilities pages within the Millennium. For more information on assignments, please see pg.56.

Getting Sounds

It never fails, there always seems to be a sound man at the back of the room, or an engineer in the control room that wants “more of this, or less of that” (bottom line: your ear is king). But, to accommodate these situations, you may need to make some minor adjusting here and there along the way. So here are some helpful guidelines for getting great sounds, while keeping everyone happy.

Input and Master Output Adjustments

The best setting for the input control is to use the **<Input level>** knob so you're occasionally lighting the clip LED. As far as setting the Master Output level, let your ears be the judge. But, if you can't hear the rest of the band, chances are that you need to back off on the Master Volume level of the Millennium.

Amplifier settings

Gain Adjustments

To adjust the gain in the Amplifier Modeling section, either turn the **<Gain>** knob on the front panel or press the **<Edit>** button to put you in edit mode. Now use the **<Preset/Effect>** wheel to scroll to the amplifier model. From this point, turn the **<Mix/Page>** knob to move to Page 2 of the amplifier module. The number of different Amp tones are almost unlimited when making gain adjustments. Your gain settings range from 0.0 to 10, so this gives you plenty of room for great tones in between. Note that the gain parameter will add distortion gain when a distorted amplifier module is used and will add volume when a clean tone Amplifier module is used. Always remember to save any changes.

EQ and Preset Level

Adjusting the EQ is as easy as grabbing the knob and turning. The **<Treble>** knob controls the level of the High frequencies. The **<Mid>** knob controls the level of the mid range frequencies, and the **<Bass>** knob controls the bass frequencies. In Preset mode, the level of each frequency band is displayed in the 7 segment displays located above each knob. EQ settings range from 0.0 to 10. The Millennium also gives you the ability to adjust individual preset levels by simply turning the **<Level>** knob to the desired setting. Always remember to save any changes.

Note: Changes to the **Gain, EQ and Level** settings can be done using either the tone Controls (located on the left side of the front panel) or the **<1,2,3 and 4>** knobs located directly below the display. Using either editing method will correspond in the display. A sample setting is shown below with Channel B being the active channel.

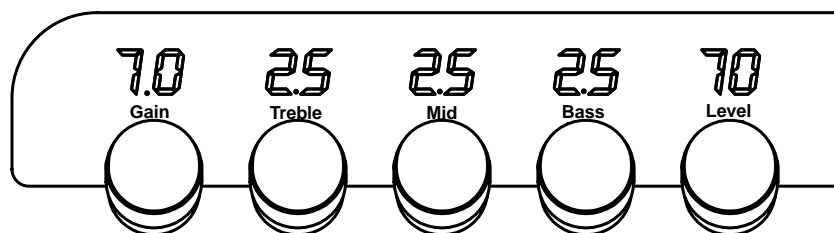

This example setting has been set from Preset mode using Channel B. Once the Millennium is in Edit mode the display will correspond.

When the Tone controls are used, the display will appear as follows on page 2 of the Amplifier module when the Millennium is in Edit mode:

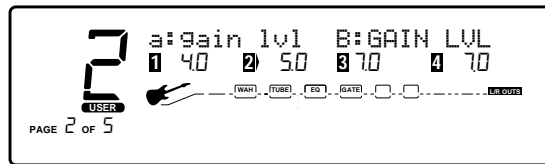

Using the <Page> knob turn to page 4 and the display will appear like this:

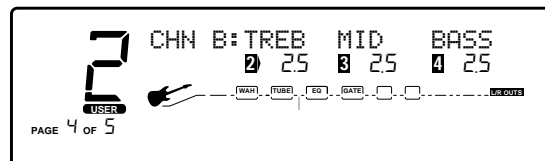

Amplifier Model and Channel Selection

Selecting Amplifier types in the Millennium is as easy as pushing a button. To call up any one of the Amplifier model types, simply press one of the six buttons in the <Amplifier Modeling> button array, or turn the <2> when the Millennium is in edit mode on page 1 of the Amplifier module. Subsequent presses of any one of the Amplifier model buttons will move you through the selected Amplifier model menu. A-B channel switching can be achieved within the Amp model by pressing the <Channel> button, or turning the <4> button while the Millennium is on page 1 of the Amplifier module in edit mode. Always remember to save any changes.

Amplifier Contour Control

Using the <Contour> knob will give you the ability to control the tonal qualities of the Power Amp section of the Millennium. When the <Contour> knob is turned all of the way down, the power amp tone is flat. Turning up the knob brightens up the signal in the Power Amp section.

Digital Effects

Wet/Dry Mix Adjustments Global or Local

To change the mix of dry and wet signal of the overall effect level, use the <Mix/Page> knob. Mix settings range from 0 (all dry) to 100% (all wet) when the Millennium Wet/Dry mix is set to **Local**. When the Wet/Dry mix is set to **Global** (setting the Wet/Dry mix either Local or Global is done on page 2 of the Utility menu), the mix control effects the percentage of Wet/Dry mix in every preset. As the acoustics of any room change, you can easily adjust the mix of your effects accordingly with the turn of a knob. The Master Mix of each preset can be modified in the Master Mix menu while in edit mode by pressing the <Edit> button then scrolling through the Preset pages until the the L/R Out and speaker icons blink.

Digital FX Quick Adjust Knobs

Many digital effects available in the Millennium have a simple quick adjustment knob located on the front panel. These knobs are great to use when you need to bring in or bring down the level of a selected effect. To use these knobs, when the Millennium is in preset mode, simply turn the appropriate quick adjust knob and adjust. Always remember to store the settings once they are dialed-in.

The following list gives a brief explanation of each FX level control knob.

Speed: The <Speed> knob controls the speed of the first modulation effect in the configuration when a modulation type effect, such as a Tremolo is used in the selected preset. The range for the speed is from 0.06 to 16.0.Hz.

Depth: The <Depth> knob controls the depth of the first modulation effect in the configuration when a modulation type effect, such as a Tremolo is used in the selected preset. The range for the depth is from 0 to 100%.

Delay: The <Delay> knob controls the delay level of the first delay in a configuration, when a delay module is used in the selected preset. The range of the delay level is from Off to 100%.

Reverb: The <Reverb> knob controls the reverb level of the first reverb module in the configuration, when a reverb module is used in a selected preset. The range of the reverb level is from Off to 100%.

Selecting A Preset

When you first turn on your Millennium, you are in Preset Mode, and the display will appear something like:

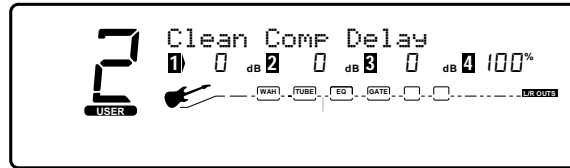

To select a preset, do the following:

1. Make sure preset mode is selected (the **<Preset>** button will be brightly lit). If the **<Preset>** button is dim, press it once to return to preset mode.
2. Use the **<Preset>** button to select the preset bank (factory or user). successive presses of the **<Preset>** button toggle between the factory and user bank of presets.
3. Using the **<Preset/Effect>** wheel, scroll to the Preset you want to use.

Using the Tuner

The Tuner of the Millennium can be accessed one of two ways. Either in page 1 of the Utility menu or by using the optional Johnson Amplification J-12 foot controller. The following explains both modes of operation.

Utility Menu Tuner Mode

1. Press the **<Utility>** button once. The display reads:

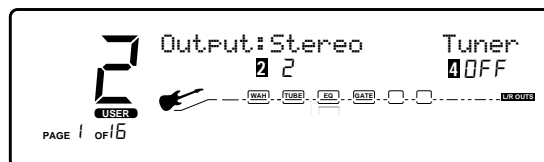

2. Now turn the **<4>** knob to turn the Tuner on. The display will now appear something like this:

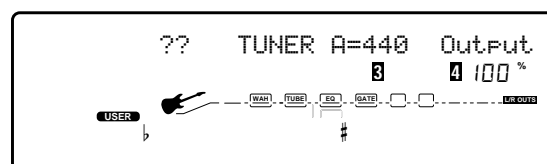

Instant Tuner Access

To instantly access the Tuner Mode of the Millennium, press and hold the **<Utility>** button. This will take you directly to the tuner function.

- As you play a note on the guitar, the large number display will tell you which note you are playing, while the meter will show you if you are flat or sharp. If the meter is moving right, the note you are playing is sharp. If the meter moves left, you are flat. The goal is to tune your guitar so that the meter stops moving, and the display will lock-in, indicating that you are in tune. Once you start playing the selected note, the display will read as follows:

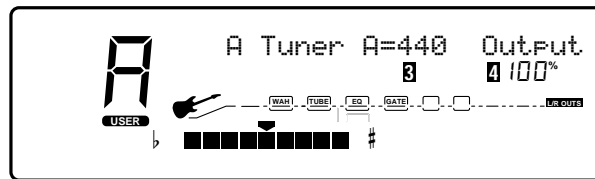

- Press the any button to exit the Tuner mode.

Reference and Output

The Millennium gives you the option of changing the Tuning reference from as low as F# or A=427 to A=453, by simply turning the **<3>** knob while the Millennium is in Tuner mode. Another feature available in the Millennium Tuner mode, is the ability to set the amount of signal that is passed to the output while tuning. This has a range from 0 (mute) to 100%. The output can be changed by turning the **<4>** knob to the desired level while the Millennium is in Tuner mode.

Johnson Amplification J-12 Tuner Mode

To access the Tuner mode using the optional J-12 foot controller, press and hold the **<Bank Up/Tuner>** footswitch to engage tuner mode.

- As you play a note on the guitar, the indicator in the display of the J-12 will move either to the right, or the left. If the indicator is moving right, the note you are playing is sharp. If the indicator moves left, you are flat. The goal is to tune your guitar so that the indicator stops in the middle and the display locks-in, indicating you are in tune.
- In both methods of tuning, the tuner is referenced to A=440Hz. If you prefer tuning sharp or flat according to the A reference, use the **<3>** knob to select a new reference. This can be set as high as A=453Hz or as low as A=427Hz. The tuner can also be used for alternate tuning references where A=Ab (meaning you play an A note, but you hear an Ab note). It is possible to tune as low as A=Gb.
- At this point, press any footswitch on the J-12 to exit the Tuner mode.

Section-3 Editing Presets

Naming and Storing Presets

Before we get into editing presets and creating your own, let's learn how to store changes so you won't lose any modifications you'll want to keep. The Store procedure allows you to rename, relocate and save any modifications you have made to presets so that they can be accessed easily later.

Naming the Preset

1. Press the <Store> button once. The display shows the current preset name (which may look something like this):

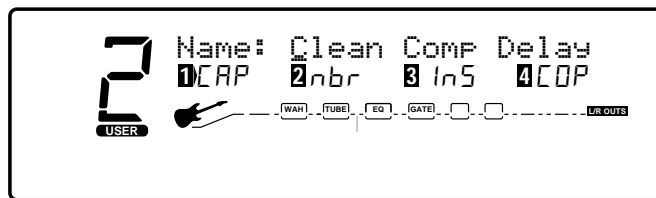

A cursor appears under the first character of the preset name.

2. Using the <Preset/Effect> wheel, change the character to the one you want in the selected position.
3. When the correct character is displayed in that position, use the <Page> knob to scroll the cursor to the next character you want to change.
4. Use the <1> knob to change the letter's case. The <2> knob is used to select numbers, The <3> knob is used to insert spaces. The <4> knob is used to copy and paste characters.
5. To copy a character, position the cursor under the character you want to copy (using the <Page> knob), then turn the <4> knob clockwise. To paste the copied character, position the cursor where you want to paste the character, then turn the <4> knob counter-clockwise.
6. To abort the procedure, press any button.

Storing the Preset

1. When you have the name how you want it, press the **<Store>** button again. The top line of the display appears something like this:

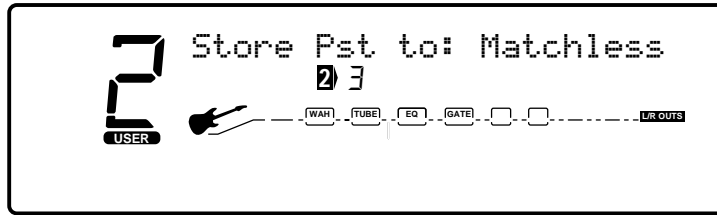

This screen allows you to select the location of the new Preset. Note that when the Preset is stored, it is stored in the User bank of presets because factory presets cannot be overwritten.

2. Use the **<2>** knob or the **<Preset/Effect>** wheel to select the preset number where you want to store the new preset.
3. Press the **<Store>** button again. The top line of the display briefly reads:

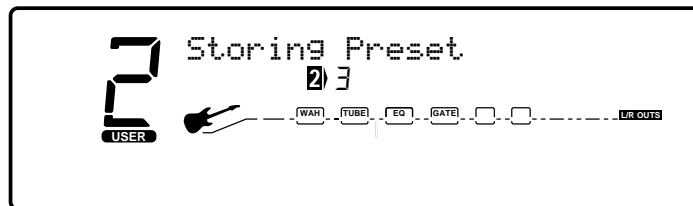

after which you are taken to the preset you have just stored.

The newly created preset is now loaded, and can now be recalled at any time.

4. To abort the procedure, push either the **<Preset>** button to take you to preset Mode, the **<Edit>** button to take you to FX Edit Mode, or the **<Utilities>** button to take you to Utility Mode, depending upon which mode you want to enter.

Editing a Preset

The Millennium is capable of producing almost any sound ever thought conceivable. Whether it be amplifier tone or an effect configuration that utilizes the most sophisticated digital effects available. Great sounds aren't just a crazy concept, but a very achievable possibility, and in these next few pages, we will give you some pointers in editing presets, to help achieve your own unique tones.

Preset Editing Sections

1. Integrated Amplifier Model Editing
2. Digitally controlled Analog Wah Editing
3. Noise Reduction Editing
4. Digital Effects Editing

Integrated Amplifier Model Editing

From any preset within the Millennium you can select and edit any amplifier model by performing the following procedures:

Integrated Amplifier Model Selection

To call up any Integrated Amplifier Model in the Millennium while in preset Mode, all you have to do is press any one of the Amplifier Models buttons and the selected amplifier model type is called up. Successive presses of the selected amplifier model button will call up any other amplifier type within that model. The illustration below shows the selection of the British Combo Amplifier Integrated Model:

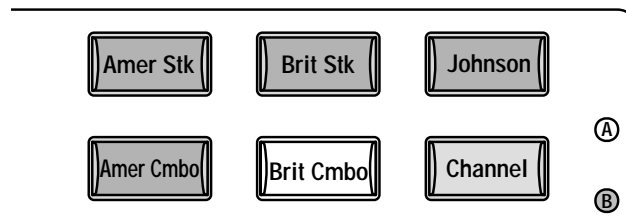

Editing Integrated Amplifier Models

1. From preset mode press the <Edit> button once and the display will appear something like this:

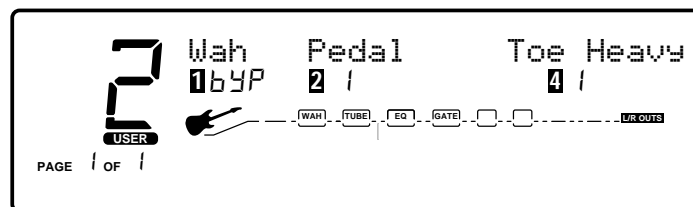

2. Now use the **<Preset/Effect>** wheel and scroll to the Amplifier type Module. Once you are there, the display will appear something like this:



3. Using the **<2>** knob will allow you to select any one of the amplifier models within the Millennium and the **<4>** knob will select either the A or B channel. This will make the selected channel active for editing

4. Once the amplifier model and channel have been selected, use the **<Page>** knob to move to page 2 of the amplifier model edit menu. Page 2 lets you adjust the gain and preset levels of channel A or B. The active channel (A or B) appears in upper case letters and will appear something like this :

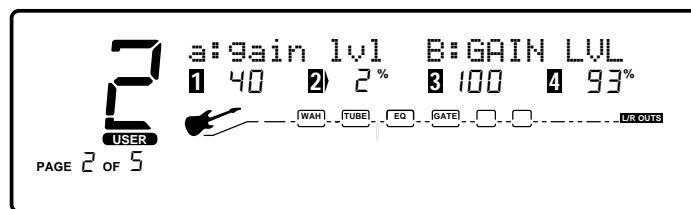

Note: To toggle between the active A or B channel, simply press the **<Channel>** button. This is essential for editing because when the A or B channel is active you can make all EQ, gain and preset level modifications using either the **<1>**, **<2>**, **<3>** and **<4>** buttons, or you can use the **<Gain>**, **<EQ>**, or **<Level>** knobs to make any adjustments.

5. Once the adjustments are made to the gain and levels of amplifier models and channels, use the **<Page>** knob and turn to page 3 (Channel A) and 4 (Channel B) of the amplifier model editing section to make any EQ adjustments. The display will appear like this:

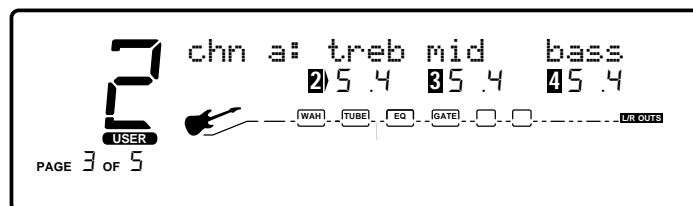

6. Now use the <Page> knob to move to page 5 of the amplifier model editing section and the display will appear like this:

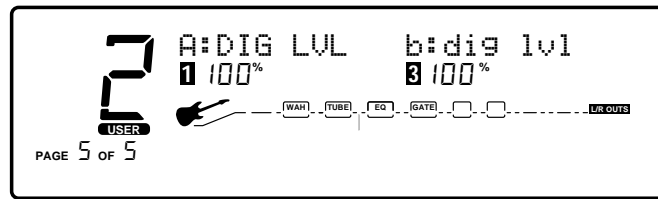

7. Using the <1> knob will let you adjust the digital level of Channel A. The <3> knob adjusts the digital level of Channel B.

Note: Digital Level sets the amount of digital effect level that is heard within the selected preset.

Always note that the channel (A or B) that appears in upper case letters is the currently active channel and can be toggled any time using the <Channel> button to select either channel

8. Once all of the modifications have been made to the Amplifier model in the currently selected preset, press the <Store> button to save your changes. To exit the amplifier model editing section, press the <Preset> button.

Analog Wah Editing

Analog Wah editing can be done by performing the following procedures:

1. From Preset mode press the <Edit> button and the display will appear like this:

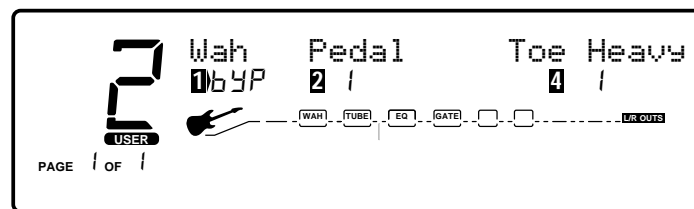

2. Using the <1> knob will either turn the Wah On or Off. The <2> is used to activate the Wah pedal range and the <4> knob is used to select the Wah type.

3. The <2> (pedal) parameter can be assigned to a footswitch to bypass or turn the module On. This is parameter can be selected by turning the <2> knob and a **Changed** icon will appear directly beneath the parameter. At this point press the <Assign> button and the display will appear as follows:



4. Now press the footswitch to be assigned. **You can use either the a standard volume or voltage controller Expression pedal connected to the Expression Pedal 1 and 2 pedal inserts on the rear panel of the Millennium or you can use either one of the Expression pedal on the optional J-12 Foot Controller to act as the Wah pedal.** If the selected footswitch is already assigned to control another parameter, the display of the Millennium will ask you if you want to re-assign. If you wish to re-assign turn the <1> knob for yes or the <2> knob to abort the assign function.

Note: Any time an assignment to turn a parameter On/Off is made you must decide if you want the parameter On when you enter the selected preset. If you want it on, make the assignment to the parameter when the parameter is set to On. Otherwise, have the parameter set to Off or Bypass and the parameter will not be active within the Preset until the footswitch is used to activate the parameter

5. To Exit the Analog Wah edit mode, simply press the <Preset> button.

Noise Gate Editing

The procedure for editing the Noise Gate module within the amplifier section is as follows:

1. From preset mode, press the <Edit> button and use the <Preset/Effect> wheel and turn until the display appears something like this:

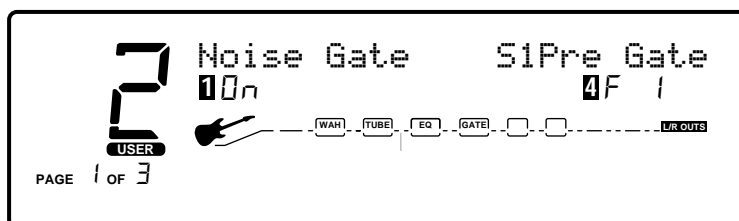

2. At this point, you can use the <1> knob to turn the Noise gate On or Off and the <4> knob is used to select the Noise gate default.
3. Now use the <Page> knob and turn to page 2 of the Noise Reduction module. Turning the <1> knob lets you select the Noise gate type and its position in the signal flow.

4. Once the Noise gate type and position are selected use the <Page> knob and turn to page 3 of the Noise gate edit module. This page is used to set the Threshold, Attenuation, Attack and Release parameters. Higher Threshold settings will close the gate sooner. Lower Release settings allow the gate to open up faster
5. To exit Noisegate edit mode, press the <Preset> button.

Selecting Effect Configuration Routes

Within every Preset of the Millennium, you have the option of selecting any 1 of the 15 Effect Configuration routes available in the Millennium. This can be very helpful when you have a preset that uses an Amplifier model that you prefer, but the currently selected effect configuration is not ideal for the digital effects that you wish to use in the Preset. You can easily change these Effect configurations by using the following procedure as a guide:

1. Accessing the effect configurations can be done one of two ways. From Preset mode, simply press the <Config> button, or press the <Edit> button and use the <Preset/Effect> and turn until the display appears something like this:



Note that the effect configuration is flashing

2. Now use the <1> to select any one of the 15 different configurations available.
3. Once the configuration has been selected, press the <Store> button to save any changes.
4. To Exit the configuration menu, just press the <Preset> button to return to preset mode.

A Complete listing of the effect configurations of the Millennium can be found on page 85.

FX Edit Mode

1. From Preset mode, press the <Edit> button. The display looks something like this:

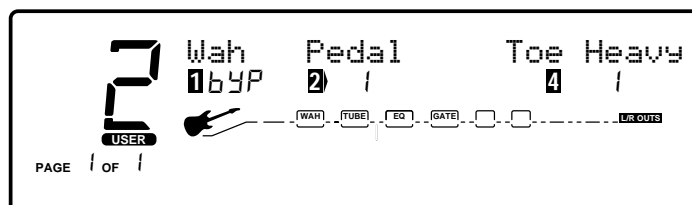

When you enter FX Edit mode, the first page of every FX Module allows you to:

- 1) Bypass that effect module (by turning it on or off) using the <1> knob.
- 2) Select an Effect Module (Only in the Digital Effect section), using the <2> knob.
- 3) Store the Default using the <3> knob (for more info on storing Defaults, see pg. 30).
- 4) Select a Default for the selected Effect Module using the <4> knob.

Changing Effect Modules

Each preset can be comprised of up to 4 digital effects (in addition to the Amplifier section). You can scroll through the modules in each preset two different ways:

1. By pressing the <Edit> button to enter FX Edit mode and using the <Preset/Effect> wheel to scroll through the different modules, or
2. By using the FX Library buttons. Pressing the <Config> button takes you directly to the first module in the Amplifier section. Likewise, pushing the <Other> button takes you directly to the first module in the digital FX section and displays which effect is in it. Subsequent pushes of the button scrolls you through subsequent modules that are in the effect configuration.

Once you reach a module you want to change (ie: you want to swap a delay for a reverb), use the <2> knob to select a new effect.

Selecting a Default

Once you have selected the effect you want in the preset (ie: Dual Chorus), you can quickly scroll through several different Dual Chorus defaults stored in your Millennium's library. Defaults are modified effect modules which have custom settings that can be called up to use in a preset anytime that particular sound is required.

Example:

There are 10 Dual Chorus defaults to choose from. Some Factory Presets use these default settings. So, if you like the Dual Chorus that is being used in Factory Preset #45, and would like to use it in Preset #98, simply scroll to the modulation module, then use the <4> knob to recall the default (which happens to be F4-MediumWell) in Preset #45. This eliminates the need to copy all those parameters from one location to the other.

For a list of all the FX Modules and their Defaults, see page 34.

Adjusting the Module's Parameters

Once in Edit Mode, the parameters of every default module can be accessed through a series of pages. You adjust the level of a particular module from Edit page 2. If you're not already in Edit Mode, press the <Edit> button. You can then use the <Preset/Effect> wheel to scroll to the module you want to change (ie: Dual Chorus). Using the <Page> knob, scroll to page 2. You can now change the individual module's level using the <1> knob. Settings range from 0 (off) to 100%.

Custom Defaults

Once you have tweaked the parameters of an effect Module, you can store it off as part of the preset. Once it is stored off, it becomes a custom default for that preset, but is not added to the User default library. To save the settings as User Defaults, please see pg. 31

Comparing Changes

During the course of editing presets, you may find that you want to compare the edited version of the preset to the original, stored version. Fortunately, your Millennium provides you with a compare function.

To compare an edited preset with the original stored version, do the following:

1. While in FX Edit mode, press the **<Edit>** button once. The top line of the display reads:

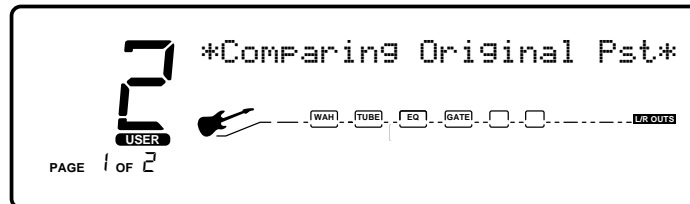

When this message is displayed, the stored preset is temporarily loaded and active.

2. To return to the edited version, press the **<Edit>** button to get back to FX Edit Mode.

Section-4 Editing Modules

Storing/Naming Defaults

Before we get into editing modules and creating your defaults, let's learn how to store changes so you won't lose any modifications you'll want to keep. The Store procedure allows you to rename, relocate and save any modifications you have made to defaults so that they can be accessed easily later.

1. When you have satisfactorily altered an effect default (or created a new one), scroll back to Page 1 of the effect module you are editing (if you're not already there). The display looks something like this:

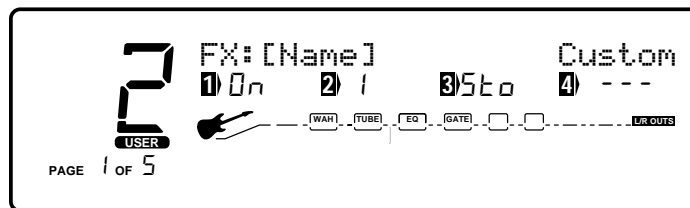

2. From Page 1 of the FX Edit menu, turn the <3> knob clockwise. You will then be able to name your new default.

Naming the Default

1. Using the <Preset/Effect> wheel, change the character to the one you want in the selected position.
2. When the correct character is displayed in that position, use the <Page> knob to scroll the cursor to the next character you want to change.
3. Use the <1> to change the letter's case. Use the <2> knob to select numbers. The <3> knob is used to insert spaces. The <4> knob is used to copy and paste characters.
4. To copy a character, position the cursor under the character you want to copy (using the <Page> knob), then turn the <4> knob clockwise. To paste the copied character, position the cursor where you want to paste the character, then turn the <4> knob counter-clockwise.
5. To abort the procedure, push either the <Preset> button to take you to preset mode, the <Edit> button to take you to FX Edit mode, or the <Utility> button to take you to Utility mode, depending upon which mode you want to enter.

Storing the Default

1. When you have the name as you want it to read, press the **<Store>** button. The top line of the display reads:

Store To: [Name]

This screen allows you to select the location of the new default. Note that when the default is stored, it is stored in the User bank of defaults because factory defaults cannot be overwritten.

2. Use the **<2>** knob to select the default number where you want to store the new default.
3. Press the **<Store>** button again. The default is saved off and you are taken to page 1 of the FX Edit menu.

The newly created default is now loaded, and can now be recalled at any time.

4. To abort the procedure, push either the **<Preset>** button to take you to Preset Mode, the **<Edit>** button to take you to FX Edit Mode, or the **<Utility>** button to take you into Utility Mode, depending upon which mode you want to enter.

Editing a Module

Each of the Millennium's effects has several usable factory defaults, however, you may need to tweak the parameters of the module in order to the right sound you're looking for. The parameters of each effect module are reached through a series of pages.

1. Press the **<Edit>** button. The display looks something like this:

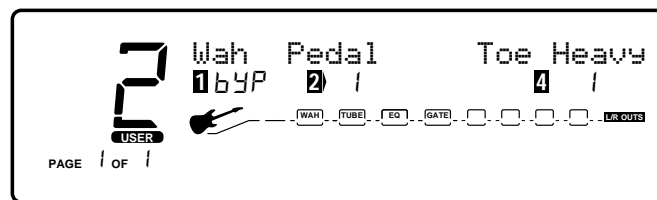

When you first enter FX Edit mode (by pressing the **<Edit>** button), you are taken to the Analog Wah section. Turn the **<Preset/Effect>** wheel to scroll through the modules until you reach a digital Effect module. Notice that as you scroll through the different modules, the currently selected module will flash in the Effect Routing matrix of the display. Once you have reached a module in the digital Effects section that you want to edit, use the **<Page>** knob to scroll to the particular parameters.

*Notice: Anytime a change is made to either an effect module or Default, the **Changed** icon will appear directly below the effected parameter within the module or default and the **<Store>** button will light.*

Scrolling through a Module's Pages

Notice in the bottom left corner of the display (just under the preset number) the display indicates which page you are on and the total number of pages within the module. Each page allows you to access up to four parameters using the <1> - <4> knobs.

Example:

To scroll through the parameter pages of the Dual Chorus module, from the Preset mode either press the <Mod> button on the front panel until the Dual Chorus module comes up in the display. or, press the <Edit> button and once this button is lit, use the <Preset/Effect> wheel to scroll to the Dual Chorus module. At this point use the <Page> button to scroll through the parameters of the Dual Chorus module.

For a description of all the FX Modules and their parameters, see pages 35-55.

Output Module Functions

The last module in the audio chain within any preset of the Millennium gives you control over crucial output functions of the Amp such as: Master Mix, Master Volume and On and Bypass of the XLR cabinet emulator for each preset.

1. To access the Output module, press the <Edit> button and turn the <Preset/Effect> wheel counter-clockwise once until the display appears like this:

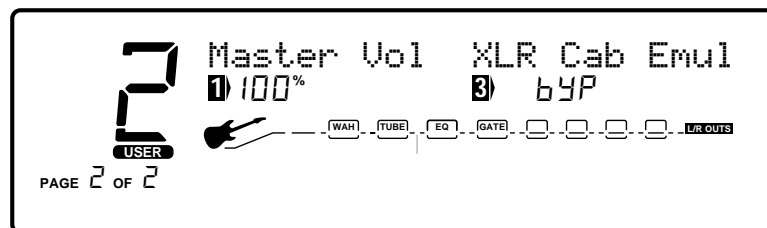

2. Using the <3> and <4> knobs will let you set the Master Dry and Wet levels in the selected preset.
3. By turning the <Page> knob, you will now be taken to page 2 of the Output module and the display will appear like this:

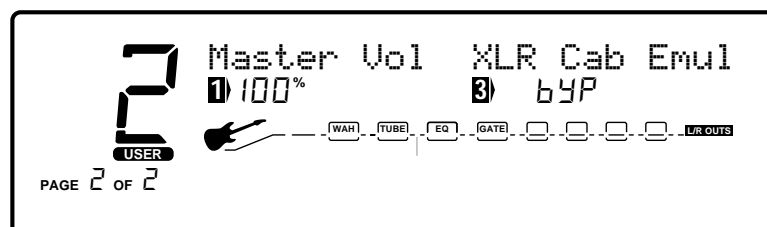

4. The <1> knob is used to set the Master Volume level and the <3> knob is used to set the XLR Cabinet emulator to On or Bypass in the currently selected preset. To Exit the Output module, either turn the <Preset/Effect> wheel, or press the <Preset> button.

Digital Effect Module Size and Type

With all of the work that these digital effect modules do for your sound, they have a tendency to work up an appetite. So, they consume their food from the FX pies chart referred to on page 12.

Since some of these effect modules have a larger appetite than the others, they require more pie. To help divide up the pie, we have provided you with a chart below that tells you what size of effect block that each will fit in. This helpful chart will also let you know if the selected module is either a Mono, Stereo, or Dual type effect module.

Note: The Effect Module size will always be displayed in Page 1 of the selected effect module next to the number 2 icon located in the display.

Effect Name	Module Type - 4h	Module Type - HLF	Module Type - 3/4	Module Type - FULL	Effect Type
Dual Cho	✓	✓	✓	✓	Dual
Quad Cho		✓	✓	✓	Dual
Octal Cho			✓	✓	Dual
Dual Fla	✓	✓	✓	✓	Dual
Dual Pha	✓	✓	✓	✓	Dual
RotarySpkr		✓	✓	✓	Stereo
St Tremolo	✓	✓	✓	✓	Stereo
Auto Pan	✓	✓	✓	✓	Stereo
Dual Dtn	✓	✓	✓	✓	Dual
Quad Dtn		✓	✓	✓	Dual
Octal Dtn			✓	✓	Dual
Smooth Pch			✓	✓	Stereo
Dual Pitch	✓	✓	✓	✓	Dual
Quad Pitch		✓	✓	✓	Dual
Octal Pch			✓	✓	Dual
St Pitch	✓	✓	✓	✓	Stereo
StDual Pch		✓	✓	✓	Stereo
Whammy			✓	✓	Stereo
Harmony			✓	✓	Stereo
Delay	✓	✓	✓	✓	Dual
Dual Delay	✓	✓	✓	✓	Dual
Quad Delay		✓	✓	✓	Dual
Stereo Delay		✓	✓	✓	Stereo
StDual Dly			✓	✓	Stereo
StQuad Dly		✓	✓	✓	Stereo
Long Dly	✓	✓	✓	✓	Dual
Analog Dly	✓	✓	✓	✓	Stereo
StAlog Dly		✓	✓	✓	Stereo

Effect Name	Module Type - 4h	Module Type - HLF	Module Type - 3/4	Module Type - FULL	Effect Type
Chorus/Dly	✓	✓	✓	✓	Dual
Flange/Dly	✓	✓	✓	✓	Dual
Pre Delay	✓	✓	✓	✓	Dual
Reverb	✓	✓	✓	✓	Dual
DualReverb		✓	✓	✓	Dual
St Reverb			✓	✓	Stereo
Gated Rvrb	✓	✓	✓	✓	Dual
St Dual Reverb			✓	✓	Stereo
Room Echo			✓	✓	Stereo
Spring Tank			✓	✓	Dual
Auto Wah	✓	✓	✓	✓	Stereo
Compressor	✓	✓	✓	✓	Stereo
GEQ8	✓	✓	✓	✓	Mono
GEQ15		✓	✓	✓	Mono
GEQ31			✓	✓	Mono
St GEQ8		✓	✓	✓	Stereo
St PEQ3	✓	✓	✓	✓	Stereo
PEQ6	✓	✓	✓	✓	Mono
St PEQ6	✓	✓	✓	✓	Stereo
Thru Module	✓	✓	✓	✓	St/Mono

Default List

The Following list contains the names of all of the Effect Defaults in the Millennium

Noise Gate

- S1 Pre Gate
- S2 Post NR
- Post Tub
- S2 PostDst
- Fast Swell
- Slow Swell

Choruses

Dual Chorus

- Medium
- Shallow
- MildNWide
- MediumWell
- DeepDepth
- Deep
- Max Depth
- Shimmery
- SloVibrato
- FstVibrato

Quad Chorus

- Medium
- MildNWide
- Medium Well
- Thick
- DeepDepth
- Deep
- Max Depth
- Shimmery
- SloVibrato
- FstVibrato
- ChorusLeft

Octal Chorus

- Medium
- Shallow
- DeepDepth
- MaxDepth
- Deep
- Shimmery
- SpScrmblr

Flangers

Dual Flange

- HiSweep30%
- HiSweep70%
- LoSweep30%
- LoSweep70%
- Throaty
- Nasally
- Gonzo
- IntenseL
- Intense R
- FlaChorus1
- FlaChorus2

Stereo Flange

- HiSweep30%
- HiSweep70%
- LoSweep30%
- LoSweep70%
- Throaty

- Nasally
- Gonzo
- IntenseL
- Intense R
- FlaChorus1
- FlaChorus2

Dual Phaser

- ShallowSlo
- ShallowFst
- Mild Slow
- Mild Fast
- Medium
- Deep
- Shimmery
- PhaChorus1
- Phas Chorus2
- Psychelic

Detuners

Dual Detuner

- 5 Cents
- 12 Cents
- +/-5 Cents
- +/-10 Cents
- Single Vox

Quad Detuner

- Shallow
- Medium
- Wide
- Deep

Octal Detuner

- Shallow
- Medium
- Wide
- Deep

Pitch Shifters

Whanny

- Octave Up
- Octave Down
- 2ndMin3rd
- 2ndMaj3rd

Smooth Pitch

- ShftDn-12
- ShftDn-5
- ShftDn-24
- ShftUp+5
- ShftUp+7
- ShftUp+12

Dual Pitch

- 5th/OctUp
- 5thUp/OctDn
- Min3/5thUp
- 4th/OctDn
- OctUp/Dn
- OctDown/Dtn
- 5ths Down
- 1&2OctsUp

Quad Pitch

- MajChord
- MinChord
- Oct/Dtn
- 5th/OctDtn
- 5Octaves

Octal Pitch

- Chord/Det1
- MinChord2
- Oct/Dtn
- 5th/OctDtn
- 5thsOcts

Stereo Pitch

- 5th Up
- Min3rdUp
- Maj3rdUp
- OctaveUp
- 4thDown
- Octave Down
- 2 OctsDown

Stereo Dual Pitch

- 5th/OctUp
- Min3rdUp
- 3rd/5th Up
- Min 3rd/5th Up
- 4th/OctDn
- OctUp/Down
- OctDownDtn
- 1&2OctsUp

Harmony

- Cmaj3rdUp
- Cmaj6thUp
- Emin3rdUp
- Cmaj6thDn
- Cmaj3rdDn
- Emix3rdUp
- Cmaj5thUp
- 1&2OctsUp

Delays

Delay

- 1400ms/15%
- CombFilter
- Doubling
- Slapback
- 300msEcho
- 400ms/30%
- 500ms/25%
- 800ms/20%
- 1SecEcho
- MaxRepeats
- 1400ms/0%

Dual Delay

- PingPong
- 1SecTicToc
- Doubling
- Slapback
- DoubleSlap
- RoundNRound
- Hard2Tap
- Thick Tap

Quad Delay

- RoundNRnd
- SynchroTap
- RtoLPanTap
- TripleSlow
- Ping Pong
- 400ms Thick
- On the Rise
- Shav&Hrcut
- Horse Trot

Stereo Delay

- 700ms/20%
- Combfilter
- Doubling
- SlapRight
- 400ms/50%
- 500ms/30%
- 600ms/15%
- MaxRepeats
- 350ms/0%
- 700ms/0%

Stereo Dual Delay

- Skip
- SwingPong
- PingPong1
- PingPong2
- DoubleSlap
- RoundNRnd
- Hard2Tap
- ThickEcho

Stereo Quad Delay

- RoundNRnd
- SynchroTap
- Ping Pong
- 400msThick
- HorseTrot
- Shav&Hrcut
- Ratatat
- Random

Long Delay

- 2.8sec/15%
- CombFilter
- Slapback
- 300msEcho
- 400ms/30%
- 500ms/25%
- 800ms/20%
- 1 SecEcho
- MaxRepeats
- 2.8sec/0%

Analog Delay

- 1400ms/25%
- SoftEcho
- Eternity

Stereo Analog Delay

- 700ms/25%
- SoftEcho
- Eternity
- DlyCho300m

Multi-FX Mods

Chorus/Delay

- MedChoEcho
- LitChoEcho
- MedChoSlap
- DeepChoDly
- ShimryEcho
- ModDly300ms
- DeepModDly

Flange/Delay

- FlatLitD300
- FlatMedD300
- HeavyFDly
- LoSweepDly
- ThroatyDly
- DoubGonzo
- Flangbely

Reverbs

Reverb

- SmoothHall
- Bar'nGrill
- OakFloorRm
- Vocal Reverb
- FoilPlate
- GoldPlate
- Smphny Hall
- RichChmber
- Sanctuary
- Salt Palace
- CmntGarage
- PlutoVerb

Dual Reverb

- BrightHall
- LngDrkHall
- ConcrtHall
- MiniHall
- FlatChambr
- WarmChambr
- Smphny Hall
- BigCathedrl
- SmlCatherl
- GoldPlate
- Thinplate
- VocalPlate
- PercPlate
- StudioAmb
- StudioRoom
- FlutterRvb
- Very thin
- CementRoom
- HugeArena

Stereo Reverb

- SmoothHall
- Bar'nGrill
- OakFloorRm
- VocalReverb
- FoilPlate
- GoldPlate
- SmphnyHall
- RichChamber
- Sanctuary
- SaltPalace
- CmntGarage
- PlutoVerb

Gated Reverb

- 100msGated
- 200msDcyEx
- 200msDecay
- 200msGated
- 300msDcyEx
- 300msGated
- SmphnyHall
- RichChamber
- Sanctuary
- SaltPalace
- CmntGarage

Spring Tank Reverb

- Short Decay
- Long Decay
- Wet Spring
- SurfSplash
- Rat&Boing

Room Echo

- WideSlap
- LiveSlap
- Springy
- Stage
- Voxy
- Drum 1
- Drum 2

Other Modules

Pre Delay

- 0ms
- 30ms
- 60ms
- 90ms
- 120ms
- Warm0ms
- Warm60ms
- Warm120ms
- 0msHPass1
- 0msHPass2
- 0msHPass3
- 0msHPass4
- 0msLPass1
- 0msLPass2
- 0msLPass3
- 0msLPass4

Rotary Speaker

- SloLeslie
- MedLeslie
- FastLeslie

Stereo Tremolo

- DeepSlow
- DeepMedium
- DeepFast
- MildSlow
- MildMedium
- MildFast

Auto Pan

- WideSlow
- WideMedium
- Wide Fast
- Narrow Slow
- Narrow Med
- Narrow fast

Auto Wah

- Low Sens
- High Sens

Compressor

- Light
- Medium
- Heavy

Equalizers

8-Band Mono GEQ

- Flat
- Low Pump
- Sizzle
- InvertPhase
- Smiley
- InvertPhase

15-Band Mono GEQ

- Flat
- Low Pump
- Sizzle
- Smiley
- InvertPhase

31-Band Mono GEQ

- Flat
- Low Pump
- Sizzle
- Smiley

8-Band Stereo GEQ

- Flat
- Low Pump
- Sizzle
- InvertPhase

3-Band Stereo PEQ

- Flat
- Low Boost
- Smiley
- PhaseInvertL
- PhaseInvertR
- SmlBoost
- LowNudge
- 60HzNotch

6-Band Mono PEQ

- Flat
- Low Boost
- Smiley
- 60HzNotch
- InvertPhase

6-Band Stereo PEQ

- Flat
- Low Boost
- Smiley
- 60HzNotch
- PhasInvertL

Thru Module

- Stereo Thru
- Mute
- Left Thru
- Right Thru

Effects Library

The following pages offer the complete low-down on all of the effects offered in the Johnson Millennium Stereo 150 .

Analog Wah

With the Analog Wah, you get the best of both worlds. This Analog Wah is digitally controlled. What exactly does that mean? This means that you get an dead-on accurate Wah emulation (you may have heard a certain Left-handed guitarist at Woodstock with this same tone), which is controlled via the Millennium's powerful processing. And the best thing is, you no longer have to change batteries every 3 to 4 hours.

The Analog Wah module also gives you the ability to assign a Dynamic Modifier to the Pedal parameter to create Auto-Wah effects within the Wah module.

Analog Wah Parameters

- ON/Bypass** This parameter turns the Analog Wah On or Bypasses the effect module.
- Wah Position** Controls the pedal position of the Analog Wah effect module. Ranges from 1 to 128. ***An Expression pedal such as the Expression Pedals on the J-12 or a standard volume or voltage control pedal must be assigned to this parameter in order for module to operate.**
- Wah Type** Selects which Wah type is to be used. Selections are: Toe heavy, Linear, and Heel Heavy.

Amplifier Types

All of the great Amplifier tones of today and the past are present under the hood of the Johnson Amplification Millennium. You can access any of these tones by pressing any one of five Amplifier Modeling buttons located on the front panel. Successive presses of each button moves you through a variation of the selected Amplifier Model type. They're all there, but if you want to modify these tones, this can easily be done in the Edit mode.

Amplifier Type Parameters

- Amp Selector** This parameter is used to select the different Amplifier types available.
- Channel Selector** Selects which channel of the Amplifier is being used or modified. Selections are Channel A or Channel B.
- Channel A Gain** This parameter controls the amount of gain used in channel A. Range is from 0.0 to 10.
- Channel A level** This parameter controls the overall level of Channel A. Range is from Off to 100%.
- Channel B Gain** This parameter controls the amount of gain used in channel B. Range is from 0.0 to 10.
- Channel B level** This parameter controls the overall level of Channel B. Range is from Off to 100%.

Channel A Treble	This parameter controls the high EQ frequency used in Channel A . Range is from 0.0 to 10.
Channel A Mid	This parameter controls the mid EQ frequency used in Channel A . Range is from 0.0 to 10.
Channel A Bass	This parameter controls the low EQ frequency used in Channel A . Range is from 0.0 to 10.
Channel B Treble	This parameter controls the high EQ frequency used in Channel B . Range is from 0.0 to 10.
Channel B Mid	This parameter controls the mid EQ frequency used in Channel B . Range is from 0.0 to 10.
Channel B Bass	This parameter controls the low EQ frequency used in Channel B . Range is from 0.0 to 10.
Ch A dlvl	This parameter controls the overall digital effects level in channel A . Range is from Off to 100%.
Ch B dlvl	This parameter controls the overall digital effects level in channel B . Range is from Off to 100%.
Ch A mlvl	This parameter controls the overall master volume level in channel A . Range is from Off to 100%.
Ch B mlvl	This parameter controls the overall master volume level in channel B . Range is from Off to 100%.

Noise Gate

The Silencer noise reduction system is definitely going to become your best friend in any recording session or live performance for keeping signals quiet.

Noise Gate Parameters

Type	Selects the type and placement of the noise reduction to be used. Types include: 1. Silencer 1, 2. Silencer II
Threshold	Set the minimum input level at which the compressor will engage. Ranges from -90 to 0.
Attenuation	Adjusts how far the signal is lowered when the gate is closed. Ranges from 1 to 5.
Attack	Controls how quickly the gate opens after the signal level reaches Thresh. Range: 1 to 10.
Release	Determines how quickly the the gate closes after the signal falls below the Threshold. Ranges from: 1 to 10.

Digital Effects

Reverbs

Reverberation is probably the most widely used effect because it allows you to simulate the sound reflection characteristics of almost any kind of room. In a real room, reverb is a result of sound reflecting off room surfaces such as the walls, floor, ceiling, and objects in the room. The materials, size, and shape of the room determine how long these reflections echo and decay before dying out completely. These factors also help determine the audio characteristics of the room, such as how long the high-frequency reverberations ring when compared to the low frequencies, or how much initial "slapback" the room wall produces when a sound hits.

Today's technology allows the Millennium to offer a complete palette of flexible, easy to use reverbs. There are five basic reverbs to choose from:

- 1) **Reverb** - Simple, straight ahead reverb with only the most basic parameters.
- 2) **Dual Reverb** - Multi-dimensional reverb with flexible frequency band-splitting capabilities. The reverb can be divided into primary and secondary stages using selectable High or Low Pass cross-overs.
- 3) **Stereo Reverb** - A true stereo version of the Reverb Module.
- 4) **Spring Reverb** - A recreation of the old Spring Tank Reverb found in Vintage and Modern combo Amps.
- 5) **Gated Reverbs** - A very linear, high energy reverb that can be set to decay, stay flat, or ramp up the reverb decay, creating many unique ambient effects.
- 6) **Room Echo** - A true stereo, multi-tap delay for creating small ambient spaces. The delays are divided into four sections of early reflections. These reflections can be placed anywhere in the stereo field and can be as dense or sparse as necessary. The Room Delay also includes a feedback loop for delay regeneration.

Reverb

Real life reverberation is the result of sound reflecting off surfaces in a room or hall. It can best be described as millions of small echoes that decay over a period of time. The size of the room, the surface type of the walls, or the carpet on the floor all contribute to the way real reverberation behaves and sounds.

When do I use Reverb? When recording in the studio, nearly always. Many guitar tracks, for example, are recorded in a very sterile environment (i.e. very dry), but adding reverb can add lush depth to any guitar track and you can get those great sounds in the Studio or Live.

Why should I use stereo reverb? Digital Effects such as Chorus and Delay produce stereo imaging type effects. Stereo reverb helps maintain that original stereo image. But don't forget that millions of hit recordings were made using mono input reverbs that created a stereo output image. The theory is that sound generally originates from one point in a room, so mono often works just fine. The rule? Don't get caught using too much reverb on your guitar in live situations. Even if the room is small, it still produces some reverb. Too much makes the guitar go away. Let it compliment the room.

Gated Reverb

Gated reverb doesn't behave as naturally as the standard varieties of reverb. Originally, it was created by taking a long, dense reverb and chopping it short with a noise gate. This made for a burst of reverberation energy that could help thicken up a variety of sounds.

Digital signal processing techniques improved and soon allowed ways to create similar gated reverb sounds that were far more usable and flexible. Today's gated reverb doesn't get gated at all, it just sounds like it does. It is actually a large burst of delay taps that create the gated reverb sound. This allows you to choose the length of the effect along with different slope shapes.

When do I use Gated Reverb? Using a Gated Reverb in a multi effect guitar application is ideal for producing unusual special effects. Using the Gated reverb can produce a very rich and intense and ambience which can thicken up a guitar tone in many ways . This type of reverb is also ideal for producing an effect that is similar to backward masking.

Reverb Parameters:

Note: Not all of the parameters listed below are available in all Reverb modules.

FX: Lvl	Controls the signal input level fed to the Module. Ranges from Off to 100%.
Dry: Lvl	Controls the level of the dry (unaffected) signal. Ranges from Off to 100%.
Balance	Controls the left/right positioning of the dry signal in the stereo soundfield. Ranges from -99 (all left) to 99 (all right).
Type	Selects the reverb type. Each room type has a different decay range (just as real rooms do), so changing TYPE also changes the decay time of the room. Types are: Studio Room, Wood Room, Vocal Plate, Concert Hall, Plate Reverb, Chamber, Cathedral, Arena, Cement Shelter, and Infinite Spring (for Reverbs), and: Flat, Shelf, Decaying Linear, Decaying Logarithmic, Decaying Exponential, Decaying Sine, Reverse Linear, Reverse Logarithmic, Reverse Exponential, Reverse Sine, Peaking Linear, and Peaking Exponential (for Gated Reverbs).
Density	Controls the number of discrete room wall reflections during the early portions of DECAY. Higher settings produce more reflections while low settings yield fewer initial wall echoes. Use this control in conjunction with DISPERSION to build or reduce the thickness of early reflection clusters heard near the beginning of the reverberation. Ranges from 0% to 99%.
Dispersion	Controls the distance (time) between the echoes set by DENSITY. If DENSITY is set low and DISPERSION is set high, the initial room echoes. Dispersion can be heard as discrete echoes followed by smoother room reverberations. Set DISPERSION low for a dense cluster of reflections during the early portions of DECAY. Ranges from 1 to 5.
Diffusion	Simulates the presence of different room materials by controlling the smoothness of reverberations through the course of DECAY. Low DIFFUSION settings are great for simulating hard, flat surfaces while higher DIFFUSION settings can be used to simulate the presence of irregular surfaces in the room such as natural rock masonry or man-made diffusers. Unlike flat surfaces, these materials reflect (diffuse) the sound in many directions because of the irregularity of the surfaces themselves. This builds smoothness over the reverb progression. Ranges from 0% to 99%.

X-Over Type	Selects which crossover type will be used for the Primary Secondary reverb stages. The two crossover types are High Pass (HP) and Low Pass (LP).
X-Over Freq.	Selects the Frequency where the crossover begins to function. Ranges from 25Hz to 20kHz.
Prim & Secd X-Over	These two Parameters allow the crossover to be turned On or Off for each reverb stage. When Off, that particular stage will be full bandwidth, otherwise its frequency response is limited by the X-Over Type and Frequency Parameters.
Prim & Secd Damp	Adjusts how quickly the room absorbs the high-frequency reverberations. In a real room, absorptive materials can be used to dampen the natural high-frequency reverberations of the room. High settings of DAMP cause the reverberations to darken tonally and become less defined over the course of DECAY. Low settings cause less dramatic room effects on the tone of the reverberations. Ranges from 1 to 7.
Low Pass	Selects the frequency above which all frequencies are rolled off. This control can be used to darken the response of bright-sounding gated reverbs. Ranges from 100 Hz to 8 kHz in the Gated Reverb and from 100 Hz to 20 kHz in the Stereo Gated Reverb.
Time	Controls the length of the gated reverb in milliseconds (much like the DECAY control of a normal reverb). Ranges from 25 milliseconds to 300 milliseconds in the Gated Reverb and from 500 milliseconds in the Stereo Gated Reverb.
Blend	Cross-mixes reverberations from the left side into the right side and vice-versa. This can be used to increase the realism of the simulated room by adding reverberations from different parts of the room to each channel. Ranges from 0% to 99%.
Prim & Secd Blend	Adjusts the amount of BLEND for the Primary and Secondary reverb stages. See BLEND above for a complete parameter description.
Decay	Controls the length (RT60) of the room reverberations. This one control could have been divided among Size and Reflection controls but has been simplified here for easier use. To simulate a large room, use longer DECAY settings. For small rooms, use shorter DECAY settings. For more natural sounding reverbs, you may also want to decrease the DENSITY setting as DECAY is shortened. Ranges from .5 to 23 seconds depending on the Reverb Type currently selected.
Prim & Secd Decay	Controls the length (RT60) for the Primary and Secondary reverberation stages. This Parameter interacts with the SIZE and REFLCT Parameters. Larger SIZE and REFLCT settings will allow longer reverb decay times while smaller settings reduce the length of the reverb decays but produce better small environment emulations. Ranges from .26 to 11 seconds.
Prim & Secd Size	Changes the relative room size of the Primary and Secondary reverb stages. Ranges from 1 to 5.
Prim & Secd Reflect	Controls the simulation of energy loss of sound each time it is reflected. Hard, smooth materials like glass and wood have more reflectivity that softer, more porous materials. This control can be thought of as determining the “liveness” of the room. Ranges from 1 to 10.

Note: The following Delay Parameters that are utilized within the Reverb section are to be used in the Room Echo reverb module.

Delay A	Sets the length of time before hearing Delay Group A. Ranges from 0 to 120 milliseconds.
Delay B	Sets the length of time before hearing Delay Group A and Delay Group B. Ranges from 0 to 120 milliseconds.
Delay C	Sets the length of time before hearing Delay Group B and Delay Group C. Ranges from 0 to 120 milliseconds.
Delay D	Sets the length of time before hearing Delay Group C and Delay Group D. Ranges from 0 to 120 milliseconds.
Out A - D	Controls the output level of the Delay Groups. Ranges from Off to 100%.
Bal A - D	Controls the left/right balance of the Delay Groups. Ranges from -99 to 99.
Shape	Selects the shape of the output levels for the delay group taps. Shape selections are: Flat, Peak, Decreasing, Increasing, Shelf, and Reverse Shelf.
Spread	Controls the width of the effect's stereo imaging. Ranges from 1 to 10.
FB: Dly	Sets the amount of time before the delay is feedback in. Ranges from 0 to 170 ms.
Amount	Sets how much delay is feedback into the signal. Ranges from Off to 50%.
Out L - R	Adjusts the overall level of the left/right side of the reverb. Ranges from Off to 100%.
Prim Out L	Adjusts the overall level of the left side of the Primary reverb. Ranges from Off to 100%.
Prim Out R	Adjusts the overall level of the right side of the Primary reverb. Ranges from Off to 100%.
Secd Out L	Adjusts the overall level of left side of the Secondary reverb. Ranges from Off to 100%.
Secd Out R	Adjusts the overall level of the right side of the Secondary reverb. Ranges from Off to 100%.

Choruses and Flangers

Both choruses and flangers use a Low Frequency Oscillator (LFO) to produce their rich, swirling effects. When you change the speed and depth Parameters of modulation effects, you're actually controlling the frequency and amplitude of the LFO. These settings determine the rate and intensity of the modulation effect.

In general, here's how a chorus works: after entering the Module, the source signal is split into two paths. One is allowed to pass through the Module unaltered, while the other is delayed and pitch modulated with an LFO. The modified sound is then sent to the output, along with the original. In Fig. 4-1 below, a sine wave is used to modulate the pitch of the split sound source.

The Dual Chorus creates two different pitch “voices”, while the Octal Chorus creates eight voices for extremely full, rich sounds .

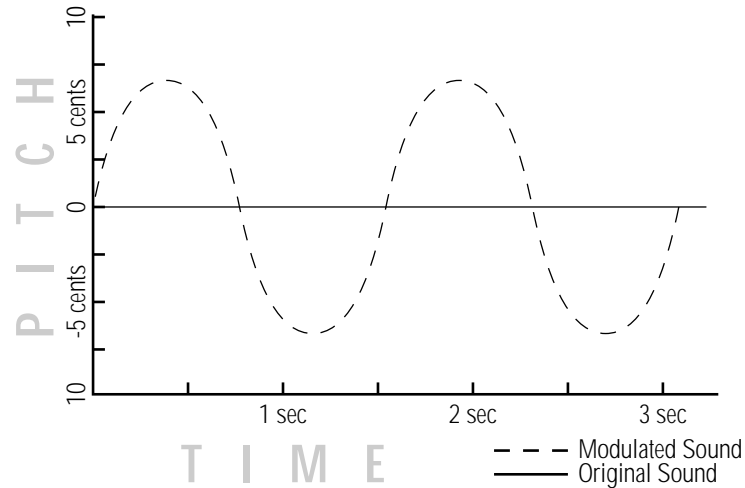

Figure 4-1 Modulation Example

The only difference between choruses and flangers is that flangers use less delay and have a feedback Parameter that sends a portion of the effected signal back to the input of the Module. When the effected signal reaches the input, it is sent through the Module again, building thickness and depth. If you increase the feedback enough, the source begins to lose its own original pitch to the dramatic pitch modulation of the feedback loop.

LFO Waveforms: There are four LFO waveforms available for Choruses, Flangers, Phasers, Tremolos, Auto Panners. They include SINE, TRiangle, SPecial-1, SPecial-2, and SPecial-3. See figure 4-2 for examples of what these waveforms look like.

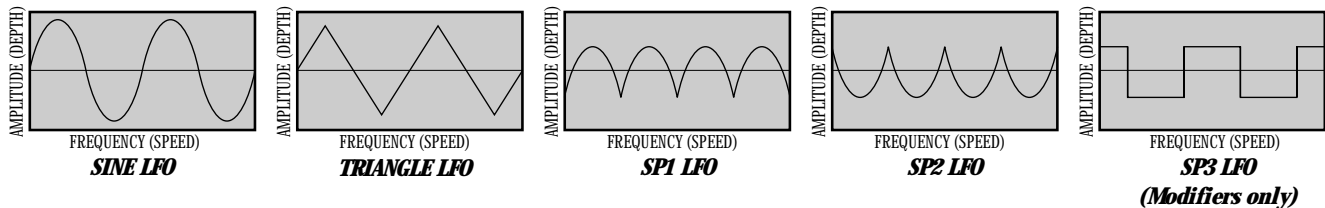

Figure 4-2 LFO Types

Chorus

Chorus is probably the most basic modulation effect. It is really just a very small delay whose time is always changing. As the time is varied, the delayed signal's pitch changes (just like a tape recording's pitch raises when you play it faster). By moving the time back and forth, you hear a sound that goes in and out of tune. When combined with the original sound, it almost sounds like more than one instrument is playing. The Millennium uses several choruses at once to make huge rich sounds. For example, the octal chorus uses eight chorus voices at once to create an incredible ensemble of sound. Aside from the more obvious speed and depth parameters (which adjust respectively how fast and far the sound goes out of tune), the Millennium allows you to use different waveforms. The waveform defines how it will move in and out of tune. The triangle waveform is very popular for slow, shallow chorus settings, while the sine waveform works nicely for faster, deeper settings.

When do I use Chorus? The Chorus effect is so vast in applications, an easier question would probably be “When can’t I use a Chorus. When playing the Blues, turn the Speed and Depth parameters up to produce an almost Leslie-Type effect. When trying to obtain “Big” rock guitar tone, use the Chorus to thicken-up and add depth to your sound. And, any time your using a clean tone program, guitar always sounds so lush when chorus is added.

Chorus Parameters:

Note: not all of the parameters listed below are available in all Chorus modules.

FX: Lvl	Controls the signal input level fed to the Module. Ranges from Off to 100%.
Dry: Lvl	Controls the level of the dry (unaffected) signal. Ranges from Off to 100%.
Balance	Controls the left/right positioning of the dry signal in the stereo soundfield. Ranges from -99 (all left) to 99 (all right).
Speed	Controls the Low Frequency Oscillator (LFO) speed of the chorus. Ranges from 0.06 to 16.0 Hz.
Depth	Adjusts the intensity of the chorus effect. High settings produce dramatic modulation, while lower settings can be used to produce a more subtle, ambient swirling. Ranges from 0 to 30 milliseconds.
Depth 1 - 2	DEPTH1 adjusts the intensity of chorus voices 1-4. DEPTH2 adjusts the intensity of chorus voices 5-8. Ranges from 0 to 30 milliseconds.
Wander Speed	Controls the secondary LFO speed of chorus voices 5-8. This is a secondary oscillator for voices 5-8 that causes deviations from the oscillation path set by DEPTH2. This control can produce radical new textures when used creatively. Try setting it slightly faster or slower than SPEED. Ranges from 0.06 to 2.0 Hz.
Wander Depth	Adjusts the intensity of the oscillation deviations produced by WANDER SPEED. WANDER DEPTH produces dramatic psycho-acoustic swirling effects when set higher than DEPTH2. Ranges from 0 to 10 milliseconds.
WvFrm	Selects which waveform the LFO follows. Options: sine, triangle, SP1 (special 1), and SP2 (special 2). See figure 3-4
Dly A - B	Controls the delay time of chorus voices A and B. Higher delay time settings produce a more dramatic sweeping sound. Ranges from 0 to 60 milliseconds.
Dly C - D	Controls the delay time of chorus voices C and D. Higher delay time settings produce a more dramatic sweeping sound. Ranges from 0 to 60 milliseconds
Dly E - H	Controls the delay time of chorus voices E through H. Higher delay time settings produce a more dramatic sweeping sound. Ranges from 0 to 60 milliseconds
Out A - B	Adjusts the overall level of chorus voice A or B. Ranges from Off to 100%.
Pan A - B	Controls the placement of chorus voice A or B. Ranges from -99 to 99.

Out C - D	Adjusts the overall level of chorus voice C or D. Ranges from Off to 100%.
Pan C - D	Controls the placement of chorus voice C or D in the stereo image. Ranges from -99 to 99.
Out LA - LB	Adjusts the left-side level of chorus voice A or B. Ranges from Off to 100%.
Out RA - RB	Adjusts the right-side level of chorus voice A or B. Ranges from Off to 100%.
Spread	Controls the width of the effect's stereo imaging. The higher the setting, the wider the image. The lower the setting, the more monophonic the effect becomes. Ranges from 1 to 10.

Flanger

A flanger is just a chorus that loops back into itself, causing what can be described as a tubular sound (since it sounds much like the reflections heard inside a large cement or metal pipe). It is still a modulating effect, so you hear a lot of sweeping movement. This makes the flanger a very colorful effect that can be easily overused if you're not careful. The more you feed the flanger back to itself, the more intense the sound becomes.

When do I use Flanger? An electric guitar is the first sound that begs for the flanger effect. It works very well with both clean and distorted guitar sounds. By setting the Speed and Depth parameters to higher settings, this will add more depth and body to the overall guitar signal.

Flanger Parameters

Note: Not all of the parameter listed below are available in all of the Flanger modules.

FX: Lvl	Controls the signal input level fed to the Module. Ranges from Off to 100%.
Dry: Lvl	Controls the level of the dry (unaffected) signal. Ranges from Off to 100%.
Balance	Controls the positioning of the dry signal in the stereo soundfield. Ranges from -99 (all left) to 99 (all right).
Speed	Controls the Low Frequency Oscillator (LFO) speed of the flanger. Ranges from 0.06 to 16.0 Hz.
Depth	Controls the intensity of the flange effect. High settings of DEPTH combined with high settings of FDBCK produce dramatic, synth-like textures. Ranges from 0 to 30 milliseconds.
FdBck	Controls how much of the flanged signal is fed back to the input of the Module. The FDBACK Parameter is what gives flangers their distinctive voice. Flangers are capable of both positive and negative feedback loops, so experiment to find the sound you like best. Ranges from -99% to 99%.
WvFrm	Selects which waveform the LFO follows. Options for this control include sine, triangle, SP1 (Special 1), and SP2 (Special 2). The sine wave setting is probably the most easily recognized, but the smooth response of the triangle

wave or the intensity of SP1 or SP2 typically produce better results. See figure 4-2.

- Dly A - B** Controls the delay time of flange voice A or B. Shorter delay times produce a more dramatic, deeper sweeping sound. Ranges from 0 to 60 milliseconds.
- Out A - B** Adjusts the overall level of flange voice A or B. Ranges from Off to 100%.
- Pan A - B** Controls the stereo soundfield placement of flange voice A or B. Ranges from -99 to 99.
- Out L - R** Controls the output level of the left or right side of the flanger. Ranges from Off to 100%.

Phasers

The Phaser or “Phase Shifter” as it is sometimes called, is a classic effect from the 70’s that uses phase cancellation to create a warm sweeping effect. The effect is created by making a copy of a signal and moving it in and out of phase while mixing it with the original signal. As it moves, different frequencies are cancelled out creating a smooth curling sound. There is also a feedback control that sends the shifting signal back into the phaser’s input. This intensifies the sound even more.

When do I use a Phaser? A great example of this can be heard most when you listen to music of the 70’s. Guitarist of the day loved their Phasers. A Phaser is a great effect to use when playing clean and funky rhythms.

Phaser Parameters:

- Dry: Lvl** Controls the level of the dry (unaffected) signal. Ranges from Off to 100%.
- Balance** Controls the positioning of the dry signal in the stereo soundfield. Ranges from -99 (all left) to 99 (all right).
- Speed** Controls the Low Frequency Oscillator (LFO) speed of the phaser. Ranges from 0.06 to 16.0 Hz.
- Depth** Controls the intensity of the phaser effect. High settings of DEPTH combined with high settings of FDBCK produce dramatic, synth-like textures. Ranges from 0 to 30 milliseconds.
- FdBck** Controls how much of the flanged signal is fed back to the input of the Module. The FDBACK Parameter is what gives phasers their distinctive resonating sound. Ranges from -99% to 99%.
- WvFrm** Selects which waveform the LFO follows. Options for this control include sine, triangle, SP1 (Special 1), and SP2 (Special 2). The sine wave setting is probably the most easily recognized, but the smooth response of the triangle wave or the intensity of SP1 or SP2 typically produce better results. See figure 4-2.
- Out A - B** Adjusts the overall level of phaser voice A or B. Ranges from Off to 100%.
- Pan A - B** Controls the stereo soundfield placement of phaser voice A or B. Ranges from -99 to 99.
- Out L - R** Controls the output level of the left or right side of the flanger. Ranges from Off to 100%.

Rotary Speaker Simulator

The Rotary Speaker Simulator allows you to emulate the classic rotating speaker sound, without the chiropractic problems that come with moving bulky speaker cabinets. The Rotary speaker is directly responsible for some of the most unique sounds in music. The applications for this effect are so diverse, it can be used to achieve sounds ranging from the Allman Brothers Band to the legendary Stevie Ray Vaughan.

A unique parameter in the Rotating Speaker simulation is the Acceleration parameter. This parameter is used emulate the the time that it takes to get the Speaker up and spinning at full speed. The parameter can be assigned to a footswitch on the J-12 or an External external expression pedal so you can control the acceleration speed.

Rotary Speaker Simulator Parameters:

FX: Lvl	Controls the signal input level fed to the Module. Ranges from Off to 100%.
Dry: Lvl	Controls the level of the dry (unaffected) signal. Ranges from Off to 100%.
Balance	Controls the positioning of the dry signal in the stereo soundfield. Ranges from -99 (all left) to 99 (all right)
Mode	Selects which speed mode the Rotor and Horn are in. Settings are fast or slow.
Spread	Sets the horn stereo microphone spread. Ranges from 0 to 100%.
H - R: Level	Sets the overall level of the Rotor or Horn. Ranges from Off to 100%.
Slo - Fast Hrn Speed	Controls the Low Frequency Oscillator (LFO) speed of the Horn. Ranges from 0.06 to 16.0 Hz.
Slo - Fast Hrn Depth	Controls the intensity of the rotating effect. Ranges from 0 to 30 milliseconds.
Slo - Fast Hrn Doppler	Sets the amount of shifted pitch heard in the Horn. Ranges from 0 to 50 milliseconds.
Slo - Fast Rtr Speed	Controls the Low Frequency Oscillator (LFO) speed of the Rotor. Ranges from 0.06 to 16.0 Hz.
Slo - Fast Rtr Depth	Controls the intensity of the rotating effect. Ranges from 0 to 30 milliseconds.
X-Over	Selects the frequency where the signal is split between the Horn and Rotor. Ranges from 25Hz to 20kHz.
Acceleration: H - R	Sets the amount of time that the Rotor and Horn take to come up to their full rotating speed. Ranges from 0 to 10 seconds.

Tremolo and Auto-Panner

Look out, because the popular Tremolo and Auto panner effects of the 50's and 60's are back with a vengeance. These effects that revolutionized "Surf-Style" music can be heard all over the air waves in the 90's. Tremolos and auto panners are similar to one another in that they both use an LFO to modulate input levels to produce vibrato effects.

Tremolo

The word tremolo actually has several definitions in the music world. It basically means that a sound is being modulated in amplitude (the volume is beating or pulsing). It could be emulated by turning a volume knob up and down. But you probably have better things to do than turn a volume control up and down throughout a whole song, so let the Millennium do it for you.

Aside from speed and depth parameters, the tremolo also has an LFO waveform that determines the way a signal's volume is increased and decreased. While the Sine wave is probably the most common to the ear, the Triangle and Special 2 waveforms are progressively more intense.

When do I use Tremolo? Tremolo is truly a vintage sound for the guitar, electric piano and organ. Most pronounced on the guitar, you can hear it used on everything from sweet ballads to blues rock 'n roll.

Auto Panner

The auto panner is really just a dual version of a tremolo. It changes the amplitude of the left signal just as a tremolo does, but the amplitude of the right signal is inverse to that of the left signal. This gives the illusion that the signal is moving back and forth between the left and right speakers.

The Auto Panner's Speed typically doesn't get set as fast as the Tremolo since you usually want a sound to move smoothly back and forth in the stereo image. The Millennium auto panner is especially flexible since it can be used for either mono or stereo input sources. When used with a mono source, the signal pans back and forth as described earlier. When a stereo sound source is used, the original stereo image is maintained by moving the volume of the left signal exactly opposite of the right signal. The stereo image fades back and forth between the stereo extremes.

When do I use an auto panner? The auto panner can be a very creative tool. When running your guitar rig in a stereo set-up with the right amount of cabinet separation, the Auto-Panner creates a stereo panning effect that is right out of this world.

Auto panners can also add life to delays or choruses by moving them around instead of just sitting in one place in the mix. Simply place an auto panner module after a delay or chorus module. You don't need to set the auto panner's depth parameter too deep since you just want some gentle movement.

Tremolo & Auto Panner Parameters:

FX: Lvl	Controls the signal input level fed to the Module. Ranges from Off to 100%.
Speed	Controls the Low Frequency Oscillator (LFO) speed of the effect. Ranges from 0.06 to 16.0 Hz.
Depth	Controls the intensity of the effect. As DEPTH increases, volume changes become more dramatic. Ranges from 0 to 30 milliseconds.

WvFrm Selects which waveform the LFO follows. Options for this control include sine, triangle, SP1 (Special 1), and SP2 (Special 2). The sine wave setting is probably the most easily recognized, but the smooth response of the triangle wave or the intensity of SP1 or SP2 typically produce better results. See figure 4-2 on page 41.

Pitch Shifters and Harmony

The pitch shifter allows you to move sound from one pitch to another. It accomplishes this by recording a small part of the original sound and then playing it back either faster (to raise the pitch) or slower (to lower the pitch). It does this over and over again to create a new pitch.

The Harmony modules give you almost unlimited possibilities. you can use different harmony intervals to produce slide guitar effects. or Major or Minor 3rd intervals to create dual soling lines reminiscent of the Eagles' "Hotel California".

When do I use pitch shifting? Guitarists are probably the most well known users of pitch shifters. They commonly pitch shift their sound down by an octave to get a deep rumble out of their distortion, or shift it an octave up to emulate a 12 string guitar.

Both guitar and synth players have created some amazing textures by pitch shifting their sound up a fifth (7 semitones). This creates more complex chords out of simple ones (e.g. a basic Cmaj chord sounds like a Cmaj9 chord, or Cmin7 becomes a Cmin11 chord). Lead lines sound amazing when using major 5th intervals up.

Pitch Shifters Parameters

Note: not all of the parameters listed below are available in all Pitch Shifter modules.

FX: Lvl	Controls the signal input level fed to the Module. Ranges from Off to 100%.
Dry: Lvl	Controls the level of the dry (unaffected) signal. Ranges from Off to 100%.
Balance	Controls the positioning of the dry signal in the stereo soundfield. Ranges from -99 (all left) to 99 (all right)
Shft A - B	SHFTA and SHFTB control the pitch intervals between the original note and voices A and B of the pitch shifter. Pitch shifters can be used for a wide variety of effects, including doubling, octave division, and chromatic harmonies. Each Pitch Shifter has a 4-octave range, stepped in semitones from -24 to +24.
Dtn A - B	Controls the detuning amount for pitch-shifted voices A and B. As DTN moves away from zero, dissonance becomes more pronounced. Low DTN settings can be useful for thickening or enhancing the imaging of the source material. Ranges from -50% to 50%.
Shft C - D	See Shift A - B.
Dtn C - D	See Dtn A - B.

Shft E - H	See Shift A - B.
Dtn E - H	See Dtn A - B.
Key	Sets the diatonic key for the harmonies. If the song you are playing is in the key of G Major, you would select G for the scale.
Scale	Sets the scale type for the Harmony you want to hear. Scale types include: Major, Minor, Harmonic Minor, Melodic Minor, Dorian, Mixolydian, Lydian, Lydian Augmented, Major Pentatonic, Minor Pentatonic, Blues, Whole Tone, Half-Whole, and Whole-Half.
Interval	Sets the basic interval of the Harmony. You can choose from one of several Harmony intervals. See the Harmony Interval Charts for reference.
Out A - B	Adjusts the overall level of pitch-shifted voice A or B. Ranges from Off to 100%.
Pan A - B	Controls the placement of pitch-shifted voice A or B in the stereo image. Ranges from -99 (all left) to 99 (all right).
Out C - D	Adjusts the overall level of pitch-shifted voice C or D. Ranges from Off to 100%.
Pan C - D	Controls the placement of pitch-shifted voice C or D in the stereo image. Ranges from -99 (all left) to 99 (all right).
Out E - H	Adjusts the overall level of pitch-shifted voice E through H. Ranges from Off to 100%.
Pan E - H	Controls the placement of pitch-shifted voice E through H in the stereo image. Ranges from -99 (all left) to 99 (all right).
Out L - R	Adjusts the left or right output level of the pitch-shifted voice. Ranges from Off to 100%.
Out LA - LA	Adjusts the left-side level of pitch-shifted voice A or B. Ranges from Off to 100%.
Out RA - RB	Adjusts the right-side level of pitch-shifted voice A or B. Ranges from Off to 100%.
Spread	Controls the width of the effect's stereo imaging. The higher the setting, the wider the image. The lower the setting, the more monophonic the effect becomes. Ranges from 1 to 10.

Detuners

The detuner effect does exactly what its name implies; it detunes a sound (moves it out of tune) and allows you to add it to the original sound. The result can be almost chorus-like, but it doesn't move like the chorus effect does. This actually makes the detuner more transparent and not quite as thick as the chorus effect, which in many applications is a good thing (since effects can quickly pile up and clog up great sounding audio).

When do I use a detuner? The detuner falls into the same guidelines as the chorus effect. It works with just about everything; It is ideal for thickening up a rhythm guitar track. Remember to experiment with the delay parameters if you are looking for a wider detuning sound. Adding 30-60 ms of delay to the detuner's voices that are panned hard to one side (while not delaying the other side) will change the detuner's stereo imaging greatly.

Detuner Parameters

FX: Lvl	Controls the signal input level fed to the Module. Ranges from Off to 100%.
Dry: Lvl	Controls the level of the dry (unaffected) signal. Ranges from Off to 100%.
Balance	Controls the positioning of the dry signal in the stereo soundfield. Ranges from -99 (all left) to 99 (all right).
Dtn A - B	Controls the detuning amount for detuner voices A and B. Higher detune settings produce a more dissonant sound. Ranges from -50% to 50%.
Dtn C - D	Controls the detuning amount for detuner voices C and D. Ranges from -50% to 50%.
Dtn E - H	Controls the detuning amount for detuner voices E through H. Ranges from -50% to 50%.
Dly A - B	Controls the amount of time before detuner voices A and B are heard. Higher delay time settings produce a short slapback delay effect. Ranges from 0 to 60 milliseconds.
Dly C - D	Controls the amount of time before detuner voices C and D are heard. Ranges from 0 to 60 milliseconds.
Dly E - H	Controls the amount of time before detuner voices E through H are heard. Ranges from 0 to 60 milliseconds.
Out A - B	Adjusts the overall level of detuner voice A or B. Ranges from Off to 100%.
Pan A - B	Controls the stereo soundfield placement of detuner voice A or B. Ranges from -99 (all left) to 99 (all right).
Out C - D	Adjusts the overall level of detuner voice C or D. Ranges from Off to 100%.
Pan C - D	Controls the stereo soundfield placement of detuner voice C or D. Ranges from -99 (all left) to 99 (all right).
Out LA - LB	Adjusts the left side level of detuner voice A or B. Ranges from Off to 100%.
Out RA - RB	Adjusts the right side level of detuner voice A or B. Ranges from Off to 100%.
Spread	Controls the width of the effect's stereo imaging. The higher the setting, the wider the image. The lower the setting, the more monophonic the effect becomes. Ranges from 1 to 10.

Delays

A delay produces discrete, repeating echoes of the source material at a specified interval. In digital delays, the input signal is "sampled" or recorded into memory, where it is held for the amount of time you specify with the delay time setting, after which the sample is replayed at

the output. The Millennium delays have a feedback meter that is used to send a portion of the delayed signal back to the input to be re-recorded along with new source material. The feedback setting determines how long the delay repeats take to decay to inaudibility.

When do I use delay? When you're the lone guitarist in a band, the Delay can be your best friend. The Delay repeats can create the illusion that there is more than one guitar being played. One trick to using delays effectively is setting the delays to fall in time with the music. This used to mean grabbing a calculator, dividing 60 by the tempo (beats per minute), then dividing that answer by the desired sub-beats . . . Sound like a hassle? Yeah, we thought so too. So the Millennium takes care of all the calculations for you! All you have to do is tap the TapIt <button> or (assign the tapit parameter to a footswitch on the J-12 or J-3) and manually tap in the desired delay time and the new time is added.

Another common use for delay is for stereo imaging. Very small amounts of delay (10-25ms) can be used to make a signal sound like it is panned to one side. This trick works because of the way the brain interprets sounds. When your left ear hears something before the right ear, it thinks that the source of that sound is found somewhere to your left. You can also use delays set at 30-60ms, which spreads a sound to the extremes of the stereo image. Be careful with this technique if your mix has a chance of being listened to in mono.

Delay Parameters

Note: not all of the parameters listed below are available in all Delay modules.

FX: Lvl	Controls the signal input level fed to the Module. Ranges from Off to 100%.
Dry: Lvl	Controls the level of the dry (unaffected) signal. Ranges from Off to 100%.
Balance	Controls the positioning of the dry signal in the stereo soundfield. Ranges from -99 (all left) to 99 (all right).
Dly Time	Sets the maximum delay time available to each delay voice. For example, if DELAYTIME is set to 1000 ms, each delay voice can be set from 0 to 100% of that delay time. Ranges from 0 to 1.4 seconds (Maximum delay times differ between 4th, 3/4, HLF, and FUL module Types.) Half bandwidth delay times automatically double the set delay time used used.
FdBck	Controls the fade time of the delay repeats. Higher settings take longer to fade out, while a setting of zero could be used to limit the delay to one repeat per voice. The delay provide both positive and negative feedback settings. Ranges from -99% to +99%.
TapIt	Allows you to change DELAYTIME in real-time, by tapping the TAPIT button at the tempo you want. Delay voice percentages do not change when using this control.
Smear	Sets the spread of Diffusion of the Delay Repeats. Ranges from 0 to 100%.
LPF	Selects where the Low Pass Filter is positioned within the Delay Module. Positions are: Pre Delay or Post Delay.
Frequency	Selects the Frequency band that appears in the LPF. Ranges from 25 Hz to 20 kHz.
Gain	Controls the output gain of the LPF. Ranges from -12 to 12.

Dly A - B	Controls the percentage of DELAYTIME allocated to delay voices A and B. For example, if DELAYTIME (above) is set to 1000 ms and DLYA is set to 75%, the voice A delay time is 750 ms. Remember, each voice in the Module can have any delay time up to 100% of DELAYTIME. Ranges from 0% to 100%.
Dly C - D	See Dly A - B.
Out	Adjusts the overall level of the Delay. Ranges from Off to 100%.
Pan	Controls the stereo soundfield placement of the delay. Ranges from -99 (all left) to 99 (all right).
Out L - R	Adjusts the left or right output level of the Delay. Ranges from Off to 100%.
Out A - B	Adjusts the output level of delay voice A or B. Ranges from Off to 100%.
Pan A - B	Controls the stereo soundfield placement of delay voice A or B. Ranges from -99 (all left) to 99 (all right).
Out C - D	Adjusts the output level of delay voice C or D. Ranges from Off to 100%.
Pan C - D	Controls the stereo soundfield placement of delay voice C or D. Ranges from -99 (all left) to 99 (all right).
Out LA - LB	Adjusts the left-side output level of delay voice A or B. Ranges from Off to 100%.
Out RA - RB	Adjusts the right-side output level of delay voice A or B. Ranges from Off to 100%.
Out LC - LD	Adjusts the left-side output level of delay voice C or D. Ranges from Off to 100%.
Out RC - RD	Adjusts the right-side output level of delay voice C or D. Ranges from Off to 100%.

Compressor

Compressor Parameters

Level	Controls the signal input level fed to the module. Ranges from Off to 100%.
Threshold	Sets the threshold level of the compressor. Ranges from -27 to 0.
Ratio	This parameter sets the compressor ratio. Ranges from 1.5 to 40.
Gain	This parameter controls the amount of gain in the compressor. Ranges from 0 to 200%.
Attack	This parameter controls the attack time of the compressor. Settings are: Slo, Med and Fast.
Release	This parameter sets the release of the compressor. Settings are: Slo, Med and Fast.
Delay	This parameter sets the delay time of the compressor. Ranges from 0 to 10 ms.

Equalizers

The Millennium has a broad selection of equalizer Modules to cover virtually any need. If you need bigger Guitar tone, the EQs will give it to you. Both mono and stereo modules are available. Remember that mono equalizers connected to stereo sources will always sum the stereo signal together for equalization (thus eliminating the stereo image). If you need to maintain the stereo image, use a stereo equalizer module.

The Parametrics allow you to cover very specific regions of the sound spectrum with extreme precision and control. Up to 6 bands of either stereo, or mono parametric equalization are available.

The Graphic equalizers use $1/3$, $2/3$, or $1\ 2/3$ octave ISO-standard frequency centers. Equalization or EQ is probably one of the most valuable tools the Millennium offers. EQ allows you to change the level of certain frequencies of a sound, and it comes in two different basic flavors: graphic and parametric. Graphic is the most common and easiest to use, but the parametric offers much more flexibility and power.

When do I use EQ? This may seem overly simplistic, but you should use EQ whenever your ears tell you to use it! However, you need to remember that EQ can do more harm than good when not used carefully. The EQ can take that thin and “Clangy” sounding Guitar and add all of the low end in the world that your heart may desire. This can also be used on the other side. If you have a song that needs tight and bright rhythm guitar, you can use the EQ modules to take out the Lows and build up your mids

Here are a couple of simple examples:

If you feel your guitar tone is just a little dull, try cutting some of the lower frequencies, you always have to boost up the guitar's' high frequencies, because it could quickly become too bright. Often, good EQ techniques use cut more than boost. This is where the old saying “less is more” definitely applies.

If you are having a hard time being heard in the mix, don't make it louder. Listen carefully and see if there is another instrument that is conflicting with your Guitar. Adding a little EQ in the right spot of the less dominant guitar will allow it to speak a little easier through the rest of the music.

Graphic Equalizers

Graphic EQs give you control of the levels for fixed or pre-selected frequencies (bands) that are evenly spaced. The Millennium offers 8 and 15 band Mono and 8-band Stereo GEQs and a 31 band mono GEQ. They all cover the complete range of frequencies, but the spacing between the 31 bands is much closer than the 8 bands, therefore offering more exact control of the sound.

Graphic Equalizer Parameters

Level	Controls the signal input level fed to the Module. Ranges from Off to 100%.
Phase	Inverts the phase of the source signal. Can be set either IN or OUT of phase.
Phase L - R	Inverts the phase of the left or right side of the stereo source signal. Can be set either IN or OUT of phase.
Freq	Controls the amount of boost / cut applied to the selected frequency. The GEQ 8 uses $1\text{-}1/3$ octave ISO standard frequency centers, (Hz) while the GEQ15 and GEQ31 use $2/3$ octave and $1/3$ octave frequencies. Boost/cut range for each band is from -12 to 12.

Parametric Equalizers

Parametric EQs offer the added flexibility of letting you define the center frequency you want to adjust, and how many frequencies around that center frequency you want to affect. Some of the PEQ modules in the Millennium, also include high shelf and low shelf EQ bands. A high shelf allows you select a frequency, and the boost/cut parameter changes the level of all the frequencies above that selected frequency. The low shelf works the same way but works on frequencies below the selected frequency.

Parametric Equalizer Parameters

Level	Controls the signal input level fed to the Module. Ranges from Off to 100%.
Phase	Inverts the phase of the source signal. Can be set either IN or OUT of phase.
Phase L - R	Inverts the phase of the left or right side of the stereo source signal. Can be set either IN or OUT of phase.
LoShlv Freq	Selects the center frequency of the low-frequency shelving EQ band. Ranges from 25Hz to 20kHz.
LoShlv Level	Adjusts the amount of boost or cut applied to the center frequency of the low-frequency shelving EQ band (selected by LOSHLV FREQ). Ranges from -12 to 12.
Band # Freq	Sets the center frequency of the selected band. 6-band PEQs have four true parametric bands of EQ plus shelving high- and low-frequency controls with variable frequency. Bands 1 and 2 range from 25 Hz to 20 kHz. Bands 3 and 4 range from 1 kHz to 20 kHz.
Band # Width	Controls the bandwidth of the selected frequency. The higher the setting of WIDTH, the more frequency-selective the boost/cut becomes. In other words, with low (narrow) WIDTH settings, frequencies around the selected center frequency are not affected by the LEVEL setting. As WIDTH increases, frequencies around the center frequency become affected by the setting of LEVEL. Range is from 0.08 to 4.00 kHz.
Band # Level	Adjusts the amount of boost or cut applied to the selected frequency. Varies from -12 to 12.
HiShlv Freq	Selects the center frequency of the high-frequency shelving EQ band. Ranges from 1kHz to 20kHz.
HiShlv Level	Adjusts the amount of boost or cut applied to the center frequency of the high-frequency shelving EQ band (selected by HISHLV FREQ). Ranges from -12 to 12.

Multi Effects Modules - Chorus/Delay and Flange/Delay

The Millennium, Multi Effect Modules allow the User to combine either Delay and Chorus or Delay and Flange within one Effect module block. This is ideal for situations where the User needs to add another effect to the Effect Configuration, but is running low on signal processing resources. Within the module, there is a unique parameter that allows you route the signal several different ways between the two effects.

Multi-Effect Module Parameters

FX: Lvl	Controls the signal input level fed to the Module. Ranges from Off to 100%.
----------------	---

Dry: Lvl	Controls the level of the dry (unaffected) signal. Ranges from Off to 100%.
Balance	Controls the positioning of the dry signal in the stereo soundfield. Ranges from -99 (all left) to 99 (all right).
Route	Selects the route signal path within the Chorus/Delay, and Flange/Delay Multi effects modules. The 3 settings are: 1) Chorus/Flange into Delay with feedback into the Delay 2) Chorus/Flange into Delay with feedback into Chorus/Flange 3) Delay into Chorus/Flange with feedback thru the Chorus/Flange.
Speed	Controls the Low Frequency Oscillator (LFO) Speed of the Chorus or Flanger. Ranges from 0.06 to 16.0 Hz.
Depth	Adjusts the intensity of the Chorus or Flanger effect. Ranges from 0 to 30 milliseconds.
Feedback (Flanger)	Controls how much of the flanged signal is fed back to the input of the Module. The FDBACK Parameter is what gives flangers their distinctive voice. Flangers are capable of both positive and negative feedback loops, so experiment to find the sound you like best. Ranges from -99% to 99%.
WvFrm	Selects which waveform the LFO follow. Options for this control include: Sine, Triangle, SP1 (Special 1), and SP2 (Special 2).
C/F: Delay	Controls the delay time of the Chorus or Flanger voice. Ranges from 0 to 40 milliseconds.
Delay Time	Sets the delay time for the delay tap. Ranges from 0 to 300 milliseconds.
Feedback	Controls the fade time of the delay repeats. Higher settings take longer to fade out, while a setting of zero will limit the delay to one repeat. Ranges from 0 to 99%.
TapIt	Allows you to change the Delay time in real-time by tapping the TAPIT button at the tempo you want. Delay voice percentages do not change when using this control.
Level: C/F/D	Controls the overall output level of each effect block. Ranges from Off to 100%.
Pan: C/F/D	Controls the stereo soundfield placement of each effect block. Ranges from -99 (all left) to 99 (all right).

Whammy Effects

In today's music industry, it seems that every album on the charts, whether it be Country, Rock, Industrial, or Alternative, are using the Whammy technology in some shape or form. Whether it be a subtle chorus Detune, or an all out 2 octave Whammy Dive, this thing is a definite attention getter, and first-call studio effect. At this rate, the Whammy effect could possibly log-in as much studio time as Chet Atkins.

Whammy Effect Parameters

Whammy On/Off Turns the Whammy module on or off. When the module is turned off, the signal will only continue to pass through the module if the dry level is turned up.

FX Level	This parameter lets you select the overall FX level mix of the Whammy Effect module. Ranges from: Off to 100%.
Dry Level	This parameter lets you select the amount of Dry signal that is included in the Whammy effect. Ranges from: Off to 100%.
Balance	This parameter allows you to pan the Dry signal either to the Right or the Left in the stereo soundfield. Ranges from Left 99 to Right 99.
Min Shift	This parameter sets the minimum pedal shift level of the Whammy effect. Ranges from: -72 (6 octaves down), to 24 (2 octaves up).
Max Shift	This parameter set the maximum pedal shift level of the Whammy effect. Ranges from: -72 (6 octaves down), to 24 (2 octaves up).
Min Detune	This parameter sets the minimum pedal level of detune effect. Ranges from: -50% (down 50 cents), to 50% (up 50 cents).
Max Detune	This parameter sets the maximum pedal level of detune effect. Ranges from: -50% (down 50 cents), to 50% (up 50 cents).
Pedal	This parameter is used for the assignment of an expression pedal. This parameter also shows the pedal travel range. Ranges from: 0 to 100
Out	This parameter is used to set the overall output level of the Whammy module. Ranges from: 0 to 100%
Pan	This parameter is used to position the Whammy effect in the Stereo soundfield. Ranges from: Left 99 to Right 99.

Auto Wah

Break out the Bell-bottom jeans and the Disco mirror balls, because the Auto-Wah is here to play. The Auto Wah is a great effect use when you want a nasally wah-type effect, but you don't want to do the leg work. The Auto Wah utilizes a sensitivity detector that reads the input signal, then simulates the action of a wah pedal.

Auto Wah Effect Parameters

Auto Wah On/Off	Turns the Auto Wah module on or off. When the module is turned off, the signal will continue to pass through the module.
FX Level	This parameter lets you select the overall FX level mix of the Auto Wah Effect module. Ranges from: Off to 100%.
Sensitivity	This parameter adjusts the sensitivity of the detection of the automatic wah. The higher the sensitivity is set, the wider the Wah range will be. Ranges from: Off to 100%.

Section-5 Advanced Topics

Assigning Modifiers

Modifiers are unique tools that can be used to dramatically alter your sound based on information from External expression pedals and external footswitches, signal amplitude, the settings of a Low Frequency Oscillator (LFO) or MIDI Continuous Controller.

Every Preset in your Millennium has a set of Modifiers. Up to 16 Modifier links can be assigned to control any parameter. There are five types of Modifiers that can be linked to a parameter:

- External expression pedal
- The foot pedals and switches on the optional Johnson Amplification J-12 foot controller.
- LFOs
- MIDI CCs
- Dynamic (signal amplitude dependent).

MIDI CCs

When you use MIDI CCs, the Millennium responds to CC numbers 0-127 and CHP (channel pressure or aftertouch). This means that you could assign an Expression pedal, a keyboard's modulation or pitch bend wheel, or any other MIDI CC device to control effect Parameters.

LFOs

When you use LFOs, Parameter values can be controlled automatically between a defined minimum and maximum setting at a rate set by the user. The Millennium has 2 user definable LFOs in each preset that can be assigned to any Parameter.

For example, you can create an auto panner without using an auto panner module. Simply link an effect's output pan parameter to the LFO modifier and the LFO will move that parameter back and forth. This modifier can be a very useful weapon in the ongoing battle of new sound creation. There are two LFOs available in each preset that can use unique speeds and waveforms.

Dynamic Modifiers

When you use Dynamic Modifiers, the Parameter values are controlled in relation to the dynamics of the input signal. The possibilities are nearly endless, and they cannot be duplicated using any other method.

For example, you could link the Dynamic Modifier of a Preset to control a chorus level. It doesn't sound like much on paper, but imagine the expressiveness of this type of effect on the guitar part. As the dynamics of the music increase, the chorus becomes less apparent. Ease up on the string attack a little and the chorus increases. ALL IN REAL TIME!

***NOTE:** Linking a Modifier to a Parameter causes the Parameter to change as if you were changing it using the <Preset/Effect> wheel. The only difference is that the <Store> button and **CHANGED** icon do not light. Therefore, the Default name may display 'Custom' if a parameter is consistently being changed by a Modifier. Storing the Preset will store these new parameter values.*

External Expression Pedals

The rear panel of the Millennium contains 2 external expression pedal inserts that can be linked to control any parameter of the Amplifier operating system. Either a Standard Volume or a Voltage control pedal can be connected to these insertion jacks. The 2 External Expression pedals on the J-12 foot controller can be used as well.

Once the External Expression pedal is connected, the assignment procedure to be followed is listed below.

Linking a Parameter to a Modifier

To link a parameter to a Modifier, please complete the following steps:

1. Scroll to the parameter you would like to link to a modifier (ie: Delay feedback).
2. Press the <Assign> button and the display appears something like:



3. Turn the <1> knob to turn the link for that parameter on. The display will look something like this:

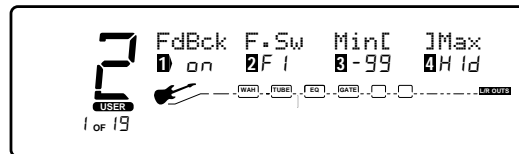

4. Use the <2> knob to scroll through the different modifiers that can be linked to the parameter you want assigned. The selections are:
 - MIDI CC's (CC): 0-127 & ChP (aftertouch)
 - Real Time modifiers (RT): LF1, LF2, dY1, & dY2
 - External Pedal (Ext): Pd1, (Pd3) when the J-12 is connected.
 - J-12 (F.Pdl & F.Sw): Pdl-2 & F1-10

NOTE: The MUTE and THRU effect types do not have any Parameters to connect to, so they will not appear in the parameter list.

5. Use the <3> knob to select the minimum parameter value you want when the controller is in the maximum position.
6. Use the <4> knob to select the maximum parameter value you want when the controller is in the maximum position.

NOTE: Make sure you store any changes you want to save before moving on.

Setting up an LFO

To set up an LFO that is linked to an effect parameter, the procedure is as follows:

1. Enter Assign Mode by pressing the <Assign> button.
2. Use the <Page> knob to scroll to the LFO page. The display looks something like:

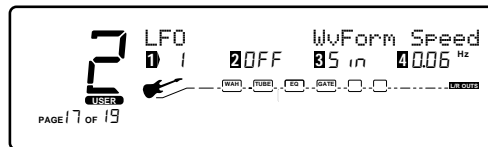

3. You can use the <1> knob to select which of the two LFOs you want to adjust.
4. Use the <2> knob to turn the LFO on or off.
5. Use the <3> knob to change the selected LFO's waveform. You can select SINE, TRiangle, SPecial1, SPecial2.
6. Use the <4> knob to adjust the speed of the LFO cycle.

Any parameters assigned to the LFOs will now follow the modulating waveform of the LFO you selected.

Setting up a Dynamic Modifier

1. Enter assign Mode by pressing the <Assign> button.
2. Use the <Page> knob to scroll to the first of two Dyn pages. The display looks something like:

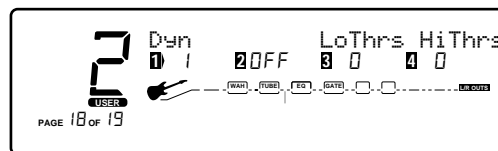

3. You can use the <1> knob to select which of the two Dyns you want to adjust.
4. Use the <2> knob to turn the Dyn on or off.
5. Use the <3> knob to set the threshold above which dynamic modification of the parameter begins.
6. Use the <4> knob to set the point at which maximum Parameter modification occurs.
7. Use the <Page> knob to scroll to the next Dyn page.

8. Use the <2> knob to adjust the attack time of the Dyn.
9. Use the <3> knob to adjust the hold time of the Dyn.
10. Use the <4> knob to adjust the release time of the Dyn.

Morphing Pedal Assignments

The Johnson Amplifier Modules and the Effect Configurations within the Millennium have special Morphing capabilities that allow you to morph between one Amplifier type to another in selected Amplifier models. This feature is also available in certain Effect configurations so you can pan between effects. This will allow you to either morph from a distorted Tube Amplifier type, to a clean Solid State Amplifier type or morph between Digital effects. Morphing can be done by linking an Expression Pedal to the Morph pedal parameter.

Amplifier Morphing

To assign the morphing pedal to morph between amplifier types use the following procedure.

1. Amplifier type morphing must be done using a Johnson Amplifier model. So, from Preset mode, press the <Johnson> button until the signal path in the display shows an amplifier model that uses dual amplifier modules and are displayed something like this:

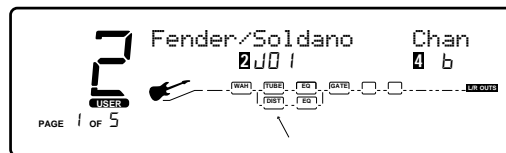

2. Using either the <Channel> button or the <4> knob, press (or turn) until both of the channel (A&B) LEDs light and the display appears like this:

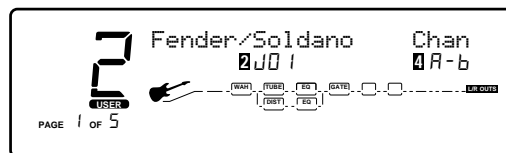

3. At this point, you want to assign the Morphing pedal by pressing the <Config> button and the display will appear something like this:



4. Now using the <Page> knob, turn to page 2 and the display will appear like this:

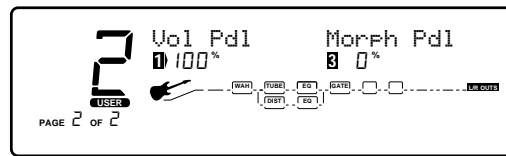

5. By turning the <3> this will activate the Morph pedal parameter making it ready for assignment. Now press the <Assign> button and the display will appear something like this:



6. Now select the Expression pedal to be assigned. This can be either the one of the two expression pedal inserts located on the rear of the unit, or one of the two Expression Pedals on the J-12 foot controller and the display will appear something like this:

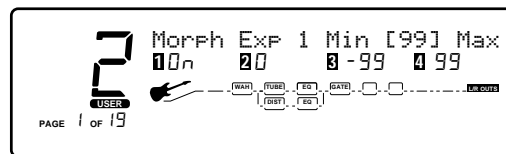

7. In this example, Expression pedal 1 of the J-12 is now assigned to morph between Solid State and Tube distortion models. Note that -99 as the minimum value represents the Solid State (bottom) Amp and the Maximum being 99, represents the Tube (top) distortion. To return to Preset mode, press the <Preset> button. Always remember to save any changes.

Morphing Between Effect Modules

Not only does the Millennium allow you to Morph between Amplifier modules, but it also gives you the ability to morph between effect modules. This can be done when using Effect Configurations 6, 12 or 15 which are split configurations.

The procedure for assigning the morph pedal to the Effect Modules uses the same steps as 3 through 7 of the Amplifier Morphing assignment procedure.

Volume Pedal Assignments

Volume control can be assigned to any preset within the Millennium. When volume control is used in a selected preset, you have the option of using either one of the two Expression pedal inserts (located on the rear of the unit), or the Expression pedal available on the optional J-12 foot controller.

The procedure for assigning volume control to any preset of the Millennium is as follows:

1. From Preset mode, you must get to the configuration screen by either pressing the **<Edit>** button and turning the **<Preset/Effect>** wheel, or simply press the **<Config>** button until the display appears something like this:

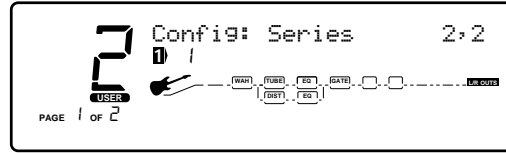

2. Now turn the **<Page>** knob to page 2 and the display will appear like this:

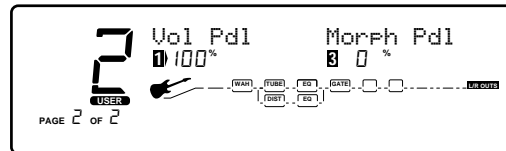

3. Now turn the **<1>** knob making the Volume Pedal parameter active for assignment to an Expression pedal. Now press the **<Assign>** button and the display will appear like this:

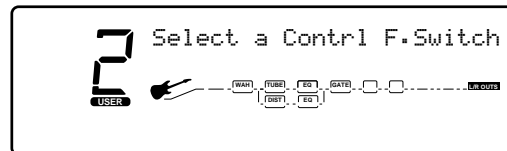

4. Now all you have to do is select the Expression Pedal that want to assign the Volume Pedal parameter control to and move the pedal and the display will appear something like this:

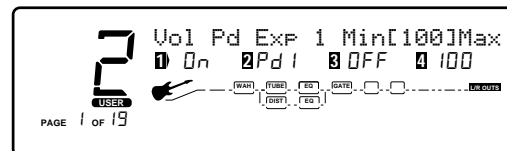

5. Now that the assignment has been made, make sure that you store your changes and press the **<Preset>** button to return to Preset mode.

MIDI Functions

In this day and age where the role of the Guitarist has taken on so many new responsibilities, his or her equipment has to be fast, and has to be able to communicate with other devices at the drop of a hat. So, we at Johnson Amplification have given the Millennium all of the MIDI goodies that your heart may desire.

Setting the MIDI Channels

This option sets the MIDI Channel that the Millennium will respond to MIDI preset changes and CC messages and transmit preset changes on. MIDI channel settings include: Off, 1, 2,...15, 16, and All.

To change the MIDI channel assignment, do the following:

1. Go to Page 3 of the Utility menu by pressing the <Utility> button and then turn the <Page> knob. The display reads:



2. Use the <2> knob to select the MIDI channel number you want your Millennium to receive on.
3. Use the <4> knob to select the MIDI channel number you want your Millennium to transmit on.

MIDI Merging

MIDI merging allows incoming MIDI data to be merged with any MIDI data generated by your Millennium before being sent to the MIDI Out/Thru port. Selecting the MIDI Merge option can be accessed in Page 6 of the Utility menu. Once there, the display will look like this:

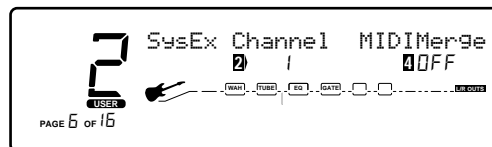

Preset Receive Map

The Preset mapping features of the Millennium allow you to access any of your Millennium's 200 Presets using the standard 128 Preset Change commands through MIDI. From the Factory, the Millennium is set to access User Preset 1 through 100 using MIDI Preset change numbers 1 through 100. MIDI Preset change numbers 101 through 128 access the Factory Preset bank.

To gain MIDI access to other presets not mentioned and bypass you must use the preset mapping feature.

To remap a preset number to a MIDI Preset change number, do the following:

1. Press the <Utility> button and scroll to Page 4 of the Utility menu using the <Page> knob. The display reads:

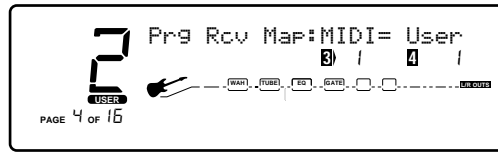

2. Use the <3> knob to select the MIDI Preset change number you want mapped. Note that the number under Millennium USER changes along with the MIDI number.
3. Use the <4> knob to select the Millennium Preset you want the selected MIDI Preset change number to recall. As this number increases above Preset 100, note that Millennium USER changes to Millennium FACT, indicating that the mapped number will recall the indicated Preset number in the Factory bank..

Preset Transmit Map

With the Preset Transmit Map function, you can use your Millennium to send MIDI patch changes of your other effects devices. When you call up a Preset in your Millennium, the appropriate presets in your other FX unit's will also be recalled.

To remap a MIDI Preset change number to a Preset number, do the following:

1. Press the <Utility> button, and scroll to Page 5 of the Utility menu using the <Page> knob. Now use the <1> knob and turn the setting to Off. The display will now appear like this:



2. Use the <3> knob to select the Millennium preset number you want mapped. Note that the number under MIDI changes along with the preset number.
3. Use the <4> knob to select the MIDI preset change number to be sent out the MIDI Out port when the corresponding preset number is recalled.

SysEx Device Channel

An easy way to think of the System Exclusive Device Channel option is to separate System Exclusive data from normal MIDI data. Each type of data has its own group of 16 channels upon which data can be transmitted. This feature will also allow individual remote control of more than one Millennium with SysEx commands.

From the Factory and in most situations, the SysEx channel is set at Channel 1.

Normal MIDI data, like Preset Changes, MIDI Volume, Modulation, etc. is transmitted and received on the MIDI channel designated by the setting of MIDI RECEIVE CHANNEL). SysEx data, on the other hand, is transmitted and received on the SysEx channel designated by the setting of SYSEX DEVICE CHANNEL.

This setup frees up your regular MIDI channels for other control options, and gives you the flexibility to request SysEx data from only the devices you want in your setup, whether they share the same MIDI channel or not.

To change the SysEx Device Channel number do the following:

1. Press the <Utility> button, and scroll to Page 6 of the Utility menu using the <Page> knob. The display reads:



2. Use the <2> knob to select the desired SysEx channel (1, 2,...15, 16).

Sysex Dumps

Preset Dump: Allows you to dump individual Millennium presets to another Millennium or external MIDI devices like patch librarians, computers, or sequencers for backup, storage, or organization. This option allows you to select the preset to be dumped, and, when dumping to another Millennium, the preset location where you want the preset dumped.

To initiate an individual patch dump from the Millennium, do the following:

1. Press the <Utility> button and scroll to Page 8 of the Utility menu using the <Page> knob. The display reads:



2. Using the function <3> knob, select the Preset number you want to dump. Note that the MIDI number changes as you scroll.
3. Use the function <4> knob to select the Preset location where you want the preset dumped.
4. To initiate the dump, turn the function <1> knob. The Information line briefly reads:

Sending Preset Dump...

after which it returns to the Preset dump screen.

Default Dump: Allows you to dump individual Millennium User defaults to another Millennium or external MIDI devices like patch librarians, computers, or sequencers for backup, storage, or organization. This option allows you to select the default to be dumped.

To initiate an individual Default dump from the Millennium, do the following:

1. Press the <Utility> button and scroll to Page 9 of the Utility menu using the <Page> knob. The display reads:

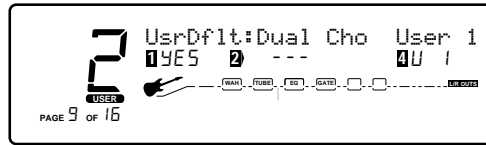

2. Using the function <2> knob, select the Effect Module whose Default you want to dump.
3. Use the function <4> knob to select the User Default you want to dump.
4. To initiate the dump, turn the function <1> knob. The Information line briefly reads:

Sending User Default...

after which it returns to the User default screen.

Bulk Dump: This option allows you to dump all resident Presets in memory to an external recording device, like a patch librarian, computer, or sequencer for backup, storage, or organization. This option dumps all Presets simultaneously. It does not send any Millennium system information, such as SysEx Device channel or Presets maps.

To perform a SysEx Bulk Dump of all Millennium Presets, do the following:

1. Press the <Utility> button and scroll to Page 7 of the Utility menu using the <Page> knob. The display reads:

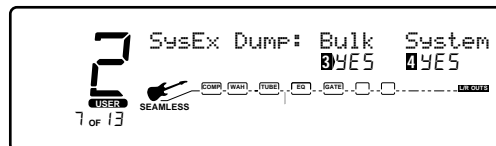

2. To initiate a bulk dump, turn the <2> knob. The Information line of the display reads:

SENDING BULK DUMP...

after which the display returns to the Dump screen. Bulk Dumps are very large and may take several minutes to complete.

System Dump: This is the option to use for dumping system data to an external MIDI or SysEx recording device. All the item settings in the Utility menu are sent using this option. Presets are not included in this dump.

The System Dump procedure is the same as the Bulk Dump procedure (see above), except that to initiate a System Dump, turn the <4> knob.

Other Utility Functions

The following page, lists some additional Utility functions included in the Millennium that make your programming life a little easier.

Factory Reset

Allows you to erase all User Presets, Default and Utility settings at once and restore the Millennium memory to its factory condition.

WARNING! This procedure will destroy and reset ALL User Presets in the Millennium memory. Be sure you want to erase the memory, and start fresh before continuing with this procedure.

To perform a factory reset, do the following:

1. Press the <Utility> button and scroll to page 15 of the Utility Menu using the <Page> knob. The display reads:

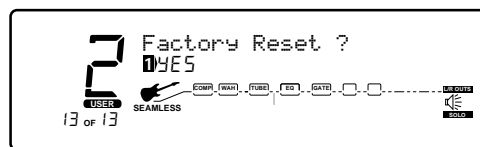

2. To initiate the reset, turn the function <1> knob.
3. This is your last chance to change your mind. If you are sure, turn the <3> knob. If not, you can abort the procedure by turning the <4> knob. If you turn the <3> knob, the Information line of the display briefly reads: `Resetting...` after which the unit resets, and returns to Preset 1.

Note: In extreme situations, the Millennium can be completely reset using a special power-up procedure. This will also completely reset the Millennium, eliminating any custom settings created by the user. The procedure is as follows:

1. Press and hold the <Config> button while powering up your Millennium.
2. Release the <Config> button after an asterisk appears in the information line on the screen.
3. Press the <Mod> button and the Millennium will re-initialize itself.

Global vs. Local XLR Cabinet Emulation

The thing to factor in when using the XLR Cabinet emulator in either global or local mode is whether or not you want all of your sounds affected by this change. A good time to use Global mode is when your frequently playing in different venues (because each room always sounds different).

The procedure for selecting either the Local or Global XLR Cabinet emulation is as follows:

1. Press the <Utility> button and scroll to page 2 of the Utility page using the <Page> knob. The display reads:

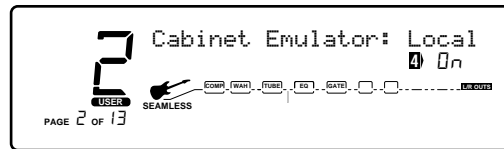

2. Using the <4> knob, you can turn the Cabinet Emulator to either Local On or Global On mode, or Global Off.

Output Mode

You can output the signal of your Millennium as either a Stereo or Mono signal.

1. Press the <Utility> button and scroll to page 1 of the Utility page using the <Page> knob. The display reads:

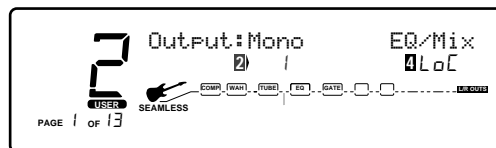

2. Using the <2> knob, you can turn set your Millennium to output either a Stereo or Mono signal.

J-3 Footswitch Set-Up

The J-3 footswitch offers three footswitches that can be assigned to perform numerous different functions. Out of the box, the J-3 will change Presets Up and Down and will A-B channel switch. Changing these footswitch functions is done on Pages 13 and 14 of the Utility menu.

To access this assignment function, press the <Utility> button and turn the <Page> knob to page 14.

Page 14 of the utility menu gives you the following foot switch assignment options: Preset Up, Preset Down, Song List Up, Song List Down, Channel A-B switching, Tuner Access, TapIt tap tempo switch and FX bypass. These selections can be made by using either the <2>, <3> or <4> knobs.

Page 15 of the Utility menu lets you program a Song list so you can build a list of up to 32 different Presets to use that can be accessed by pressing 1 footswitch. To set the Song list use the <3> knob to select the step and the <4> knob is used to select which preset will be used with the selected step.

Section-6 The J-12 Foot Controller

Configuring the Pedalboard

The optional Johnson Amplification J-12 foot controller can help you get the most out of your Millennium. Since the J-12 talks to the Millennium using a proprietary communication protocol, it offers better response time and capabilities not available with convention MIDI pedalboard controllers.

The J-12 includes 12 footswitches for preset and parameter control. It also features 2 built-in Expression Pedals. The large 20 character display constantly feeds you important information such as Preset names, CC links and Tuner indicators.

Note: All Pedalboard functions involved in the next section also apply to the Digitech Control One Foot Controller

Connecting the Johnson Amplification J-12 Foot Controller

The J-12 uses a standard 5-pin DIN cable (like those used for MIDI) to communicate with the Millennium. Simply connect the J-12 output jack to the Millennium Input jack (when the unit is powered down) and you're ready to roll!

NOTE: *Never plug anything other than the J-12 into the Millennium's Foot Controller input jack. (Voltage is present at this jack).*

Expression Pedal Names

With the Millennium being able to accommodate up to 4 Expression pedals, the pedal names change if the J-12 is used. The Names are as follows:

Exp1 = Expression pedal 1 input on the rear of Millennium, when the J-12 is not connected.

Exp2 = Expression pedal 2 input on the rear of the Millennium, when the J-12 is not connected.

Exp1 = Expression pedal 1 on the J-12 (When the J-12 is connected).

Exp2 = Expression pedal 2 on the J-12 (When the J-12 is Connected).

Exp3 = Expression pedal 1 input on the rear of Millennium, when the J-12 is connected.

Exp4 = Expression pedal 2 input on the rear of the Millennium, when the J-12 is connected.

Assigning Functions

The J-12 helps you organize your sounds into 19 groups called Banks. Each of these Banks utilize the 10 footswitches patches, which are user programmable to do one of several functions. These functions include:

- *Selecting any Millennium Preset*
- *Modifying or turning On/Off any Parameter in real-time*
- *Sending MIDI CC information out of the MIDI out port (Toggle CC# for values 0 or 127)*
- *Assign a MIDI CC# for the Expression pedal to send out the MIDI port*

To change Banks, Press either the Bank Up or Bank Down footswitches on the J-12 to take you up or down one bank at a time.

The Foot Controller setup menu contains all the setup options necessary to use the Millennium with the optional J-12 foot controller. The submenus included under the Foot Controller setup are located on pages 10, 11 and 12 of the Utility menu and they include:

- *Patch Assignment*
- *Continuous Control*

Assigning Presets to Footswitches

To assign any currently selected Preset to a patch footswitch in the currently selected bank, do the following:

1. Once the selected Preset has been chosen, press the **<Assign>** button once. The display reads:

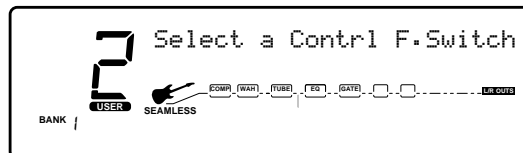

2. Press one of the ten footswitches to Link the selected preset to that switch. If you choose a footswitch that is already assigned to do something else besides select a preset, the display reads:

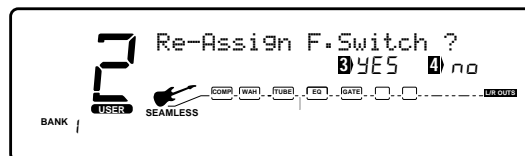

3. Turning the **<3>** function button re-assigns the function of the footswitch while turning **<4>** will leave everything as it was, aborting the procedure.

Once you link a Preset to a Patch in a Bank, the LED lights above the footswitch that you selected indicating the Link was successful.

4. Press the **<Preset>** button to exit.

Assigning Parameters to Footswitches/ Expression Pedals

The Millennium allows you to control up to 16 Parameters per Preset. Each time you link a parameter to a Footswitch or expression pedal, it is added to any assignments already made to that controller. This is where the Millennium becomes the dedicated work horse that it is, by doing all of the organizing for you so all you have to do is select which parameter is being controlled, then tell the Millennium to "Make it so".

To assign any currently selected Parameter to a footswitch or Expression pedal in the currently selected bank, do the following:

1. Be sure that the parameter you want to link is displayed and selected (below, is an example the Channel A gain setting) Turning the <1> knob make the Gain in Channel A active for linking. The display should appear something like this:

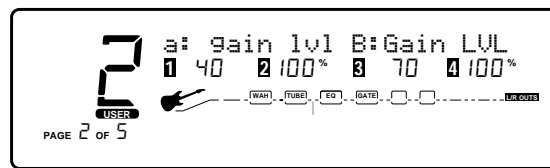

2. Turn the <4> knob to select the gain parameter, then press the <Assign> button once. The display reads:



3. Select the footswitch or move the expression pedal to be used. An example would be to use Exp 1. From there, use knobs <3> and <4> to set the minimum and maximum ranges of the gain. Minimum and maximum settings can also be set in reverse. An example would be if you set the Gain Min and Max levels in reverse so when the Expression Pedal is moved forward, it would lower the Gain setting.

Once this is done the display will appear something like this:

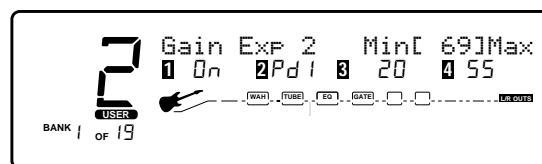

4. To exit the parameter assignment mode press the <Preset> button to return to Preset mode. The <Store> button will stay bright until these changes are stored, or the preset is changed.

Other Footswitch Functions

The footswitches on the J-12 can be assigned to do several functions. This is done through the Foot Controller menus in the Utility section of the Millennium. These functions include:

Toggle MIDI CC: This function allows you to send MIDI Continuous Controller (CC) information out the MIDI port while the footswitch still maintains its ability to control a parameter directly. When assigned to a footswitch, CC values 0 or 127 are sent. CC numbers 0 through 127 are available.

Exp CC send: The Expression pedals of the J-12 can also send MIDI CC data to other MIDI devices.

The procedure for setting up a MIDI CC toggle footswitch function is as follows:

1. Press the <Utility> button once. The display reads:

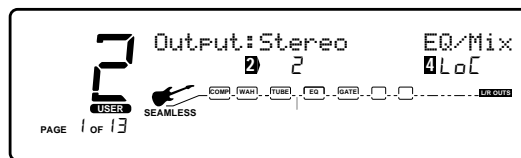

2. Turn the <Page> knob to page 10 and the display reads:

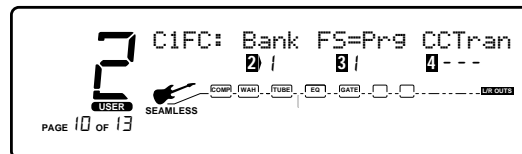

3. Turn the <2> knob to select the bank in which the CC toggle is to be used. Once the bank is selected, use the <3> knob to select the footswitch to be used. The display reads:

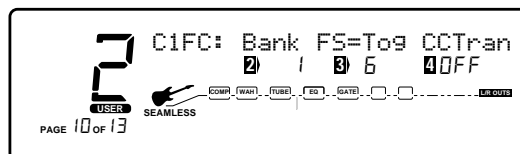

4. The display now shows that footswitch 6 in bank 1 is set to toggle CCs. Take notice that (from the factory) when footswitches 6-0 are selected, you can assign that footswitch a CC number from 0-127 by turning the <4> knob.

5. Now to assign the CC number, just turn the <4> knob until you have reached the desired CC. The display will now read something like this:

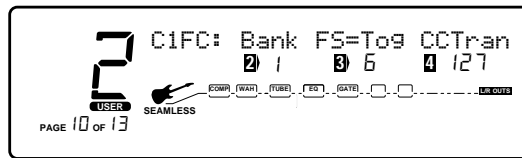

6. Press the <Preset> button to exit the Foot controller setup menu.

Assigning MIDI Control to the Expression Pedals

This series of menus and submenus allows MIDI setup of the Expression pedals of the J-12. There are two procedures you must do in order for the Expression pedals to work properly with MIDI:

1. Assign CC Number
2. CC Transmit Channel

Assign CC Number to Expression Pedals - This option allows you to choose the MIDI CC numbers you want to use for sending continuous control messages using any one of the 4 Expression pedal options. These assignments can be done on pages 11 and 12 of the Utility menu. From the Factory, the Expression pedal(s) are not pre-assigned to any MIDI CC number. To assign which CC number is sent from the Expression pedal(s), do the following.

1. Press the <Utility> button once. The display appears something like this:

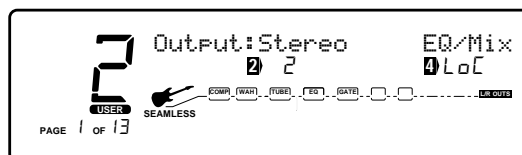

2. Turn the <Page> knob to page 11 and the display will appear something like this:

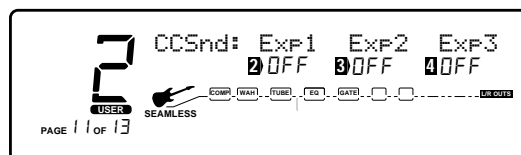

3. Turn either function keys <2 or 3> to assign a CC number to the selected Expression pedal . The display will appear like this on page 11 if, for example Exp 1 is selected. (Exp1=Internal Expression pedal 1 insert on Millennium w/o the J-12. Or, Expression pedals 1 or 2 on the J-12 when connected. The display now reads:

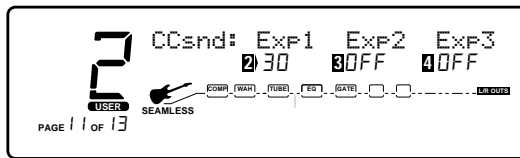

Page 12 will appear like this:

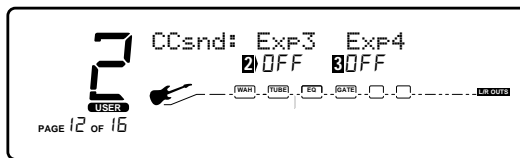

4. Press the <Utility> button to exit.

For a complete explanation of Expression Pedal names, please refer to page 68.

CC Transmit Channel - This option allows you to set the MIDI channel on which CCs will be sent out the Millennium MIDI Out port to other MIDI devices. If you are using the J-12 for the Millennium only, you don't need to worry about setting up this option.

However, if you plan to use the J-12 for continuous control over other MIDI devices (either in conjunction with the Millennium or by themselves), you need to assign a MIDI transmit channel for each of the CC numbers you'll be using for continuous control of the other devices.

To change the MIDI channels on which the selected CCs will transmit to other MIDI devices, do the following:

1. Press the <Utility> button once. The display and the display should appear something like this:

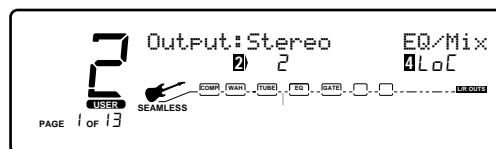

2. Turn **<Page>** knob to page 3 and the display will read:

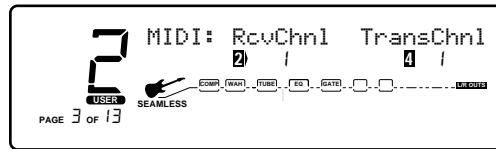

3. Turn the function knob **<4>** to select the MIDI CC transmit channel. For example, select channel 10 and the display will now appear like this:



4. To exit the Transmit channel assignment, press the **<Preset>** button.

Momentary Footswitch Assignment

The Millennium now has the ability to assign any footswitch of either the J-12 or Control One foot controllers to act as momentary switches. This will give you the ability to toggle the value a parameter by a press /hold and release of the selected footswitch. The Momentary footswitch assignment can be done by performing the following procedure:

1. When the parameter for assignment has been selected, press the **<Assign>** button once. After you have selected the footswitch for assignment, the display will appear something like this:

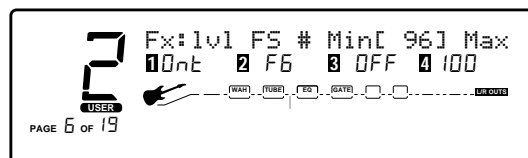

2. Now turn the **<1>** button to set the footswitch to either: **OnT** (On Toggle) or **OnP** (On Momentary).

3. Choosing the OnP setting will make the footswitch perform as a momentary footswitch. This means that the footswitch will toggle the selected parameter while pressed, and once released, the parameter will return to its original value.

Other Pedalboard Tidbits

Here are a few other features that you will want to learn about to get the most out of your J-12 foot controller:

Bank Up/ Tuner and Bank Down / Bypass Footswitches

These two foot switches are located at top right side of the J-12. The Bank Up/Tuner footswitch, as you may have guessed, will move to the next Bank Up in the Millennium, as well as access the Tuner Mode by simply pressing and holding the footswitch until the Tuner appears in the display.

To access the next bank down press the Bank Down footswitch once. To bypass the Digital effects in the Millennium, press and hold the footswitch until the LEDs indicate that the unit is now in effect bypass mode.

Using the Tuner

1. To access the Tuner mode using the optional J-12 foot controller, press and hold the **<Bank Up/Tuner>** footswitch to engage tuner mode.
2. As you play a note on the guitar, the indicator in the display of the J-12 will move either to the right, or the left. If the indicator is moving right, the note you are playing is sharp. If the indicator moves left, you are flat. The goal is to tune your guitar so that the indicator stops in the middle and the display locks-in, indicating you are in tune.
3. In both methods of tuning, the tuner is referenced to A=440Hz. If you prefer tuning sharp or flat according to the A reference, use the **<3>** knob to select a new reference. This can be set as high as A=453Hz or as low as A=427Hz. The tuner can also be used for alternate tuning references where A=Ab (meaning you play an A note, but you hear an Ab note). It is possible to tune as low as A=Gb.
4. At this point, press any footswitch on the J-12 to exit the Tuner mode.

Naming Banks

Straight out of the box, the Millennium has 19 user Banks to choose from when used with the either the J-12 foot controller. Each of the Banks have been given a specific named to give indication to what type of presets exist with the Bank. In your constant editing mode to make the box custom to your needs, we have given you the ability to rename the Banks. The procedure is as follows (and please don't worry, we won't be hurt):

1. From Preset mode press the **<Utility>** button and the display will appear something like this:
2. Turn the **<Page>** knob until you reach page 13 and appears like this:

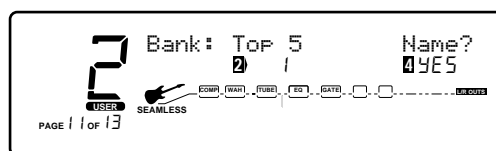

3. At this point, use the <2> knob to select the Bank to be named. Once the Bank has been selected, turn the <4> knob to rename the Bank. The display now appears like this:

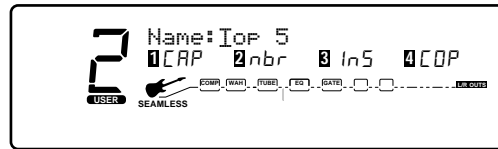

4. To exit the naming bank assignment, press the <Utility> button.
5. Using the <1> knob, change the character to the one you want in the selected position.
6. When the correct character is displayed in that position, use the <Page> knob to scroll the cursor to the next character you want to change.
7. Use the <2> knob to select numbers, the <3> knob to insert spaces and the <4> knob to copy and paste characters.
8. To copy a character, position the cursor under the character you want to copy (using the <Page> knob), then turn the <4> knob clockwise. To paste the copied character, position the cursor where you want to paste the character, then turn the <4> knob counter-clockwise.
9. To abort the procedure, push either the <Preset> button to take you to Preset Mode, the <Edit> button to take you to FX Edit Mode, or the <Utility> button to take you to Utility mode, depending upon which mode you want to enter.

Un-Linking or Viewing Parameter Control

1. To un-link or view a parameter that has been assigned to a footswitch, Expression Pedal or LFO simply press the <Assign> button twice. The display will tell you which parameter is linked to which footswitch. To unlink, simply turn the <1> knob and the top line of the display will now read:

Available Link

2. To see any other parameter links in the selected program, press the <Assign> button twice and then turn the <Page> knob.

Section-7 Appendix

Millennium Factory Preset List

Bank 1 Top 5

1- Rectifier Solo	Cfg-4
2- Panning Twin Reverb	Cfg-4
3- Matchless Blues	Cfg-3
4- Custom Marshall w/Reverb	Cfg-1
5- Get Your Wah Wahs Out	Cfg-4

Bank 2 Fender

6- '65 Black Face Twin	Cfg-4
7- '65 Twin Bright	Cfg-4
8- Fender Overdrive	Cfg-4
9- Leslie Jazz twin	Cfg-4
10-Fender Phase/Pong Delay	Cfg-4

Bank 3 Boogie/Soldano

11- Boogie Mark II Combo	Cfg-4
12- Rectifier Stack	Cfg-4
13- Trem-O-Verb	Cfg-4
14- Boogie Mark II Stack	Cfg-4
15- Soldano SLO	Cfg-4

Bank 4 Vox

16-'63 Vox AC 30 Top Boost	Cfg-1
17- Vox AC 30 Clean/Dirty	Cfg-1
18- Vox w/Analog Delay	Cfg-1
19- AC 30 Chorus/Delay	Cfg-4
20- Vox AC 30 Cln/Drty Combo	Cfg-4

Bank 5 Matchless

21- Matchless DC30 Combo	Cfg-1
22- Matchless w/Reverb	Cfg-4
23- DC30 Leslified	Cfg-4
24- Matchless Gain Solo	Cfg-12
25- Mchles Cln/Edge	Cfg-9

Bank 6 Marshall

26- Hot Rodded Marshall	Cfg-4
27- Marshall Master Volume	Cfg-1

28- Marshall JCM 800 Combo	Cfg-1
29- Marshall JCM 800 Stack	Cfg-4
30- A)Clean B)HotRod Marshall	Cfg-4

Bank - 7 Johnson

31- Johnson Fat Soul	Cfg-3
32- Johnson Powr-Solo	Cfg-4
33- Johnson Edge->Clean	Cfg-9
34- Johnson Tone&Clean	Cfg-9
35- Johnson Gain&Mo gain	Cfg-9

Bank - 8 Signature 1

36- Mysterious Wah	Cfg-13
37- Stray Dead Catz	Cfg-9
38- Smashing Bumpkins	Cfg-4
39- Pride Delay	Cfg-4
40- Dick Dale	Cfg-4

Bank - 9 Signature 2

41- Classic SRV	Cfg-4
42- Brown Sound	Cfg-9
43- E.Johnson Clean/Solo	Cfg-9
44- Foxy Lady	Cfg-4
45- Run Like Gilmour	Cfg-4

Bank 10 Blues

46- Bluesy Twin Solo	Cfg-9
47- Tremolo Blues	Cfg-9
48- Blues Boogie	Cfg-9
49- Blue BB'S	Cfg-9
50- Slide Blues	Cfg-2

Bank 11 Dual Tone

51- L)Vox R)Marshall	Cfg-6
52- Twin->Matchless Heaven	Cfg-4
53- L)Metal Tube R)Fuzz	Cfg-6
54- Twin/Match Hybrid ExpPdl	Cfg-4
55- Twin->Marshall Solo	Cfg-6

Bank 12 Alternative

56- Industrialized	Cfg-9
57- Whammy Madness	Cfg-2
58- Triplet Delay	Cfg-4
59- Post-Seattle Grind	Cfg-4
60- Space Hippie	Cfg-8

Bank 13 Country

61- Pedal Steel	Cfg-2
62- Rockin' Billy	Cfg-4
63- Good For Pickin'	Cfg-4
64- Drinking w/Cowboyz	Cfg-7
65- Stereo Slapback	Cfg-13

Bank 14 Vintage

66- Surfari	Cfg-4
67- Fuzz in the Sky	Cfg-4
68- Danno Electro	Cfg-9
69- Electric Sitar	Cfg-9
70- Guitar Organ	Cfg-4

Bank - 15 Studio

71- Chorus Wash	Cfg-10
72- Vol Pedal Swell	Cfg-8
73- Cln Comp Mono>Ster	Cfg-13
74- PWR CORD Mono>Ster	Cfg-13
75- Greasy Solo	Cfg-10

Bank - 16 Jazz/Fusion

76- MD's Sweet Solo	Cfg-9
77- Pop Jazz Comp	Cfg-10
78- Mainstream Jazz	Cfg-9
79- Fusion Solo Boogie	Cfg-10
80- Steely Phaser	Cfg-9

Bank - 17 Rock

81- Stack In a Studio	Cfg-1
82- Metallurgist	Cfg-4
83- Phasey Rhythm	Cfg-4
84- Too Heavy	Cfg-4
85- Just A Wah	Cfg-13

Bank 18 Dynamics

86- Ducked Delay Solo	Cfg-1
87- Dynamic Chorus	Cfg-4
88- Automatic Wah	Cfg-1
89- Guitar Synth	Cfg-7
90- Dynamic Tremolo	Cfg-4

Bank 19 Morph

91- Clean->->Solo Morph	Cfg-15
92- Tube->->SpaceFuzz Morph	Cfg-9
93- Auto Morph	Cfg-15
94- Soldano Ambient Morph	Cfg-4
95- 2 Second Loop Jam	Cfg-9
96- Wahs Happening?	Cfg-15
97- Planet Diablo	Cfg-8
98- Blues in D	Cfg-2
99- JC-120 Jazz Chorus	Cfg-3
100-Sweet Combo	Cfg-3

Millennium Preset Descriptions

To help all of you Tone and Effect connoisseurs along the way, this list gives you a brief description all 100 Factory Presets of the Millennium.

Bank - 1 Top 5

- 1- **Rectifier Stack** - Pure and rich Dual Rectifier Stack tone with Dual Delay and Chorus modules ideal for soloing.
- 2- **Panning Twin Reverb** - Tone of the legendary Twin with Reverb and an Auto Panner effect to that pans the signal right and left.
- 3- **Matchless Blues** - The mighty DC-30 is overdriven and uses a flanger which makes it ideal for playing the blues.
- 4- **Custom Marshall w/Reverb** - The great Marshall with the custom "Mods" already in place and just a touch of reverb.
- 5- **Get Your Wah Wahs Out** - A Boogie MK II Amp model that uses the Analog Wah module with Delay and Reverb.

Bank - 2 Fender

- 6- **'65 Black Face Twin** - This rare (and high priced) Amp tone is brought out in the Millennium.
- 7- **'65 Twin Bright** - Boosted Mids and Highs will let this Twin cut through in any room.
- 8- **Fender Overdrive** - Classic Twin tone, with just a touch a distortion to overdrive the front end.
- 9- **Leslie Jazz Twin** - Let the Jazz shine through with the Leslie to fill up this Twin.
- 10- **Fender Phase/Pong Delay** - The Twin Amp tone with Phaser and Pong Delay.

Bank - 3 Boogie/Soldano

- 11- **Boogie Mark II Combo** - The Combo Amp tone of Carlos .
- 12- **Rectifier Stack** - The wall of angry Dual Rectified Tone is present here.
- 13- **Trem-O-Verb** - Dual Rectifier tone with a Tremolo effect at your disposal.
- 14- **Boogie MK II Stack** - The legendary vintage tone that Mr. Randall Smith created in a shed almost thirty years ago.
- 15- **Soldano SLO** - The high-priced prestiges tone of what is sure to become a Amplifier classic.

Bank - 4 Vox

16- '63 Vox AC 30 Top Boost - Vintage British Combo tone with Reverb mixed in for good measure.

17- Vox AC 30 Clean/Dirty - Classic clean AC 30 in channel A and distortion in channel B.

18- Vox w/Analog Wah - A Slightly overdriven AC 30 with an Analog tape delay effect.

19- AC 30 Chorus/Delay - AC 30 tone with lush Chorus and a 500ms Delay.

20-Vox AC30 Cln/Drty Combo - Channel switching from a clean to overdriven AC 30 Amp.

Bank - 5 Matchless

21- Matchless DC 30 Combo - The tone of the of the new Industry-standard work horse.

22- Matchless HC 30 - Matchless half-stack tone that can kick in distortion to overdrive the Amp by channel switching.

23- DC30 Leslified - The DC 30 with leslie simulation thrown in to keep things spinning.

24- Matchless DC 30 Solo - A Solo Must. with overdriven Matchless tone with Detuning and Delay digital effects.

25- Matchless Cln/Edge- Morph between the great tones of a Matchless and a hot-rodded Marshall Master.

Bank - 6 Marshall

26- Hot Rodded Marshall - Marshall tone with all of the modifications already done to it with a Dual detuner and Reverb.

27- Marshall Master Volume - A simple mid '70s Marshall Master Volume that was designed to rock with all tone controls pushed to 10.

28- Marshall JCM 800 Combo - The big Marshall tone harnessed in a 2X12 combo.

29- Marshall JCM 800 Stack - The Amplifier that revolutionized the 1980s Rock Sound.

30- Clean/Hot Rod Marshall - A Johnson Amp model that allows you to produce pristine clean and distorted tones at the same time.

Bank - 7 Johnson 1

31- Johnson Fat Soul - Tube Distortion with Dual Delay and Stereo Reverb effect modules.

32- Johnson Powr-Solo - Big, custom tube distortion with Dual Detuning and Dual Delay that can be thrown in any solo situation.

- 33- Jonson Edge->Clean** - A overdriven Amp tone that can be switched to to clean with a Digital Compressor, Dual Delay and Stereo reverb digital effect modules.
- 34- Johnson Tone and Clean-** A custom Johnson Amplifier module that boosts the clean signal with 6-band Parametric EQ and adds a Dual Phaser and Stereo dual delay module.
- 35- Johnson Gain&Mo Gain-** A Johnson custom Amplifier Module that boosts the signal by using a parametric 6-band EQ. And it also uses Stereo Tremolo and Stereo Reverb Effects.

Bank - 8 Signature 1

- 36- Mysterious Wahs** - A dynamic modifier is connected to the Analog Wah module to help give you the sound of the Irish "Pop" guitarist.
- 37- Stray Dead Catz** - Vintage Fender Twin with delay is used to produce the classic Setzer Tone .
- 38- Smashing Bumpkins** - A Dual rectifier is used to re-create the tone of Mr. Corgan and friends.
- 39- Pride Delay** - A Vox AC 30 model with lots of Delay, just the way the Edge likes it.
- 40- Dick Dale** - The legendary tone of the man that gave birth to surf music rings out in a '65 Black Face model with Reverb.

Bank - 9 Signature 2

- 41- Classic SRV** - The classic tone of the legendary Stevie Ray Vaughan which utilizes a custom Jonson Amplifier model and Rotary Speaker simulator can be turned on to produce a Leslie effect with an additional Reverb module.
- 42- Brown Sound** - Tone of the great Mr. Van Halens' early years when the trusty Marshall stood by his side.
- 43- E. Johnson Clean/Solo** - The Violin Tone of Austin, Texas, complete with Chorus, Delay and Reverb.
- 44- Foxy Lady** - Pick up your Strat and let the feedback wake the neighbors with this Marshall model run all of the way up.
- 45- Run Like Gilmour** - This Preset is great to be used on any classic of Pink Floyd tunes.

Bank - 10 Blues

- 46- Bluesy Twin Solo-** This '65 Black face model with compressor and Delay will touch anyone with your blues.
- 47- Tremolo Blue-** The great tremolo sound is present in this preset along with a Fender Twin amp model..
- 48- Blues Boogie** - the Boogie MK II combo Amp model that was designed to be at home in any blues club..

49- **Blue BB's**- Added parametric EQ with reverb and Delay give you the tone of BB'S and his best girl Lucille.

50- **Slide Blues**- Use an expression pedal on this preset to create bayou-type slide guitar effects.

Bank - 11 Dual Tone

51- **L) Vox R)Marshall** - This preset combines an AC 30 and Marshall amp model to give you the best of both worlds.

52- **Twin/Matchless Heaven** - Most could not afford to own both of these tones, but you have both side by side at the same time.

53- **L) Metal Tube R)Fuzz** - Combine both of these distortions, and you will have all of the gain in the world at your fingertips.

54- **Twin/Match Hybrid ExpPdl** - Use an Expression pedal to morph between Fender Twin and Matchless Amp models .

55- **Twin->Marshall Solo** - Use the Twin model with reverb for rhythm tone then morph to the Marshall model for the big solo.

Bank - 12 Alternative

56- **Industrialized** - The Soldano SLO model is used with the a Dual Detuner to produce a unique distortion tone.

57- **Whammy Madness** - Get yourself an expression pedal to produce whammy effects through the Rectifier model.

58- **Triplet Delay** - This Boogie MK II model with tons of Delay and Reverb can be used to create beautiful clean tones.

59- **Post-Seattle Grind** -This preset combines Vox and Marshall tones to produce a nice slight distortion tone.

60- **Space Hippie** - The Vox AC 30 Top Boost is used with Dual Chorus, Dual Delay and Dual Phaser modules to produce sounds that are out of this world.

Bank - 13 Country

61- **Pedal Steel** - Use an expression pedal on this one to produce pedal steel-type effects.

62- **Rockin' Billy** - This preset is a must for any rock-a-billy tune.

63- **Good For Pickin'** - This '65 Blackface Fender tone with Reverb and slapback delay will make you "a grinnin".

64- **Drinking w/Cowboyz** - Try this preset when the no good, drinkin', dog-stealin', wrecked your truck person in your life leaves ya.

65- **Stereo Slapback** - A distorted Fender with compression and Analog and Dual Delay preset can be heard here.

Bank - 14 Vintage

- 66- **Surfari** - Great surf music tones will shoot the pipeline with this Tremolo and Reverb preset.
- 67- **Fuzz in the Sky** - Use this Preset to bring out the great fuzz tone of the '60s and '70s.
- 68- **Danno Electro** - Pitch shifting and Dual Chorus is used to help produce this Baritone Guitar preset.
- 69- **Electric Sitar** - Use this Dual Pitch Shifter preset to create Egyptian-type sounds.
- 70- **Guitar Organ** - Great Leslie effects can be heard on this preset that uses a Rotary Speaker Simulator module.

Bank - 15 Studio

- 71- **Chorus Wash** - Heavy Chorus effects and Dual Amplifier types are used in this preset.
- 72- **Vol Pedal Swell** - Use this preset to create Synth-like vol pedal swells.
- 73- **Cln Comp Mono->Ster** - This straight ahead clean tone with compressor can go from a mono to Stereo output with an Expression pedal.
- 74- **PWR CORD Mono>Ster** - Take this great power rhythm tone from mono to stereo with the use of an Expression pedal.
- 75- **Greasy Solo** - Use this Preset for recording any guitar solo in the studio.

Bank - 16 Jazz/Fusion

- 76- **MD's Sweet Solo** - The tone of a studio legend that is great for the Fusion solo.
- 77- **Pop Jazz Comp** - Use this preset for Wes Montgomery-type sounds.
- 78- **Mainstream Jazz** - This is a great tone to use that utilizes a Fender twin amp module with EQ, Chorus and Reverb effects.
- 79- **Fusion Solo Boogie** - A great Boogie Tone preset for fusion solos.
- 80- **Steely Phaser** - A Twin Reverb model with Dual Phaser and Auto panning effects for fusion rhythms.

Bank - 17 Rock

- 81- **Stack in a Studio** - Get the big Marshall tone with this preset that is guaranteed to rock any one's world.
- 82- **Metallurgist** - Bring on the Dual rectifier stack sound with Dual flanger and Delay.

83- Phasey Rhythm - Use this Dual-tone Phaser effected preset for rhythm playing.

84- Too Heavy - You will have gain for days when you use this Dual Rectifier model preset.

85- Just a Wah - This JCM 800 Combo amp with distortion uses an Analog Wah module to produce overdrive tones.

Bank - 18 Dynamics

86- Ducked Delay Solo - A Dynamic modifier is used in this preset so the harder your attack is, the more delay will be heard.

87- Dynamic Chorus - This is beautiful clean chorus preset that has a dynamic modifier assigned to the chorus module. This means, harder attack, more chorus.

88- Automatic Wah - Use this overdriven preset with dynamic attack that will produce an auto wah effect.

89- Guitar Synth - Use this Preset to produce guitar synth effects, that change depending on how hard your attack hits.

90- Dynamic Tremolo - Change your Tremolo speed by attacking the strings harder on this preset.

Bank - 19 Morph

91- Clean->->Solo Morph - Use this preset when you need to morph from a clean tone preset to a distorted solo tone.

92- Tube->->Space Fuzz Morph - You can morph from a Tube distortion to a classic Fuzz distortion.

93- Auto Morph - Use this preset when you want the Millennium to automatically morph from a clean to distorted tone.

94- Soldano->->Ambient Morph - This preset is used to morph from a clean Fender Twin to a Soldano amp model.

95- 2 Second Jam Loop - This preset is great to use when you want to play along with a sample, because the 2 second delay will automatically loop itself to act as a sample so you can jam along with yourself.

96- Wahs Happening - Get out of this world sounds with this Matchless model that uses Auto Wah, Pitching, Delay and Chorus effects.

97- Planet Diablo - This Twin Reverb is heavily effected with Delay, Chorus and Reverb.

98-Blues in D- Use this Preset to create the great blues tone (with pitch shifting),you never thought possible.

99- JC-120 Jazz Chorus- Use this preset to get the industry-standard sound of a lush Jazz Chorus 120.

100- Sweet Combo - This is the Combo Amplifier tone personified.

Effect Configuration Chart

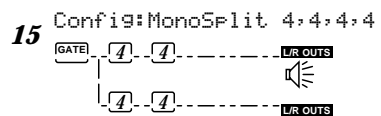
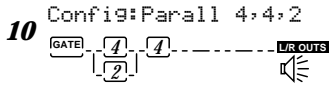
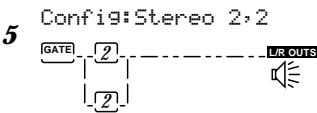
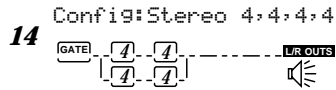
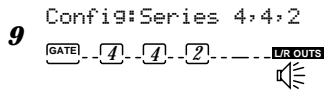
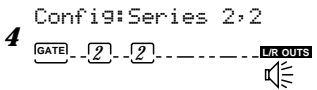
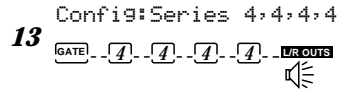
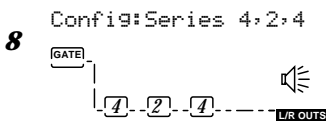
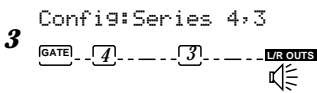
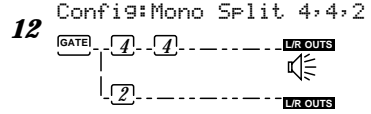
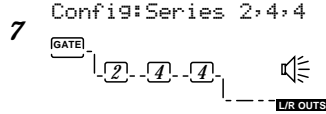
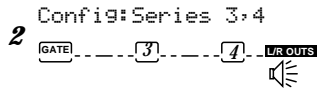
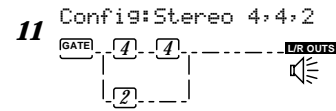
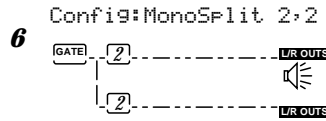
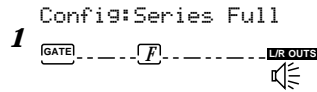

Dual Output Configurations - Take notice that several effect configurations (ie: 12 and 14) use dual outputs. This indicates that Dual distortion paths can be run to both the right and the left outputs. This will be dictated by panning either distortions to the right or the left.

Key: 4= 1/4 size module
 3= 3/4 size module
 2= 1/2 size module
 F= Whole size module

Harmony Interval Charts

Interval	Major	Minor	Harm.Minor	Mel.Minor	Dorian	Mixolydian	Lydian
↑Oct	C	C	C	C	C	C	C
↑7th	B	B _b	B	B	B _b	B _b	B
↑6th	A	A _b	A _b	A	A	A	A
↑5th	G	G	G	G	G	G	G
↑4th	F	F	F	F	F	F	F#
↑3rd	E	E _b	E _b	E _b	E _b	E	E
↑2nd	D	D	D	D	D	D	D
Ref	C	C	C	C	C	C	C
↓2nd	B	B _b	B	B	B _b	B _b	B
↓3rd	A	A _b	A _b	A	A	A	A
↓4th	G	G	G	G	G	G	G
↓5th	F	F	F	F	F	F	F#
↓6th	E	E _b	E _b	E _b	E _b	E	E
↓7th	D	D	D	D	D	D	D
↓Oct	C	C	C	C	C	C	C

Int.	Lydian Aug.	Int.	Major Pent.	Int.	Minor Pent.	Int.	Blues	Int.	Whole Tone	Int.	Hlf-Whl Dim.	Int.	Whl-Hlf Dim.
										↑Oct	C	↑Oct	C
↑Oct	C									↑b7th	B _b	↑6th	B
↑7th	B					↑Oct	C	↑Oct	C	↑6th	A	↑5th	A
↑6th	A	↑Oct	C	↑Oct	C	↑b7th	B _b	↑b7th	A#	↑5th	G	↑b6th	G#
↑#5th	G#	↑6th	A	↑b7th	B _b	↑5th	G	↑#5th	G#	↑#4th	F#	↑b5th	F#
↑#4th	F#	↑5th	G	↑5th	G	↑b5th	F#	↑#4th	F#	↑3rd	E	↑4th	F
↑3rd	E	↑3rd	E	↑4th	F	↑4th	F	↑3rd	E	↑#2nd	E _b	↑b3rd	E _b
↑2nd	D	↑2nd	D	↑b3rd	E _b	↑b3rd	E _b	↑2nd	D	↑2nd	D _b	↑2nd	D
Ref	C	Ref	C	Ref	C	Ref	C	Ref	C	Ref	C	Ref	C
↓b2nd	B	↓b3rd	A	↓2nd	B _b	↓2nd	B	↓2nd	A#	↓2nd	B _b	↓b2nd	B
↓b3rd	A	↓4th	G	↓4th	G	↓4th	G	↓3rd	G#	↓b3rd	A	↓b3rd	A
↓3rd	G#	↓b6th	E	↓5th	F	↓b5th	F#	↓b5th	F#	↓4th	G	↓3rd	G#
↓b5th	F#	↓b7th	D	↓6th	E _b	↓5th	F	↓b6th	E	↓b5th	F#	↓b5th	F#
↓b6th	E	↓Oct	C	↓Oct	C	↓6th	E _b	↓b7th	D	↓b6th	E _b	↓5th	F
↓b7th	D					↓Oct	C	↓Oct	C	↓6th	E	↓6th	E _b
↓Oct	C									↓7th	D _b	↓b7th	D
										↓Oct	C	↓Oct	C

Millennium Specifications

Power Amp Section:

60 Watts RMS per channel @ 8 ohms
120 Watts RMS per channel @ 4 ohms

Audio Outputs:

Left Speaker outputs: 2-1/4 inch jacks paralleled
Right Speaker outputs: 2-1/4 inch jacks paralleled
Loop Send: 1/4 inch TRS balanced / unbalanced: -10dBu
Left/Right Direct/Recording
Outputs: 2- XLR servo-balanced: +4 dBu
1 ground Maximum level: +18 dBu
Impedance: 100 ohms

Audio Inputs:

Bright Input: 1/4 inch unbalanced:
sensitivity adjustable by input level control
Impedance: 1 megohm
Normal Input: 1/4 inch unbalanced sensitivity
adjustable by input level control
Impedance: 1 megohm
Loop Return: 1/4 inch unbalanced: +18 dBu
Maximum Level: +18 dBu
Impedance: 10 k Ω

Controller Connections:

MIDI: In, Out/Thru
Expression Pedal inputs: 2- 1/4 inch;
compatible with any standard volume pedal with 25K to 1M Ω
or voltage control pedal (0-5v).
J-3 footswitch input: 1/4inch TRS
J-12 Controller Input: 5 pin DIN female

Tube Complement:

2- 12Ax7 triodes: 300 volt power supply

DSP Section:

A/D Converter: 20 bit 128X oversampled delta sigma stereo
D/A Converter: 20 bit 128X oversampled
Sampling frequency: 44.1 kHz
Static Dynamic Instruction Set Computer (S-DISC II)
Digital signal path width: 24 bits
Internal Data path width: 24 bits
Delay DRAM: 256 K x 24 (5.9 sec.)
Delay SRAM: 256 24 bit registers
Data ALU processing: 11.3 MIPS
Multiplier size: 24 x 24 bits

DSP co-processor

Digital Signal Path width: 24 bits
Internal Data Path width: 48 bits
Delay SRAM: 768 - 24 bit registers
Data ALU processing: 22.6 MIPS
Multiplier size: 24 X 24 bits

Power Requirements:

100, 120, 230 and 240 VAC 50/60 Hz 550 W
Fuse: 100, 120 VAC 1/4" X 1 1/4" 6A
230, 240 VAC 5mm X 20mm 3.15A

Memory Capacity:

Factory: 100 Presets
User: 100 Presets

Dimensions: 28" (711mm) W x 19.5" (495mm) H x 12" (305mm) D
Net Weight: 70 lbs
Shipping Weight: 75 lbs

MIDI Implementation Chart

Function...		Transmitted		Recognized		Remarks
<i>Basic Channel</i>	<i>Default Channel</i>	<i>X</i>	<i>X</i>	<i>1-16</i>	<i>1-16</i>	<i>Memorized</i>
<i>Mode</i>	<i>Default Messages Altered</i>	<i>X</i>	<i>X</i>	<i>Mode 2, Mode 4</i>	<i>Mode 2, Mode 4</i>	<i>Memorized</i>
		<i>N/A</i>		<i>X</i>		
<i>Note Number</i>	<i>True Voice</i>	<i>X</i>	<i>N/A</i>	<i>X</i>	<i>X</i>	
<i>Velocity</i>	<i>Note ON</i>	<i>X</i>	<i>X</i>	<i>X</i>	<i>X</i>	
	<i>Note OFF</i>		<i>X</i>		<i>X</i>	
<i>After Touch</i>	<i>Key's Ch's</i>	<i>X</i>	<i>X</i>	<i>0</i>	<i>X</i>	
			<i>X</i>		<i>X</i>	
<i>Pitch Bender</i>		<i>X</i>		<i>X</i>		
<i>Control Change</i>		<i>X</i>		<i>0</i>		<i>1*</i>
<i>Preset Change</i>	<i>True #</i>	<i>X</i>	<i>N/A</i>	<i>0</i>	<i>0-127</i>	<i>2*</i>
<i>System Exclusive</i>		<i>0</i>		<i>0</i>		<i>See SysEx (see appendix)</i>
<i>System Common</i>	<i>:Song Pos</i>	<i>X</i>		<i>X</i>		
	<i>:Song Sel</i>			<i>X</i>		
	<i>:Tune</i>	<i>X</i>		<i>X</i>		
<i>System Real Time</i>	<i>:Clock</i>	<i>X</i>		<i>X</i>		
	<i>:Commands</i>	<i>X</i>		<i>X</i>		
<i>Aux Messages</i>	<i>:Local ON/OFF</i>	<i>X</i>		<i>X</i>		
	<i>:All Notes Off</i>	<i>X</i>		<i>X</i>		
	<i>:Active Sense</i>	<i>X</i>		<i>X</i>		
	<i>:Reset</i>	<i>X</i>		<i>X</i>		
<i>Notes</i>	<p><i>1* Each Parameter can be linked to any control change. These assignment tables are stored in memory.</i></p> <p><i>2* For Preset map 1-128 (Preset Change can be mapped to Factory Presets, User Presets, or Bypass function).</i></p>					

Mode 1 : OMNI ON, POLY
Mode 3 : OMNI OFF, POLY

Mode 2 : OMNI ON, MONO
Mode 4 : OMNI OFF, MONO

0 : Yes
X : No

System Exclusive Implementation

MIDI System Exclusive communication allows a user to control a device directly through MIDI in a very powerful and flexible manner. Much care has gone into creating and testing this documentation but Johnson Amplification can not guarantee 100% accuracy, nor can Johnson Amplification be held responsible for presets and data lost in a product from System Exclusive Information use.

A working knowledge of the MIDI Version 1.0 Detailed Specification can be useful while implementing any manufacturer's SysEx commands. For a copy of the MIDI spec contact:

MIDI Manufacturers Association
5316 West 57th Street
Los Angeles, California 90056 USA
(213) 649-6434

It is a good practice to back up any user programs and/or user algorithms in the device before you begin to work with SysEx commands due to the fact that incorrect commands can produce unexpected results. Should you encounter any discrepancies between this documentation, and a Johnson Amplification S-DISC II™ MIDI, product please feel free to contact us at:

Johnson Amplification
Attn: Product Management Dept.
8760 South Sandy Parkway
Sandy, Utah 84070 USA
(801) 566-8800
<http://www.digitech.com>

MIDI Basics

MIDI Channels: The Millennium can be set so that they communicate on 1 of 16 discrete MIDI channels. Some devices may also be set up to transmit or receive information on all channels in an Omni mode or to none of the channels in a Disabled mode.

Preset Changes: When the Millennium is set to communicate on one or all of the MIDI channels, it will recognize a Preset Change command. If the number is legal (e.g. within the device's range of selectable presets) the Johnson Amplification device will respond by changing to the new preset. MIDI sends Preset Changes 0 through 127. Johnson Amplification devices begin their preset numbering with 1, thus Preset Change 0 will select preset 1. The Millennium also allows the user to 're-map' the Preset Change commands so that Preset Change 0 could call preset 135, if so desired.

Continuous Controllers: A MIDI Continuous Controller may be 'Linked' to nearly any available parameter in the Millennium. CC links (Modifiers) and their ranges are treated uniquely in each preset with the assignments being saved only if they are stored as part of the preset.

Channel Pressure: DigiTech products treat Channel Pressure as simply another type of Continuous Controller which can be linked to parameters for control.

Pitch Bend: Pitch Bend information is a higher resolution controller that is not supported in Johnson Amplification products, due to the density of the information and the resources needed to process it properly. Many MIDI control products offer the ability to map Pitch Bend to normal Continuous Controllers if a user wanted to control a parameter with a device such as a Pitch Bend Wheel.

General Format

The general format for the System Exclusive information is as follows (note: all SysEx values are displayed in Hexadecimal format, along with this symbol (h) for clarification):

Hex Value	Definition
F0(h)	System Exclusive 'Begin Message' byte
00(h)	
00(h)	Manufacturer's ID Number (Johnson Amplification)
10(h)	
0n(h)	n = Unit's Device or SysEx Channel number (minus one) e.g. 00(h) is device or SysEx Ch 1 01(h) is device or SysEx Ch 2 etc... 0F(h) is device or SysEx Ch 16
dd	dd = device ID number 4A(h) identifies the Millennium
pp	pp = Procedure number. The different procedure's names and general formats are described in the Procedures Section.
dd(1)1, dd(1)2.....dd(n)1, dd(n)2	
	dd = Data as needed by procedures. Since the standard MMA MIDI Specification reserves 80(h) through FF(h) (decimal numbers 128 through 255) for specific commands, a split byte format is adopted for all data communication in this SysEx implementation. dd(n)2 denotes the 1st through 7th bits of the nth byte and dd(n)1 denotes the 8th bit of the nth byte. Note: All data that is requested or received, is in split byte format unless noted otherwise.
F7(h)	System Exclusive 'End Message' byte

Procedures

In the following section, SYS_HEAD refers to a valid System Exclusive header. The System Exclusive header starts with the System Exclusive status byte, and includes all bytes through the Johnson Amplification device type. F7(h) is the System Exclusive 'Message End' byte. All SysEx numbers in the format definition of each procedure are given as hexadecimal values, along with this symbol (h) for clarification. Binary numbers are identified with this symbol (b).

REQUEST ONE PRESET (01b)

SYS_HEAD, 01(h), yy1, yy2, zz1, zz2 F7(h)

When yy = 00(h)	User bank is selected
When yy = 01(h)	Factory bank is selected
zz	The Preset number, 1-100 User (00-63(h)) or 1-100 Factory (00-63(h))

When a Request One Preset procedure is received, the Millennium will respond with a Receive One Preset procedure.

RECEIVE ONE PRESET (42b)

SYS_HEAD 42(h), vv(1)1, vv(1)2, vv(2)1, vv(2)2, yy1, yy2, zz1, zz2, dd(1st)1, dd(1st)2, ... dd(nth)1, dd(nth)2, F7(h)

vv software version number

When yy = 00(h)	User bank is selected
When yy = 01(h)	Factory bank is selected
zz	The Preset number, 1-100 (00-63h)
dd(n)	Preset data

The Receive One Preset procedure is used to load a preset into the Millennium. The number of preset bytes to be received (n) is different for each preset. If the Millennium is sent a Receive One Preset procedure where the preset number is not a valid RAM destination, it will be ignored.

REQUEST BULK DUMP (49b)

SYS_HEAD, 49(h), F7(h)

When a Request Bulk Dump procedure is received, the Millennium will respond with a Receive Bulk Dump procedure.

RECEIVE BULK DUMP (48b)

SYS_HEAD 48(h), dd(1st)1 dd(1st)2, ... dd(nth)1, dd(nth)2, F7(h)

dd(n)	Bulk Dump Data
-------	----------------

The Receive Bulk Dump procedure is used to load all User Programs into the Millennium. A software version number is imbedded in the data.

REQUEST UTILITY SETTINGS (11b)

SYS_HEAD, 11(h), F7(h)

When a Request Utility Settings procedure is received, the Millennium will respond with a Receive Utility Settings procedure.

RECEIVE UTILITY SETTINGS (12b)

SYS_HEAD 12(h), vv(1)1, vv(1)2, vv(2)1, vv(2)2, rr1, rr2, tt1, tt2, ee1, ee2, ff1, ff2, ss1, ss2, nn1, nn2, mm1, mm2, qq1, qq2, yy (1st)1,yy(1st)2, zz(1st)1,zz(1st)2 ... yy(128th)1,yy(128th)2, zz(128th)1,zz(128th)2, F7(h)

vv =	software version number
rr =	MIDI Receive Channel (range = 00(h) ~ 07(h))
tt =	MIDI Transmit Channel (range = 00(h) ~ 07 (h))
ee =	Cabinet Emulator (range = 00(h) ~ 07 (h))
ff =	Foot Controller (range = 00(h) ~ 07(h))
ss =	SysEx Channel (Millennium only)
nn	MIDI Merge On/Off (Millennium only)
mm	Mono-Stereo (range = 00(h) ~ 01(h))
qq	EQ mode (range = 00(h) ~ 07(h))
yy, zz	Preset Map Settings (MIDI Preset changes 1 ~ 128 = map)
When yy = 00(h)	User Bank is selected
When yy = 01(h)	Factory Bank is selected
When yy = 02(h)	and zz =00(h), Bypass toggle is selected
zz	Preset Number.

REQUEST PARAMETER VALUE (17b)

SYS_HEAD 17(h), aa1, aa2,bb's1, bb's2, F7(h)

aa	Effect Module's Position
bb's	Effect Parameter's Position

When a Request Parameter Value procedure is received, the Millennium will respond with a Receive Parameter Value procedure.

RECEIVE PARAMETER VALUE (18b)

SYS_HEAD 18(h), aa1,aa2, bb's1, bb's2,cc1, cc2, F7(h)

aa	Effect Module's Position
bb's	Effect Parameter's Position
cc	Parameter Value

The Receive Parameter Value procedure is used to load Parameter Values into the Millennium. Please refer to the Parameter Charts for more information.

REQUEST ALL CURRENT PARAMETER VALUES (23b)

SYS_HEAD, 23(h), ww1, ww2, F7(h)

When ww= 7F(h) All module's parameters will be requested.
 When ww= 68(h) (position of the module minus 1), only that module's parameters will be requested.
 ww Requested Module's parameter Values

When a Request All Current Parameter Values procedure is received, the Millennium will respond with a Respond All Current Parameter Values procedure.

RECEIVE ALL CURRENT PARAMETER VALUES FOR CURRENT PRESET (24b)

SYS_HEAD, 24(h), nn1, nn2, ww1, ww2, mm1(1st), mm2(1st), aa1(1st), aa2(1st), dd1(1st)(1st), dd2(1st)1st, ... dd1(1st)(wth), dd2(1st)(wth), ... mm1(xth),...mm2(xth), aa1(xth), aa2(xth), dd1(xth)(1st), dd2(xth)(1st), ... dd1(xth)(wth),dd2(xth)(wth), F7(h)

When ww= 7F(h) All module's parameters will be received.
 When ww= 68(h) (position of the modules minus 1), only that module's parameters will be received.

nn Number of Modules.
 ww Modules User requested.
 mm Indicates the beginning of the xth Module.
 aa Number of available parameters in the FX Module.
 dd Current value for the wth parameter.

The Receive All Current Parameter Values procedure is used to receive Parameter Values from the Millennium for the currently selected program.

Warning: Sending data that was retrieved from a different preset will delete the memory. Be sure to only send data that was received from the same preset.

REQUEST MODULE CONFIGURATION (25b)

SYS HEAD , 25 (h) , F7 (h)

When a Request Module Configuration procedure received, the Millennium will respond with a Respond Module Configuration procedure.

RESPOND MODULE CONFIGURATION (26b)

SYS HEAD , 26(h) , nn1, nn2, cc(1st)1,cc(1st)2, ee(1st)1, ee(1st)2, ... cc(nth)1, cc(nth)2 , ee(nth)1, ee(nth)2, F7(h)

nn Number modules present in the algorithm
 cc Class I.D. of the nth module in the algorithm
 ee I.D. number of the effect currently loaded in the nth module (see pg. 12 for ID numbers)

Class I.D. Numbers for millennium

00(h) Amplifier Type
 01(h) 1/4 Effect Module

02(h)	1/2 Effect Module
03(h)	3/4 Effect Module
04(h)	Whole Effect Module

RECEIVE KEY SCAN CODE (54b)

SYS_HEAD, 54(h), cc, F7(h)

cc Code for the Key Scan (*note: there is only one byte, not two*)

The Receive Key Scan Code procedure is used to emulate a button press on the front panel of the. See the Key Scan Code Maps (page 96) for a list of Key Scan codes.

RECEIVE HOLD KEY SCAN CODE (55b)

SYS_HEAD, 55(h), cc, 68, F7(h)

cc Code for the Key Scan (*note: there is only one byte, not two*)

68Time key is pressed expressed in 0.1 seconds increments (*note: there is only one byte, not two*)

The Receive Hold Key Scan Code procedure is used to emulate a button press and hold on the front panel of the Millennium. The device will respond with a Receive Key Accepted procedure.

RECEIVE KEY ACCEPTED (56b)

SYS_HEAD, 56(h), cc1, cc2, F7(h)

cc Code echoed for the Key Scan received. (00(h) if key is invalid)

The Receive Key Accepted procedure is sent from the Millennium in response and acceptance of a Receive Scan Code Key or Receive Hold Scan Code Key procedure but is ignored if received by the Millennium.

SELECT ONE PRESET (1Fb)

SYS_HEAD, 1F(h), yy1, yy2, zz1, zz2 F7(h)

When yy = 00(h) User bank is selected

When yy = 01(h) Factory bank is selected.

zz The Preset number, 1-100 User (00-63(h)) or 1-191 Factory (00-BE(h))

This command behaves like a standard MIDI Preset Change command, except that it allows the selection of any preset in the Millennium without the use of mapping.

RESET PRESET (20b)

SYS_HEAD, 20(h), F7(h)

The Reset Preset procedure causes the Millennium to reload the current saved program.

RESET DEVICE (21b)

SYS_HEAD, 21(h), F7(h)

The Reset Device procedure causes the Millennium to reboot the software as if the power had been turned off, and then back on. If edits have been made to the current preset without saving, they will be lost.

RESET FACTORY SETTINGS (22b)

SYS_HEAD, 22(h), F7(h)

The Reset Factory Settings procedure causes the Millennium to reload a sections of the EPROM factory defaults and perform a hard reset.

REQUEST USER DEFAULTS (13b)

SYS_HEAD, 13(h), yy1, yy2, zz1, zz2 F7(h)

When a Request User Default procedure is received, the Millennium will respond with a Receive User Defaults procedure.

yy= effect ID #

zz= index map max = 5

FX ID # = 255

RECEIVE USER DEFAULTS (14b)

SYS_HEAD,14(h), yy1, yy2, zz1, zz2 F7(h)

The Receive User Defaults procedure is used to receive User Defaults.

yy= effect ID #

zz= index map max = 5

FX ID # = 255

SysEx Button/Keys/Footswitch codes

The following are codes for each of the buttons or keys on the Millennium. Numbers are given as hexadecimal values.

Key Label	Hex equivalent	Key Label	Hex equivalent
Input Knob	54(h)	J-12 Bank Up	41(h)
Mix/Page	10(h)	J-12 Bank Down	42(h)
RVB	F(h)	Preset button	01(h)
DLY	E(h)	Digital Effect Bypass	02(h)
PCH	D(h)	Utility button	03(h)
MOD	C(h)	Edit button	09(h)
Gain	14(h)	Assign button	A(h)
Treble	15(h)	Store button	B(h)
Mid	16(h)	American Stk button	21(h)
Bass	17(h)	American Combo button	29(h)
Level	18(h)	British Stack	22(h)
J-3 FS A	5(h)	British Combo	24(h)
J-3 FS B	6(h)	Johnson button	23(h)
J-3 FS C	7(h)	Configuration button	11(h)
J-3 Preset Up	24(h)	Mod button	12(h)
J-3 Preset Down	25(h)	Delay button	13(h)
J-3 List Up	26(h)	Reverb button	19(h)
J-3 List Down	27(h)	Other button	1a(h)
J-12 Fs 1	31(h)	TapIt button	1b(h)
J-12 Fs 2	32(h)		
J-12 Fs 3	33(h)		
J-12 Fs 4	35(h)		
J-12 Fs 5	36(h)		
J-12 Fs 6	37(h)		
J-12 Fs 7	38(h)		
J-12 Fs 8	39(h)		
J-12 Fs 9	40(h)		
J-12 Fs 10	41(h)		

SysEx Preset Dump Example

For those of you that are reluctant to stick your feet in the SysEx water, we have included a simple example of a SysEx Preset jump. It takes you set by step through all of the operation commands of a typical SysEx procedure.

```

<<SysEx Header>>
F0 00 00 10 47
<<Procedure>>
42
<<Preset Dump Version>>
00 01 00 01
<<Bank and Preset for User Preset 1>>
00 00 00 00
<<Preset's Transmit Count...Lo Bytes, Hi Bytes>>
00 0A 00 06
<<FX Module Count for Module IDs>>
00 07
<<Module ID Numbers>>
00 0C 00 10 00 15 00 20 00 01 00 5A 00 77
<<Algorithm Number>>
00 00
<<FX Module Count for Module Types>>
00 07
<<FX Module Class Type
00 22 00 24 00 18 00 07 00 00 00 06 00 03
<<20 Character Preset Name...dynamic>>
00 31 00 3A 00 52 00 76 00 62 00 20 00 32 00 3A 00 47 00 74 00 52 00 76
00 20 00 33 00 3A 00 44 00 6C 00 79 00 20 00 34 00 3A 00 43 00 68 00 6F
<<Null to indicate end of Character String>>
00 00
<<Misc Preset Data...too dynamic to document>>
00 07 00 00 00 06 00 00 00 03 00 06 00 03 00 32 00 08 00 03 00 00 00 00 00 02 00 04 00 00 00 00 00 02 00 08
00 00 00 00.....
                                ..... 01 7E 00 00 00 00 20 01 7F 00 00 00 00 20 00 00 00 00 00 20 00 01 00 00 00
00 00 20 00 02 00 00 00 00 20 00 00 00 00 00 00 00 00 00 00 00 00 00 00 00 00 00 00 00 00 00 00 00 00 00
<<SysEx End>>
F7

```

NOTE: *When the length of the program name is modified, the Preset's Transmit Count must also be modified accordingly.*

FX Module codes and numbers

The Following chart shows all effect modules and their respective parameters with SysEx Effect I.D. numbers attached.

FX #	FX Name	EditPage	P#	Parameter Name						
131(b)	Tube Dist.	Page 1	00(h)	On/Off			01(h) Default type			
			01(h)	Default type			02(h) Level			
		Page 2	02(h)	Distortion Type			Page 3	03(h) Phase		
			03(h)	Gain level			04(h) 80Hz			
							05(h) 140Hz			
								06(h) 250Hz		
								07(h) 450Hz		
							Page 4	08(h) 800Hz		
								09(h) 1.5kHz		
								10(h) 2.5kHz		
								11(h) 4.5kHz		
						12(h) 8kHz				
132(b)	Tube EQ	Page 1	00(h)	On/Off			08(h) 15kHz			
			01(h)	Default type						
		Page 2	02(h)	Level			Page 5			
			03(h)	Phase						
		Page 3	04(h)	80Hz			135(b) Noise Gate	Page 1	00(h) On/Off	
			05(h)	140Hz					01(h) Default type	
			06(h)	250Hz					Page 2	02(h) Noise gate Type
			07(h)	450Hz					Page 3	03(h) Threshold
		Page 4	08(h)	800Hz					04(h) Attenuation	
			09(h)	1.5kHz					05(h) Attack	
			10(h)	2.5kHz					06(h) Release	
			11(h)	4.5kHz						
		Page 5	12(h)	8kHz			3F(b) GEQ 8	Page 1	00(h) On/Off	
			08(h)	15kHz					01(h) FX Type	
									02(h) Default Type	
									Page 2	03(h) Level
		Page 4	09(h)	160Hz					04(h) Phase	
			0A(h)	250Hz					05(h) 80Hz	
			0B(h)	400Hz					06(h) 160Hz	
0C(h)	630Hz						07(h) 315Hz			
Page 5	0D(h)		1kHz					08(h) 630Hz		
	0E(h)		1.6kHz							
	0F(h)		2.5kHz			Page 4	09(h) 1.25kHz			
	10(h)		4.0kHz				0A(h) 2.5kHz			
Page 6	11(h)	6.3kHz					0B(h) 5.0kHz			
	12(h)	10.0kHz					0C(h) 10.0kHz			
	13(h)	16.0kHz								
133(b)	S. State Dist.	Page 1	00(h)	On/Off			00(h) On/Off			
			01(h)	Default type			01(h) FX Type			
		Page 2	02(h)	Distortion Type					02(h) Default Type	
			03(h)	Distortion Gain			Page 2	03(h) Level		
								04(h) Phase		
								05(h) 25Hz		
								06(h) 40Hz		
							Page 3	07(h) 63Hz		
134(b)	S. State EQ	Page 1	00(h)	On/Off						

		08(h)	100Hz			1F(h)	8.0kHz
	Page 4	09(h)	160Hz			20(h)	10.0kHz
		0A(h)	250Hz		Page 9	21(h)	12.5kHz
		0B(h)	400Hz			22(h)	16.0kHz
		0C(h)	630Hz			23(h)	18.0kHz
	Page 5	0D(h)	1kHz				
		0E(h)	1.6kHz	41(b)	St GEQ 8	Page 1	00(h) On/Off
		0F(h)	2.5kHz				01(h) FX Type
		10(h)	4.0kHz				02(h) Default
	Page 6	11(h)	6.3kHz		Page 2	03(h)	Level
		12(h)	10.0kHz			04(h)	Phase L
		13(h)	16.0kHz			05(h)	Phase R
					Page 3	06(h)	80Hz
43(b)	GEQ 31	Page 1	00(h) On/Off			07(h)	160Hz
			01(h) FX Type			08(h)	315Hz
			02(h) Default Type			09(h)	630Hz
	Page 2	03(h)	Level		Page 4	0A(h)	1.25kHz
		04(h)	Phase			0B(h)	2.5kHz
	Page 3	05(h)	20Hz			0C(h)	5.0kHz
		06(h)	25Hz			0D(h)	10.0kHz
		07(h)	31.5Hz				
	Page 4	08(h)	40Hz				
		09(h)	50Hz	44(b)	St PEQ 3	Page 1	00(h) On/Off
		0A(h)	63Hz				01(h) FX Type
		0B(h)	80Hz				02(h) Default
	Page 5	0C(h)	100Hz		Page 2	03(h)	Level
		0D(h)	125Hz			04(h)	PhaseL
		0E(h)	160Hz			05(h)	PhaseR
		0F(h)	200Hz		Page 3	06(h)	Band1 Freq
		10(h)	250Hz			07(h)	Width Level
	Page 6	11(h)	315Hz		Page 4	08(h)	Band2 Level
		12(h)	400Hz			09(h)	Width Level
		13(h)	500Hz		Page 5	0A(h)	Band3 Freq
		14(h)	630Hz			0B(h)	Width Level
	Page 7	15(h)	800Hz				
		16(h)	1.0kHz	45(b)	PEQ 6	Page 1	00(h) On/Off
		17(h)	1.25kHz				01(h) FX Type
		18(h)	1.6kHz				02(h) Default
	Page 8	19(h)	2.0kHz		Page 2	03(h)	Level
		1A(h)	2.5kHz			04(h)	Phase Inv
		1B(h)	3.15kHz		Page 3	05(h)	LoShlv Freq
		1C(h)	4.0kHz			06(h)	Level
	Page 9	1D(h)	5.0kHz		Page 4	07(h)	Band1 Freq
		1E(h)	6.3kHz			08(h)	Width Level

	Page 5	09(h)	Band2 Freq			0C(h)	PanA
		0A(h)	Width Level			0D(h)	OutB
	Page 6	0B(h)	Band3 Freq			0E(h)	PanB
		0C(h)	Width Level				
	Page 7	0D(h)	Band4 Freq	20(b) Quad Cho	Page 1	00(h)	On/Off
		0E(h)	Width Level			01(h)	FX Type
	Page 8	0F(h)	HiShlv Freq			02(h)	Default
		10(h)	Level		Page 2	03(h)	FX Level
						04(h)	Dry Level
46(b) St PEQ 6	Page 1	00(h)	On/Off			05(h)	Balance
		01(h)	FX Type		Page 3	06(h)	Speed
		02(h)	Default			07(h)	Depth
	Page 2	03(h)	Level			08(h)	Waveform
		04(h)	Phase L		Page 4	09(h)	DlyA
		05(h)	Phase R			0A(h)	DlyB
	Page 3	06(h)	Loshlv Freq			0B(h)	DlyC
		07(h)	Level			0C(h)	DlyD
	Page 4	08(h)	Band1 Freq		Page 5	0D(h)	OutA
		09(h)	Width			0E(h)	PanA
		0A(h)	Level			0F(h)	OutB
	Page 5	0B(h)	Band 2 Freq			10(h)	PanB
		0C(h)	Width		Page 6	11(h)	OutC
		0D(h)	Level			12(h)	PanC
	Page 6	0E(h)	Band3 Freq			13(h)	OutD
		0F(h)	Width			14(h)	PanD
		10(h)	Level				
	Page 7	11(h)	Band4 Freq	22(b) Octal Cho	Page 1	00(h)	On/Off
		12(h)	Width			01(h)	FX Type
		13(h)	Level			02(h)	Default
	Page 8	14(h)	HiShlv Freq		Page 2	03(h)	FX Level
		15(h)	Level			04(h)	Dry Level
						05(h)	Balance
1F(b) Dual Cho	Page 1	00(h)	On/Off		Page 3	06(h)	Speed
		01(h)	FX Type			07(h)	Depth1
		02(h)	Default			08(h)	Depth2
	Page 2	03(h)	FX Level		Page 4	09(h)	Speed
		04(h)	Dry Level			0A(h)	Depth
		05(h)	Balance		Page 5	0B(h)	DlyA
	Page 3	06(h)	Speed			0C(h)	DlyB
		07(h)	Depth			0D(h)	DlyC
		08(h)	Waveform			0E(h)	DlyD
	Page 4	09(h)	DlyA		Page 6	0F(h)	DlyE
		0A(h)	DlyB			10(h)	DlyF
	Page 5	0B(h)	OutA			11(h)	DlyG

			12(h)	DlyH			09(h)	Rotor Lvl
		Page 7	13(h)	Spread		Page 4	0A(h)	Dummy (ignore)
47(b) Dual Flange	Page 1		00(h)	On/Off			0B(h)	Horn Slow Speed
			01(h)	FX Type			0C(h)	Horn Slow Depth
			02(h)	Default		Page 5	0D(h)	Horn Slow Doppler
	Page 2		03(h)	FX level			0E(h)	Dummy (ignore)
			04(h)	Dry Level			0F(h)	Horn Fast Speed
			05(h)	Balance			10(h)	Horn Fast Depth
	Page 3		06(h)	Speed		Page 6	11(h)	Horn Fast Doppler
			07(h)	Depth			12(h)	Dummy (ignore)
			08(h)	Feedback			13(h)	Rotor Slow Speed
			09(h)	Waveform		Page 7	14(h)	Roto Slow Depth
	Page 4		0A(h)	DlyA			15(h)	Dummy (ignore)
			0B(h)	DlyB			16(h)	Rotor Fast Speed
	Page 5		0C(h)	OutA		Page 8	17(h)	Roto Fast Depth
			0D(h)	PanA			18(h)	X-Over
			0E(h)	OutB			19(h)	Horn Acceleration
			0F(h)	PanB			1A(h)	Rotor Acceleration
4B(b) Dual Phaser	Page 1		00(h)	On/Off	50(b) St. Tremolo	Page 1	00(h)	On/Off
			01(h)	FX Type			01(h)	FX Type
			02(h)	Default		Page 2	02(h)	Default
	Page 2		03(h)	FX Level			03(h)	Level
			04(h)	Dry Level			04(h)	Speed
			05(h)	Balance			05(h)	Depth
	Page 3		06(h)	Speed			06(h)	Waveform
			07(h)	Depth	51(b) AutoPanner	Page 1	00(h)	On/Off
			08(h)	Feedback			01(h)	FX Type
			09(h)	Waveform		Page 2	02(h)	Default
	Page 4		0A(h)	OutA			03(h)	Level
			0B(h)	PanA			04(h)	Speed
			0C(h)	OutB			05(h)	Depth
			0D(h)	PanB			06(h)	Waveform
30(b) Rotary Speaker	Page 1		00(h)	On/Off	2C(b) Dual Detune	Page 1	00(h)	On/Off
			01(h)	FX Type			01(h)	FX Type
			02(h)	Default		Page 2	02(h)	Default
	Page 2		03(h)	FX Level			03(h)	FX Level
			04(h)	Dry Level			04(h)	Dry Level
			05(h)	Balance			05(h)	Balance
	Page 3		06(h)	Mode		Page 3	06(h)	DtnA
			07(h)	Spread			07(h)	DtnB
			08(h)	Horn Lvl			08(h)	DlyA

		09(h)	DlyB			0F(h)	DlyB
	Page 4	0A(h)	OutA			10(h)	DlyC
		0B(h)	PanA			11(h)	DlyD
		0C(h)	OutB		Page 6	12(h)	DlyE
		0D(h)	PanB			13(h)	DlyF
						14(h)	DlyG
						15(h)	DlyH
2E(b) Quad Detune	Page 1	00(h)	On/Off			16(h)	Spread
		01(h)	FX Type		Page 7		
		02(h)	Default				
	Page 2	03(h)	FX Level	26(b) Smooth Pitch	Page 1	00(h)	On/Off
		04(h)	Dry Level			01(h)	FX Type
		05(h)	Balance				
	Page 3	06(h)	DetnA			02(h)	Default
		07(h)	DetnB		Page 2	03(h)	FX Level
		08(h)	DetnC			04(h)	Dry Level
		09(h)	DetnD			05(h)	Balance
	Page 4	0A(h)	DlyA		Page 3	06(h)	Shft
		0B(h)	DlyB			07(h)	Dtn
		0C(h)	DlyC			08(h)	OutB
		0D(h)	DlyD			09(h)	PanB
	Page 5	0E(h)	OutA				
		0F(h)	PanA	28(b) Dual Pitch	Page 1	00(h)	On/Off
		10(h)	OutB			01(h)	FX Type
		11(h)	PanB			02(h)	Default
	Page 6	12(h)	OutC		Page 2	03(h)	FX Level
		13(h)	PanC			04(h)	Dry Level
		14(h)	OutD			05(h)	Balance
		15(h)	PanD		Page 3	06(h)	ShftA
						07(h)	DtnA
						08(h)	ShftB
						09(h)	DtnB
2F(b) Octal Detune	Page 1	00(h)	On/Off			0A(h)	OutA
		01(h)	FX Type		Page 4	0B(h)	PanA
		02(h)	Default			0C(h)	OutB
	Page 2	03(h)	FX Level			0D(h)	PanB
		04(h)	Dry Level				
		05(h)	Balance				
	Page 3	06(h)	DetnA	2A(b) Quad Pitch	Page 1	00(h)	On/Off
		07(h)	DetnB			01(h)	FX Type
		08(h)	DetnC			02(h)	Default
		09(h)	DetnD		Page 2	03(h)	FX Level
	Page 4	0A(h)	DetnE			04(h)	Dry Level
		0B(h)	DetnF			05(h)	Balance
		0C(h)	DetnG				
		0D(h)	DetnH		Page 3	06(h)	ShftA
	Page 5	0E(h)	DlyA			07(h)	DtnA

		08(h)	ShiftB			ID(h)	OutH
		09(h)	DtnB		Page 9	1E(h)	Spread
Page 4		0A(h)	ShiftC				
		0B(h)	DtnC	27(b) Stereo Pitch	Page 1	00(h)	On/Off
		0C(h)	ShiftD			01(h)	FX Type
		0D(h)	DtnD			02(h)	Default
Page 5		0E(h)	Out A		Page 2	03(h)	FX Level
		0F(h)	PanA			04(h)	Dry Level
		10(h)	OutB			05(h)	Balance
		11(h)	PanB		Page 3	06(h)	Shift
Page 6		12(h)	OutC			07(h)	Dtn
		13(h)	PanC			08(h)	OutL
		14(h)	OutD			09(h)	OutR
		15(h)	PanD				
				29(b) St Dual Pitch	Page 1	00(h)	On/Off
2B(b) Octal Pitch	Page 1	00(h)	On/Off			01(h)	FX Type
		01(h)	FX Type			02(h)	Default
		02(h)	Default		Page 2	03(h)	FX Level
Page 2		03(h)	FX Level			04(h)	Dry Level
		04(h)	Dry Level			05(h)	Balance
		05(h)	Balance		Page 3	06(h)	ShiftA
Page 3		06(h)	ShiftA			07(h)	DtnA
		07(h)	DetnA			08(h)	ShiftB
		08(h)	ShiftB			09(h)	DtnB
		09(h)	DtnB		Page 4	0A(h)	OutLA
Page 4		0A(h)	ShiftC			0B(h)	OutLB
		0B(h)	DetnC			0C(h)	OutRA
		0C(h)	ShiftD			0D(h)	OutRB
		0D(h)	DetnD				
Page 5		0E(h)	ShiftE	25(b) Harmony	Page 1	00(h)	On/Off
		0F(h)	DetnE			01(h)	FX Type
		10(h)	ShiftF			02(h)	Default
		11(h)	DetnF		Page 2	03(h)	FX Level
Page 6		12(h)	ShiftG			04(h)	Dry Level
		13(h)	DetnG			05(h)	Balance
		14(h)	ShiftH		Page 3	06(h)	Key
		15(h)	DetnH			07(h)	Scale
Page 7		16(h)	OutA		Page 4	08(h)	Interval
		17(h)	OutB		Page 5	09(h)	Level
		18(h)	OutC			0A(h)	Pan
		19(h)	OutD				
Page 8		1A(h)	OutE	12(b) Delay(370ms)			
		1B(h)	OutF	14(b) Delay(700ms)			
		1C(h)	OutG	19(b) Delay(1400ms)	Page 1	00(h)	On/Off
						01(h)	FX Type

		02(h)	Default			0F(h)	OutB
	Page 2	03(h)	FX Level			10(h)	PanB
		04(h)	Dry Level		Page 6	11(h)	OutC
		05(h)	Balance			12(h)	PanC
	Page 3	06(h)	Delay Time			13(h)	OutD
		07(h)	FeedBack			14(h)	PanD
		08(h)	Tapit (ignore)				
	Page 4	09(h)	Out	17(b) S Delay(370ms)			
		0A(h)	Pan	1C(h) S Delay(700ms)	Page 1	00(h)	On/Off
						01(h)	FX Type
						02(h)	Default
Dual Dly(370ms)							
15(b) Dual Dly(700ms)					Page 2	03(h)	FX Level
1A(b) Dual Dly(1400ms)	Page 1	00(h)	On/Off			04(h)	Dry Level
		01(h)	FX Type			05(h)	Balance
		02(h)	Default		Page 3	06(h)	Delay Time
	Page 2	03(h)	FX Level			07(h)	FeedBack
		04(h)	Dry Level			08(h)	Tapit (ignore)
		05(h)	Balance		Page 4	09(h)	OutL
	Page 3	06(h)	Delay Time			0A(h)	OutR
		07(h)	FeedBack				
		08(h)	Tapit (ignore)	18(b) St. DI Dly(370ms)			
	Page 4	09(h)	DlyA	1D(h) St. DI Dly(700ms)	Page 1	00(h)	On/Off
		0A(h)	DlyB			01(h)	FX Type
	Page 5	0B(h)	OutA			02(h)	Default
		0C(h)	PanA		Page 2	03(h)	FX Level
		0D(h)	OutB			04(h)	Dry Level
		0E(h)	PanB			05(h)	Balance
					Page 3	06(h)	Delay Time
						07(h)	FeedBack
16(b) Quad Dly(700ms)						08(h)	Tapit (ignore)
1B(b) Quad Dly(1400ms)	Page 1	00(h)	On/Off			09(h)	DlyA
		01(h)	FX Type		Page 4	0A(h)	DlyB
		02(h)	Default				
	Page 2	03(h)	FX Level		Page 5	0B(h)	OutLA
		04(h)	Dry Level			0C(h)	OutLB
		05(h)	Balance			0D(h)	OutRA
	Page 3	06(h)	Delay Time			0E(h)	OutRB
		07(h)	FeedBack				
		08(h)	Tapit (ignore)	1E(b) St. Quad Delay	Page 1	00(h)	On/Off
	Page 4	09(h)	DlyA			01(h)	FX Type
		0A(h)	DlyB			02(h)	Default
		0B(h)	DlyC		Page 2	03(h)	FX Level
		0C(h)	DlyD			04(h)	Dry Level
	Page 5	0D(h)	OutA			05(h)	Balance
		0E(h)	PanA		Page 3	06(h)	Delay Time

		07(h)	FeedBack			0B(h)	Freq
		08(h)	Tapit (ignore)			0C(h)	Gain
	Page 4	09(h)	DlyA		Page 5	0D(h)	OutL
		0A(h)	DlyB			0E(h)	OutR
		0B(h)	DlyC				
		0C(h)	DlyD	37(h) Chorus/Dly	Page 1	00(h)	On/Off
	Page 5	0D(h)	OutLA			01(h)	FX Type
		0E(h)	OutLB			02(h)	Default
		0F(h)	OutLC		Page 2	03(h)	FX Level
		10(h)	OutLD			04(h)	Dry Level
	Page 6	11(h)	OutRA			05(h)	Balance
		11(h)	OutRB		Page 3	06(h)	Route
		13(h)	OutRC		Page 4	07(h)	Speed
		14(h)	OutRD			08(h)	Depth
					Page 5	09(h)	WvFrm
32(h) Alog Dly(370ms)						0A(h)	Chorus Delay
34(h) Alog Dly(700ms)					Page 6	0B(h)	Delay Time
36(h) Alog Dly(1400ms)	Page 1	00(h)	On/Off			0C(h)	Delay Feedback
		01(h)	FX Type			0D(h)	Tapit (ignore)
		02(h)	Default		Page 7	0E(h)	Chorus Level
	Page 2	03(h)	FX Level			0F(h)	Chorus Pan
		04(h)	Dry Level			10(h)	Delay Level
		05(h)	Balance			11(h)	Delay Pan
	Page 3	06(h)	Delay Time				
		07(h)	FeedBack	38(h) Flange/Dly	Page 1	00(h)	On/Off
		08(h)	TapIt (ignore)			01(h)	FX Type
	Page 4	09(h)	Smear			02(h)	Default
		0A(h)	LPF Type		Page 2	03(h)	FX Level
		0B(h)	Freq			04(h)	Dry Level
		0C(h)	Gain			05(h)	Balance
	Page 5	0D(h)	Out		Page 3	06(h)	Route
		0E(h)	Pan		Page 4	07(h)	Speed
						08(h)	Depth
						09(h)	Flange Feedback
33(h) St.A.Dly(370ms)					Page 5	09(h)	WvFrm
35(h) St.A.Dly(700ms)	Page 1	00(h)	On/Off			0A(h)	Flange Delay
		01(h)	FX Type			0B(h)	Delay Time
		02(h)	Default		Page 6	0C(h)	Delay Feedback
	Page 2	03(h)	FX Level			0D(h)	Tapit (ignore)
		04(h)	Dry Level			0E(h)	Flange Level
		05(h)	Balance		Page 7	0F(h)	Flange Pan
	Page 3	06(h)	Delay Time			10(h)	Delay Level
		07(h)	FeedBack			11(h)	Delay Pan
		08(h)	TapIt (ignore)			12(h)	Balance
	Page 4	09(h)	Smear0A(h) LPF Type				

					Page 8	12(h)	Secondary Decay
09(b) PreDelay	Page 1	00(h)	On/Off			13(h)	Secondary Size
		01(h)	FX Type			14(h)	Second Reflection
		02(h)	Default		Page 9	15(h)	Primary OutL
	Page 2	03(h)	FX Level			16(h)	Primary OutR
		04(h)	Dry Level		Page 10	17(h)	Secondary OutL
		05(h)	Balance			18(h)	Secondary OutR
	Page 3	06(h)	Delay				
		07(h)	Filter Type	0D(b) Stereo Reverb	Page 1	00(h)	On/Off
		08(h)	Frequency			01(h)	FX Type
	Page 4	09(h)	OutL			02(h)	Default
0A(h)		OutR	Page 2		03(h)	FX Level	
0A(b) Reverb	Page 1	00(h)	On/Off			04(h)	Dry Level
		01(h)	FX Type			05(h)	Balance
		02(h)	Default		Page 3	06(h)	Reverb Type
	Page 2	03(h)	FX Level			07(h)	Decay
		04(h)	Dry Level		Page 4	08(h)	Density
		05(h)	Balance			09(h)	Diffusion
	Page 3	06(h)	Type	Page 5	0A(h)	Blend	
		07(h)	Decay		0B(h)	OutL	
		Page 4	08(h)	Density		0C(h)	OutR
	09(h)		Diffusion	10(b) Gated Reverb	Page 1	00(h)	On/Off
Page 5	0A(h)		OutL			01(h)	FX Type
	0B(h)	OutR			02(h)	Default	
0C(b) Dual Reverb	Page 1	00(h)	On/Off		Page 2	03(h)	FX Level
		01(h)	FX Type			04(h)	Dry Level
		02(h)	Default			05(h)	Balance
	Page 2	03(h)	FX Level		Page 3	06(h)	Type
		04(h)	Dry Level			07(h)	Time
		05(h)	Balance		Page 4	08(h)	Density
	Page 3	06(h)	Density			09(h)	LowPass
		07(h)	Diffusion	Page 5	0A(h)	OutL	
		08(h)	Dispersion		0B(h)	OutR	
	Page 4	09(h)	X-Over Type	11(b) St Gated Reverb	Page 1	00(h)	On/Off
0A(h)		Frequency			01(h)	FX Type	
Page 5		0B(h)	Primary X-Over			02(h)	Default
	0C(h)	Secondary X-Over	Page 2		03(h)	FX Level	
Page 6	0D(h)	Primary Damp			04(h)	Dry Level	
	0E(h)	Secondary Damp			05(h)	Balance	
	Page 7	0F(h)	Primary Decay		Page 3	06(h)	Type
10(h)		Primary Size			07(h)	Time	
11(h)		Primary Reflection	Page 4		08(h)	Density	

		09(h)	Dispersion			06(h)	Thrsh Closed
		0A(h)	Low Pass			07(h)	Attn
	Page 5	0B(h)	Blend		Page 3	08(h)	Delay
		0C(h)	OutL			09(h)	Attack
		0D(h)	OutR			0A(h)	Hold
						0B(h)	Release
8(h) Spring Reverb	Page 1	00(h)	On/Off	7D(h) Thru	Page 1	00(h)	FX Type
		01(h)	FX Type				
		02(h)	Default	7E(h) Mute	Page 1	00(h)	FX Ty
	Page 2	03(h)	FX Level				
		04(h)	Dry Level				
0F(h) Room Echo	Page 1	00(h)	On/Off				
		01(h)	FX Type				
		02(h)	Default				
	Page 2	03(h)	FX Level				
		04(h)	Dry Level				
		05(h)	Balance				
	Page 3	06(h)	Delay A				
		07(h)	Delay B				
		08(h)	Delay C				
		09(h)	Delay D				
	Page 4	0A(h)	Out A				
		0B(h)	Bal A				
		0C(h)	Out B				
		0D(h)	Bal B				
	Page 5	0E(h)	Out C				
		0F(h)	Bal C				
		10(h)	Out D				
		11(h)	Bal D				
	Page 6	12(h)	Shape Type				
		13(h)	Spread				
	Page 7	14(h)	Diffusion				
		15(h)	Feedback Delay				
		16(h)	Feedback Amount				
	Page 8	17(h)	OutL				
		18(h)	OutR				
52(h) Noise Gate	Page 1	00(h)	On/Off				
		01(h)	FX Type				
		02(h)	Default				
	Page 2	04(h)	Level				
		05(h)	Thrsh Open				



*8760 South Sandy Parkway
Sandy, Utah, 84070*

*Telephone 801.566.8800
FAX 801.566.7005*

*International Distribution:
3 Overlook Drive, Unit 4
Amherst, New Hampshire 03031 U.S.A.
FAX 603.672.4246*

*Johnson Amplification™, Millennium™, and S-DISC™ II are registered trademarks
of the Harman Music Group Incorporated*

*Copyright © 1997
the Harman Music Group Incorporated*

*Printed In U.S.A. 6/97
Manufactured in the U.S.A.*

Millennium Stereo 150 18-2195-A

Please Visit Johnson Amplification on the World Wide Web at:

<http://digitech.com>

Free Manuals Download Website

<http://myh66.com>

<http://usermanuals.us>

<http://www.somanuals.com>

<http://www.4manuals.cc>

<http://www.manual-lib.com>

<http://www.404manual.com>

<http://www.luxmanual.com>

<http://aubethermostatmanual.com>

Golf course search by state

<http://golfingnear.com>

Email search by domain

<http://emailbydomain.com>

Auto manuals search

<http://auto.somanuals.com>

TV manuals search

<http://tv.somanuals.com>