



OM-201 540K

2007-10

Processes



MIG (GMAW) Welding

Pulsed MIG (GMAW-P)

Flux Cored (FCAW) Welding



Automatic Welding

Description



Automatic Welding Interface And
Arc Welding Power Source

Auto Access 675TM

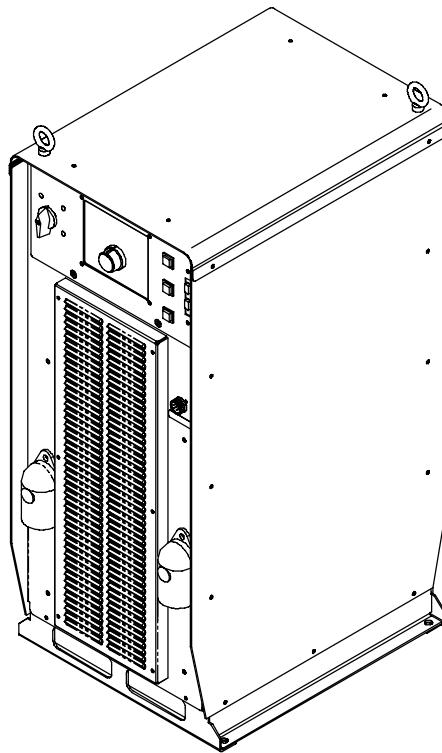

Visit our website at
www.MillerWelds.com/ams

OWNER'S MANUAL

File: Advanced Manufacturing Systems



From Miller to You

Thank you and congratulations on choosing Miller. Now you can get the job done and get it done right. We know you don't have time to do it any other way.

That's why when Niels Miller first started building arc welders in 1929, he made sure his products offered long-lasting value and superior quality. Like you, his customers couldn't afford anything less. Miller products had to be more than the best they could be. They had to be the best you could buy.

Today, the people that build and sell Miller products continue the tradition. They're just as committed to providing equipment and service that meets the high standards of quality and value established in 1929.

This Owner's Manual is designed to help you get the most out of your Miller products. Please take time to read the Safety precautions. They will help you protect yourself against potential hazards on the worksite.

We've made installation and operation quick and easy. With Miller you can count on years of reliable service with proper maintenance. And if for some reason the unit needs repair, there's a Troubleshooting section that will help you figure out what the problem is. The parts list will then help you to decide the exact part you may need to fix the problem. Warranty and service information for your particular model are also provided.



Miller is the first welding equipment manufacturer in the U.S.A. to be registered to the ISO 9001:2000 Quality System Standard.

Miller Electric manufactures a full line of welders and welding related equipment. For information on other quality Miller products, contact your local Miller distributor to receive the latest full line catalog or individual specification sheets. **To locate your nearest distributor or service agency call 1-800-4-A-Miller, or visit us at www.MillerWelds.com on the web.**



Working as hard as you do – every power source from Miller is backed by the most hassle-free warranty in the business.



TABLE OF CONTENTS

SECTION 1 – SAFETY PRECAUTIONS - READ BEFORE USING	1
1-1. Symbol Usage	1
1-2. Arc Welding Hazards	1
1-3. Additional Symbols For Installation, Operation, And Maintenance	3
1-4. California Proposition 65 Warnings	4
1-5. Principal Safety Standards	4
1-6. EMF Information	4
SECTION 2 – CONSIGNES DE SÉCURITÉ – LIRE AVANT UTILISATION	5
2-1. Symboles utilisés	5
2-2. Dangers relatifs au soudage à l'arc	5
2-3. Dangers supplémentaires en relation avec l'installation, le fonctionnement et la maintenance	7
2-4. Proposition californienne 65 Avertissements	8
2-5. Principales normes de sécurité	9
2-6. Information EMF	9
SECTION 3 – INSTALLATION	11
3-1. Specifications	11
3-2. Dimensions And Weight	11
3-3. Duty Cycle And Overheating	12
3-4. Volt-Ampere Curves	12
3-5. Selecting A Location	13
3-6. Connection Diagram	13
3-7. Rear Panel Receptacles And Supplementary Protectors	14
3-8. Connecting To Weld Terminals	15
3-9. Selecting Weld Cable Sizes*	16
3-10. Peripheral Receptacle Functions	17
3-11. Motor Control Receptacle Functions	18
3-12. Electrical Service Guide	19
3-13. Connecting Input Power	20
3-14. Touch Sensor Operation	21
3-15. Remote Program Select	21
3-16. Remote Program Setting	21
SECTION 4 – OPERATION	22
4-1. Operational Terms	22
4-2. Front Panel Controls (See Section 4-3)	24
4-3. Front Panel Controls - Continued (See Section 4-2)	25
4-4. Front Panel Switches	26
4-5. Robot Calibration Mode	27
4-6. Robot Auto-Calibration Sample Programs	28
4-7. Reset Mode	30
SECTION 5 – MAINTENANCE	31
5-1. Routine Maintenance	31
5-2. Blowing Out Inside Of Unit	31
SECTION 6 – SAFETY PRECAUTIONS FOR SERVICING	32
6-1. Symbol Usage	32
6-2. Servicing Hazards	32
6-3. California Proposition 65 Warnings	33
6-4. EMF Information	33

TABLE OF CONTENTS

SECTION 7 – TROUBLESHOOTING	34
7-1. Set Value Mode	34
7-2. Diagnostics	35
7-3. Removing Cover and Measuring Input Capacitor Voltage	37
7-4. Process Control Module PC4 Diagnostic LED's	38
7-5. Diagnostic LED's On Process Control Module PC4	38
7-6. Wire Feed Module PC6 Diagnostic LED's And Dip Switch Settings	39
7-7. Diagnostic LED's On Wire Feed Module PC6	39
7-8. User Interface Module PC7 Diagnostic LED's	40
7-9. Diagnostic LED's On User Interface Module PC7	40
7-10. Automation Interface Module PC9 Diagnostic LED's	41
7-11. Diagnostic LED's On Automation Interface Module PC9	42
7-12. Network And Module Status LED's	44
7-13. Troubleshooting	45
SECTION 8 – ELECTRICAL DIAGRAMS	46
SECTION 9 – PARTS LIST	54
WARRANTY	

SECTION 1 – SAFETY PRECAUTIONS - READ BEFORE USING

som_2007-04

 Protect yourself and others from injury — read and follow these precautions.

1-1. Symbol Usage

 **DANGER!** – Indicates a hazardous situation which, if not avoided, will result in death or serious injury. The possible hazards are shown in the adjoining symbols or explained in the text.

 Indicates a hazardous situation which, if not avoided, could result in death or serious injury. The possible hazards are shown in the adjoining symbols or explained in the text.

NOTICE – Indicates statements not related to personal injury.

 Indicates special instructions.



This group of symbols means Warning! Watch Out! ELECTRIC SHOCK, MOVING PARTS, and HOT PARTS hazards. Consult symbols and related instructions below for necessary actions to avoid the hazards.

1-2. Arc Welding Hazards

 The symbols shown below are used throughout this manual to call attention to and identify possible hazards. When you see the symbol, watch out, and follow the related instructions to avoid the hazard. The safety information given below is only a summary of the more complete safety information found in the Safety Standards listed in Section 1-5. Read and follow all Safety Standards.

 Only qualified persons should install, operate, maintain, and repair this unit.

 During operation, keep everybody, especially children, away.



ELECTRIC SHOCK can kill.

Touching live electrical parts can cause fatal shocks or severe burns. The electrode and work circuit is electrically live whenever the output is on. The input power circuit and machine internal circuits are also live when power is on. In semiautomatic or automatic wire welding, the wire, wire reel, drive roll housing, and all metal parts touching the welding wire are electrically live. Incorrectly installed or improperly grounded equipment is a hazard.

- Do not touch live electrical parts.
- Wear dry, hole-free insulating gloves and body protection.
- Insulate yourself from work and ground using dry insulating mats or covers big enough to prevent any physical contact with the work or ground.
- Do not use AC output in damp areas, if movement is confined, or if there is a danger of falling.
- Use AC output ONLY if required for the welding process.
- If AC output is required, use remote output control if present on unit.
- Additional safety precautions are required when any of the following electrically hazardous conditions are present: in damp locations or while wearing wet clothing; on metal structures such as floors, gratings, or scaffolds; when in cramped positions such as sitting, kneeling, or lying; or when there is a high risk of unavoidable or accidental contact with the workpiece or ground. For these conditions, use the following equipment in order presented: 1) a semiautomatic DC constant voltage (wire) welder, 2) a DC manual (stick) welder, or 3) an AC welder with reduced open-circuit voltage. In most situations, use of a DC, constant voltage wire welder is recommended. And, do not work alone!
- Disconnect input power or stop engine before installing or servicing this equipment. Lockout/tagout input power according to OSHA 29 CFR 1910.147 (see Safety Standards).
- Properly install and ground this equipment according to its Owner's Manual and national, state, and local codes.

- Always verify the supply ground – check and be sure that input power cord ground wire is properly connected to ground terminal in disconnect box or that cord plug is connected to a properly grounded receptacle outlet.
- When making input connections, attach proper grounding conductor first – double-check connections.
- Keep cords dry, free of oil and grease, and protected from hot metal and sparks.
- Frequently inspect input power cord for damage or bare wiring – replace cord immediately if damaged – bare wiring can kill.
- Turn off all equipment when not in use.
- Do not use worn, damaged, undersized, or poorly spliced cables.
- Do not drape cables over your body.
- If earth grounding of the workpiece is required, ground it directly with a separate cable.
- Do not touch electrode if you are in contact with the work, ground, or another electrode from a different machine.
- Do not touch electrode holders connected to two welding machines at the same time since double open-circuit voltage will be present.
- Use only well-maintained equipment. Repair or replace damaged parts at once. Maintain unit according to manual.
- Wear a safety harness if working above floor level.
- Keep all panels and covers securely in place.
- Clamp work cable with good metal-to-metal contact to workpiece or worktable as near the weld as practical.
- Insulate work clamp when not connected to workpiece to prevent contact with any metal object.
- Do not connect more than one electrode or work cable to any single weld output terminal.

SIGNIFICANT DC VOLTAGE exists in inverter-type welding power sources after removal of input power.

- Turn Off inverter, disconnect input power, and discharge input capacitors according to instructions in Maintenance Section before touching any parts.



HOT PARTS can cause severe burns.

- Do not touch hot parts bare handed.
- Allow cooling period before working on gun or torch.
- To handle hot parts, use proper tools and/or wear heavy, insulated welding gloves and clothing to prevent burns.



FUMES AND GASES can be hazardous.

Welding produces fumes and gases. Breathing these fumes and gases can be hazardous to your health.

- Keep your head out of the fumes. Do not breathe the fumes.
- If inside, ventilate the area and/or use local forced ventilation at the arc to remove welding fumes and gases.
- If ventilation is poor, wear an approved air-supplied respirator.
- Read and understand the Material Safety Data Sheets (MSDSs) and the manufacturer's instructions for metals, consumables, coatings, cleaners, and degreasers.
- Work in a confined space only if it is well ventilated, or while wearing an air-supplied respirator. Always have a trained watch-person nearby. Welding fumes and gases can displace air and lower the oxygen level causing injury or death. Be sure the breathing air is safe.
- Do not weld in locations near degreasing, cleaning, or spraying operations. The heat and rays of the arc can react with vapors to form highly toxic and irritating gases.
- Do not weld on coated metals, such as galvanized, lead, or cadmium plated steel, unless the coating is removed from the weld area, the area is well ventilated, and while wearing an air-supplied respirator. The coatings and any metals containing these elements can give off toxic fumes if welded.



ARC RAYS can burn eyes and skin.

Arc rays from the welding process produce intense visible and invisible (ultraviolet and infrared) rays that can burn eyes and skin. Sparks fly off from the weld.

- Wear an approved welding helmet fitted with a proper shade of filter lenses to protect your face and eyes when welding or watching (see ANSI Z49.1 and Z87.1 listed in Safety Standards).
- Wear approved safety glasses with side shields under your helmet.
- Use protective screens or barriers to protect others from flash, glare and sparks; warn others not to watch the arc.
- Wear protective clothing made from durable, flame-resistant material (leather, heavy cotton, or wool) and foot protection.



WELDING can cause fire or explosion.

Welding on closed containers, such as tanks, drums, or pipes, can cause them to blow up. Sparks can fly off from the welding arc. The flying sparks, hot workpiece, and hot equipment can cause fires and burns. Accidental contact of electrode to metal objects can cause sparks, explosion, overheating, or fire. Check and be sure the area is safe before doing any welding.

- Remove all flammables within 35 ft (10.7 m) of the welding arc. If this is not possible, tightly cover them with approved covers.
- Do not weld where flying sparks can strike flammable material.
- Protect yourself and others from flying sparks and hot metal.
- Be alert that welding sparks and hot materials from welding can easily go through small cracks and openings to adjacent areas.
- Watch for fire, and keep a fire extinguisher nearby.
- Be aware that welding on a ceiling, floor, bulkhead, or partition can cause fire on the hidden side.
- Do not weld on closed containers such as tanks, drums, or pipes, unless they are properly prepared according to AWS F4.1 (see Safety Standards).
- Do not weld where the atmosphere may contain flammable dust, gas, or liquid vapors (such as gasoline).
- Connect work cable to the work as close to the welding area as practical to prevent welding current from traveling long, possibly unknown paths and causing electric shock, sparks, and fire hazards.

- Do not use welder to thaw frozen pipes.
- Remove stick electrode from holder or cut off welding wire at contact tip when not in use.
- Wear oil-free protective garments such as leather gloves, heavy shirt, cuffless trousers, high shoes, and a cap.
- Remove any combustibles, such as a butane lighter or matches, from your person before doing any welding.
- After completion of work, inspect area to ensure it is free of sparks, glowing embers, and flames.
- Use only correct fuses or circuit breakers. Do not oversize or bypass them.
- Follow requirements in OSHA 1910.252 (a) (2) (iv) and NFPA 51B for hot work and have a fire watcher and extinguisher nearby.



FLYING METAL or DIRT can injure eyes.

- Welding, chipping, wire brushing, and grinding cause sparks and flying metal. As welds cool, they can throw off slag.
- Wear approved safety glasses with side shields even under your welding helmet.



BUILDUP OF GAS can injure or kill.

- Shut off shielding gas supply when not in use.
- Always ventilate confined spaces or use approved air-supplied respirator.

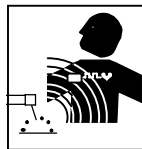

MAGNETIC FIELDS can affect Implanted Medical Devices.

- Wearers of Pacemakers and other Implanted Medical Devices should keep away.
- Implanted Medical Device wearers should consult their doctor and the device manufacturer before going near arc welding, spot welding, gouging, plasma arc cutting, or induction heating operations.



NOISE can damage hearing.

Noise from some processes or equipment can damage hearing.

- Wear approved ear protection if noise level is high.



CYLINDERS can explode if damaged.

Shielding gas cylinders contain gas under high pressure. If damaged, a cylinder can explode. Since gas cylinders are normally part of the welding process, be sure to treat them carefully.

- Protect compressed gas cylinders from excessive heat, mechanical shocks, physical damage, slag, open flames, sparks, and arcs.
- Install cylinders in an upright position by securing to a stationary support or cylinder rack to prevent falling or tipping.
- Keep cylinders away from any welding or other electrical circuits.
- Never drape a welding torch over a gas cylinder.
- Never allow a welding electrode to touch any cylinder.
- Never weld on a pressurized cylinder – explosion will result.
- Use only correct shielding gas cylinders, regulators, hoses, and fittings designed for the specific application; maintain them and associated parts in good condition.
- Turn face away from valve outlet when opening cylinder valve.
- Keep protective cap in place over valve except when cylinder is in use or connected for use.
- Use the right equipment, correct procedures, and sufficient number of persons to lift and move cylinders.
- Read and follow instructions on compressed gas cylinders, associated equipment, and Compressed Gas Association (CGA) publication P-1 listed in Safety Standards.

1-3. Additional Symbols For Installation, Operation, And Maintenance



FIRE OR EXPLOSION hazard.

- Do not install or place unit on, over, or near combustible surfaces.
- Do not install unit near flammables.
- Do not overload building wiring – be sure power supply system is properly sized, rated, and protected to handle this unit.



FALLING UNIT can cause injury.

- Use lifting eye to lift unit only, NOT running gear, gas cylinders, or any other accessories.
- Use equipment of adequate capacity to lift and support unit.
- If using lift forks to move unit, be sure forks are long enough to extend beyond opposite side of unit.



OVERUSE can cause OVERHEATING

- Allow cooling period; follow rated duty cycle.
- Reduce current or reduce duty cycle before starting to weld again.
- Do not block or filter airflow to unit.

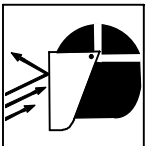

FLYING SPARKS can cause injury.

- Wear a face shield to protect eyes and face.
- Shape tungsten electrode only on grinder with proper guards in a safe location wearing proper face, hand, and body protection.
- Sparks can cause fires — keep flammables away.



STATIC (ESD) can damage PC boards.

- Put on grounded wrist strap BEFORE handling boards or parts.
- Use proper static-proof bags and boxes to store, move, or ship PC boards.



MOVING PARTS can cause injury.

- Keep away from moving parts.
- Keep away from pinch points such as drive rolls.



WELDING WIRE can cause injury.

- Do not press gun trigger until instructed to do so.
- Do not point gun toward any part of the body, other people, or any metal when threading welding wire.



MOVING PARTS can cause injury.

- Keep away from moving parts such as fans.
- Keep all doors, panels, covers, and guards closed and securely in place.
- Have only qualified persons remove doors, panels, covers, or guards for maintenance as necessary.
- Reinstall doors, panels, covers, or guards when maintenance is finished and before reconnecting input power.

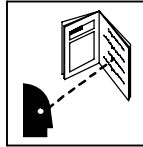

READ INSTRUCTIONS.

- Read Owner's Manual before using or servicing unit.
- Use only genuine replacement parts from the manufacturer.

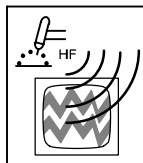

H.F. RADIATION can cause interference.

- High-frequency (H.F.) can interfere with radio navigation, safety services, computers, and communications equipment.
- Have only qualified persons familiar with electronic equipment perform this installation.
- The user is responsible for having a qualified electrician promptly correct any interference problem resulting from the installation.
- If notified by the FCC about interference, stop using the equipment at once.
- Have the installation regularly checked and maintained.
- Keep high-frequency source doors and panels tightly shut, keep spark gaps at correct setting, and use grounding and shielding to minimize the possibility of interference.

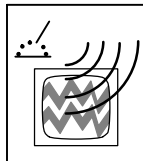

ARC WELDING can cause interference.

- Electromagnetic energy can interfere with sensitive electronic equipment such as computers and computer-driven equipment such as robots.
- Be sure all equipment in the welding area is electromagnetically compatible.
- To reduce possible interference, keep weld cables as short as possible, close together, and down low, such as on the floor.
- Locate welding operation 100 meters from any sensitive electronic equipment.
- Be sure this welding machine is installed and grounded according to this manual.
- If interference still occurs, the user must take extra measures such as moving the welding machine, using shielded cables, using line filters, or shielding the work area.

1-4. California Proposition 65 Warnings

 Welding or cutting equipment produces fumes or gases which contain chemicals known to the State of California to cause birth defects and, in some cases, cancer. (California Health & Safety Code Section 25249.5 et seq.)

 Battery posts, terminals and related accessories contain lead and lead compounds, chemicals known to the State of California to cause cancer and birth defects or other reproductive harm. Wash hands after handling.

For Gasoline Engines:

 Engine exhaust contains chemicals known to the State of California to cause cancer, birth defects, or other reproductive harm.

For Diesel Engines:

 Diesel engine exhaust and some of its constituents are known to the State of California to cause cancer, birth defects, and other reproductive harm.

1-5. Principal Safety Standards

Safety in Welding, Cutting, and Allied Processes, ANSI Standard Z49.1, from Global Engineering Documents (phone: 1-877-413-5184, website: www.global.ihs.com).

Recommended Safe Practices for the Preparation for Welding and Cutting of Containers and Piping, American Welding Society Standard AWS F4.1, from Global Engineering Documents (phone: 1-877-413-5184, website: www.global.ihs.com).

National Electrical Code, NFPA Standard 70, from National Fire Protection Association, P.O. Box 9101, Quincy, MA 02269-9101 (phone: 617-770-3000, website: www.nfpa.org and www.sparky.org).

Safe Handling of Compressed Gases in Cylinders, CGA Pamphlet P-1, from Compressed Gas Association, 4221 Walney Road, 5th Floor, Chantilly, VA 20151 (phone: 703-788-2700, website: www.cganet.com).

Code for Safety in Welding and Cutting, CSA Standard W117.2, from Canadian Standards Association, Standards Sales, 5060 Mississauga,

Ontario, Canada L4W 5NS (phone: 800-463-6727 or in Toronto 416-747-4044, website: www.csa-international.org).

Safe Practice For Occupational And Educational Eye And Face Protection, ANSI Standard Z87.1, from American National Standards Institute, 25 West 43rd Street, New York, NY 10036-8002 (phone: 212-642-4900, website: www.ansi.org).

Standard for Fire Prevention During Welding, Cutting, and Other Hot Work, NFPA Standard 51B, from National Fire Protection Association, P.O. Box 9101, Quincy, MA 02269-9101 (phone: 617-770-3000, website: www.nfpa.org).

OSHA, Occupational Safety and Health Standards for General Industry, Title 29, Code of Federal Regulations (CFR), Part 1910, Subpart Q, and Part 1926, Subpart J, from U.S. Government Printing Office, Superintendent of Documents, P.O. Box 371954, Pittsburgh, PA 15250-7954 (phone: 1-866-512-1800) (there are 10 Regional Offices—phone for Region 5, Chicago, is 312-353-2220, website: www.osha.gov).

1-6. EMF Information

Considerations About Welding And The Effects Of Low Frequency Electric And Magnetic Fields

Welding current, as it flows through welding cables, will cause electromagnetic fields. There has been and still is some concern about such fields. However, after examining more than 500 studies spanning 17 years of research, a special blue ribbon committee of the National Research Council concluded that: "The body of evidence, in the committee's judgment, has not demonstrated that exposure to power-frequency electric and magnetic fields is a human-health hazard." However, studies are still going forth and evidence continues to be examined. Until the final conclusions of the research are reached, you may wish to minimize your exposure to electromagnetic fields when welding or cutting.

To reduce magnetic fields in the workplace, use the following procedures:

1. Keep cables close together by twisting or taping them, or using a cable cover.
2. Arrange cables to one side and away from the operator.
3. Do not coil or drape cables around your body.
4. Keep welding power source and cables as far away from operator as practical.
5. Connect work clamp to workpiece as close to the weld as possible.

About Implanted Medical Devices:

Implanted Medical Device wearers should consult their doctor and the device manufacturer before performing or going near arc welding, spot welding, gouging, plasma arc cutting, or induction heating operations. If cleared by your doctor, then following the above procedures is recommended.

SECTION 2 – CONSIGNES DE SÉCURITÉ – LIRE AVANT UTILISATION

fre_som_2007-04

! Se protéger et protéger les autres contre le risque de blessure — lire et respecter ces consignes.

2-1. Symboles utilisés



DANGER! – Indique une situation dangereuse qui si on l'évite pas peut donner la mort ou des blessures graves. Les dangers possibles sont montrés par les symboles joints ou sont expliqués dans le texte.



Indique une situation dangereuse qui si on l'évite pas peut donner la mort ou des blessures graves. Les dangers possibles sont montrés par les symboles joints ou sont expliqués dans le texte.

NOTE – Indique des déclarations pas en relation avec des blessures personnelles.

 Indique des instructions spécifiques.



Ce groupe de symboles veut dire Avertissement! Attention! DANGER DE CHOC ELECTRIQUE, PIECES EN MOUVEMENT, et PIECES CHAUDES. Consulter les symboles et les instructions ci-dessous y afférant pour les actions nécessaires afin d'éviter le danger.

2-2. Dangers relatifs au soudage à l'arc



Les symboles représentés ci-dessous sont utilisés dans ce manuel pour attirer l'attention et identifier les dangers possibles. En présence de l'un de ces symboles, prendre garde et suivre les instructions afférentes pour éviter tout risque. Les instructions en matière de sécurité indiquées ci-dessous ne constituent qu'un sommaire des instructions de sécurité plus complètes fournies dans les normes de sécurité énumérées dans la Section 2-5. Lire et observer toutes les normes de sécurité.



Seul un personnel qualifié est autorisé à installer, faire fonctionner, entretenir et réparer cet appareil.



Pendant le fonctionnement, maintenir à distance toutes les personnes, notamment les enfants de l'appareil.



UNE DÉCHARGE ÉLECTRIQUE peut entraîner la mort.

Le contact d'organes électriques sous tension peut provoquer des accidents mortels ou des brûlures graves. Le circuit de l'électrode et de la pièce est sous tension lorsque le courant est délivré à la sortie. Le circuit d'alimentation et les circuits internes de la machine sont également sous tension lorsque l'alimentation est sur Marche. Dans le mode de soudage avec du fil, le fil, le dérouleur, le bloc de commande du rouleau et toutes les parties métalliques en contact avec le fil sont sous tension électrique. Un équipement installé ou mis à la terre de manière incorrecte ou impropre constitue un danger.

- Ne pas toucher aux pièces électriques sous tension.
- Porter des gants isolants et des vêtements de protection secs et sans trous.
- S'isoler de la pièce à couper et du sol en utilisant des housses ou des tapis assez grands afin d'éviter tout contact physique avec la pièce à couper ou le sol.
- Ne pas se servir de source électrique à courant électrique dans les zones humides, dans les endroits confinés ou là où on risque de tomber.
- Se servir d'une source électrique à courant électrique UNIQUEMENT si le procédé de soudage le demande.
- Si l'utilisation d'une source électrique à courant électrique s'avère nécessaire, se servir de la fonction de télécommande si l'appareil en est équipé.
- D'autres consignes de sécurité sont nécessaires dans les conditions suivantes : risques électriques dans un environnement humide ou si l'on porte des vêtements mouillés ; sur des structures métalliques telles que sols, grilles ou échafaudages ; en position coincée comme assise, à genoux ou couchée ; ou s'il y a un risque élevé de contact inévitable ou accidentel avec la pièce à souder ou le sol. Dans ces conditions, utiliser les équipements suivants, dans l'ordre indiqué : 1) un poste à souder DC à tension constante (à fil), 2) un poste à souder DC manuel (électrode) ou 3) un poste à souder AC à tension à vide réduite. Dans la plupart des situations, l'utilisation d'un poste à souder DC à fil à tension constante est recommandée. En outre, ne pas travailler seul !
- Couper l'alimentation ou arrêter le moteur avant de procéder à l'installation, à la réparation ou à l'entretien de l'appareil. Déverrouiller l'alimentation selon la norme OSHA 29 CFR 1910.147 (voir normes de sécurité).
- Installer le poste correctement et le mettre à la terre convenablement selon les consignes du manuel de l'opérateur et les normes nationales, provinciales et locales.
- Toujours vérifier la terre du cordon d'alimentation. Vérifier et s'assurer que le fil de terre du cordon d'alimentation est bien raccordé à la borne de terre du sectionneur ou que la fiche du cordon est raccordée à une prise correctement mise à la terre.
- En effectuant les raccordements d'entrée, fixer d'abord le conducteur de mise à la terre approprié et contre-vérifier les connexions.
- Les câbles doivent être exempts d'humidité, d'huile et de graisse; protégez-les contre les étincelles et les pièces métalliques chaudes.
- Vérifier fréquemment le cordon d'alimentation afin de s'assurer qu'il n'est pas altéré ou à nu, le remplacer immédiatement s'il l'est. Un fil à nu peut entraîner la mort.
- L'équipement doit être hors tension lorsqu'il n'est pas utilisé.
- Ne pas utiliser des câbles usés, endommagés, de grosseur insuffisante ou mal épissés.
- Ne pas enrouler les câbles autour du corps.
- Si la pièce soudée doit être mise à la terre, le faire directement avec un câble distinct.
- Ne pas toucher l'électrode quand on est en contact avec la pièce, la terre ou une électrode provenant d'une autre machine.
- Ne pas toucher des porte électrodes connectés à deux machines en même temps à cause de la présence d'une tension à vide doublée.
- N'utiliser qu'un matériel en bon état. Réparer ou remplacer sur-le-champ les pièces endommagées. Entretenir l'appareil conformément à ce manuel.
- Porter un harnais de sécurité si l'on doit travailler au-dessus du sol.
- S'assurer que tous les panneaux et couvercles sont correctement en place.
- Fixer le câble de retour de façon à obtenir un bon contact métal-métal avec la pièce à souder ou la table de travail, le plus près possible de la soudure.
- Isoler la pince de masse quand pas mis à la pièce pour éviter le contact avec tout objet métallique.
- Ne pas raccorder plus d'une électrode ou plus d'un câble de masse à une même borne de sortie de soudage.

Il reste une TENSION DC NON NÉGLIGEABLE dans les sources de soudage onduleur quand on a coupé l'alimentation.

- Arrêter les convertisseurs, débrancher le courant électrique et décharger les condensateurs d'alimentation selon les instructions indiquées dans la partie Entretien avant de toucher les pièces.



DES PIÈCES CHAUDES peuvent provoquer des brûlures graves.

- Ne pas toucher à mains nues les parties chaudes.
- Prévoir une période de refroidissement avant de travailler à l'équipement.
- Ne pas toucher aux pièces chaudes, utiliser les outils recommandés et porter des gants de soudage et des vêtements épais pour éviter les brûlures.



LES FUMÉES ET LES GAZ peuvent être dangereux.

Le soudage génère des fumées et des gaz. Leur inhalation peut être dangereux pour votre santé.

- Eloigner votre tête des fumées. Ne pas respirer les fumées.
- À l'intérieur, ventiler la zone et/ou utiliser une ventilation forcée au niveau de l'arc pour l'évacuation des fumées et des gaz de soudage.
- Si la ventilation est médiocre, porter un respirateur anti-vapeurs approuvé.
- Lire et comprendre les spécifications de sécurité des matériaux (MSDS) et les instructions du fabricant concernant les métaux, les consommables, les revêtements, les nettoyants et les dégraissants.
- Travailler dans un espace fermé seulement s'il est bien ventilé ou en portant un respirateur à alimentation d'air. Demander toujours à un surveillant dûment formé de se tenir à proximité. Des fumées et des gaz de soudage peuvent déplacer l'air et abaisser le niveau d'oxygène provoquant des blessures ou des accidents mortels. S'assurer que l'air de respiration ne présente aucun danger.
- Ne pas souder dans des endroits situés à proximité d'opérations de dégraissage, de nettoyage ou de pulvérisation. La chaleur et les rayons de l'arc peuvent réagir en présence de vapeurs et former des gaz hautement toxiques et irritants.
- Ne pas souder des métaux munis d'un revêtement, tels que l'acier galvanisé, plaqué en plomb ou au cadmium à moins que le revêtement n'ait été enlevé dans la zone de soudure, que l'endroit soit bien ventilé, et en portant un respirateur à alimentation d'air. Les revêtements et tous les métaux renfermant ces éléments peuvent dégager des fumées toxiques en cas de soudage.

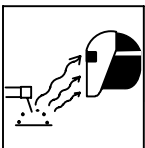

LES RAYONS DE L'ARC peuvent provoquer des brûlures dans les yeux et sur la peau.

Le rayonnement de l'arc du procédé de soudage génère des rayons visibles et invisibles intense (ultraviolets et infrarouges) susceptibles de provoquer des brûlures dans les yeux et sur la peau. Des étincelles sont projetées pendant le soudage.

- Porter un casque de soudage approuvé muni de verres filtrants approprié pour protéger visage et yeux pendant le soudage (voir ANSI Z49.1 et Z87.1 énuméré dans les normes de sécurité).
- Porter des lunettes de sécurité avec écrans latéraux même sous votre casque.
- Avoir recours à des écrans protecteurs ou à des rideaux pour protéger les autres contre les rayonnements les éblouissements et les étincelles ; prévenir toute personne sur les lieux de ne pas regarder l'arc.
- Porter des vêtements confectionnés avec des matières résistantes et ignifuges (cuir, coton lourd ou laine) et des bottes de protection.

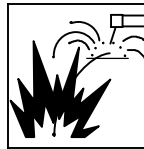

LE SOUDAGE peut provoquer un incendie ou une explosion.

Le soudage effectué sur des conteneurs fermés tel que des réservoirs, tambours ou des conduites peut provoquer leur éclatement. Des étincelles peuvent être projetées de l'arc de soudure. La projection d'étincelles, des pièces chaudes et des équipements chauds peut provoquer des incendies et des brûlures. Le contact accidentel de l'électrode avec des objets métalliques peut provoquer des étincelles, une explosion, un surchauffement ou un incendie. Avant de commencer le soudage, vérifier et s'assurer que l'endroit ne présente pas de danger.

- Déplacer toutes les substances inflammables à une distance de 10,7 m de l'arc de soudage. En cas d'impossibilité les recouvrir soigneusement avec des protections homologués.
- Ne pas souder dans un endroit où des étincelles peuvent tomber sur des substances inflammables.
- Se protéger et d'autres personnes de la projection d'étincelles et de métal chaud.
- Des étincelles et des matériaux chauds du soudage peuvent facilement passer dans d'autres zones en traversant de petites fissures et des ouvertures.
- Surveiller tout déclenchement d'incendie et tenir un extincteur à proximité.
- Le soudage effectué sur un plafond, plancher, paroi ou séparation peut déclencher un incendie de l'autre côté.
- Ne pas effectuer le soudage sur des conteneurs fermés tels que des réservoirs, tambours, ou conduites, à moins qu'ils n'aient été préparés correctement conformément à AWS F4.1 (voir les normes de sécurité).
- Ne soudez pas si l'air ambiant est chargé de particules, gaz, ou vapeurs inflammables (vapeur d'essence, par exemple).
- Brancher le câble de masse sur la pièce la plus près possible de la zone de soudage pour éviter le transport du courant sur une longue distance par des chemins inconnus éventuels en provoquant des risques d'électrocution, d'étincelles et d'incendie.
- Ne pas utiliser le poste de soudage pour dégeler des conduites gelées.
- En cas de non utilisation, enlever la baguette d'électrode du porte-électrode ou couper le fil à la pointe de contact.
- Porter des vêtements de protection dépourvus d'huile tels que des gants en cuir, une chemise en matériau lourd, des pantalons sans revers, des chaussures hautes et un couvre chef.
- Avant de souder, retirer toute substance combustible de vos poches telles qu'un allumeur au butane ou des allumettes.
- Une fois le travail achevé, assurez-vous qu'il ne reste aucune trace d'étincelles incandescentes ni de flammes.
- Utiliser exclusivement des fusibles ou coupe-circuits appropriés. Ne pas augmenter leur puissance; ne pas les ponter.
- Une fois le travail achevé, assurez-vous qu'il ne reste aucune trace d'étincelles incandescentes ni de flammes.
- Utiliser exclusivement des fusibles ou coupe-circuits appropriés. Ne pas augmenter leur puissance; ne pas les ponter.
- Suivre les recommandations dans OSHA 1910.252(a)(2)(iv) et NFPA 51B pour les travaux à chaud et avoir de la surveillance et un extincteur à proximité.

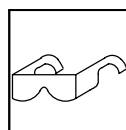

DES PIÈCES DE METAL ou DES SALETES peuvent provoquer des blessures dans les yeux.

- Le soudage, l'écaillage, le passage de la pièce à la brosse en fil de fer, et le meulage génèrent des étincelles et des particules métalliques volantes. Pendant la période de refroidissement des soudures, elles risquent de projeter du laitier.
- Porter des lunettes de sécurité avec écrans latéraux ou un écran facial.



LES ACCUMULATIONS DE GAZ risquent de provoquer des blessures ou même la mort.

- Fermer l'alimentation du gaz protecteur en cas de non-utilisation.
- Veiller toujours à bien aérer les espaces confinés ou se servir d'un respirateur d'adduction d'air homologué.



LES CHAMPS MAGNETIQUES peuvent affecter des implants médicaux.

- Porteur de simulateur cardiaque ou autre implants médicaux, rester à distance.
- Les porteurs d'implants doivent d'abord consulter leur médecin avant de s'approcher des opérations de soudage à l'arc, de soudage par points, de gougeage, du coupage plasma ou de chauffage par induction.



LE BRUIT peut endommager l'ouïe.

Le bruit des processus et des équipements peut affecter l'ouïe.

- Porter des protections approuvées pour les oreilles si le niveau sonore est trop élevé.

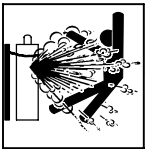

LES BOUTEILLES peuvent exploser si elles sont endommagées.

Des bouteilles de gaz protecteur contiennent du gaz sous haute pression. Si une bouteille est endommagée, elle peut exploser. Du fait que les bouteilles de gaz font normalement partie du procédé de soudage, les manipuler avec précaution.

- Protéger les bouteilles de gaz comprimé d'une chaleur excessive, des chocs mécaniques, des dommages physiques, du laitier, des flammes ouvertes, des étincelles et des arcs.
- Placer les bouteilles debout en les fixant dans un support stationnaire ou dans un porte-bouteilles pour les empêcher de tomber ou de se renverser.
- Tenir les bouteilles éloignées des circuits de soudage ou autres circuits électriques.
- Ne jamais placer une torche de soudage sur une bouteille à gaz.
- Une électrode de soudage ne doit jamais entrer en contact avec une bouteille.
- Ne jamais souder une bouteille pressurisée – risque d'explosion.
- Utiliser seulement des bouteilles de gaz protecteur, régulateurs, tuyaux et raccords convenables pour cette application spécifique ; les maintenir ainsi que les éléments associés en bon état.
- Détourner votre visage du détendeur-régulateur lorsque vous ouvrez la soupape de la bouteille.
- Le couvercle du détendeur doit toujours être en place, sauf lorsque la bouteille est utilisée ou qu'elle est reliée pour usage ultérieur.
- Utiliser les équipements corrects, les bonnes procédures et suffisamment de personnes pour soulever et déplacer les bouteilles.
- Lire et suivre les instructions sur les bouteilles de gaz comprimé, l'équipement connexe et le dépliant P-1 de la CGA (Compressed Gas Association) mentionné dans les principales normes de sécurité.

2-3. Dangers supplémentaires en relation avec l'installation, le fonctionnement et la maintenance



Risque D'INCENDIE OU D'EXPLOSION.

- Ne pas placer l'appareil sur, au-dessus ou à proximité de surfaces inflammables.
- Ne pas installer l'appareil à proximité de produits inflammables.
- Ne pas surcharger l'installation électrique – s'assurer que l'alimentation est correctement dimensionnée et protégée avant de mettre l'appareil en service.

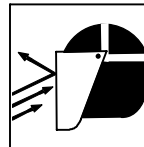

LES ÉTINCELLES VOLANTES risquent de provoquer des blessures.

- Porter un écran facial pour protéger le visage et les yeux.
- Affûter l'électrode au tungstène uniquement à la meuleuse dotée de protecteurs. Cette manœuvre est à exécuter dans un endroit sûr lorsque l'on porte l'équipement homologué de protection du visage, des mains et du corps.
- Les étincelles risquent de causer un incendie – éloigner toute substance inflammable.



LA CHUTE DE L'APPAREIL peut blesser.

- Utiliser l'anneau de levage uniquement pour soulever l'appareil, NON PAS les chariots, les bouteilles de gaz ou tout autre accessoire.
- Utiliser un équipement de levage de capacité suffisante pour lever l'appareil.
- En utilisant des fourches de levage pour déplacer l'unité, s'assurer que les fourches sont suffisamment longues pour dépasser du côté opposé de l'appareil.

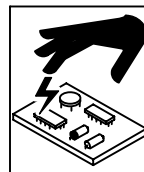

LES CHARGES ÉLECTROSTATIQUES peuvent endommager les circuits imprimés.

- Établir la connexion avec la barrette de terre avant de manipuler des cartes ou des pièces.
- Utiliser des pochettes et des boîtes antistatiques pour stocker, déplacer ou expédier des cartes de circuits imprimés.

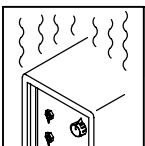

L'EMPLOI EXCESSIF peut SURCHAUFFER L'ÉQUIPEMENT.

- Prévoir une période de refroidissement ; respecter le cycle opératoire nominal.
- Réduire le courant ou le facteur de marche avant de poursuivre le soudage.
- Ne pas obstruer les passages d'air du poste.

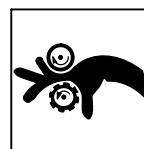

DES ORGANES MOBILES peuvent provoquer des blessures.

- Ne pas s'approcher des organes mobiles.
- Ne pas s'approcher des points de coincement tels que des rouleaux de commande.



LES FILS DE SOUDAGE peuvent provoquer des blessures.

- Ne pas appuyer sur la gâchette avant d'en avoir reçu l'instruction.
- Ne pas diriger le pistolet vers soi, d'autres personnes ou toute pièce mécanique en engageant le fil de soudage.



DES ORGANES MOBILES peuvent provoquer des blessures.

- S'abstenir de toucher des organes mobiles tels que des ventilateurs.
- Maintenir fermés et verrouillés les portes, panneaux, recouvrements et dispositifs de protection.
- Seules des personnes qualifiées sont autorisées à enlever les portes, panneaux, recouvrements ou dispositifs de protection pour l'entretien.
- Remettre les portes, panneaux, recouvrements ou dispositifs de protection quand l'entretien est terminé et avant de rebrancher l'alimentation électrique.

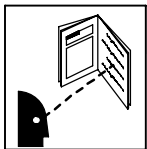

LIRE LES INSTRUCTIONS.

- Lisez le manuel d'instructions avant l'utilisation ou la maintenance de l'appareil.
- N'utiliser que les pièces de rechange recommandées par le constructeur.
- Effectuer régulièrement le contrôle et l'entretien de l'installation.
- Maintenir soigneusement fermés les portes et les panneaux des sources de haute fréquence, maintenir les éclateurs à une distance correcte et utiliser une terre et un blindage pour réduire les interférences éventuelles.

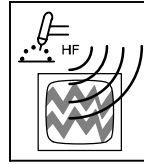

LE RAYONNEMENT HAUTE FRÉQUENCE (H.F.) risque de provoquer des interférences.

- Le rayonnement haute fréquence (H.F.) peut provoquer des interférences avec les équipements de radio-navigation et de communication, les services de sécurité et les ordinateurs.

- Demander seulement à des personnes qualifiées familiarisées avec des équipements électroniques de faire fonctionner l'installation.
- L'utilisateur est tenu de faire corriger rapidement par un électricien qualifié les interférences résultant de l'installation.
- Si le FCC signale des interférences, arrêter immédiatement l'appareil.

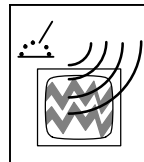

LE SOUDAGE À L'ARC risque de provoquer des interférences.

- L'énergie électromagnétique risque de provoquer des interférences pour l'équipement électronique sensible tel que les ordinateurs et l'équipement commandé par ordinateur tel que les robots.

- Veiller à ce que tout l'équipement de la zone de soudage soit compatible électromagnétiquement.
- Pour réduire la possibilité d'interférence, maintenir les câbles de soudage aussi courts que possible, les grouper, et les poser aussi bas que possible (ex. par terre).
- Veiller à souder à une distance de 100 mètres de tout équipement électronique sensible.
- Veiller à ce que ce poste de soudage soit posé et mis à la terre conformément à ce mode d'emploi.
- En cas d'interférences après avoir pris les mesures précédentes, il incombe à l'utilisateur de prendre des mesures supplémentaires telles que le déplacement du poste, l'utilisation de câbles blindés, l'utilisation de filtres de ligne ou la pose de protecteurs dans la zone de travail.

2-4. Proposition californienne 65 Avertissements

⚠ Les équipements de soudage et de coupage produisent des fumées et des gaz qui contiennent des produits chimiques dont l'État de Californie reconnaît qu'ils provoquent des malformations congénitales et, dans certains cas, des cancers. (Code de santé et de sécurité de Californie, chapitre 25249.5 et suivants)

⚠ Les batteries, les bornes et autres accessoires contiennent du plomb et des composés à base de plomb, produits chimiques dont l'État de Californie reconnaît qu'ils provoquent des cancers et des malformations congénitales ou autres problèmes de procréation. Se laver les mains après manipulation.

Pour les moteurs à essence :

⚠ Les gaz d'échappement des moteurs contiennent des produits chimiques dont l'État de Californie reconnaît qu'ils provoquent des cancers et des malformations congénitales ou autres problèmes de procréation.

Pour les moteurs diesel :

⚠ Les gaz d'échappement des moteurs diesel et certains de leurs composants sont reconnus par l'État de Californie comme provoquant des cancers et des malformations congénitales ou autres problèmes de procréation.

2-5. Principales normes de sécurité

Safety in Welding, Cutting, and Allied Processes, ANSI Standard Z49.1, de Global Engineering Documents (téléphone : 1-877-413-5184, site Internet : www.global.ihc.com).

Recommended Safe Practices for the Preparation for Welding and Cutting of Containers and Piping, American Welding Society Standard AWS F4.1 de Global Engineering Documents (téléphone : 1-877-413-5184, site Internet : www.global.ihc.com).

National Electrical Code, NFPA Standard 70, de National Fire Protection Association, P.O. Box 9101, Quincy, MA 02269-9101 (téléphone : 617-770-3000, site Internet : www.nfpa.org).

Safe Handling of Compressed Gases in Cylinders, CGA Pamphlet P-1, de Compressed Gas Association, 4221 Walney Road, 5th Floor, Chantilly, VA 20151 (téléphone : 703-788-2700, site Internet : www.cganet.com).

Code for Safety in Welding and Cutting, CSA Standard W117.2, de Canadian Standards Association, 5060 Mississauga, Ontario, Canada

L4W 5NS (téléphone : 800-463-6727 ou à Toronto 416-747-4044, site Internet : www.csa-international.org).

Safe Practice For Occupational And Educational Eye And Face Protection, ANSI Standard Z87.1, de American National Standards Institute, 11 West 43rd Street, New York, NY 10036-8002 (téléphone : 212-642-4900, site Internet : www.ansi.org).

Standard for Fire Prevention During Welding, Cutting, and Other Hot Work, NFPA Standard 51B, de National Fire Protection Association, P.O. Box 9101, Quincy, MA 02269-9101 (téléphone : 617-770-3000, site Internet : www.nfpa.org).

OSHA, Occupational Safety and Health Standards for General Industry, Title 29, Code of Federal Regulations (CFR), Part 1910, Subpart Q, and Part 1926, Subpart J, de U.S. Government Printing Office, Superintendent of Documents, P.O. Box 371954, Pittsburgh, PA 15250-7954 (téléphone : 1-866-512-1800) (il y a 10 bureaux régionaux—le téléphone de la région 5, Chicago, est 312-353-2220, site Internet : www.osha.gov).

2-6. Information EMF

Considérations sur le soudage et les effets de basse fréquence et des champs magnétiques et électriques.

Le courant de soudage, pendant son passage dans les câbles de soudage, causera des champs électromagnétiques. Il y a eu et il y a encore un certain souci à propos de tels champs. Cependant, après avoir examiné plus de 500 études qui ont été faites pendant une période de recherche de 17 ans, un comité spécial ruban bleu du National Research Council a conclu : « L'accumulation de preuves, suivant le jugement du comité, n'a pas démontré que l'exposition aux champs magnétiques et champs électriques à haute fréquence représente un risque à la santé humaine ». Toutefois, des études sont toujours en cours et les preuves continuent à être examinées. En attendant que les conclusions finales de la recherche soient établies, il vous serait souhaitable de réduire votre exposition aux champs électromagnétiques pendant le soudage ou le coupage.

Pour réduire les champs magnétiques sur le poste de travail, appliquer les procédures suivantes :

1. Garder les câbles ensemble, les torsader, les scotcher, ou les recouvrir d'une housse.
2. Disposer les câbles d'un côté et à distance de l'opérateur.
3. Ne pas courber pas et ne pas entourer pas les câbles autour de votre corps.
4. Garder le poste de soudage et les câbles le plus loin possible de vous.
5. Connecter la pince sur la pièce aussi près que possible de la soudure.

En ce qui concerne les implants médicaux :

Les porteurs d'implants doivent d'abord consulter leur médecin avant de s'approcher des opérations de soudage à l'arc, de soudage par points, de gougeage, du coupage plasma ou de chauffage par induction. Si le médecin approuve, il est recommandé de suivre les procédures précédentes.

SECTION 3 – INSTALLATION

☞ Appearance of actual unit may vary from unit shown in manual.

3-1. Specifications

Input Power	Rated Welding Output	Voltage Range	Wire Feed Speed Range**	Wire Diameter Range	Max Open Circuit Voltage DC	Amperes Input At Rated Load Output 60 Hz, Three-Phase				Input KVA	Input KW
						230 V	400V	460 V	575 V		
Three Phase	675 A @ 44 V DC, 100% Duty Cycle	10-44	Standard: 50-1400 ipm (1.3-35.6 mpm)	.035-.062 in (0.8-1.6 mm)	85	89.7 (0-1A*)	52.0 (0-1A*)	43.7 (0-1A*)	21.2 (0-1A*)	35.7 (0.8*)	34.4 (0.17*)

*While idling; Input amperage fluctuates while idling and is always less than one Ampere. Use one Ampere for power efficiency calculations.

**Wire feed speed ranges are for GMAW welding. While pulse welding, wire feed speed ranges may be more limited.

3-2. Dimensions And Weight

Hole Layout Dimensions			
A	17-3/32 in (434 mm)		
B	17-3/8 in (441 mm)		
C	19-3/32 in (485 mm)		
D	16-3/32 in (409 mm)		
E	1/2 in (13 mm)		
Weight			
215 lb (98 kg) Net 232 lb (105 kg) Ship			

Ref. 802 913-B

3-3. Duty Cycle And Overheating

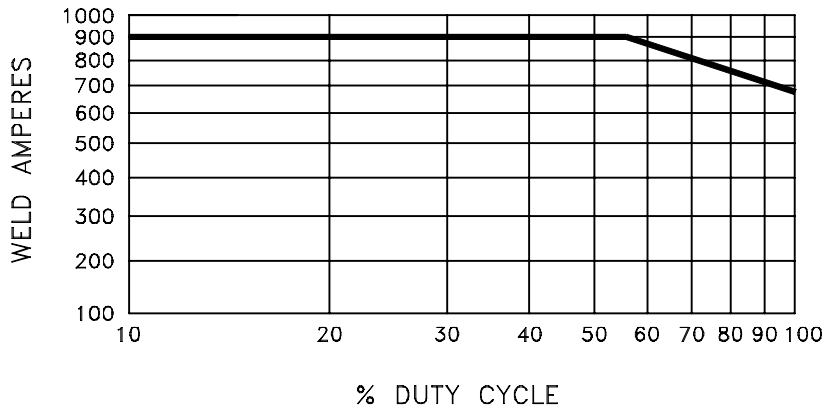

Duty Cycle is percentage of 10 minutes that unit can weld at rated load without overheating.

If unit overheats, thermostat(s) opens, output stops, and cooling fan runs. Wait fifteen minutes for unit to cool. Reduce amperage or duty cycle before welding.

NOTICE – Exceeding duty cycle can damage unit and void warranty.

100% Duty Cycle At 675 Amperes

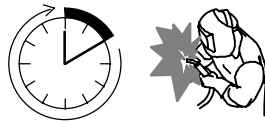

Continuous Welding

Overheating

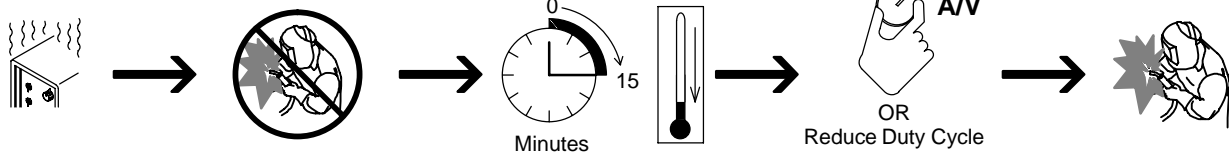

duty1 4/95 – 206 789-A

3-4. Volt-Ampere Curves

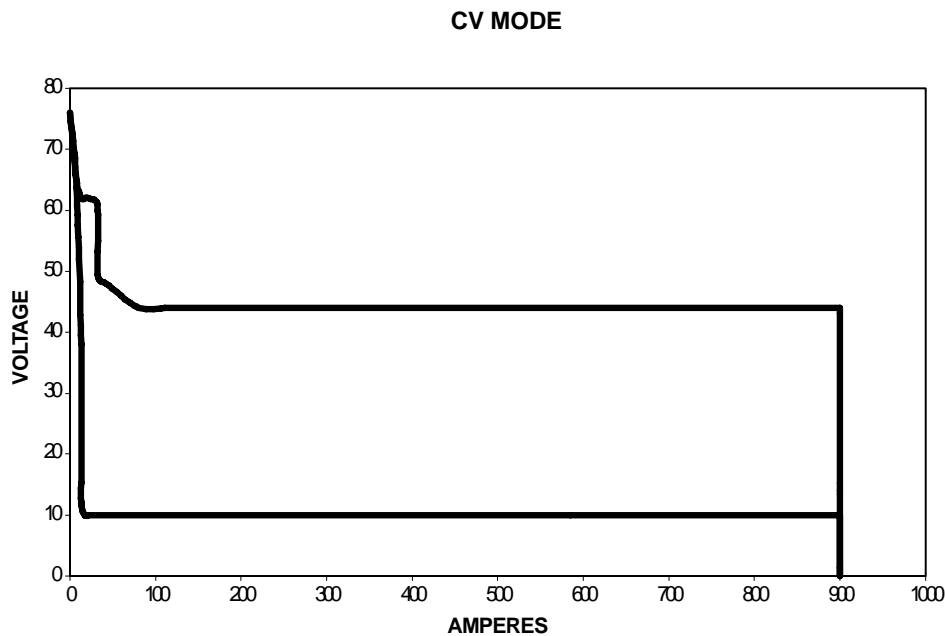

Volt-ampere curves show minimum and maximum voltage and amperage output capabilities of unit. Curves of other settings fall between curves shown.

This volt-ampere curve represents the dynamic output of the unit with a static load.

va_curve1 4/95 – 221 502-A

3-5. Selecting A Location

Movement

OR

Tipping

Do not move or operate unit where it could tip.

Location

Special installation may be required where gasoline or volatile liquids are present – see NEC Article 511 or CEC Section 20.

Do not stack units. Beware of tipping.

- 1 Lifting Forks
Use lifting forks to move unit. Extend forks beyond opposite side of unit.
- 2 Hand Cart
Use cart or similar device to move unit.
- 3 Rating Label
Use rating label to determine input power needs.
- 4 Line Disconnect Device
Locate unit near correct input power supply.

loc_2 3/96 -Ref. 802 913-B

3-6. Connection Diagram

The proper interface kit must be installed in the welding power source/interface unit to allow it to be connected to the robot.

- 1 Robot (Will Vary According To Application)
- 2 Motor/Drive Assembly
- 3 Gas Cylinder
- 4 Gas Hose
- 5 Robot Control
- 6 Robot Input/Output Cable
- 7 Gas And Motor Control Cable
- 8 Welding Power Source/Interface Unit
- 9 Negative (-) Weld Cable
- 10 Workpiece
- 11 Voltage Sensing Lead (Optional)

Positive (+) voltage sensing lead is contained in the motor cable.

- 12 Positive (+) Weld Cable

Ref. 802 913-B / Ref. 801 915-A

3-7. Rear Panel Receptacles And Supplementary Protectors

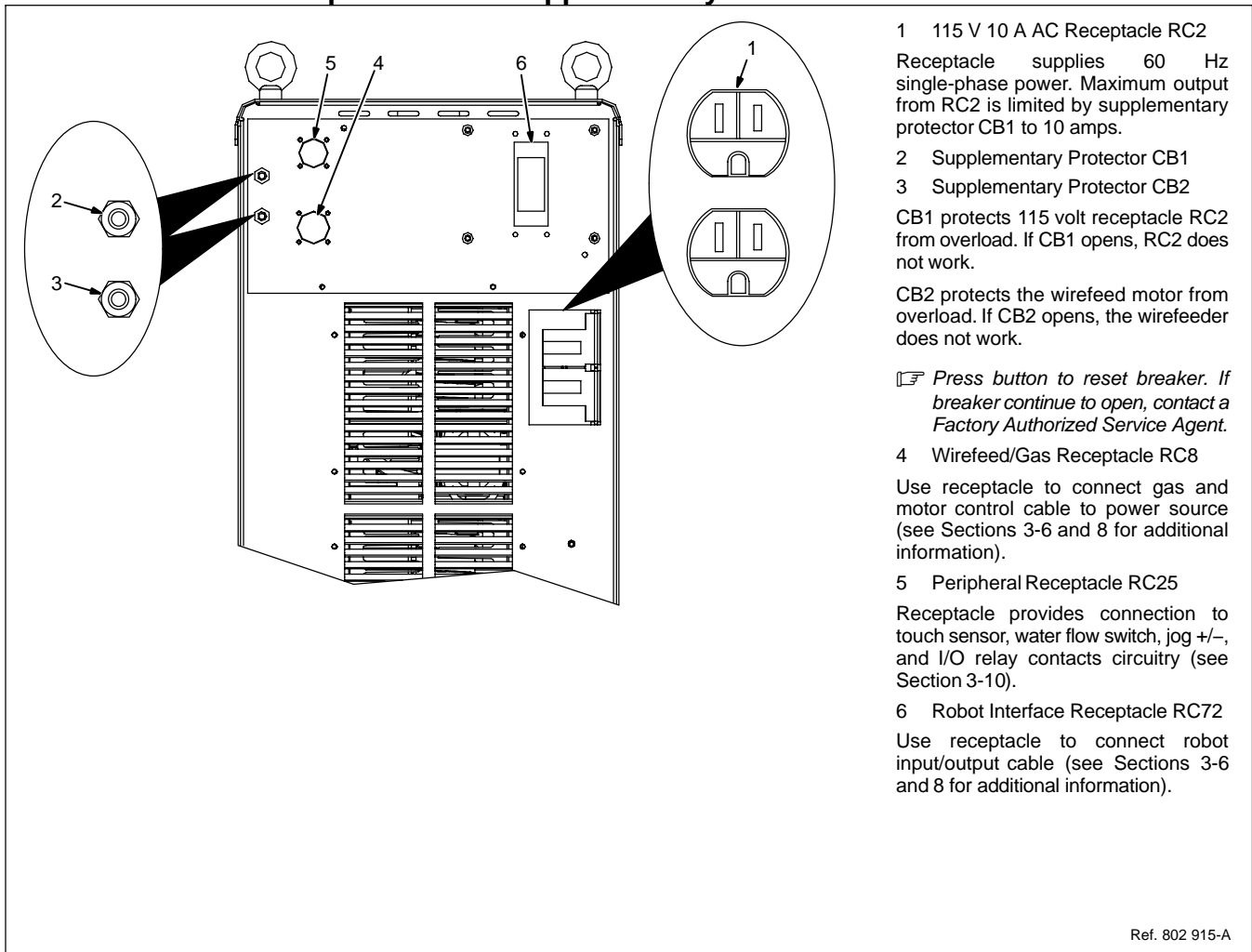

3-8. Connecting To Weld Terminals



☞ If using an electrode negative (straight polarity) process, the volt sense lead must be connected to the work.

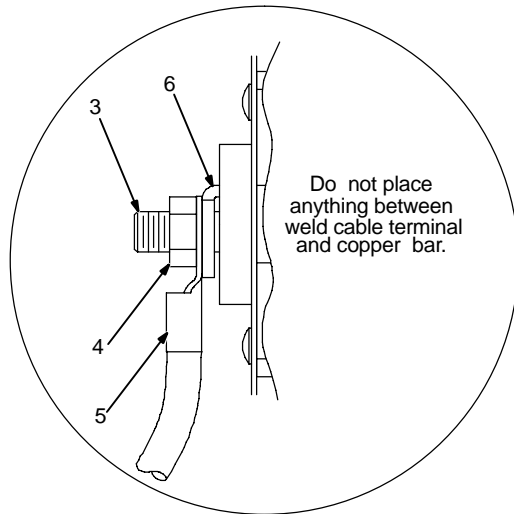
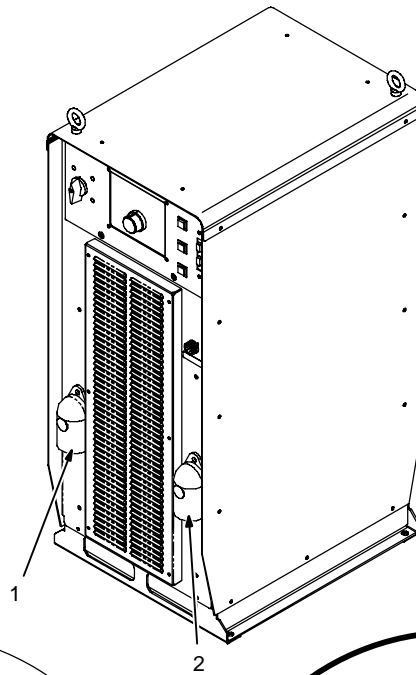

Do not place anything between weld cable terminal and copper bar.

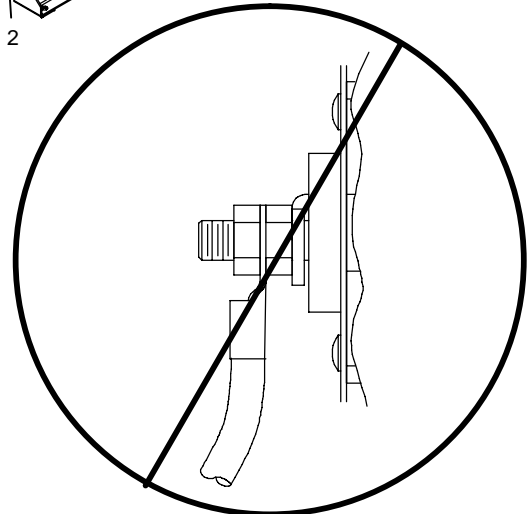

Tools Needed:

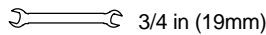

Correct Installation

Incorrect Installation

Ref. 802 913-B / 803 778-A

⚠ Turn off power before connecting to weld output terminals.

⚠ Failure to properly connect weld cables may cause excessive heat and start a fire, or damage your machine.

Determine total cable length in weld circuit (both positive and negative cables combined) and maximum welding amperes. See Section 3-10 to select proper

cable size.

- 1 Positive (+) Weld Output Terminal
 - 2 Negative (-) Weld Output Terminal
- Connect positive weld cable to Positive (+) weld terminal and negative (-) cable to Negative weld terminal.
- 3 Weld Output Terminal
 - 4 Supplied Weld Output Terminal Nut
 - 5 Weld Cable Terminal

6 Copper Bar

Remove supplied nut from weld output terminal. Slide weld cable terminal onto weld output terminal and secure with nut so that weld cable terminal is tight against copper bar. **Do not place anything between weld cable terminal and copper bar. Make sure that the surfaces of the weld cable terminal and copper bar are clean.**

3-9. Selecting Weld Cable Sizes*



ARC WELDING can cause Electromagnetic Interference.

To reduce possible interference, keep weld cables as short as possible, close together, and down low, such as on the floor. Locate welding operation 100 meters from any sensitive electronic equipment. Be sure this welding machine is installed and grounded according to this manual. If interference still occurs, the user must take extra measures such as moving the welding machine, using shielded cables, using line filters, or shielding the work area.

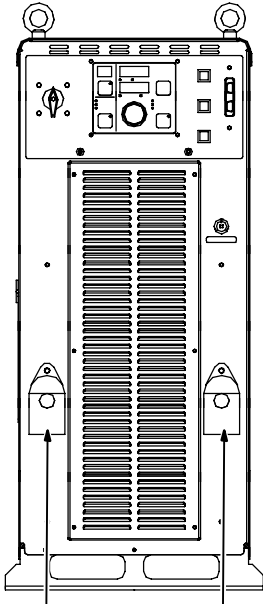
 <p>Weld Output Terminals</p> <p>⚠ Turn off power before connecting to weld output terminals.</p> <p>⚠ Do not use worn, damaged, undersized, or poorly spliced cables.</p>	Weld Cable Size*** and Total Cable (Copper) Length in Weld Circuit Not Exceeding****								
			100 ft (30 m) or Less	150 ft (45 m)	200 ft (60 m)	250 ft (70 m)	300 ft (90 m)	350 ft (105 m)	400 ft (120 m)
	Welding Amperes**	10 – 60% Duty Cycle	60 – 100% Duty Cycle	10 – 100% Duty Cycle					
 <p>Positive + Negative -</p> <p>Ref. 802 914-B</p>	100	4 (20)	4 (20)	4 (20)	3 (30)	2 (35)	1 (50)	1/0 (60)	1/0 (60)
	150	3 (30)	3 (30)	2 (35)	1 (50)	1/0 (60)	2/0 (70)	3/0 (95)	3/0 (95)
	200	3 (30)	2 (35)	1 (50)	1/0 (60)	2/0 (70)	3/0 (95)	4/0 (120)	4/0 (120)
	250	2 (35)	1 (50)	1/0 (60)	2/0 (70)	3/0 (95)	4/0 (120)	2 ea. 2/0 (2x70)	2 ea. 2/0 (2x70)
	300	1 (50)	1/0 (60)	2/0 (70)	3/0 (95)	4/0 (120)	2 ea. 2/0 (2x70)	2 ea. 3/0 (2x95)	2 ea. 3/0 (2x95)
	350	1/0 (60)	2/0 (70)	3/0 (95)	4/0 (120)	2 ea. 2/0 (2x70)	2 ea. 3/0 (2x95)	2 ea. 3/0 (2x95)	2 ea. 4/0 (2x120)
	400	1/0 (60)	2/0 (70)	3/0 (95)	4/0 (120)	2 ea. 2/0 (2x70)	2 ea. 3/0 (2x95)	2 ea. 4/0 (2x120)	2 ea. 4/0 (2x120)
	500	2/0 (70)	3/0 (95)	4/0 (120)	2 ea. 2/0 (2x70)	2 ea. 3/0 (2x95)	2 ea. 4/0 (2x120)	3 ea. 3/0 (3x95)	3 ea. 3/0 (3x95)
	600	3/0 (95)	4/0 (120)	2 ea. 2/0 (2x70)	2 ea. 3/0 (2x95)	2 ea. 4/0 (2x120)	3 ea. 3/0 (3x95)	3 ea. 4/0 (3x120)	3 ea. 4/0 (3x120)
	700	4/0 (120)	2 ea. 2/0 (2x70)	2 ea. 3/0 (2x95)	2 ea. 4/0 (2x120)	3 ea. 3/0 (3x95)	3 ea. 4/0 (3x120)	3 ea. 4/0 (3x120)	4 ea. 4/0 (4x120)
	800	4/0 (120)	2 ea. 2/0 (2x70)	2 ea. 3/0 (2x95)	2 ea. 4/0 (2x120)	3 ea. 4/0 (3x120)	3 ea. 4/0 (3x120)	4 ea. 4/0 (4x120)	4 ea. 4/0 (4x120)
	900	2 ea. 2/0 (2x70)	2 ea. 3/0 (2x95)	2 ea. 4/0 (2x120)	3 ea. 3/0 (3x95)				
	1000	2 ea. 2/0 (2x70)	2 ea. 3/0 (2x95)	2 ea. 4/0 (2x120)	3 ea. 3/0 (3x95)				
1250	2 ea. 3/0 (2x95)	2 ea. 4/0 (2x120)	3 ea. 3/0 (3x95)	4 ea. 3/0 (4x95)					

* This chart is a general guideline and may not suit all applications. If cable overheating occurs, use next size larger cable.

**Cable should be sized for Peak Amperage (Apk) for pulse welding applications.

***Weld cable size (AWG) is based on either a 4 volts or less drop or a current density of at least 300 circular mils per ampere. () = mm² for metric use

****For distances longer than those shown in this guide, call a factory applications representative at 920-735-4505.

S-0007-E

☞ In pulse welding applications using inverter power sources, peak currents can result in extreme voltage drops producing poor welding characteristics with undersized cables. A recommendation for weld cable size is a minimum of 2/0 for 300 ampere welding power sources and 4/0 for 450 ampere welding power sources when total cable length is less than 100 ft (30m).

3-10. Peripheral Receptacle Functions

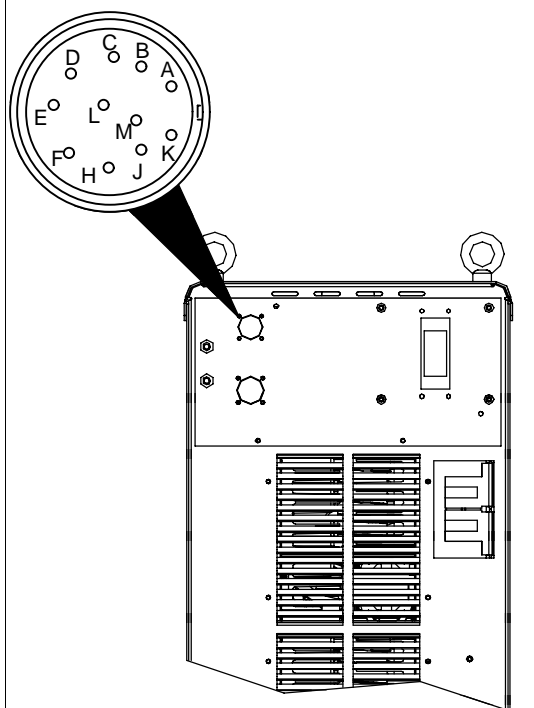
	Function	Socket	Socket Information
 <p style="text-align: right;">Ref. 802 915-A</p>		A	Not used.
		B	Not used.
	Purge	C*	Circuit common.
		D	Contact closure to C completes 40 volts dc solenoid circuit to purge shielding gas line.
	Coolant Flow Switch Input Signal	E	Contact closure to F indicates coolant flow switch is closed and recirculating coolant system is operational.
		F*	Circuit common.
	Jog	H**	Contact closure to circuit common advances welding wire at wire drive assembly.
	Retract	J**	Contact closure to circuit common retracts welding wire at wire drive assembly.
	Touch Sensor ON And Output Signal	K	Contact closure to L energizes Touch Sensor circuitry.
		L*	Circuit common.
M		Part touched +24 volts dc output signal referenced to circuit common.	

*Circuit common is same electrical reference point.

**Speed of Jog + (advance) and Jog - (retract) is 60 ipm for 3 seconds, then it automatically changes to 700 ipm.

Note: A customer supplied matching amphenol plug, factory Part No. 194 847, [Amphenol Part No. 97-3106A-20-33P(B)(621) and strain relief clamp 97-3057-12(0621)] is required to use peripheral receptacle.

3-11. Motor Control Receptacle Functions

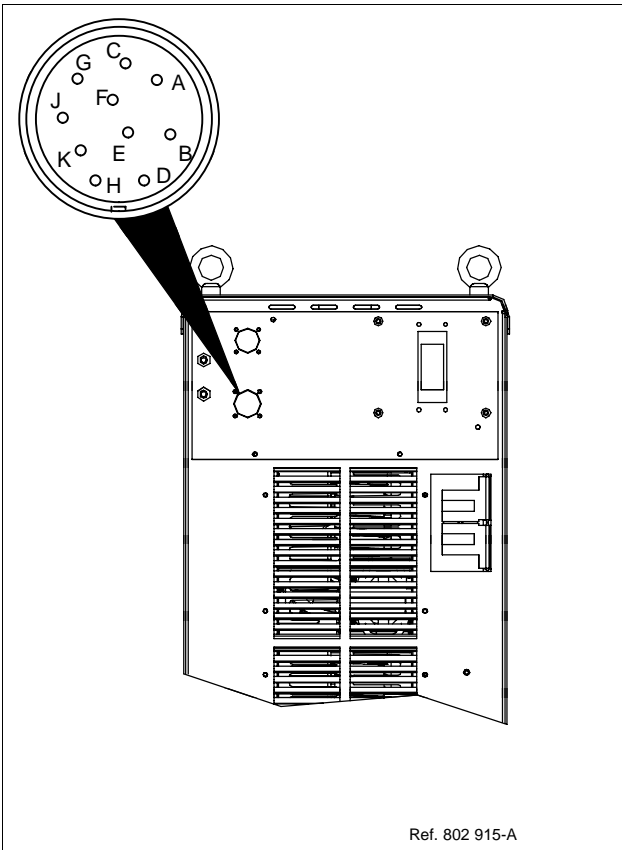

Socket	Socket Information
A	Not used.
B	Motor negative (-).
C	Tach A.
D	Motor positive (+).
E	Tach common.
F	Gas valve.
G	Electrode sense.
H	Tach +5 volts dc.
J	Tach B.
K	Gas valve.

3-12. Electrical Service Guide



Failure to follow these electrical service guide recommendations could create an electric shock or fire hazard. These recommendations are for a dedicated branch circuit sized for the rated output and duty cycle of the welding power source.

NOTICE – INCORRECT INPUT POWER can damage this welding power source. This welding power source requires a CONTINUOUS supply of input power at rated frequency ($\pm 10\%$) and voltage ($\pm 10\%$). Phase to ground voltage shall not exceed +10% of rated input voltage. Do not use a generator with automatic idle device (that idles engine when no load is sensed) to supply input power to this welding power source.

☞ Actual input voltage should not exceed $\pm 10\%$ of indicated required input voltage. If actual input voltage is outside of this range, output may not be available.

	60 Hz Three Phase			
Input Voltage	230	400	460	575
Input Amperes At Rated Output	89.7	52.0	43.7	21.2
Max Recommended Standard Fuse Rating In Amperes				
Circuit Breaker ¹, Time-Delay ²	110	60	50	40
Normal Operating ³	125	80	70	50
Min Input Conductor Size In AWG ⁴	3	6	8	8
Max Recommended Input Conductor Length In Feet (Meters)	173 (53)	275 (84)	231 (70)	361 (110)
Min Grounding Conductor Size In AWG ⁴	6	8	8	10

Reference: 2005 National Electrical Code (NEC) (including article 630)

- 1 Choose a circuit breaker with time-current curves comparable to a Time Delay Fuse.
- 2 "Time-Delay" fuses are UL class "RK5" .
- 3 "Normal Operating" (general purpose - no intentional delay) fuses are UL class "K5" (up to and including 60 amp), and UL class "H" (65 amp and above).
- 4 Conductor data in this section specifies conductor size (excluding flexible cord or cable) between the panelboard and the equipment per NEC Table 310.16. If a flexible cord or cable is used, minimum conductor size may increase. See NEC Table 400.5(A) for flexible cord and cable requirements.

3-13. Connecting Input Power

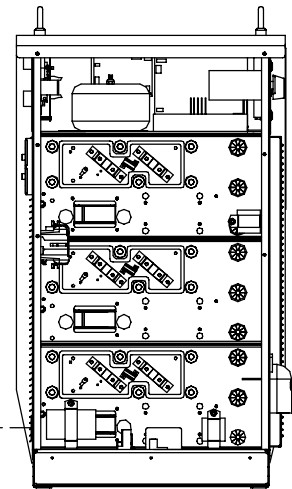
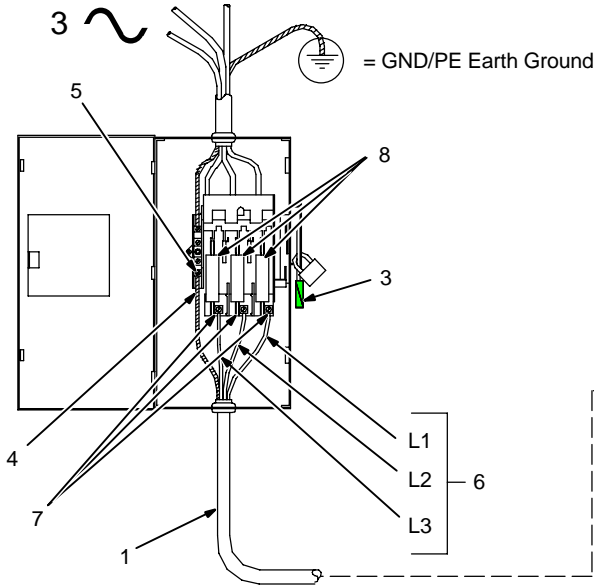
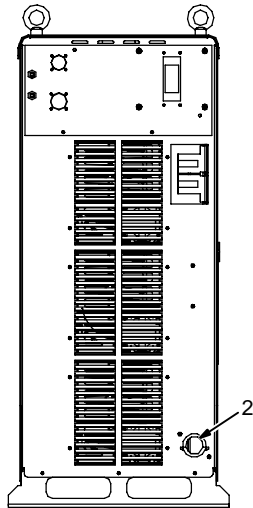

WARNING

ELECTRIC SHOCK can kill; SIGNIFICANT DC VOLTAGE exists after removal of input power.

- Always wait 5 minutes after power is turned off before working on unit.
- Check input capacitor voltage, and be sure it is near 0 before touching any parts.

Read Owner's Manual.

Three-Phase Input Connection

21805-A

Route input power cable through tubing inside unit.

Route ground conductor through current transducer to ground terminal.

Tools Needed:



802 915-A / Ref. 803 766-A / 218 005-A

⚠ Turn Off welding power source, and check voltage on input capacitors according to Section 7-3 before proceeding.

⚠ Installation must meet all National and Local Codes – have only qualified persons make this installation.

⚠ Disconnect and lockout/tagout input power before connecting input conductors from unit.

⚠ Make input power connections to the welding power source first.

⚠ Always connect green or green/yellow conductor to supply grounding terminal first, and never to a line terminal.

- 1 Input Power Conductors (Customer Supplied Cord)

Select size and length of conductors using Section 3-12. Conductors must comply with national, state, and local electrical codes. If

applicable, use lugs of proper amperage capacity and correct hole size.

Welding Power Source Input Power Connections

2 Strain Relief

Install strain relief of proper size for unit and input conductors. Route conductors (cord) through strain relief and tighten screws.

- Use large strain relief for input conductor size 8 and larger.

- Use small strain relief with reducing washers for input conductor size 10.

Connect input conductors as shown in illustration.

Route green or green/yellow grounding conductor through current transducer and connect to welding power source grounding terminal first. Then connect input conductors L1, L2, and L3 to welding power source line terminals.

Reinstall side panel onto welding power source.

Disconnect Device Input Power Connections

- 3 Disconnect Device (switch shown in the OFF position)

- 4 Green Or Green/Yellow Grounding Conductor

- 5 Disconnect Device Grounding Terminal

- 6 Input Conductors (L1, L2 And L3)

- 7 Disconnect Device Line Terminals

Connect green or green/yellow grounding conductor to disconnect device grounding terminal first.

Connect input conductors L1, L2, and L3 to disconnect device line terminals.

8 Over-Current Protection

Select type and size of over-current protection using Section 3-12 (fused disconnect switch shown).

Close and secure door on disconnect device. Remove lockout/tagout device, and place switch in the On position.

3-14. Touch Sensor Operation



The touch sensor feature allows the robot to locate a weldment using the wire feed system and welding power source. The weld output terminals provide a path for touch sensor voltage when this feature is turned on at the peripheral receptacle. Turning on touch sensor causes a dc voltage to be present on the welding wire. When welding wire touches the weldment, the voltage sensing circuit closes, and a +24 volts dc output signal is sent to the robot control indicating weldment detection. Touch sensor dc voltage on the welding wire is 80 volts DC. As soon as touch sensor turns on, WIRE LIVE appears on the front panel display.

3-15. Remote Program Select

 Remote Program Select is factory set to "On". WaveWriter or File Management software is required to turn this function "Off".

When Remote Program Select is On, a remote device or robot pendant may be used to select programs. When Off, program selection must be done from the welding power source front panel.

3-16. Remote Program Setting

 When Remote Program Select is "On", program selection will be determined by remote input once a weld is initiated. Prior to welding, program selection can be done in a normal manner from the welding power source front control panel.

See the following table for the remote program select binary code.

Program No.	Output A	Output B	Output C
1	Off	Off	Off
2	On	Off	Off
3	Off	On	Off
4	On	On	Off
5	Off	Off	On
6	On	Off	On
7	Off	On	On
8	On	On	On

SECTION 4 – OPERATION

4-1. Operational Terms

The following is a list of terms and their definitions as they apply to this interface unit:

General Terms:

Synergic	Synergic refers to the unit's ability to use preprogrammed pulse parameters to determine the actual pulse settings of Peak Amperage, Background Amperage, Pulse Frequency and Pulse Width at any specific wire feed speed setting.
Arc Adjust	Term used to represent arc length adjustments in pulse programs. Increasing Arc Adjust increases the actual arc length. Likewise, decreasing arc adjust shortens arc length. Arc Adjust is replaced by volts in MIG programs.
Program	Eight active slots for selection of various processes, wire types, and parameters.
Process	A selection made for MIG, Pulse, Accu-pulse, and RMD (optional).
MIG	CV weld process with individual settings of voltage and wire speed.
Pulse	Conventional pulse program using peak, background, pulse width, frequency, and peak voltage as factory taught data. Adaptive method is controlled by frequency adjustment.
Accu-pulse	Pulse process utilizing constant current ramps with constant voltage control of peaks and backgrounds. Adaptive response is controlled by peak and minimum current levels. Benefits are shorter arc lengths, better puddle control, more tolerant of tip-to-work variation, less audible noise, no arc wandering, allows weld to fill in at toes increasing travel speed and deposition, and more tolerant to poor fit up and gaps.
Accuspeed	CV Pulse process designed for high travel speeds. Typically used in Robotic applications. Arc is designed to be tight and fast. Front panel display is ACCU – SPED.
AccuCurve	CV Pulse process using a pulse waveform with modified curves at particular locations within the waveform. Has a distinguished change in arc characteristics. Front panel display is ACCU – CURV.
RMD (optional)	RMD refers to Regulated Metal Deposition. A precisely controlled short-circuit transfer. Benefits of RMD are well suited to thin materials, improves gap filling and spatter reduction. Provides less heat input into workpiece, minimizes distortion and allows use of larger diameter wire on thin gauge materials.
Wire Type	Selection of wire type by alloys and classification.
Gas Type	Selection of shielding gas being used in application.
Process Set Up	Selection procedure for entering program.
Program Load	Enters selected program information (process, wire type, gas, etc.) into program slot (1-8).
Volts	Preset voltage in MIG mode at idle, actual voltage while welding, and 3 seconds hold value at end of weld.
Time	Indicates time values being set for timed functions (e.g. Prewflow, Postflow which are only available in the Arc On and Analog input or the Arc On and No Analog input modes).
Arc Length	Distance from end of wire electrode to workpiece.
WFS	Term used to represent wire feed speed. In MIG mode, wire feed setting is independent of voltage setting. In pulse, Accu-pulse, and RMD (optional) adjusting wire feed speed also increases power level on wire electrode (one knob control).
Amps	Indicates average amperage while welding and 3 seconds hold value at end of weld.
Arc Control	Pressing this button will allow setting of inductance in MIG mode and sharp arc in pulse, Accu-pulse, and RMD (optional).
Inductance	In short circuit GMAW welding, an increase in inductance will decrease the number of short circuit transfers per second (provided no other changes are made) and increase the arc-on time. The increased arc-on time makes the welding puddle more fluid.
Sharp Arc	In pulse and Accu-pulse mode this adjustment changes the arc cone by adjusting the preprogrammed factory pulse data. In RMD (optional) this control will affect the arc in much the same way as inductance.
Adjust	Control knob used to change or set parameters and functions.
Sequence	Selecting Sequence will allow setting of preflow, start, crater, postflow, and retract times and parameters (only available on Auto Access models in the Arc On and Analog input or the Arc On and No Analog input modes).
Prewflow	Setting a time value for gas flow prior to arc start (only available on Auto Access models in the Arc On and Analog input or the Arc On and No Analog input modes, and can only be set with the optional PDA with File Management software).

4-1 . Operational Terms (Continued)

Start	Provides voltage/arc adjust, wire feed rate, and time value for modified arc starts (only available on Auto Access models in the Arc On and Analog input or the Arc On and No Analog input modes, and can only be set with the optional PDA with File Management software).
Weld	Sequence function that allows for a timed weld operation [(0 to 999 seconds) only available on Auto Access models in the Arc On and Analog input or the Arc On and No Analog input modes, and can only be set with the optional PDA with File Management software].
Crater	Allows setting of voltage/arc adjust, wire feed rate, and time value for arc ends (only available on Auto Access models in the Arc On and Analog input or the Arc On and No Analog input modes, and can only be set with the optional PDA with File Management software).
Postflow	Setting a time value for gas flow after arc end (only available on Auto Access models in the Arc On and Analog input or the Arc On and No Analog input modes, and can only be set with the optional PDA with File Management software).
Retract	Sequence function that allows the wire to move back towards the contact tip when a welding operation is completed. Setting is both speed (IPM) and time (sec), (only available on Auto Access models in the Arc On and Analog input or the Arc On and No Analog input modes, and can only be set with the optional PDA with File Management software).
Auto Thread	Method of jogging wire without holding jog or trigger switch. Pressing Jog and Retract simultaneously will automatically feed wire. Default setting is 72 inches at a feed rate of 700 ipm. Pressing jog, purge, or trigger switch will terminate the auto-threading feature. These values can be changed using a PDA with File Management/WaveWriter software.

4-2. Front Panel Controls (See Section 4-3)

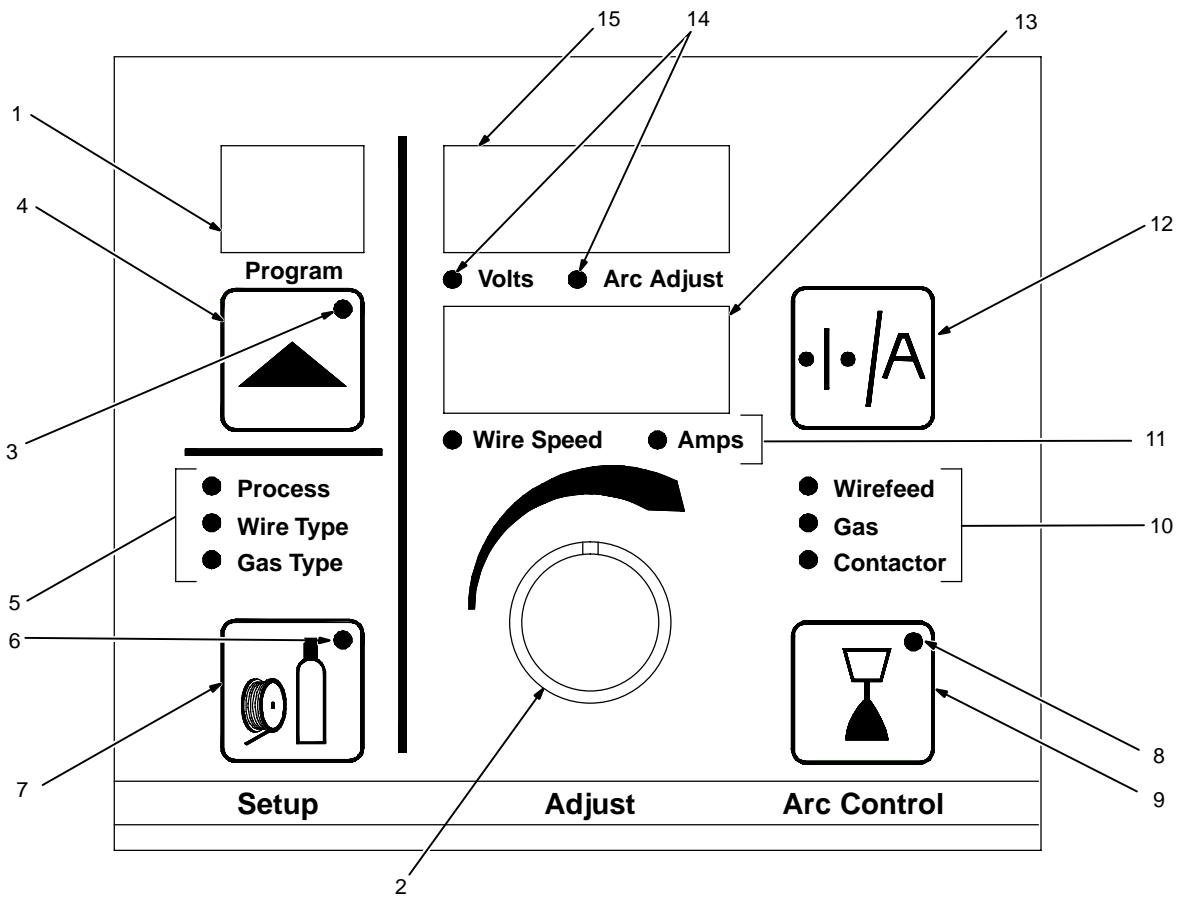

☞ When an LED is lit, it means the related function is active.

198 993

1 Program Display

Displays the number of the active program.

2 Adjust Knob

Turn the Adjust knob to change program number, Setup, Arc Control, and weld parameters.

3 Program Push Button LED

The LED lights when the Program Push Button is active.

4 Program Push Button

Press push button (LED lights) and turn Adjust knob to select active program.

The letter C is displayed with the program number if the program has been changed from the factory settings using the optional PDA with File Management/WaveWriter software (see File Management/WaveWriter Owner's Manual).

☞ The program cannot be changed through the front panel while welding.

Press and hold button to see program name. Custom programs are named using optional

PDA with File Management/WaveWriter software. Program name is shown in upper and lower displays (items 13 and 15).

5 Setup Mode Indicators

The lit LED indicates which setup mode is active. Setup mode parameters are shown in Display Windows (see Items 13 and 15).

Process LED

When this LED is lit, turn the Adjust knob to select the desired weld process. Choices include pulse welding (displayed as PULS), Accu-pulse, MIG welding (MIG), and Accu Puls/RMD [Regulated Metal Deposition (optional)].

Wire Type LED

When this LED is lit, turn the Adjust knob to select the desired wire type, wire alloy, and size. Wire type and size choices vary according to the selected weld process. Choices may include steel (displayed as STL), stainless steel (SS), metal core (MCOR), aluminum (ALUM). See Table 4-1 for all wire abbreviations.

Gas Type LED

When this LED is lit, turn the Adjust knob to select the desired weld gas. Gas type choices vary according to the selected weld process.

See Table 4-1 for all gas abbreviations.

6 Setup Push Button LED

The LED lights to indicate one of the setup modes is active.

7 Setup Push Button

Press button to select Process, Wire Type, Wire Diameter, or Gas Type parameters.

☞ In order for selections to be retained in memory, the Setup push button must be pressed six times before any other push button is pressed: once to select Process, again to select Wire Type, again to select Wire Alloy, again to select Wire Size, again to select Gas Type, and a sixth time to store selections in memory. The displays will temporarily show "PROG LOAD" to indicate the data is being stored in memory.

4-3. Front Panel Controls - Continued (See Section 4-2)

<p>8 Arc Control LED The LED lights to indicate the Arc Control button is active. Light goes out when button is inactive.</p> <p>9 Arc Control Push Button This push button allows fine tuning inductance for MIG programs, and Arc Control for programs other than MIG. When the push button is pressed, the upper display (item 15) shows INDU for inductance, or ARC for Arc Control to indicate which parameter is selected for change. The range of possible values is 0-99 for inductance, and 0-50 for arc control. Turn the Adjust knob to change the parameter value. Press button to deactivate arc control mode (LED goes out).</p> <p>10 Wire Feed/Gas/Contactor LEDs The Wirefeed LED lights when the wire feeder is energized. For example, when the front panel Jog or Retract button is pressed, the Wirefeed LED lights. The Gas LED lights when the gas valve is energized. The Contactor LED lights when the output contactor is energized, making the weld output terminals live.</p>	<p>11 Wire Speed And Amps LED's The lit LED indicates whether wire speed or amps are being displayed.</p> <p>12 Wire Feed Speed/Amps Display Push Button 13 Lower Display Press Wire Feed Speed/Amps Display button to show weld amperage or wire feed speed in lower display (the applicable LED under the lower display lights to indicate which is shown). When welding, actual value is shown. If amperage was selected for display, the unit will show actual welding amperage prior to and while welding unless the the unit is in Display Command Values mode. Only wire speed command will be displayed while welding if the unit is set in Display Command Values mode, even if the Wire Feed Speed/Amps Display button is pressed.</p> <p><i>☞ Displays show actual or command values as determined by configuration menu when using a PDA with File Management/WaveWriter software. Command values are displayed prior to welding and actual values are displayed while welding unless a PDA with File Management software</i></p>	<p><i>was used to set the unit in the "Display Command Values" mode. In the Display Command Values mode, command values are displayed while welding.</i></p> <p><i>☞ If a PDA with File Management/WaveWriter software is used to change wire feed units (IPM, MPM) or display welding information (command or actual), save the changes and then turn the power to the unit off and then on again for the changes to be carried out by the unit.</i></p> <p>14 Volts And Arc Adjust LED's The lit LED indicates whether voltage or arc length is being displayed.</p> <p>15 Upper Display The upper display shows different information depending on the active function of the unit and the weld process being used. When the display shows voltage (for a MIG process), the Volts LED lights. When it shows arc adjust [for a pulsed and RMD (optional) weld process], the Arc Adjust LED lights. However, during any weld process (MIG and pulse), the unit will display actual arc voltage unless a PDA with File Management/WaveWriter software has set the unit in the "Display Command Values" mode.</p>
---	---	--

Table 4-1. Welding Wire And Gas Abbreviations*

Wire Description	Wire Abbreviation	Alloy Type	Gas Type	Gas Abbreviation
Steel	STL	E70, E100, E120	100% CO ₂ , 90% Argon/10% CO ₂ , 85% Argon/15% CO ₂ , 75% Argon/25% CO ₂ , 95% Argon/5% CO ₂ , 95% Argon /5% O ₂ , 98% Argon/2% O ₂	CO2 C10 C15 C25 C5 OX5 OX2
Stainless Steel	SS	308, 309, 312, 316	98% Argon, 2% O ₂ (81Ar/18HE/1CO ₂ Accu-pulse) 90HE/7-1/2Ar/2-1/2CO ₂ MIG/RMD/Accu-pulse)	OX2 Tri Gas Tri Gas
Cored Tubular Wire	MCOR	71, 76, 86R, 409, 439	90% Argon/10% CO ₂	C10
			98% Argon/2% O ₂	OX2
Aluminum	ALUM	4XXX, 5XXX	100% Argon	ARGN
* Not all wire types may be available with your unit.				

Table 4-2. Robot Abbreviations

Manufacturer	Robot Abbreviation
ABB	ABB
Fanuc	FANU
Daihen	DAHN
Kawasaki	KAWA
Kuka	KUKA
Comau	COMU
Hitachi	HCHI
Nachi	NCHI
Panasonic	PANA
Motorman	MOTO
Robot Adapter	DTEC
Detect Disabled	OFF
None	Robt DTEC

4-4. Front Panel Switches

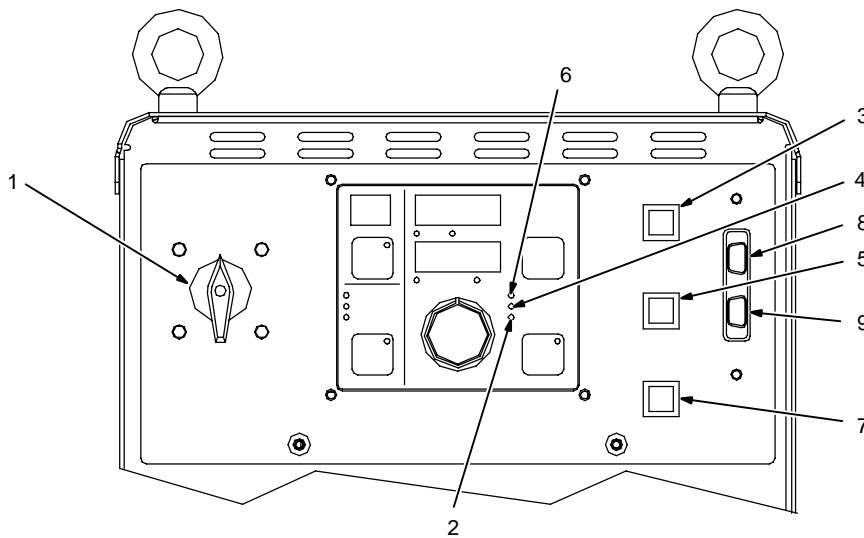

Ref. 802 914-A

1 Power Switch
Turns unit On or Off.

The power-up sequence may last up to 30 seconds before the unit is ready to weld. During power-up, the front panel will display messages indicating the status of the unit. The first message is:

NET WAIT

NET WAIT is an abbreviation for "network updating" and means the internal control network is powering up. The next message is **XXXX** (Robot Type)

XXXX identifies the robot adapter being used as identified by the unit (see Table 4-2 for a list of robot adapters that could be displayed). To ensure proper operation of the system, verify the robot displayed corresponds to the actual robot being used. The final message is

AUTO 675

AUTO 675 indicates the software being loaded.

2 Contactor LED

Contactor LED illuminates when weld output is energized.

3 Purge Push Button

Press button to purge gas line.

4 Gas LED

Gas LED illuminates when Purge push button is pressed.

5 Jog Push Button

Press button to jog wire.

6 Wirefeed LED

Wirefeed LED illuminates when wire feeds or retracts.

7 Retract Push Button

Press button to retract wire. Wirefeed LED illuminates when Retract push button is pressed.

Auto-Threading feature is activated by pressing the Jog and Retract buttons simultaneously. Pressing the Jog, Purge, or trigger switch will turn off the Auto-Threading feature.

8 PDA Port

9 PC Port

4-5. Robot Calibration Mode

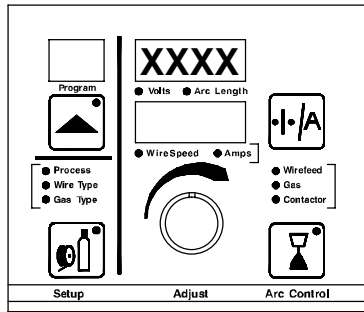

Turn unit On. Unit displays abbreviated name of robot detected where XXXX appears (see Table 4-2 for a list of robot adapters that could be displayed).

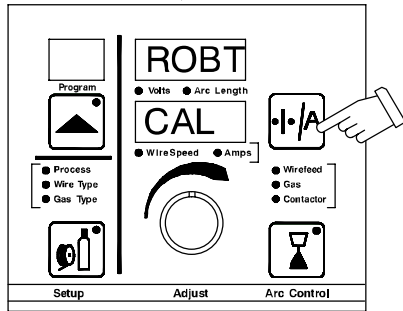

To enter calibration mode while robot name appears on front panel, press and hold wire feed/amps button until "ROBT CAL" appears on front panel. "ROBT CAL" message will not display until after the power-up sequence is completed (approximately 20 seconds).

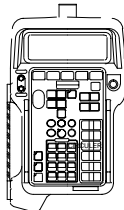

Use robot pendant or other method to enter two weld schedules into the robot. Maintain schedule 1 for at least 10 to 20 seconds minimum before moving on to schedule 2. Maintain schedule 2 for 10 to 20 seconds before ending the simulated weld. Schedule data is shown below:

Schedule 1	Schedule 2
10.0 Volts	44.0 Volts
100 IPM	1000 IPM

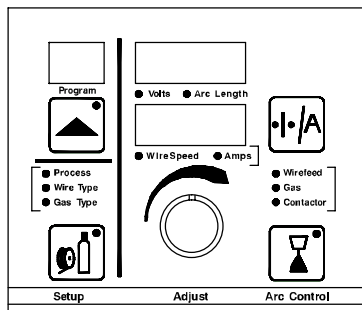

When the robot calibration mode ends, the ROBT CAL message stops and the unit will display normal front panel information.

Use the robot calibration mode to custom-calibrate the power source to the robot command signals. This ensures the wire speed, voltage, and arc adjust are the same on the robot pendant as on the power source.

The factory recommendation is to perform the calibration on all installations or code updates.

Follow this procedure if the factory settings are not as accurate as desired. Synchronization of the robot and power source signals makes installation easier and improves the operation of the system.

The robot pendant must have Weld enabled, and there can be no start/stop crater conditions set in the robot.

The calibration mode will execute as a "dry run" from the operator's perspective. The welding power source provides the robot with feedback so the robot thinks a weld is underway, yet the robot torch need not move during the calibration.

If you wish to stop the calibration procedure, turn unit input power off and then on again.

If the calibration is performed correctly the ROBT CAL message stops being displayed; however, if it is performed incorrectly, the message remains on the display.

To start the calibration procedure over again, turn unit input power off and then on again following the calibration setup steps following the calibration setup steps.

4-6. Robot Auto-Calibration Sample Programs

☞ It is critical to make certain that NO start power, start conditions, run-in, or crater parameters of any kind are present in the robot program. The welding power source is looking for 2 distinct welding conditions. If there is a "start power" condition, the welding power source will equate this as the first condition and fail to execute Auto-Cal correctly. If there is a "crater fill" condition, the welding power source will equate this as the second condition and fail to execute Auto-Cal correctly.

Actual Motoman Welder Condition File

<Welding Current Output Char.>

NO.	REF (V)	MEASURE (A)
01	0.01	1
02	7.00	500
03	13.99	999
04	0.00	000

<Welding Voltage Output Char.>

NO.	REF (V)	MEASURE (V)
01	0.14	0.5
02	7.00	25.0
03	14.00	50.0
04		

Sample Auto-Calibration Routine For Motoman Robot

```
0000 NOP
0001 Mov J
0002 AWELD 1.40 (AWELD direct input of 1.40Volts = 100 ipm)
0003 VWELD 2.80 (VWELD direct input of 2.80Volts = 10.0 volts)
0004 Arcon
0005 Timer T=10.00
0006 Arcof
0007 AWELD 14.00 (AWELD direct input of 14.00Volts = 1000 ipm)
0008 VWELD 12.32 (VWELD direct input of 12.32Volts = 44.0 volts)
0009 Arcon
0010 Timer T=10.00
0011 Arcof
0012 End
```

Sample Auto-Calibration Routine For Fanuc Robot

- 1: Call Safehome
- 2: J P[1] 40% Fine
Arcstart [10.0Volts, 100.0IPM]
- 3: L P[2] 10.0 sec Fine
Arc End [0.0Volts, 0.0IPM, 0.0Sec]
- 4: Wait 1.00 (Sec)
- 5: J P[3] 40% Fine
Arcstart [44.0Volts, 1000.0IPM]
- 6: L P[4] 10.0 sec Fine
Arc End [0.0Volts, 0.0IPM, 0.0Sec]
- 7: Call Safehome

Sample Auto-Calibration Routine For ABB Robot

```
Move J home, v500, z50, tweldgun;  
Arcl \ on, *, v500, sm1, wd1, wv0, z50, tweldgun;  
Arcl \ off, *, v500, sm1, wd1, wv0, z50, tweldgun;  
WaitTime 5;  
Arcl \ on, *, v500, sm1, wd2, wv0, z50, tweldgun;  
Arcl \ off, *, v500, sm1, wd2, wv0, z50, tweldgun;  
Move J home, v500, z50, tweldgun;
```

*Seam Data values must all be set at zero.

Weld Data 1:	Weld Data 2:
weld_sched:=0	weld_sched:=0
weld_speed:=5	weld_speed:=5
weld_voltage:=10	weld_voltage:=44
weld_wfs:=100	weld_wfs:=1000
org_weldspeed:=0	org_weldspeed:=0
org_weldvoltage:=0	org_weldvoltage:=0
org_weldwfeed:=0	org_weldwfeed:=0

4-7. Reset Mode

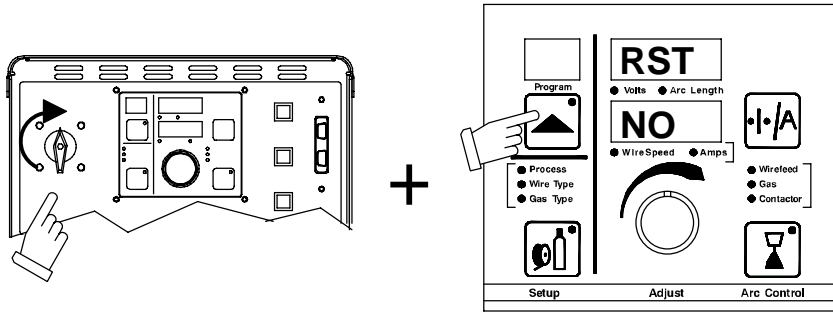

Enter reset mode by turning power On and pressing the Program Push Button until the RST NO message is displayed. RST NO message will not display until after the power-up sequence is completed (approximately 20 seconds).

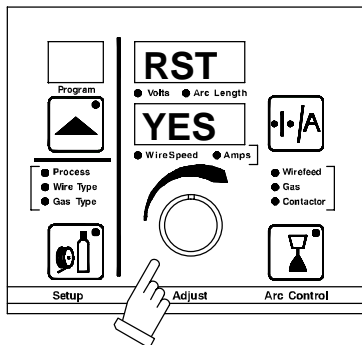

Rotate Adjust knob to change NO to YES.

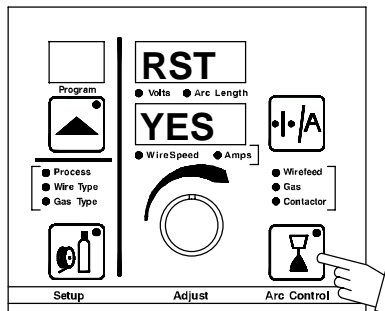

Press the Arc Control button to confirm the reset.

The reset message is displayed for 2 seconds while factory program settings are being reloaded.

During the reset mode the following factory default programs are loaded into the unit:

Program 1	Pulse .035 Mild Steel 90% Argon, 10% CO ₂
Program 2	MIG .035 Mild Steel 75% Argon, 25% CO ₂
Program 3	Accu-pulse .035 Mild Steel 90% Argon, 10% O ₂
Program 4	Pulse .045 Mild Steel 90% Argon, 10% CO ₂
Program 5	MIG .045 Mild Steel 75% Argon, 25% CO ₂
Program 6	Accu-pulse .045 Mild Steel 90% Argon, 10% O ₂
Program 7	Pulse .052 Mild Steel 90% Argon, 10% CO ₂
Program 8	MIG .052 Mild Steel 75% Argon, 25% CO ₂

Reset mode is not active when Program Lock is enabled.

The reset mode allows the operator to reload factory program settings for all eight active programs in the unit.

System configuration data will be lost during the Reset operation.

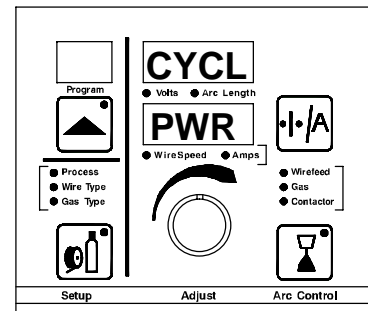

Cycl Pwr message appears on the display when programs complete loading.

Turn power off, wait 10 seconds, and turn power back on again to complete the reset operation.

After Reset is complete, be sure to load appropriate programs that contain the correct wire size, process, and shielding gas for the welding operation

SECTION 5 – MAINTENANCE

5-1. Routine Maintenance

					Disconnect power before maintaining.		<i>Maintain more often during severe conditions.</i>	
					✓ = Check ◇ = Change ● = Clean ☆ = Replace * To be done by Factory Authorized Service Agent		Reference	
Every 3 Months	☆ Unreadable Labels		● Weld Terminals		☆ Damaged Gas Hose		✓ ☆ Weld Cables	
	✓ ☆ Cords		✓ ☆ Gun Cables					
Every 6 Months	● Drive Rolls		● Inside Unit					

5-2. Blowing Out Inside Of Unit

		Do not remove case when blowing out inside of unit. To blow out unit, direct airflow through front and back louvers as shown.	

Ref. 802 913-B

SECTION 6 – SAFETY PRECAUTIONS FOR SERVICING

 Protect yourself and others from injury — read and follow these precautions.

6-1. Symbol Usage

OM-201 540K - 2007-10, safety_stm 2007-04

 **DANGER!** – Indicates a hazardous situation which, if not avoided, will result in death or serious injury. The possible hazards are shown in the adjoining symbols or explained in the text.

 Indicates a hazardous situation which, if not avoided, could result in death or serious injury. The possible hazards are shown in the adjoining symbols or explained in the text.

NOTICE – Indicates statements not related to personal injury.

 Indicates special instructions.



This group of symbols means Warning! Watch Out! ELECTRIC SHOCK, MOVING PARTS, and HOT PARTS hazards. Consult symbols and related instructions below for necessary actions to avoid the hazards.

6-2. Servicing Hazards

 The symbols shown below are used throughout this manual to call attention to and identify possible hazards. When you see the symbol, watch out, and follow the related instructions to avoid the hazard.

 Only qualified persons should test, maintain, and repair this unit.

 During servicing, keep everybody, especially children, away.



ELECTRIC SHOCK can kill.

- Do not touch live electrical parts.
- Turn Off welding power source and wire feeder and disconnect and lockout input power using

line disconnect switch, circuit breakers, or by removing plug from receptacle, or stop engine before servicing unless the procedure specifically requires an energized unit.

- Insulate yourself from ground by standing or working on dry insulating mats big enough to prevent contact with the ground.
- Do not leave live unit unattended.
- If this procedure requires an energized unit, have only personnel familiar with and following standard safety practices do the job.
- When testing a live unit, use the one-hand method. Do not put both hands inside unit. Keep one hand free.
- Disconnect input power conductors from deenergized supply line BEFORE moving a welding power source.

SIGNIFICANT DC VOLTAGE exists after removal of input power on inverters.

- Turn Off inverter, disconnect input power, and discharge input capacitors according to instructions in Troubleshooting Section before touching any parts.

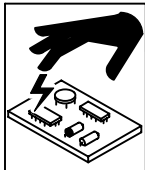

STATIC (ESD) can damage PC boards.

- Put on grounded wrist strap BEFORE handling boards or parts.
- Use proper static-proof bags and boxes to store, move, or ship PC boards.



FIRE OR EXPLOSION hazard.

- Do not place unit on, over, or near combustible surfaces.
- Do not service unit near flammables.

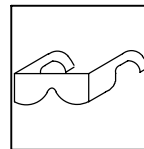

FLYING METAL or DIRT can injure eyes.

- Wear safety glasses with side shields or face shield during servicing.
- Be careful not to short metal tools, parts, or wires together during testing and servicing.

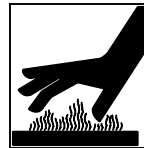

HOT PARTS can cause severe burns.

- Do not touch hot parts bare handed.
- Allow cooling period before working on equipment.
- To handle hot parts, use proper tools and/or wear heavy, insulated welding gloves and clothing to prevent burns.

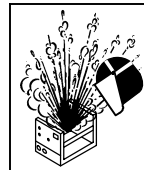

EXPLODING PARTS can cause injury.

- Failed parts can explode or cause other parts to explode when power is applied to inverters.
- Always wear a face shield and long sleeves when servicing inverters.

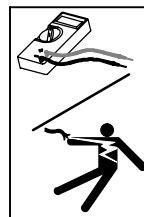

SHOCK HAZARD from testing.

- Turn Off welding power source and wire feeder or stop engine before making or changing meter lead connections.
- Use at least one meter lead that has a self-retaining spring clip such as an alligator clip.
- Read instructions for test equipment.



FALLING UNIT can cause injury.

- Use lifting eye to lift unit only, NOT running gear, gas cylinders, or any other accessories.
- Use equipment of adequate capacity to lift and support unit.
- If using lift forks to move unit, be sure forks are long enough to extend beyond opposite side of unit.



MOVING PARTS can cause injury.

- Keep away from moving parts such as fans.
- Keep away from pinch points such as drive rolls.
- Have only qualified persons remove doors, panels, covers, or guards for maintenance as necessary.
- Keep hands, hair, loose clothing, and tools away from moving parts.
- Reinstall doors, panels, covers, or guards when maintenance is finished and before re-connecting input power.

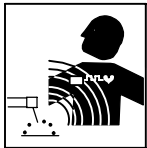

MAGNETIC FIELDS can affect Implanted Medical Devices.

- Wearers of Pacemakers and other Implanted Medical Devices should keep away from servicing areas until consulting their doctor and the device manufacturer.

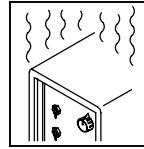

OVERUSE can cause OVERHEATING.

- Allow cooling period; follow rated duty cycle.
- Reduce current or reduce duty cycle before starting to weld again.
- Do not block or filter airflow to unit.

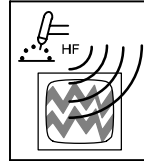

H.F. RADIATION can cause interference.

- High-frequency (H.F.) can interfere with radio navigation, safety services, computers, and communications equipment.
- Have only qualified persons familiar with electronic equipment install, test, and service H.F. producing units.
- The user is responsible for having a qualified electrician promptly correct any interference problem resulting from the installation.
- If notified by the FCC about interference, stop using the equipment at once.
- Have the installation regularly checked and maintained.
- Keep high-frequency source doors and panels tightly shut, keep spark gaps at correct setting, and use grounding and shielding to minimize the possibility of interference.

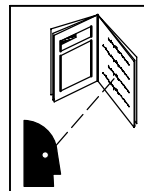

READ INSTRUCTIONS.

- Use Testing Booklet (Part No. 150 853) when servicing this unit.
- Consult the Owner's Manual for welding safety precautions.
- Use only genuine replacement parts from the manufacturer.

6-3. California Proposition 65 Warnings

⚠ Welding or cutting equipment produces fumes or gases which contain chemicals known to the State of California to cause birth defects and, in some cases, cancer. (California Health & Safety Code Section 25249.5 et seq.)

⚠ Battery posts, terminals and related accessories contain lead and lead compounds, chemicals known to the State of California to cause cancer and birth defects or other reproductive harm. Wash hands after handling.

For Gasoline Engines:

⚠ Engine exhaust contains chemicals known to the State of California to cause cancer, birth defects, or other reproductive harm.

For Diesel Engines:

⚠ Diesel engine exhaust and some of its constituents are known to the State of California to cause cancer, birth defects, and other reproductive harm.

6-4. EMF Information

Considerations About Welding And The Effects Of Low Frequency Electric And Magnetic Fields

Welding current, as it flows through welding cables, will cause electromagnetic fields. There has been and still is some concern about such fields. However, after examining more than 500 studies spanning 17 years of research, a special blue ribbon committee of the National Research Council concluded that: "The body of evidence, in the committee's judgment, has not demonstrated that exposure to power-frequency electric and magnetic fields is a human-health hazard." However, studies are still going forth and evidence continues to be examined. Until the final conclusions of the research are reached, you may wish to minimize your exposure to electromagnetic fields when welding or cutting.

To reduce magnetic fields in the workplace, use the following procedures:

1. Keep cables close together by twisting or taping them, or using a cable cover.
2. Arrange cables to one side and away from the operator.
3. Do not coil or drape cables around your body.
4. Keep welding power source and cables as far away from operator as practical.
5. Connect work clamp to workpiece as close to the weld as possible.

About Implanted Medical Devices:

Implanted Medical Device wearers should consult their doctor and the device manufacturer before performing or going near arc welding, spot welding, gouging, plasma arc cutting, or induction heating operations. If cleared by your doctor, then following the above procedures is recommended.

SECTION 7 – TROUBLESHOOTING

7-1. Set Value Mode

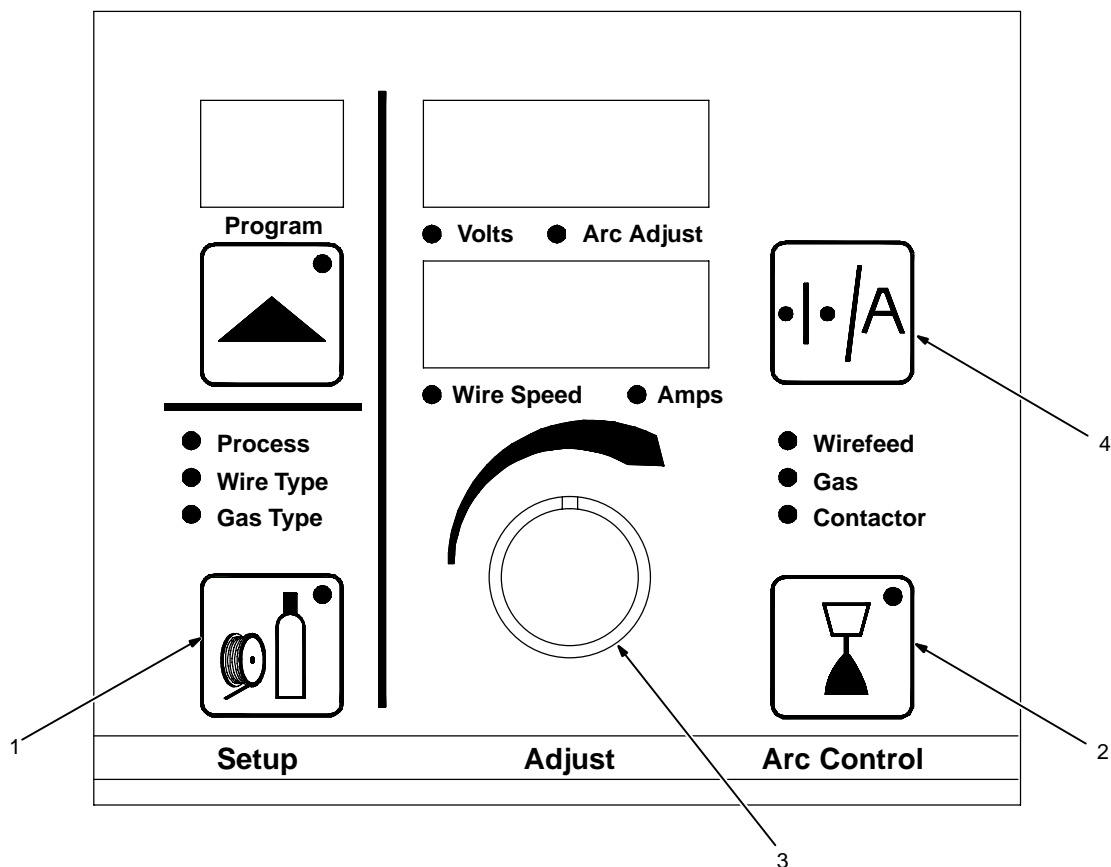

The Set Value mode is a troubleshooting tool that allows certain robot command values to be manually over-ridden.

- 1 Setup Push Button
- 2 Arc Control Push Button
- 3 Adjust Knob
- 4 Wire Feed Speed/Amps Display Push Button

Enter the Set Value mode by pressing the Setup and Arc Control push buttons at the same time. When in the Set Value mode the display windows briefly shows SET VALU and the blinking LED's under the display windows indicate whether Volts, Arc Adjust, or Wire Speed can be changed turning the Adjust knob.

Depending on the defined weld process, either volts (MIG) or arc adjust [pulse, Accu-pulse, or RMD (optional)] can be changed in the top display. Wire speed can be

changed in the bottom display. Press the Wire Feed Speed/Amps push button to toggle between selecting information in the top display or bottom display. The LED under the active display will blink to indicate the value that can be changed.

Rotate the Adjust knob to change values.

Exit the Set Value mode by pressing the Setup and Arc Control push buttons at the same time or turning power source off and then back on again.

7-2. Diagnostics

The following error messages are shown on the upper and lower displays to indicate specific errors. Explanations are in the text below:

ERR	ERR	ERR	ERR	ERR	ERR
TACH	MOTR	WFS	STRT	STOP	FLOW
Indicates a tachometer error.	Indicates a motor error.	Indicates a wire feed speed error.	Indicates an arc start error.	Indicates an arc stop error.	Indicates a gas flow error.

ERR	ERR	ERR	ERR	ERR	ERR
COOL	GND	STUK	TEMP	LINE	ARC
Indicates a coolant flow error.	Indicates a ground current error.	Indicates a wire stuck error.	Indicates a temperature error.	Indicates a line error.	Indicates an arc error.

ERR TACH

- **Tach error** for Tach A occurs 2 seconds after the loss of tachometer feedback. The motor speed is regulated through the monitoring of voltage and current. Press Jog/Purge button to clear error.
- **Tach error** for Tach B occurs 2 seconds after the loss of tachometer feedback. The motor speed is regulated through the monitoring of voltage and current. Press Jog/Purge button to clear error.

ERR MOTR

- **The motor error** indicates that the motor has been drawing too much current for too long. To remedy this, reduce the wire feed speed or the wire feeder torque load/duty cycle. Press Jog/Purge button to clear error.

ERR WFS

- **The wire feed speed error** indicates actual wire feed speed does not match wire feed speed command. Press Jog/Purge button to clear error.

ERR STRT

- **The start error**, when enabled, occurs if the trigger is held longer than three seconds without an arc start. The error may be cleared by releasing the trigger, and pressing the Jog/Purge button.

ERR STOP

- **The stop error** occurs as result of obstructions in the wire feed system or a faulty wire drive system. Check wire feed and wire drive systems. Press Jog/Purge button to clear error.

ERR FLOW

- **The flow error** indicates no gas flow to the gun. The error may be reset by reestablishing gas flow to the gun, and then pressing the Jog/Purge button.

ERR COOL

- **The cool error** indicates no coolant flow in water flow switch option. The error may be reset by reestablishing coolant flow to the gun, and then pressing the Jog/Purge button.

ERR GND

- **The ground current error** occurs if weld current is detected in the earth ground connection. May be caused by a conductor making contact with unit chassis. Check and repair feeder weld connections. Turn power off and back on to clear error.

ERR STUK

- **The stuck error** occurs if the welding wire sticks to the workpiece at the end of a weld. May be caused by poor weld conditions. The error may be cleared by cutting wire from workpiece, and pressing the Jog/Purge button.

ERR TEMP

- **The temperature error** indicates welding power source has overheated and shutdown. The error may be cleared by allowing unit to cool down, and pressing the Jog/Purge button. If problem persists, check fan motors and thermistors for proper operation. If unit is not overheated, check input line voltage. If input line voltage is okay, contact nearest factory authorized Service Agent.

ERR LINE

- **The line error** indicates input power is outside of unit operating range. Check and correct input power. Press Jog/Purge button to clear error.

ERR ARC

- **The arc error** indicates an arc outage occurred possibly from a wire feeder error or power source error. Check wire feeder and power source. Press Jog/Purge button to clear error.

7-2. Diagnostics (Continued)

WELD	MOTR	PLS	LOW	E	RMD
WAIT	COM	WAIT	WFS	STOP	DONE
Indicates a weld cycle wait error.	Indicates a motor communication error.	Indicates a UIM communication error.	Indicates a low WFS command error.	Indicates an emergency stop error.	Indicates RMD demo is done.
OVER	REL	TRIG	ERR	OVER	
AVG	TRIG	STUK	UNKN	CRNT	
Indicates an over average current error.	Indicates a contactor on error.	Indicates a trigger closed error.	Indicates an unknown error.	Indicates an overcurrent error.	
<p>WELD WAIT</p> <ul style="list-style-type: none"> • The weld wait error indicates unit was not ready for a weld sequence. Press Jog/Purge button to clear error. <p>MOTR COM</p> <ul style="list-style-type: none"> • The motor communication error indicates motor board lost data communications. Press Jog/Purge button to clear error. If condition persists, contact nearest factory authorized service agent. <p>PLS WAIT</p> <ul style="list-style-type: none"> • The uim communication error indicates user interface board lost data communications. Press Jog/Purge button to clear error. If condition persists, contact nearest factory authorized service agent. <p>LOW WFS</p> <ul style="list-style-type: none"> • The low wire feed speed error indicates actual wire feed speed is lower than wire feed speed command. Check for obstructions in the wire feed system or a faulty wire drive system. Press Jog/Purge button to clear error. <p>E STOP</p> <ul style="list-style-type: none"> • The emergency stop error occurs if the user presses an emergency stop button. Reset the emergency stop button and press Jog/Purge button to clear error. Only applies to units equipped with E stop option. <p>RMD DONE</p> <ul style="list-style-type: none"> • The RMD done message indicates the RMD demo is completed. Pressing Jog/Purge button will change the screen to CYCL PWR on the display. Turn unit power off and back on again. <p>OVER AVG</p> <ul style="list-style-type: none"> • The over average error indicates that current is outside the average range for the set program parameters. Check and correct program parameters. Press Jog/Purge button to clear error. <p>REL TRIG</p> <ul style="list-style-type: none"> • The release trigger error indicates the user held the gun trigger after an E stop was reset causing the contactor to remain on. Press Jog/Purge button to clear error. <p>TRIG STUK</p> <ul style="list-style-type: none"> • The trigger stuck error indicates the user held the gun trigger during power up. Release trigger and turn power off and back on. <p>ERR UNKN</p> <ul style="list-style-type: none"> • The unknown error indicates an error was sent from the PCM board to the UIM, but error condition is unknown. Make sure welding power source is isolated from the welding fixture. Press Jog/Purge button to clear error. <p>OVER CRNT</p> <ul style="list-style-type: none"> • The over current error indicates welding power source primary current of the inverter is too high. Turn welding power source off and disconnect unit for servicing. Attempting to reset the display to continue welding may further damage internal components. A complete prepower check of the unit is needed including resistance measurements of R1 and R8 resistors on welding power source Interconnect board. Resistors should measure 30K ohms. Visually inspect electrolytic capacitors C1 and C2 for any possible damage. In the event of an over voltage condition, R1 and R8 could open potentially causing an imbalance in the power circuit. This condition would create excessive current in the inverter primary transformer and result in the OVER CRNT error. 					

7-3. Removing Cover and Measuring Input Capacitor Voltage



900 Volts dc can be present on the capacitor bus and significant DC voltage can remain on capacitors after unit is Off. Always check the voltage on both inverter assemblies as shown to be sure the input capacitors have discharged before working on unit.

Turn Off welding power source, and disconnect input power.

Remove cover

- 1 Power Interconnect Board PC2
- 2 Voltmeter

Measure the dc voltage across the + bus terminal and – bus terminal on PC2 as shown until voltage drops to near 0 (zero) volts. Measure input capacitor voltage on all three inverter assemblies before proceeding.

3 Typical Bleeder Resistor

An example of a typical bleeder resistor is shown on this page.

Proceed with job inside unit. Reinstall cover when finished.

Tools Needed:

 5/16 in

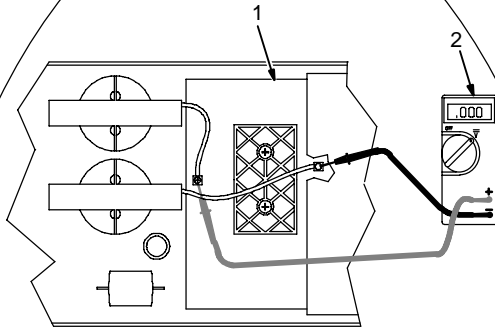
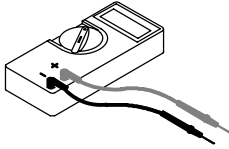

+ lead to left bus terminal, – lead to right bus terminal

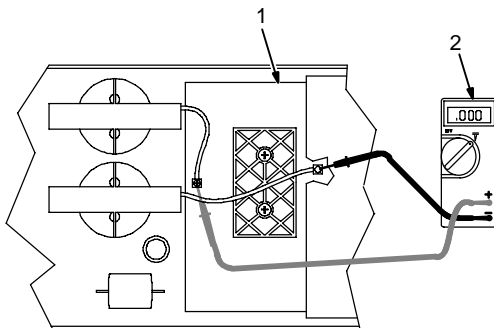

+ lead to left bus terminal, – lead to right bus terminal

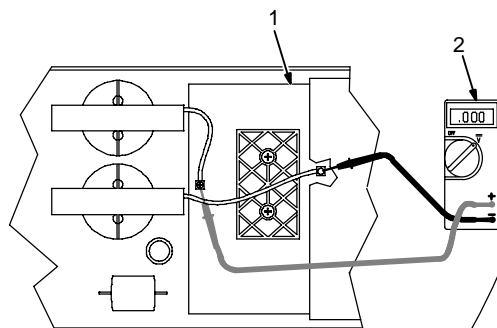

+ lead to left bus terminal, – lead to right bus terminal

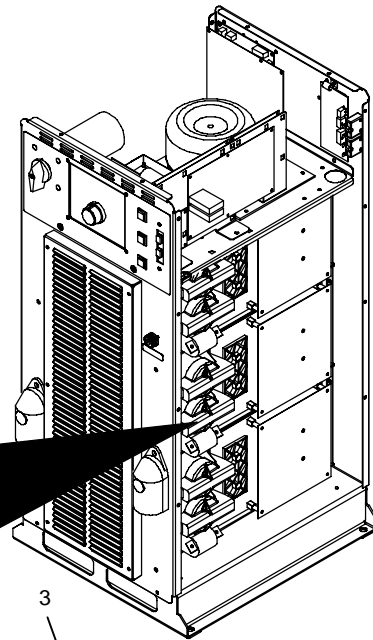

3

Typical Bleeder Resistor

25 to 1000 ohm, 5 watt resistor

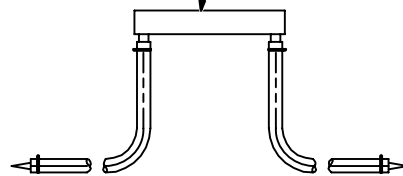

#16 AWG 1000 volts dc insulation rating, approx 3 in (76 mm) leads

7-4. Process Control Module PC4 Diagnostic LED's



1 Process Control Module PC4

Diagnostic LED's are visible inside unit, located on PC4 mounted on the top tray.

Refer to Section 7-5 for information on diagnostic LED's.

Reinstall cover after checking diagnostic LED's.

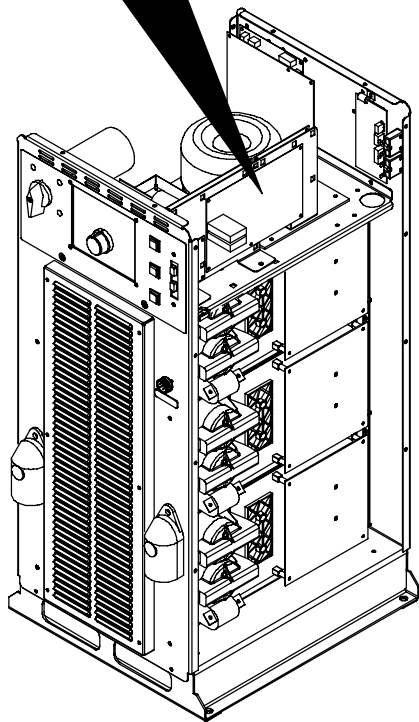
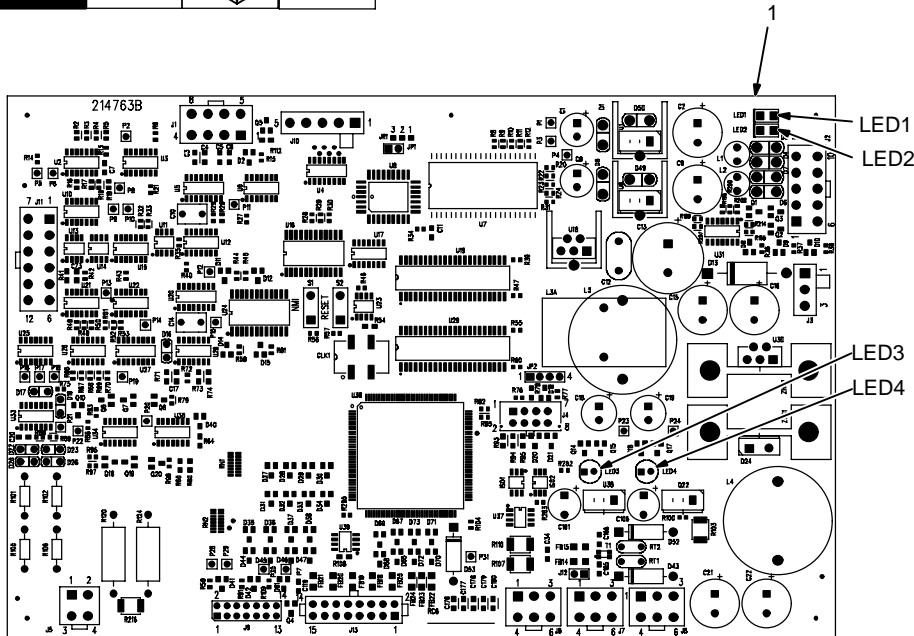

216 956-A / Ref. 803 001-B

7-5. Diagnostic LED's On Process Control Module PC4

LED	Status	Diagnosis
1	On	Indicates -25 volts dc is present on process control module PC4
	Off	Indicates -25 volts dc is not present on process control module PC4
2	On	Indicates +25 volts dc is present on process control module PC4
	Off	Indicates +25 volts dc is not present on process control module PC4
3,4	On	See Network Status Table in Section 7-12
	Off	See Network Status Table in Section 7-12

7-6. Wire Feed Module PC6 Diagnostic LED's And Dip Switch Settings

1 Wire Feed Module PC6

Diagnostic LED's are visible inside unit, located on PC6 mounted on the top tray assembly.

Refer to Section 7-7 for information on diagnostic LED's.

Reinstall top cover after checking diagnostic LED's.

2 Dip Switch S1

Dip switches are used to identify each circuit board on the internal network. Dip switch settings are different for each circuit board. For proper operation, do not change dip settings from those shown.

1 Wire Feed Module PC6

Diagnostic LED's are visible inside unit, located on PC6 mounted on the top tray assembly.

Refer to Section 7-7 for information on diagnostic LED's.

Reinstall top cover after checking diagnostic LED's.

2 Dip Switch S1





Dip switches are used to identify each circuit board on the internal network. Dip switch settings are different for each circuit board. For proper operation, do not change dip settings from those shown.

217 333-B / 803 300-A

7-7. Diagnostic LED's On Wire Feed Module PC6

LED	Status	Diagnosis
1	On	Indicates +15 volts dc is present on wire feed module PC6
	Off	Indicates +15 volts dc is not present on wire feed module PC6
2	On	Indicates +5 volts dc is present on wire feed module PC6
	Off	Indicates +5 volts dc is not present on wire feed module PC6
3,4	On	See Network Status Table in Section 7-12
	Off	See Network Status Table in Section 7-12

7-8. User Interface Module PC7 Diagnostic LED's



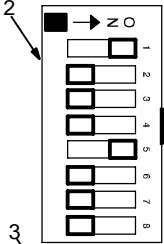



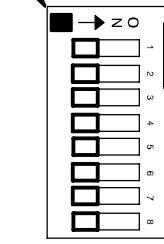

2

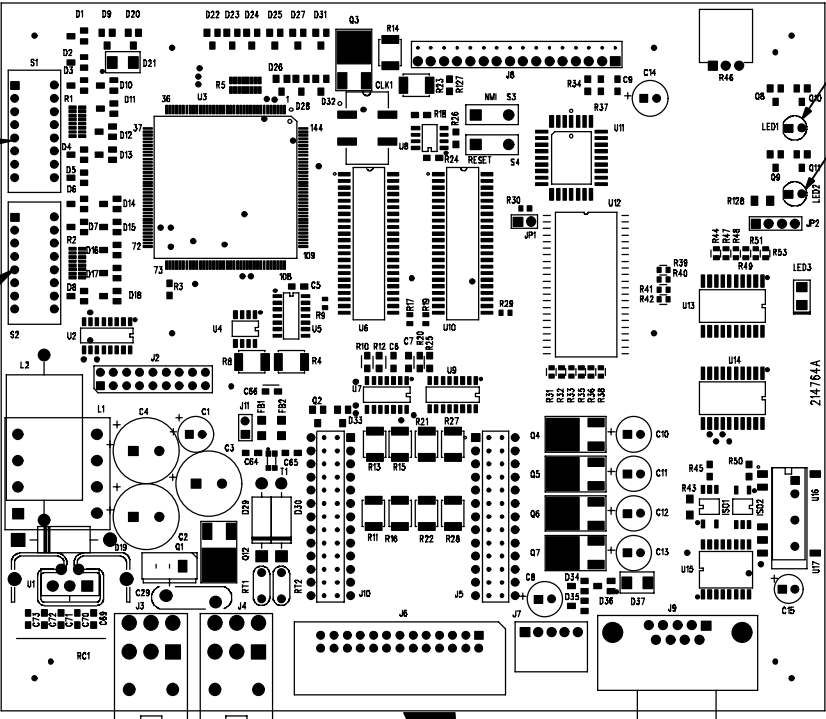

3



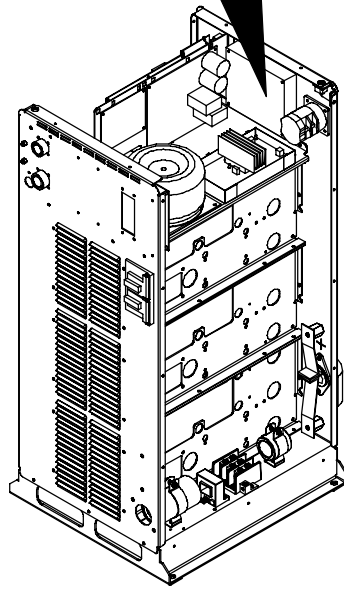

1 User Interface Module PC7
Diagnostic LED's are visible inside unit, located on PC7 mounted behind the front panel.
Refer to Section 7-9 for information on diagnostic LED's.

Reinstall cover after checking diagnostic LED's.

2 Dip Switch S1

3 Dip Switch S2

Dip switches are used to identify each circuit board on the internal network. Dip switch settings are different for each circuit board. For proper operation, do not change dip settings from those shown.

218 559-A / 803 300-A

7-9. Diagnostic LED's On User Interface Module PC7

LED	Status	Diagnosis
1, 2	On	See Network Status Table in Section 7-12
	Off	See Network Status Table in Section 7-12

7-10. Automation Interface Module PC9 Diagnostic LED's

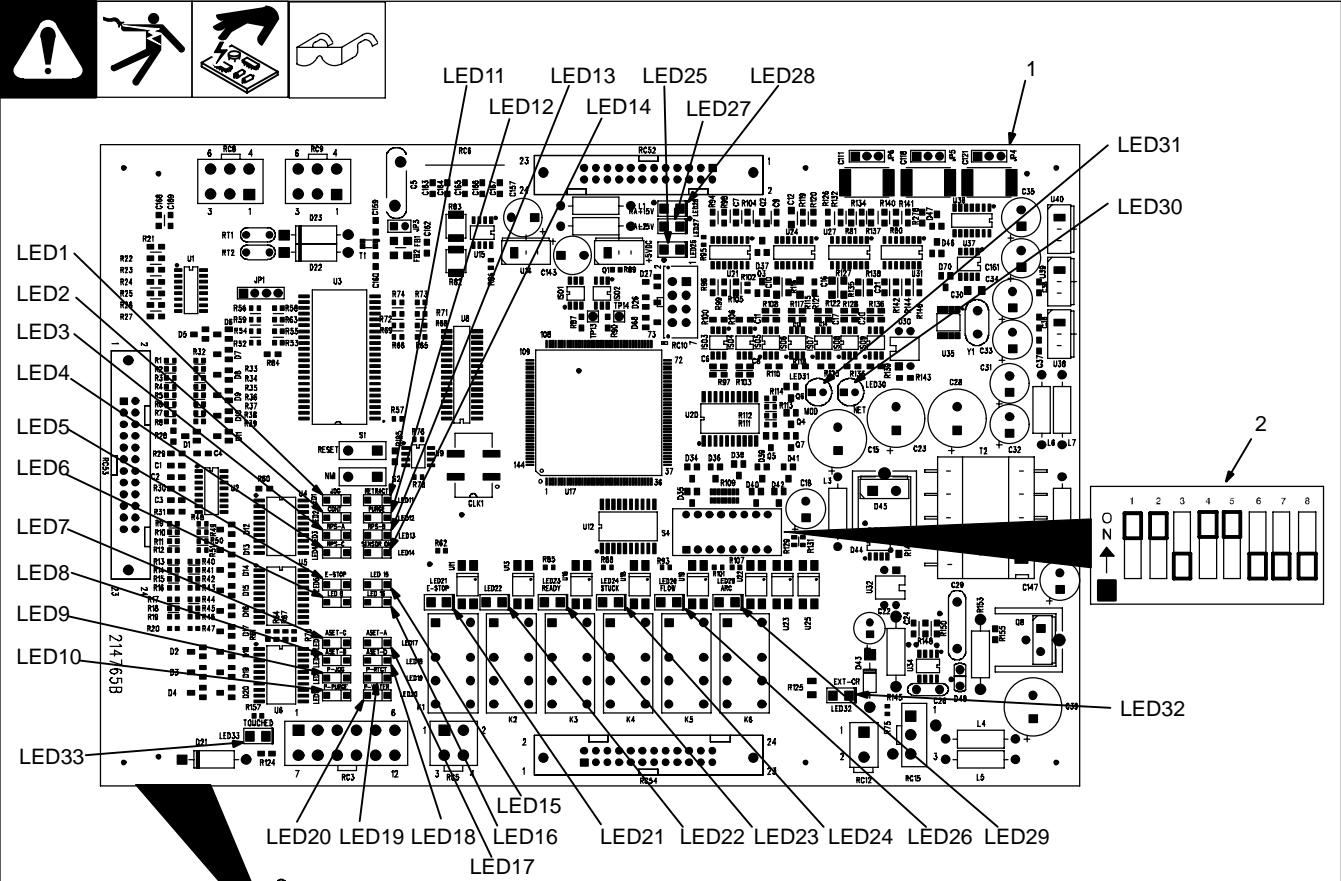

216 958-A / Ref. 803 301-B

1 Automation Interface Module PC9
Diagnostic LED's are visible inside unit,
located on PC9 mounted on left side.
Refer to Section 7-11 for information on
diagnostic LED's.

Reinstall cover after checking diagnostic
LED's.

2 Dip Switch S4

Dip switches are used to identify each
circuit board on the internal network. Dip
switch settings are different for each circuit
board. For proper operation, do not change
dip settings from those shown.

7-11. Diagnostic LED's On Automation Interface Module PC9

LED	Status	Diagnosis
1	On	Input signal On from robot for jog advance
	Off	Input signal Off from robot for no jog advance
2	On	Input signal On from robot to energize contactor
	Off	Input signal Off from robot to not energize contactor
3	On	Input signal On remote program A selected
	Off	Input signal Off remote program A not selected
4	On	Input signal On remote program C selected
	Off	Input signal Off remote program C not selected
5	On	Input signal On from E-stop board PC12 for no emergency stop
	Off	Input signal Off from E-stop board PC12 acknowledges E-stop is On from robot
6	On	Spare 1 not assigned
	Off	Spare 1 not assigned
7	On	Input signal On Autoset-C selected
	Off	Input signal Off Autoset-C not selected
8	On	Input signal On Autoset-B selected
	Off	Input signal Off Autoset-B not selected
9	On	Input signal On Remote Jog on from peripheral plug
	Off	Input signal Off Remote Jog off from peripheral plug
10	On	Input signal On Remote Purge on from peripheral plug
	Off	Input signal Off Remote Purge off from peripheral plug
11	On	Input signal On from robot for jog retract
	Off	Input signal Off from robot for no jog retract
12	On	Input signal On from robot for purge
	Off	Input signal Off from robot for no purge
13	On	Input signal On remote program B selected
	Off	Input signal Off remote program B not selected
14	On	Input signal On Touch Sensor on from robot or peripheral plug
	Off	Input signal Off Touch Sensor off from robot or peripheral plug
15	On	Spare 0 not assigned
	Off	Spare 0 not assigned
16	On	Spare 2 not assigned
	Off	Spare 2 not assigned
17	On	Input signal On Autoset-A selected
	Off	Input signal Off Autoset-A not selected
18	On	Input signal On Autoset-D selected
	Off	Input signal Off Autoset-D not selected
19	On	Input signal On Remote Retract on from peripheral plug
	Off	Input signal Off Remote Retract off from peripheral plug
20	On	Input signal On Remote Water Flow on from peripheral plug
	Off	Input signal Off Remote Water Flow off from peripheral plug
21	On	Input signal On from robot for no emergency stop
	Off	Input signal Off from robot for emergency stop
23	On	Input signal On from relay K3 for welding power source ready and no detected errors present
	Off	Input signal Off from relay K3 for welding power source not ready, detected errors are present, or unit is in operating mode preventing the weld ready signal from being enabled

LED	Status	Diagnosis
24	On	Input signal On from relay K4 to indicated wire stuck in weld joint
	Off	Input signal Off from relay K4 to indicate wire is not stuck in weld joint
25	On	Indicates +5 volts dc is present on automation interface module PC9
	Off	Indicates +5 volts dc is not present on automation interface module PC9
26	On	Input signal on from relay K5 for flow (shielding gas or coolant) present
	Off	Input signal off from relay K5 for flow (shielding gas or coolant) not present
27	On	Indicates -15 volts dc is present on automation interface module PC9
	Off	Indicates -15 volts dc is not present on automation interface module PC9
28	On	Indicates +15 volts dc is present on automation interface module PC9
	Off	Indicates +15 volts dc is not present on automation interface module PC9
29	On	Input signal on from relay K6 for arc detected
	Off	Input signal off from relay K6 for no arc detected
30, 31	On	See Network Status Table in Section 7-12
	Off	See Network Status Table in Section 7-12
32	On	Input signal on for aux. relay energized
	Off	Input signal off for aux. relay energized
33	On	Input signal on touch sensor touch detected
	Off	Input signal off touch sensor touch not detected

7-12. Network And Module Status LED's

A. Network Status LED's

The following are network status LED's:

LED1 on the UIM circuit board

LED4 on the WFM and PCM circuit boards

LED30 on the AIM circuit board.

Status	Diagnosis
Off	The circuit board is not on-line with the network or there is no power applied to the circuit board.
Green	The circuit board is operating normally and the on-line connection is made with the network.
Flashing Green	The circuit board is wait for an on-line connection to be made with the network.
Red	The circuit board has encountered a communication link failure with the network. Check DeviceNet cable connections. Verify dip switch positions according to Sections 1-2 and 1-3. Replace circuit board if necessary.

B. Module Status LED's

The following are module status LED's:

LED2 on the UIM circuit board

LED3 on the WFM and PCM circuit boards

LED31 on the AIM circuit board.

Status	Diagnosis
Off	There is no power applied to the circuit board or the board software is not executing its functions.
Green	The circuit board is operating normally.
Flashing Red	The circuit board has encountered a recoverable fault. Wait or cycle power to clear fault.
Red	The circuit board has encountered an unrecoverable fault.

7-13. Troubleshooting

			
Trouble		Remedy	
No weld output; completely inoperative		Place line disconnect in On position (see Section 3-13).	
		Check and replace line fuse(s), if necessary, or reset circuit breaker (see Section 3-13).	
		Check for proper input power connections (see Section 3-13).	
No weld output; meter display on with no error displayed.		Check to see if the contactor indicator light is lit when contactor line is asserted on.	
Erratic or improper weld output with no errors displayed.		Use proper size and type of weld cable (see Section 3-9).	
		Check that proper program for wire size, process, and shielding gas is loaded.	
		Clean and tighten all weld connections.	
No 115 volts AC at the duplex receptacle.		Reset supplementary protector CB1 (see Section 3-7).	
Wire does not feed.		Check supplementary protector CB2 and reset if necessary (see Section 3-7).	
		Check motor control cable connections.	
Wire feeds erratically.		Readjust hub tension.	
		Readjust drive roll pressure.	
		Clean or replace dirty or worn drive rolls.	
		Remove weld spatter around the nozzle opening.	
		Replace contact tip or liner. See gun Owner's Manual.	
Wire feeds as soon as power is supplied.		Check motor control cable connections.	
		Check gun trigger. See gun Owner's Manual.	
Wire stubbing on low end using a constant current power source.		Increase output setting of the power source.	
		Check voltage sense lead connection, clean and tighten if necessary.	
Gas does not flow or does not stop flowing; wire feeds.		Check gas valve and flow meter.	
Wire burns back to gun contact tip when using electrode negative (straight polarity) process.		Check to be sure that volt sense lead is connected to the work.	

SECTION 8 - ELECTRICAL DIAGRAMS

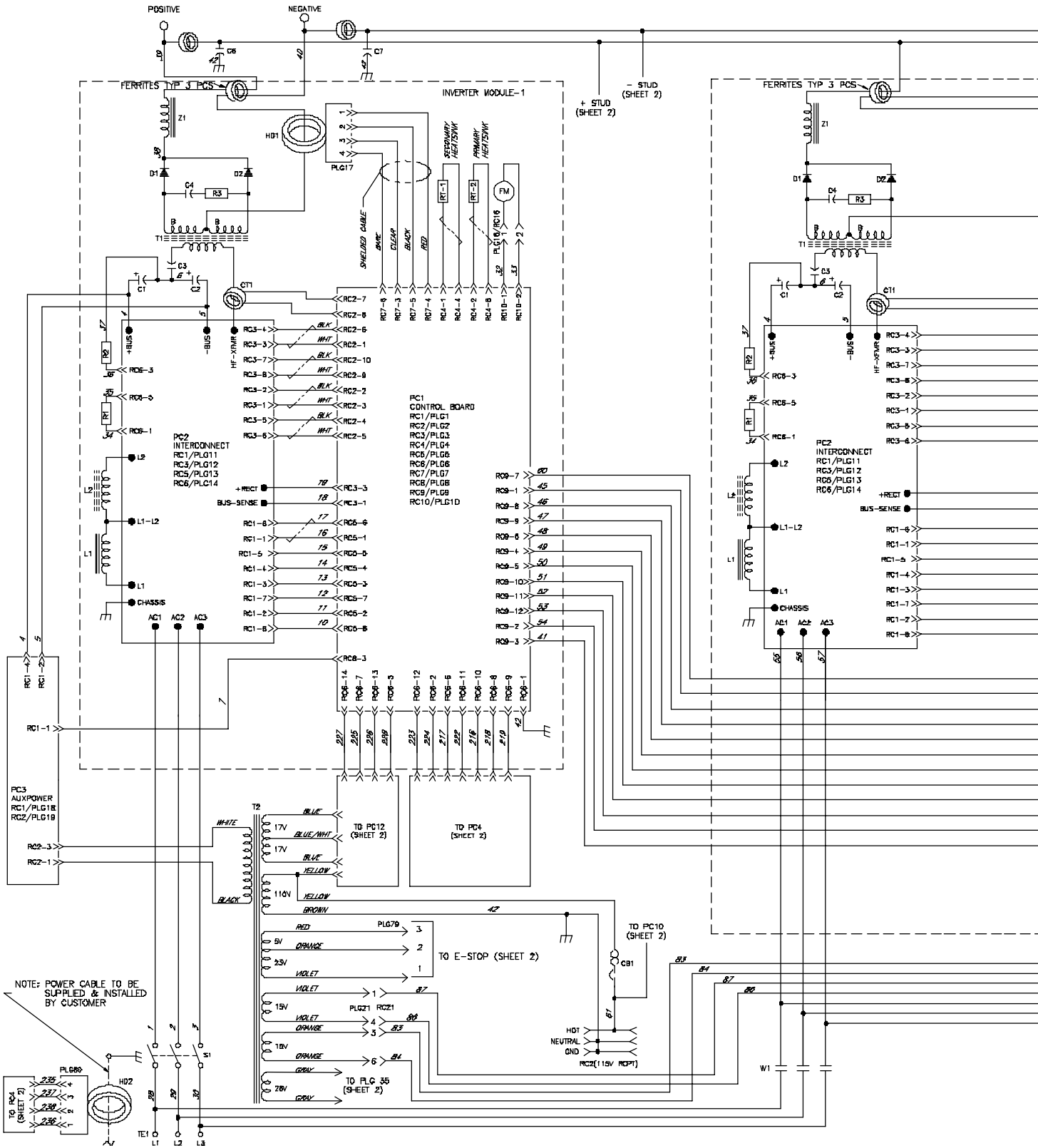



Figure 6-1. Circuit Diagram For Welding Power Source (1 Of 2)

⚠ WARNING



ELECTRIC SHOCK HAZARD

- Do not touch live electrical parts.
- Disconnect input power or stop engine before servicing.
- Do not operate with covers removed.
- Have only qualified persons install, use, or service this unit.

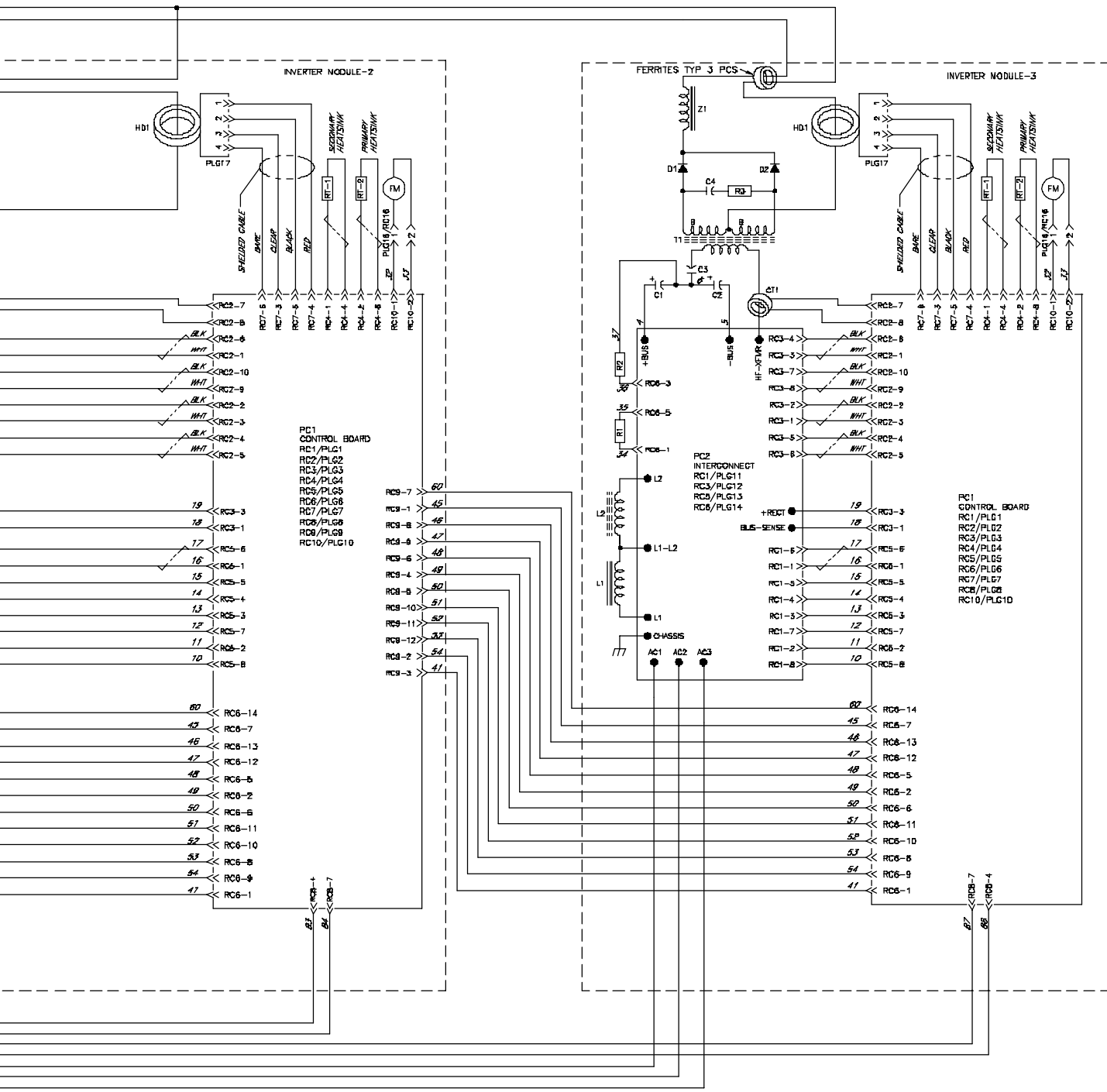

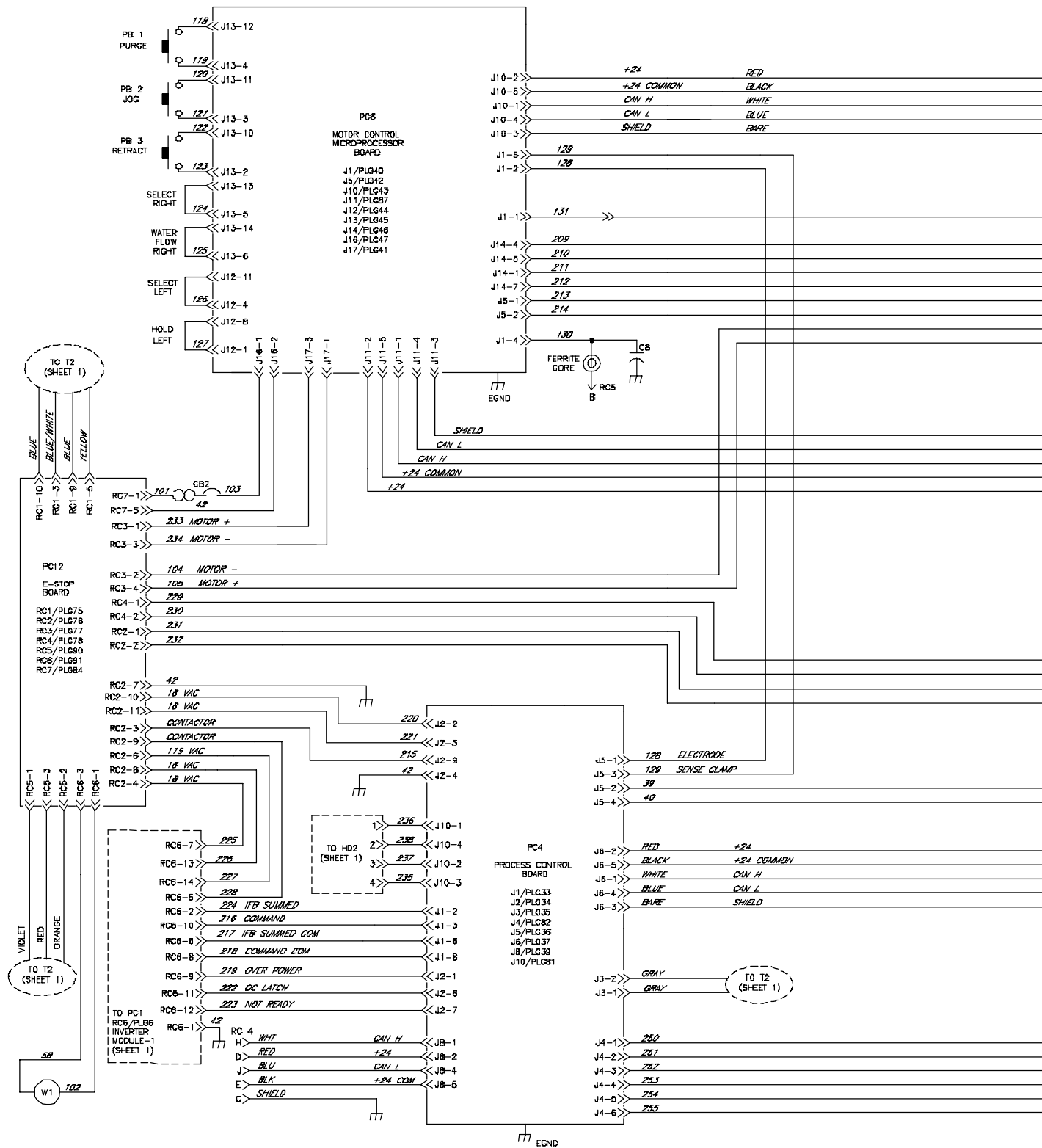
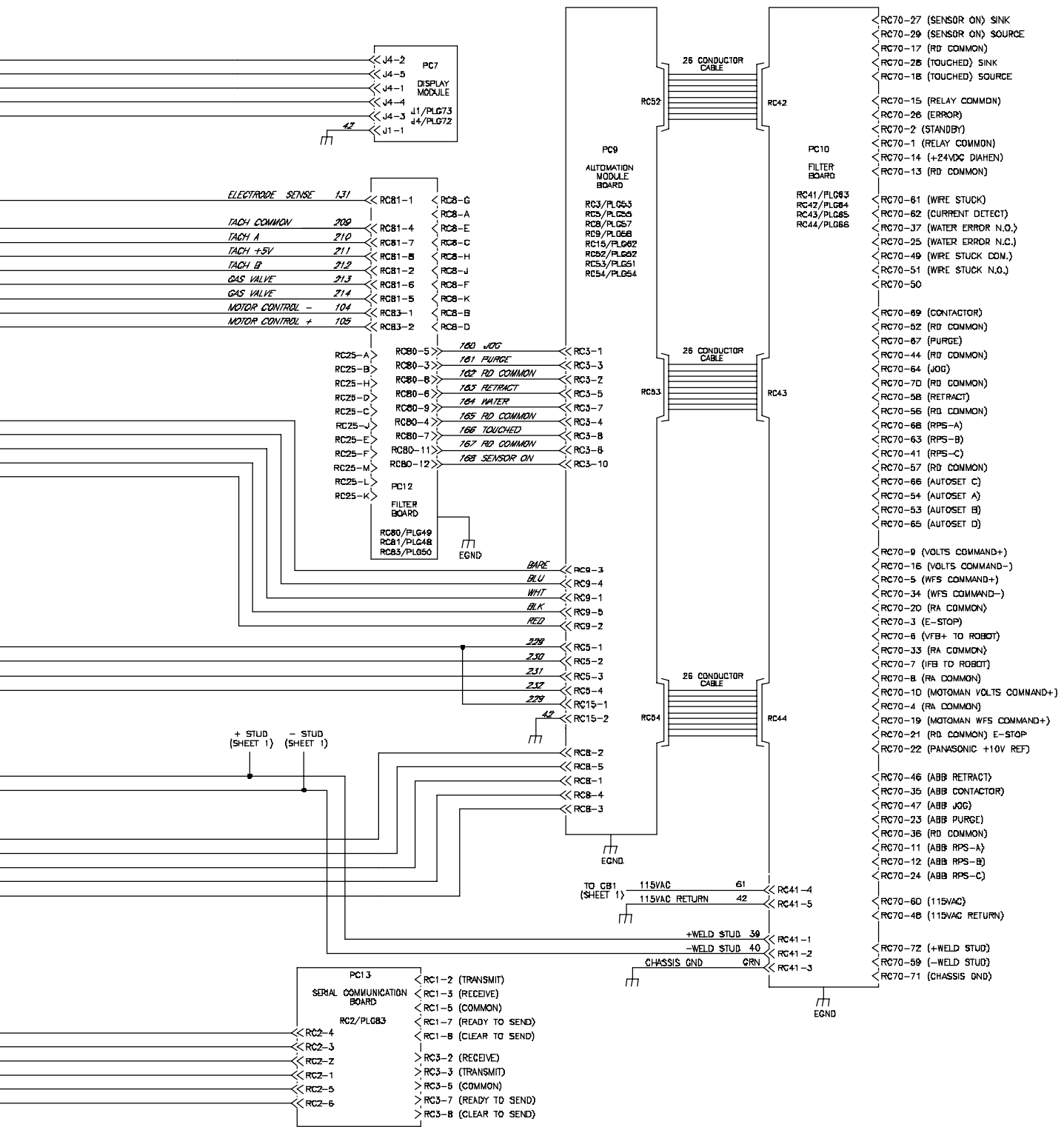

Figure 6-2. Circuit Diagram For Welding Power Source (2 Of 2)

⚠ WARNING

- Do not touch live electrical parts.
- Disconnect input power or stop engine before servicing.
- Do not operate with covers removed.
- Have only qualified persons install, use, or service this unit.

ELECTRIC SHOCK HAZARD



- < RC70-27 (SENSOR ON) SINK
- < RC70-29 (SENSOR ON) SOURCE
- < RC70-17 (RD COMMON)
- < RC70-26 (TOUCHED) SINK
- < RC70-18 (TOUCHED) SOURCE
- < RC70-15 (RELAY COMMON)
- < RC70-26 (ERROR)
- < RC70-2 (STANDBY)
- < RC70-1 (RELAY COMMON)
- < RC70-14 (+24VDC DIAHEN)
- < RC70-13 (RD COMMON)
- < RC70-61 (WIRE STUCK)
- < RC70-62 (CURRENT DETECT)
- < RC70-37 (WATER ERROR N.C.)
- < RC70-25 (WATER ERROR N.C.)
- < RC70-49 (WIRE STUCK COM.)
- < RC70-51 (WIRE STUCK N.O.)
- < RC70-50
- < RC70-69 (CONTACTOR)
- < RC70-52 (RD COMMON)
- < RC70-67 (PURGE)
- < RC70-44 (RD COMMON)
- < RC70-64 (JOG)
- < RC70-70 (RD COMMON)
- < RC70-58 (RETRACT)
- < RC70-56 (RD COMMON)
- < RC70-68 (RPS-A)
- < RC70-68 (RPS-B)
- < RC70-41 (RPS-C)
- < RC70-57 (RD COMMON)
- < RC70-66 (AUTOSET C)
- < RC70-54 (AUTOSET A)
- < RC70-53 (AUTOSET B)
- < RC70-65 (AUTOSET D)
- < RC70-9 (VOLTS COMMAND+)
- < RC70-16 (VOLTS COMMAND-)
- < RC70-5 (WFS COMMAND+)
- < RC70-34 (WFS COMMAND-)
- < RC70-20 (RA COMMON)
- < RC70-3 (E-STOP)
- < RC70-6 (VFB+ TO ROBOT)
- < RC70-33 (RA COMMON)
- < RC70-7 (IFB TO ROBOT)
- < RC70-8 (RA COMMON)
- < RC70-10 (MOTOMAN VOLTS COMMAND+)
- < RC70-4 (RA COMMON)
- < RC70-19 (MOTOMAN WFS COMMAND+)
- < RC70-21 (RD COMMON) E-STOP
- < RC70-22 (PANASONIC +10V REF)
- < RC70-46 (ABB RETRACT)
- < RC70-35 (ABB CONTACTOR)
- < RC70-47 (ABB JOG)
- < RC70-23 (ABB PURGE)
- < RC70-36 (RD COMMON)
- < RC70-11 (ABB RPS-A)
- < RC70-12 (ABB RPS-B)
- < RC70-24 (ABB RPS-C)
- < RC70-60 (115VAC)
- < RC70-48 (115VAC RETURN)
- < RC70-72 (+WELD STUD)
- < RC70-59 (-WELD STUD)
- < RC70-71 (CHASSIS GND)

TYPICAL ROBOT CONTROL

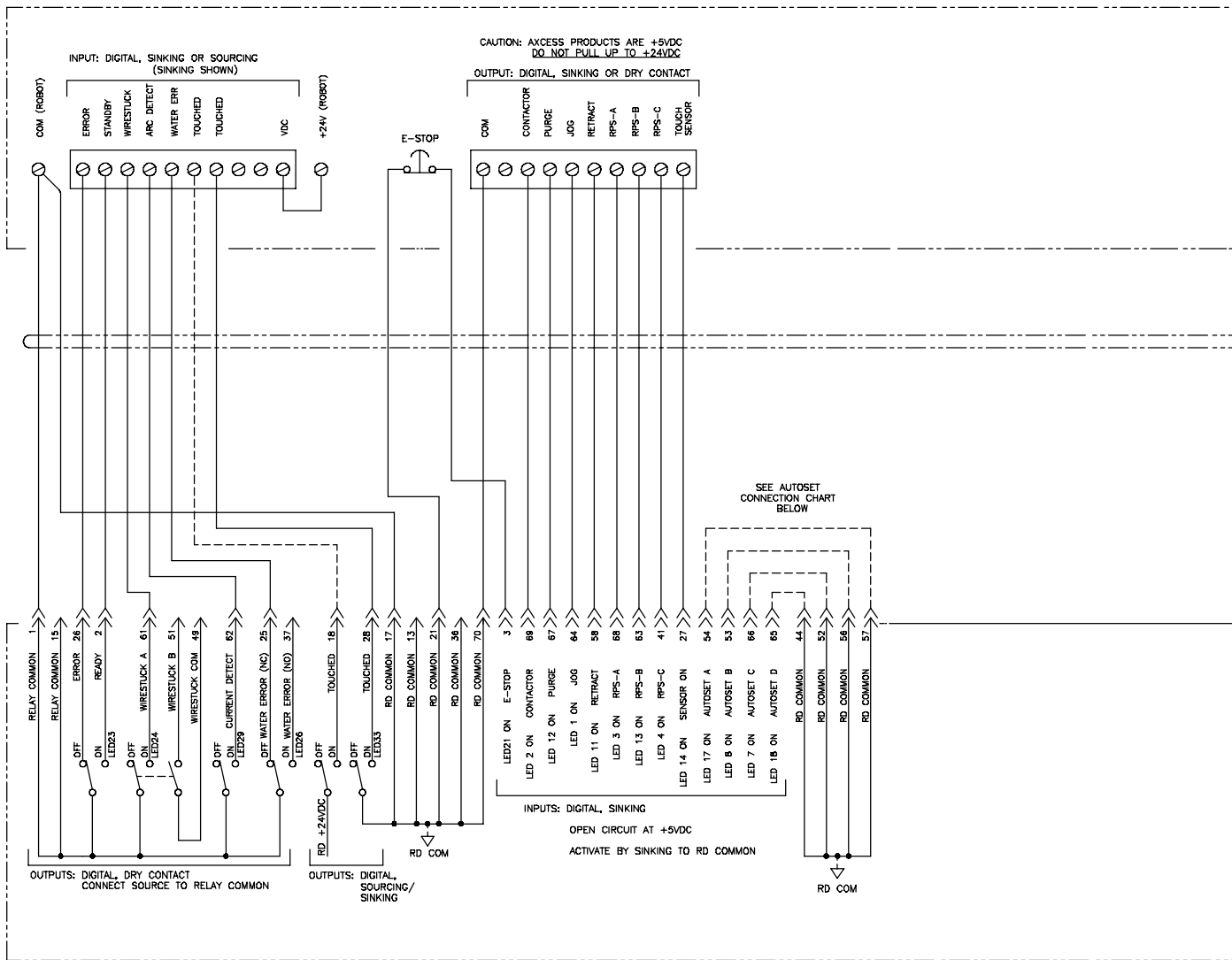

MILLER 72 PIN ROBOT INTERFACE (ACCESS)

PROGRAM SELECT CHART			
RPS PIN	68	63	41
	A	B	C
PROGRAM			
1			
2	X		
3	X		
4	X	X	
5	X		
6	X	X	
7	X	X	
8	X	X	X

X = INPUT ACTIVE

AUTOSET CONNECTION CHART									
AUTOSET PIN				AUTOSET PIN					
54	53	66	65	ROBOT TYPE	54	53	66	65	ROBOT TYPE
A	B	C	D		A	B	C	D	
X	X	X	X	KAWASAKI	X	X	X		COMAU
X	X	X	X	SPARE	X	X	X		NACHI
X	X	X	X	PANASONIC	X	X	X		HITACHI
X	X	X	X	SMIC	X	X	X		DAHEN
X	X	X	X	KUKA	X	X	X		MOTOMAN
X	X	X	X	MILACRON	X	X	X		FANUC
X	X	X	X	IGM	X	X	X		ABB
X	X	X	X	REIS					NONE

X = FIT JUMPER

Figure 6-3. Circuit Diagram For 72 Pin Robot Interface

⚠ WARNING

- Do not touch live electrical parts.
- Disconnect input power or stop engine before servicing.
- Do not operate with covers removed.
- Have only qualified persons install, use, or service this unit.

ELECTRIC SHOCK HAZARD

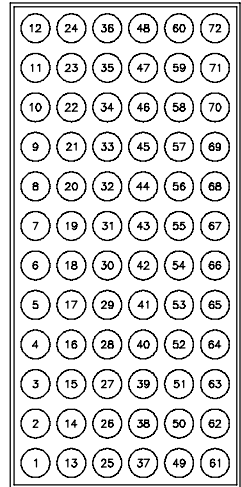
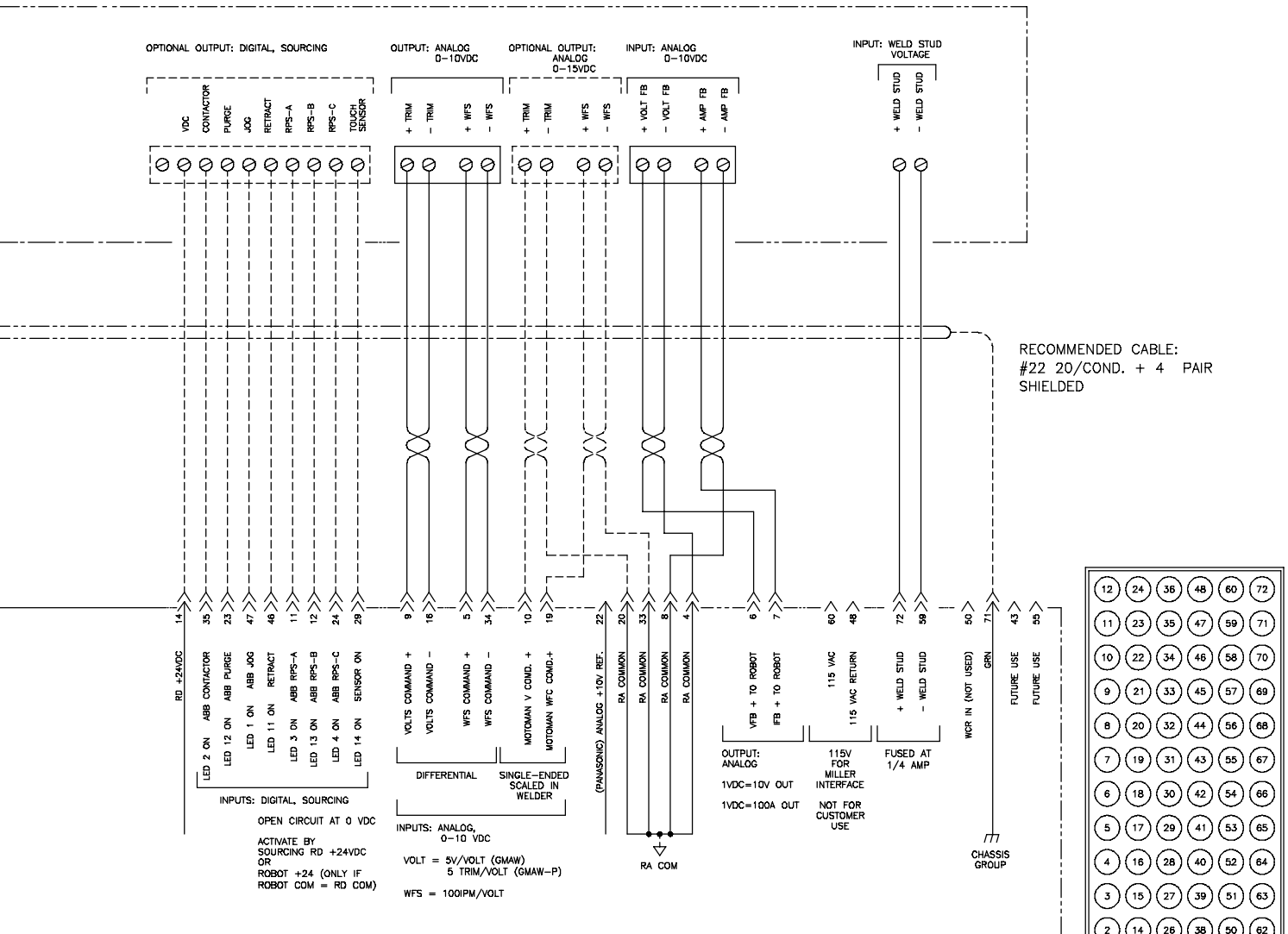

ROBOT INTERFACE PIN DETAIL
HARDING 72 PIN FEMALE
(FRONT VIEW)

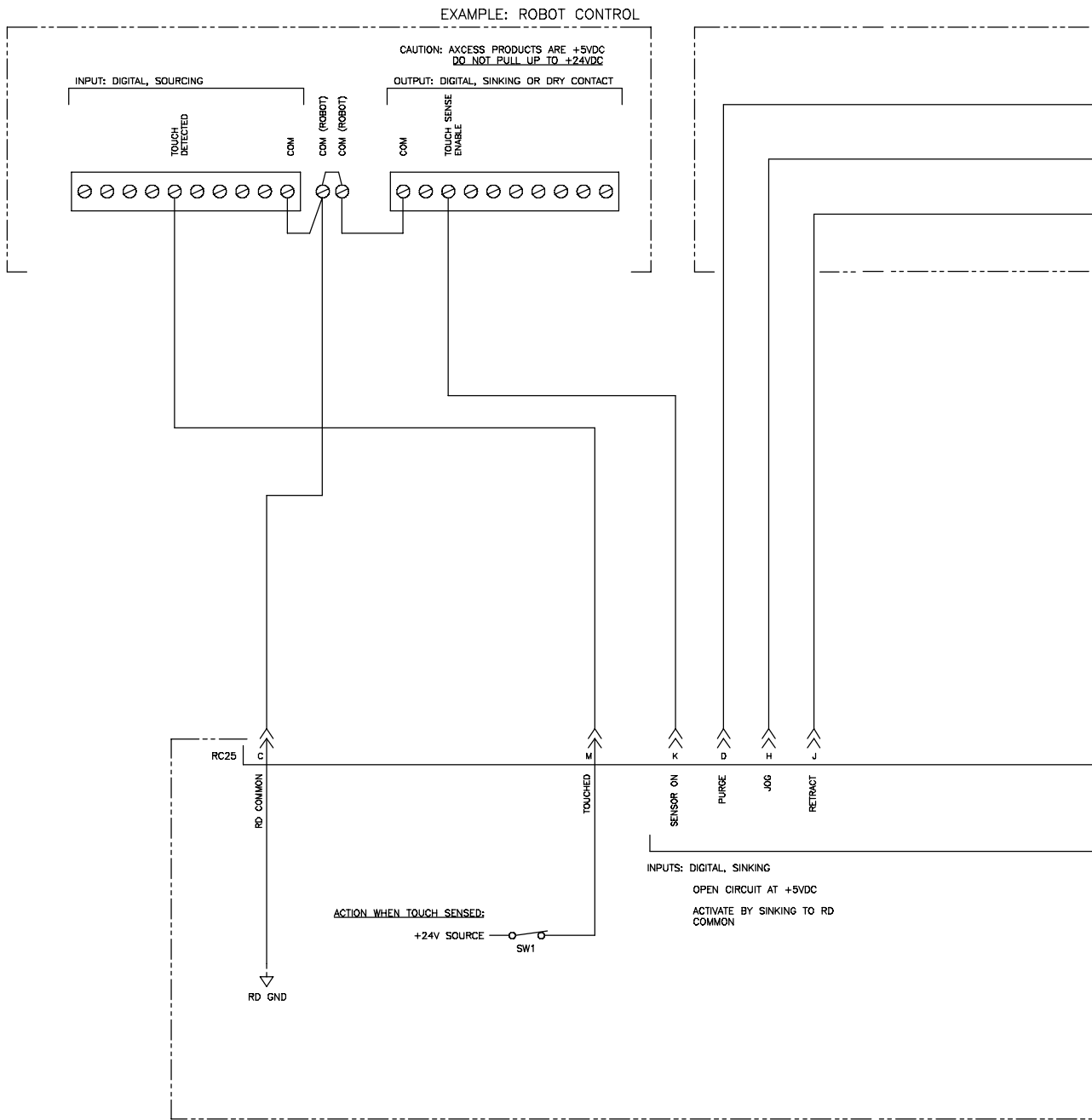

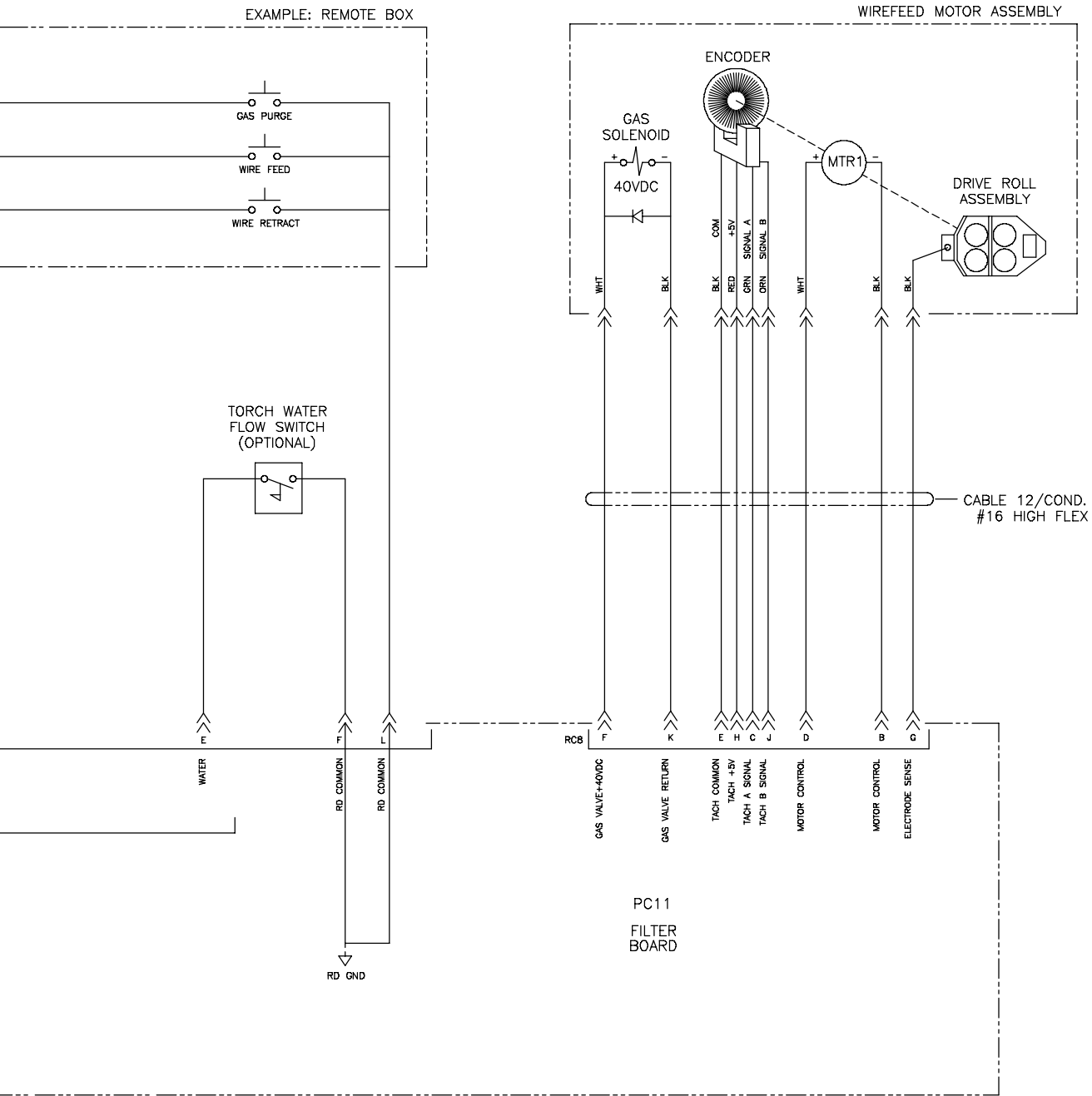



Figure 6-4. Circuit Diagram For Peripheral/Motor Interface

 ELECTRIC SHOCK HAZARD	WARNING
	<ul style="list-style-type: none"> • Do not touch live electrical parts. • Disconnect input power or stop engine before servicing. • Do not operate with covers removed. • Have only qualified persons install, use, or service this unit.



SECTION 9 – PARTS LIST

 Hardware is common and not available unless listed.

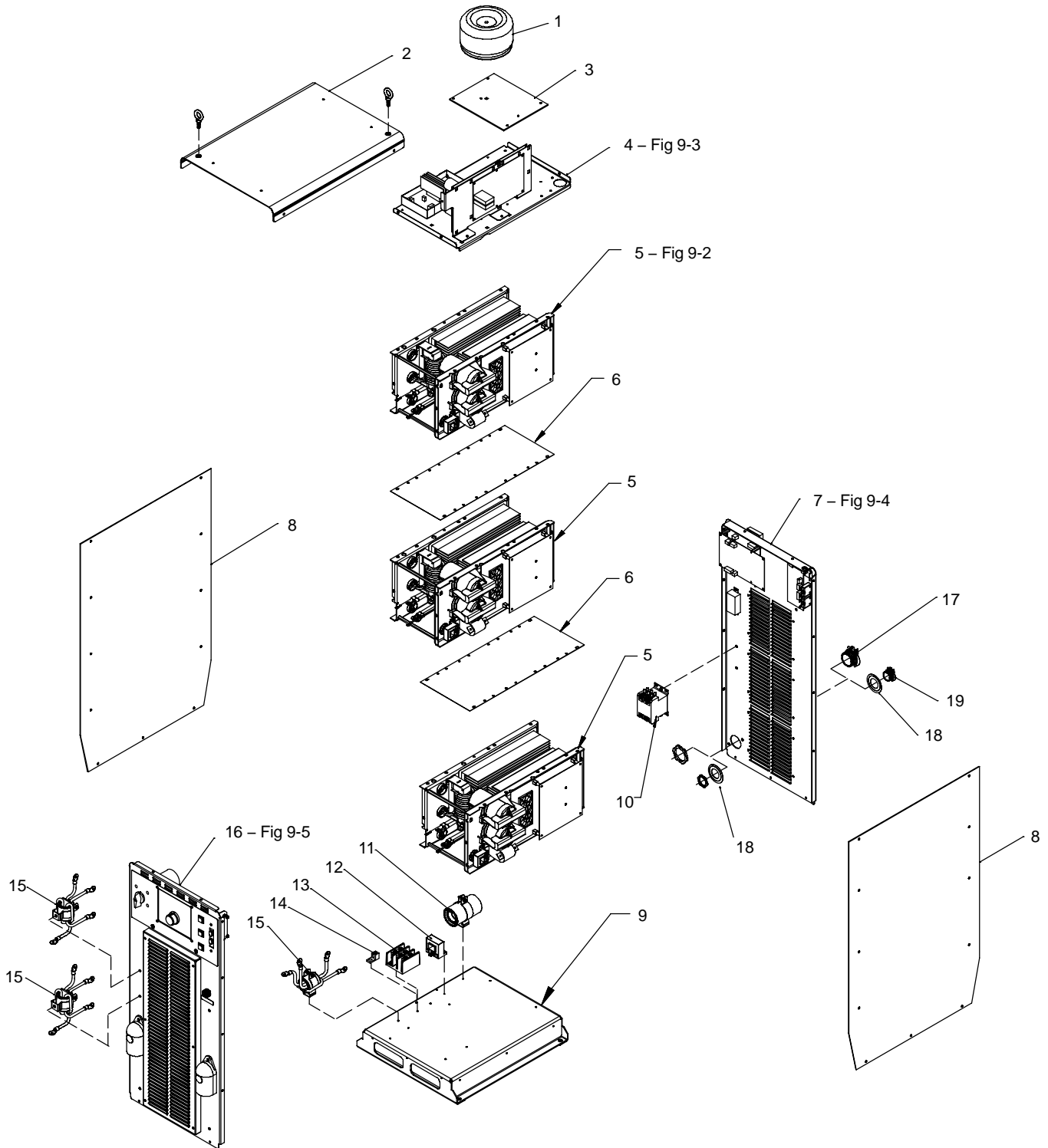

Ref. 802 919-C

Figure 9-1. Main Assembly

Item No.	Dia. Mkgs.	Part No.	Description	Quantity
----------	------------	----------	-------------	----------

Figure 9-1. Main Assembly

1	T2	212543	Xfmr, Control Toroidal 665 VAC Pri 1900 VA 60 Hz	1
2		210492	Cover, Top	1
3		210481	Plate, Mtg Toroid Xfmr	1
4		Fig 9-3	Top Tray Assembly	1
5	IM1,IM2,IM3	214597	Windtunnel, LH w/Components (Fig 9-2)	3
		222958	Windtunnel, RH w/Components (Fig 9-2)	3
6		198961	Panel, Module Divider	2
7		Fig 9-4	Rear Panel Assembly	1
8		227791	Panel, Side W/Insulator	2
9		210482	Base	1
10	W1	160793	Contactora, DEF PRP 60A 3P 24VAC Coil W/Boxlug	1
11		213386	Assembly, Filter (Primary)	1
12	HD2	182918	Transducer, Current 400A Module Supply V +/- 15V	1
13		198951	Block, Terminal 3 Pole	1
14		148025	Lug, Univ W/SCR 600V 2/0-6 Wire .266 Stud	1
15		218356	Filter Assy, Secondary	3
16		Fig 9-5	Front Panel Assembly	1
		227855	Kit, Connectors W/Washer For Power Cables (Includes)	1
17		010467	Connector, Clamp Cable 1.250	1
18		225840	Washer, Reducer 1.25 in - 0.75 in	2
19		010916	Connector, Clamp Cable 0.750	1

*Recommended Spare Parts.

+When ordering a component originally displaying a precautionary label, the label should also be ordered.

To maintain the factory original performance of your equipment, use only Manufacturer's Suggested Replacement Parts. Model and serial number required when ordering parts from your local distributor.

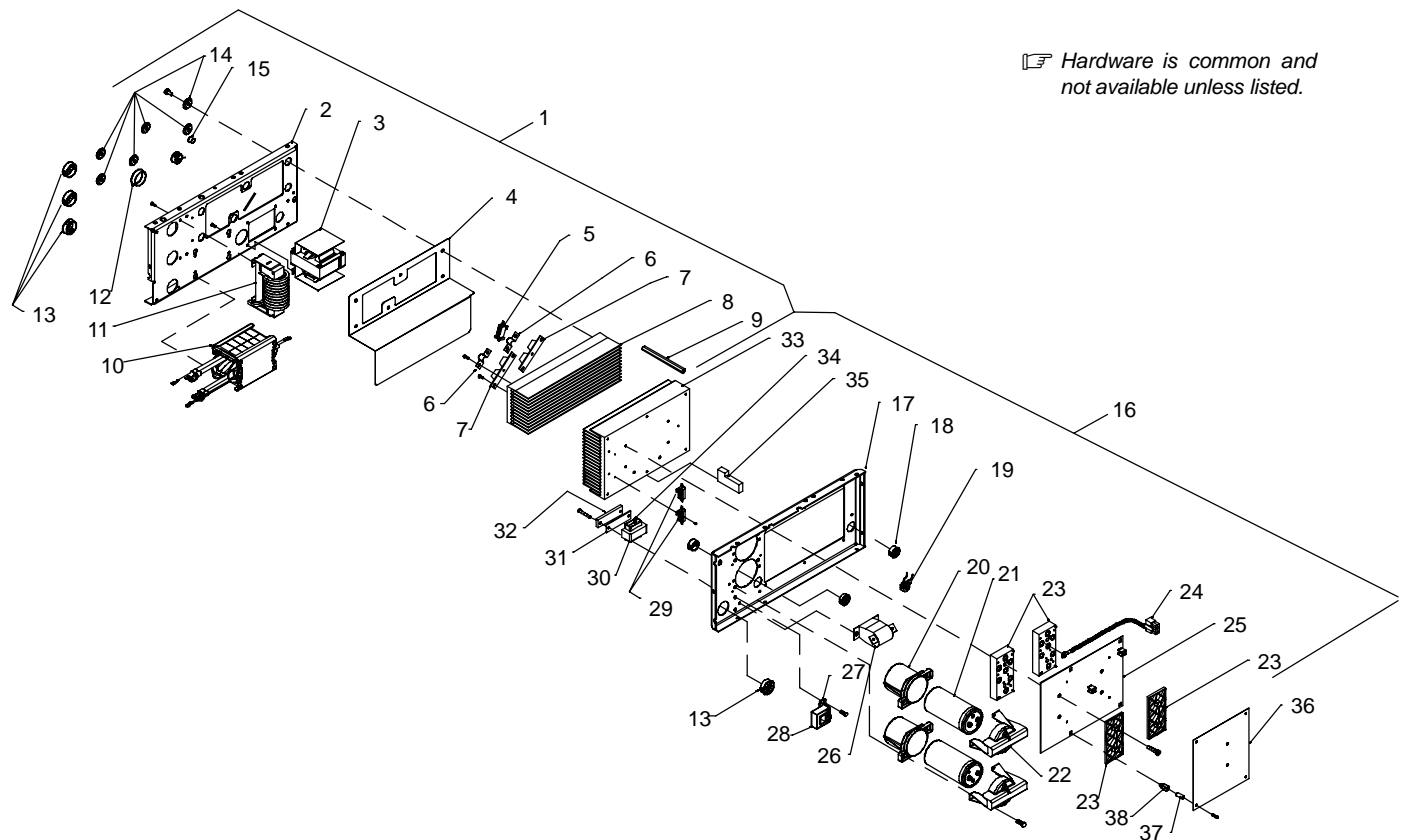

Figure 9-2. Windtunnel Assembly LH And RH

802 955-A

Item No.	Dia. Mkgs.	Part No.	Description	Quantity
Figure 9-2. Windtunnel Assembly LH And RH (Fig 9-1 Item 6)				
1		214597	Windtunnel, LH w/Components (including)	1
2		196351	Windtunnel, LH	1
3	L1	213940	Inductor, Input	1
4		214519	Insulator, Heat Sink Rectifier	1
5	R3, C4	233052	Resistor/Capacitor	1
6		199840	Bus Bar, Diode	2
7	D1, D2	201531	Kit, Diode Power Module	2
8		196347	Heat Sink, Rectifier	1
9		196349	Spacer, Windtunnel	3
10	T1	203408	Xfmr, HF Litz/Litz	1
11	Z1	220496	Output Inductor Assy	1
12		170647	Bushing, Snap-in Nyl 1.312 Id X 1.500 Mtg Hole	2
13		179276	Bushing, Snap-in Nyl 1.000 Id X 1.375 Mtg Hole Cent	4
14		196355	Insulator, Screw	6
15		010546	Bushing, Snap-in Nyl .375 Id X .500 Mtg Hole	1
16		222958	Windtunnel, RH w/Components (including)	1
17		196332	Windtunnel, RH	1
18		030170	Bushing, Snap-in Nyl .750 Id X 1.000 Mtg Hole Cent	2
19		196259	Plugs, w/Leads & Current Xfmr (including)	1
		115092	Housing, Plug & Skts	1
		115091	Housing, Plug & Skts	1
	CT1	196231	Xfmr, Current Sensing 200/1	1
20		201695	Clamp, Capacitor (Bottom)	2
21	C1, C2	226081	Capacitor, Elctlt 2400 Uf 500 Vdc Can 2.50 Dia	2
22		210507	Clamp, Capacitor (Top) Machined	2
23		217625	Kit, Input/Pre-regulator And Inverter Module	1
24	RT1, RT2	214015	Thermistor, NTC 30K Ohm @ 25 Deg C 7&18in Lead	1
25	PC2	222661	Circuit Card Assy, Power Interconnect	1
26	C3	196143	Capacitor, Polyp Met Film 16. Uf 400 VAC 10%	1
27		196378	Bracket, Mtg Current Xfmr	1
28	HD1	182918	Transducer, Current 400A Module Supply V +/- 15v	1
		196384	Cable, Transducer 20in	1
29	R1, R2	196343	Resistors, W/Leads & Plug	1
		196840	Insulator, Resistors/Interface Board	1
30		109056	Core, Ferrite E 2.164 Lg X 1.094 High X .826 Wide	1
31		196514	Gasket, Inductor Mounting	2
32		196512	Bracket, Inductor Mounting	2
33		196330	Heat Sink, Power Module	1
34	L2	196345	Coil, Inductor (Pre-regulator)	1
35		196588	Baffle, Foam Rubber (Lower)	1
		196365	Plugs, w/Leads (Fan)	1
		199136	Plugs, w/Leads (PC2 To PC1)	1
36	PC1	214523	Circuit Card Assy, Control (Inverter 300A)	1
37		204846	Insulator, Screw	4
38		083147	Grommet, Scr No 8/10 Panel Hole .312 Sq .500 High	4

*Recommended Spare Parts.

+When ordering a component originally displaying a precautionary label, the label should also be ordered.

To maintain the factory original performance of your equipment, use only Manufacturer's Suggested Replacement Parts. Model and serial number required when ordering parts from your local distributor.

 Hardware is common and not available unless listed.

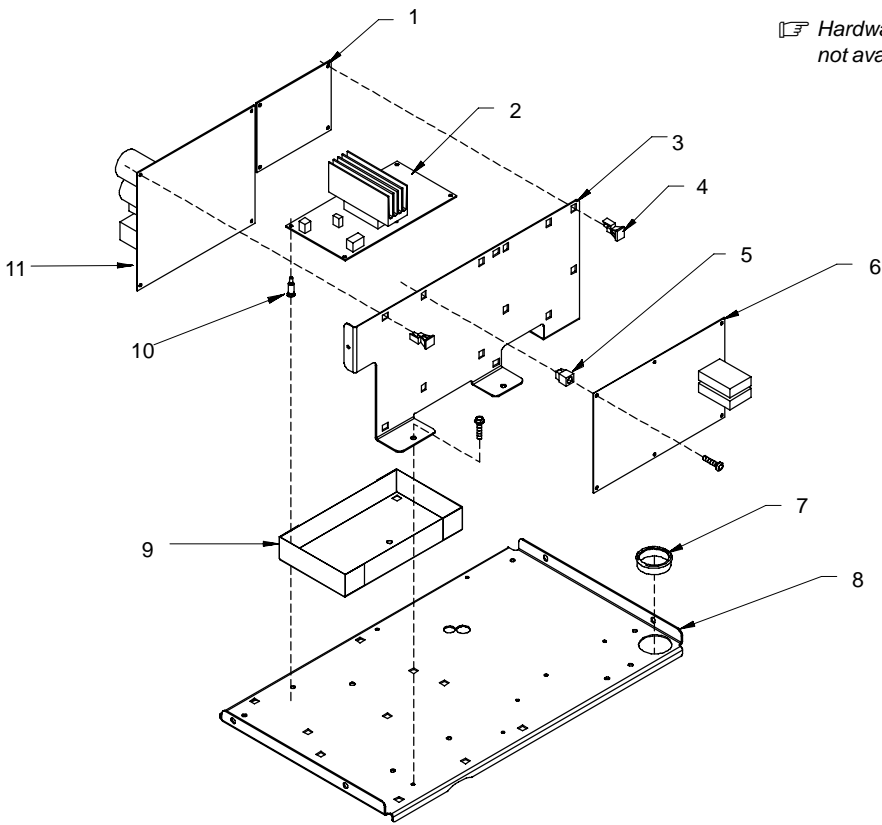

802 916-B

Figure 9-3. Top Tray Assembly

Item No.	Dia. Mkgs.	Part No.	Description	Quantity
----------	------------	----------	-------------	----------

Figure 9-3. Top Tray Assembly (Fig 9-1 Item 4)

...	1	PC12	209676	Circuit Card Assy, E-stop	1
...	2	PC3	231928	Circuit Card Assy, Aux Power	1
...	3		210490	Bracket, Mtg PC Card	1
...	4		134201	Stand-Off, PC Card .312/.375/Post&Lock .43	4
...	5		083147	Grommet, SCR No 8/10 Panel Hole .312 Sq .500 High	24
...	6	PC4	221277	Process Control Module	1
...	7		170647	Bushing, Snap-in Nyl 1.312 Id X 1.500 Mtg Hole	1
...	8		210491	Tray, Mtg PC Card	1
...	9		223439	Insulator, Circuit Card (Aux Power)	1
...	10		198122	Stand-Off Support, PC Card .250 w/Post&Lock .500	1
...	11	PC6	221280	Wire Feed Module	1

*Recommended Spare Parts.

+When ordering a component originally displaying a precautionary label, the label should also be ordered.

To maintain the factory original performance of your equipment, use only Manufacturer's Suggested Replacement Parts. Model and serial number required when ordering parts from your local distributor.

☞ Hardware is common and not available unless listed.

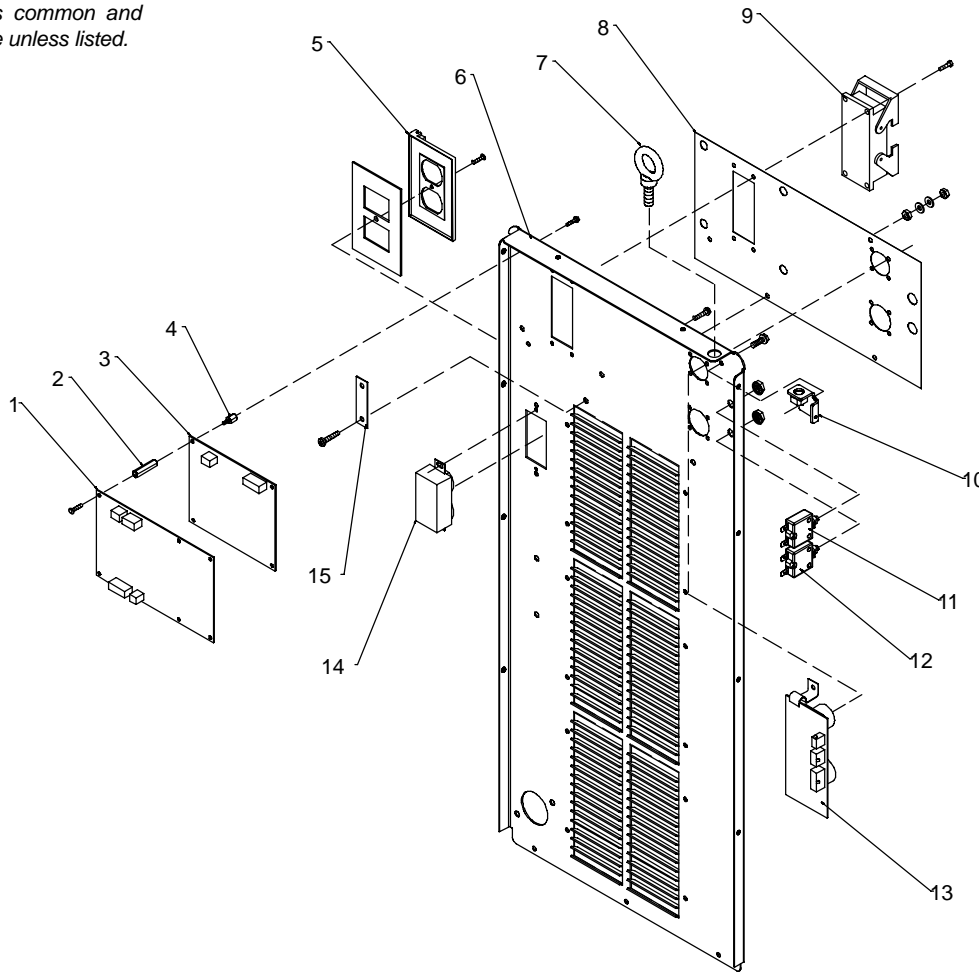

802 917-B

Figure 9-4. Rear Panel Assembly

Item No.	Dia. Mkgs.	Part No.	Description	Quantity
----------	------------	----------	-------------	----------

Figure 9-4. Rear Panel Assembly

...	1	PC9	221279	Automation Interface Module	1
...	2		199297	Stand-off, no 6-32 & no 8-32 x 2.50 lg .312 hex alm/m	4
...	3	PC10	214855	Circuit Card Assy, Robot Interface Filter HF	1
...	4		199295	Stand-off, no 8-32 x .500 lg .312 hex al m&f	4
...	5		217297	Cover, Receptacle Weatherproof Duplex Rcpt	1
...	6		210471	Panel, Rear	1
...	7		210358	Bolt, eye shld thd stem .500-13 X 1.500	1
...	8		210 505	Nameplate, Rear	1
...	9		201058	Connector, Rect 72 Pin Assy	1
...	10		210483	Bracket, lift eye	1
...	11	CB1	083432	Supplementary Protector, Man Reset 1P 10A 250VAC Frict	1
...	12	CB2	093995	Supplementary Protector, Man Reset 1P 15A 250VAC Frict	1
...	13	PC11	216213	Circuit Card Assy, Motor Filter HF	1
...	14	RC2	604176	Receptacle, w/Leads (115V Duplex)	1
...	15		216596	Strap, Grounding 4.50 in long	1

*Recommended Spare Parts.

+When ordering a component originally displaying a precautionary label, the label should also be ordered.

To maintain the factory original performance of your equipment, use only Manufacturer's Suggested Replacement Parts. Model and serial number required when ordering parts from your local distributor.

 Hardware is common and not available unless listed.

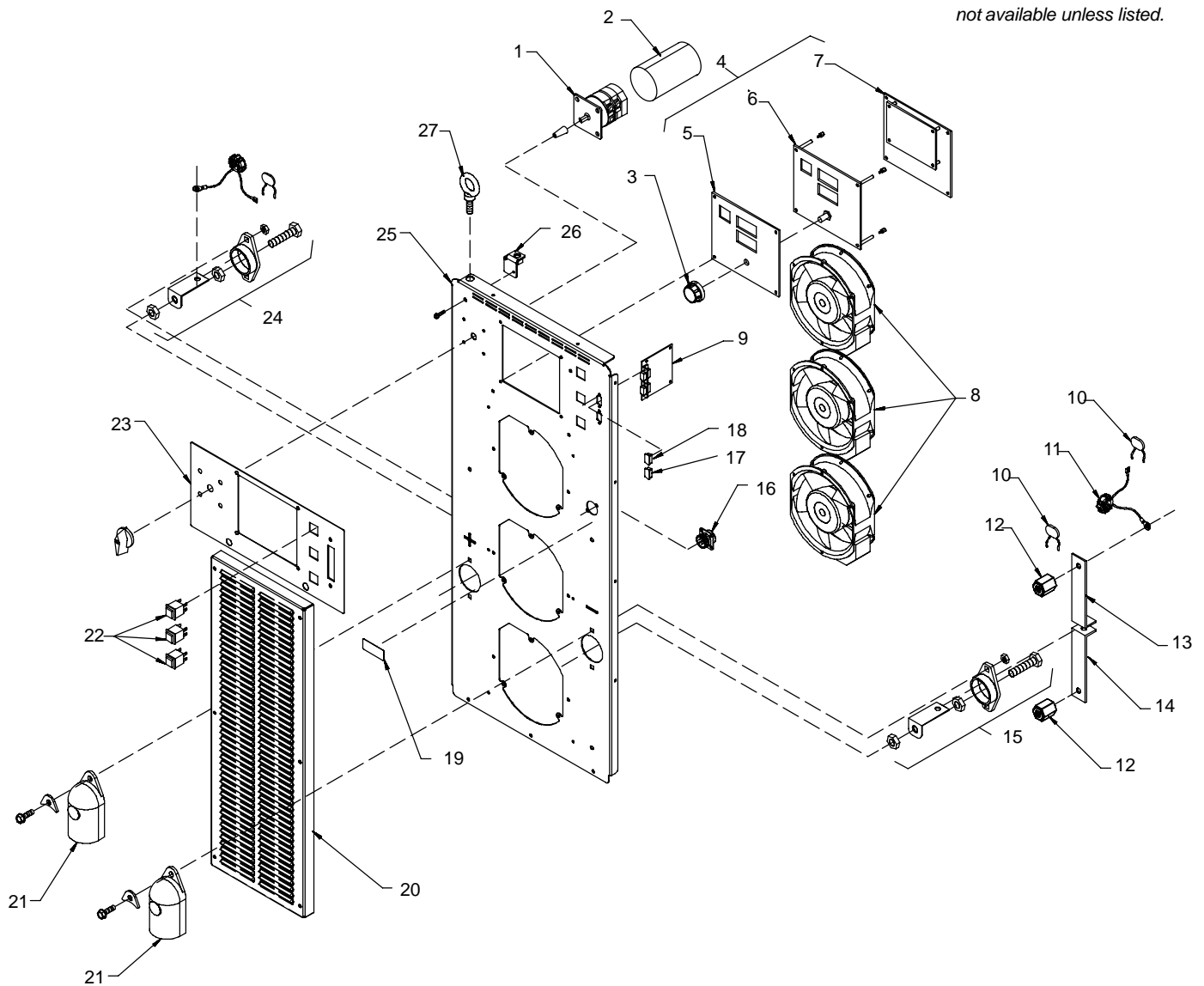

Figure 9-5. Front Panel Assembly

Ref. 802 918-B

Item No.	Dia. Mkgs.	Part No.	Description	Quantity
----------	------------	----------	-------------	----------

Figure 9-5. Front Panel Assembly

...	1	S1	207456	Switch Assy, Rotary 2 Posn 1P 40A 600VAC PNLMTG 90Deg	1
...	2		207895	Insulator,Switch Power	1
...	3		179851	Knob, Pointer 1.670 Dia X .250 Id Push On W/Spring	1
...	4		204393	Panel, PC Card Front (including)	1
...			204394	Panel, PC Card Switch/Overlay (including)	1
...	5		200410	Nameplate, Overlay	1
...	6	PC20	227879	Circuit Card Assy, Switches	1
...	7	PC7	221278	User Interface Module	1
...			200416	Circuit Card Assy, Display	1
...			199376	Circuit Card Assy, User Interface	1
...	8	FM	196313	Fan, Muffin 115V 50/60 Hz 3000 Rpm 6.378 Mtg Holes	3
...	9	PC13	208071	Circuit Card Assy,ISO/COMM	1
...	10	C6, C7, C8	206878	Capacitor Assy	3
...	11		213102	Choke, Common Mode w/Leads	2
...	12		025248	Stand-off, Insul .250-20 X 1.250 Lg X .437 Thd	3

Item No.	Dia. Mkgs.	Part No.	Description	Quantity
Figure 9-5. Front Panel Assembly (Continued)				
... 13		220815	Bus Bar, Output	1
... 14		210864	Bus Bar, Output	1
... 15		210866	Terminal, pwr output black	1
... 16	RC5	214664	Receptacle, Common Mode Choke	1
... 17		216966	Cover, Connector D-sub 9 pin Male w/Chain	1
... 18		216965	Cover, Connector D-sub 9 skt Female w/Chain	1
... 19		219843	Label, Volt Sense	1
... 20		207896	Box, Louver	1
... 21		186621	Boot, Generic	2
... 22	PB1, PB2, PB3	199443	Switch, Pb Mc No Spst 10A 115VAC w/Blk Cap Panelmt	3
... 23		212780	Nameplate, Front	1
... 24		210865	Terminal, pwr output red	1
... 25		210469	Panel, Front	1
... 26		210483	Bracket, lift eye	1
... 27		210358	Bolt, eye shld thd stem .500-13 X 1.500	1

*Recommended Spare Parts.

+When ordering a component originally displaying a precautionary label, the label should also be ordered.

To maintain the factory original performance of your equipment, use only Manufacturer's Suggested Replacement Parts. Model and serial number required when ordering parts from your local distributor.

TRUE BLUE[®]

WARRANTY

Effective January 1, 2007

(Equipment with a serial number preface of "LH" or newer)

This limited warranty supersedes all previous Miller warranties and is exclusive with no other guarantees or warranties expressed or implied.

LIMITED WARRANTY – Subject to the terms and conditions below, Miller Electric Mfg. Co., Appleton, Wisconsin, warrants to its original retail purchaser that new Miller equipment sold after the effective date of this limited warranty is free of defects in material and workmanship at the time it is shipped by Miller. THIS WARRANTY IS EXPRESSLY IN LIEU OF ALL OTHER WARRANTIES, EXPRESS OR IMPLIED, INCLUDING THE WARRANTIES OF MERCHANTABILITY AND FITNESS.

Within the warranty periods listed below, Miller will repair or replace any warranted parts or components that fail due to such defects in material or workmanship. Miller must be notified in writing within thirty (30) days of such defect or failure, at which time Miller will provide instructions on the warranty claim procedures to be followed.

Miller shall honor warranty claims on warranted equipment listed below in the event of such a failure within the warranty time periods. All warranty time periods start on the delivery date of the equipment to the original end-user purchaser, and not to exceed one year after the equipment is shipped to a North American distributor or eighteen months after the equipment is shipped to an International distributor.

1. 5 Years Parts — 3 Years Labor
 - * Original main power rectifiers
2. 3 Years — Parts and Labor
 - * Transformer/Rectifier Power Sources
 - * Plasma Arc Cutting Power Sources
 - * Process Controllers
 - * Semi-Automatic and Automatic Wire Feeders
 - * Inverter Power Sources (Unless Otherwise Stated)
 - * Water Coolant Systems (Integrated)
 - * Intelligit
 - * Engine Driven Welding Generators
(NOTE: Engines are warranted separately by the engine manufacturer.)
3. 1 Year — Parts and Labor Unless Specified
 - * Motor Driven Guns (w/exception of Spoolmate Spoolguns)
 - * Positioners and Controllers
 - * Automatic Motion Devices
 - * RFCS Foot Controls
 - * Induction Heating Power Sources, Coolers, and Electronic Controls/Recorders
 - * Water Coolant Systems (Non-Integrated)
 - * Flowgauge and Flowmeter Regulators (No Labor)
 - * HF Units
 - * Grids
 - * Spot Welders
 - * Load Banks
 - * Arc Stud Power Sources & Arc Stud Guns
 - * Racks
 - * Running Gear/Trailers
 - * Plasma Cutting Torches (except APT & SAF Models)
 - * Field Options
(NOTE: Field options are covered under True Blue[®] for the remaining warranty period of the product they are installed in, or for a minimum of one year — whichever is greater.)
 - * Bernard-Branded Mig Guns (No Labor)
 - * Weldcraft-Branded TIG Torches (No Labor)
 - * Subarc Wire Drive Assemblies
4. 6 Months — Batteries
5. 90 Days — Parts
 - * MIG Guns/TIG Torches and Subarc (SAW) Guns

- * Induction Heating Coils and Blankets, Cables, and Non-Electronic Controls
- * APT & SAF Model Plasma Cutting Torches
- * Remote Controls
- * Accessory (Kits)
- * Replacement Parts (No labor)
- * Spoolmate Spoolguns
- * Canvas Covers

Miller's True Blue[®] Limited Warranty shall not apply to:

1. **Consumable components; such as contact tips, cutting nozzles, contactors, brushes, slip rings, relays or parts that fail due to normal wear. (Exception: brushes, slip rings, and relays are covered on Bobcat, Trailblazer, and Legend models.)**
2. Items furnished by Miller, but manufactured by others, such as engines or trade accessories. These items are covered by the manufacturer's warranty, if any.
3. Equipment that has been modified by any party other than Miller, or equipment that has been improperly installed, improperly operated or misused based upon industry standards, or equipment which has not had reasonable and necessary maintenance, or equipment which has been used for operation outside of the specifications for the equipment.

MILLER PRODUCTS ARE INTENDED FOR PURCHASE AND USE BY COMMERCIAL/INDUSTRIAL USERS AND PERSONS TRAINED AND EXPERIENCED IN THE USE AND MAINTENANCE OF WELDING EQUIPMENT.

In the event of a warranty claim covered by this warranty, the exclusive remedies shall be, at Miller's option: (1) repair; or (2) replacement; or, where authorized in writing by Miller in appropriate cases, (3) the reasonable cost of repair or replacement at an authorized Miller service station; or (4) payment of or credit for the purchase price (less reasonable depreciation based upon actual use) upon return of the goods at customer's risk and expense. Miller's option of repair or replacement will be F.O.B., Factory at Appleton, Wisconsin, or F.O.B. at a Miller authorized service facility as determined by Miller. Therefore no compensation or reimbursement for transportation costs of any kind will be allowed.

TO THE EXTENT PERMITTED BY LAW, THE REMEDIES PROVIDED HEREIN ARE THE SOLE AND EXCLUSIVE REMEDIES. IN NO EVENT SHALL MILLER BE LIABLE FOR DIRECT, INDIRECT, SPECIAL, INCIDENTAL OR CONSEQUENTIAL DAMAGES (INCLUDING LOSS OF PROFIT), WHETHER BASED ON CONTRACT, TORT OR ANY OTHER LEGAL THEORY.

ANY EXPRESS WARRANTY NOT PROVIDED HEREIN AND ANY IMPLIED WARRANTY, GUARANTY OR REPRESENTATION AS TO PERFORMANCE, AND ANY REMEDY FOR BREACH OF CONTRACT TORT OR ANY OTHER LEGAL THEORY WHICH, BUT FOR THIS PROVISION, MIGHT ARISE BY IMPLICATION, OPERATION OF LAW, CUSTOM OF TRADE OR COURSE OF DEALING, INCLUDING ANY IMPLIED WARRANTY OF MERCHANTABILITY OR FITNESS FOR PARTICULAR PURPOSE, WITH RESPECT TO ANY AND ALL EQUIPMENT FURNISHED BY MILLER IS EXCLUDED AND DISCLAIMED BY MILLER.

Some states in the U.S.A. do not allow limitations of how long an implied warranty lasts, or the exclusion of incidental, indirect, special or consequential damages, so the above limitation or exclusion may not apply to you. This warranty provides specific legal rights, and other rights may be available, but may vary from state to state.

In Canada, legislation in some provinces provides for certain additional warranties or remedies other than as stated herein, and to the extent that they may not be waived, the limitations and exclusions set out above may not apply. This Limited Warranty provides specific legal rights, and other rights may be available, but may vary from province to province.

miller_warr 2007-01

Warranty Questions?

Call
1-800-4-A-MILLER
for your local
Miller distributor.

Your distributor also gives
you ...

Service

You always get the fast,
reliable response you
need. Most replacement
parts can be in your
hands in 24 hours.

Support

Need fast answers to the
tough welding questions?
Contact your distributor.
The expertise of the
distributor and Miller is
there to help you, every
step of the way.





Owner's Record

Please complete and retain with your personal records.

Model Name

Serial/Style Number

Purchase Date

(Date which equipment was delivered to original customer.)

Distributor

Address

City

State

Zip



For Service

Contact a **DISTRIBUTOR** or **SERVICE AGENCY** near you.

Always provide Model Name and Serial/Style Number.

Contact your Distributor for:

Welding Supplies and Consumables

Options and Accessories

Personal Safety Equipment

Service and Repair

Replacement Parts

Training (Schools, Videos, Books)

Technical Manuals (Servicing Information and Parts)

Circuit Diagrams

Welding Process Handbooks

To locate a Distributor or Service Agency visit www.millerwelds.com or call 1-800-4-A-Miller

Contact the Delivering Carrier to:

File a claim for loss or damage during shipment.

For assistance in filing or settling claims, contact your distributor and/or equipment manufacturer's Transportation Department.

Miller Electric Mfg. Co.

An Illinois Tool Works Company
1635 West Spencer Street
Appleton, WI 54914 USA

International Headquarters—USA

USA Phone: 920-735-4505 Auto-Attended
USA & Canada FAX: 920-735-4134
International FAX: 920-735-4125

European Headquarters – United Kingdom

Phone: 44 (0) 1204-593493
FAX: 44 (0) 1204-598066

www.MillerWelds.com



Free Manuals Download Website

<http://myh66.com>

<http://usermanuals.us>

<http://www.somanuals.com>

<http://www.4manuals.cc>

<http://www.manual-lib.com>

<http://www.404manual.com>

<http://www.luxmanual.com>

<http://aubethermostatmanual.com>

Golf course search by state

<http://golfingnear.com>

Email search by domain

<http://emailbydomain.com>

Auto manuals search

<http://auto.somanuals.com>

TV manuals search

<http://tv.somanuals.com>