



OM-203 185F

2005-09

Processes

Induction Heating

Description

Single Induction Heating Power Source
Temperature Control/Recorder

IH/TS

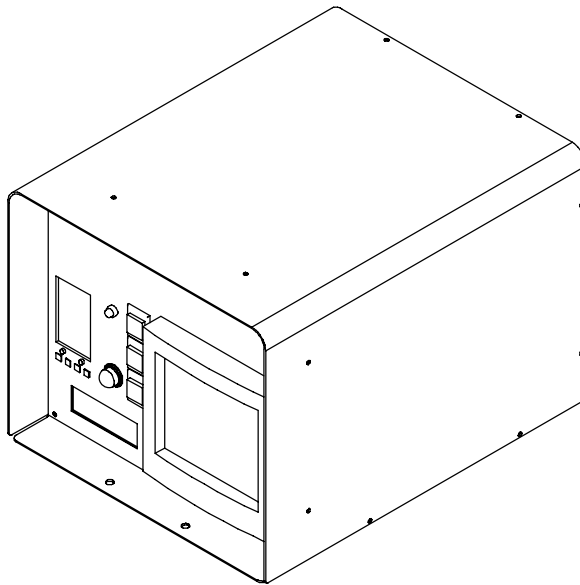

OWNER'S MANUAL

File: Induction Heating



Visit our website at
www.MillerWelds.com

From Miller to You

Thank you and congratulations on choosing Miller. Now you can get the job done and get it done right. We know you don't have time to do it any other way.

That's why when Niels Miller first started building arc welders in 1929, he made sure his products offered long-lasting value and superior quality. Like you, his customers couldn't afford anything less. Miller products had to be more than the best they could be. They had to be the best you could buy.

Today, the people that build and sell Miller products continue the tradition. They're just as committed to providing equipment and service that meets the high standards of quality and value established in 1929.

This Owner's Manual is designed to help you get the most out of your Miller products. Please take time to read the Safety precautions. They will help you protect yourself against potential hazards on the worksite.

We've made installation and operation quick and easy. With Miller you can count on years of reliable service with proper maintenance. And if for some reason the unit needs repair, there's a Troubleshooting section that will help you figure out what the problem is. The parts list will then help you to decide the exact part you may need to fix the problem. Warranty and service information for your particular model are also provided.



Miller is the first welding equipment manufacturer in the U.S.A. to be registered to the ISO 9001:2000 Quality System Standard.

Miller Electric manufactures a full line of welders and welding related equipment. For information on other quality Miller products, contact your local Miller distributor to receive the latest full line catalog or individual specification sheets. **To locate your nearest distributor or service agency call 1-800-4-A-Miller, or visit us at www.MillerWelds.com on the web.**



Working as hard as you do – every power source from Miller is backed by the most hassle-free warranty in the business.



TABLE OF CONTENTS

SECTION 1 – SAFETY PRECAUTIONS – READ BEFORE USING	1
1-1. Symbol Usage	1
1-2. Induction Heating Hazards	1
1-3. Additional Symbols for Installation, Operation, and Maintenance	2
1-4. California Proposition 65 Warnings	2
1-5. Principal Safety Standards	2
1-6. EMF Information	3
SECTION 2 – MESURES DE SECURITE POUR LE CHAUFFAGE PAR INDUCTION	4
2-1. Dangers supplémentaires de mise en route, de fonctionnement et d'entretien	5
2-2. Informations concernant les champs électro-magnétiques (Information EMF)	6
2-3. PRINCIPALES NORMES DE SÉCURITÉ	6
SECTION 3 – INTRODUCTION	7
SECTION 4 – INSTALLATION	8
4-1. Specifications	8
4-2. IH/TS Installation	8
4-3. Connecting To Power Source	9
4-4. Input 14 Pin Information For Receptacle RC1	9
4-5. Connecting 25kW System Cords And Cables	10
4-6. Connecting 5kW System Cords And Cables	11
4-7. Connecting External Device	12
SECTION 5 – COMPONENTS AND CONTROLS	13
5-1. IH/TS Front Panel	13
5-2. IH/TS Rear Panel	14
5-3. Controller	15
SECTION 6 – SETUP AND OPERATION	16
6-1. Safety Equipment	16
6-2. IH/TS Setup	16
6-2-1. Select Power Source	16
6-2-2. Time Date Setup – Digital	17
6-2-2-1. Digital Recorder Controls	17
6-2-2-2. Login As Engineer	17
6-2-2-3. Go To Operator Screen	17
6-2-2-4. Locale Setup	17
6-2-2-5. Time And Date Setup	18
6-2-2-6. Login As User	18
6-2-2-7. Go To Home Screen	18
6-2-2-8. Channel Cycling On/Off And Notes	18
6-3. Operation	19
6-3-1. 2408 Controller	20
6-3-1-1. 2408 Controller Operation	20
6-3-2. Programming The 2408 Controller	21
6-3-3. Batch Recording Using 5100 Digital Recorder	26
6-3-3-1. Login As User	26
6-3-3-2. Start Recording	26
6-3-3-3. Stop Recording	27
6-3-3-4. Saving Data To A Disk (Recommended After Each Batch)	27
6-3-3-5. Saving Data To A PC (Alternative To Floppy Disk)	27
6-3-3-5-1. Review Software – First Time Setup	27
6-3-3-5-2. Creating A Shortcut – First Time Setup	27
6-3-3-5-3. Changing IP Address To Connect The IH/TS	28
6-3-3-5-4. Downloading Files From Recorder	28
6-3-3-5-5. Troubleshooting Connection Problems	29
6-3-3-5-6. Resetting IP Address (Necessary To Connect User's PC To Company's Network)	29
6-3-4. Running A Program To Preheat Or Stress Relief	30

TABLE OF CONTENTS

6-3-5. Recovering From An Interruption	31
6-3-6. Viewing Data In Review Software	32
6-3-6-1. Installing Review Software And First Time Setup	32
6-3-6-2. Backing Up The Database	32
6-3-7. Running Review Software	33
6-3-8. Typical Profile Chart Printout	47
SECTION 7 – CONFIGURING CONTROLLER AND RECORDER	48
7-1. Changing Controller Operating Window, Ramp, Dwell, Or Temperature Units	48
7-2. Changing 5100V Recorder From Degrees F to Degrees C And Change TC Descriptor	49
7-3. Restoring Recorder Configuration From A Floppy Disk (For 5100 Digital Recorder)	50
7-3-1. Load File	50
7-3-2. Date Setup	50
7-3-3. Time Setup	51
7-3-4. Login As User	51
7-3-5. Go To Home Screen	51
SECTION 8 – MAINTENANCE & TROUBLESHOOTING	52
8-1. Routine Maintenance	52
8-2. Troubleshooting	52
8-3. Diagnostic Procedures For IH/TS	55
8-4. Resetting All RAM Variables In The Event Of Display Errors	58
8-5. Factory Set Parameters	59
8-5-1. Controller Version Number	59
8-5-2. 2408 Controller Edit Parameters	60
8-5-3. 2408 Controller Full Parameters (Prior To Version V4.09)	61
8-5-4. 2408 Controller Configure Parameters (Prior To Version V4.09)	62
8-5-5. 2408 Controller Full Parameters (Effective w/Version V4.09)	63
8-5-6. 2408 Controller Configure Parameters (Effective w/Version V4.09)	64
8-6. Calibration Certification Procedure	65
SECTION 9 – ELECTRICAL DIAGRAMS	66
SECTION 10 – PARTS LIST	67
WARRANTY	

SECTION 1 – SAFETY PRECAUTIONS – READ BEFORE USING

▲ **Warning: Protect yourself and others from injury — read and follow these precautions.**

1-1. Symbol Usage

safety_1hom 5/05



Means Warning! Watch Out! There are possible hazards with this procedure! The possible hazards are shown in the adjoining symbols.

▲ **Marks a special safety message.**

☞ Means "Note"; not safety related.



This group of symbols means Warning! Watch Out! possible ELECTRIC SHOCK, MOVING PARTS, and HOT PARTS hazards. Consult symbols and related instructions below for necessary actions to avoid the hazards.

1-2. Induction Heating Hazards

▲ **The symbols shown below are used throughout this manual to call attention to and identify possible hazards. When you see the symbol, watch out, and follow the related instructions to avoid the hazard. The safety information given below is only a summary of the more complete safety information found in the Safety Standards listed in Section 1-5. Read and follow all Safety Standards.**

▲ **Only qualified persons should install, operate, maintain, and repair this unit.**

▲ **During operation, keep everybody, especially children, away.**



ELECTRIC SHOCK can kill.

Touching live electrical parts can cause fatal shocks or severe burns. The power circuit and output bus bars or connections are electrically live whenever the output is on. The input power circuit and machine internal circuits are also live when power is on. Incorrectly installed or improperly grounded equipment is a hazard.

- Do not touch live electrical parts.
- Enclose any connecting bus bars and coolant fittings to prevent unintentional contact.
- Wear dry, hole-free insulating gloves and body protection.
- Insulate yourself from work and ground using dry insulating mats or covers big enough to prevent any physical contact with the work or ground.
- Additional safety precautions are required when any of the following electrically hazardous conditions are present: in damp locations or while wearing wet clothing; on metal structures such as floors, gratings, or scaffolds; when in cramped positions such as sitting, kneeling, or lying; or when there is a high risk of unavoidable or accidental contact with the workpiece or ground. For these conditions, see ANSI Z49.1 listed in Safety Standards. And, do not work alone!
- Disconnect input power before installing or servicing this equipment. Lockout/tagout input power according to OSHA 29 CFR 1910.147 (see Safety Standards).
- Use only nonconductive coolant hoses with a minimum length of 18 inches (457 mm) to provide isolation.
- Properly install and ground this equipment according to its Owner's Manual and national, state, and local codes.
- Always verify the supply ground – check and be sure that input power cord ground wire is properly connected to ground terminal in disconnect box or that cord plug is connected to a properly grounded receptacle outlet.
- When making input connections, attach proper grounding conductor first – double-check connections.

- Frequently inspect input power cord for damage or bare wiring – replace cord immediately if damaged – bare wiring can kill.
- Turn off all equipment when not in use.
- Do not use worn, damaged, undersized, or poorly spliced cables.
- Do not drape cables over your body.
- Do not touch power circuit if you are in contact with the work, ground, or another power circuit from a different machine.
- Use only well-maintained equipment. Repair or replace damaged parts at once. Maintain unit according to manual.
- Wear a safety harness if working above floor level.
- Keep all panels and covers securely in place.

SIGNIFICANT DC VOLTAGE exists in inverter-type power sources after removal of input power.

- Turn Off inverter, disconnect input power, and discharge input capacitors according to instructions in Maintenance Section before touching any internal parts.



FUMES AND GASES can be hazardous.

Induction Heating of certain materials, adhesives, and fluxes can produce fumes and gases. Breathing these fumes and gases can be hazardous to your health.

- Keep your head out of the fumes. Do not breathe the fumes.
- If inside, ventilate the area and/or use local forced ventilation to remove fumes and gases.
- If ventilation is poor, wear an approved air-supplied respirator.
- Read and understand the Material Safety Data Sheets (MSDSs) and the manufacturer's instruction for adhesives, fluxes, metals, consumables, coatings, cleaners, and degreasers.
- Work in a confined space only if it is well ventilated, or while wearing an air-supplied respirator. Always have a trained watchperson nearby. Fumes and gases from heating can displace air and lower the oxygen level causing injury or death. Be sure the breathing air is safe.
- Do not heat in locations near degreasing, cleaning, or spraying operations. The heat can react with vapors to form highly toxic and irritating gases.
- Do not overheat coated metals, such as galvanized, lead, or cadmium plated steel, unless the coating is removed from the heated area, the area is well ventilated, and while wearing an air-supplied respirator. The coatings and any metals containing these elements can give off toxic fumes if overheated. See coating MSDS for temperature information.



FIRE OR EXPLOSION hazard.

- Do not overheat parts and adhesive.
- Watch for fire; keep extinguisher nearby.
- Keep flammables away from work area.
- Do not locate unit on, over, or near combustible surfaces.
- Do not install unit near flammables.
- Do not operate unit in explosive atmosphere.



INDUCTION HEATING can cause burns.

- Hot parts and equipment can injure.
- Do not touch or handle induction head/coil during operation.
- Do not touch hot parts bare-handed.
- Allow cooling period before handling parts or equipment.
- Keep metal jewelry and other metal personal items away from head/coil during operation.

1-3. Additional Symbols for Installation, Operation, and Maintenance

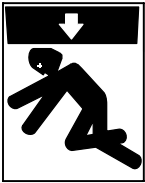

FALLING UNIT can cause injury.

- Use handle and have person of adequate physical strength lift unit.
- Move unit with hand cart or similar device.
- For units without a handle, use equipment of adequate capacity to lift unit.
- When using lift forks to move unit, be sure forks are long enough to extend beyond opposite side of unit.

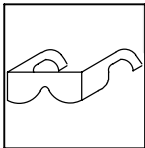

FLYING METAL OR ADHESIVE can injure eyes.

- Wear approved safety glasses with side shields or wear face shield.



MOVING PARTS can cause injury.

- Keep away from moving parts such as fans.
- Keep all doors, panels, covers, and guards closed and securely in place.

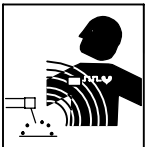

MAGNETIC FIELDS can affect pacemakers.

- Pacemaker wearers keep away.
- Wearers should consult their doctor before going near induction heating operations.

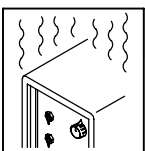

OVERUSE can cause OVERHEATING

- Allow cooling period.
- Reduce output or reduce duty cycle before starting to heat again.
- Follow rated duty cycle.

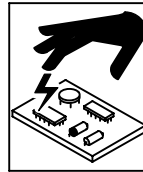

STATIC (ESD) can damage PC boards.

- Put on grounded wrist strap BEFORE handling boards or parts.
- Use proper static-proof bags and boxes to store, move, or ship PC boards.

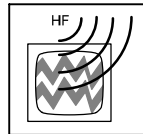

H.F. RADIATION can cause interference.

- High-frequency (H.F.) can interfere with radio navigation, safety services, computers, and communications equipment.
- Have only qualified person familiar with electronic equipment perform this installation.
- The user is responsible for having a qualified electrician promptly correct any interference problem resulting from the installation.
- If notified by the FCC about interference, stop using the equipment at once.
- Have the installation regularly checked and maintained.
- Keep high-frequency source doors and panels tightly shut.

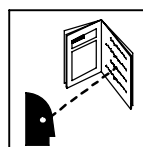

READ INSTRUCTIONS.

- Read Owner's Manual before using or servicing unit.
- Use only genuine Miller/Hobart replacement parts.

1-4. California Proposition 65 Warnings

- ▲ **Welding or cutting equipment produces fumes or gases which contain chemicals known to the State of California to cause birth defects and, in some cases, cancer. (California Health & Safety Code Section 25249.5 et seq.)**
- ▲ **Battery posts, terminals and related accessories contain lead and lead compounds, chemicals known to the State of California to cause cancer and birth defects or other reproductive harm. Wash hands after handling.**

For Gasoline Engines:

- ▲ **Engine exhaust contains chemicals known to the State of California to cause cancer, birth defects, or other reproductive harm.**

For Diesel Engines:

- ▲ **Diesel engine exhaust and some of its constituents are known to the State of California to cause cancer, birth defects, and other reproductive harm.**

1-5. Principal Safety Standards

Safety in Welding, Cutting, and Allied Processes, ANSI Standard Z49.1, from Global Engineering Documents (phone: 1-877-413-5184, website: www.global.ihs.com).

Safety and Health Standards, OSHA 29 CFR 1910, from Superintendent of Documents, U.S. Government Printing Office, Washington, D.C. 20402.

National Electrical Code, NFPA Standard 70, from National Fire Protection Association, Batterymarch Park, Quincy, MA 02269.

Canadian Electrical Code Part 1, CSA Standard C22.1, from Canadian Standards Association, Standards Sales, 178 Rexdale Boulevard, Rexdale, Ontario, Canada M9W 1R3.

Practice For Occupational And Educational Eye And Face Protection, ANSI Standard Z87.1, from American National Standards Institute, 11 West 42nd Street, New York, NY 10036-8002 (phone: 212-642-4900, website: www.ansi.org).

1-6. EMF Information

Considerations About Induction Heating And The Effects Of Low Frequency Electric And Magnetic Fields

The following is a quotation from the General Conclusions Section of the U.S. Congress, Office of Technology Assessment, *Biological Effects of Power Frequency Electric & Magnetic Fields – Background Paper*, OTA-BP-E-53 (Washington, DC: U.S. Government Printing Office, May 1989): “. . . there is now a very large volume of scientific findings based on experiments at the cellular level and from studies with animals and people which clearly establish that low frequency magnetic fields can interact with, and produce changes in, biological systems. While most of this work is of very high quality, the results are complex. Current scientific understanding does not yet allow us to interpret the evidence in a single coherent framework. Even more frustrating, it does not yet allow

us to draw definite conclusions about questions of possible risk or to offer clear science-based advice on strategies to minimize or avoid potential risks.”

To reduce magnetic fields in the workplace, use the following procedures:

1. Arrange output cable to one side and away from the operator.
2. Do not coil or drape output cable around the body.
3. Keep power source and cable as far away from the operator as practical.

About Pacemakers:

Pacemaker wearers consult your doctor before welding or going near welding or induction heating operations. If cleared by your doctor, then following the above procedures is recommended.

SECTION 2 – MESURES DE SECURITE POUR LE CHAUFFAGE PAR INDUCTION

ihom_fre 8/03



AVERTISSEMENT

LE CHAUFFAGE PAR INDUCTION peut être dangereux.

PRENDRE LES MESURES NECESSAIRES POUR EVITER LES RISQUES DE BLESSURES GRAVES, VOIRE MORTELLES. TENIR LES ENFANTS A DISTANCE. LES PORTEURS D'UN STIMULATEUR CARDIAQUE DOIVENT PREALABLEMENT CONSULTER LEUR MEDECIN.

Pendant les opérations de chauffage, comme dans la plupart des activités, l'opérateur s'expose à certains dangers. Le chauffage n'est pas dangereux à condition de prendre certaines mesures. Les consignes de sécurité indiquées ci-après ne sont qu'un résumé des informations plus détaillées se trouvant dans les normes de sécurité énumérées à la page suivante. Lire et respecter toutes les normes de sécurité.

LES OPERATIONS D'INSTALLATION, DE FONCTIONNEMENT, DE MAINTENANCE ET DE REPARATION NE DOIVENT ETRE CONFIEES QU'A DU PERSONNEL QUALIFIE.



Danger de mort PAR ELECTROCUTION.

Le contact de composants électriques peut provoquer des accidents mortels ou des brûlures graves. Le circuit de puissance et les connexions de sortie sont sous tension lorsqu'on active la sortie. Le circuit d'alimentation et les circuits internes de la machine sont également sous tension lorsque l'alimentation est sur marche. Des équipements installés ou reliés à la borne de terre de manière incorrecte sont dangereux.

1. Ne pas toucher des composants électriques sous tension.
2. Envelopper les connexions et raccords de refroidissement pour éviter tout contact accidentel.
3. Porter des gants d'isolation secs, sans trous, et une protection corporelle.
4. Isolez-vous de la pièce et du sol avec des tapis ou des couvertures d'isolation suffisamment grands pour prévenir tout contact physique avec la pièce ou la terre.
5. Déconnecter l'alimentation avant d'installer l'appareil ou d'en effectuer l'entretien. Verrouiller ou étiqueter la sortie d'alimentation selon la norme OSHA 29 CFR 1910.147 (se reporter aux Principales normes de sécurité).
6. Utiliser seulement des tuyaux non conducteurs avec une longueur minimale de 460 mm pour assurer l'isolement.
7. Installer et mettre cet équipement correctement à la terre conformément au manuel utilisateur et aux codes nationaux, gouvernementaux et locaux.
8. Vérifier souvent la terre de l'alimentation – contrôler et s'assurer que le conducteur de terre du câble d'alimentation est correctement relié à la borne de terre dans le boîtier de déconnexion ou que le connecteur est branché à une sortie de boîtier correctement mise à la terre.
9. En réalisant des connexions d'entrée brancher d'abord le conducteur de terre approprié – contrôler deux fois les connexions.
10. Vérifier souvent le bon état du câble d'alimentation ou l'isolation des fils – remplacer le câble immédiatement s'il est endommagé – des fils dénudés peuvent provoquer des accidents mortels.
11. Arrêter tous les équipements lorsqu'ils ne sont pas utilisés.
12. Ne pas utiliser des câbles usés, endommagés, sous dimensionnés ou mal épissés.
13. Ne pas porter les câbles autour de votre corps.
14. Ne pas toucher le circuit électrique si vous êtes en contact avec la pièce, la terre ou le circuit électrique d'une autre machine.
15. Utiliser seulement des équipements bien entretenus. Réparer ou remplacer immédiatement des composants endommagés. Effectuer des travaux d'entretien sur l'appareil selon le manuel.
16. Porter un harnais de sécurité pour effectuer des travaux au-dessus du sol.
17. Maintenir solidement en place tous les panneaux et couvercles.



LE CHAUFFAGE PAR INDUCTION peut provoquer des blessures ou des brûlures au contact de PIECES CHAUDES OU DE L'EQUIPEMENT.

1. Ne pas toucher ou manipuler la tête/l'enroulement à induction pendant le fonctionnement.
2. Tenir les bijoux et autres objets personnels en métal éloignés de la tête/de l'enroulement pendant le fonctionnement.
3. Laisser refroidir les composants ou équipements avant de les manipuler.



LE CHAUFFAGE PAR INDUCTION peut provoquer un incendie.

1. Ne pas surchauffer les composants ni les adhésifs.
2. Attention aux risques d'incendie: tenir un extincteur à proximité.
3. Stocker des produits inflammables hors de la zone de travail.

La mise en place de l'appareil sur, au-dessus ou à proximité de surfaces inflammables peut être source d'INCENDIES OU d'EXPLOSION.

1. Ne pas placer l'appareil sur, au-dessus ou à proximité de surfaces inflammables.
2. Ne pas installer l'appareil à proximité de produits inflammables.
3. Ne pas faire fonctionner l'appareil en atmosphère explosive.









DES FUMÉES ET DES GAZ peuvent être dangereux pour votre santé.

Le chauffage à induction génère des fumées et des gaz. Leur inhalation peut être dangereuse pour votre santé.

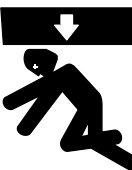
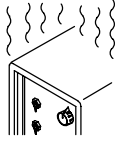
1. Eloigner la tête des fumées. Ne pas respirer les fumées.
2. A l'intérieur, ventiler la zone et/ou utiliser un extracteur pour l'évacuation des fumées et des gaz.
3. Si la ventilation est insuffisante, utiliser un respirateur à alimentation d'air homologué.
4. Lire les spécifications de sécurité des matériaux (MSDSs) et les instructions du fabricant concernant les adhésifs, les métaux, les consommables, les revêtements, les nettoyants et les dégraisseurs.

5. Travailler dans un espace fermé seulement s'il est bien ventilé ou en portant un respirateur. Demander toujours à un surveillant dûment formé de se tenir à proximité. Des fumées et des gaz provenant du chauffage peuvent déplacer l'air, abaisser le niveau d'oxygène, et provoquer des lésions ou des accidents mortels. S'assurer que l'air ambiant ne présente aucun danger.
6. Ne pas chauffer dans des endroits se trouvant à proximité d'opérations de dégraissage, de nettoyage ou de pulvérisation. La chaleur peut réagir en présence de vapeurs et former des gaz hautement toxiques et irritants.
7. Ne pas chauffer des métaux munis d'un revêtement tels que l'acier galvanisé, plaqué au plomb ou au cadmium, à moins que le revêtement ne soit enlevé de la zone chauffée, que la zone soit bien ventilée et, si nécessaire, en portant un respirateur. Les revêtements et tous les métaux contenant ces éléments peuvent dégager des fumées toxiques s'ils sont chauffés.

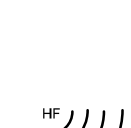
2-1. Dangers supplémentaires de mise en route, de fonctionnement et d'entretien

	<p>LA CHUTE DE MATERIEL peut provoquer des blessures personnelles graves et endommager les équipements.</p> <ol style="list-style-type: none"> 1. Utiliser la poignée et demander à une personne ayant la force physique nécessaire pour soulever l'appareil. 2. Déplacer l'appareil à l'aide d'un charriot ou d'un engin similaire. 3. Pour les appareils sans poignée utiliser un équipement d'une capacité appropriée pour soulever l'appareil. 4. En utilisant des fourches de levage pour déplacer l'unité, s'assurer que les fourches sont suffisamment longues pour dépasser du côté opposé de l'appareil. 		<p>UNE UTILISATION INTENSIVE peut provoquer un SURCHAUFFEMENT DU MATERIEL.</p> <ol style="list-style-type: none"> 1. Prévoir une période de refroidissement 2. Réduire le courant de sortie ou le facteur de marche avant de recommencer le chauffage. 3. Respecter le facteur de marche nominal.
	<p>LA PROJECTION DE PIÈCES DE METAL ou DE COLLE peut provoquer des blessures aux yeux.</p> <ol style="list-style-type: none"> 1. Porter des lunettes de protection avec des protections latérales. 		<p>L'ELECTRICITE STATIQUE peut endommager les composants des tableaux électriques.</p> <ol style="list-style-type: none"> 1. Etablir la connexion avec la barrette de terre avant de manipuler des cartes ou des pièces. 2. Utiliser des pochettes et des boîtes antistatiques pour stocker, déplacer ou expédier des cartes PC.
	<p>DES ORGANES MOBILES peuvent provoquer des blessures.</p> <ol style="list-style-type: none"> 1. S'abstenir de toucher des organes mobiles tels que des ventilateurs. 2. Maintenir fermés et fixement en place les portes, panneaux, recouvrements et dispositifs de protection. 		<p>LE RAYONNEMENT HAUTE FREQUENCE peut provoquer des interférences avec les équipements de radio-navigation et de communication, les services de sécurité et les ordinateurs.</p> <ul style="list-style-type: none"> • Demander seulement à des personnes qualifiées familiarisées avec des équipements électroniques de faire fonctionner l'installation. • L'utilisateur est tenu de faire corriger rapidement par un électricien qualifié les interférences résultant de l'installation. • Si le FCC signale des interférences, arrêter immédiatement l'appareil. • Effectuer régulièrement le contrôle et l'entretien de l'installation. • Maintenir soigneusement fermés les portes et les panneaux des sources de haute fréquence.
	<p>DES CHAMPS MAGNETIQUES CREEES PAR DES COURANTS ELEVES peuvent affecter le fonctionnement du stimulateur cardiaque.</p> <ol style="list-style-type: none"> 1. Porteurs de stimulateur cardiaque, restez à distance. 2. Les porteurs d'un stimulateur cardiaque doivent d'abord consulter leur médecin avant de s'approcher des opérations de chauffage à induction. 		

2-2. Informations concernant les champs électro-magnétiques (Information EMF)

Considérations relatives au chauffage à induction et aux effets des champs électriques et magnétiques basse fréquence.

Le texte suivant est extrait des conclusions générales Département du Congrès U.S., Office of Technology Assessment, *Effets biologiques des champs magnétiques et électriques basse fréquence – Background Paper*, OTA-BP-E-53 (Washington, DC: U.S. Government Printing Office, May 1989): “. . . on dispose maintenant d’importantes découvertes scientifiques reposant sur des expériences effectuées dans le domaine cellulaire et des études réalisées sur des animaux et des personnes qui démontrent clairement que des champs magnétiques basse fréquence peuvent avoir une interaction et produire des changements dans les systèmes biologiques. Alors que la plus grande partie de cet ouvrage est d’une très grande qualité, les résultats sont complexes. La compréhension scientifique courante ne nous permet pas encore d’interpréter la preuve fournie dans un seul ouvrage cohérent. Il est encore plus frustrant de ne pas pouvoir tirer des conclusions définitives en ce qui concerne les problèmes de risque possible ou de

proposer des recommandations scientifiques claires pour des stratégies à suivre en vue de minimiser ou de prévenir des risques potentiels.”

Pour réduire les champs magnétiques sur le poste de travail, appliquer les procédures suivantes :

4. Disposer le câble de sortie d’un côté à distance de l’opérateur
5. Ne pas enrouler ou draper le câble électrique autour du corps.
6. Placer la source de courant et le câble le plus loin possible de l’opérateur.

En ce qui concerne les stimulateurs cardiaques

Les procédures ci-dessus concernent également les porteurs de stimulateur cardiaque. Consulter votre médecin pour un complément d’information.

2-3. PRINCIPALES NORMES DE SÉCURITÉ

Normes de sécurité et de santé, OSHA 29 CFR 1910, from Superintendent of Documents, U.S. Government Printing Office, Washington, D.C. 20402.

Code électrique national, NFPA Standard 70, from National Fire Protection Association, Batterymarch Park, Quincy, MA 02269.

Code électrique du Canada, partie 1, CSA Standard C22.1, from Canadian Standards Association, Standards Sales, 178 Rexdale Boulevard, Rexdale, Ontario, Canada M9W 1R3.

Safe Practices For Occupation And Educational Eye And Face Protection, ANSI Standard Z87.1, from American National Standards Institute, 1430 Broadway, New York, NY 10018.

SECTION 3 – INTRODUCTION

The Induction Heating Temperature Station (IH/TS) is designed to be used with Induction Heating Systems for pre-heat and post-heat (stress relieving) applications. The station is built in two different configurations; as a controller only or as a controller with a digital recorder.

The controller in the IH/TS comes pre-programmed from the factory with a typical stress relieving temperature profile that can be easily changed to match specific customer stress relief requirements. Also, the controller can be programmed to operate in a pre-heat mode. These instructions will guide the operator in the proper use of the station which includes programming and setting up the controller, and operating the recorder.

SECTION 4 – INSTALLATION

4-1. Specifications

Specification	Description
Overall Dimensions	Height: 10 in (254 mm); Width: 14-1/2 in (368 mm); Depth: 16 in (406 mm)
Weight	Net: IH/TS (no recorder) 13.1 lb (5.9 kg); IH/TS (digital recorder) 21.1 lb (9.6 kg)
Type Of Input Power	24 Volts DC, 115 Volts AC
Memory Capacity	One Program Up To 8 Segments
Control Capacity	Single Power Source Control
Operating Temperature Range	41° To 104° F (5° To 40° C)
Storage Temperature Range	-4° To 122° F (-20° To 50° C)

Reference the controller and recorder manuals for additional information.

4-2. IH/TS Installation

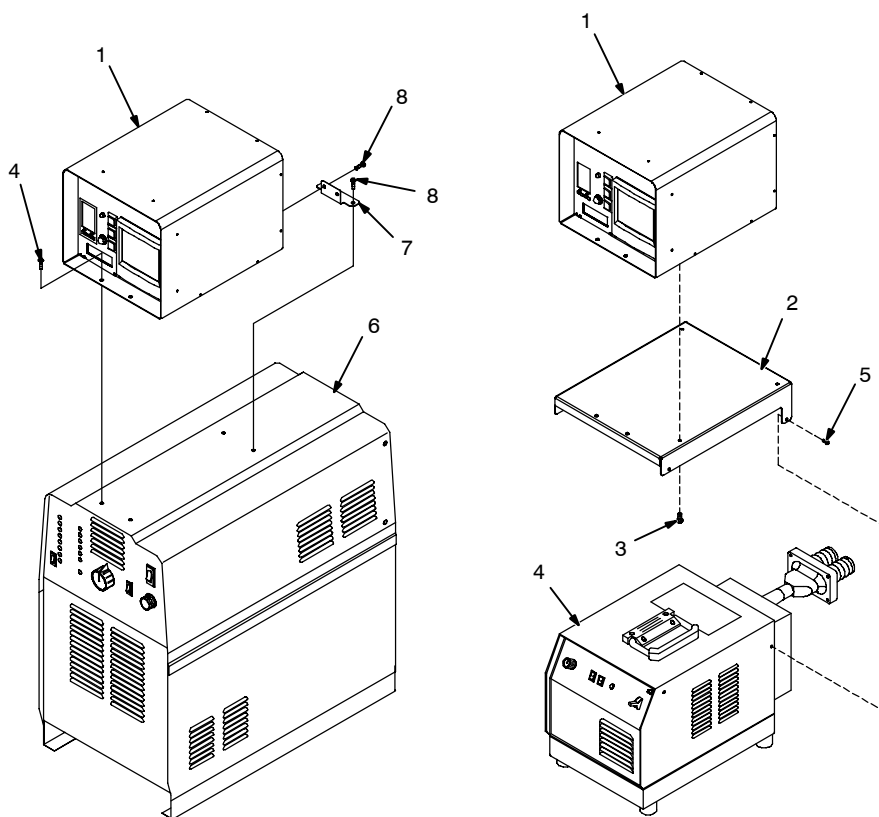

▲ Turn Off and disconnect input power.

5 kW System

1. Temperature Control/Recorder
2. 5kW Mounting Bracket
3. Screw, 10-32 (4)

Install and secure IH/TS to mounting bracket using supplied #10 screws.

4. 5kW Power Source Case
5. Case Sheet Metal Screw (4)

Remove case sheet metal screws from both top left and right sides of unit. Install mounting bracket to power source and secure by reinstalling sheet metal screws.

25 kW System

6. 25 kW Power Source Case
7. Rear Mounting Bracket
8. Screw, 1/4-20 (2)

Remove front and middle mounting screws from top of Item 6 case. Locate IH/TS and reinstall front mounting screws. Locate rear mounting bracket, and secure with supplied 1/4-20 screws. Reinstall middle mounting screws to secure bracket to case.

Tools Needed:



Ref. 802 905-A / 802 900

4-3. Connecting To Power Source

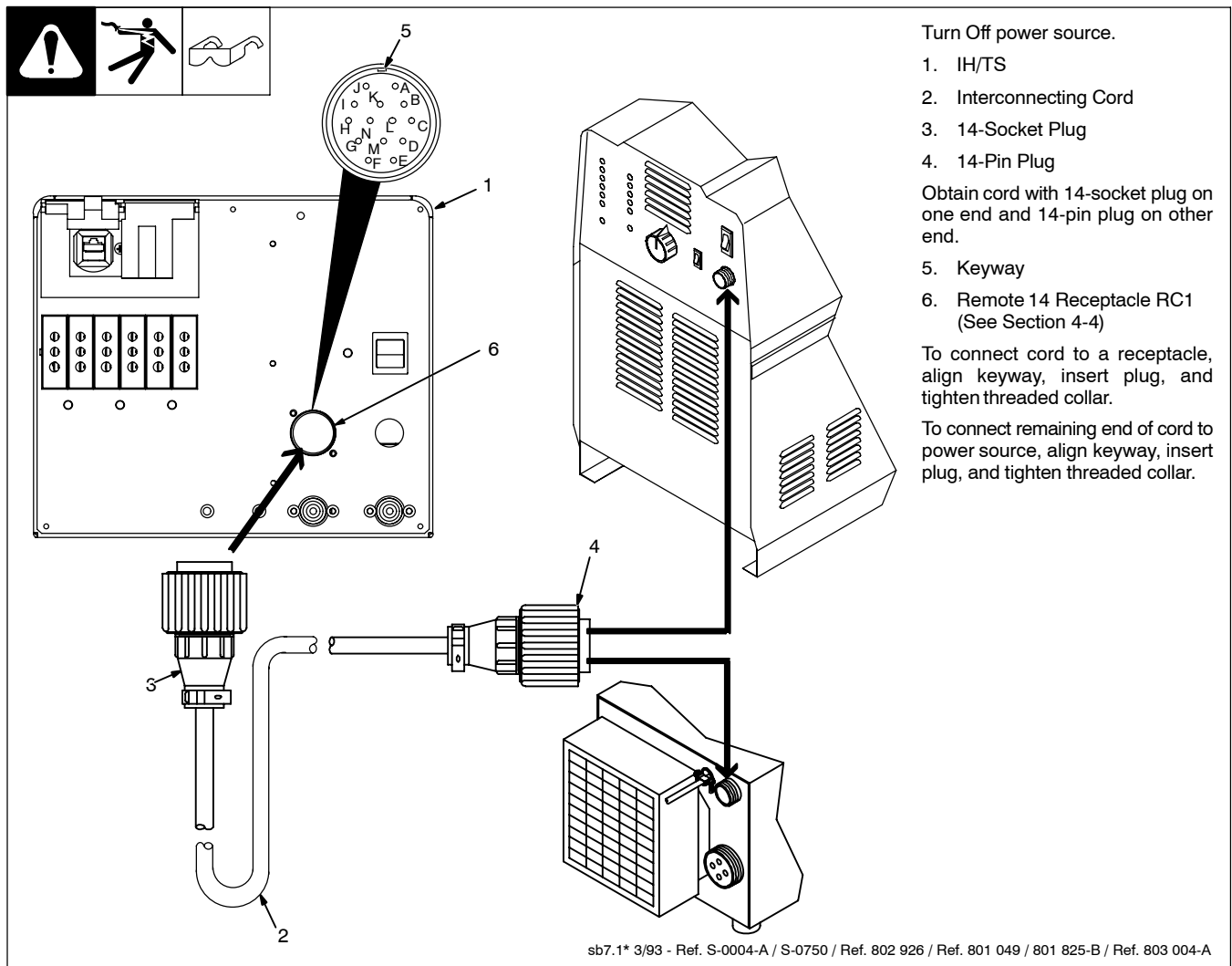

4-4. Input 14 Pin Information For Receptacle RC1

 REMOTE 14	Pin	Pin Information
Remote Contactor	A	+24 volts dc from power source.
	B	Contact closure to A completes power source +24 volts dc contactor control circuit.
Remote Output Control	D	Control circuit common.
	E	0 to +10 volts dc signal for power source output control.
Power Source Fault	F, J	Absence of contact closure from power source indicates power source output failure.
Remote Metering*	I	Actual frequency input signal.
	L	Average power input signal.
	M	Voltage input signal RMS.
	N	Current input signal RMS.

*See power source Owner's Manual for scaling information.

4-5. Connecting 25kW System Cords And Cables

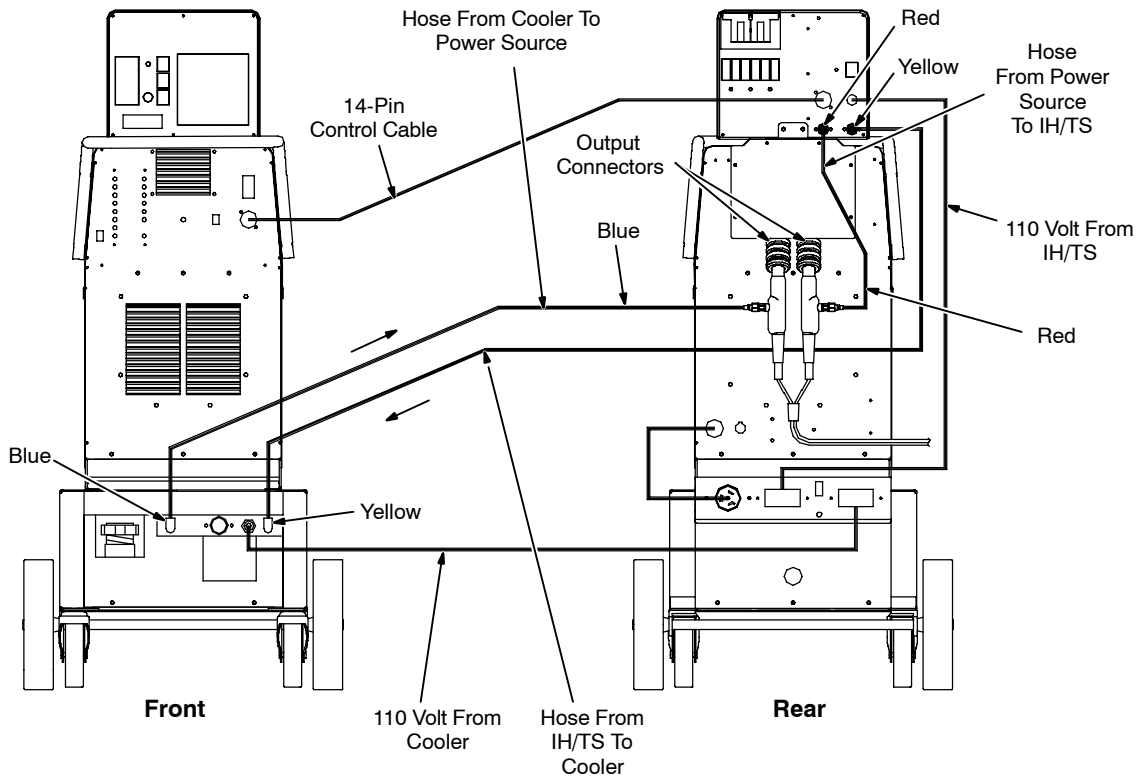

803 036-C

Connect the power output cable and coolant lines as shown.

Connect 110-volt power cable as shown.

Plug the 110-volt cooler power cord into the duplex at the rear of the power source cart. On the 25kW system, the cooler must be plugged into the right side duplex. This is identified with a label that reads "switched receptacle." The ON-OFF switch located to the left operates this

plug.

The IH/TS Control is plugged in the left side duplex. Do not use these duplex connections for operating auxiliary tools, such as grinders, drills, lights, etc.

Connect output power cables to the output connectors.

All coolant connections have 5/8-18 left-hand threads.

- Connect the "coolant out" line from the cooler directly to the output extension cable.
- Connect the "coolant in" line on the IH/TS directly to the remaining output extension cable connection.
- Connect the "coolant out" line from the IH/TS to the "coolant in" line on the cooler.

4-6. Connecting 5kW System Cords And Cables

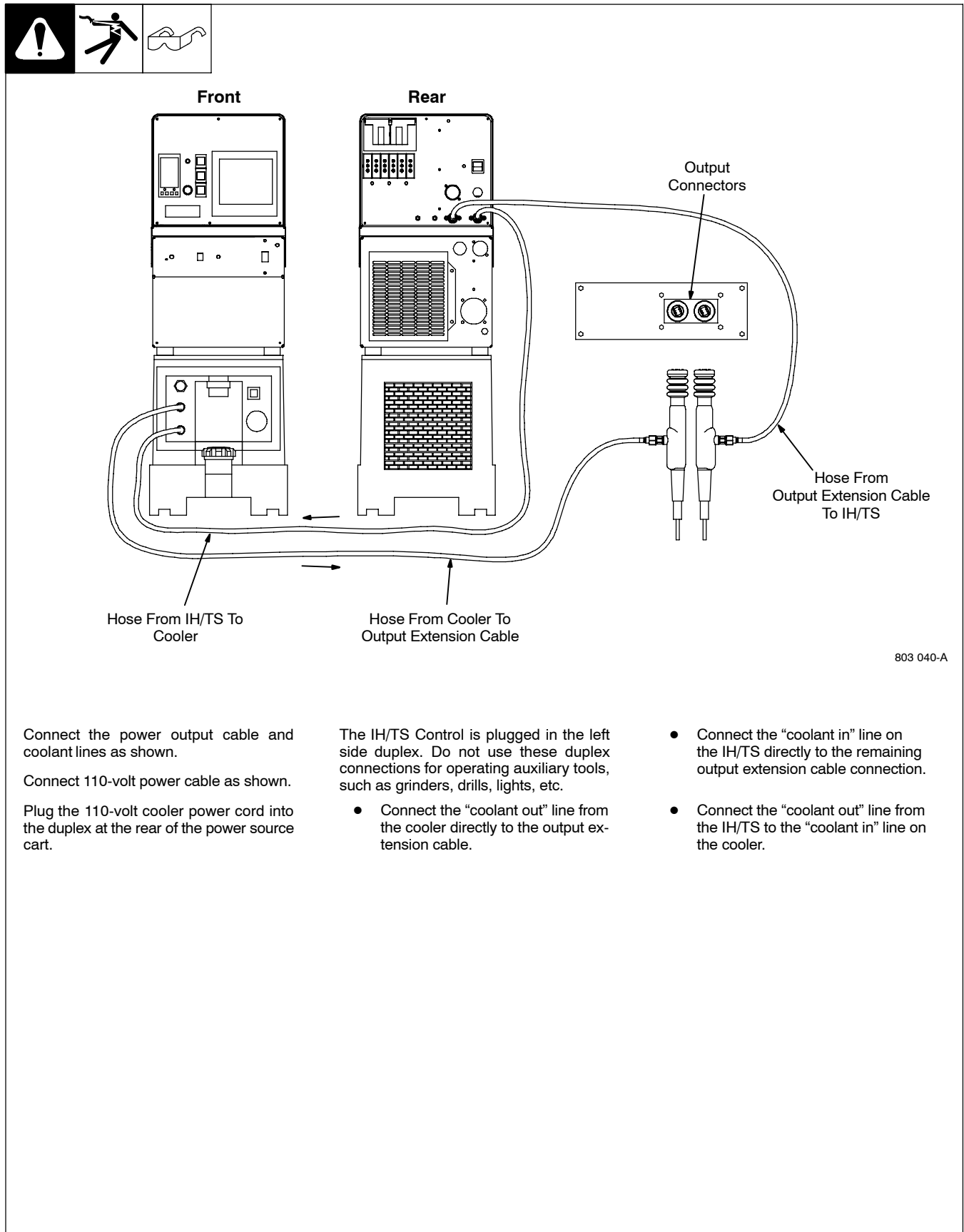

803 040-A

Connect the power output cable and coolant lines as shown.

Connect 110-volt power cable as shown.

Plug the 110-volt cooler power cord into the duplex at the rear of the power source cart.

The IH/TS Control is plugged in the left side duplex. Do not use these duplex connections for operating auxiliary tools, such as grinders, drills, lights, etc.

- Connect the "coolant out" line from the cooler directly to the output extension cable.

- Connect the "coolant in" line on the IH/TS directly to the remaining output extension cable connection.

- Connect the "coolant out" line from the IH/TS to the "coolant in" line on the cooler.

4-7. Connecting External Device

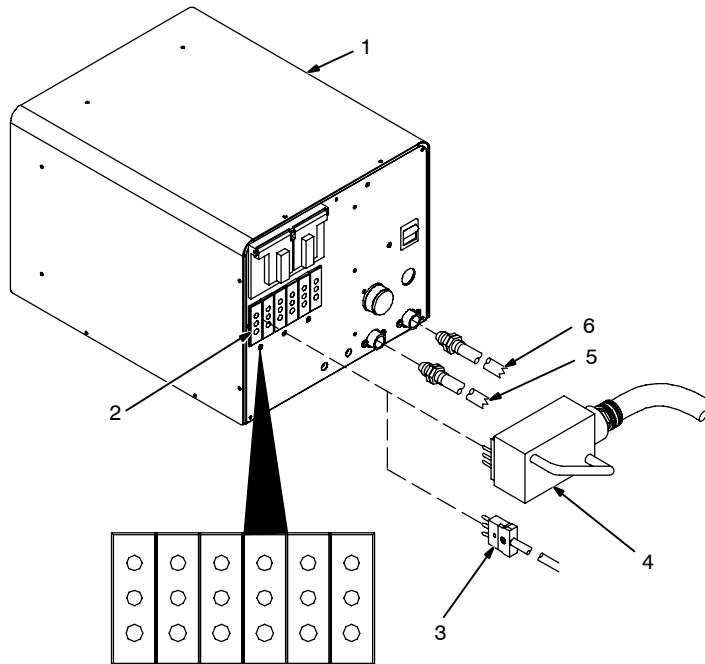

The IH/TS must have (as a minimum) one thermocouple connected to receptacle TC1. If multiple thermocouples are desired, either use individual thermocouple plugs or the thermocouple extension cable.

To connect thermocouples to the control, proceed as follows:

Turn Off power source.

1. Temperature Controller
2. Thermocouple Receptacles
3. Individual Thermocouple Plug
4. Thermocouple Extension Cable

Align plug pins with receptacle sockets and push plug into receptacle.

5. Coolant Line From Coil
6. Coolant Line To Cooler "Coolant In" Port

The IH/TS is supplied with an internal coolant flow switch. Coolant hoses must be connected to the IH/TS for proper operation. Connect coolant hoses (supplied with post-heat systems) to coolant fittings on unit as described in Section 4-5.

Tools Needed:



Ref. 803 003-B

SECTION 5 – COMPONENTS AND CONTROLS

5-1. IH/TS Front Panel

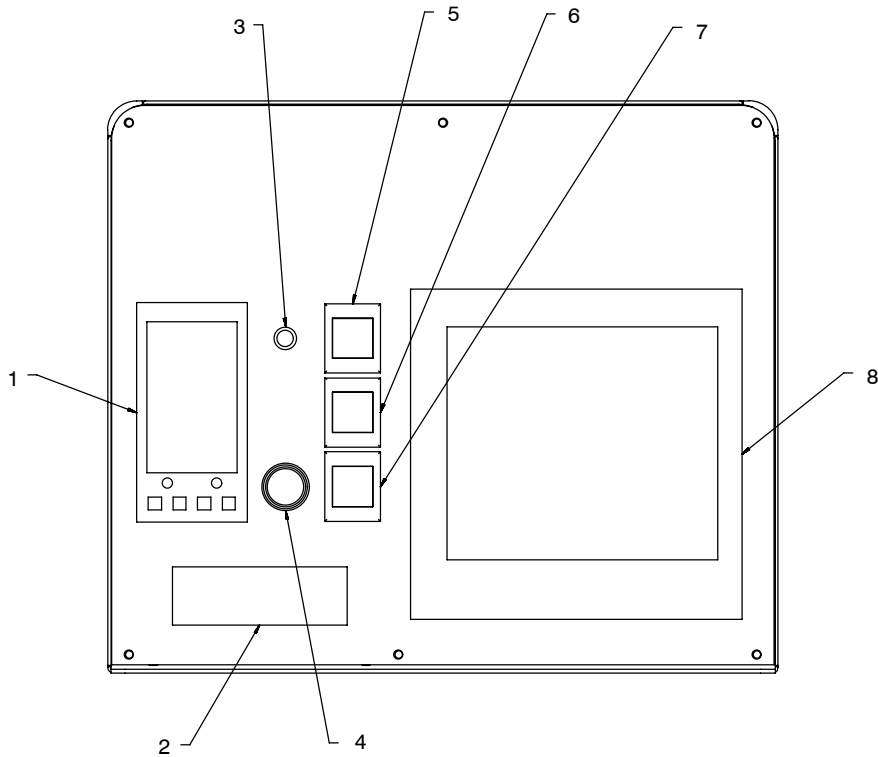

▲ Keep all panels, doors, and covers closed and secure during programming.

1. Temperature Controller
2. Parameter Display Screen
3. Heat On Pilot Light
4. Fault/ Limit Light
5. Run Button
6. Hold Button
7. Stop Button
8. Recorder (If Equipped)

Ref. 803 004

5-2. IH/TS Rear Panel

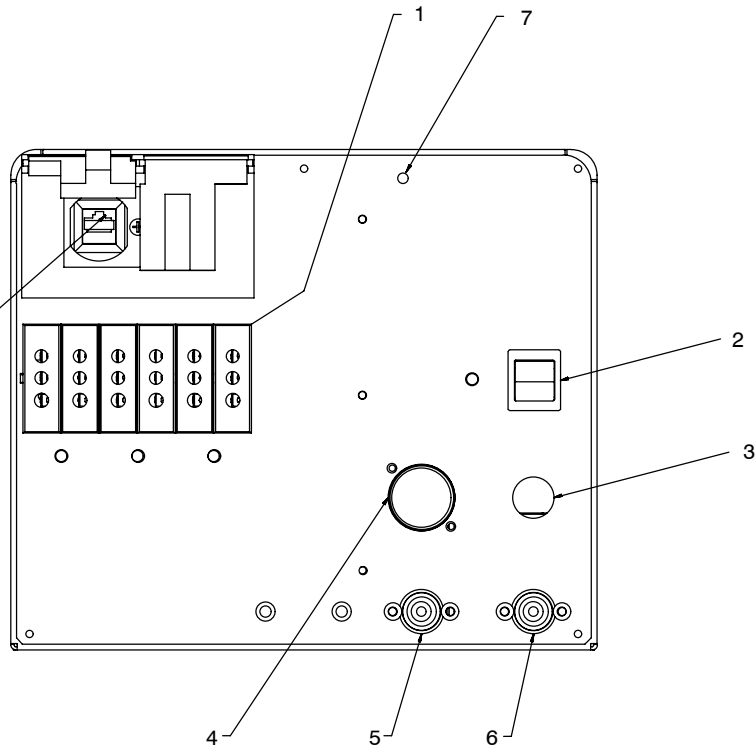

▲ **Keep all panels, doors, and covers closed and secure during programming.**

1. Thermocouple Connectors
2. On/Off Power Switch
3. 115 VAC Power Cord
4. 14-Pin Receptacle
5. Coolant Flow Switch "IN" Fitting
6. Coolant Flow Switch "OUT" Fitting
7. Power Source Select Switch
8. Network Connection

Ref. 803 004-A

5-3. Controller

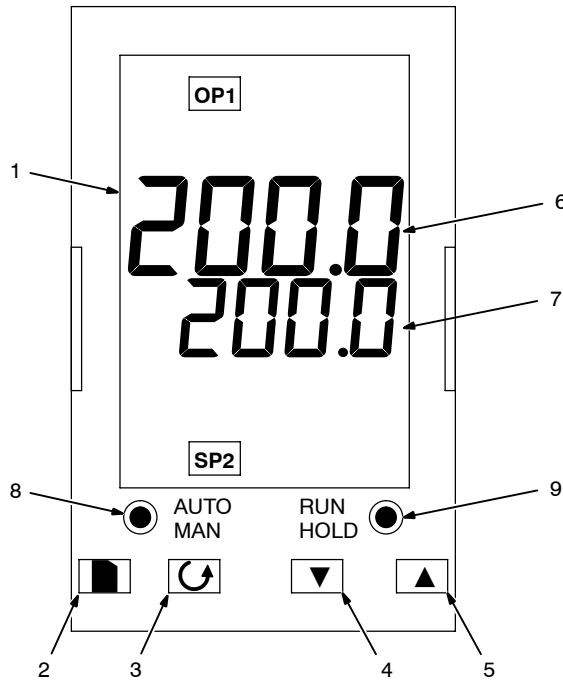

▲ **Keep all panels, doors, and covers closed and secure during programming.**

1. Digital Display
2. Page Forward Button
3. Scroll Button
4. Down Button
5. Up Button
6. Actual Temperature
7. Setpoint Temperature
8. Auto/Man Button (Disabled)
9. Run/Hold Button (Disabled)

SECTION 6 – SETUP AND OPERATION

6-1. Safety Equipment

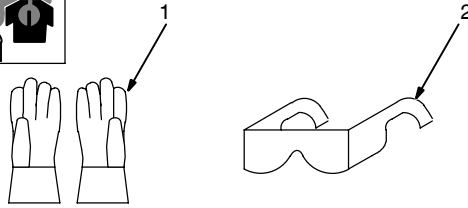

Wear the following during operation:

1. Dry, Insulating Gloves
2. Safety Glasses With Side Shields

DO NOT wear rings or watches during operation.

sb3.1* 1/94

6-2. IH/TS Setup

6-2-1. Select Power Source

Energize the power source, cooler, and IH/TS. A power source selection will appear in the top right corner of the IH/TS front panel Parameter Display. Press the recessed Power Source Select button on the IH/TS rear panel to toggle through and select the appropriate power source maximum output. This selection will provide the proper output scaling in the parameter display screen for the power source that is attached to the IH/TS.

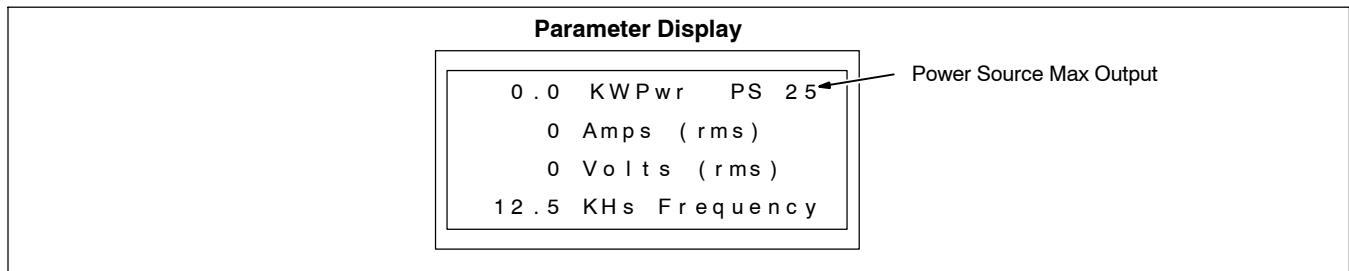

6-2-2. Time Date Setup – Digital

6-2-2-1. Digital Recorder Controls

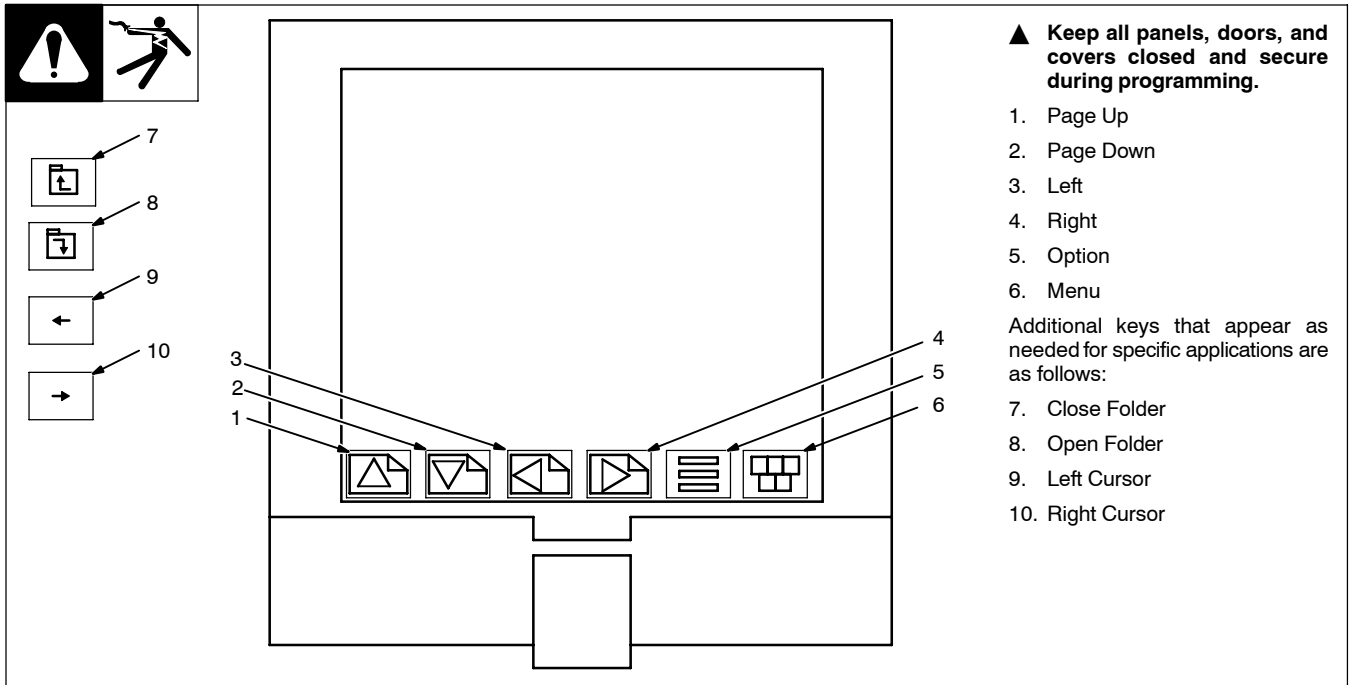

6-2-2-2. Login As Engineer

1. Touch top left corner (Logged Out) or (User).
2. Touch Blue text (pull down menu) next to User.
3. Touch Engineer.
4. Touch Password field.
5. Touch Numeric.
6. Touch 1, then 0, and finally Ok. “Engineer” will appear in top left corner of display.

6-2-2-3. Go To Operator Screen

1. Touch the Menu  key in bottom right corner to open Root Menu.
2. Touch Operator.

6-2-2-4. Locale Setup

1. Touch System.
2. Touch Locale.
3. Touch pull down next to Country.
4. Touch appropriate country.
5. Touch pull down next to Time Zone.
6. Touch appropriate time zone (i.e. CST Central). See “<http://www.timeanddate.com>” for additional information.
7. Set DST (Daylight Savings Time) if applicable. Place an “X” in the box next to “Use Summertime (DST)” to enable this option.

NOTE

In general, for those locations that observe DST:
DST begins at 2:00 am on the first Sunday in April.
DST ends at 2:00 am on the last Sunday in October.
See "<http://deil.lang.uiuc.edu/web.pages/holidays/DST.html> for exceptions.

8. Touch Apply.

6-2-2-5. Time And Date Setup

1. Touch System.
2. Touch Clock.
3. Adjust time and date, if necessary.
4. Touch Apply.

6-2-2-6. Login As User

1. Touch top left corner (Engineer).
2. Touch pull down next to User.
3. Touch User from pull down list.

6-2-2-7. Go To Home Screen

1. Touch the Menu  key in bottom right corner to open Root Menu.
2. Touch Home.

6-2-2-8. Channel Cycling On/Off And Notes

When Trend graphs are displayed, the operator has the option to sequentially display the TC readings for each channel by activating the "Channel Cycling On" option. When channel cycling is off, recorder displays only the selected TC value.

To activate/deactivate "Channel Cycling":

1. Press the Option  key to open options menu.
2. Press channel cycling On to activate cycling or press channel cycling Off to deactivate cycling.

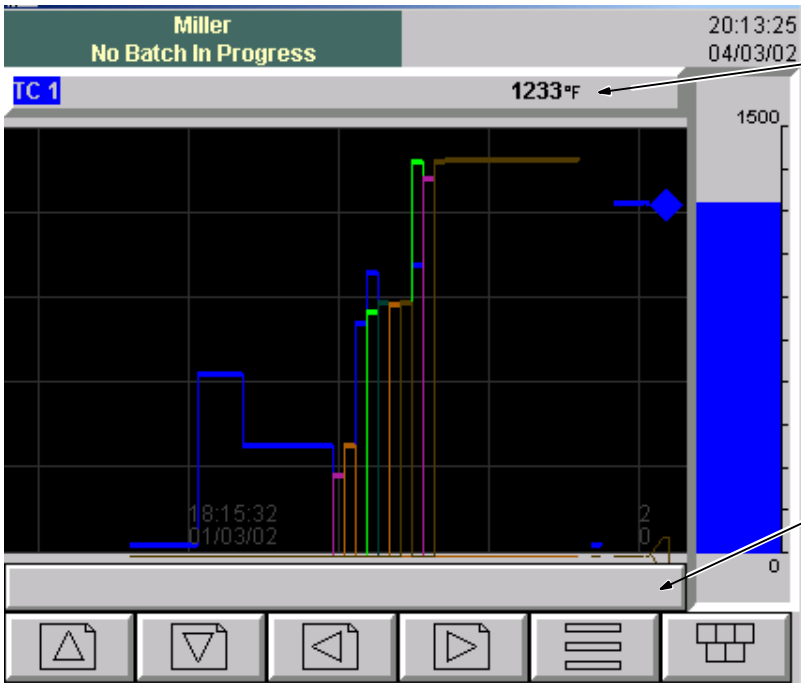

To manually change which TC is displayed, press the TC field to advance to the next TC reading.

Notes can be added to a chart on the recorder while viewing a trend screen.

Press the "Option Menu" button.

Press "Note".

Press the field next to "User Note" and enter notes using keypad.

Press "OK".

Press "OK".

The note is added to the chart.

The note can be viewed on the bottom of the screen or in the history screen.

Press the Option key, press "Enter History".

To exit, press the Option key, then press "Exit History".

scrn34

6-3. Operation

1. Energize IH/TS and power source. A coolant flow error should appear on the IH/TS display. Energize the cooler and the error will clear from the display.
2. Set up Temperature Profile – per code requirements (see Section 6-3-2 Programming The 2408 Controller).
3. Set up and start Digital Recorder
 Digital Recorder (see Section 6-3-3. Batch Recording On The 5100 Digital Recorder)
4. Run the heat process (see Section 6-3-4. Running A Heat Treat and the following tables).
5. Recover from an interruption, if applicable (see Section 6-3-5. Recovering From An Interruption).
6. Retrieve data
 Digital Recorder (see Section 6-3-3-4. Batch Recording On The 5100 Digital Recorder)
 View and print data (see Section 6-3-6 Review Software).

Table 6-1. Controller Display Definitions





Name	Description
	Home List (extra parameters may be present.)
Home	Measured value and Setpoint
OP	% Output level

Table 6-2. Run List Sub-Menu Definitions

<i>run</i>	<i>PrOgRAm rUn LISt</i>
<i>SEAE</i>	Program status (<i>OFF, run, hOLd, HbAc, End</i>)
<i>PSP</i>	Programmer setpoint
<i>SEG</i>	Active segment number
<i>SEYP</i>	Active segment type
<i>SEGE</i>	Segment time remaining in the segment units
<i>EGE</i>	Target setpoint
<i>rAEE</i>	Ramp rate (if a rate segment)
<i>PrGE</i>	Program time remaining in hours
<i>SEG.d</i>	*Flash active segment type in the lower readout of the home display (no/YES)
<i>FASt</i>	Runs through program 10 times faster than normal
*This parameter can only be changed when the program is in reset.	

6-3-1. 2408 Controller

The 2408 controller in the IH/TS provides a means of establishing a heat profile for heating or stress relieving as dictated by “code” requirements, and controls the power source to meet the programmed profile. The 2408 controller has several screens (main and sub-menu) that are used to monitor status and program the control. The main screens are as follows:



- Home Screen: This screen is displayed after first turning on the unit. It has the actual temperature at the top of the display and program temperature at the bottom of the display. Home Screen sub-menu and definitions are shown in Table 6-1. Pressing the “Scroll”  button will step through the sub-menus.
- Run List: This screen is accessed by pushing the “Page”  key twice. Run List allows the operator to check the status of a program while the system is running. It also allows making changes to a program by pressing the “Hold”  button on the front of the IH/TS. Run List sub-menu screens and their definitions are shown in Table 6-2.
- Program List: This screen is accessed by pushing the “Page”  key three times. Program List is used to program the controller for a pre-heat or stress relieving temperature profile. Definitions of the various terms found in the sub-menu screens are shown in Table 6-3. Typical programming examples are shown in Figure 6-1, Figure 6-2 and Figure 6-3.
- Access List: This screen is used to access the configuration and set-up sub-screens within the controller. This area is password protected and should only be used by an experienced operator.

 *Making changes in the Access List screens may cause the system to operate incorrectly.*

A series of keys at the bottom of the 2408 controller are used to navigate between and change values in the various screens on the controller display. Definition of the keys are as follows:

The “Page”  key advances the controller display between main screens (Run List, Prog List and Accs List).

The “Scroll”  key advances between various sub-menu screens in the main menus.

The “Up”  and “Down”  keys are used to change values in the sub-menu screens.

 *The two small round buttons on the front of the controller are disabled and nonfunctional.*

6-3-1-1. 2408 Controller Operation

The 2408 controller is configured to control the power source to achieve the temperature program that is entered in “Prog List”. The configuration of the controller contains two important elements that dictate how the controller switches between segments and how it protects against over-temperature conditions.

One element is called “Holdback”. This is a temperature window that the controller uses to determine the point at which it switches from segment-to-segment. The window is set to $\pm 10^{\circ}$. When operating within a temperature profile, the controller will not advance to the next segment until the actual temperature comes within 10° of the target temperature.

The second element is an alarm. This alarm value is set at 25° F. When the actual temperature exceeds the target temperature by 25° F, the controller shuts off the power source contactor to prevent overheating the part. When the temperature falls 2° F below the alarm temperature, the controller re-energizes the power source output.

6-3-2. Programming The 2408 Controller

Identify the “code” requirements for the heat treat.



For Preheat program refer to Figure 6-1.

For Postweld stress relief program refer to Figure 6-2.

For a complex stress relief program (multiple temperature rise and cool rates) refer to Figure 6-3.

Use worksheet in Figure 6-4 to help prepare either a pre- or post-heat temperature profile.

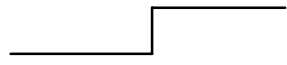
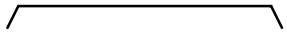
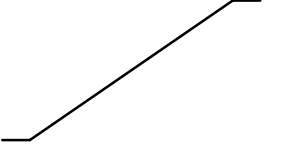
Table 6-3. Program List Terms And Definitions

$SEG.n$		Segment number
Segment Type Definitions		
Step ($STEP$)		The setpoint steps instantaneously from its current value to a new value.
Dwell ($dwell$)		The setpoint remains constant for a specified period. Dwell units ($dwell$) are in hours.
Ramp Time ($rmpt$) Ramp Rate ($rmpr$)		The setpoint ramps linearly, from its current value to a new value, either at a set rate (called <i>ramp-rate programming</i>), or in a set time (called <i>time-to-target programming</i>). You must specify the ramp rate, or the ramp time, and the target setpoint, when creating or modifying a program. Ramp units ($rmpt$) are in hours.
End (End)		A program either ends in this segment or repeats. You specify which is the case when you create or modify a program (see the final topic in this chapter). When a program ends, the programmer is put into either a continuous Dwell state with all outputs staying unchanged, or the Reset state.

The following parameters are available depending on the $TYPE$ selected						
	$STEP$	$dwell$	$rmpt$	$rmpr$	End	
EGT	√		√	√		Target setpoint for a “ $rmpt$ ” or “ $STEP$ ” segment.
$rATE$				√		Ramp rate for a “ $rmpr$ ” segment.
dwr		√	√			Dwell time for a “ $dwell$ ” segment.
$Endt$					√	End of prog – $dwell$, $STEP$, $STOP$.

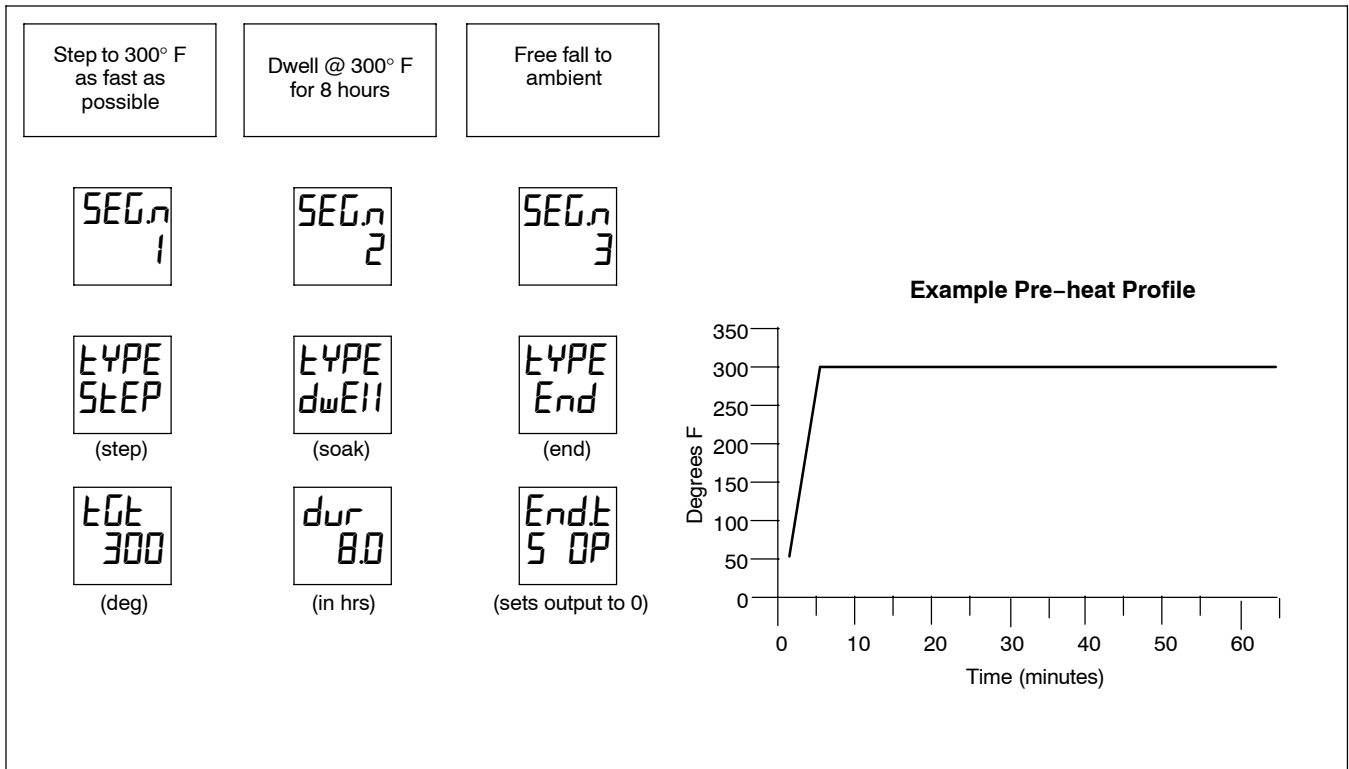

Figure 6-1. Setting Pre-heat Profile Using Example Parameters

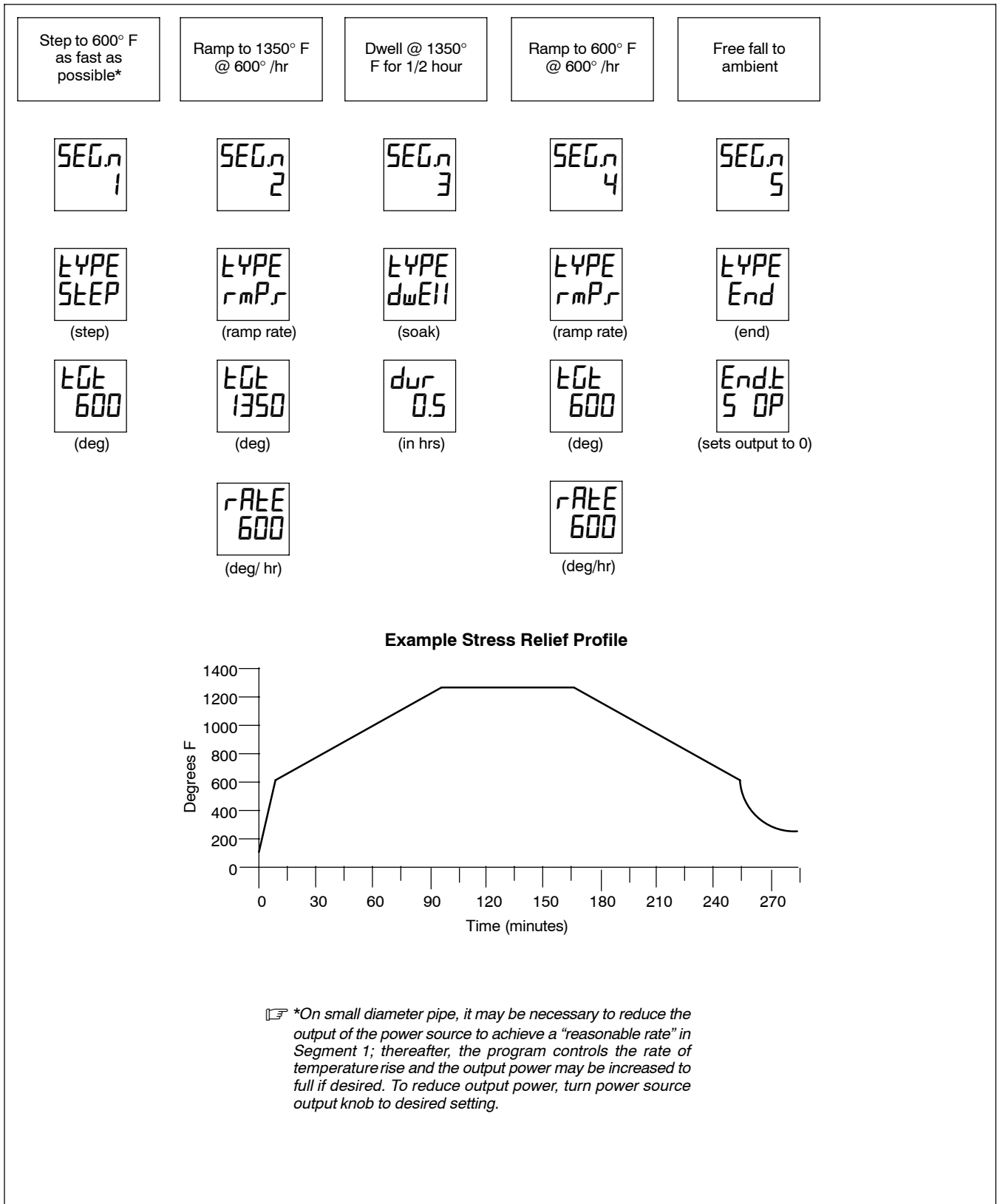

Figure 6-2. Setting Stress Relief Profile Using Example Parameters

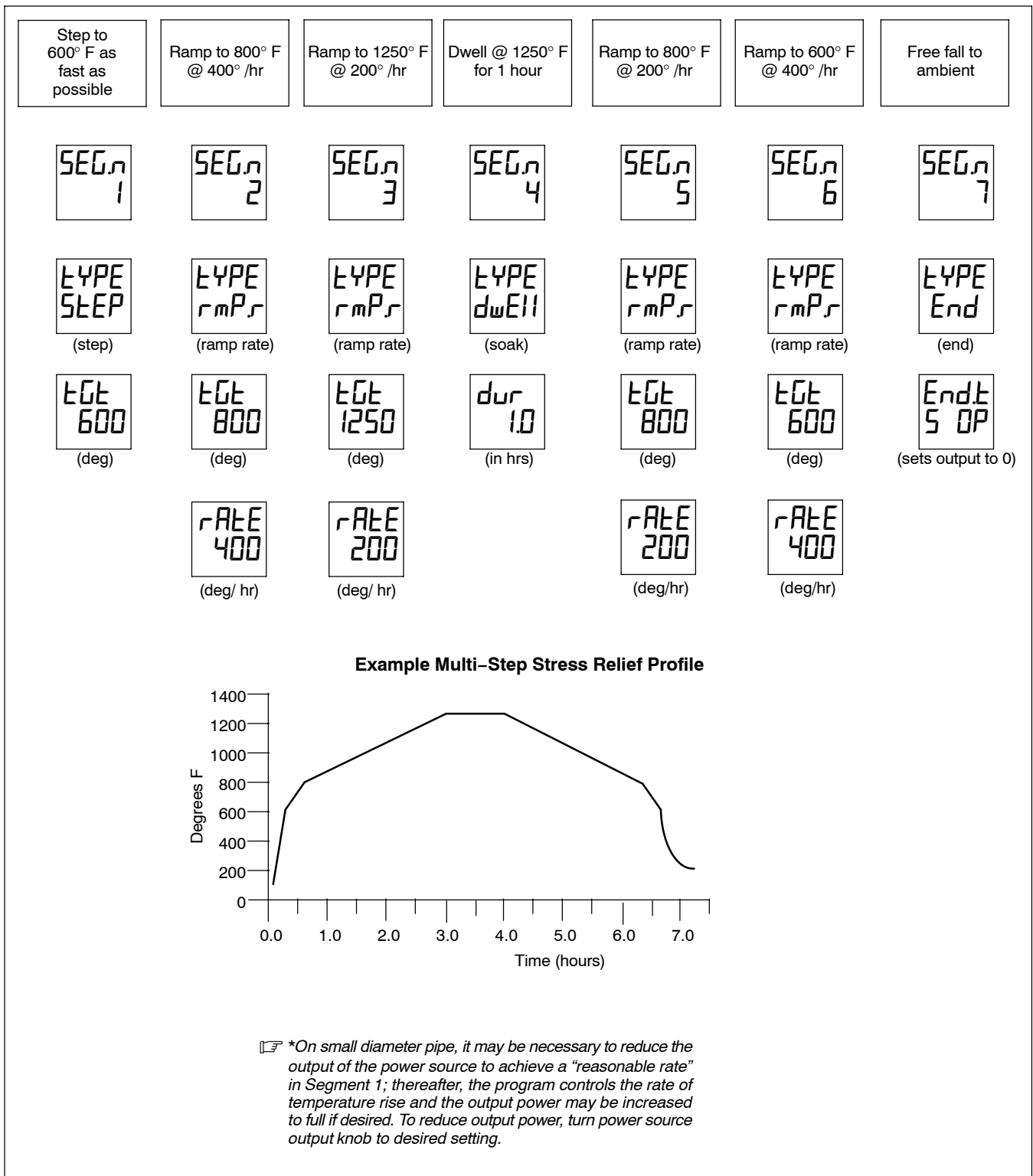

Figure 6-3. Setting A Complex Stress Relief Profile With Multiple Temperature Rise/Cool Rates Using Example Parameters

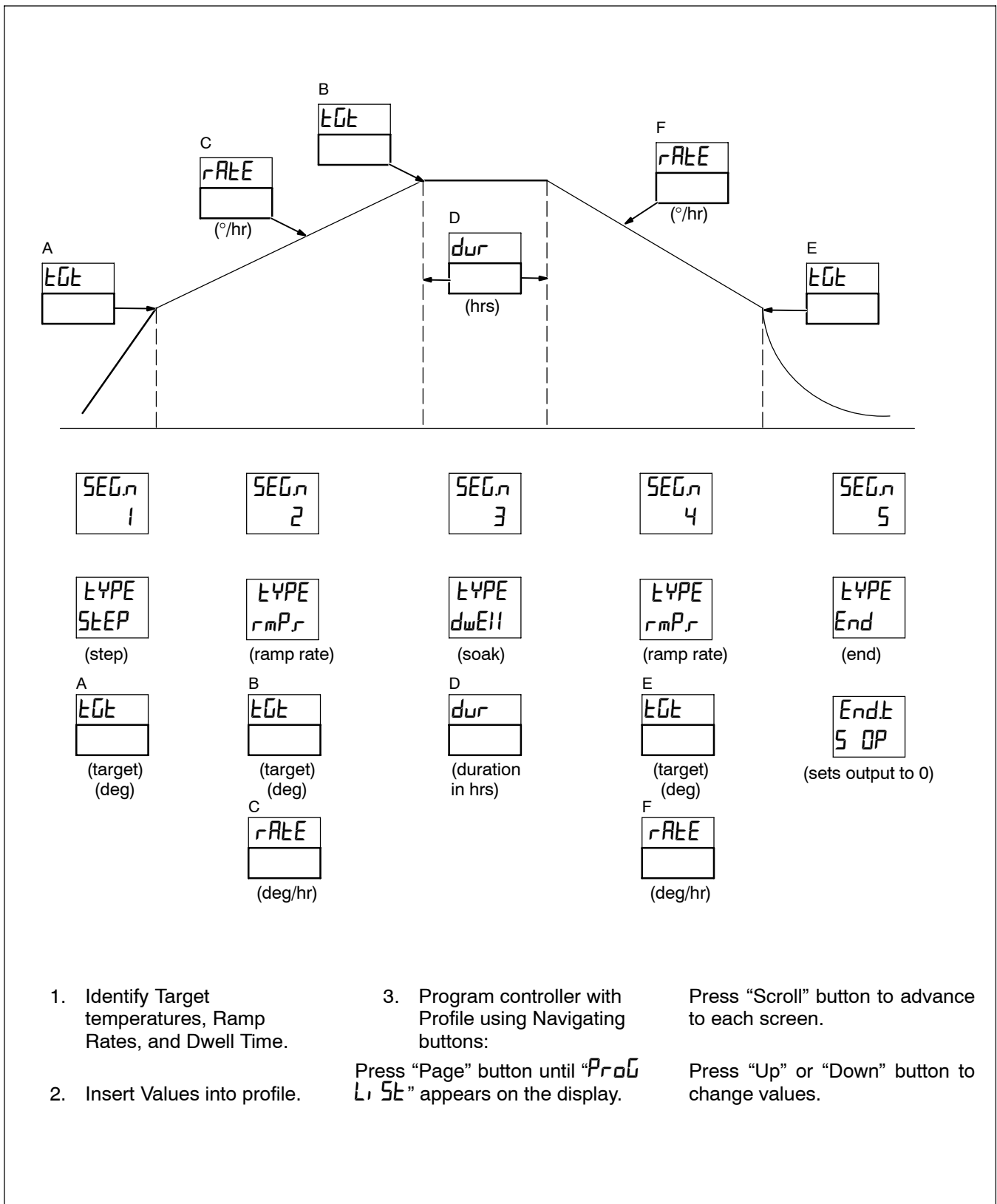

Figure 6-4. Profile Set-Up Worksheet

6-3-3. Batch Recording Using 5100 Digital Recorder

The batch file generated by the recorder will consist of:

GroupDescriptor~BatchName~TimeDateStamp.uhh

The default **Group Descriptor** is set to "Group". This setting may be changed to something that relates to the application (i.e. Company, Contract, or Project name).

To change the Group Descriptor, proceed as follows:

1. Log in as an Engineer (see Section 6-2-2-2).
2. Touch Menu (bottom right).
3. Touch Operator.
4. Touch Config.
5. Touch Groups.
6. Touch the field next to Descriptor, a keypad will appear on the display.
7. Enter the desired name and touch Ok.
8. Touch Apply.
9. Touch Menu (bottom right).
10. Touch Home.

The **Batch Name** is entered by the operator. This should be a unique name that identifies the part being heated. Since the same part may have Pre-heat (P), Bakeout (B), and Stress (S) procedures done to it, the batch name should include an indicator as to which process was done (i.e. W41-1307-2-S) where the S indicates a stress procedure.

The **Time Date Stamp** and **.uhh** file extension are both generated automatically by the recorder.

Begin Batch recording.

6-3-3-1. Login As User

1. Touch top left corner.
2. Touch pull down next to User.
3. Touch User from pull down list.

6-3-3-2. Start Recording

1. Touch "No Batch In Progress".
2. Touch "New".
3. Touch field next to Job # (Batch Name). This will be the batch name.
4. Enter unique Batch Name (see Section 6-3-3).
5. Touch "Ok".
6. Touch field next to User ID.
7. Enter User ID.
8. Touch "Ok".
9. Touch field next to Comments.
10. Enter Comments or, at least, touch the blank key.
11. Touch "Ok".
12. Scroll down to bottom of screen.
13. Touch field next to Rec. ID.
14. Touch the blank key (bottom right keyboard).
15. Touch "Ok".
16. Touch "Start".
17. Touch "Close".

6-3-3-3. Stop Recording

1. Touch the block with the batch name.
2. Touch "Stop".
3. Touch "Close" – screen returns to the home screen and displays "No Batch In Progress".

NOTE



If a batch file was not started, the temperature data is still recorded. The Job# (Batch Name), User, Comments, and Recorder ID are not recorded.

6-3-3-4. Saving Data To A Disk (Recommended After Each Batch)

1. Insert floppy disk into recorder.
2. Login as User (see Section 6-3-3-1).
3. Touch  key in bottom right corner to open Root Menu.
4. Touch "Operator".
5. Touch "Archive".
6. Touch "Disk".
7. Select how much data to save to floppy (typically, Last Day is sufficient).
Last day saves from 12:00am until current time. Last week saves from 12:00am Monday until current time.
Scroll down and wait until archive transfer changes from active to inactive.

NOTE



DO NOT remove floppy disk before completion of data transfer.

8. Touch  key in bottom right corner to open Root Menu.
9. Touch "Home".
10. Remove floppy disk.
11. To view data, go to Section 6-3-6.

6-3-3-5. Saving Data To A PC (Alternative To Floppy Disk)

6-3-3-5-1. Review Software – First Time Setup

1. Start "Review" software (see Section 6-3-7).
2. Click on "Instrument", "Setup", "TCP/IP".
3. Click on "Add Instrument".
4. In the "TCP/IP Address or Host Name:" field, type "192.168.111.222".
5. In the "Identifier:" field, type "Generic".
6. Click on "OK".

6-3-3-5-2. Creating A Shortcut – First Time Setup

Local Area Network Connection (Windows® 2000)

1. Click on "Start", "Settings", "Control Panel".
2. Open "Network and Dial-up Connections".
3. Right click on "Local Area Connection".
4. Select "Create Shortcut".
5. Click on "Yes" to create a shortcut on the desktop.

6. Close the "Network and Dial-up Connection" window.
7. Close the "Control Panel".

Network Connection (Windows® 95, 98, ME)

1. Click on "Start", "Settings", "Control Panel".
2. Right click on "Network".
3. Select "Create Shortcut".
4. Click on "Yes" to create a shortcut on the desktop.
5. Close the "Control Panel".

6-3-3-5-3. Changing IP Address To Connect The IH/TS

For Windows® 2000

1. Close any open network applications.
2. Double click "Local Area Connection" desktop shortcut.
3. Click on "Properties".
4. Scroll down to "Internet Protocol (TCP/IP)".
5. Click on "Internet Protocol (TCP/IP)" to highlight it.
6. Click on "Properties".
7. Click on "Use the following IP address:".
8. In the "IP address" field, type "192.168.111.221".
9. Click on "OK".
10. Click on "OK" to add the subnet mask.
11. The "Subnet mask:" field should display "255.255.255.0".
12. Click on "OK".
13. Click on "OK".
14. Click on "Close" to close the "Local Area Connection" window.

For Windows® 95, 98, ME

1. Close any open applications (Windows will restart to apply settings).
2. Double click "Network" desktop shortcut.
3. Scroll down to "Internet Protocol (TCP/IP)".
4. Click on "Internet Protocol (TCP/IP)" to highlight it.
5. Click on "Properties".
6. Click on "Specify an IP address:".
7. In the "IP address" field, type "192.168.111.221".
8. Click on "OK".
9. Click on "OK".
10. Click on "Yes" to restart the computer and have changes take effect.

6-3-3-5-4. Downloading Files From Recorder

1. Connect a crossover cable between the IH/TS recorder and the PC (a crossover cable is a special network cable with pins 2 and 3 reversed on one end).
2. Start "Review" software (see Section 6-3-7).

3. Click on "Instrument", "File Services".
4. Click on "Generic".
5. Enter user name: "user" (leave password field blank).
6. Click on "OK".
7. Right click on desired files and transfer them following the procedures in Sections 6-3-6 and 6-3-7.

6-3-3-5. Troubleshooting Connection Problems

1. Click on "Start", "Programs", "Accessories", "Command Prompt".
2. Type in "ping 192.168.111.222".
3. Press "Enter".

If the message "Timed Out" appears 4 times, the recorder is not responding. Check unit setup outlined previously and verify crossover cable is connected properly.

6-3-3-5-6. Resetting IP Address (Necessary To Connect User's PC To Company's Network)

For Windows® 2000

1. Close any open network applications.
2. Double click "Local Area Connection" desktop shortcut.
3. Click on "Properties".
4. Scroll down to "Internet Protocol (TCP/IP)".
5. Click on "Internet Protocol (TCP/IP)" to highlight it.
6. Click on "Properties".
7. Click on "Obtain an IP address automatically".
8. Click on "OK".
9. Click on "OK".
10. Click on "Close" to close the "Local Area Connection" window.

For Windows® 95, 98, ME

1. Close any open applications (Windows will restart to apply settings).
2. Double click "Network" desktop shortcut.
3. Scroll down to "Internet Protocol (TCP/IP)".
4. Click on "Internet Protocol (TCP/IP)" to highlight it.
5. Click on "Properties".
6. Click on "Obtain an IP address automatically".
7. Click on "OK".
8. Click on "OK".

6-3-4. Running A Program To Preheat Or Stress Relief

To start the Heat Treat operation, proceed as follows:

Press the "RUN" button – The blue "Heat On" light turns on and the power source energizes.
The power source parameters are displayed on the "Parameter Display".
The controller flashes "Hold" until the measured temperature climbs to within the "Hold Back" window (10°) of the target temperature.

To adjust profile during the Heat Treat operation, proceed as follows:

Press the "HOLD" button – The controller displays "HOLD", but the heat is maintained at the present target temperature.

Press  "Page" button until "PrOg LISt" appears on the display.

Press  "Scroll" button to select the desired parameter for changing.

Use  or  "Up" or "Down" button to change value.

Press  "Page" button until parameter screen appears on the display.

Press "RUN" button to resume program.

When cycle completes or to abort the process, fully press the "STOP" button – controller resets to segment 1 and power source contactor relays open.

6-3-5. Recovering From An Interruption

Press the "RUN" button to start profile.

NOTE

There are two conditions the controller looks at to determine:

- 1) If it should supply output power and
- 2) If the power source contactor should be on.

1) If the current temperature is more than 10 °F above the target temperature in segment 1, the IH/TS will not require output from the power source. The blue **Heat On** light will be **on** and power source will not provide output. (Providing the Panel/Remote switch on the power source is in the remote position.)



2) If the current temperature is more than 25 °F above the target temperature in segment 1, the blue **Heat On** light will be **off** and the system will not provide power. (Regardless of Panel/Remote switch position.)

To continue from the current part temperature, rather than waiting for the part temperature to fall to within 10° of segment 1's target temperature:

Press the "HOLD" button – The controller displays "HOLD".

Press  "Page" button until "Prog List" appears on the display.

Press  "Scroll" button to *SEG 1's* temperature setting.

Use  or  "Up" or "Down" button to adjust target temp to the current temperature of +5° F.

Press  "Page" button until parameter screen appears on the display.

Press "RUN" button to resume program – the controller will step to the new target temperature setting and continue through the remainder of the profile.

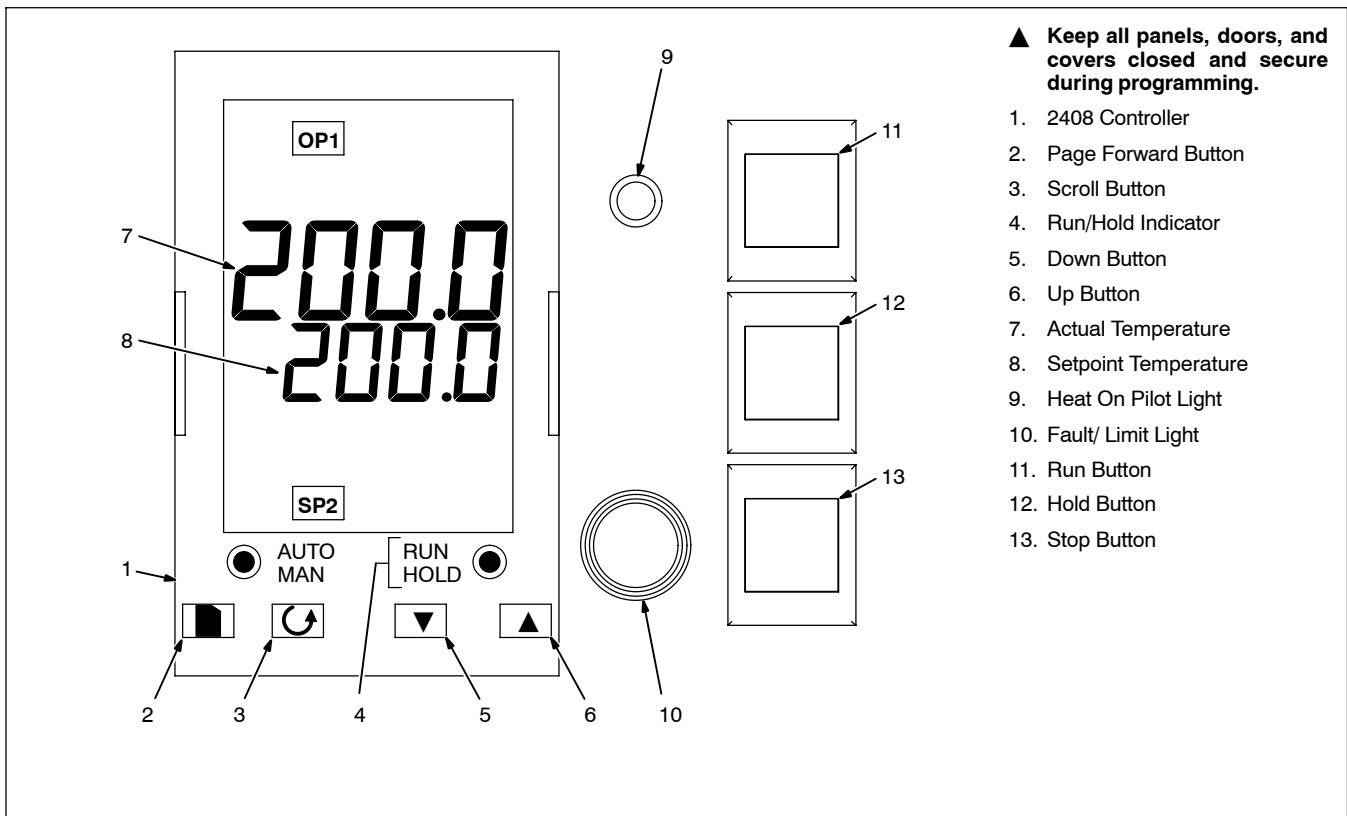

6-3-6. Viewing Data In Review Software

6-3-6-1. Installing Review Software And First Time Setup

Insert the “Chessell 5000 Series Data Management System” CD into the computer.

If the installation program does not automatically start, browse to the CD using “My Computer” and run “Setup.exe”.

Place a check in the box next to “Review”. The other components are optional. Additional information about the software can be found in the readme.txt file on the CD.

Click “Install Recorders Software” and accept the default settings of the software installation.

This Owner’s Manual will guide you through the steps to create and save a chart for a batch file. Additional information on the Review software is available under Start\Programs\Eurotherm\Manuals\Review Manual.

The first time Review software is launched, a message box will be displayed to enable “Review Full features”. Place a check in the box for “Don’t ask me this again”, then click “No”.

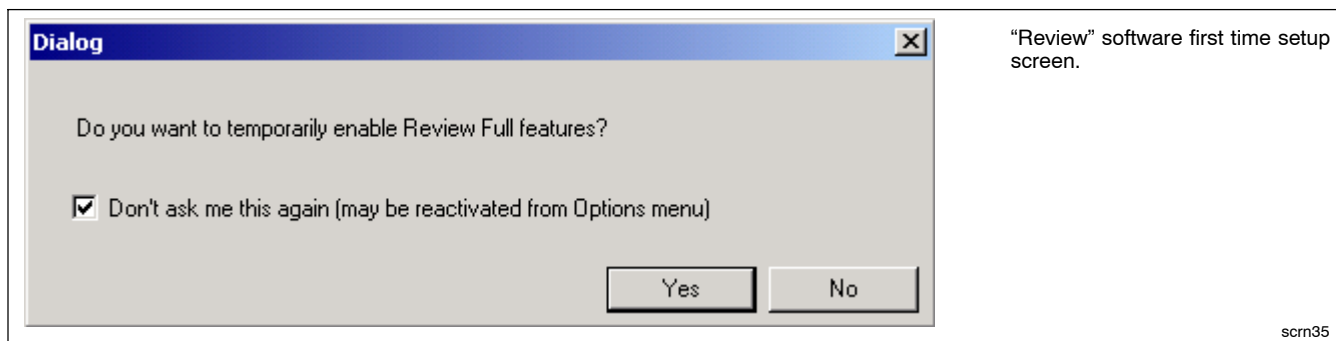

6-3-6-2. Backing Up The Database

When Review software is used, archive data is stored in a database on the PC. As files are transferred to the database, the “Review.erv” file size increases. Data transferred into the database can be deleted, but not moved. If the “Review.erv” file size reaches 1 gigabyte, data will need to be deleted or a new database will need to be created. Refer to the Review Manual for additional instructions.

When data is transferred to the review.erv database, the original.uhh data file is simultaneously copied to the Master Archive Folder.

To change the location of the Master Archive Folder, proceed as follows:

In Review software, click “Options”.

Click “Master Archive Folder”.

Change the “Master Archive Folder” location as desired. If a network drive is available, multiple users can use the same database. Refer to the Review Manual for further instructions.

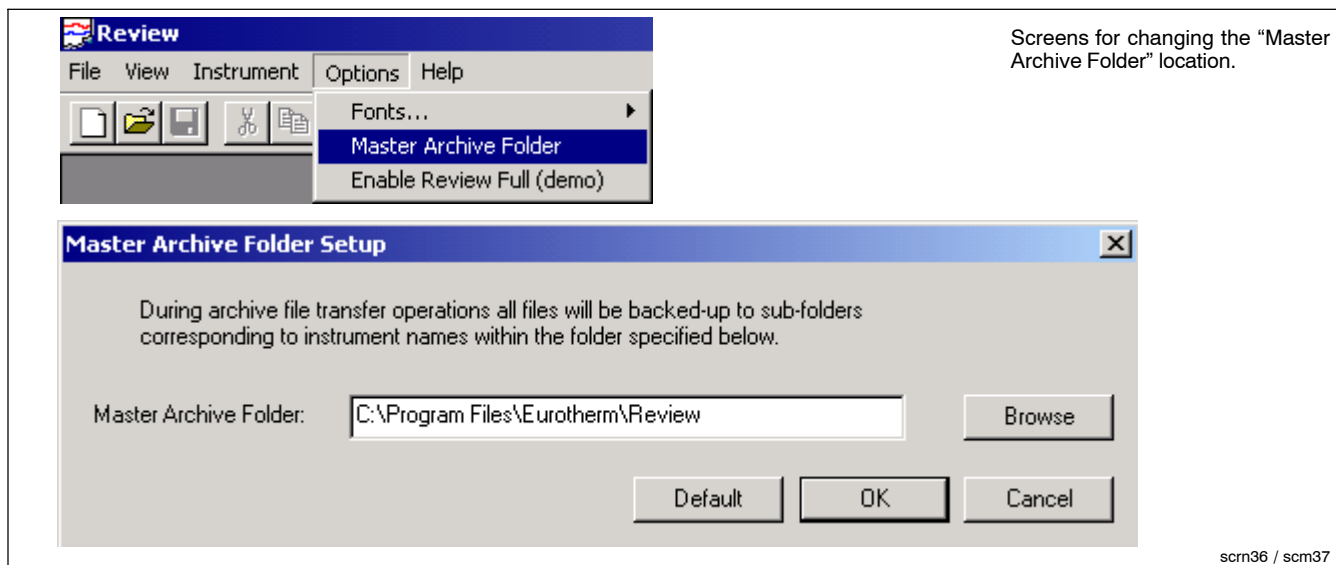

There are three files used to produce a chart in Review software as follows:

1. The .uhh file contains the actual temperature data downloaded from the recorder.
2. The c:\Program Files\Eurotherm\Review\Review.erv file contains a copy of the original data and any annotations added in the Review software.
3. The .cgp file contains the chart graphical properties (setup).

To prevent loss of data due to software or hardware failure, all three file types should be backed up on a regular basis.

6-3-7. Running Review Software

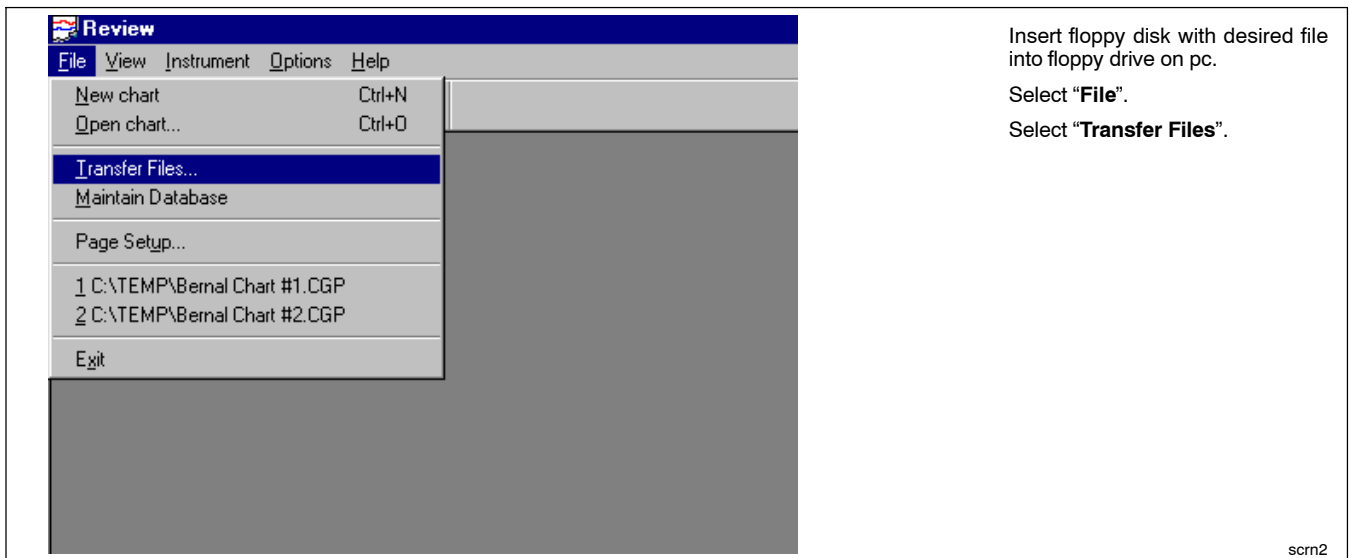
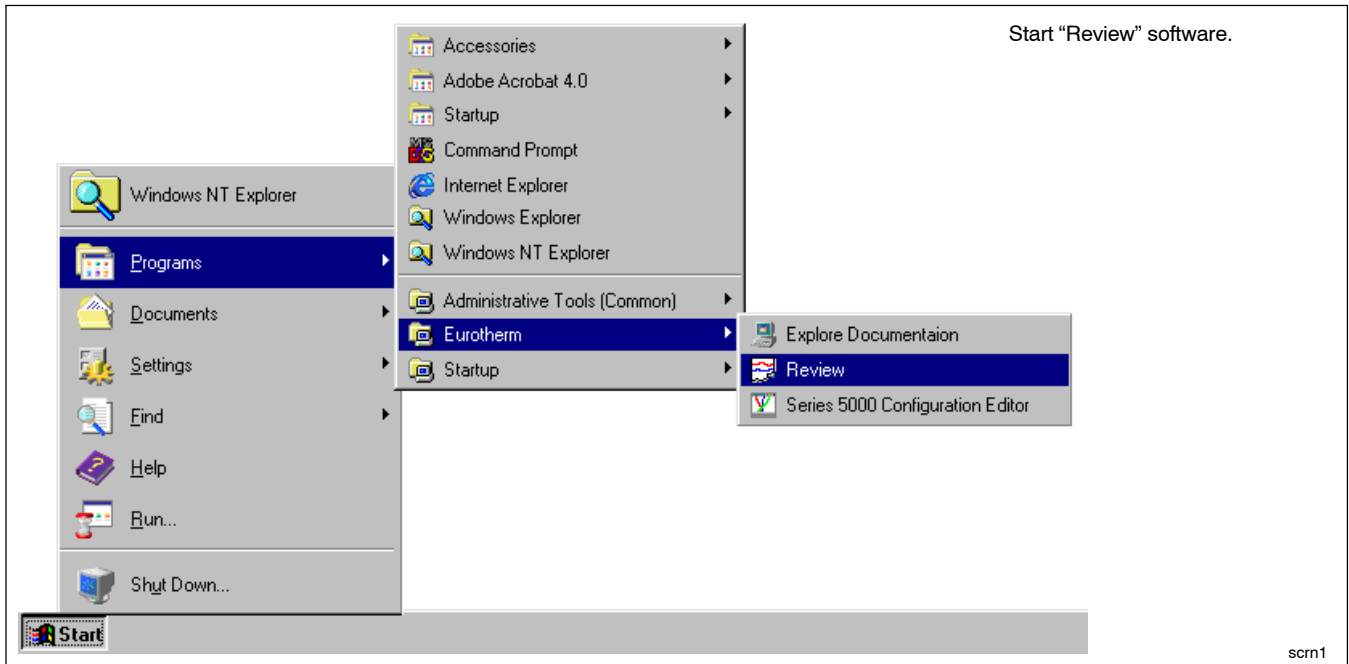

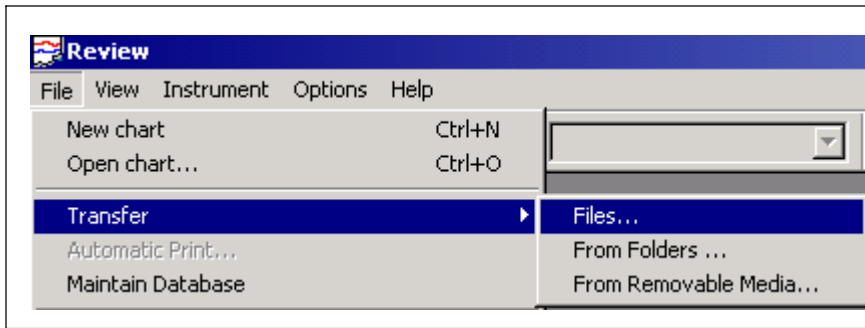

Select "Files".

scrn38

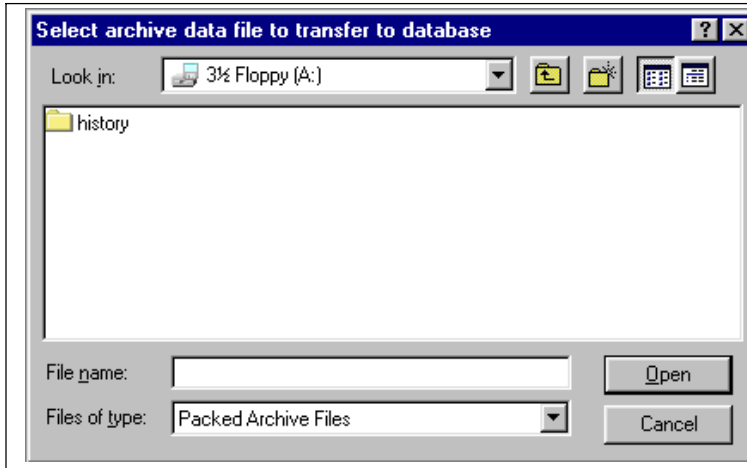

Select the "history" folder on the floppy drive or browse to the folder on the PC that contains the .uhh files.

scrn3

Single File With Batch Name

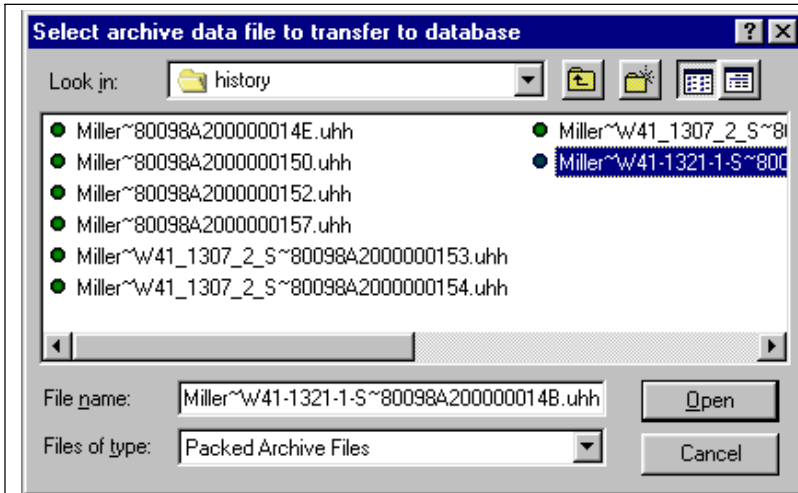

Select the desired file (highlight file name).

The file name consists of:

Group_Descriptor-Batch_Name-Time/Date_stamp.uhh

For example: Miller~W41-1321-1-S~80098A200000014B.uhh

Select "Open".

scrn4

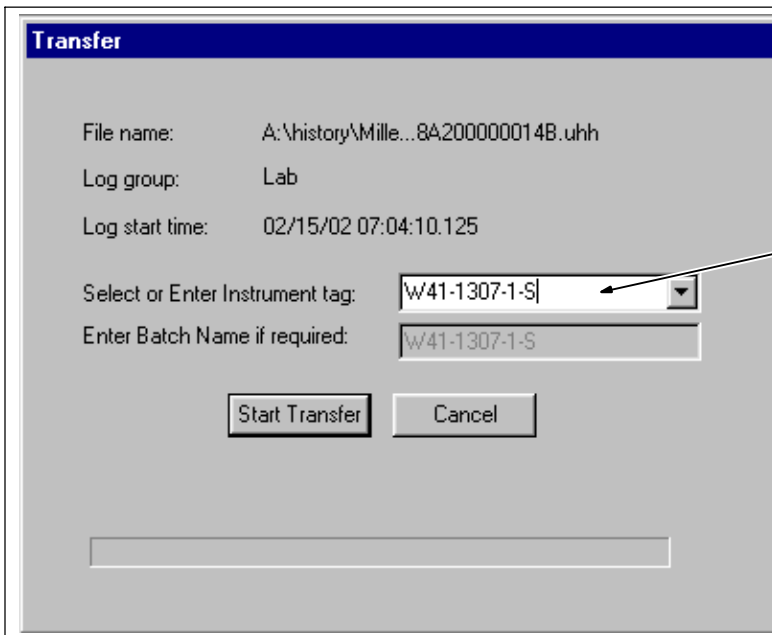

Enter the Job# (Batch Name) in the field next to "Select or Enter Instrument tag:"

This is the "File name" the information will be stored in.

Select "OK".

Proceed to "New Instrument" pop-up window (top of page 37).

scrn5

Single File With No Batch Name

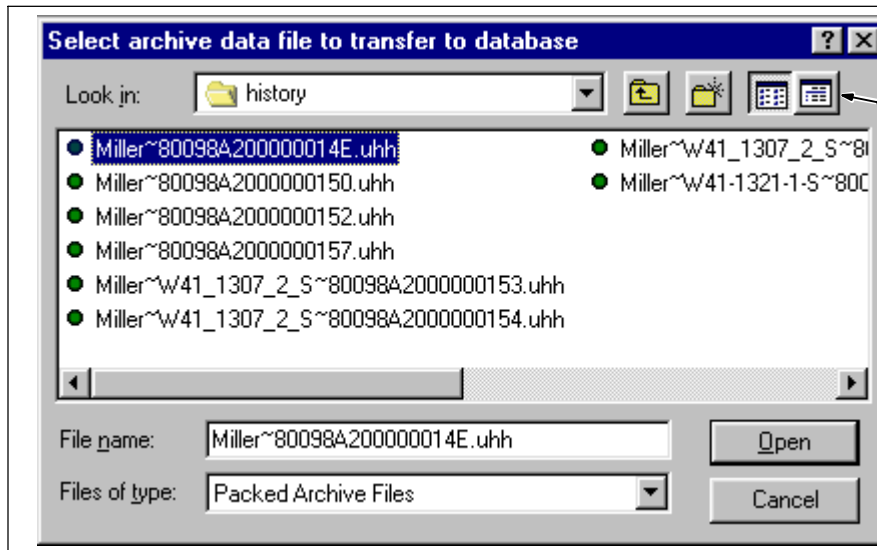

Data is continuously stored in the recorder. If a batch was not started, the temperature data is still recorded. The Job# (Batch Name), User, Comments and Recorder ID are not recorded. The file name would consist of: Group_Descriptor-Time/Date_stamp.uhh (no Batch Name). The file creation time can be found using the Detail Button. Select the desired file. Select "Open".

scrn6

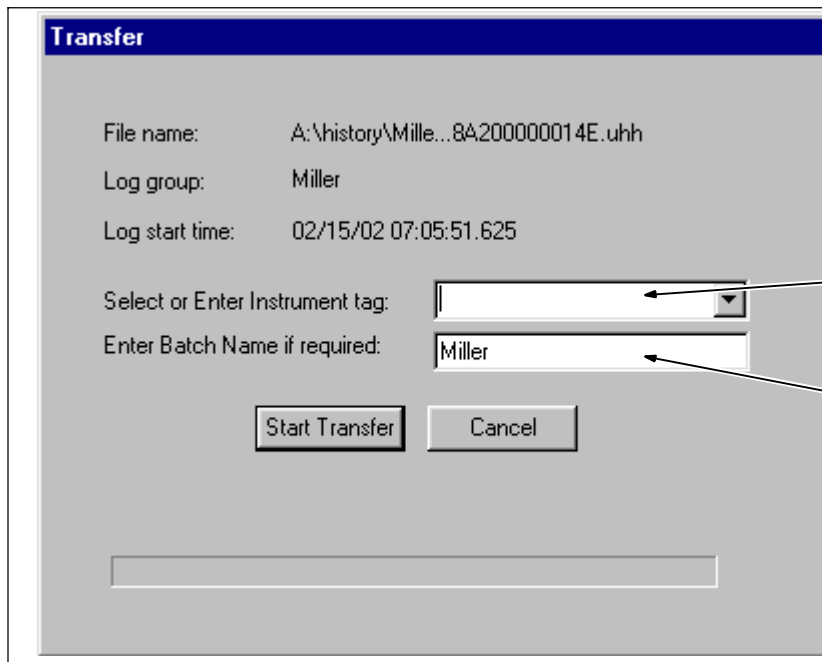

Enter the Job# (Batch Name) in the field next to "Select or Enter Instrument tag:". This is the "File name" the information will be stored in. If a batch was not started, enter the Job# (Batch Name) in the field next to "Enter Batch Name if Required:" as well. Select "Start Transfer". Proceed to "New Instrument" pop-up window (top of page 37).

scrn7

Multiple Files With Batch Names

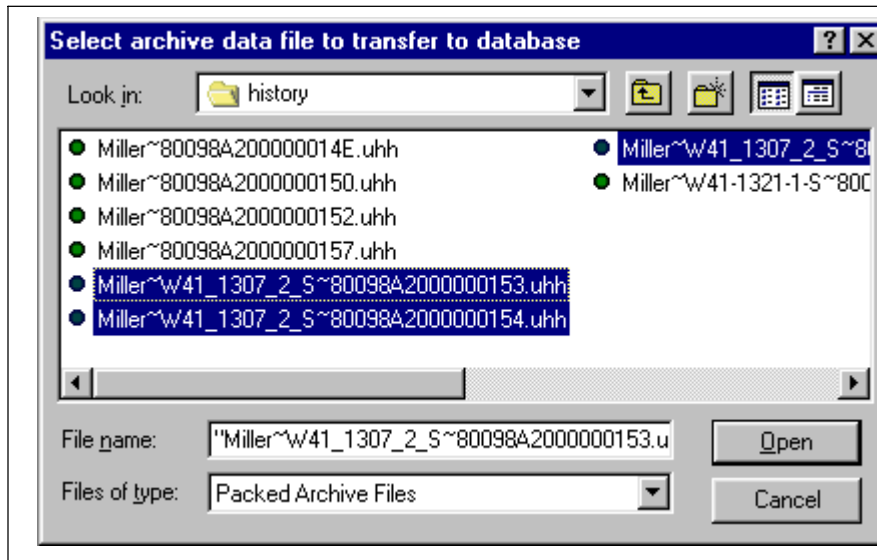

Data is continuously stored in the recorder. The file name consists of:
Group_Descriptor-Batch_Name-Time/
Date_stamp.uhh
Select the desired files.
Select "Open".

scrn8

Multiple Files With No Batch Names

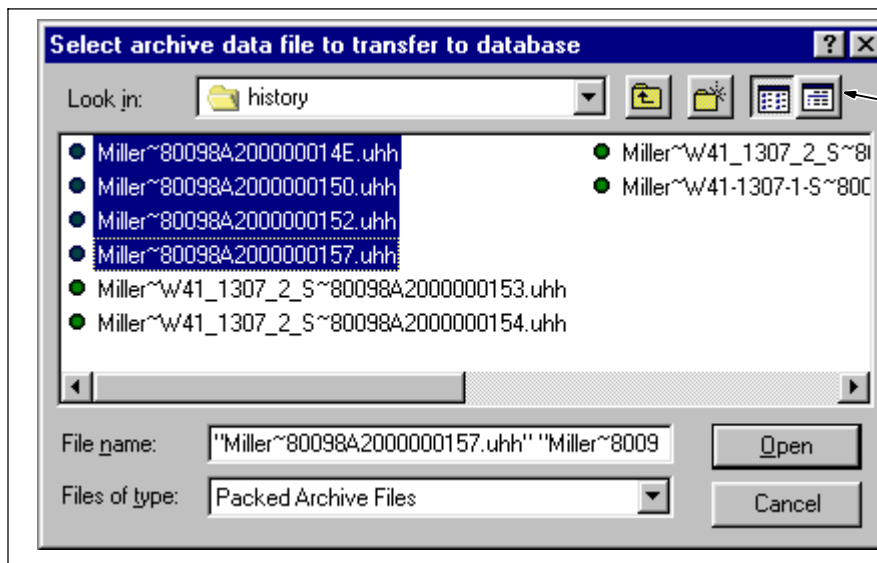

If a batch was not started, the temperature data is still recorded. The Job# (Batch Name), User, Comments and Recorder ID are not recorded.
The file name would consist of:
Group_Descriptor-Time/Date_stamp.uhh (no Batch Name).
The file creation time can be found using the Detail Button.
Select the desired files.
Select "Open".

scrn9

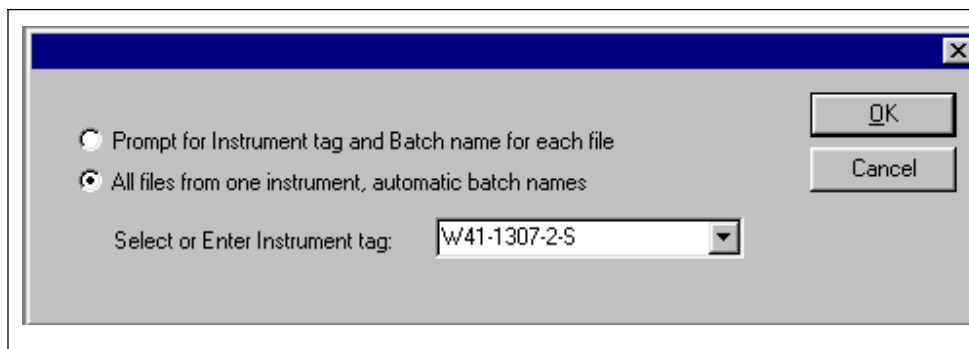

Select "All files from one instrument, automatic batch names".
Enter the Job# (Batch Name) in the field next to "Select or Enter Instrument tag:"
This is the "File name" the information will be stored in.
Select "OK".
Proceed to "New Instrument" pop-up window (top of page 37).

scrn10



New instrument is displayed.
Select **"OK"** to add the Instrument tag.

scrn11

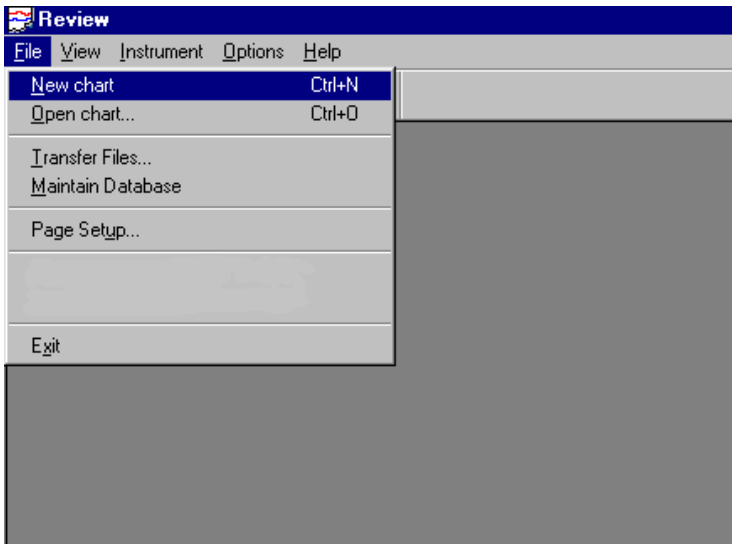

Select **"File"**.
Select **"New Chart"**.

scrn12

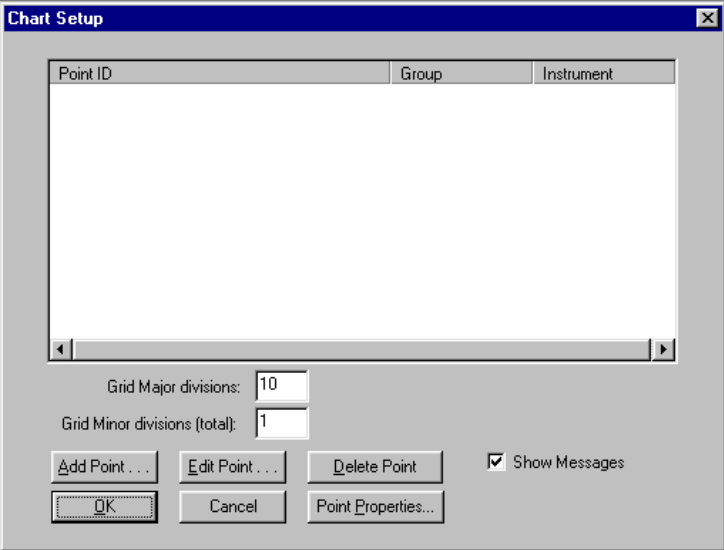

Select **"Add Point"**.

scrn13

Select Point [X]

Instrument: W41-1307-1-S

Log Group:

Point ID(s):

TC 1	(ANIN1)
TC 2	(ANIN2)
TC 3	(ANIN3)
TC 4	(ANIN4)
TC 5	(ANIN5)
TC 6	(ANIN6)

Buttons: OK, Cancel, Add All

Select Instrument, this is the Instrument tag [Job# (Batch Name)] that was entered previously.

scrn14

Select Point [X]

Instrument: W41-1307-2-S

Log Group: Miller

Point ID(s):

TC 1	(ANIN1)
TC 2	(ANIN2)
TC 3	(ANIN3)
TC 4	(ANIN4)
TC 5	(ANIN5)
TC 6	(ANIN6)

Buttons: OK, Cancel, Add All

Select the appropriate Log Group.
 Select Point ID to add a specific point, then select "OK"
 or
 Select "Add All".

scrn15

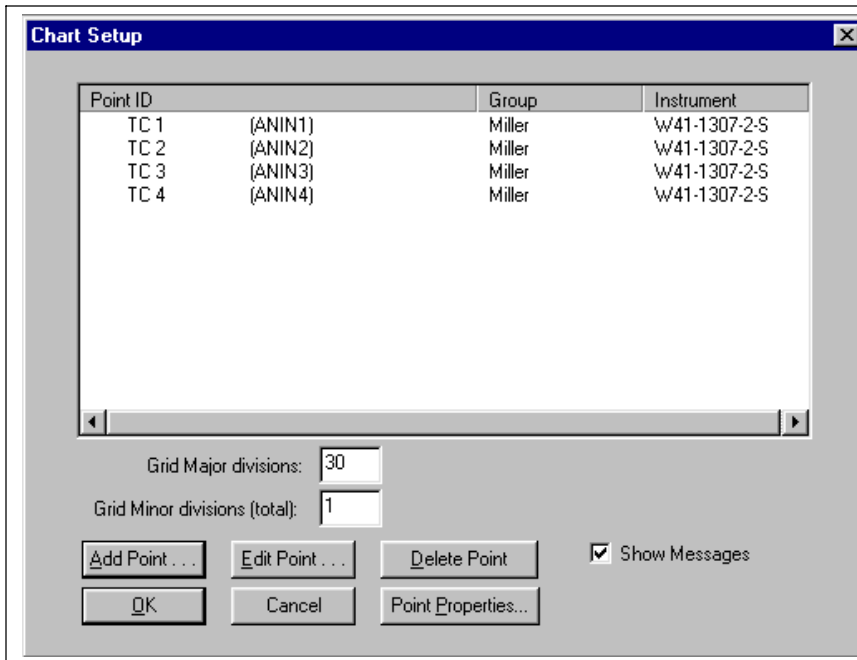

Change "Grid Major divisions:" to 30 resulting in 50° increments from 0-1500° F.

Select "OK" to view chart

scrn16

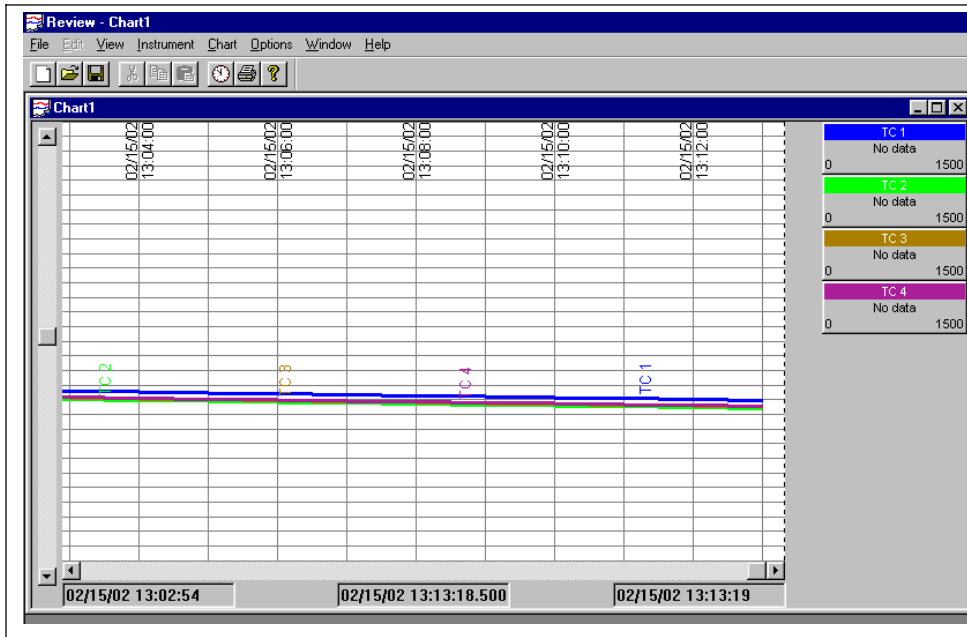

This display is the default view of the profile. Note the values show "No data" which is due to the dashed line on the right side of the screen being outside of the data values.

scrn17

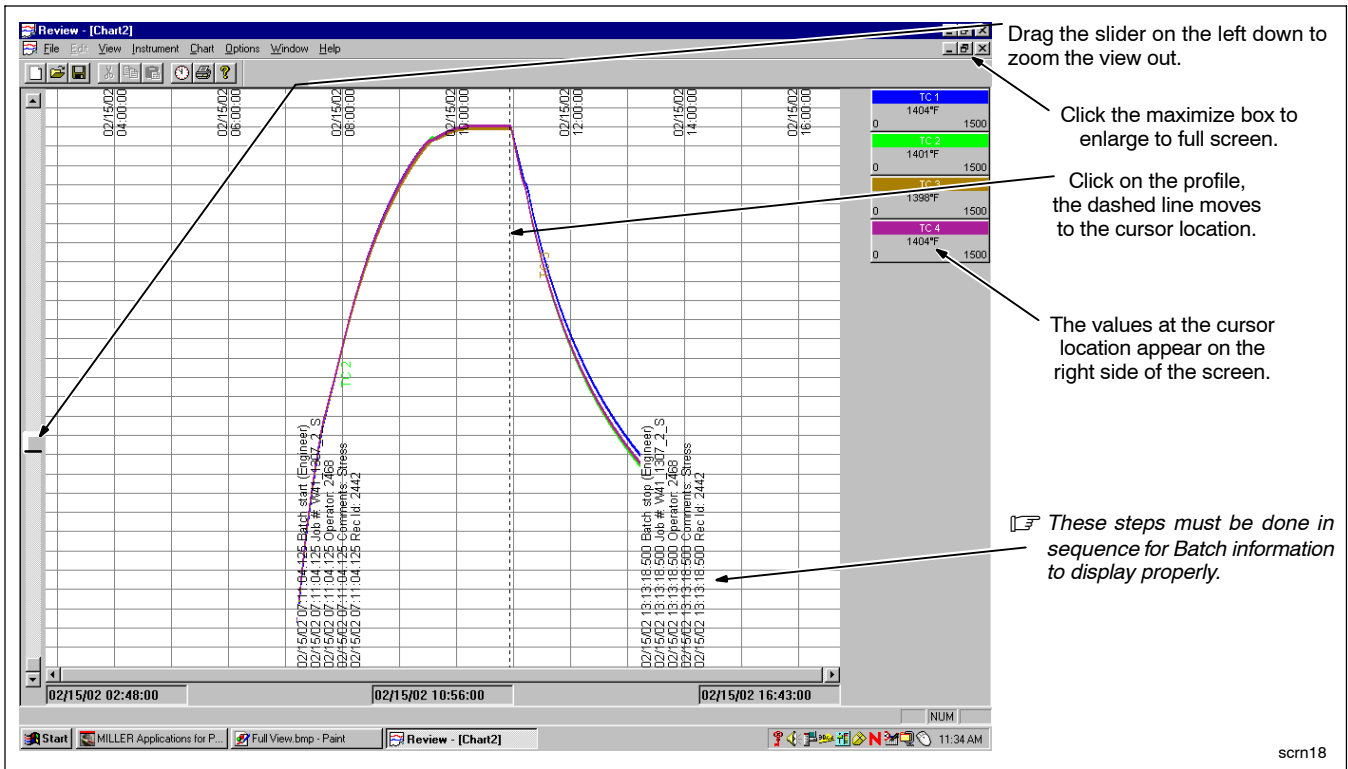

Drag the slider on the left down to zoom the view out.

Click the maximize box to enlarge to full screen.

Click on the profile, the dashed line moves to the cursor location.

The values at the cursor location appear on the right side of the screen.

These steps must be done in sequence for Batch information to display properly.

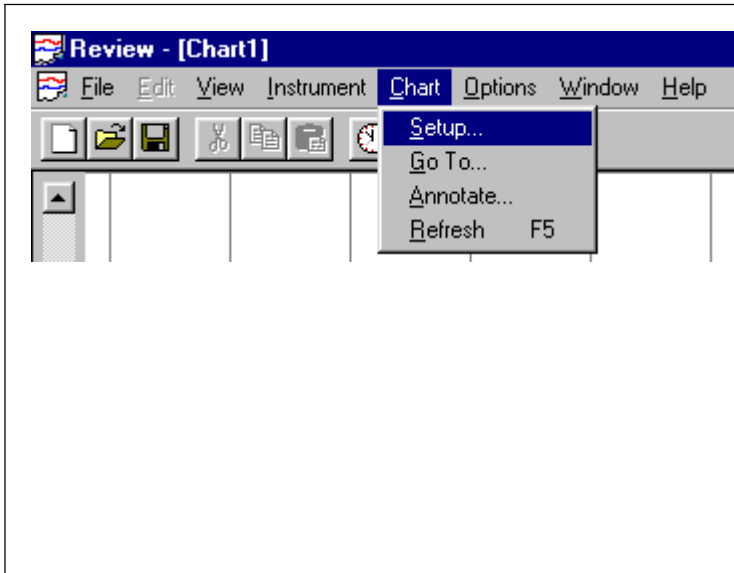
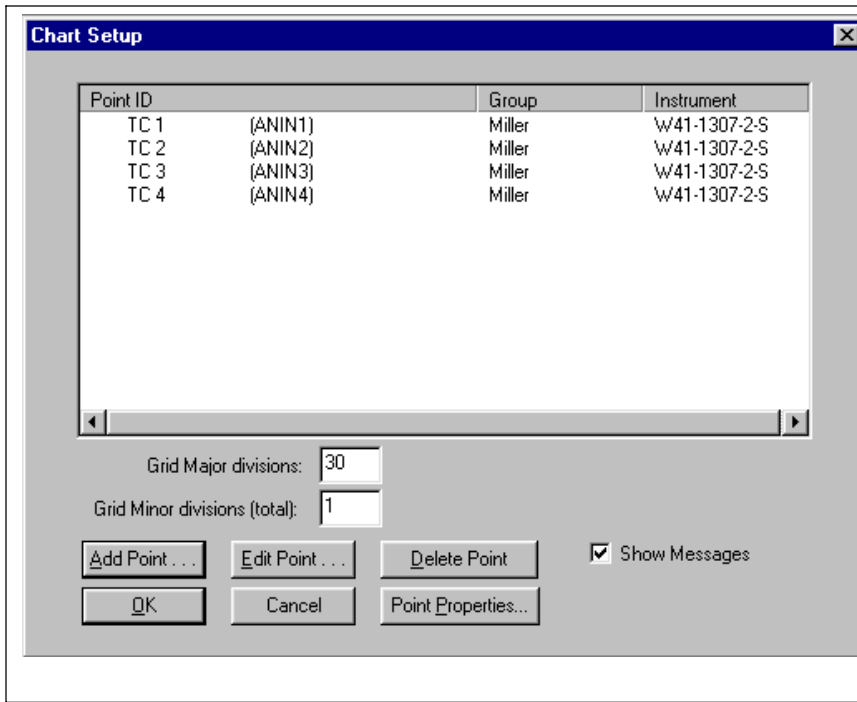

Chart properties may be edited by selecting "Chart", then "Setup".



To remove a TC, click on the TC# (Point ID), then click **"Delete Point"**.

To edit a TC trace properties, select a TC# (Point ID), then click **"Point Properties..."**.

Select **"OK"** to return to the chart.

scrn20

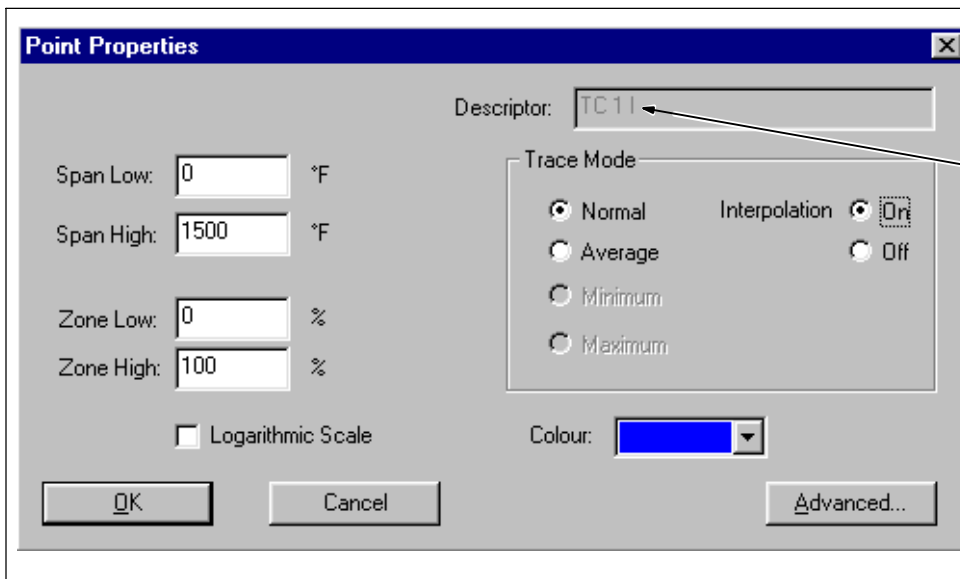

Span – dictates the range of temperature to plot for the trace.

Interpolation On – will show a smoothed line between points instead of steps.

Interpolation adds an "I" to end of descriptor.

Select **"OK"** when done.

scrn21



Comments can be added to the chart by selecting "Annotate" from the **Chart Menu**.

scrn22

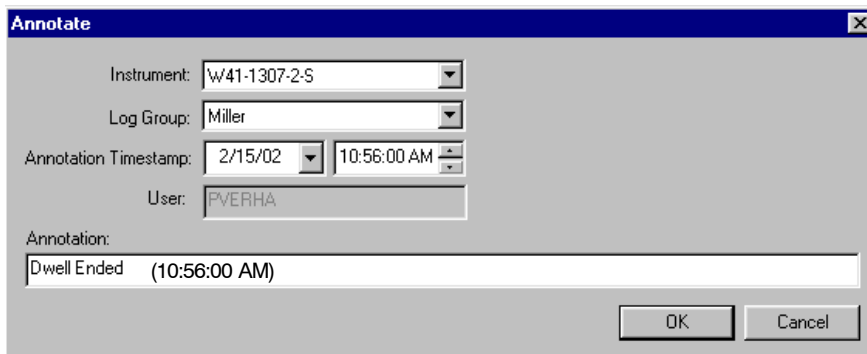

Add comments in the Annotation field.

Add time manually.

Select "OK".

scrn23

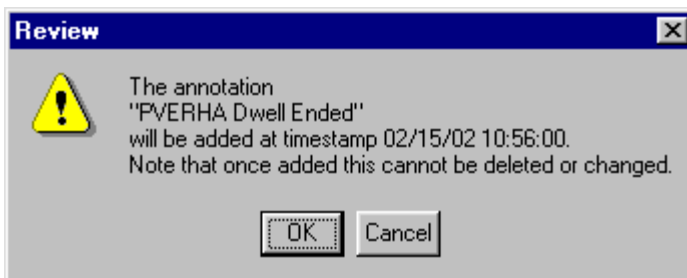

A warning will appear on the display stating that once added, the comment cannot be deleted or changed.

Select "OK".

The comment becomes part of the chart.

scrn24

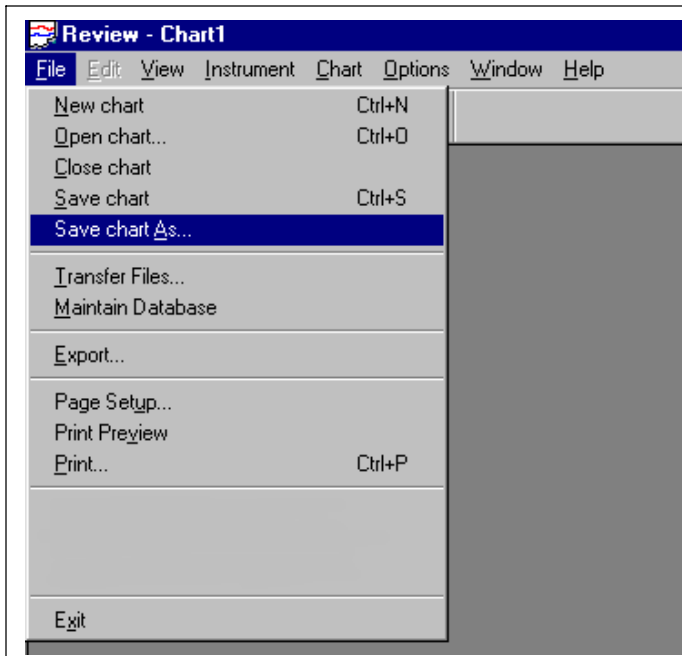

Save chart to floppy disk by selecting "File", then select "Save chart As..."

scrn25



Select a path to "Save in".
Enter "File name" to save as.

File name should be the same as the Instrument name and Job# (Batch Name) for consistency.

Select "Save".

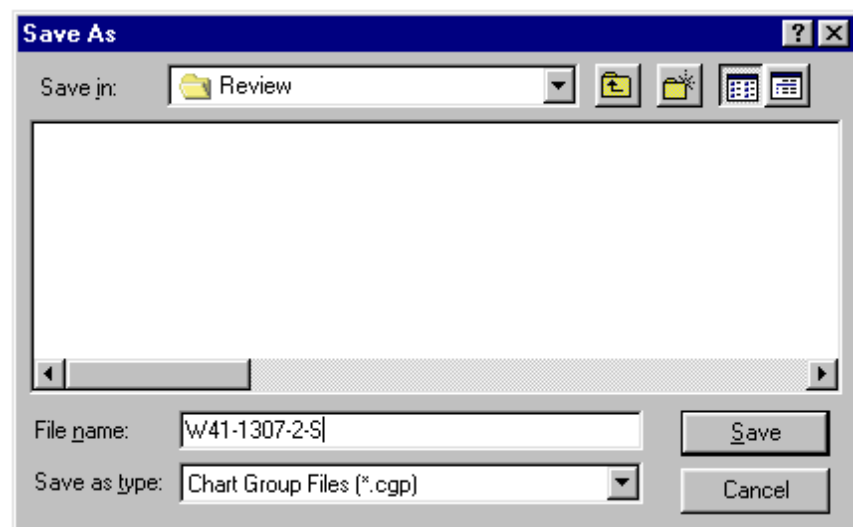

scrn26 / scrn27

The file name becomes part of the chart

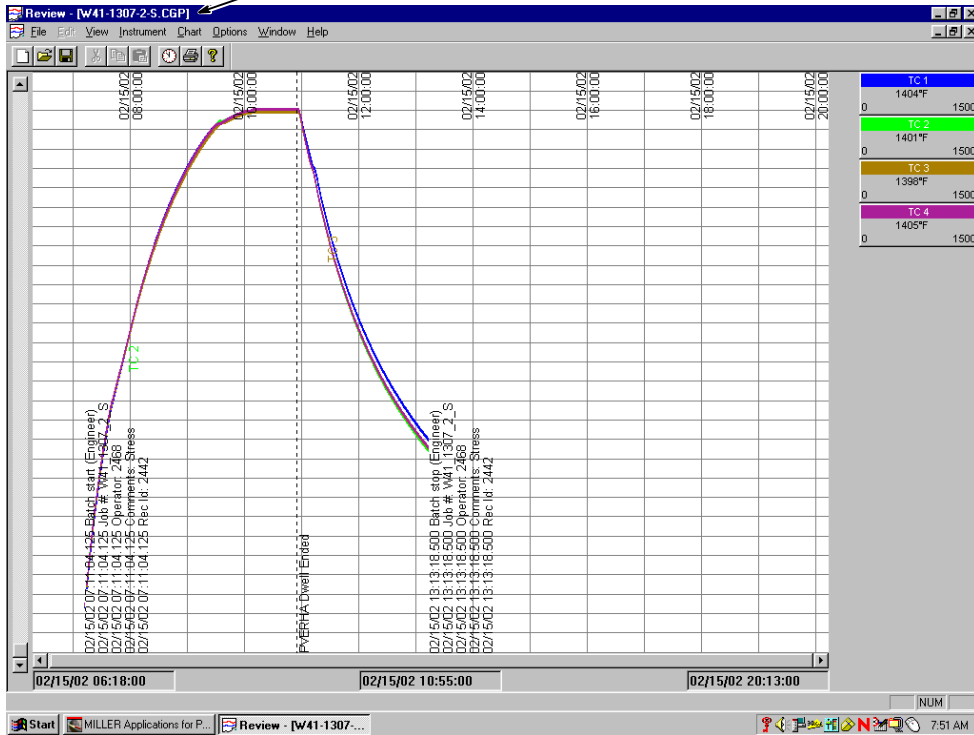

scrn28

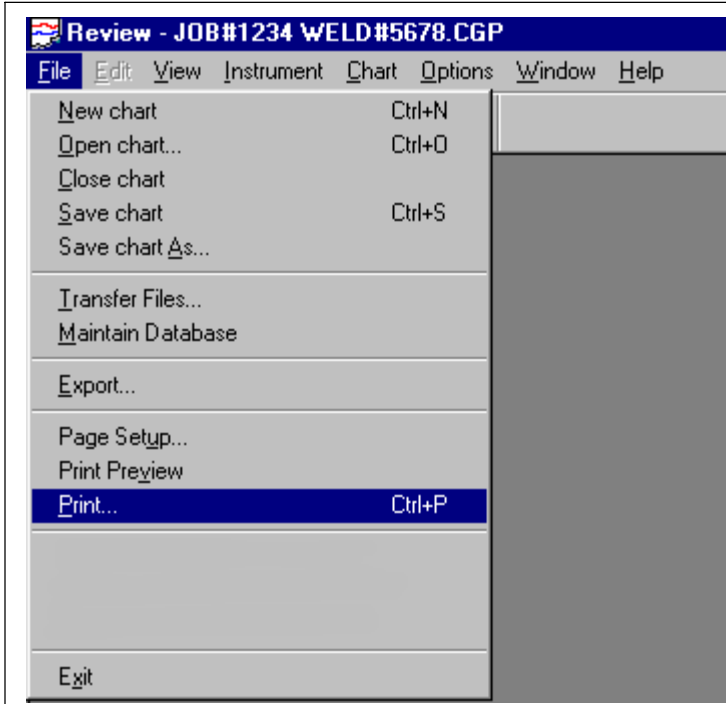

Select "File".

Select "Print" to print entire profile on one page.

scrn29

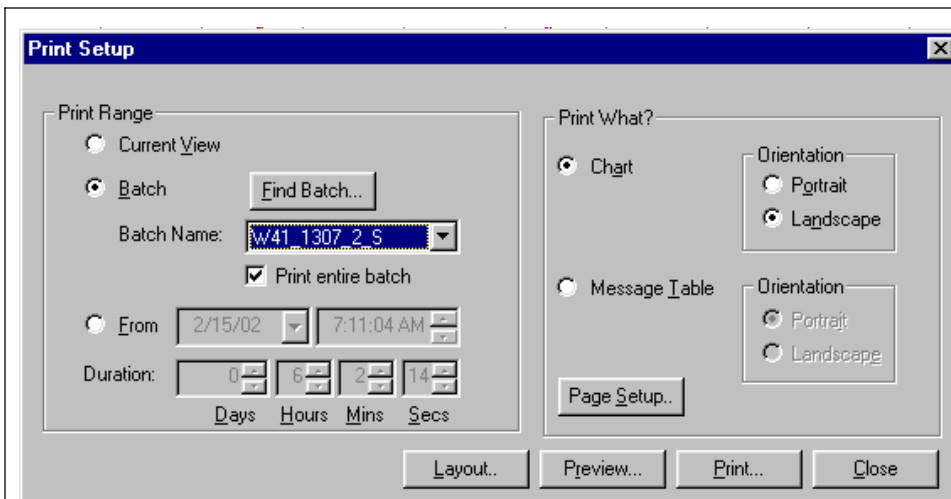

Select **"Batch"**.

Click in check box to select **"Print entire batch"**.

Select **"Batch Name"** from pull down menu.

Select **"Print"**.

scrn30

6-3-8. Typical Profile Chart Printout

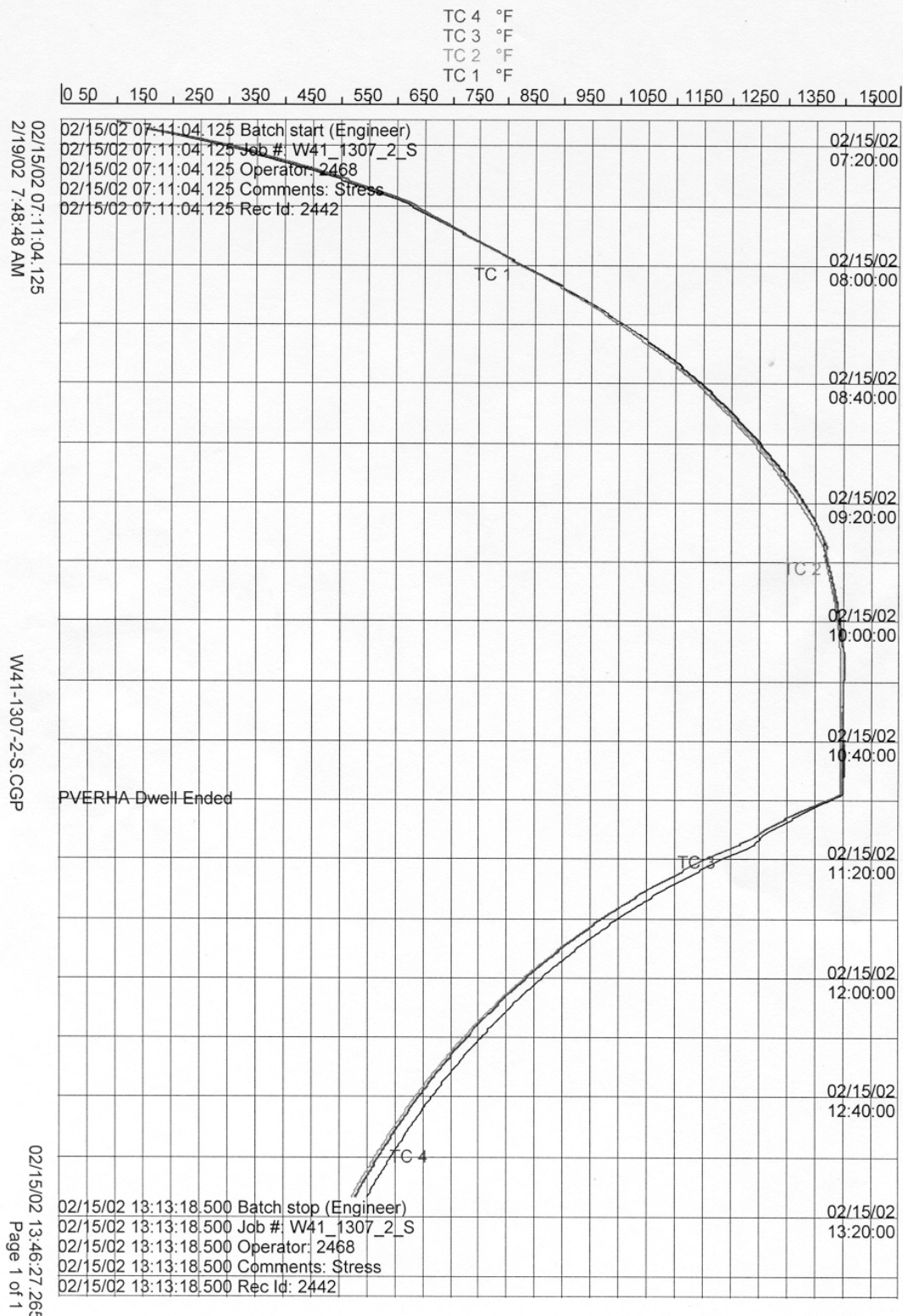

SECTION 7 – CONFIGURING CONTROLLER AND RECORDER

7-1. Changing Controller Operating Window, Ramp, Dwell, Or Temperature Units

NOTE

Use the following instructions if changes are required to Operating Window, Ramp, Dwell, or Temperature units.

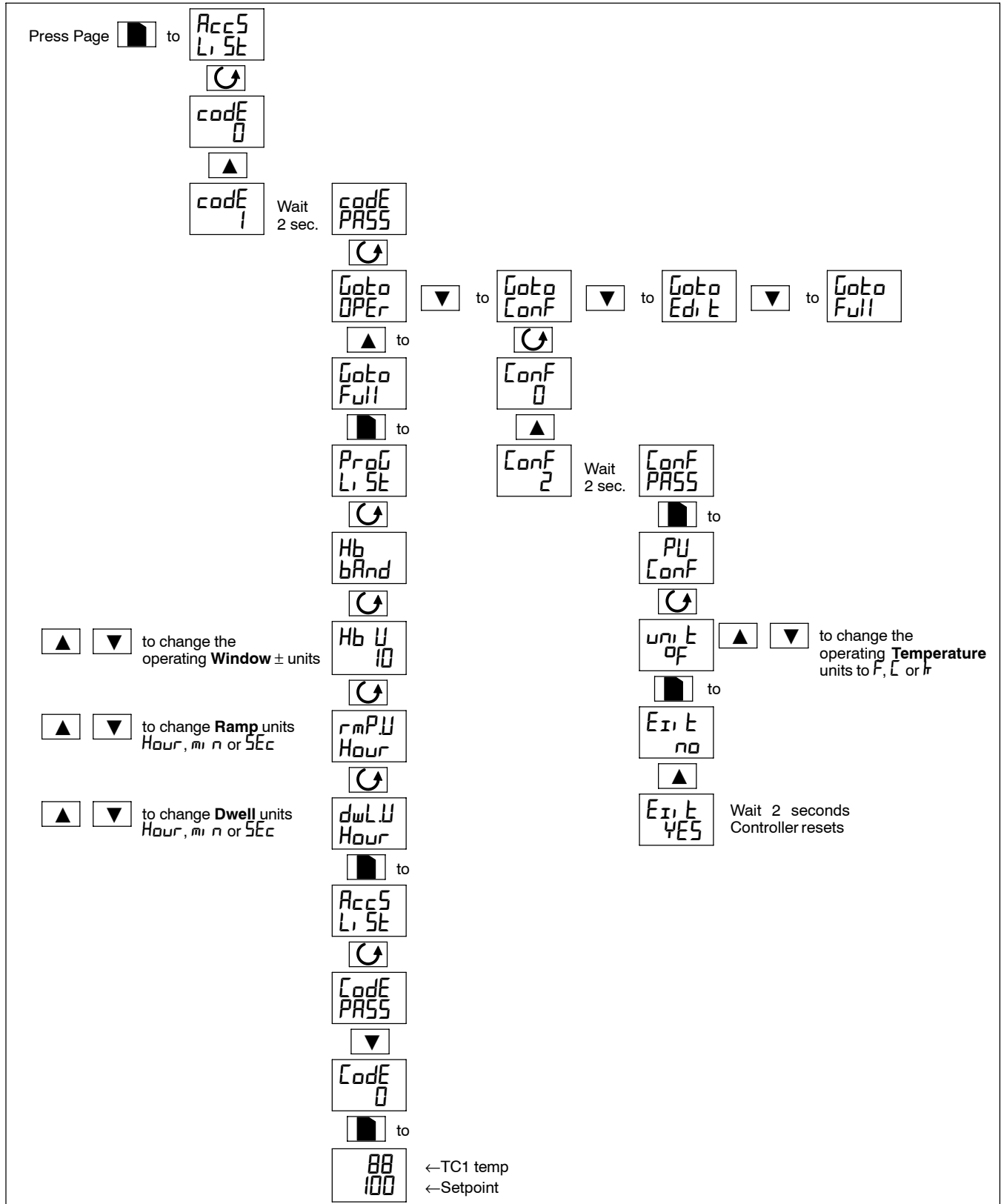

7-2. Changing 5100V Recorder From Degrees F to Degrees C And Change TC Descriptor

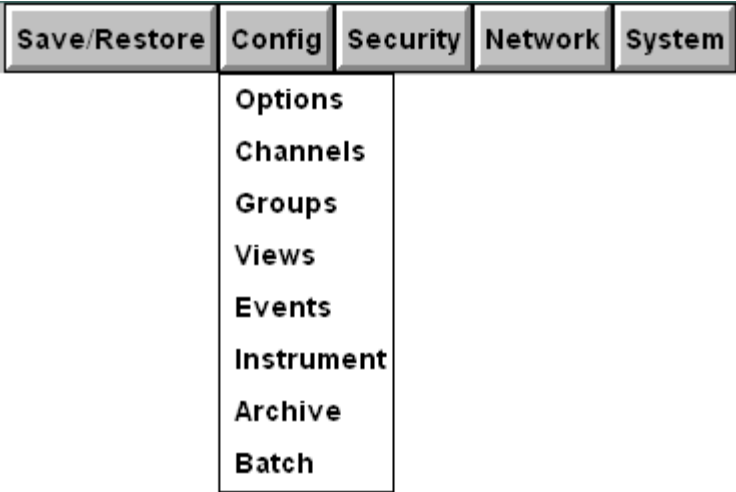

The screenshot shows the main menu with five tabs: Save/Restore, Config, Security, Network, and System. The 'Config' tab is selected, and a dropdown menu is open, listing the following options: Options, Channels, Groups, Views, Events, Instrument, Archive, and Batch. The 'Channels' option is highlighted in blue.

Log in as **“Engineer”** (see Section 6-2-2-2).

Press **“Menu”** (bottom right of display).

Select **“Config”**.

Select **“Channels”** from pull down menu.

scrn32

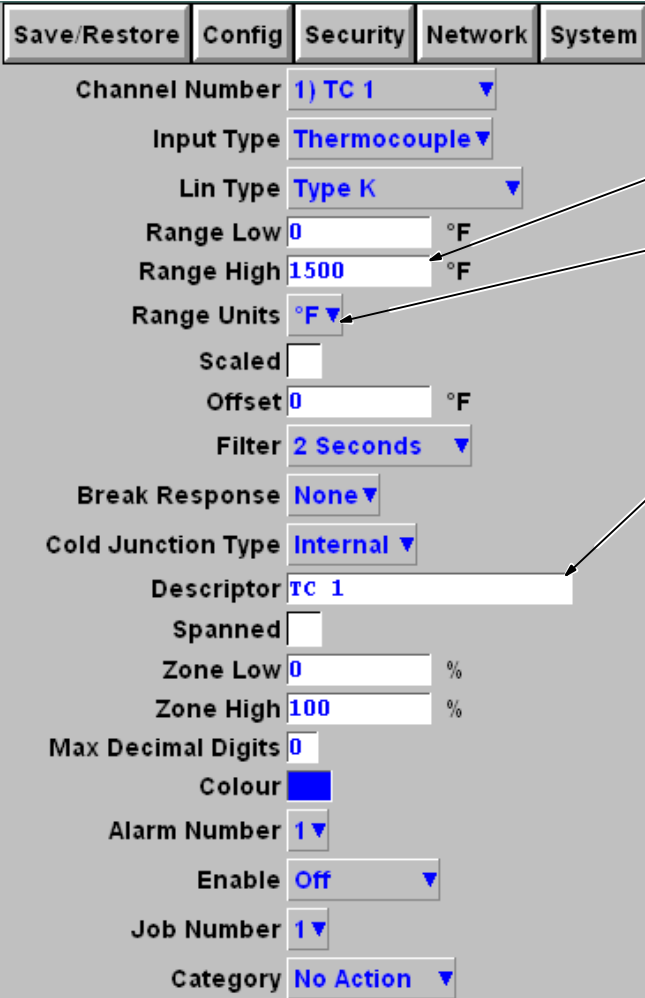

The screenshot shows the configuration screen for channel '1) TC 1'. The 'Config' tab is selected. The following fields are visible:

- Channel Number: 1) TC 1
- Input Type: Thermocouple
- Lin Type: Type K
- Range Low: 0 °F
- Range High: 1500 °F
- Range Units: °F
- Scaled:
- Offset: 0 °F
- Filter: 2 Seconds
- Break Response: None
- Cold Junction Type: Internal
- Descriptor: TC 1
- Spanned:
- Zone Low: 0 %
- Zone High: 100 %
- Max Decimal Digits: 0
- Colour: Blue
- Alarm Number: 1
- Enable: Off
- Job Number: 1
- Category: No Action

Annotations with arrows point to the 'Range Units' field, the 'Descriptor' field, and the 'Apply' button (implied by the text).

For each Channel Number (1-6):

1. Select **“Channel Number”**.
2. Maximum expected temperature range reading: 1500 for °F typ. (1472 °F) = 800 for °C typ.
3. Range units can be changed between °F and °C.
4. Descriptor can be changed in “Descriptor” field, if desired.

Press **“Apply”**.

Log out.

scrn33

7-3. Restoring Recorder Configuration From A Floppy Disk (For 5100 Digital Recorder)

Login as Engineer.

Touch top left corner (Logged Out) or (User).

Touch Blue text (pull down menu) next to User.

Touch Engineer.

Touch Password field.

Touch Numeric.

Touch 1, then 0, then Ok.

7-3-1. Load File

Insert digital recorder configuration disk into recorder.

Touch  key in bottom right corner to open Root Menu.

Touch Operator.

Touch Save/R.

Touch Restore.

Touch field next to File Name.

Touch up folder.

Touch \Floppy\ (Highlights yellow).

Touch down folder.

Touch the desired 5100 Config file (####.uhz).

Touch Open.

7-3-2. Date Setup

1. Touch System.
2. Touch Locale.
3. Touch pull down next to Country.
4. Touch appropriate country.
5. Touch pull down next to Time Zone.
6. Touch appropriate time zone (i.e. CST Central). See "<http://www.timeanddate.com>" for additional information.
7. Set DST (Daylight Savings Time) if applicable. Place an "X" in the box next to "Use Summertime (DST)" to enable this option.

NOTE

*In general, for those locations that observe DST:
DST begins at 2:00 am on the first Sunday in April.
DST ends at 2:00 am on the last Sunday in October.
See "<http://deil.lang.uiuc.edu/web/pages/holidays/DST.html> for exceptions.*

8. Touch Apply.

7-3-3. Time Setup

1. Touch System.
2. Touch Clock.
3. Adjust time, if necessary.
4. Touch Apply.

7-3-4. Login As User











1. Touch top left corner (Engineer).
2. Touch pull down next to User.
3. Touch User from pull down list.

7-3-5. Go To Home Screen



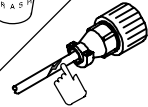



1. Touch  key in bottom right corner to open Root Menu.
2. Touch Home.

SECTION 8 – MAINTENANCE & TROUBLESHOOTING

8-1. Routine Maintenance

				 Turn Off all power before maintaining.
<div style="display: flex; justify-content: space-around; align-items: center;"> <div style="text-align: center;">  3 Months </div> <div style="text-align: center;">  </div> <div style="text-align: center;">  </div> <div style="text-align: center;"> <p>Replace Cracked Parts</p> </div> </div>		<div style="display: flex; justify-content: space-around; align-items: center;"> <div style="text-align: center;">  6 Months </div> <div style="text-align: center;">  </div> <div style="text-align: center;"> <p>OR</p> </div> <div style="text-align: center;">  </div> <div style="text-align: center;"> <p>Blow Out Or Vacuum Inside</p> </div> </div> <div style="display: flex; justify-content: space-around; align-items: center; margin-top: 10px;"> <div style="text-align: center;">  </div> <div style="text-align: center;"> <p>Replace Unreadable Labels</p> </div> </div>		

8-2. Troubleshooting

				
Trouble	Remedy			
IH/TS does not power up.	Be sure that power switch on rear of IH/TS is in the On position.			
	Check 115 volts ac at receptacle where IH/TS is plugged in.			
	Be sure that IH/TS is not plugged into a switched receptacle.			
	Check power source primary power for 3-phase, 400 or 460 volts ac (depending on model).			
	Replace building line fuse or reset circuit breaker.			
For 5 kW PWHT cart, remove transformer cover on back of running gear, and check terminal strip jumpers to verify they are set in the correct position. For 25 kW PWHT system cart, remove transformer cover on back of running gear, and check for loose lead connections.				
Display flashes <i>Sbr</i>	Thermocouple open, connect thermocouple.			
	Two pin thermocouple plugged into ground (copper) pin, reconnect to the two silver pins.			
Display flashes <i>ldH</i>	Workpiece actual temperature is more than 25 degrees over the target temperature. Wait for workpiece temperature to drop or follow the recovery procedure in Section 6-3-5.			
Power source contactor turns On and Off at 25° over target temperature.	Change Panel/Remote switch on power source to Remote position.			
<i>ConF</i>  appears on the display.	Press the up arrow to change the  to  . Press scroll to enter the menu. Press page to <i>E1</i> , <i>E</i> <i>no</i> and change it to <i>E1</i> , <i>E</i> <i>YES</i> , and the controller will reset automatically.			
If display flashes <i>no</i> , <i>o</i> .	Remove 2408 control from its housing by pressing locking tabs outward slightly on sides of control and pulling control forward. Look for add-on PC card in back of controller, and check that white connector is fully inserted into 2408 control. Reinstall 2408 control into housing being careful not to damage locking tabs on housing.			

Trouble	Remedy
If display flashes no again, or if 0-10 V output card fails.	<p>Remove 2408 control from its housing by pressing locking tabs outward slightly on sides of control and pulling control forward. Look for add-on PC card in back of controller, and remove PC card. Reinstall 2408 control into housing being careful not to damage locking tabs on housing. Disable output card function as follows: Go to Conf, I H Conf (Module 1 Config). See Section 8-5-4. Change id dCOP to id nonE. Scroll to E1 E no and change it to E1 E YES, and the controller will reset automatically. Set power source panel / remote switch to panel position and set desired maximum output. The control will operate in an on / off mode (at target temp + over temp alarm value). The over temp alarm value is set in Go to Full, AL L, SE, I dH.</p> <p>Obtain a replacement 0-10 V isolated card.</p>
Output stops when green Run button is released.	Replace Hold button.
Temperature readings go down instead of up.	Check for reversed red (-) and yellow (+) leads in 2-pin thermocouple, and correct if necessary.
Temperature readings do not rise.	Check for a short between thermocouple wires.
Temperature does not change in ramp segment.	Change the ramp rate for that segment in the Program List.
Fault/Limit light is on.	<p>Parameter Display will indicate either "Coolant Flow Error" or "PS Limit".</p> <p>"Coolant Flow Error" – ensure that cooler is plugged in and turned on. For 25 kW system, ensure receptacle switch is on. Check coolant level in reservoir, and add coolant if necessary. Check filter on cooler and replace, if necessary. Verify that coolant "IN" and "OUT" hoses are connected to the correct fittings. Check alignment of center pins in plastic quick disconnect fittings. Be sure that coolant jumpers are connected properly.</p> <p>"PS Limit" indicates the power source will run at less than full output. Verify panel/remote switch on power source is in Remote position. Turn down dial on front panel of power source until light goes out or To obtain full output, adjust the coil to get more coupling into the part. Check set-up parameters. If Volts setting is greater than 650, add a turn to the heating coil.</p>
Current Source fault.	<p>Remove a turn from the heating coil.</p> <p>Power/Volts equals Real Current, Real Current must be kept under 60 A.</p>
2408 Controller displays dwell before 10 degree window is reached.	<p>Check that Hold Back setting is in Band, display will read Hb bAnd (see Section 8-5-3, Go to Full, ProG L, SE).</p> <p>Check that Hold Back Units equals 10 F, display will read Hb U 10 (see Section 8-5-3, Go to Full, ProG L, SE).</p>
Parameter display does not operate, but 2408 Temperature Controller and 5100V Recorder displays do operate.	See Section 8-3A.
2408 Temperature Controller display does not operate, but 5100V Recorder display does operate.	See Section 8-3B.
5100V Recorder does not turn on, but 2408 Temperature Controller does turn on.	See Section 8-3C.
Flow/Limit light does not illuminate when cooler is turned off.	See Section 8-3D.
Heat On light does not display when power source is supplying output.	See Section 8-3E.
Output does not start when Run button is pressed.	See Section 8-3F.
Pressing Power Source Select button on rear of IH/TS does not change selection.	See Section 8-3G.
5100V Recorder displays Channel Error.	See Section 8-3H.

Trouble	Remedy
2408 Temperature Controller reads greater than 5° F different than Channel 1 on 5100V Recorder.	See Section 8-3I.
2408 Temperature Controller readings fluctuate rather than remain stable.	Check and secure connections to the workpiece.
5100V Recorder screen blinks when touched, but does not advance to next screen.	Screen calibration needs adjusting. Turn off IHTS power switch. Turn on IHTS power switch while touching screen, and continue to touch screen (about 45 seconds) until configuration display appears on the screen. Press "Touch Cal" or wait a few minutes for the Touch Cal display to appear on the screen. Use a pointed object (be careful not to damage screen), and touch each set of cross hairs to calibrate screen. When calibration is complete, turn IHTS power off and back on again.
5100V Recorder does not recognize floppy disk.	Floppy disks do not work well in ambient temperatures greater than 104° F (40° C).
	Clean floppy drive with a disk drive cleaner (available from a local computer reseller).

8-3. Diagnostic Procedures For IH/TS



A. Parameter Display Does Not Operate, But 2408 Temperature Controller And 5100V Recorder Displays Do Operate.

Turn on power source.

Remove 14-pin control cable from power source and IH/TS.

Check for bent pins in 14-pin control cable and on IH/TS receptacle.

Check for +24 volts dc between pins A and D at power source receptacle.

If +24 volts dc is not present, consult power source Owner's Manual for troubleshooting.

Connect 14-pin control cable to power source.

Check for +24 volts dc between pins A and D at IH/TS end of cable.

If +24 volts dc is not present, replace 14-pin control cable.

Connect 14-pin control cable to IH/TS.

Unplug IH/TS 115 volts ac power cord.

Remove IH/TS wrapper.

Check that plug PLG3 is fully inserted into receptacle RC3 on circuit board PC1.

Check for loose wires in 14-pin receptacle and plug PLG3.

Check for +24 volts dc between pins 7 (-) and 15 (+) at plug PLG3 and receptacle RC3.

If +24 volts dc is not present, check wiring from plug PLG3 to receptacle RC10.

Check that display ribbon cable is fully connected to receptacle RC1 on circuit board PC1 (grey foil on pin 1).

Check solder joints of ribbon cable to display.

Disconnect ribbon cable from display at receptacle RC1.

Check for +5 volts dc between pins 1 (-) and 2 (+) at receptacle RC1, and proceed as follows:

If +5 volts dc is present, replace the display; if 5 volts dc is not present, replace circuit board PC1.

Reconnect IH/TS 115 volts ac power cord.

B. 2408 Temperature Controller Display Does Not Operate, But 5100V Recorder Display Does Operate

Remove and reseat 2408 controller module, make sure that locking tabs are in place.

Remove IH/TS wrapper.

Check for 115 volts ac between L and N at terminal strip on rear of controller module.

If 115 volts ac is present, replace 2408 Temperature Controller; if 115 volts ac is not present, check wiring.

C. 5100V Recorder Does Not Turn On, But 2408 Temperature Controller Does Turn On

Place IH/TS power switch in the Off position.

Open floppy drive door.

Place IH/TS power switch in the On position.

Check for floppy drive light illumination.

If drive light does not illuminate, proceed as follows:

Remove IH/TS wrapper.

Check for 115 volts ac at plug on rear of recorder and reseal plug.

If 115 volts ac is not present, check wiring between plug PLG4, receptacle RC4, and power switch.

If 115 volts ac is present at plug on rear of recorder, check that green LED is illuminated by viewing through louvers on side of recorder.

A green LED should be visible through the louvers on the side of the recorder.

If green LED is not illuminated, replace recorder.

If drive does illuminate, replace the recorder.

D. Flow/Limit Light Does Not Illuminate When Cooler Is Turned Off

Check that cooler is plugged into switched receptacle and switch is in the Off position.

Unplug cooler power cord from receptacle.

Disconnect power output/extension cable from power source.

Press green Run button, and check if Fault/Limit light illuminates.

If light did not illuminate, check if power source displays Under Frequency Fault.

If power source does not display fault, consult power source Owner's Manual for troubleshooting.

If power source does display fault, check parameter display for error message.

If error message appears on parameter display, proceed as follows:

Remove Fault/Limit amber lense and bulb.

Check for 115 volts ac at light socket.

If 115 volts ac is present, replace Fault/Limit bulb.

If 115 volts ac is not present, proceed as follows:

Remove IH/TS wrapper.

Check for 115 volts ac between pin 13 at receptacle RC3 and neutral (switch S1-1, lead 2).

If 115 volts ac is present, check wiring for Fault/Limit light PL-2.

If 115 volts ac is not present, check for 115 volts ac between pin 14 at receptacle RC3 and neutral (switch S1-1, lead 2).

If 115 volts ac is present, replace circuit board PC1.

If 115 volts ac is not present, check wiring from pin 14 at receptacle RC3.

If no error message appears on the parameter display, proceed as follows:

Unplug IH/TS 115 volts ac power cord.

Remove IH/TS wrapper.

Check for an open circuit at RC3 between pins 17 and 18.

If circuit is open, replace circuit board PC1.

If circuit is not open, consult power source Owner's Manual for troubleshooting.

Reconnect IH/TS 115 volts ac power cord.

If light illuminates, disconnect Coolant In (red) fitting from IH/TS.

Spray silicone lubricant into fitting.

Insert a long narrow screwdriver into fitting and actuate flow switch plunger several times.

Remove IH/TS wrapper.

Disconnect flow switch leads.

Check Flow/Limit light for illumination.

If light does not illuminate, replace circuit board PC1.

If light does illuminate, proceed as follows:

Check switch leads for continuity when switch is activated.

Check switch leads for open circuit when switch is deactivated.

If continuity is always present at switch leads, replace flow switch.

E. Heat On Light Does Not Display When Power Source Is Supplying Output

Remove IH/TS wrapper.

Check for 24 volts dc at LED (this LED is polarity sensitive, red mark on plastic lense is + side).

If 24 volts dc is present, replace LED.

If 24 volts dc is not present, another source rather than the IH/TS is energizing the power source. Check for a short circuit between pins A and B in the 14-pin control cable.

F. Output Does Not Start When Run Button Is Pressed

Check for $\overline{5br}$ on 2408 Temperature Controller display.

Fully press and release Stop and Hold buttons, then try pressing the Run button.

If actual temperature is higher than target temperature, see recovery procedure in Section 6-3-5.

Remove 14-pin control cable from IH/TS.

Jumper pins A and B in plug on 14-pin cable.

If no output is present, proceed as follows:

Remove 14-pin control cable from power source.

Jumper pins A and B at power source receptacle.

If no output is present, consult power source Owner's Manual for troubleshooting.

If output is present, replace 14-pin control cable.

If output is present, proceed as follows:

Unplug IH/TS 115 volts ac power cord.

Check Run, Hold and Stop switches for operation.

G. Pressing Power Source Select Button On Rear Of IH/TS Does Not Change Selection

Remove IH/TS wrapper.

Jumper across leads at Power Source Select button (dry circuit).

If selection changes, replace switch.

If selection does not change, proceed as follows:

Jumper between pins 1 and 2 at RC2 on circuit board PC1.

If selection changes, replace wiring to the switch.

If selection does not change, replace circuit board PC1.

H. 5100V Recorder Displays Channel Error

Recorder will not operate below 32° F, allow 15-30 minutes for warm up or move recorder to a warmer location.

Remove IH/TS wrapper.

Remove red cover on rear of recorder.

Check that terminal strip is secure on rear of recorder.

Ribbon cable may be disconnected inside of recorder after prior maintenance, reconnect ribbon cable.

If above procedures do not clear the error message, replace recorder.

I. 2408 Temperature Controller Reads Greater Than 5° F Different Than Channel 1 On 5100V Recorder

Remove IH/TS wrapper.

Check that red (-) and yellow (+) leads are secure between clamp and copper pad on rear of temperature controller.

Connect a thermocouple to TC1 input.

If temperature controller drifts while power source is off, replace temperature controller.

If recorder readings drift while power source is off, replace recorder.

If power source output varies (audible frequency change) while attempting to maintain temperature, replace temperature controller.

If recorder readings drift while temperature controller is maintaining temperature, replace recorder.

8-4. Resetting All RAM Variables In The Event Of Display Errors

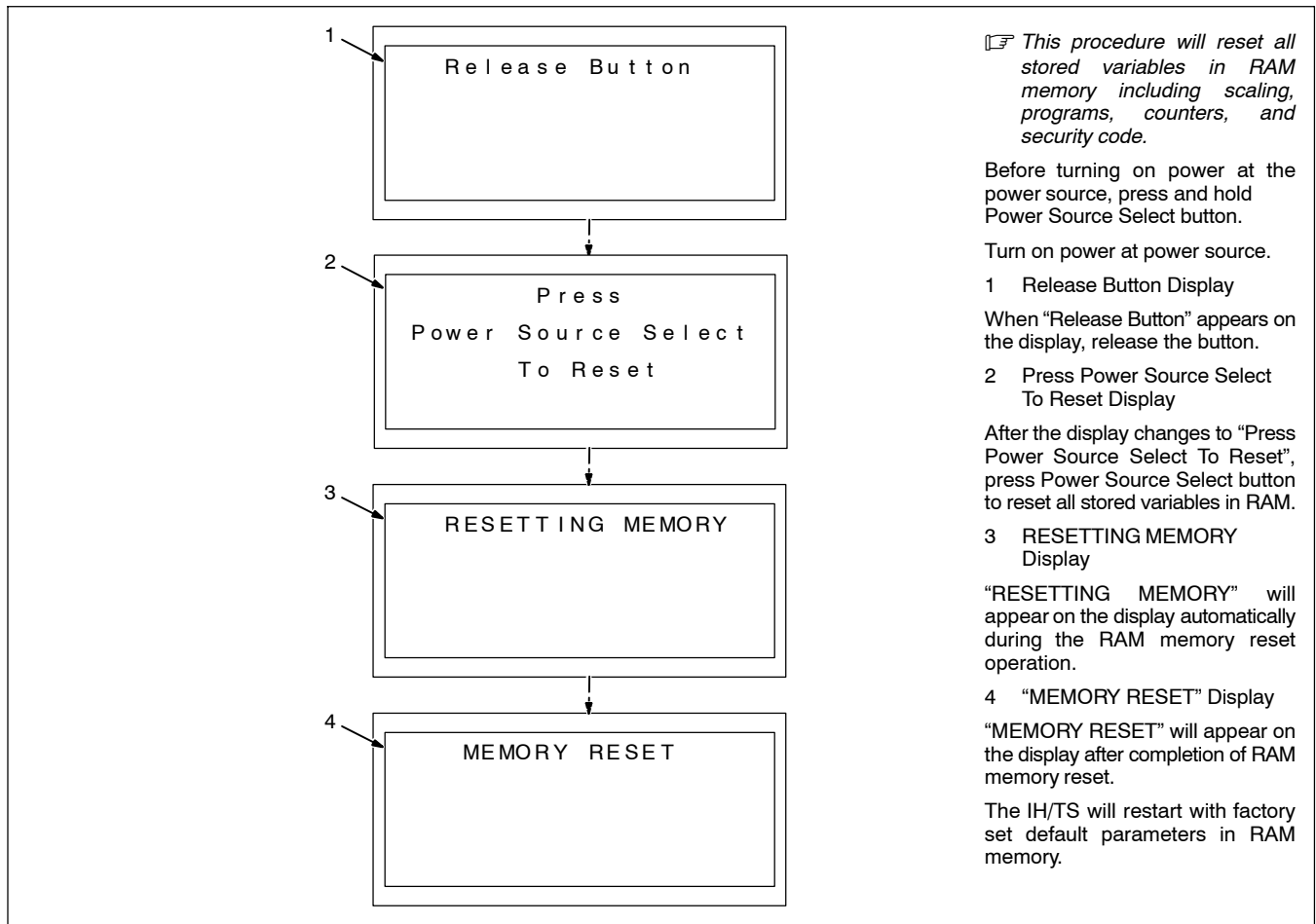

8-5. Factory Set Parameters

If it becomes necessary to return to factory settings, the following sections list factory settings for the 2408 controller. All settings can be accessed through the Goto screen. To access the Goto screen, proceed as follows:

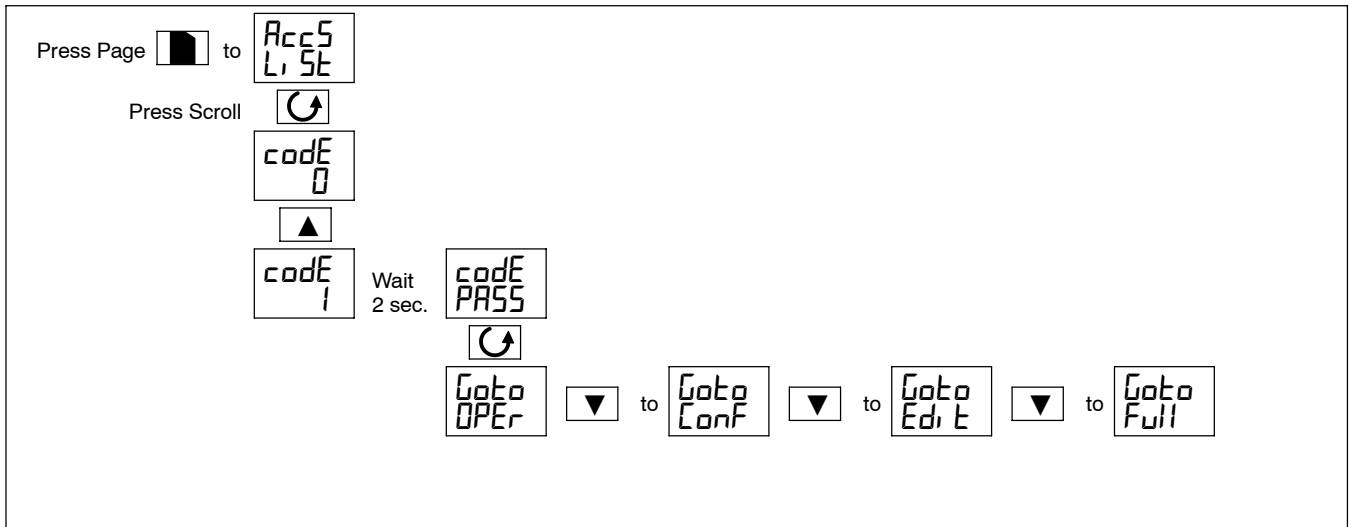

After selecting the desired Goto screen, press the scroll button to display the menu.

Press the page button to move from left to right through the columns; press the scroll button to move down the column; press the up or down arrow to change parameter settings, if necessary.

8-5-1. Controller Version Number

When the controller is first turned on, the version number will display briefly, and appear as shown.

Controller configuration parameters vary based upon version number. See appropriate Section for the corresponding version number.

Version Number
(V4.09 Effective w/Serial No. LC089021)

8-5-2. 2408 Controller Edit Parameters

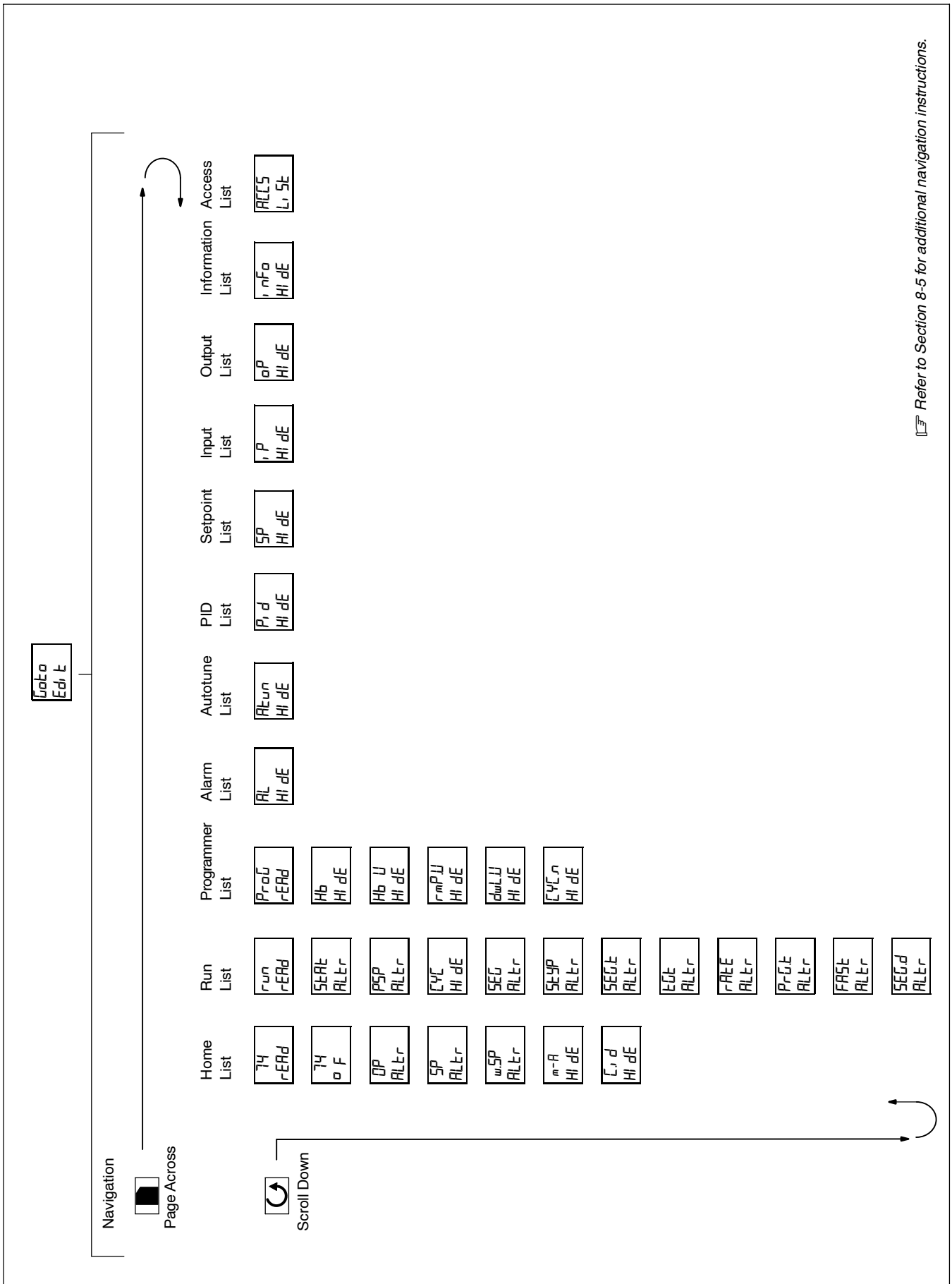

Refer to Section 8-5 for additional navigation instructions.

8-5-3. 2408 Controller Full Parameters (Prior To Version V4.09)

	Home List	Run List	Programmer List	Alarm List	Autotune List	PID List	Setpoint List	Input List	Output List	Information List	Access List
	74 100	run L, SE	Prog L, SE	AL L, SE	Autun L, SE	P, d L, SE	SP L, SE	P, P L, SE	OP L, SE	INFO L, SE	ACCESS L, SE
	74 0 F	SEAL OFF	Hb bAnd	1dH, 25	tune OFF	SET P, d, 1	SSSEL SP, 1	F, L, E 3.0	OPLO 0.0	d, SP Std	
	OP varies	FRSE no	Hb, U 10	HY, 1 2	d, r OFF	Pb 14	SP, 1 100	DF, S, T 0	OP, H, 1000	LoL, varies	
	m-A Auto	SEEd YES	r, m, U Hour	Lb, E OFF	d, r, E 10	t, 1 49	SP, 2 400	m, U, 1 varies	OP, r, r OFF	LoG, H varies	
	L, d 0		d, m, U Hour	d, i, r, U no	Pd, c m, r, n	E, d OFF	SP, L 0	C, J, L, 1 varies	C, Y, L, H 1.0	LoG, A varies	
			C, Y, L, n 1			r, E, S 0.0	SP, H 1450	L, 1, 1 varies	ont, H Auto	LoL, t varies	
			SELn 1			H, c, b Auto	SP, 2, L 0	P, U, S, L P, 1	End, P 0.0	LoL, w 0	
			E, Y, P, E STEP	d, u, r 1.0		L, c, b Auto	SP, 2, H 1450		SE, D, P 0.0	r, E, S, L no	
			E, L, E 600	SELn 4		P, b, 2 50	SP, r, r OFF		SE, b, O, P 0.0	m, L, E varies	
			SELn 2	E, Y, P, E r, m, P, r		t, 1, 2 150	H, b, L, Y OFF		w, O, P 100.0	w, O, P varies	
			E, L, E 1250	E, L, E 600		E, d, 2 50			P, O, P varies	P, O, P varies	
			r, A, E, E 6000	r, A, E, E 6000		r, E, S, 2 0.0			I, O, P varies	I, O, P varies	
			SELn 3	SELn 5		H, c, b, 2 Auto			d, O, P 0	d, O, P 0	
			E, Y, P, E d, w, E, 1	E, Y, P, E End		L, c, b, 2 Auto					
			End, E 5 OP	End, E 5 OP							

Refer to Section 8-5 for additional navigation instructions.

Navigation Page Across
Scroll Down

8-5-4. 2408 Controller Configure Parameters (Prior To Version V4.09)

Navigation		Auto Conf														
Page Across		Auto Conf														
Scroll Down		Auto Conf														
Instrument Config	Process Value Config	Input Config	Setpoint Config	Alarms Config	Programmer Config	Logical Inputs A Config	Logical Inputs B Config	Alarm relay Config	Comms 1 Config	Comms 2 Config	Module 1 Config	Module 2 Config	Module 3 Config	Calibration Config	Password Config	Extr no
Inst Config	PU Conf	IP Conf	SP Conf	AL Conf	PTOP Conf	L1A Conf	L1B Conf	L1A Conf	HA Conf	JA Conf	IA Conf	2A Conf	3A Conf	CAL Conf	PASS Conf	
Ext Pid	Unit of F	Input Htc	SP 2	AL 1 dHi	PEXP 1	L1A Logic	L1B Logic	L1A Logic	id none	id none	id dcdp	id none	id none	rcAL none	ALCP 1	
Act reu	decP nnnn	IL Auto	rmtr OFF	Ltch no	ABAC Prd	Func r-H	Func RES	Func dLg	Func none	Func none	Func HEAT	Func none	Func none	ULAL no	cnfP 2	
COOL Lin	rngL 0	IMP Auto	mtr OFF	bLoc no	PwrF rSET	SEnS nor	SEnS	SEnS	UALL 0	UALL 100	UALL 0	UALL 0	PE IL 0	PE IH 1000		
Extd SEcc	rngH 1450		Prtr OFF	AL 2 OFF	srno toPU	LdHi YES	AL 2 no	AL 3 no	UML 00	UML 00	UML 00	UML 00	PE IH 00	PE IH 00		
dtSP Err	rngU Pmin		rngU Pmin	Ltch no		AL 4 no	AL 4 no	AL 4 no	UML 00	UML 00	UML 00	UML 00	UML 00	UML 00		
n-A dISA	rngE none		rngE none	bLoc no		mHn no	mHn no	mHn no	dcF no	rmtrF no	PIF no	rmAL no	End YES	SSync no		
r-h dISA				AL 3 OFF		Sbr no	Sbr no	Sbr no								
PwrF OFF				Ltch no		SPAn no	SPAn no	SPAn no								
FwdE none				bLoc no		Lbr no	Lbr no	Lbr no								
Pdtr no				AL 4 OFF		LdF no	LdF no	LdF no								
Sbr E SbdP				Ltch no		UUNE no	UUNE no	UUNE no								
FOP no				bLoc no												
bcd none																
USch no																

Refer to Section 8-5 for additional navigation instructions.

8-5-5. 2408 Controller Full Parameters (Effective w/Version V4.09)

Navigation	Home List	Run List	Programmer List	Alarm List	Autotune List	PID List	Setpoint List	Input List	Output List	Information List	Access List
	74 100	run L, SE	Prog L, SE	AL L, SE	ALtn L, SE	P, d L, SE	SP L, SE	I, P L, SE	OP L, SE	info L, SE	ACCESS L, SE
	74 0 F	SEAL OFF	Hb bAnd	7dH 25	EUNE OFF	SET P, d, I	SSEL SP1	FILE 30	OPLO 0.0	di, SP Std	
	OP varies	FRSE no	Hb, U 10	HY 1 2	drH OFF	Pb 14	SP, 1 100	DF, S, T 0	OPH 1000	LoLl varies	
	m-A Auto	SEEd YES	r, m, U Hour	LB, E OFF	drAE 10	E, 1 49	SP, 2 400	m, U, I varies	OP, r, r OFF	LoGH varies	
	L, d 0		d, m, U Hour	di, AL no	Adc mPn	Ed OFF	SP, L 0	C, J, L, I varies	CYLH 1.0	LoLH varies	
			CYLH 1			rES 0.0	SP, H 1450	L, 1 varies	on, t, H Auto	LoLc varies	
			SELn 1			Hcb Auto	SP, 2L 0	P, U, S, L I, P, I	EndP 0.0	LoLw 0	
			EYPE STEP	dur 10		Lcb Auto	SP, 2H 1450		S, b, OP 0.0	rESL no	
			ECE 600	SELn 4		P, b, 2 50	SP, r, r OFF			m, DP 1000	
			SELn 2	EYPE r, m, P, r		E, 2 150	H, b, E, Y OFF				
			ECE 1250	ECE 600		Ed, 2 50					
			r, AE 6000	r, AE 6000		rES2 0.0					
			SELn 3	SELn 5		Hcb2 Auto					
			EYPE d, w, E, I	EYPE End		Lcb2 Auto					
				EndE 5 OP							

Refer to Section 8-5 for additional navigation instructions.

8-5-6. 2408 Controller Configure Parameters (Effective w/Version V4.09)

Navigation		Auto Conf													
Page Across		Auto Conf													
Scroll Down		Auto Conf													
Instrument Config	Process Value Config	Input Config	Setpoint Config	Alarms Config	Programmer Config	Logical Inputs A Config	Logical Inputs B Config	Alarm relay Config	Comms 1 Config	Comms 2 Config	Module 1 Config	Module 2 Config	Module 3 Config	Calibration Config	Password Config
Inst Config	PU Config	IP Config	SP Config	AL Config	PT Config	L1A Config	L1B Config	ARR Config	HA Config	JA Config	IA Config	2A Config	3A Config	CAL Config	PASS Config
Ext P.d	Unit of F	Input Htc	SP 2	AL 1 dHi	PEYP 1	L1A LoGi	L1B LoGi	rELY	id none	id none	id dcdp	id none	id none	rcAL none	EXT no
Act reu	dEcP nnnn	CJC Auto	rmtR OFF	Ltch no	ABAc ProG	Func r-H	Func RES	Func dLg	Func none	Func none	Func HEAT	Func none	Func none	ULAL no	ALCP 1
COOL Lin	rngL 0	IMP Auto	mEr OFF	bLoc no	PwrF rSEt	SEnS nor	SEnS	SEnS	ULAL 0	ULAL 100	ULAL 0	PE IL 0	PE IH 1000	PE IL 0	PE IH 1000
Extd SEcc	rngH 1450	PrEr OFF	rmpU Pmin	AL 2 OFF	5rno toPU	LdHi YES	AL 2 no	AL 3 no	ULAL 100	ULAL 100	ULAL 100	ULAL 100	ULAL 100	ULAL 100	ULAL 100
dEYP Err	rmpU Pmin	rmpU Pmin	rmt none	Ltch no	Ltch no	AL 3 no	AL 4 no	mHn no	ULAL 100	ULAL 100	ULAL 100	ULAL 100	ULAL 100	ULAL 100	ULAL 100
n-A d.SA	rmt none	bLoc no	AL 3 OFF	Ltch no	bLoc no	AL 4 no	mHn no	Sbr no	ULAL 100	ULAL 100	ULAL 100	ULAL 100	ULAL 100	ULAL 100	ULAL 100
r-h d.SA	AL 4 OFF	AL 4 OFF	Ltch no	bLoc no	AL 4 OFF	Ltch no	Sbr no	SPAn no	ULAL 100	ULAL 100	ULAL 100	ULAL 100	ULAL 100	ULAL 100	ULAL 100
PwrF OFF	Ltch no	bLoc no	AL 4 OFF	Ltch no	Ltch no	bLoc no	SPAn no	Lbr no	ULAL 100	ULAL 100	ULAL 100	ULAL 100	ULAL 100	ULAL 100	ULAL 100
FwdE none	bLoc no	SbrE SbdP	Ltch no	bLoc no	SbrE EnAb	Ltch no	Lbr no	LDF no	ULAL 100	ULAL 100	ULAL 100	ULAL 100	ULAL 100	ULAL 100	ULAL 100
SbrE SbdP	SbrE SbdP	FOP no	bcd none	USch no	LtCh 100	USch no	LtCh 100	USch no	ULAL 100	ULAL 100	ULAL 100	ULAL 100	ULAL 100	ULAL 100	ULAL 100
FOP no	USch no	LtCh 100	LtCh 100	LtCh 100	LtCh 100	LtCh 100	LtCh 100	LtCh 100	ULAL 100	ULAL 100	ULAL 100	ULAL 100	ULAL 100	ULAL 100	ULAL 100

Refer to Section 8-5 for additional navigation instructions.

8-6. Calibration Certification Procedure

The following items are required for verifying calibration:

1. Fluke-714 Thermocouple Calibrator
this can be obtained from: <http://www.fluke.com/products/home.asp?SID=13&AGID=9&PID=1707>
specify primary standard certification when ordering.
2. Type-K Mini Connector (Fluke #80CK-M) Or Equivalent
this can be obtained from: http://thermo-electric-direct.com.control.interliant.com/Miniature_Quick-Coupling_Thermocouple_Connectors10630.html
3. Type-K 2-Pin Male Connector
this can be obtained from: http://thermo-electric-direct.com.control.interliant.com/Standard_Quick-Coupling_Thermocouple_Connectors7886.html
4. Calibration Labels – Part No. QCC306BU BLUE
these can be obtained from: <http://www.q-cees.com/itemdetail.asp?part=206>
5. A length of type-K thermocouple wire connected between the type-K mini connector and type-K 2-pin connector.

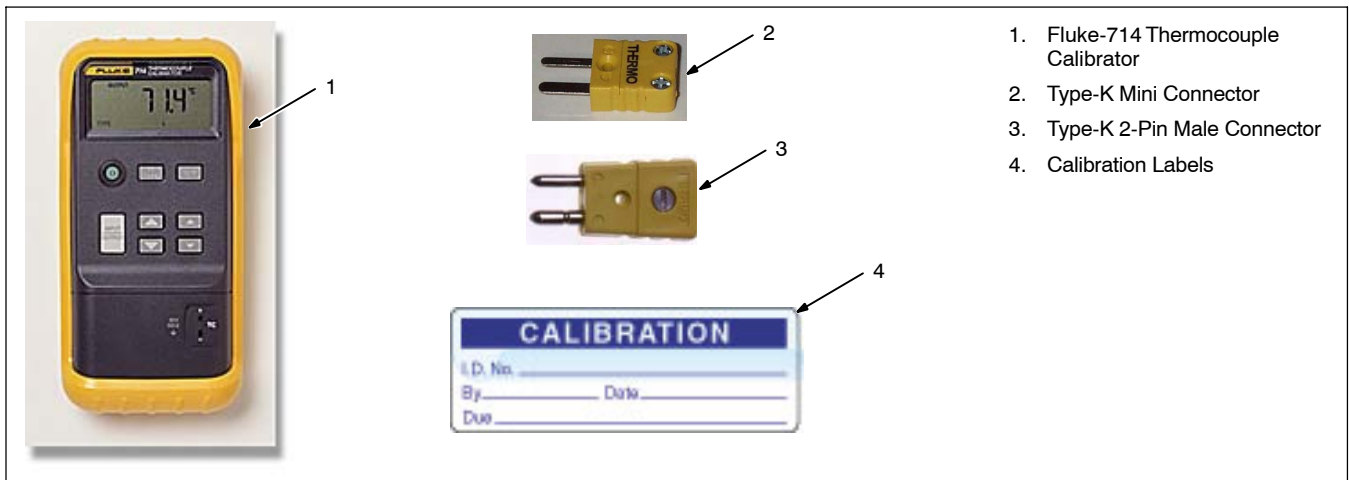

1. Fluke-714 Thermocouple Calibrator
2. Type-K Mini Connector
3. Type-K 2-Pin Male Connector
4. Calibration Labels

Perform the procedure as follows:

1. Press the down arrow on bottom left of digital recorder to display numeric page.
 Allow readings to stabilize before recording.
2. Set Fluke-714 TC Calibrator to 382.0 degrees F.
 - a. Move TC Calibrator from TC1 through TC6 in sequence recording each value read onto the Certificate of Calibration.
 - b. Verify readings are within ± 3 degrees F of TC Calibrator.
 If readings are beyond the ± 3 degrees F, the instrument will need to be returned to Eurotherm for repair.
3. Repeat at 882.0 degrees F and at 1382.0 degrees F
4. Save a copy of the Certificate using the IH/TS serial no. and date as the file name, i.e. "LB056241 062501" for June 25, 2001.
5. Print a copy of the certificate to send with the IH/TS.
6. Complete calibration sticker and apply to IH/TS front panel below recorder.

I.D. No. (IH/TS serial no.)
By (your initials) Date (today's date)
Due (date 1 year from today)

SECTION 9 – ELECTRICAL DIAGRAMS

	WARNING	<ul style="list-style-type: none"> Do not touch live electrical parts. Disconnect input power or stop engine before servicing. Do not operate with covers removed. Have only qualified persons install, use, or service this unit.
	ELECTRIC SHOCK HAZARD	

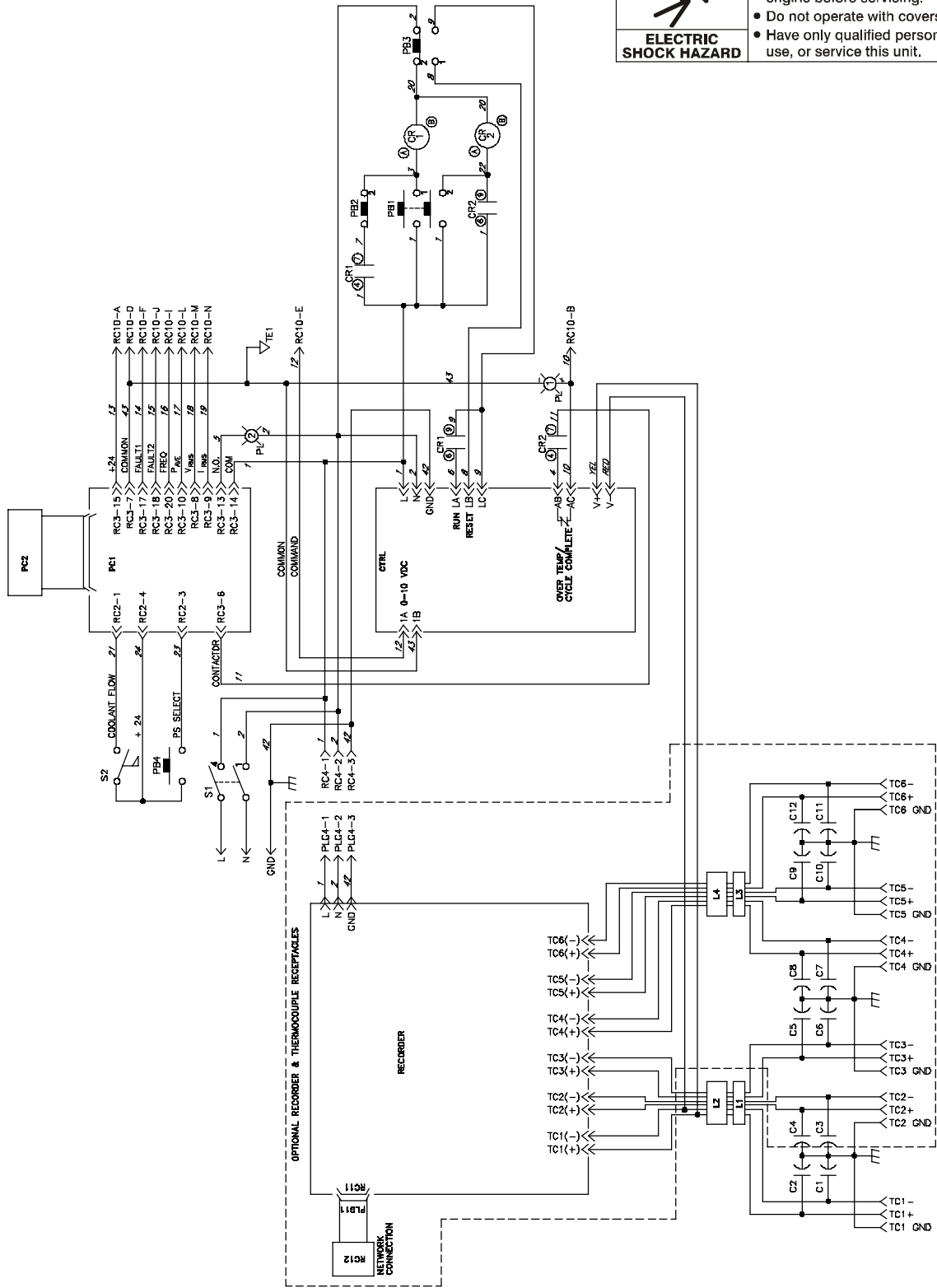
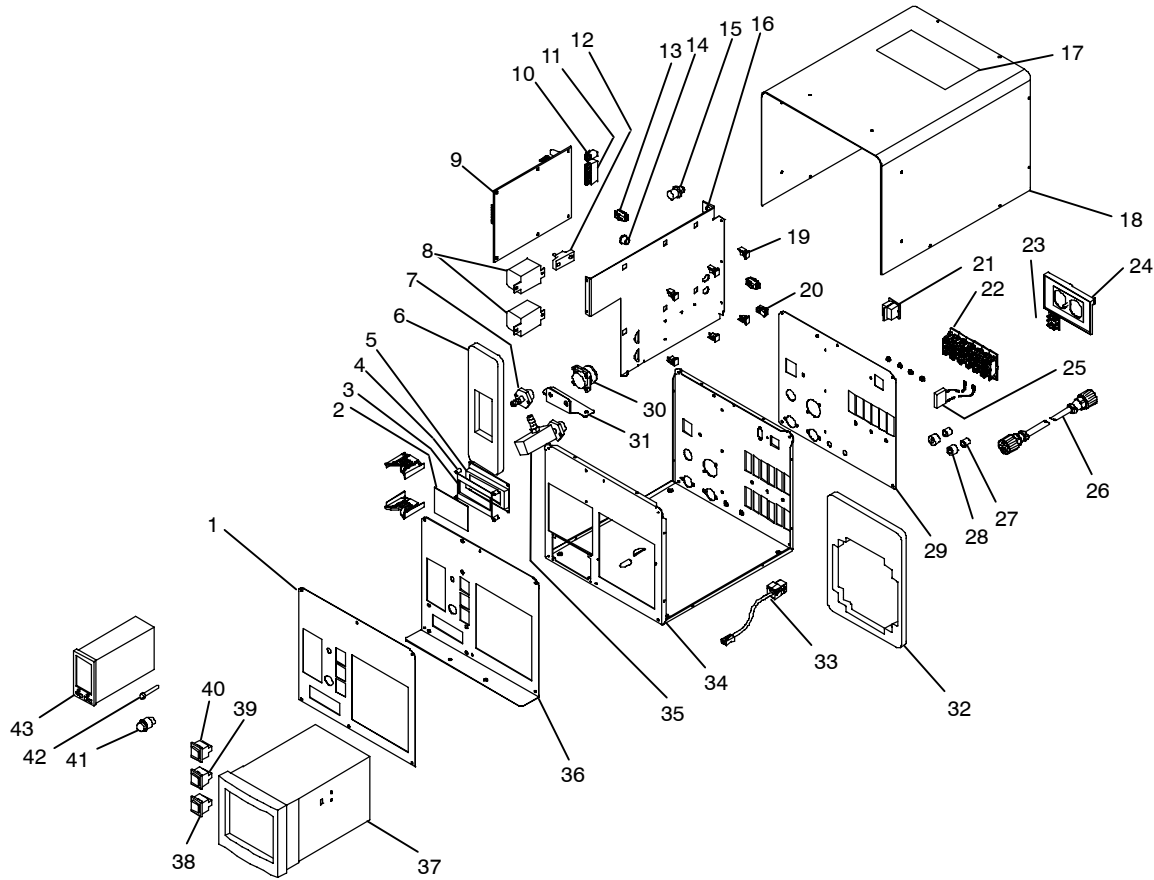

Figure 9-1. Circuit Diagram For IH/TS

SECTION 10 – PARTS LIST



Ref. 803 005-A

Figure 10-1. Complete Assembly

Dia. Mkgs.	Part No.	Description	Quantity
Figure 10-1. Complete Assembly			
1	203 262	NAMEPLATE, w/o recorder	1
1	204 366	NAMEPLATE, w/recorder	1
2	147 582	LENS, clear anti glare	1
3	174 446	GASKET, meter lens	1
4	156 005	TUBING, nyl	4
5	203 182	LCD, w/ribbon cable	1
6	204 039	MOUNT, nprn 1/8 din controller 55 durometer	1
7	081 543	FTG, coolant	1
8	186 162	RELAY, encl 120VAC DPDT 5A/120VAC	2
9	203 181	CIRCUIT CARD ASSY, pendant control	1
10	164 899	HOUSING PLUG PINS & SKTS	1
11	169 240	HOUSING PLUG PINS & SKTS	1
12	072 253	STUD, connection single	1
13	115 090	HOUSING PLUG & PINS	1
14	088 731	BUSHING, snap-in nyl	1
15	113 333	SWITCH, pb mc no SPST 1A 115 VAC	1
16	203 089	PANEL, center	1
17	147 876	LABEL, warning	1
18	+194 029	WRAPPER	1
19	134 201	STANDOFF	6
20	115 094	HOUSING PLUG & SKTS	1
21	158 506	SWITCH, rocker DPDT 10A 250VAC	1

Dia. Mkgs.	Part No.	Description	Quantity
Figure 10-1. Complete Assembly (Continued)			
..... 22 198 893	.. RECEPTACLE, thermocouple	6
..... 23 209 948	.. BRACKET, mtg receptacle RJ45	2
..... 24 175 282	.. COVER, receptacle weatherproof duplex rcpt	1
..... 25 203 975	.. CAPACITOR ASSY	6
..... 26 198 885	.. CABLE, interconnecting	1
..... 27 204 702	.. CORE, toroidal	1
..... 28 204 703	.. CORE, toroidal	1
..... 29 203 264	.. NAMEPLATE, rear w/o recorder	1
..... 29 204 367	.. NAMEPLATE, rear w/recorder	1
..... 30 152 492	.. RCPT W/PINS	1
..... 31 204 227	.. BRACKET, mtg IH/TS	1
..... 32 204 040	.. MOUNT, nprn 100mm recorder 55 durometer	1
..... 33 214 532	.. CABLE ASSY, interconnecting RJ45	2
..... 34 194 067	.. CASE SECTION, front/bottom/rear	1
..... 35 202 602	.. SWITCH, flow w/fittings	1
..... 36 194 068	.. PANEL, front	1
..... 37 194 920	.. RECORDER, temperature, digital	1
..... 38 212 719	.. KIT, switch replacement for 203 137 (including)	1
..... 203 137	.. SWITCH, pb mc DPST NC/NO 1A 115VAC red	1
..... *210 369	.. BOOT, switch pushbutton	1
..... 39 212 718	.. KIT, switch replacement for 203 136 (including)	1
..... 203 136	.. SWITCH, pb mc nc SPST 1A 115VAC black	1
..... *210 369	.. BOOT, switch pushbutton	1
..... 40 212 717	.. KIT, switch replacement for 203 135 (including)	1
..... 203 135	.. SWITCH, pb mc nc SPST 1A 115VAC green	1
..... *210 369	.. BOOT, switch pushbutton	1
..... 41 027 631	.. HOUSING, light	1
..... 027 629	.. BULB, incand	1
..... 176 246	.. LENS, light	1
..... 42 197 062	.. LED, blue	1
..... 43 202 200	.. TEMPERATURE CONTROLLER	1
..... 192 457	.. CORD, power	1

+When ordering a component originally displaying a precautionary label, the label should also be ordered.

*If replacing a boot only onto an existing switch, apply a silicone spray on both boot and switch to prevent moisture buildup inside boot and ease installation.

To maintain the factory original performance of your equipment, use only Manufacturer's Suggested Replacement Parts. Model and serial number required when ordering parts from your local distributor.

TRUE BLUE[®]

WARRANTY

Effective January 1, 2005

(Equipment with a serial number preface of "LF" or newer)

This limited warranty supersedes all previous Miller warranties and is exclusive with no other guarantees or warranties expressed or implied.

Warranty Questions?

Call
1-800-4-A-MILLER
for your local
Miller distributor.

Your distributor also gives
you ...

Service

You always get the fast,
reliable response you
need. Most replacement
parts can be in your
hands in 24 hours.

Support

Need fast answers to the
tough welding questions?
Contact your distributor.
The expertise of the
distributor and Miller is
there to help you, every
step of the way.

LIMITED WARRANTY - Subject to the terms and conditions below, Miller Electric Mfg. Co., Appleton, Wisconsin, warrants to its original retail purchaser that new Miller equipment sold after the effective date of this limited warranty is free of defects in material and workmanship at the time it is shipped by Miller. THIS WARRANTY IS EXPRESSLY IN LIEU OF ALL OTHER WARRANTIES, EXPRESS OR IMPLIED, INCLUDING THE WARRANTIES OF MERCHANTABILITY AND FITNESS.

Within the warranty periods listed below, Miller will repair or replace any warranted parts or components that fail due to such defects in material or workmanship. Miller must be notified in writing within thirty (30) days of such defect or failure, at which time Miller will provide instructions on the warranty claim procedures to be followed.

Miller shall honor warranty claims on warranted equipment listed below in the event of such a failure within the warranty time periods. All warranty time periods start on the date that the equipment was delivered to the original retail purchaser, or one year after the equipment is sent to a North American distributor or eighteen months after the equipment is sent to an International distributor.

1. 5 Years Parts — 3 Years Labor
 - * Original main power rectifiers
 - * Inverters (input and output rectifiers only)
2. 3 Years — Parts and Labor
 - * Transformer/Rectifier Power Sources
 - * Plasma Arc Cutting Power Sources
 - * Semi-Automatic and Automatic Wire Feeders
 - * Inverter Power Sources (Unless Otherwise Stated)
 - * Water Coolant Systems (Integrated)
 - * Intelligig
 - * Maxstar 150
 - * Engine Driven Welding Generators
(NOTE: Engines are warranted separately by the engine manufacturer.)
3. 1 Year — Parts and Labor Unless Specified
 - * DS-2 Wire Feeder
 - * Motor Driven Guns (w/exception of Spoolmate Spoolguns)
 - * Process Controllers
 - * Positioners and Controllers
 - * Automatic Motion Devices
 - * RFCS Foot Controls
 - * Induction Heating Power Sources and Coolers
 - * Water Coolant Systems (Non-Integrated)
 - * Flowgauge and Flowmeter Regulators (No Labor)
 - * HF Units
 - * Grids
 - * Maxstar 85, 140
 - * Spot Welders
 - * Load Banks
 - * Arc Stud Power Sources & Arc Stud Guns
 - * Racks
 - * Running Gear/Trailers
 - * Plasma Cutting Torches (except APT & SAF Models)
 - * Field Options
(NOTE: Field options are covered under True Blue[®] for the remaining warranty period of the product they are installed in, or for a minimum of one year — whichever is greater.)
4. 6 Months — Batteries
5. 90 Days — Parts
 - * MIG Guns/TIG Torches

- * Induction Heating Coils and Blankets
- * APT & SAF Model Plasma Cutting Torches
- * Remote Controls
- * Accessory Kits
- * Replacement Parts (No labor)
- * Spoolmate Spoolguns
- * Canvas Covers

Miller's True Blue[®] Limited Warranty shall not apply to:

1. **Consumable components; such as contact tips, cutting nozzles, contactors, brushes, slip rings, relays or parts that fail due to normal wear. (Exception: brushes, slip rings, and relays are covered on Bobcat, Trailblazer, and Legend models.)**
2. Items furnished by Miller, but manufactured by others, such as engines or trade accessories. These items are covered by the manufacturer's warranty, if any.
3. Equipment that has been modified by any party other than Miller, or equipment that has been improperly installed, improperly operated or misused based upon industry standards, or equipment which has not had reasonable and necessary maintenance, or equipment which has been used for operation outside of the specifications for the equipment.

MILLER PRODUCTS ARE INTENDED FOR PURCHASE AND USE BY COMMERCIAL/INDUSTRIAL USERS AND PERSONS TRAINED AND EXPERIENCED IN THE USE AND MAINTENANCE OF WELDING EQUIPMENT.

In the event of a warranty claim covered by this warranty, the exclusive remedies shall be, at Miller's option: (1) repair; or (2) replacement; or, where authorized in writing by Miller in appropriate cases, (3) the reasonable cost of repair or replacement at an authorized Miller service station; or (4) payment of or credit for the purchase price (less reasonable depreciation based upon actual use) upon return of the goods at customer's risk and expense. Miller's option of repair or replacement will be F.O.B., Factory at Appleton, Wisconsin, or F.O.B. at a Miller authorized service facility as determined by Miller. Therefore no compensation or reimbursement for transportation costs of any kind will be allowed.

TO THE EXTENT PERMITTED BY LAW, THE REMEDIES PROVIDED HEREIN ARE THE SOLE AND EXCLUSIVE REMEDIES. IN NO EVENT SHALL MILLER BE LIABLE FOR DIRECT, INDIRECT, SPECIAL, INCIDENTAL OR CONSEQUENTIAL DAMAGES (INCLUDING LOSS OF PROFIT), WHETHER BASED ON CONTRACT, TORT OR ANY OTHER LEGAL THEORY.

ANY EXPRESS WARRANTY NOT PROVIDED HEREIN AND ANY IMPLIED WARRANTY, GUARANTY OR REPRESENTATION AS TO PERFORMANCE, AND ANY REMEDY FOR BREACH OF CONTRACT TORT OR ANY OTHER LEGAL THEORY WHICH, BUT FOR THIS PROVISION, MIGHT ARISE BY IMPLICATION, OPERATION OF LAW, CUSTOM OF TRADE OR COURSE OF DEALING, INCLUDING ANY IMPLIED WARRANTY OF MERCHANTABILITY OR FITNESS FOR PARTICULAR PURPOSE, WITH RESPECT TO ANY AND ALL EQUIPMENT FURNISHED BY MILLER IS EXCLUDED AND DISCLAIMED BY MILLER.

Some states in the U.S.A. do not allow limitations of how long an implied warranty lasts, or the exclusion of incidental, indirect, special or consequential damages, so the above limitation or exclusion may not apply to you. This warranty provides specific legal rights, and other rights may be available, but may vary from state to state.

In Canada, legislation in some provinces provides for certain additional warranties or remedies other than as stated herein, and to the extent that they may not be waived, the limitations and exclusions set out above may not apply. This Limited Warranty provides specific legal rights, and other rights may be available, but may vary from province to province.





Owner's Record

Please complete and retain with your personal records.

Model Name	Serial/Style Number
------------	---------------------

Purchase Date	(Date which equipment was delivered to original customer.)
---------------	--

Distributor	
-------------	--

Address	
---------	--

City	
------	--

State	Zip
-------	-----



For Service

Contact a DISTRIBUTOR or SERVICE AGENCY near you.

Always provide Model Name and Serial/Style Number.

Contact your Distributor for:

- Welding Supplies and Consumables
 - Options and Accessories
 - Personal Safety Equipment
 - Service and Repair
 - Replacement Parts
 - Training (Schools, Videos, Books)
 - Technical Manuals (Servicing Information and Parts)
 - Circuit Diagrams
 - Welding Process Handbooks
- To locate a Distributor or Service Agency visit www.millerwelds.com or call 1-800-4-A-Miller

Contact the Delivering Carrier to:

- File a claim for loss or damage during shipment.
- For assistance in filing or settling claims, contact your distributor and/or equipment manufacturer's Transportation Department.

Miller Electric Mfg. Co.

An Illinois Tool Works Company
1635 West Spencer Street
Appleton, WI 54914 USA

International Headquarters—USA

USA Phone: 920-735-4505 Auto-Attended
USA & Canada FAX: 920-735-4134
International FAX: 920-735-4125

European Headquarters – United Kingdom

Phone: 44 (0) 1204-593493
FAX: 44 (0) 1204-598066

www.MillerWelds.com



Free Manuals Download Website

<http://myh66.com>

<http://usermanuals.us>

<http://www.somanuals.com>

<http://www.4manuals.cc>

<http://www.manual-lib.com>

<http://www.404manual.com>

<http://www.luxmanual.com>

<http://aubethermostatmanual.com>

Golf course search by state

<http://golfingnear.com>

Email search by domain

<http://emailbydomain.com>

Auto manuals search

<http://auto.somanuals.com>

TV manuals search

<http://tv.somanuals.com>