



OM-217 769L

2007-11

Processes



Multiprocess Welding

Description



Arc Welding Power Source

XMT[®] 400

(400 Volt Model)

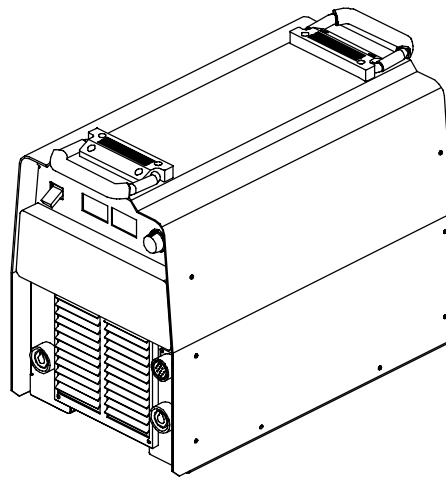

OWNER'S MANUAL

File: MULTIPROCESS



Visit our website at

www.MillerWelds.com

From Miller to You

Thank you and congratulations on choosing Miller. Now you can get the job done and get it done right. We know you don't have time to do it any other way.

That's why when Niels Miller first started building arc welders in 1929, he made sure his products offered long-lasting value and superior quality. Like you, his customers couldn't afford anything less. Miller products had to be more than the best they could be. They had to be the best you could buy.

Today, the people that build and sell Miller products continue the tradition. They're just as committed to providing equipment and service that meets the high standards of quality and value established in 1929.

This Owner's Manual is designed to help you get the most out of your Miller products. Please take time to read the Safety precautions. They will help you protect yourself against potential hazards on the worksite.

We've made installation and operation quick and easy. With Miller you can count on years of reliable service with proper maintenance. And if for some reason the unit needs repair, there's a Troubleshooting section that will help you figure out what the problem is. The parts list will then help you to decide the exact part you may need to fix the problem. Warranty and service information for your particular model are also provided.



Miller is the first welding equipment manufacturer in the U.S.A. to be registered to the ISO 9001:2000 Quality System Standard.

Miller Electric manufactures a full line of welders and welding related equipment. For information on other quality Miller products, contact your local Miller distributor to receive the latest full line catalog or individual specification sheets. **To locate your nearest distributor or service agency call 1-800-4-A-Miller, or visit us at www.MillerWelds.com on the web.**



Working as hard as you do – every power source from Miller is backed by the most hassle-free warranty in the business.



TABLE OF CONTENTS

SECTION 1 – SAFETY PRECAUTIONS - READ BEFORE USING	1
1-1. Symbol Usage	1
1-2. Arc Welding Hazards	1
1-3. Additional Symbols For Installation, Operation, And Maintenance	3
1-4. California Proposition 65 Warnings	4
1-5. Principal Safety Standards	4
1-6. EMF Information	4
SECTION 2 – CONSIGNES DE SÉCURITÉ – LIRE AVANT UTILISATION	5
2-1. Symboles utilisés	5
2-2. Dangers relatifs au soudage à l'arc	5
2-3. Dangers supplémentaires en relation avec l'installation, le fonctionnement et la maintenance	7
2-4. Proposition californienne 65 Avertissements	8
2-5. Principales normes de sécurité	9
2-6. Information EMF	9
SECTION 3 – DEFINITIONS	11
3-1. Manufacturer's Warning Label Definitions	11
3-2. Manufacturer's Rating Label	13
3-3. Symbols And Definitions	13
SECTION 4 – INSTALLATION	14
4-1. Specifications	14
4-2. Duty Cycle And Overheating	14
4-3. Volt-Ampere Curves	15
4-4. Dimensions And Weight	16
4-5. Selecting a Location	16
4-6. Weld Output Terminals And Selecting Cable Sizes	17
4-7. Remote 14 Receptacle Information	18
4-8. Electrical Service Guide	18
4-9. Connecting 3-Phase Input Power	19
SECTION 5 – OPERATION	20
5-1. Front Panel Controls	20
5-2. Meter Functions	21
5-3. Mode Switch Settings	22
5-4. Lift-Arc TIG Procedure	23
SECTION 6 – MAINTENANCE & TROUBLESHOOTING	24
6-1. Routine Maintenance	24
6-2. Blowing Out Inside Of Unit	24
6-3. Voltmeter/Ammeter Help Displays	25
6-4. Troubleshooting	26
SECTION 7 – ELECTRICAL DIAGRAM	27
SECTION 8 – PARTS LIST	28
OPTIONS AND ACCESSORIES	
WARRANTY	

SECTION 1 – SAFETY PRECAUTIONS - READ BEFORE USING

som_2007-04

 Protect yourself and others from injury — read and follow these precautions.

1-1. Symbol Usage



DANGER! – Indicates a hazardous situation which, if not avoided, will result in death or serious injury. The possible hazards are shown in the adjoining symbols or explained in the text.



Indicates a hazardous situation which, if not avoided, could result in death or serious injury. The possible hazards are shown in the adjoining symbols or explained in the text.

NOTICE – Indicates statements not related to personal injury.

 Indicates special instructions.



This group of symbols means Warning! Watch Out! ELECTRIC SHOCK, MOVING PARTS, and HOT PARTS hazards. Consult symbols and related instructions below for necessary actions to avoid the hazards.

1-2. Arc Welding Hazards



The symbols shown below are used throughout this manual to call attention to and identify possible hazards. When you see the symbol, watch out, and follow the related instructions to avoid the hazard. The safety information given below is only a summary of the more complete safety information found in the Safety Standards listed in Section 1-5. Read and follow all Safety Standards.



Only qualified persons should install, operate, maintain, and repair this unit.



During operation, keep everybody, especially children, away.



ELECTRIC SHOCK can kill.

Touching live electrical parts can cause fatal shocks or severe burns. The electrode and work circuit is electrically live whenever the output is on. The input power circuit and machine internal circuits are also live when power is on. In semiautomatic or automatic wire welding, the wire, wire reel, drive roll housing, and all metal parts touching the welding wire are electrically live. Incorrectly installed or improperly grounded equipment is a hazard.

- Do not touch live electrical parts.
- Wear dry, hole-free insulating gloves and body protection.
- Insulate yourself from work and ground using dry insulating mats or covers big enough to prevent any physical contact with the work or ground.
- Do not use AC output in damp areas, if movement is confined, or if there is a danger of falling.
- Use AC output ONLY if required for the welding process.
- If AC output is required, use remote output control if present on unit.
- Additional safety precautions are required when any of the following electrically hazardous conditions are present: in damp locations or while wearing wet clothing; on metal structures such as floors, gratings, or scaffolds; when in cramped positions such as sitting, kneeling, or lying; or when there is a high risk of unavoidable or accidental contact with the workpiece or ground. For these conditions, use the following equipment in order presented: 1) a semiautomatic DC constant voltage (wire) welder, 2) a DC manual (stick) welder, or 3) an AC welder with reduced open-circuit voltage. In most situations, use of a DC, constant voltage wire welder is recommended. And, do not work alone!
- Disconnect input power or stop engine before installing or servicing this equipment. Lockout/tagout input power according to OSHA 29 CFR 1910.147 (see Safety Standards).
- Properly install and ground this equipment according to its Owner's Manual and national, state, and local codes.

- Always verify the supply ground – check and be sure that input power cord ground wire is properly connected to ground terminal in disconnect box or that cord plug is connected to a properly grounded receptacle outlet.
- When making input connections, attach proper grounding conductor first – double-check connections.
- Keep cords dry, free of oil and grease, and protected from hot metal and sparks.
- Frequently inspect input power cord for damage or bare wiring – replace cord immediately if damaged – bare wiring can kill.
- Turn off all equipment when not in use.
- Do not use worn, damaged, undersized, or poorly spliced cables.
- Do not drape cables over your body.
- If earth grounding of the workpiece is required, ground it directly with a separate cable.
- Do not touch electrode if you are in contact with the work, ground, or another electrode from a different machine.
- Do not touch electrode holders connected to two welding machines at the same time since double open-circuit voltage will be present.
- Use only well-maintained equipment. Repair or replace damaged parts at once. Maintain unit according to manual.
- Wear a safety harness if working above floor level.
- Keep all panels and covers securely in place.
- Clamp work cable with good metal-to-metal contact to workpiece or worktable as near the weld as practical.
- Insulate work clamp when not connected to workpiece to prevent contact with any metal object.
- Do not connect more than one electrode or work cable to any single weld output terminal.

SIGNIFICANT DC VOLTAGE exists in inverter-type welding power sources after removal of input power.

- Turn Off inverter, disconnect input power, and discharge input capacitors according to instructions in Maintenance Section before touching any parts.



HOT PARTS can cause severe burns.

- Do not touch hot parts bare handed.
- Allow cooling period before working on gun or torch.
- To handle hot parts, use proper tools and/or wear heavy, insulated welding gloves and clothing to prevent burns.



FUMES AND GASES can be hazardous.

Welding produces fumes and gases. Breathing these fumes and gases can be hazardous to your health.

- Keep your head out of the fumes. Do not breathe the fumes.
- If inside, ventilate the area and/or use local forced ventilation at the arc to remove welding fumes and gases.
- If ventilation is poor, wear an approved air-supplied respirator.
- Read and understand the Material Safety Data Sheets (MSDSs) and the manufacturer's instructions for metals, consumables, coatings, cleaners, and degreasers.
- Work in a confined space only if it is well ventilated, or while wearing an air-supplied respirator. Always have a trained watch-person nearby. Welding fumes and gases can displace air and lower the oxygen level causing injury or death. Be sure the breathing air is safe.
- Do not weld in locations near degreasing, cleaning, or spraying operations. The heat and rays of the arc can react with vapors to form highly toxic and irritating gases.
- Do not weld on coated metals, such as galvanized, lead, or cadmium plated steel, unless the coating is removed from the weld area, the area is well ventilated, and while wearing an air-supplied respirator. The coatings and any metals containing these elements can give off toxic fumes if welded.



ARC RAYS can burn eyes and skin.

Arc rays from the welding process produce intense visible and invisible (ultraviolet and infrared) rays that can burn eyes and skin. Sparks fly off from the weld.

- Wear an approved welding helmet fitted with a proper shade of filter lenses to protect your face and eyes when welding or watching (see ANSI Z49.1 and Z87.1 listed in Safety Standards).
- Wear approved safety glasses with side shields under your helmet.
- Use protective screens or barriers to protect others from flash, glare and sparks; warn others not to watch the arc.
- Wear protective clothing made from durable, flame-resistant material (leather, heavy cotton, or wool) and foot protection.



WELDING can cause fire or explosion.

Welding on closed containers, such as tanks, drums, or pipes, can cause them to blow up. Sparks can fly off from the welding arc. The flying sparks, hot workpiece, and hot equipment can cause fires and explosions. Accidental contact of electrode to metal objects can cause sparks, explosion, overheating, or fire. Check and be sure the area is safe before doing any welding.

- Remove all flammables within 35 ft (10.7 m) of the welding arc. If this is not possible, tightly cover them with approved covers.
- Do not weld where flying sparks can strike flammable material.
- Protect yourself and others from flying sparks and hot metal.
- Be alert that welding sparks and hot materials from welding can easily go through small cracks and openings to adjacent areas.
- Watch for fire, and keep a fire extinguisher nearby.
- Be aware that welding on a ceiling, floor, bulkhead, or partition can cause fire on the hidden side.
- Do not weld on closed containers such as tanks, drums, or pipes, unless they are properly prepared according to AWS F4.1 (see Safety Standards).
- Do not weld where the atmosphere may contain flammable dust, gas, or liquid vapors (such as gasoline).
- Connect work cable to the work as close to the welding area as practical to prevent welding current from traveling long, possibly unknown paths and causing electric shock, sparks, and fire hazards.

- Do not use welder to thaw frozen pipes.
- Remove stick electrode from holder or cut off welding wire at contact tip when not in use.
- Wear oil-free protective garments such as leather gloves, heavy shirt, cuffless trousers, high shoes, and a cap.
- Remove any combustibles, such as a butane lighter or matches, from your person before doing any welding.
- After completion of work, inspect area to ensure it is free of sparks, glowing embers, and flames.
- Use only correct fuses or circuit breakers. Do not oversize or bypass them.
- Follow requirements in OSHA 1910.252 (a) (2) (iv) and NFPA 51B for hot work and have a fire watcher and extinguisher nearby.



FLYING METAL or DIRT can injure eyes.

- Welding, chipping, wire brushing, and grinding cause sparks and flying metal. As welds cool, they can throw off slag.
- Wear approved safety glasses with side shields even under your welding helmet.



BUILDUP OF GAS can injure or kill.

- Shut off shielding gas supply when not in use.
- Always ventilate confined spaces or use approved air-supplied respirator.

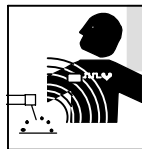

MAGNETIC FIELDS can affect Implanted Medical Devices.

- Wearers of Pacemakers and other Implanted Medical Devices should keep away.
- Implanted Medical Device wearers should consult their doctor and the device manufacturer before going near arc welding, spot welding, gouging, plasma arc cutting, or induction heating operations.



NOISE can damage hearing.

Noise from some processes or equipment can damage hearing.

- Wear approved ear protection if noise level is high.



CYLINDERS can explode if damaged.

Shielding gas cylinders contain gas under high pressure. If damaged, a cylinder can explode. Since gas cylinders are normally part of the welding process, be sure to treat them carefully.

- Protect compressed gas cylinders from excessive heat, mechanical shocks, physical damage, slag, open flames, sparks, and arcs.
- Install cylinders in an upright position by securing to a stationary support or cylinder rack to prevent falling or tipping.
- Keep cylinders away from any welding or other electrical circuits.
- Never drape a welding torch over a gas cylinder.
- Never allow a welding electrode to touch any cylinder.
- Never weld on a pressurized cylinder – explosion will result.
- Use only correct shielding gas cylinders, regulators, hoses, and fittings designed for the specific application; maintain them and associated parts in good condition.
- Turn face away from valve outlet when opening cylinder valve.
- Keep protective cap in place over valve except when cylinder is in use or connected for use.
- Use the right equipment, correct procedures, and sufficient number of persons to lift and move cylinders.
- Read and follow instructions on compressed gas cylinders, associated equipment, and Compressed Gas Association (CGA) publication P-1 listed in Safety Standards.

1-3. Additional Symbols For Installation, Operation, And Maintenance



FIRE OR EXPLOSION hazard.

- Do not install or place unit on, over, or near combustible surfaces.
- Do not install unit near flammables.
- Do not overload building wiring – be sure power supply system is properly sized, rated, and protected to handle this unit.



FALLING UNIT can cause injury.

- Use lifting eye to lift unit only, NOT running gear, gas cylinders, or any other accessories.
- Use equipment of adequate capacity to lift and support unit.
- If using lift forks to move unit, be sure forks are long enough to extend beyond opposite side of unit.



OVERUSE can cause OVERHEATING

- Allow cooling period; follow rated duty cycle.
- Reduce current or reduce duty cycle before starting to weld again.
- Do not block or filter airflow to unit.

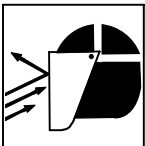

FLYING SPARKS can cause injury.

- Wear a face shield to protect eyes and face.
- Shape tungsten electrode only on grinder with proper guards in a safe location wearing proper face, hand, and body protection.
- Sparks can cause fires — keep flammables away.

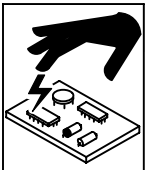

STATIC (ESD) can damage PC boards.

- Put on grounded wrist strap BEFORE handling boards or parts.
- Use proper static-proof bags and boxes to store, move, or ship PC boards.



MOVING PARTS can cause injury.

- Keep away from moving parts.
- Keep away from pinch points such as drive rolls.



WELDING WIRE can cause injury.

- Do not press gun trigger until instructed to do so.
- Do not point gun toward any part of the body, other people, or any metal when threading welding wire.



MOVING PARTS can cause injury.

- Keep away from moving parts such as fans.
- Keep all doors, panels, covers, and guards closed and securely in place.
- Have only qualified persons remove doors, panels, covers, or guards for maintenance as necessary.
- Reinstall doors, panels, covers, or guards when maintenance is finished and before reconnecting input power.

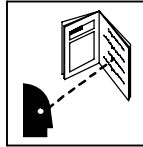

READ INSTRUCTIONS.

- Read Owner's Manual before using or servicing unit.
- Use only genuine replacement parts from the manufacturer.

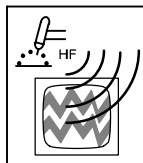

H.F. RADIATION can cause interference.

- High-frequency (H.F.) can interfere with radio navigation, safety services, computers, and communications equipment.
- Have only qualified persons familiar with electronic equipment perform this installation.
- The user is responsible for having a qualified electrician promptly correct any interference problem resulting from the installation.
- If notified by the FCC about interference, stop using the equipment at once.
- Have the installation regularly checked and maintained.
- Keep high-frequency source doors and panels tightly shut, keep spark gaps at correct setting, and use grounding and shielding to minimize the possibility of interference.

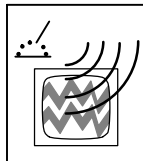

ARC WELDING can cause interference.

- Electromagnetic energy can interfere with sensitive electronic equipment such as computers and computer-driven equipment such as robots.
- Be sure all equipment in the welding area is electromagnetically compatible.
- To reduce possible interference, keep weld cables as short as possible, close together, and down low, such as on the floor.
- Locate welding operation 100 meters from any sensitive electronic equipment.
- Be sure this welding machine is installed and grounded according to this manual.
- If interference still occurs, the user must take extra measures such as moving the welding machine, using shielded cables, using line filters, or shielding the work area.

1-4. California Proposition 65 Warnings

 **Welding or cutting equipment produces fumes or gases which contain chemicals known to the State of California to cause birth defects and, in some cases, cancer. (California Health & Safety Code Section 25249.5 et seq.)**

 **Battery posts, terminals and related accessories contain lead and lead compounds, chemicals known to the State of California to cause cancer and birth defects or other reproductive harm. Wash hands after handling.**

For Gasoline Engines:

 **Engine exhaust contains chemicals known to the State of California to cause cancer, birth defects, or other reproductive harm.**

For Diesel Engines:

 **Diesel engine exhaust and some of its constituents are known to the State of California to cause cancer, birth defects, and other reproductive harm.**

1-5. Principal Safety Standards

Safety in Welding, Cutting, and Allied Processes, ANSI Standard Z49.1, from Global Engineering Documents (phone: 1-877-413-5184, website: www.global.ihs.com).

Recommended Safe Practices for the Preparation for Welding and Cutting of Containers and Piping, American Welding Society Standard AWS F4.1, from Global Engineering Documents (phone: 1-877-413-5184, website: www.global.ihs.com).

National Electrical Code, NFPA Standard 70, from National Fire Protection Association, P.O. Box 9101, Quincy, MA 02269-9101 (phone: 617-770-3000, website: www.nfpa.org and www.sparky.org).

Safe Handling of Compressed Gases in Cylinders, CGA Pamphlet P-1, from Compressed Gas Association, 4221 Walney Road, 5th Floor, Chantilly, VA 20151 (phone: 703-788-2700, website: www.cganet.com).

Code for Safety in Welding and Cutting, CSA Standard W117.2, from Canadian Standards Association, Standards Sales, 5060 Mississauga,

Ontario, Canada L4W 5NS (phone: 800-463-6727 or in Toronto 416-747-4044, website: www.csa-international.org).

Safe Practice For Occupational And Educational Eye And Face Protection, ANSI Standard Z87.1, from American National Standards Institute, 25 West 43rd Street, New York, NY 10036-8002 (phone: 212-642-4900, website: www.ansi.org).

Standard for Fire Prevention During Welding, Cutting, and Other Hot Work, NFPA Standard 51B, from National Fire Protection Association, P.O. Box 9101, Quincy, MA 02269-9101 (phone: 617-770-3000, website: www.nfpa.org).

OSHA, Occupational Safety and Health Standards for General Industry, Title 29, Code of Federal Regulations (CFR), Part 1910, Subpart Q, and Part 1926, Subpart J, from U.S. Government Printing Office, Superintendent of Documents, P.O. Box 371954, Pittsburgh, PA 15250-7954 (phone: 1-866-512-1800) (there are 10 Regional Offices—phone for Region 5, Chicago, is 312-353-2220, website: www.osha.gov).

1-6. EMF Information

Considerations About Welding And The Effects Of Low Frequency Electric And Magnetic Fields

Welding current, as it flows through welding cables, will cause electromagnetic fields. There has been and still is some concern about such fields. However, after examining more than 500 studies spanning 17 years of research, a special blue ribbon committee of the National Research Council concluded that: "The body of evidence, in the committee's judgment, has not demonstrated that exposure to power-frequency electric and magnetic fields is a human-health hazard." However, studies are still going forth and evidence continues to be examined. Until the final conclusions of the research are reached, you may wish to minimize your exposure to electromagnetic fields when welding or cutting.

To reduce magnetic fields in the workplace, use the following procedures:

1. Keep cables close together by twisting or taping them, or using a cable cover.
2. Arrange cables to one side and away from the operator.
3. Do not coil or drape cables around your body.
4. Keep welding power source and cables as far away from operator as practical.
5. Connect work clamp to workpiece as close to the weld as possible.

About Implanted Medical Devices:

Implanted Medical Device wearers should consult their doctor and the device manufacturer before performing or going near arc welding, spot welding, gouging, plasma arc cutting, or induction heating operations. If cleared by your doctor, then following the above procedures is recommended.

SECTION 2 – CONSIGNES DE SÉCURITÉ – LIRE AVANT UTILISATION

fre_som_2007-04

! Se protéger et protéger les autres contre le risque de blessure — lire et respecter ces consignes.

2-1. Symboles utilisés



DANGER! – Indique une situation dangereuse qui si on l'évite pas peut donner la mort ou des blessures graves. Les dangers possibles sont montrés par les symboles joints ou sont expliqués dans le texte.



Indique une situation dangereuse qui si on l'évite pas peut donner la mort ou des blessures graves. Les dangers possibles sont montrés par les symboles joints ou sont expliqués dans le texte.

NOTE – Indique des déclarations pas en relation avec des blessures personnelles.

 Indique des instructions spécifiques.



Ce groupe de symboles veut dire Avertissement! Attention! DANGER DE CHOC ELECTRIQUE, PIECES EN MOUVEMENT, et PIECES CHAUDES. Consulter les symboles et les instructions ci-dessous y afférant pour les actions nécessaires afin d'éviter le danger.

2-2. Dangers relatifs au soudage à l'arc



Les symboles représentés ci-dessous sont utilisés dans ce manuel pour attirer l'attention et identifier les dangers possibles. En présence de l'un de ces symboles, prendre garde et suivre les instructions afférentes pour éviter tout risque. Les instructions en matière de sécurité indiquées ci-dessous ne constituent qu'un sommaire des instructions de sécurité plus complètes fournies dans les normes de sécurité énumérées dans la Section 2-5. Lire et observer toutes les normes de sécurité.



Seul un personnel qualifié est autorisé à installer, faire fonctionner, entretenir et réparer cet appareil.



Pendant le fonctionnement, maintenir à distance toutes les personnes, notamment les enfants de l'appareil.



UNE DÉCHARGE ÉLECTRIQUE peut entraîner la mort.

Le contact d'organes électriques sous tension peut provoquer des accidents mortels ou des brûlures graves. Le circuit de l'électrode et de la pièce est sous tension lorsque le courant est délivré à la sortie. Le circuit d'alimentation et les circuits internes de la machine sont également sous tension lorsque l'alimentation est sur Marche. Dans le mode de soudage avec du fil, le fil, le dérouleur, le bloc de commande du rouleau et toutes les parties métalliques en contact avec le fil sont sous tension électrique. Un équipement installé ou mis à la terre de manière incorrecte ou impropre constitue un danger.

- Ne pas toucher aux pièces électriques sous tension.
- Porter des gants isolants et des vêtements de protection secs et sans trous.
- S'isoler de la pièce à couper et du sol en utilisant des housses ou des tapis assez grands afin d'éviter tout contact physique avec la pièce à couper ou le sol.
- Ne pas se servir de source électrique à courant électrique dans les zones humides, dans les endroits confinés ou là où on risque de tomber.
- Se servir d'une source électrique à courant électrique UNIQUEMENT si le procédé de soudage le demande.
- Si l'utilisation d'une source électrique à courant électrique s'avère nécessaire, se servir de la fonction de télécommande si l'appareil en est équipé.
- D'autres consignes de sécurité sont nécessaires dans les conditions suivantes : risques électriques dans un environnement humide ou si l'on porte des vêtements mouillés ; sur des structures métalliques telles que sols, grilles ou échafaudages ; en position coincée comme assise, à genoux ou couchée ; ou s'il y a un risque élevé de contact inévitable ou accidentel avec la pièce à souder ou le sol. Dans ces conditions, utiliser les équipements suivants, dans l'ordre indiqué : 1) un poste à souder DC à tension constante (à fil), 2) un poste à souder DC manuel (électrode) ou 3) un poste à souder AC à tension à vide réduite. Dans la plupart des situations, l'utilisation d'un poste à souder DC à fil à tension constante est recommandée. En outre, ne pas travailler seul !
- Couper l'alimentation ou arrêter le moteur avant de procéder à l'installation, à la réparation ou à l'entretien de l'appareil. Déverrouiller l'alimentation selon la norme OSHA 29 CFR 1910.147 (voir normes de sécurité).
- Installer le poste correctement et le mettre à la terre convenablement selon les consignes du manuel de l'opérateur et les normes nationales, provinciales et locales.
- Toujours vérifier la terre du cordon d'alimentation. Vérifier et s'assurer que le fil de terre du cordon d'alimentation est bien raccordé à la borne de terre du sectionneur ou que la fiche du cordon est raccordée à une prise correctement mise à la terre.
- En effectuant les raccordements d'entrée, fixer d'abord le conducteur de mise à la terre approprié et contre-vérifier les connexions.
- Les câbles doivent être exempts d'humidité, d'huile et de graisse; protégez-les contre les étincelles et les pièces métalliques chaudes.
- Vérifier fréquemment le cordon d'alimentation afin de s'assurer qu'il n'est pas altéré ou à nu, le remplacer immédiatement s'il l'est. Un fil à nu peut entraîner la mort.
- L'équipement doit être hors tension lorsqu'il n'est pas utilisé.
- Ne pas utiliser des câbles usés, endommagés, de grosseur insuffisante ou mal épissés.
- Ne pas enrouler les câbles autour du corps.
- Si la pièce soudée doit être mise à la terre, le faire directement avec un câble distinct.
- Ne pas toucher l'électrode quand on est en contact avec la pièce, la terre ou une électrode provenant d'une autre machine.
- Ne pas toucher des porte électrodes connectés à deux machines en même temps à cause de la présence d'une tension à vide doublée.
- N'utiliser qu'un matériel en bon état. Réparer ou remplacer sur-le-champ les pièces endommagées. Entretien l'appareil conformément à ce manuel.
- Porter un harnais de sécurité si l'on doit travailler au-dessus du sol.
- S'assurer que tous les panneaux et couvercles sont correctement en place.
- Fixer le câble de retour de façon à obtenir un bon contact métal-métal avec la pièce à souder ou la table de travail, le plus près possible de la soudure.
- Isoler la pince de masse quand pas mis à la pièce pour éviter le contact avec tout objet métallique.
- Ne pas raccorder plus d'une électrode ou plus d'un câble de masse à une même borne de sortie de soudage.

Il reste une TENSION DC NON NÉGLIGEABLE dans les sources de soudage onduleur quand on a coupé l'alimentation.

- Arrêter les convertisseurs, débrancher le courant électrique et décharger les condensateurs d'alimentation selon les instructions indiquées dans la partie Entretien avant de toucher les pièces.



DES PIÈCES CHAUDES peuvent provoquer des brûlures graves.

- Ne pas toucher à mains nues les parties chaudes.
- Prévoir une période de refroidissement avant de travailler à l'équipement.
- Ne pas toucher aux pièces chaudes, utiliser les outils recommandés et porter des gants de soudage et des vêtements épais pour éviter les brûlures.



LES FUMÉES ET LES GAZ peuvent être dangereux.

Le soudage génère des fumées et des gaz. Leur inhalation peut être dangereux pour votre santé.

- Eloigner votre tête des fumées. Ne pas respirer les fumées.
- À l'intérieur, ventiler la zone et/ou utiliser une ventilation forcée au niveau de l'arc pour l'évacuation des fumées et des gaz de soudage.
- Si la ventilation est médiocre, porter un respirateur anti-vapeurs approuvé.
- Lire et comprendre les spécifications de sécurité des matériaux (MSDS) et les instructions du fabricant concernant les métaux, les consommables, les revêtements, les nettoyants et les dégraissants.
- Travailler dans un espace fermé seulement s'il est bien ventilé ou en portant un respirateur à alimentation d'air. Demander toujours à un surveillant dûment formé de se tenir à proximité. Des fumées et des gaz de soudage peuvent déplacer l'air et abaisser le niveau d'oxygène provoquant des blessures ou des accidents mortels. S'assurer que l'air de respiration ne présente aucun danger.
- Ne pas souder dans des endroits situés à proximité d'opérations de dégraissage, de nettoyage ou de pulvérisation. La chaleur et les rayons de l'arc peuvent réagir en présence de vapeurs et former des gaz hautement toxiques et irritants.
- Ne pas souder des métaux munis d'un revêtement, tels que l'acier galvanisé, plaqué en plomb ou au cadmium à moins que le revêtement n'ait été enlevé dans la zone de soudure, que l'endroit soit bien ventilé, et en portant un respirateur à alimentation d'air. Les revêtements et tous les métaux renfermant ces éléments peuvent dégager des fumées toxiques en cas de soudage.



LES RAYONS DE L'ARC peuvent provoquer des brûlures dans les yeux et sur la peau.

Le rayonnement de l'arc du procédé de soudage génère des rayons visibles et invisibles intenses (ultraviolets et infrarouges) susceptibles de provoquer des brûlures dans les yeux et sur la peau. Des étincelles sont projetées pendant le soudage.

- Porter un casque de soudage approuvé muni de verres filtrants appropriés pour protéger visage et yeux pendant le soudage (voir ANSI Z49.1 et Z87.1 énuméré dans les normes de sécurité).
- Porter des lunettes de sécurité avec écrans latéraux même sous votre casque.
- Avoir recours à des écrans protecteurs ou à des rideaux pour protéger les autres contre les rayonnements les éblouissements et les étincelles ; prévenir toute personne sur les lieux de ne pas regarder l'arc.
- Porter des vêtements confectionnés avec des matières résistantes et ignifuges (cuir, coton lourd ou laine) et des bottes de protection.



LE SOUDAGE peut provoquer un incendie ou une explosion.

Le soudage effectué sur des conteneurs fermés tel que des réservoirs, tambours ou des conduites peut provoquer leur éclatement. Des étincelles peuvent être projetées de l'arc de soudure. La projection d'étincelles, des pièces chaudes et des équipements chauds peut provoquer des incendies et des brûlures. Le contact accidentel de l'électrode avec des objets métalliques peut provoquer des étincelles, une explosion, un surchauffement ou un incendie. Avant de commencer le soudage, vérifier et s'assurer que l'endroit ne présente pas de danger.

- Déplacer toutes les substances inflammables à une distance de 10,7 m de l'arc de soudage. En cas d'impossibilité les recouvrir soigneusement avec des protections homologués.
- Ne pas souder dans un endroit où des étincelles peuvent tomber sur des substances inflammables.
- Se protéger et d'autres personnes de la projection d'étincelles et de métal chaud.
- Des étincelles et des matériaux chauds du soudage peuvent facilement passer dans d'autres zones en traversant de petites fissures et des ouvertures.
- Surveiller tout déclenchement d'incendie et tenir un extincteur à proximité.
- Le soudage effectué sur un plafond, plancher, paroi ou séparation peut déclencher un incendie de l'autre côté.
- Ne pas effectuer le soudage sur des conteneurs fermés tels que des réservoirs, tambours, ou conduites, à moins qu'ils n'aient été préparés correctement conformément à AWS F4.1 (voir les normes de sécurité).
- Ne soudez pas si l'air ambiant est chargé de particules, gaz, ou vapeurs inflammables (vapeur d'essence, par exemple).
- Brancher le câble de masse sur la pièce la plus près possible de la zone de soudage pour éviter le transport du courant sur une longue distance par des chemins inconnus éventuels en provoquant des risques d'électrocution, d'étincelles et d'incendie.
- Ne pas utiliser le poste de soudage pour dégeler des conduites gelées.
- En cas de non utilisation, enlever la baguette d'électrode du porte-électrode ou couper le fil à la pointe de contact.
- Porter des vêtements de protection dépourvus d'huile tels que des gants en cuir, une chemise en matériau lourd, des pantalons sans revers, des chaussures hautes et un couvre chef.
- Avant de souder, retirer toute substance combustible de vos poches telles qu'un allumeur au butane ou des allumettes.
- Une fois le travail achevé, assurez-vous qu'il ne reste aucune trace d'étincelles incandescentes ni de flammes.
- Utiliser exclusivement des fusibles ou coupe-circuits appropriés. Ne pas augmenter leur puissance; ne pas les ponter.
- Une fois le travail achevé, assurez-vous qu'il ne reste aucune trace d'étincelles incandescentes ni de flammes.
- Utiliser exclusivement des fusibles ou coupe-circuits appropriés. Ne pas augmenter leur puissance; ne pas les ponter.
- Suivre les recommandations dans OSHA 1910.252(a)(2)(iv) et NFPA 51B pour les travaux à chaud et avoir de la surveillance et un extincteur à proximité.

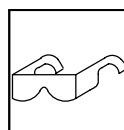

DES PIÈCES DE METAL ou DES SALETES peuvent provoquer des blessures dans les yeux.

- Le soudage, l'écaillage, le passage de la pièce à la brosse en fil de fer, et le meulage génèrent des étincelles et des particules métalliques volantes. Pendant la période de refroidissement des soudures, elles risquent de projeter du laitier.
- Porter des lunettes de sécurité avec écrans latéraux ou un écran facial.



LES ACCUMULATIONS DE GAZ risquent de provoquer des blessures ou même la mort.

- Fermer l'alimentation du gaz protecteur en cas de non-utilisation.
- Veiller toujours à bien aérer les espaces confinés ou se servir d'un respirateur d'adduction d'air homologué.



LES CHAMPS MAGNETIQUES peuvent affecter des implants médicaux.

- Porteur de simulateur cardiaque ou autre implants médicaux, rester à distance.
- Les porteurs d'implants doivent d'abord consulter leur médecin avant de s'approcher des opérations de soudage à l'arc, de soudage par points, de gougeage, du coupage plasma ou de chauffage par induction.



LE BRUIT peut endommager l'ouïe.

Le bruit des processus et des équipements peut affecter l'ouïe.

- Porter des protections approuvées pour les oreilles si le niveau sonore est trop élevé.

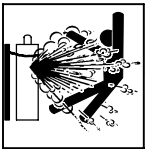

LES BOUTEILLES peuvent exploser si elles sont endommagées.

Des bouteilles de gaz protecteur contiennent du gaz sous haute pression. Si une bouteille est endommagée, elle peut exploser. Du fait que les bouteilles de gaz font normalement partie du procédé de soudage, les manipuler avec précaution.

- Protéger les bouteilles de gaz comprimé d'une chaleur excessive, des chocs mécaniques, des dommages physiques, du laitier, des flammes ouvertes, des étincelles et des arcs.
- Placer les bouteilles debout en les fixant dans un support stationnaire ou dans un porte-bouteilles pour les empêcher de tomber ou de se renverser.
- Tenir les bouteilles éloignées des circuits de soudage ou autres circuits électriques.
- Ne jamais placer une torche de soudage sur une bouteille à gaz.
- Une électrode de soudage ne doit jamais entrer en contact avec une bouteille.
- Ne jamais souder une bouteille pressurisée – risque d'explosion.
- Utiliser seulement des bouteilles de gaz protecteur, régulateurs, tuyaux et raccords convenables pour cette application spécifique ; les maintenir ainsi que les éléments associés en bon état.
- Détourner votre visage du détendeur-régulateur lorsque vous ouvrez la soupape de la bouteille.
- Le couvercle du détendeur doit toujours être en place, sauf lorsque la bouteille est utilisée ou qu'elle est reliée pour usage ultérieur.
- Utiliser les équipements corrects, les bonnes procédures et suffisamment de personnes pour soulever et déplacer les bouteilles.
- Lire et suivre les instructions sur les bouteilles de gaz comprimé, l'équipement connexe et le dépliant P-1 de la CGA (Compressed Gas Association) mentionné dans les principales normes de sécurité.

2-3. Dangers supplémentaires en relation avec l'installation, le fonctionnement et la maintenance



Risque D'INCENDIE OU D'EXPLOSION.

- Ne pas placer l'appareil sur, au-dessus ou à proximité de surfaces inflammables.
- Ne pas installer l'appareil à proximité de produits inflammables.
- Ne pas surcharger l'installation électrique – s'assurer que l'alimentation est correctement dimensionnée et protégée avant de mettre l'appareil en service.

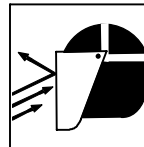

LES ÉTINCELLES VOLANTES risquent de provoquer des blessures.

- Porter un écran facial pour protéger le visage et les yeux.
- Affûter l'électrode au tungstène uniquement à la meuleuse dotée de protecteurs. Cette manœuvre est à exécuter dans un endroit sûr lorsque l'on porte l'équipement homologué de protection du visage, des mains et du corps.
- Les étincelles risquent de causer un incendie – éloigner toute substance inflammable.



LA CHUTE DE L'APPAREIL peut blesser.

- Utiliser l'anneau de levage uniquement pour soulever l'appareil, NON PAS les chariots, les bouteilles de gaz ou tout autre accessoire.
- Utiliser un équipement de levage de capacité suffisante pour lever l'appareil.
- En utilisant des fourches de levage pour déplacer l'unité, s'assurer que les fourches sont suffisamment longues pour dépasser du côté opposé de l'appareil.

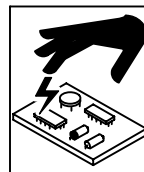

LES CHARGES ÉLECTROSTATIQUES peuvent endommager les circuits imprimés.

- Établir la connexion avec la barrette de terre avant de manipuler des cartes ou des pièces.
- Utiliser des pochettes et des boîtes antistatiques pour stocker, déplacer ou expédier des cartes de circuits imprimés.

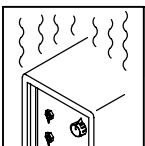

L'EMPLOI EXCESSIF peut SURCHAUFFER L'ÉQUIPEMENT.

- Prévoir une période de refroidissement ; respecter le cycle opératoire nominal.
- Réduire le courant ou le facteur de marche avant de poursuivre le soudage.
- Ne pas obstruer les passages d'air du poste.

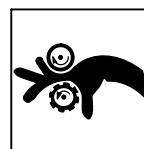

DES ORGANES MOBILES peuvent provoquer des blessures.

- Ne pas s'approcher des organes mobiles.
- Ne pas s'approcher des points de coincement tels que des rouleaux de commande.



LES FILS DE SOUDAGE peuvent provoquer des blessures.

- Ne pas appuyer sur la gâchette avant d'en avoir reçu l'instruction.
- Ne pas diriger le pistolet vers soi, d'autres personnes ou toute pièce mécanique en engageant le fil de soudage.



DES ORGANES MOBILES peuvent provoquer des blessures.

- S'abstenir de toucher des organes mobiles tels que des ventilateurs.
- Maintenir fermés et verrouillés les portes, panneaux, recouvrements et dispositifs de protection.
- Seules des personnes qualifiées sont autorisées à enlever les portes, panneaux, recouvrements ou dispositifs de protection pour l'entretien.
- Remettre les portes, panneaux, recouvrements ou dispositifs de protection quand l'entretien est terminé et avant de rebrancher l'alimentation électrique.



LIRE LES INSTRUCTIONS.

- Lisez le manuel d'instructions avant l'utilisation ou la maintenance de l'appareil.
- N'utiliser que les pièces de rechange recommandées par le constructeur.
- Effectuer régulièrement le contrôle et l'entretien de l'installation.
- Maintenir soigneusement fermés les portes et les panneaux des sources de haute fréquence, maintenir les éclateurs à une distance correcte et utiliser une terre et un blindage pour réduire les interférences éventuelles.

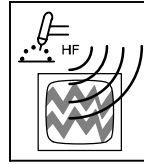

LE RAYONNEMENT HAUTE FRÉQUENCE (H.F.) risque de provoquer des interférences.

- Le rayonnement haute fréquence (H.F.) peut provoquer des interférences avec les équipements de radio-navigation et de communication, les services de sécurité et les ordinateurs.
- Demander seulement à des personnes qualifiées familiarisées avec des équipements électroniques de faire fonctionner l'installation.
- L'utilisateur est tenu de faire corriger rapidement par un électricien qualifié les interférences résultant de l'installation.
- Si le FCC signale des interférences, arrêter immédiatement l'appareil.

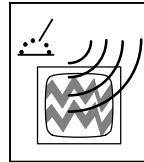

LE SOUDAGE À L'ARC risque de provoquer des interférences.

- L'énergie électromagnétique risque de provoquer des interférences pour l'équipement électronique sensible tel que les ordinateurs et l'équipement commandé par ordinateur tel que les robots.
- Veiller à ce que tout l'équipement de la zone de soudage soit compatible électromagnétiquement.
- Pour réduire la possibilité d'interférence, maintenir les câbles de soudage aussi courts que possible, les grouper, et les poser aussi bas que possible (ex. par terre).
- Veiller à souder à une distance de 100 mètres de tout équipement électronique sensible.
- Veiller à ce que ce poste de soudage soit posé et mis à la terre conformément à ce mode d'emploi.
- En cas d'interférences après avoir pris les mesures précédentes, il incombe à l'utilisateur de prendre des mesures supplémentaires telles que le déplacement du poste, l'utilisation de câbles blindés, l'utilisation de filtres de ligne ou la pose de protecteurs dans la zone de travail.

2-4. Proposition californienne 65 Avertissements

⚠ Les équipements de soudage et de coupage produisent des fumées et des gaz qui contiennent des produits chimiques dont l'État de Californie reconnaît qu'ils provoquent des malformations congénitales et, dans certains cas, des cancers. (Code de santé et de sécurité de Californie, chapitre 25249.5 et suivants)

⚠ Les batteries, les bornes et autres accessoires contiennent du plomb et des composés à base de plomb, produits chimiques dont l'État de Californie reconnaît qu'ils provoquent des cancers et des malformations congénitales ou autres problèmes de procréation. Se laver les mains après manipulation.

Pour les moteurs à essence :

⚠ Les gaz d'échappement des moteurs contiennent des produits chimiques dont l'État de Californie reconnaît qu'ils provoquent des cancers et des malformations congénitales ou autres problèmes de procréation.

Pour les moteurs diesel :

⚠ Les gaz d'échappement des moteurs diesel et certains de leurs composants sont reconnus par l'État de Californie comme provoquant des cancers et des malformations congénitales ou autres problèmes de procréation.

2-5. Principales normes de sécurité

Safety in Welding, Cutting, and Allied Processes, ANSI Standard Z49.1, de Global Engineering Documents (téléphone : 1-877-413-5184, site Internet : www.global.ihc.com).

Recommended Safe Practices for the Preparation for Welding and Cutting of Containers and Piping, American Welding Society Standard AWS F4.1 de Global Engineering Documents (téléphone : 1-877-413-5184, site Internet : www.global.ihc.com).

National Electrical Code, NFPA Standard 70, de National Fire Protection Association, P.O. Box 9101, Quincy, MA 02269-9101 (téléphone : 617-770-3000, site Internet : www.nfpa.org).

Safe Handling of Compressed Gases in Cylinders, CGA Pamphlet P-1, de Compressed Gas Association, 4221 Walney Road, 5th Floor, Chantilly, VA 20151 (téléphone : 703-788-2700, site Internet : www.cganet.com).

Code for Safety in Welding and Cutting, CSA Standard W117.2, de Canadian Standards Association, 5060 Mississauga, Ontario, Canada

L4W 5NS (téléphone : 800-463-6727 ou à Toronto 416-747-4044, site Internet : www.csa-international.org).

Safe Practice For Occupational And Educational Eye And Face Protection, ANSI Standard Z87.1, de American National Standards Institute, 11 West 43rd Street, New York, NY 10036-8002 (téléphone : 212-642-4900, site Internet : www.ansi.org).

Standard for Fire Prevention During Welding, Cutting, and Other Hot Work, NFPA Standard 51B, de National Fire Protection Association, P.O. Box 9101, Quincy, MA 02269-9101 (téléphone : 617-770-3000, site Internet : www.nfpa.org).

OSHA, Occupational Safety and Health Standards for General Industry, Title 29, Code of Federal Regulations (CFR), Part 1910, Subpart Q, and Part 1926, Subpart J, de U.S. Government Printing Office, Superintendent of Documents, P.O. Box 371954, Pittsburgh, PA 15250-7954 (téléphone : 1-866-512-1800) (il y a 10 bureaux régionaux--le téléphone de la région 5, Chicago, est 312-353-2220, site Internet : www.osha.gov).

2-6. Information EMF

Considérations sur le soudage et les effets de basse fréquence et des champs magnétiques et électriques.

Le courant de soudage, pendant son passage dans les câbles de soudage, causera des champs électromagnétiques. Il y a eu et il y a encore un certain souci à propos de tels champs. Cependant, après avoir examiné plus de 500 études qui ont été faites pendant une période de recherche de 17 ans, un comité spécial ruban bleu du National Research Council a conclu : « L'accumulation de preuves, suivant le jugement du comité, n'a pas démontré que l'exposition aux champs magnétiques et champs électriques à haute fréquence représente un risque à la santé humaine ». Toutefois, des études sont toujours en cours et les preuves continuent à être examinées. En attendant que les conclusions finales de la recherche soient établies, il vous serait souhaitable de réduire votre exposition aux champs électromagnétiques pendant le soudage ou le coupage.

Pour réduire les champs magnétiques sur le poste de travail, appliquer les procédures suivantes :

1. Garder les câbles ensemble, les torsader, les scotcher, ou les recouvrir d'une housse.
2. Disposer les câbles d'un côté et à distance de l'opérateur.
3. Ne pas courber pas et ne pas entourer pas les câbles autour de votre corps.
4. Garder le poste de soudage et les câbles le plus loin possible de vous.
5. Connecter la pince sur la pièce aussi près que possible de la soudure.

En ce qui concerne les implants médicaux :

Les porteurs d'implants doivent d'abord consulter leur médecin avant de s'approcher des opérations de soudage à l'arc, de soudage par points, de gougeage, du coupage plasma ou de chauffage par induction. Si le médecin approuve, il est recommandé de suivre les procédures précédentes.

SECTION 3 – DEFINITIONS

3-1. Manufacturer's Warning Label Definitions



Warning! Watch Out! There are possible hazards as shown by the symbols.

- 1 Electric shock from welding electrode or wiring can kill.
 - 1.1 Wear dry insulating gloves. Do not touch electrode with bare hand. Do not wear wet or damaged gloves.
 - 1.2 Protect yourself from electric shock by insulating yourself from work and ground.
 - 1.3 Disconnect input plug or power before working on machine.
- 2 Breathing welding fumes can be hazardous to your health.
 - 2.1 Keep your head out of the fumes.
 - 2.2 Use forced ventilation or local exhaust to remove the fumes.
 - 2.3 Use ventilating fan to remove fumes.
- 3 Welding sparks can cause explosion or fire.
 - 3.1 Keep flammables away from welding. Do not weld near flammables.
 - 3.2 Welding sparks can cause fires. Have a fire extinguisher nearby, and have a watchperson ready to use it.
 - 3.3 Do not weld on drums or any closed containers.
- 4 Arc rays can burn eyes and injure skin.
 - 4.1 Wear hat and safety glasses. Use ear protection and button shirt collar. Use welding helmet with correct shade of filter. Wear complete body protection.
- 5 Become trained and read the instructions before working on the machine or welding.
- 6 Do not remove or paint over (cover) the label.

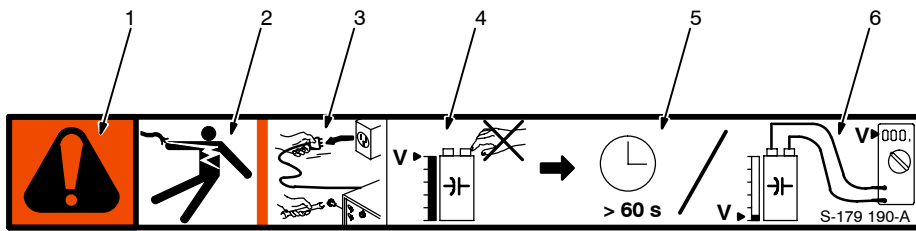

- 1 Warning! Watch Out! There are possible hazards as shown by the symbols.
- 2 Electric shock from wiring can kill.
- 3 Disconnect input plug or power before working on machine.
- 4 Hazardous voltage remains on input capacitors after power is turned off. Do not touch fully charged capacitors.
- 5 Always wait 60 seconds after power is turned off before working on unit, OR
- 6 Check input capacitor voltage, and be sure it is near 0 before touching any parts.

4/96

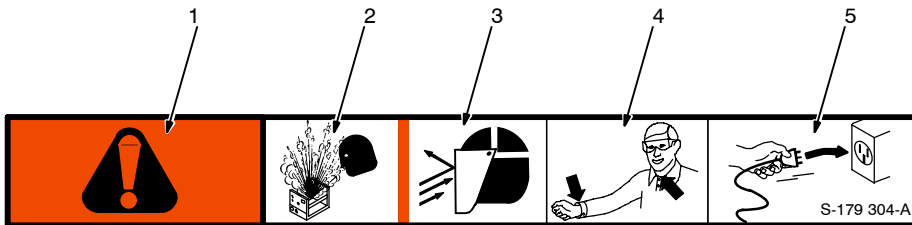

- 1 Warning! Watch Out! There are possible hazards as shown by the symbols.
- 2 When power is applied failed parts can explode or cause other parts to explode.
- 3 Flying pieces of parts can cause injury. Always wear a face shield when servicing unit.
- 4 Always wear long sleeves and button your collar when servicing unit.
- 5 After taking proper precautions as shown, connect power to unit.

4/96

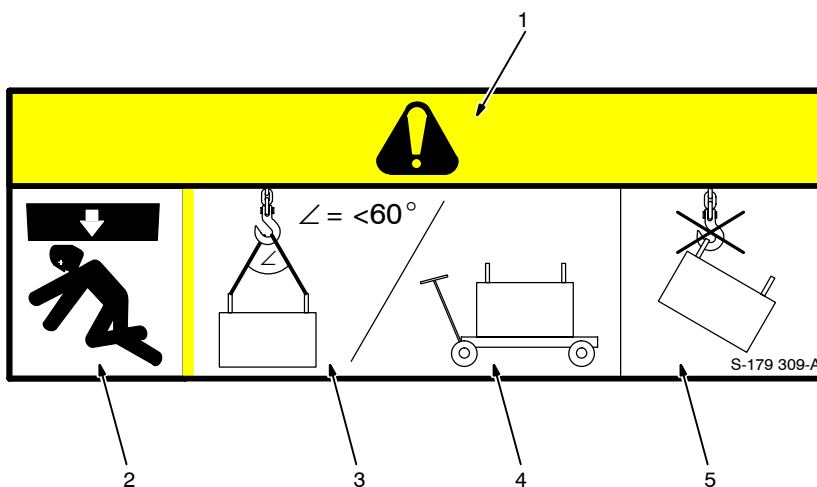

- 1 Warning! Watch Out! There are possible hazards as shown by the symbols.
- 2 Falling equipment can cause injury and damage to unit.
- 3 Always lift and support unit using both handles. Keep angle of lifting device less than 60 degrees.
- 4 Use a proper cart to move unit.
- 5 Do not use one handle to lift or support unit.

1/96

3-2. Manufacturer's Rating Label

5A/10.2V				400A/26V				30A/21.2V				375A/35V				50A/16.5V				400A/34V																																							
S				X				30%				60%				100%				S				X				30%				60%				100%																							
				I_2				400A				300A				225A								I_2				400A				300A				225A																							
$U_0 = 85V$				U_2				26V				22V				19V				$U_0 = 85V$				U_2				35V				32V				29V				$U_0 = 85V$				U_2				34V				29V				25.25V			
												I_{1max}				I_{1eff}																																											
3~ 50/60 Hz												$U_1 = 400V$				26.88A				15.54A																																							
IP23																																																											
																				223643-B																																							

223 643-B

3-3. Symbols And Definitions

A	Amperage		Panel		Alternating Current (AC)	V	Voltage
	Output		Circuit Breaker		Remote	I	On
O	Off		Gas Tungsten Arc Welding	-	Negative		Voltage Input
	Direct Current (DC)	+	Positive		Inductance		Protective Earth (Ground)
	Constant Current		Constant Voltage		Foot Control		Line Connection
	Arc Force		Shielded Metal Arc Welding (SMAW)		Gas Metal Arc Welding (GMAW)		Three Phase Static Frequency Converter-Transformer-Rectifier
U₀	Rated No Load Voltage (Average)	U₁	Primary Voltage	U₂	Conventional Load Voltage	X	Duty Cycle
Hz	Hertz	IP	Degree Of Protection	I₂	Rated Welding Current	%	Percent
	Pulsed		Lift-Arc Trigger Hold Operation (GTAW)	1~	Single Phase	3~	Three Phase
I_{1max}	Rated Maximum Supply Current	I_{1eff}	Maximum Effective Supply Current		Increase		Lift-Arc Operation (GTAW)



SECTION 4 – INSTALLATION

4-1. Specifications

Rated Welding Output	Voltage Range	Amperage Range	Maximum Open-Circuit Voltage DC	IP Rating	Amperes Input at Rated Load Output 50/60 Hz		
					400 V	KVA	KW
300 A @ 32 Volts DC, 60% Duty Cycle	10 – 35	5 – 400	90	23	17.0 (0.15*)	12.4 (0.09*)	11.5 (0.04*)

*While idling

4-2. Duty Cycle And Overheating

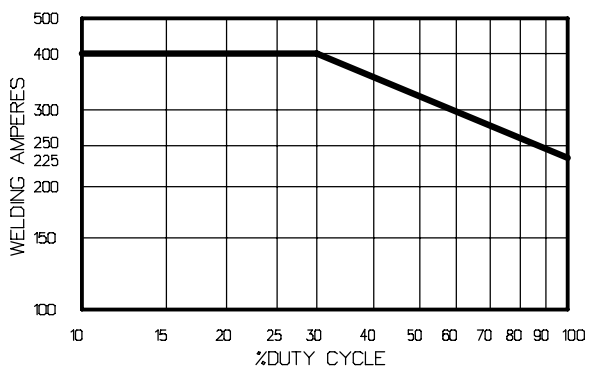

WELDING AMPERES

% DUTY CYCLE

Duty Cycle is percentage of 10 minutes that unit can weld at rated load without overheating.

If unit overheats, output stops, a Help message is displayed (see Section 6-3), and cooling fan runs. Wait fifteen minutes for unit to cool. Reduce amperage or duty cycle before welding.

NOTICE – Exceeding duty cycle can damage unit and void warranty.

60% Duty Cycle

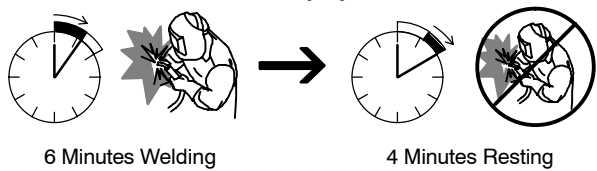

6 Minutes Welding 4 Minutes Resting

Overheating

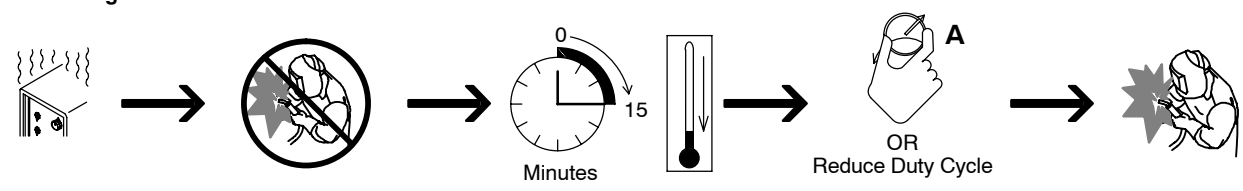

Minutes OR Reduce Duty Cycle

Ref. SA-178 651

4-3. Volt-Ampere Curves

Volt-ampere curves show minimum and maximum voltage and amperage output capabilities of unit. Curves of other settings fall between curves shown.

A. CC Mode

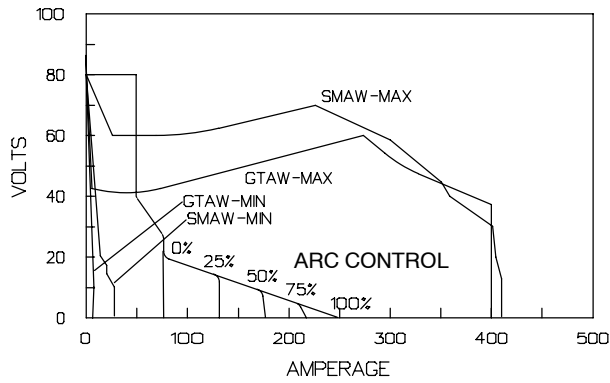

B. CV Mode

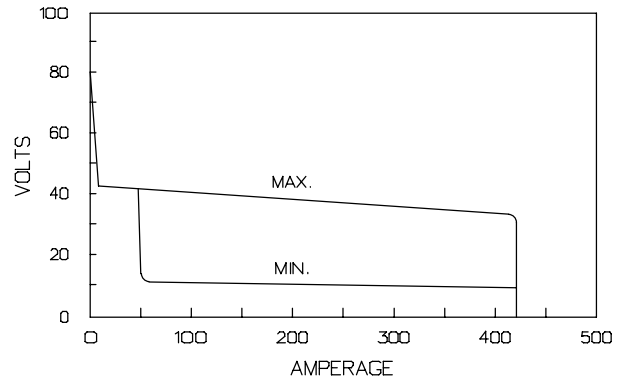

va_curve1 4/95 - SA-178 652 / SA-178 653

4-4. Dimensions And Weight

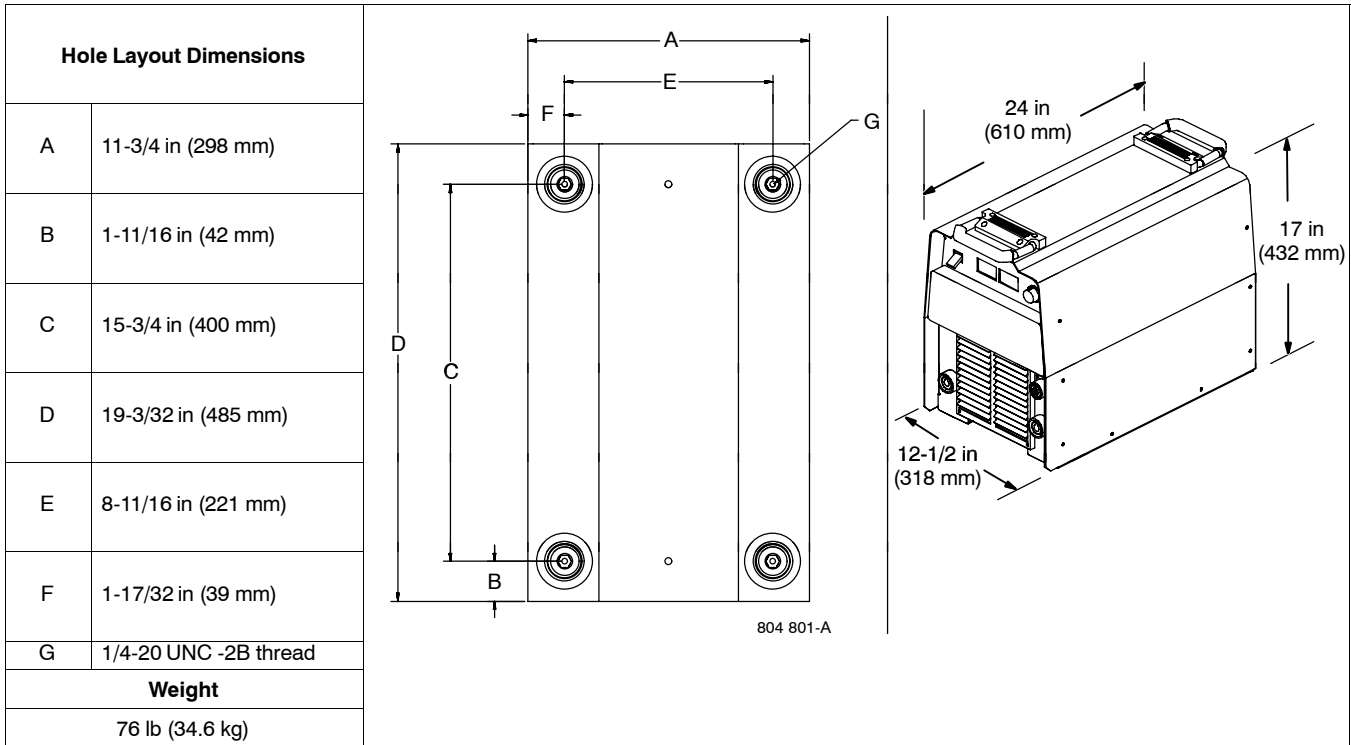

4-5. Selecting a Location

Do not move or operate unit where it could tip.

Movement

- 1 Lifting Handles
Use handles to lift unit.
- 2 Hand Cart
Use cart or similar device to move unit.
- 3 Rating Information
Use rating information on rear panel to determine input power needs.
- 4 Line Disconnect Device
Locate unit near correct input power supply.

Special installation may be required where gasoline or volatile liquids are present – see NEC Article 511 or CEC Section 20.

Location

Ref. ST-151 556 / 801 192

4-6. Weld Output Terminals And Selecting Cable Sizes



⚠️ ARC WELDING can cause Electromagnetic Interference.

To reduce possible interference, keep weld cables as short as possible, close together, and down low, such as on the floor. Locate welding operation 100 meters from any sensitive electronic equipment. Be sure this welding machine is installed and grounded according to this manual. If interference still occurs, the user must take extra measures such as moving the welding machine, using shielded cables, using line filters, or shielding the work area.



Weld Output Terminals

⚠️ Turn off power before connecting to weld output terminals.

⚠️ Do not use worn, damaged, undersized, or poorly spliced cables.

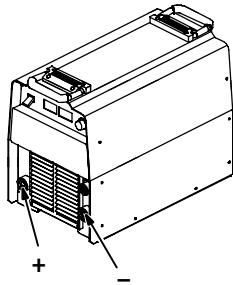

Output Receptacles

Weld Cable Size** and Total Cable (Copper) Length in Weld Circuit Not Exceeding***

	100 ft (30 m) or Less	150 ft (45 m)	200 ft (60 m)	250 ft (70 m)	300 ft (90 m)	350 ft (105 m)	400 ft (120 m)
100	4 (20)	4 (20)	4 (20)	3 (30)	2 (35)	1 (50)	1/0 (60)
150	3 (30)	3 (30)	2 (35)	1 (50)	1/0 (60)	2/0 (70)	3/0 (95)
200	3 (30)	2 (35)	1 (50)	1/0 (60)	2/0 (70)	3/0 (95)	4/0 (120)
250	2 (35)	1 (50)	1/0 (60)	2/0 (70)	3/0 (95)	4/0 (120)	2 ea. 2/0 (2x70)
300	1 (50)	1/0 (60)	2/0 (70)	3/0 (95)	4/0 (120)	2 ea. 2/0 (2x70)	2 ea. 3/0 (2x95)
350	1/0 (60)	2/0 (70)	3/0 (95)	4/0 (120)	2 ea. 2/0 (2x70)	2 ea. 3/0 (2x95)	2 ea. 3/0 (2x95)
400	1/0 (60)	2/0 (70)	3/0 (95)	4/0 (120)	2 ea. 2/0 (2x70)	2 ea. 3/0 (2x95)	2 ea. 4/0 (2x120)
500	2/0 (70)	3/0 (95)	4/0 (120)	2 ea. 2/0 (2x70)	2 ea. 3/0 (2x95)	2 ea. 4/0 (2x120)	3 ea. 3/0 (3x95)
600	3/0 (95)	4/0 (120)	2 ea. 2/0 (2x70)	2 ea. 3/0 (2x95)	2 ea. 4/0 (2x120)	3 ea. 3/0 (3x95)	3 ea. 4/0 (3x120)

* This chart is a general guideline and may not suit all applications. If cable overheats, use next size larger cable.

**Weld cable size (AWG) is based on either a 4 volts or less drop or a current density of at least 300 circular mils per ampere.
() = mm² for metric use

***For distances longer than those shown in this guide, call a factory applications representative at 920-735-4505.

S-0007-F-

4-7. Remote 14 Receptacle Information

<p style="text-align: right;">ST-801 192</p>	REMOTE 14	Socket*	Socket Information
	24 VOLTS AC OUTPUT (CONTACTOR)	A	24 volts ac. Protected by circuit breaker CB2.
		B	Contact closure to A completes 24 volts ac contactor control circuit.
	115 VOLTS AC OUTPUT (CONTACTOR)	I	115 volts ac. Protected by circuit breaker CB1.
		J	Contact closure to I completes 115 volts ac contactor control circuit.
	REMOTE OUTPUT CONTROL	C	Output to remote control; 0 to +10 volts dc, +10 volts dc in MIG mode.
		D	Remote control circuit common.
		E	0 to +10 volts dc input command signal from remote control.
	A/V AMPERAGE VOLTAGE	H	Voltage feedback; +1 volt dc per 10 output receptacle volts.
		F	Current feedback; +1 volt dc per 100 amperes.
		M	CC/CV select
	GND	G	Circuit common for 24 and 115 volts ac circuits.
	K	Chassis common.	

*The remaining sockets are not used.

4-8. Electrical Service Guide

NOTICE – **INCORRECT INPUT POWER** can damage this welding power source. This welding power source requires a **CONTINUOUS** supply of input power at rated frequency ($\pm 10\%$) and voltage ($\pm 10\%$). Phase to ground voltage shall not exceed +10% of rated input voltage. Do not use a generator with automatic idle device (that idles engine when no load is sensed) to supply input power to this welding power source.

NOTICE – Actual input voltage should not be 10% less than minimum and/or 10% more than maximum input voltages listed in table. If actual input voltage is outside this range, output may not be available.

! Failure to follow these electrical service guide recommendations could create an electric shock or fire hazard. These recommendations are for a dedicated branch circuit sized for the rated output and duty cycle of the welding power source.

	50/60 Hz Three Phase
Input Voltage	400
Input Amperes At Rated Output	18
Max Recommended Standard Fuse Rating In Amperes ¹	
Time-Delay ²	20
Normal Operating ³	25
Min Input Conductor Size In AWG ⁴	14
Max Recommended Input Conductor Length In Feet (Meters)	133 (41)
Min Grounding Conductor Size In AWG ⁴	14

Reference: 2005 National Electrical Code (NEC) (includes article 630)

1 Consult factory for circuit breaker applications.

2 "Time-Delay" fuses are UL class "RK5".

3 "Normal Operating" (general purpose - no intentional delay) fuses are UL class "K5" (up to and including 60 amp), and UL class "H" (65 amp and above).

4 Conductor data in this section specifies conductor size (excluding flexible cord or cable) between the panelboard and the equipment per NEC Table 310.16. If a flexible cord or cable is used, minimum conductor size may increase. See NEC Table 400.5(A) for flexible cord and cable requirements.

4-9. Connecting 3-Phase Input Power

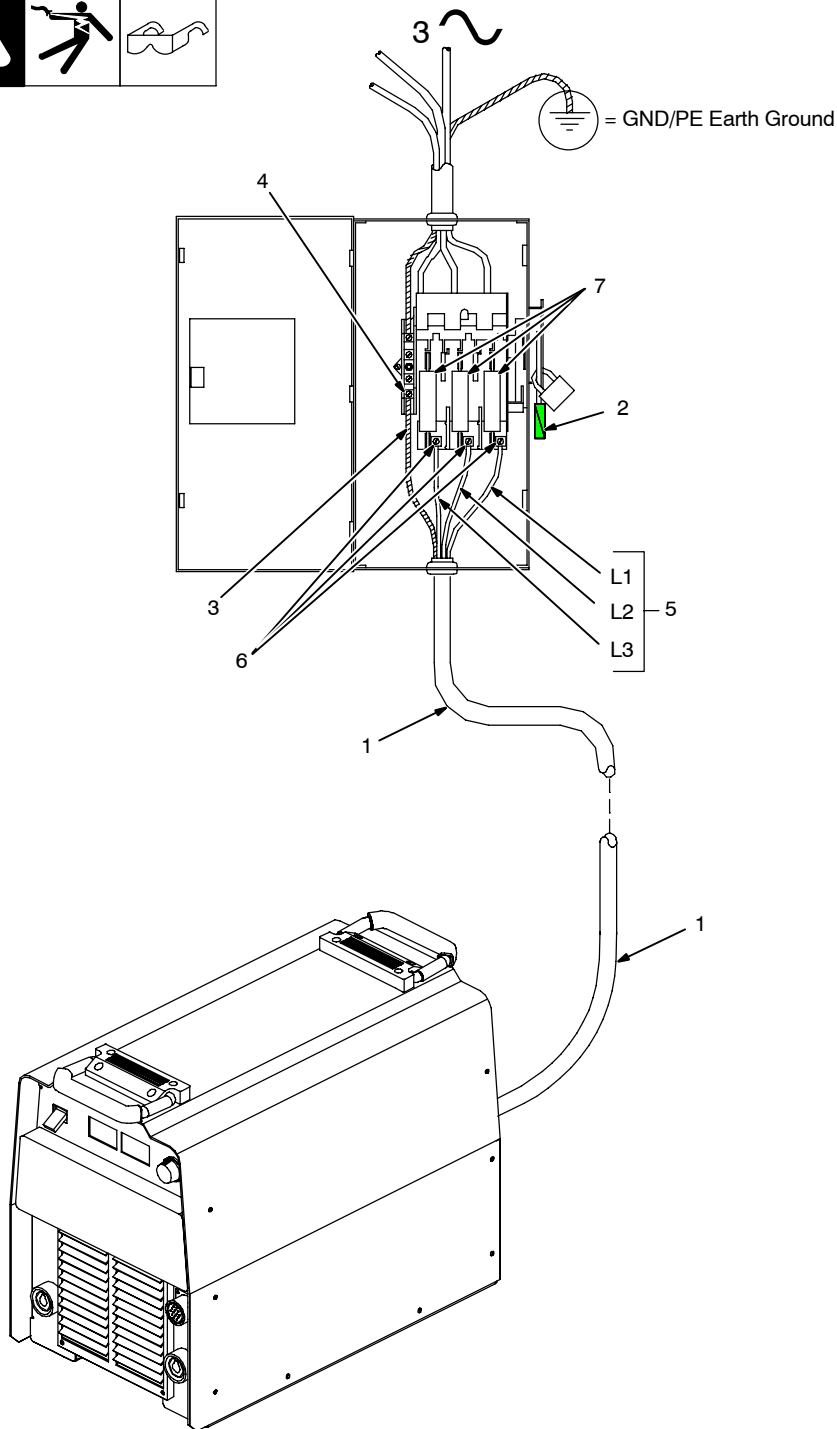

⚠ Installation must meet all National and Local Codes – have only qualified persons make this installation.

⚠ Disconnect and lockout/tagout input power before connecting input conductors from unit.

⚠ Always connect green or green/yellow conductor to supply grounding terminal first, and never to a line terminal.

For Three-Phase Operation

- 1 Input Power Cord.
- 2 Disconnect Device (switch shown in the OFF position)
- 3 Green Or Green/Yellow Grounding Conductor
- 4 Disconnect Device Grounding Terminal
- 5 Input Conductors (L1, L2 And L3)
- 6 Disconnect Device Line Terminals

Connect green or green/yellow grounding conductor to disconnect device grounding terminal first.

Connect input conductors L1, L2, and L3 to disconnect device line terminals.

7 Over-Current Protection

Select type and size of over-current protection using Section 4-8 (fused disconnect switch shown).

Close and secure door on disconnect device. Remove lockout/tagout device, and place switch in the On position.

Tools Needed:



ST-144 221 / ST-801 192 / 803 766-A

SECTION 5 – OPERATION

5-1. Front Panel Controls

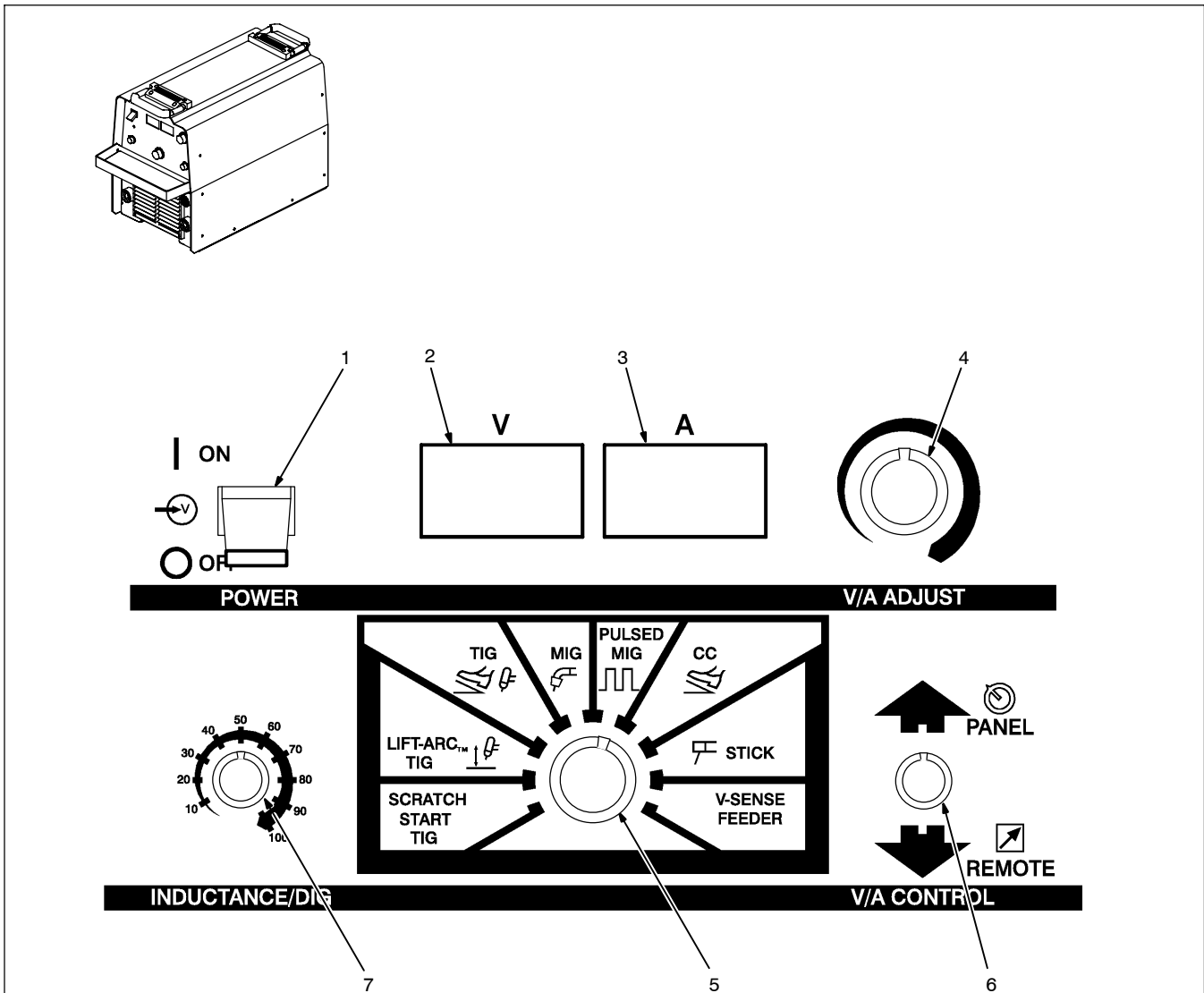

Ref. ST-175 086

1 Power On/Off Switch

The fan motor is thermostatically controlled and only runs when cooling is needed.

2 Voltmeter (see Section 5-2)

3 Ammeter (see Section 5-2)

4 Voltage/Amperage Adjustment Control

5 Mode Switch

The Mode switch setting determines both the process and output On/Off control (see Section 5-3). Source of control (panel or remote) for the amount of output is selected on the Voltage/Amperage Control switch.

For Air Carbon Arc (CAC-A) cutting and gouging, place switch in Stick position. For

best results, place Inductance/Dig control in the maximum position.

6 Voltage/Amperage Control Switch

For front panel control, place switch in Panel position.

For remote control, make connections to Remote 14 receptacle, and place switch in Remote position. In most modes, remote control is a percent of the Voltage/Amperage Adjustment control setting (the value selected on Voltage/Amperage Adjustment control is maximum available on remote). In the MIG mode, remote control provides full range of unit output regardless of V/A Adjust control setting.

7 Inductance/Dig Control

Control adjusts Dig when a Stick (SMAW) welding position is selected on mode switch.

When set lower, short-circuit amperage at low arc voltage is the same as normal welding amperage.

When set higher, short-circuit amperage is increased at low arc voltage to assist with arc starts as well as reduce sticking while welding (see volt-ampere curves in Section 4-3).









Select setting best suited for application.

Control adjusts inductance when a MIG (GMAW) position is selected on the mode switch. Inductance determines the "wetness" of the weld puddle. When set higher, "wetness" (puddle fluidity) increases.

When pulsed MIG, or one of the TIG (GTAW) processes is selected, this control is not functional.



















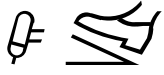







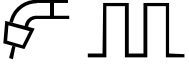



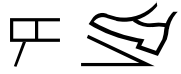

5-2. Meter Functions

 The meters display the actual weld output values for approximately three seconds after the arc is broken.

Mode	Meter Reading At Idle	
 Scratch Start TIG (GTAW)	V <div style="border: 1px solid black; padding: 2px; display: inline-block;">80.0</div> Actual Volts (OCV)	A <div style="border: 1px solid black; padding: 2px; display: inline-block;">85</div> Preset Amps
 Lift-Arc TIG (GTAW)	V <div style="border: 1px solid black; padding: 2px; display: inline-block;">7.5</div> Blank	A <div style="border: 1px solid black; padding: 2px; display: inline-block;">85</div> Preset Amps
 TIG (GTAW)	V <div style="border: 1px solid black; padding: 2px; display: inline-block;"> </div> Blank	A <div style="border: 1px solid black; padding: 2px; display: inline-block;">85</div> Preset Amps
 MIG (GMAW)	V <div style="border: 1px solid black; padding: 2px; display: inline-block;">24.5</div> Preset Volts	A <div style="border: 1px solid black; padding: 2px; display: inline-block;"> </div> Blank
 Pulsed MIG (GMAW-P)	V <div style="border: 1px solid black; padding: 2px; display: inline-block;">PPP</div> Pulse Display	A <div style="border: 1px solid black; padding: 2px; display: inline-block;">PPP</div> Pulse Display
 Remote Control SMAW	V <div style="border: 1px solid black; padding: 2px; display: inline-block;"> </div> Blank	A <div style="border: 1px solid black; padding: 2px; display: inline-block;">85</div> Preset Amps
 Panel Control SMAW	V <div style="border: 1px solid black; padding: 2px; display: inline-block;">80.0</div> Actual Volts (OCV)	A <div style="border: 1px solid black; padding: 2px; display: inline-block;">85</div> Preset Amps
 Voltage-Sensing Wirefeeder	V <div style="border: 1px solid black; padding: 2px; display: inline-block;">80.0</div> Flashes (OCV) And Preset	A <div style="border: 1px solid black; padding: 2px; display: inline-block;"> </div> Blank

5-3. Mode Switch Settings

 The SMAW modes provide the Adaptive Hot Start™ feature, which automatically increases the output amperage at the start of a weld should the start require it. This eliminates electrode sticking at arc start.

Mode	Output Control
 Scratch Start TIG (GTAW)	Select:  or  Amp ----- Weld 
 Lift-Arc TIG (GTAW)	Select:  or  Amp ----- Weld 
 TIG (GTAW) With HF Unit, Pulsing Device, Or Remote Control	Select:  or  Amp ----- Requires:   Control
 MIG (GMAW)	Select:  or  Volt ----- Requires:  Feeder
 Pulsed MIG (GMAW-P) (Requires an external pulsing device.)	Select:  Volt ----- Requires:   Feeder or Control
 Remote Control SMAW	Select:  or  Amp ----- Requires:   Control
 Panel Control SMAW	Select:  or  Amp ----- Weld 
 Voltage-Sensing Wirefeeder	Select:  or  Volt ----- Requires:  Feeder

5-4. Lift-Arc TIG Procedure

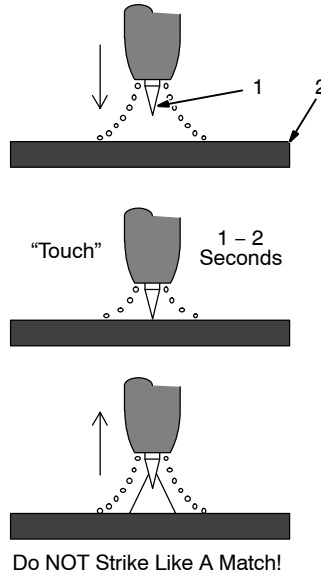

With Process Switch in the Lift-Arc TIG position, start an arc as follows:

- 1 TIG Electrode
- 2 Workpiece

Touch tungsten electrode to workpiece at weld start point, **hold electrode to workpiece for 1-2 seconds**, and slowly lift electrode. An arc will form when electrode is lifted.

Normal open-circuit voltage is not present before tungsten electrode touches workpiece; only a low sensing voltage is present between electrode and workpiece. The solid-state output contactor does not energize until after electrode is touching workpiece. This allows electrode to touch workpiece without overheating, sticking, or getting contaminated.

Ref. S-156 279

Notes

SECTION 6 – MAINTENANCE & TROUBLESHOOTING

6-1. Routine Maintenance

		Disconnect power before maintaining.		<i>Maintain more often during severe conditions.</i>		
3 Months						
		Replace Damaged Or Unreadable Labels		Repair Or Replace Cracked Cables		Replace Cracked Torch Body
						Repair Or Replace Cracked Cables And Cords
						Clean And Tighten Weld Connections
6 Months						
					Blow Out Inside	

6-2. Blowing Out Inside Of Unit

	<p>⚠ Do not remove case when blowing out inside of unit.</p> <p>To blow out unit, direct airflow through front and back louvers as shown.</p>
--	--

ST-801 192

6-3. Voltmeter/Ammeter Help Displays

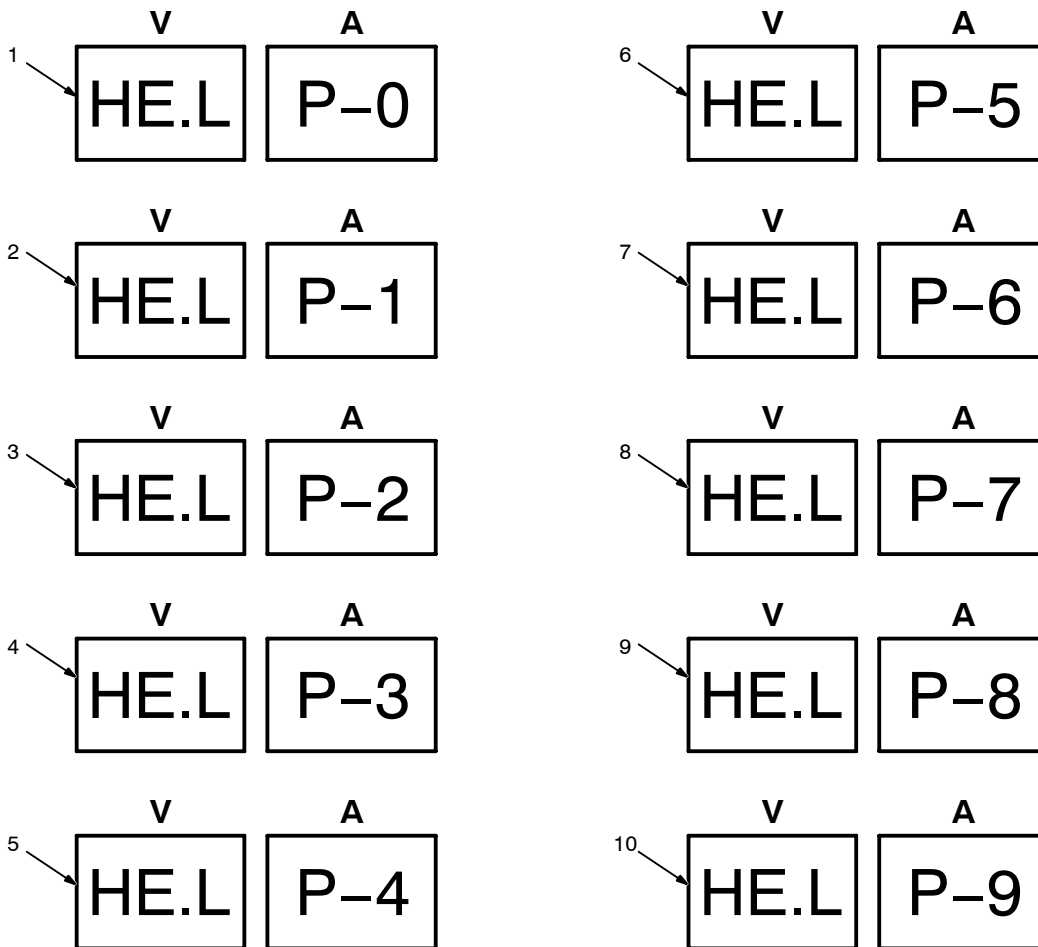

All directions are in reference to the front of the unit. All circuitry referred to is located inside the unit.

1 Help 0 Display

Indicates a shorted thermistor RT2 on the left side of the unit. If this display is shown, contact a Factory Authorized Service Agent.

2 Help 1 Display

Indicates a malfunction in the primary power circuit. If this display is shown, contact a Factory Authorized Service Agent.

3 Help 2 Display

Indicates a malfunction in the thermal protection circuitry located on the left side of the unit. If this display is shown, contact a Factory Authorized Service Agent.

4 Help 3 Display

Indicates the left side of the unit has overheated. The unit has shut down to allow the

fan to cool it (see Section 4-2). Operation will continue when the unit has cooled.

5 Help 4 Display

Indicates a malfunction in the thermal protection circuitry located on the right side of the unit. If this display is shown, contact a Factory Authorized Service Agent.

6 Help 5 Display

Indicates the right side of the unit has overheated. The unit has shut down to allow the fan to cool it (see Section 4-2). Operation will continue when the unit has cooled.

7 Help 6 Display

Indicates that the input voltage is too low and the unit has automatically shut down. Operation will continue when the voltage is within the acceptable lower range limit (15% below the applicable input voltage). If this display is

shown, have an electrician check the input voltage.

8 Help 7 Display

Indicates that the input voltage is too high and the unit has automatically shut down. Operation will continue when the voltage is within the acceptable upper range limit (15% above the applicable input voltage). If this display is shown, have an electrician check the input voltage. Help 7 can also indicate a bus voltage imbalance.

9 Help 8 Display

Indicates a malfunction in the secondary power circuit of the unit. If this display is shown, contact a Factory Authorized Service Agent.

10 Help 9 Display

Indicates a shorted thermistor RT1 on the right side of the unit. If this display is shown, contact a Factory Authorized Service Agent.

6-4. Troubleshooting

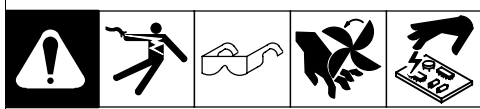

Trouble	Remedy
No weld output; unit completely inoperative.	Place line disconnect switch in On position (see Section 4-9).
	Check and replace line fuse(s), if necessary, or reset circuit breaker (see Section 4-9).
	Check for proper input power connections (see Section 4-9).
No weld output; meter display On.	If using remote control, be sure Mode Selector switch is in a position that provides output control at Remote 14 receptacle.
	Check, repair, or replace remote control.
	Unit overheated. Allow unit to cool with fan On (see Section 4-2).
Erratic or improper weld output.	Use proper size and type of weld cable (see Section 4-6).
	Clean and tighten all weld connections.
No 110 volts ac output at duplex receptacle, Remote 14 receptacle.	Reset circuit breaker CB1.
No 24 volts ac output at Remote 14 receptacle.	Reset circuit breaker CB2.

SECTION 7 - ELECTRICAL DIAGRAM

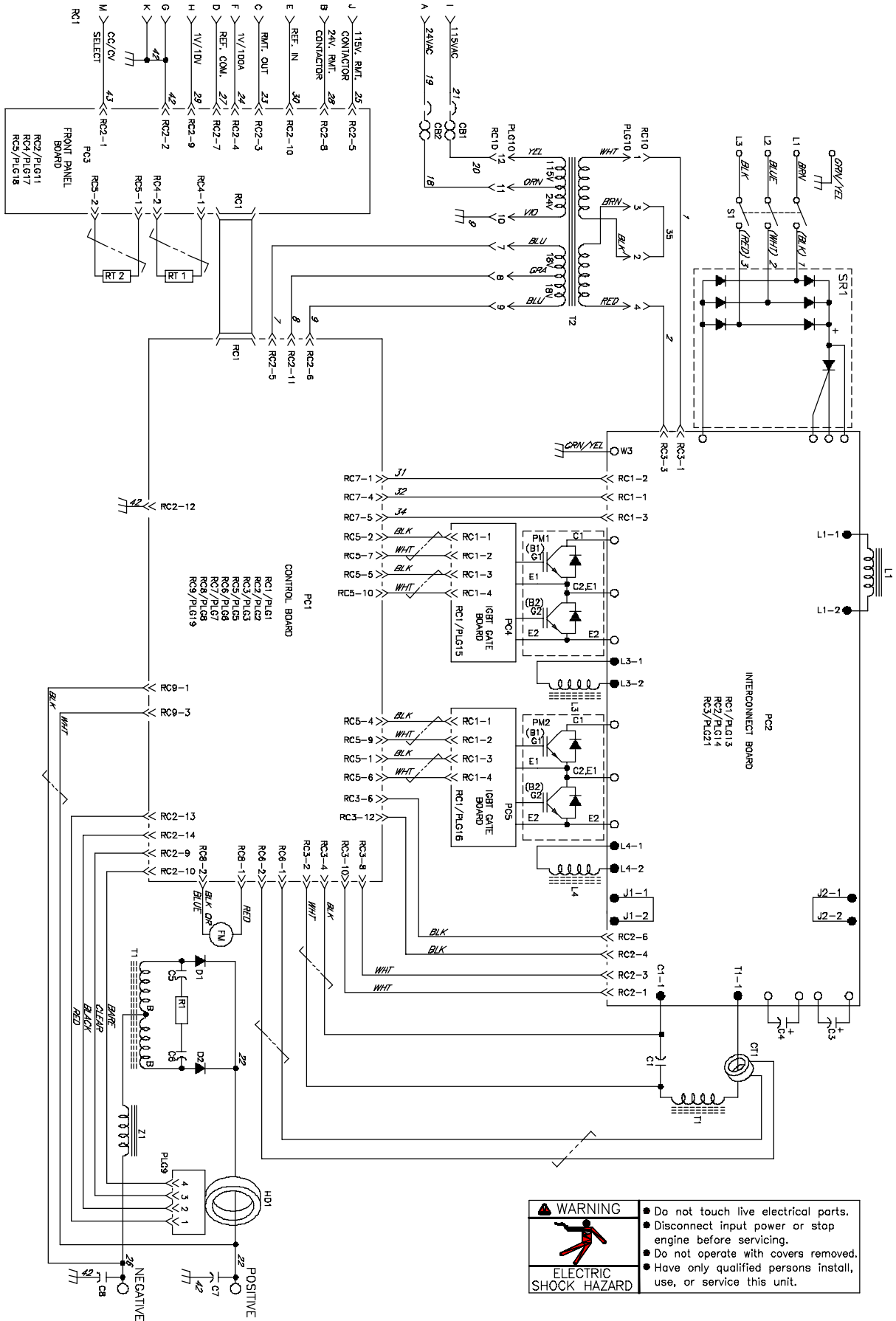

WARNING

ELECTRIC SHOCK HAZARD

- Do not touch live electrical parts.
- Disconnect input power or stop engine before servicing.
- Do not operate with covers removed.
- Have only qualified persons install, use, or service this unit.

Figure 7-1. Circuit Diagram For Welding Power Source

SECTION 8 – PARTS LIST

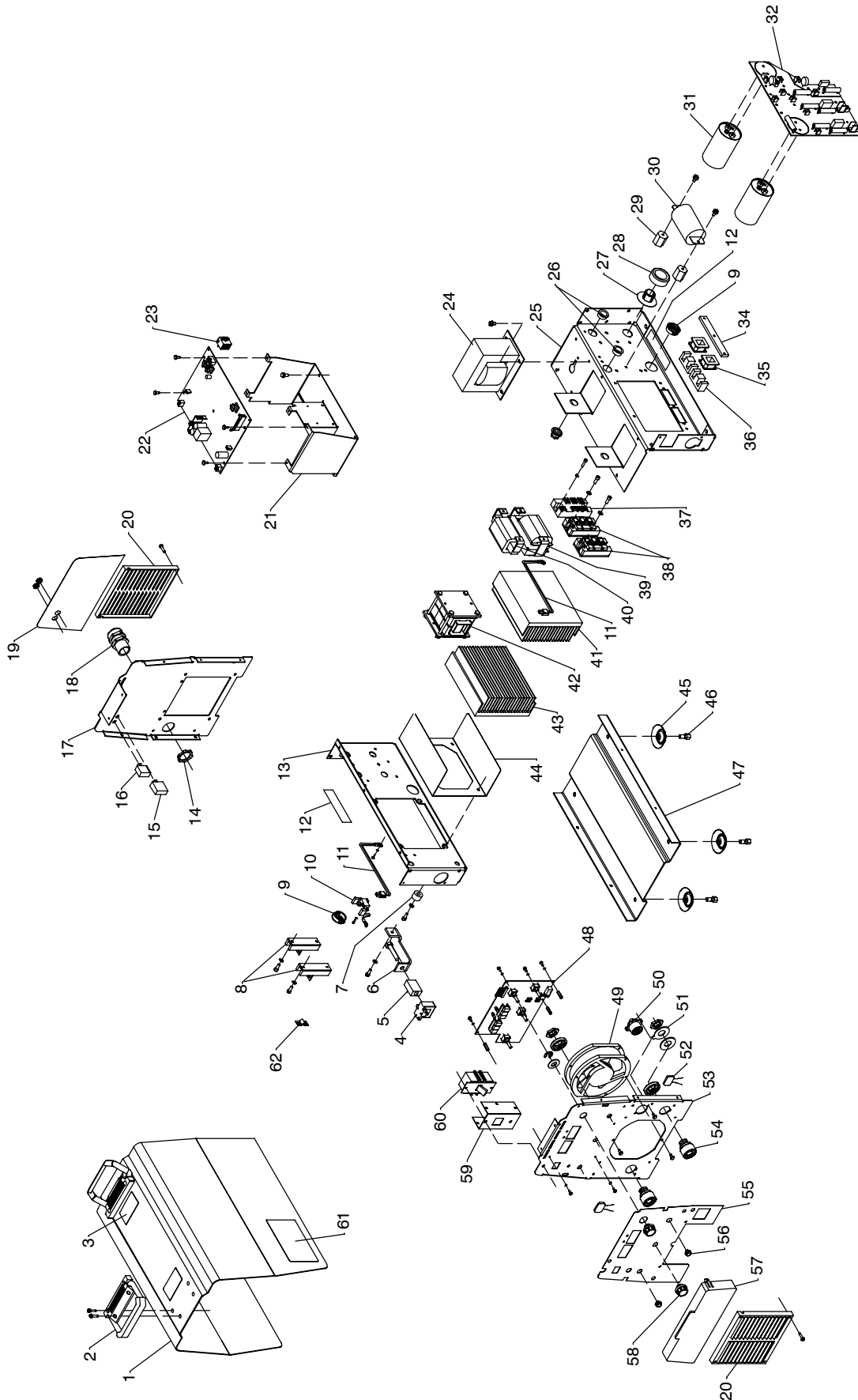

Figure 8-1. Parts Assembly

Item No.	Dia. Mkgs.	Part No.	Description	Quantity
----------	------------	----------	-------------	----------

Figure 8-1. Parts Assembly

1		+175 148	Wrapper	1
		175 256	Insulator, Side	2
2		195 585	Handle	2
3		179 309	Label, Caution Falling Equipment	2
4	HD1	182 918	Transducer, Current 400A	1
5		203 342	Bus Bar, Current Sensor	1
6		203 341	Bus Bar, Output Rectifier	1
7		181 853	Insulator, Screw	4
8	D1,2	201 531	Kit Diode, Power Module	2
9		179 276	Bushing, Snap-In Nyl 1.000 ID x 1.375Mtg Hole	2
10	C5,6 R1	175 194	Resistor/Capacitor	1
11	RT1,2	173 632	Thermistor, NTC 30K Ohm	2
12		185 836	Label, Warning Exploding Parts	2
13		+183 551	Windtunnel, Lh	1
14		234 126	Nut, Conduit 1.000 Npt Knurled	1
15	CB1	089 807	Circuit Breaker, Man Reset 1P 2.5A 250VAC	1
16	CB2	083 432	Circuit Breaker, Man Reset 1P 10A 250VAC	1
17		206 460	Panel, Rear (Without Aux. Power)	1
18		213 099	Bushing, Strain Relief	1
		178 563	Nut, Nylon 1.000 Npt	1
		186 439	Ftg, Bushing	1
		210 346	Cable, Pwr 6mm 4/C 60	1
19			Plate, Ident Rear (Order By Model And Serial Number)	1
20		175 138	Box, Louver	2
21		192 853	Bracket, Mtg Contactor/Capacitor/PC Board	1
22	PC1	215 042	Circuit Card, Control	1
	PLG2	131 056	Connector & Sockets	1
	PLG3	130 203	Connector & Sockets	1
	PLG5	115 091	Connector & Sockets	1
	PLG7	115 093	Connector & Sockets	1
23	RC10	166 679	Connector & Sockets	1
24	T2	217 322	Transformer, Control 200/400VAC	1
25		+207 727	Windtunnel, Rh	1
26		153 403	Bushing, Snap-In Nyl .750 Id X 1.000Mtg	2
27		177 547	Bushing, Snap-In Nyl 1.125Mtg	1
28	CT1	175 199	Transformer, Current	1
29		025 248	Stand-Off, Insul	2
30	C1	188 446	Capacitor, Polyp Film .5Uf 900VDC	1
31	C3,4	192 935	Capacitor, Elctlt 2700Uf 450VDC	2
32	PC2	212 210	Circuit Card, Interconnect	1
	PLG13	131 204	Connector & Sockets	1
	PLG14,21	115 093	Connector & Sockets	2
33		Deleted		
34		175 140	Bracket, Di/Dt	1
35		175 482	Coil, Di/Dt	2
36		109 056	Core	2
37	SR1	179 629	Kit Diode, Power Module	1
38	PM1,2	233 043	Kit, Transistor IGBT Module	1
39	Z1	173 570	Stabilizer	1
40	L1	173 563	Inductor, Input	1
41		207 725	Heat Sink, Power Module	1
42	T1	179 616	Transformer, Hf	1
43		207 467	Heat Sink, Rect	1
44		175 255	Insulator, Rectifier	1
		175 969	Insulator, PC Card	2
		181 197	Gasket, Di/Dt Rubber	1
45		173 693	Foot, Mtg Unit	4
46		176 736	Screw, Mtg Foot	4

Item No.	Dia. Mkgs.	Part No.	Description	Quantity
Figure 8-1. Parts Assembly (Continued)				
... 47		175 132	.. Base	1
... 48	PC3	219 820	.. Circuit Card Assy, Front Panel & Display W/Program	1
	PLG11	115 091	.. Connector & Sockets	1
... 49	FM	175 084	.. Fan, Muffin 24VDC 3000 RPM	1
... 50	RC1	186 706	.. Receptacle, W/Leads & Plug	1
... 51		178 548	.. Terminal, Connector Friction	2
... 52	C7,8	222 488	.. Capacitor, Assembly	2
... 53		185 732	.. Panel, Front	1
... 54		129 525	.. Receptacle, Twlk Insul Fem	2
		145 088	.. Kit, Connection Dinse	1
... 55			.. Nameplate, (Order By Model And Serial Number)	1
		070 590	.. Tubing, GI Acryl .325 (Order By Ft)	1ft
... 56		174 992	.. Knob, Pointer .840	2
... 57		175 855	.. Door, Front	1
... 58		174 991	.. Knob, Pointer 1.250	2
... 59		176 226	.. Insulator, Switch Power	1
... 60	S1	231 191	.. Switch, Tgl 3Pst 50A 600VAC Scr Term Wide Tgl	1
... 61		179 310	.. Label, Warning General Precautionary	2
... 62		199 840	.. Bus Bar, Diode	2

+When ordering a component originally displaying a precautionary label, the label should also be ordered.
BE SURE TO PROVIDE MODEL AND SERIAL NUMBER WHEN ORDERING REPLACEMENT PARTS.

TRUE BLUE[®]

WARRANTY

Effective January 1, 2007

(Equipment with a serial number preface of "LH" or newer)

This limited warranty supersedes all previous Miller warranties and is exclusive with no other guarantees or warranties expressed or implied.

LIMITED WARRANTY – Subject to the terms and conditions below, Miller Electric Mfg. Co., Appleton, Wisconsin, warrants to its original retail purchaser that new Miller equipment sold after the effective date of this limited warranty is free of defects in material and workmanship at the time it is shipped by Miller. THIS WARRANTY IS EXPRESSLY IN LIEU OF ALL OTHER WARRANTIES, EXPRESS OR IMPLIED, INCLUDING THE WARRANTIES OF MERCHANTABILITY AND FITNESS.

Within the warranty periods listed below, Miller will repair or replace any warranted parts or components that fail due to such defects in material or workmanship. Miller must be notified in writing within thirty (30) days of such defect or failure, at which time Miller will provide instructions on the warranty claim procedures to be followed.

Miller shall honor warranty claims on warranted equipment listed below in the event of such a failure within the warranty time periods. All warranty time periods start on the delivery date of the equipment to the original end-user purchaser, and not to exceed one year after the equipment is shipped to a North American distributor or eighteen months after the equipment is shipped to an International distributor.

1. 5 Years Parts — 3 Years Labor
 - * Original main power rectifiers
2. 3 Years — Parts and Labor
 - * Transformer/Rectifier Power Sources
 - * Plasma Arc Cutting Power Sources
 - * Process Controllers
 - * Semi-Automatic and Automatic Wire Feeders
 - * Inverter Power Sources (Unless Otherwise Stated)
 - * Water Coolant Systems (Integrated)
 - * Intellitig
 - * Engine Driven Welding Generators
(NOTE: Engines are warranted separately by the engine manufacturer.)
3. 1 Year — Parts and Labor Unless Specified
 - * Motor Driven Guns (w/exception of Spoolmate Spoolguns)
 - * Positioners and Controllers
 - * Automatic Motion Devices
 - * RFCS Foot Controls
 - * Induction Heating Power Sources, Coolers, and Electronic Controls/Recorders
 - * Water Coolant Systems (Non-Integrated)
 - * Flowgauge and Flowmeter Regulators (No Labor)
 - * HF Units
 - * Grids
 - * Spot Welders
 - * Load Banks
 - * Arc Stud Power Sources & Arc Stud Guns
 - * Racks
 - * Running Gear/Trailers
 - * Plasma Cutting Torches (except APT & SAF Models)
 - * Field Options
(NOTE: Field options are covered under True Blue[®] for the remaining warranty period of the product they are installed in, or for a minimum of one year — whichever is greater.)
 - * Bernard-Branded Mig Guns (No Labor)
 - * Weldcraft-Branded TIG Torches (No Labor)
 - * Subarc Wire Drive Assemblies
4. 6 Months — Batteries
5. 90 Days — Parts
 - * MIG Guns/TIG Torches and Subarc (SAW) Guns

- * Induction Heating Coils and Blankets, Cables, and Non-Electronic Controls
- * APT & SAF Model Plasma Cutting Torches
- * Remote Controls
- * Accessory (Kits)
- * Replacement Parts (No labor)
- * Spoolmate Spoolguns
- * Canvas Covers

Miller's True Blue[®] Limited Warranty shall not apply to:

1. **Consumable components; such as contact tips, cutting nozzles, contactors, brushes, slip rings, relays or parts that fail due to normal wear. (Exception: brushes, slip rings, and relays are covered on Bobcat, Trailblazer, and Legend models.)**
2. Items furnished by Miller, but manufactured by others, such as engines or trade accessories. These items are covered by the manufacturer's warranty, if any.
3. Equipment that has been modified by any party other than Miller, or equipment that has been improperly installed, improperly operated or misused based upon industry standards, or equipment which has not had reasonable and necessary maintenance, or equipment which has been used for operation outside of the specifications for the equipment.

MILLER PRODUCTS ARE INTENDED FOR PURCHASE AND USE BY COMMERCIAL/INDUSTRIAL USERS AND PERSONS TRAINED AND EXPERIENCED IN THE USE AND MAINTENANCE OF WELDING EQUIPMENT.

In the event of a warranty claim covered by this warranty, the exclusive remedies shall be, at Miller's option: (1) repair; or (2) replacement; or, where authorized in writing by Miller in appropriate cases, (3) the reasonable cost of repair or replacement at an authorized Miller service station; or (4) payment of or credit for the purchase price (less reasonable depreciation based upon actual use) upon return of the goods at customer's risk and expense. Miller's option of repair or replacement will be F.O.B., Factory at Appleton, Wisconsin, or F.O.B. at a Miller authorized service facility as determined by Miller. Therefore no compensation or reimbursement for transportation costs of any kind will be allowed.

TO THE EXTENT PERMITTED BY LAW, THE REMEDIES PROVIDED HEREIN ARE THE SOLE AND EXCLUSIVE REMEDIES. IN NO EVENT SHALL MILLER BE LIABLE FOR DIRECT, INDIRECT, SPECIAL, INCIDENTAL OR CONSEQUENTIAL DAMAGES (INCLUDING LOSS OF PROFIT), WHETHER BASED ON CONTRACT, TORT OR ANY OTHER LEGAL THEORY.

ANY EXPRESS WARRANTY NOT PROVIDED HEREIN AND ANY IMPLIED WARRANTY, GUARANTY OR REPRESENTATION AS TO PERFORMANCE, AND ANY REMEDY FOR BREACH OF CONTRACT TORT OR ANY OTHER LEGAL THEORY WHICH, BUT FOR THIS PROVISION, MIGHT ARISE BY IMPLICATION, OPERATION OF LAW, CUSTOM OF TRADE OR COURSE OF DEALING, INCLUDING ANY IMPLIED WARRANTY OF MERCHANTABILITY OR FITNESS FOR PARTICULAR PURPOSE, WITH RESPECT TO ANY AND ALL EQUIPMENT FURNISHED BY MILLER IS EXCLUDED AND DISCLAIMED BY MILLER.

Some states in the U.S.A. do not allow limitations of how long an implied warranty lasts, or the exclusion of incidental, indirect, special or consequential damages, so the above limitation or exclusion may not apply to you. This warranty provides specific legal rights, and other rights may be available, but may vary from state to state.

In Canada, legislation in some provinces provides for certain additional warranties or remedies other than as stated herein, and to the extent that they may not be waived, the limitations and exclusions set out above may not apply. This Limited Warranty provides specific legal rights, and other rights may be available, but may vary from province to province.

miller_warr 2007-01

Warranty Questions?

Call
1-800-4-A-MILLER
for your local
Miller distributor.

Your distributor also gives
you ...

Service

You always get the fast,
reliable response you
need. Most replacement
parts can be in your
hands in 24 hours.

Support

Need fast answers to the
tough welding questions?
Contact your distributor.
The expertise of the
distributor and Miller is
there to help you, every
step of the way.





Owner's Record

Please complete and retain with your personal records.

Model Name

Serial/Style Number

Purchase Date

(Date which equipment was delivered to original customer.)

Distributor

Address

City

State

Zip



For Service

Contact a DISTRIBUTOR or SERVICE AGENCY near you.

Always provide Model Name and Serial/Style Number.

Contact your Distributor for:

Welding Supplies and Consumables

Options and Accessories

Personal Safety Equipment

Service and Repair

Replacement Parts

Training (Schools, Videos, Books)

Technical Manuals (Servicing Information and Parts)

Circuit Diagrams

Welding Process Handbooks

To locate a Distributor or Service Agency visit www.millerwelds.com or call 1-800-4-A-Miller

Contact the Delivering Carrier to:

File a claim for loss or damage during shipment.

For assistance in filing or settling claims, contact your distributor and/or equipment manufacturer's Transportation Department.

Miller Electric Mfg. Co.

An Illinois Tool Works Company
1635 West Spencer Street
Appleton, WI 54914 USA

International Headquarters—USA

USA Phone: 920-735-4505 Auto-Attended
USA & Canada FAX: 920-735-4134
International FAX: 920-735-4125

European Headquarters – United Kingdom

Phone: 44 (0) 1204-593493
FAX: 44 (0) 1204-598066

www.MillerWelds.com



Free Manuals Download Website

<http://myh66.com>

<http://usermanuals.us>

<http://www.somanuals.com>

<http://www.4manuals.cc>

<http://www.manual-lib.com>

<http://www.404manual.com>

<http://www.luxmanual.com>

<http://aubethermostatmanual.com>

Golf course search by state

<http://golfingnear.com>

Email search by domain

<http://emailbydomain.com>

Auto manuals search

<http://auto.somanuals.com>

TV manuals search

<http://tv.somanuals.com>