

Operating Instructions

प्रचालन अनुदेश
هدایات برائے استعمال
دفترچه راهنما
إرشادات التشغيل

Microwave / Grill Oven

माइक्रोवेव / ग्रिल ओवन
مائیکروویو / گرل اوون
مایکروویو / اجاق سرخ کن
فرن مایکروویف/شوایة

Household Use Only

केवल घरेलू प्रयोग के लिए द
صرف گهریلو استعمال
فقط استفادہ خانگی
استعمال منزلي فقط



Model No. NN-GD692S

Panasonic Corporation
Web Site: <http://panasonic.net>

F00039X90KT
IP0812-0

Before operating this oven, please read these instructions completely and keep for future reference.

इस ओवन को चलाने से पहले, कृपया इन निर्देशों को पूरी तरह से पढ़ लें और भविष्य में संदर्भ के लिए अपने पास रखें।

اس اوون کو استعمال کرنے سے پہلے براہ کرم ان ہدایات کو مکمل طور پر پڑھ لیں اور آئندہ ریفرنس کیلئے رکھیں۔

قبل از استفاده از این دستگاه، لطفاً مطالب این دفترچه را به طور کامل بخوانید و آن را بر ای مراجعه در آینده نزد خود نگه دارید.

قبل تشغيل هذا الفرن، يرجى قراءة هذه التعليمات بالكامل والاحتفاظ بها للرجوع اليها في المستقبل.

Important Safety Instructions

READ CAREFULLY AND KEEP FOR FUTURE REFERENCE

Precautions to be taken when using Microwave Ovens for Heating Foodstuffs

Inspection for Damage:

A microwave oven should only be used if an inspection confirms all of the following conditions:

1. The grille is not damaged or broken.
2. The door fits squarely and securely and opens and closes smoothly.
3. The door hinges are in good condition.
4. The metal plates of a metal seal on the door are neither buckled nor deformed.
5. The door seals are neither covered with food nor have large burn marks.

Precautions:

Microwave radiation from microwave ovens can cause harmful effects if the following precautions are not taken:

1. Never tamper with or deactivate the interlocking devices on the door.
2. Never poke an object, particularly a metal object, through a grille or between the door and the oven while the oven is operating.
3. Never place saucepans, unopened cans or other heavy metal objects in the oven.
4. Do not let other metallic articles, e.g. fast food foil containers, touch the side of the oven.
5. Clean the oven cavity, the door and the seals with water and a mild detergent at regular intervals. Never use any form of abrasive cleaner that may scratch or scour surfaces around the door.
6. Always use the oven with the trays or cookware recommended by the manufacturer.
7. Never operate the oven without a load (i.e. an absorbing material such as food or water) in the oven cavity unless specifically allowed in the manufacturer's literature.
8. For horizontally hinged doors, never rest heavy objects such as food containers on the door while it is open.
9. Do not place sealed containers in the microwave oven. Baby bottles fitted with a screw cap or a teat are considered to be sealed containers.
10. This appliance is not intended for use by persons (including children) with reduced physical, sensory or mental capabilities, or lack of experience and knowledge, unless they have been given supervision or instruction concerning use of the appliance by a person responsible for their safety.
11. Young children should be supervised to ensure that they do not play with the appliance.
12. It is hazardous for anyone other than a competent person to carry out any service or repair operation that involves the removal of a cover which gives protection against exposure to microwave energy.

Earthing Instructions

This microwave oven must be earthed. In the event of an electrical short circuit, earthing reduces the risk of electric shock by providing an escape wire for the electric current. This microwave oven is equipped with an earthing plug. The plug must be plugged into an outlet that is properly installed and earthed.

WARNING—Improper use of the earthing plug can result in electric shock.

Important Instructions

WARNING—To reduce the risk of burns, electric shock, fire, injury to persons or excessive microwave energy:

1. Read all instructions before using microwave oven.
2. Some products such as whole eggs and sealed containers - (for example, closed glass jars **and sealed baby bottles with teat**) may explode and should not be heated in microwave oven.
3. Use this microwave oven only for its intended use as described in this manual.
4. As with any appliance, close supervision is necessary when used by children.
5. Do not operate this microwave oven, if it is not working properly, or if it has been damaged or dropped.
6. Do not store or use this appliance outdoors.
7. Do not immerse cord or plug in water.
8. Keep cord away from heated surfaces.
9. Do not let cord hang over edge of table or counter.
10. To reduce the risk of fire in the oven cavity:
 - (a) Do not overcook food. Carefully attend microwave oven if paper, plastic, or other combustible materials are placed inside the oven to facilitate cooking.
 - (b) Remove wire twist-ties from bags before placing bag in oven.
 - (c) If materials inside the oven should ignite, keep oven door closed, turn oven off at the wall switch, or shut off power at the fuse or circuit breaker panel.
 - (d) Never leave microwave unattended while cooking or reheating.
 - (e) Heating therapeutic wheat bags is not recommended. If heating, do not leave unattended and follow manufacturers' instructions carefully.
11. Do not remove outer panel from oven.
12. Appliances are not intended to be operated by means of an external timer or separate remote-control system.
13. Failure to maintain the oven in a clean condition could lead to deterioration of the surface that could adversely affect the life of the appliance and possibly result in a hazardous situation.

Circuits

Your microwave ovens should be operated on a separate circuit from other appliances. The voltage used must be the same as specified on this microwave oven. Failure to do this may cause the power board fuse to blow, and/or food to cook slower. Do not insert higher value fuse in the power board.

Practical Hints:

1. For initial use of COMBINATION and GRILL, if you see white smoke arise, it is not malfunction.
2. Exterior oven surfaces, including air vents on the cabinet and the oven door will get hot during COMBINATION and GRILL. Use care when opening or closing door and when inserting or removing food and accessories.
3. The oven has a heater situated in the top of the oven. After using the GRILL and COMBINATION functions, the ceiling will be very hot.
4. The accessible parts may become hot when GRILL or COMBINATION is in use. Children should be kept away.

Fan Motor Operation after Cooking

After using this oven, the fan may rotate to cool the electric components. This is perfectly normal, and you can take out the food from the oven while the fan operates.

Installation and General Instructions

General Use

1. In order to maintain high quality, do not operate the oven when empty. The microwave energy will reflect continuously throughout the oven if no food or water is present to absorb energy. This can lead to damage to the microwave oven including arcing within the oven cavity.
2. If smoke is observed, press the **Stop/Reset** Button and leave door closed. Disconnect the power cord, or shut off power at the fuse or circuit breaker panel.
3. Do not dry clothes, newspapers or other materials in oven. They may catch on fire.
4. Do not use recycled paper products, unless the paper product is labelled as safe for microwave oven use. Recycled paper products may contain impurities which may cause sparks and/or fires when used.
5. Do not use newspapers or paper bags for cooking.
6. Do not hit or strike control panel. Damage to controls may occur.
7. POT HOLDERS may be needed as heat from food is transferred to the cooking container and from the container to the glass tray. The glass tray can be very hot after removing the cooking container from the oven.
8. Do not store flammable materials next to, on top of, or in the oven. It could be a fire hazard.
9. Do not cook food directly on glass tray unless indicated in recipes. (Food should be placed in a suitable cooking utensil.)
10. DO NOT use this oven to heat chemicals or other non-food products. DO NOT clean this oven with any product that is labeled as containing corrosive chemicals. The heating of corrosive chemicals in this oven may cause microwave radiation leaks.
11. If glass tray is hot, allow to cool before cleaning or placing in water.
12. When using the COMBINATION mode, never place any aluminum or metal container directly on the wire rack. Always insert a heat-proof, glass plate or dish between the wire rack and the aluminum container. This will prevent sparking that may damage the oven.
13. During cooking, some steam will condense inside and/or on the oven door. This is normal and safe. Steam will disappear after the oven is cool down.
14. During use the appliance becomes hot. Care should be taken to avoid touching heating elements inside the oven.
15. It is recommended not to use the wire rack when cooking in the MICROWAVE mode only.
16. Do not leave the microwave unattended while reheating or cooking food in disposable containers made of plastic, paper or other combustible materials, as these types of containers can ignite if overheated.

Placement of Oven

1. The oven must be placed on a flat, stable surface, more than 85 cm above the floor. For correct operation, the oven must have sufficient air flow. Allow 15 cm of space on the top of the oven, 10 cm at back and 10 cm on both sides. If one side of the oven is placed flush to a wall, the other side or top must not be blocked. Do not remove feet.

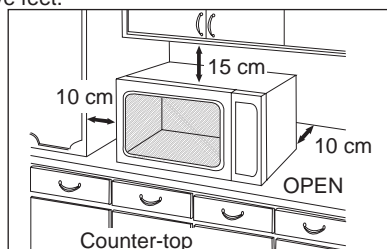

- (a) Do not block air vents. If they are blocked during operation, the oven may be overheated and damaged. When using any cloth over the oven, the air intake and exhaust should not be blocked. Also allow sufficient space on back and both sides of the oven.
 - (b) Do not place oven near a hot or damp surface such as a gas stove, electric range or sink etc.
 - (c) Do not operate oven when room humidity is too high.
2. This oven was manufactured for household use only.

Food

1. Do not use your oven for home canning or the heating of any closed jar. Pressure will build up and the jar may explode. In addition, the microwave oven cannot maintain the food at the correct canning temperature. Improperly canned food may spoil and be dangerous to consume.
2. Do not attempt to deep fat fry in your microwave oven.
3. Do not boil eggs in their shell (unless otherwise stated in cookbook). Pressure will build up and the eggs will explode.
4. Potatoes, apples, egg yolks, whole squash and sausages are examples of foods with nonporous skins. This type of food must be pierced before cooking, to prevent bursting.
5. When heating liquids, e.g. soup, sauces and beverages in your microwave oven, overheating the liquid beyond boiling point can occur without evidence of bubbling. This could result in a sudden boil over the hot liquid. To prevent this possibility the following steps should be taken.
 - (a) Avoid using straight-sided containers with narrow necks.
 - (b) Do not overheat.
 - (c) Stir the liquid before placing the container in the oven and again halfway through cooking time.
 - (d) After heating, allow to stand in the oven for a short time, stirring again before carefully removing the container.
6. **DO NOT USE A CONVENTIONAL MEAT THERMOMETER IN THE MICROWAVE OVEN. To check the degree of cooking of roasts and poultry use a MICROWAVE THERMOMETER.** Alternatively, a conventional meat thermometer may be used after the food is removed from the oven. If undercooked, return meat or poultry to the oven and cook for a few more minutes at the recommended power level. It is important to ensure that meat and poultry are thoroughly cooked.
7. **COOKING TIMES given in the cookbook are APPROXIMATE.** Factors that may affect cooking time are preferred degree of moisture content, starting temperature, altitude, volume, size, shape of food and utensils used. As you become familiar with the oven, you will be able to adjust for these factors.
8. It is better to **UNDERCOOK RATHER THAN OVERCOOK** foods. If food is undercooked, it can always be returned to the oven for further cooking. If food is overcooked, nothing can be done. Always start with minimum cooking times recommended.
9. Extreme care should be taken when cooking popcorn in a microwave oven. Cook for minimum time as recommended by manufacturer. Use the directions suitable for the wattage of your microwave oven. NEVER leave oven unattended when popping popcorn.
10. When heating food in plastic or paper containers, check the oven frequently due to the possibility of ignition.
11. The contents of feeding bottles and baby food jars are to be stirred or shaken and the temperature is to be checked before consumption, in order to avoid burns.

Feature Diagram

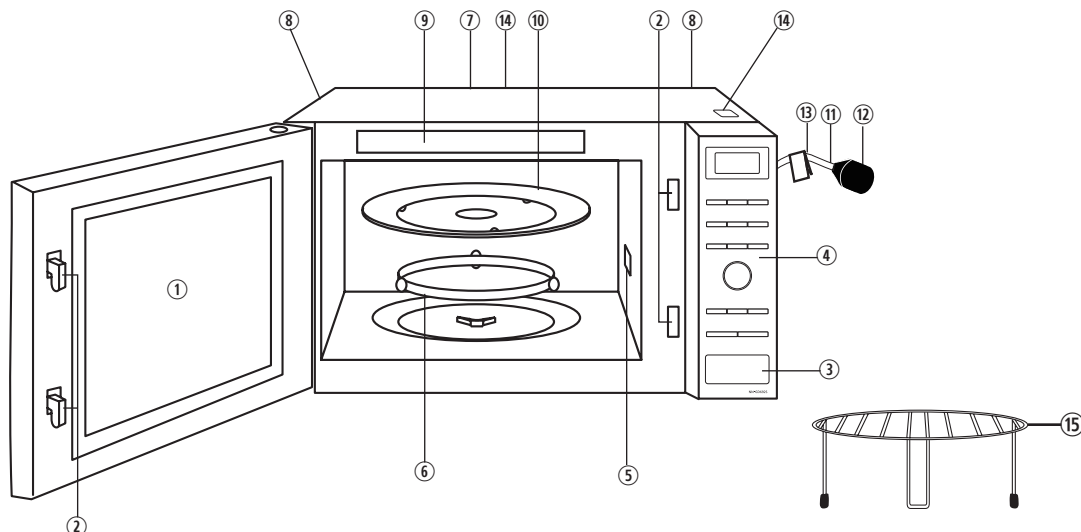

① **Oven Window**

② **Door Safety Lock System**

③ **Door Release Button**

Push to open the door. Opening the door during cooking will stop the cooking process without cancelling the program. Cook resumes as soon as the door is closed and **Start** Button is pressed. It is quite safe to open the door at any time during a cooking program and there is no risk of Microwave exposure.

④ **Control Panel**

⑤ **Waveguide Cover (do not remove)**

⑥ **Roller Ring**

- a. Roller Ring should be cleaned regularly to avoid excessive noise.
- b. Roller Ring and Glass Tray should be used at the same time.

⑦ **Identification Plate**

⑧ **Oven Air Vent**

⑨ **Menu Label**

Position your supplied auto program menu label here.

⑩ **Glass Tray**

- a. DO NOT operate the oven without the Roller Ring and Glass Tray in place.
- b. Only use the Glass Tray specifically designed for this oven. Do not substitute any other Glass Tray.
- c. If the Glass Tray is hot, allow to cool before cleaning or placing in water.

d. DO NOT cook directly on the Glass Tray.

Always place food on a microwave-safe dish.

e. If food or utensil on the Glass Tray touches oven walls, causing the tray to stop moving, the tray will automatically rotate in the opposite direction. This is normal.

f. Glass Tray can rotate in either direction.

⑪ **Power Supply Cord**

⑫ **Power Supply Plug**

⑬ **Power Supply Cord Label**

⑭ **Warning Label**

⑮ **Wire Rack**

- a. A Wire Rack is included with the oven in order to facilitate browning of small dishes.
- b. Wire Rack should be cleaned regularly.
- c. When using Wire Rack in the manual GRILL or COMBINATION cooking modes, be careful to choose heat-proof containers; containers made of plastic or paper may melt or burn when exposed to the heat radiating from the grill.
- d. When using the COMBINATION mode, never place any aluminum or metal container directly on Wire Rack. Always insert a glass plate or dish between Wire Rack and the aluminum container. This will prevent sparking that may damage the oven.
- e. Do not use Wire Rack when cooking in the MICROWAVE mode only.

Warning

- (a) The door seals and door seal areas should be cleaned with a damp cloth. The appliance should be inspected for damage to the door seals and door seal areas and if these areas are damaged the appliance should not be operated until it has been repaired by a service technician trained by the manufacturer.
- (b) It is dangerous for anyone other than a service technician trained by the manufacturer to perform repair service.
- (c) If the supply cord of this appliance is damaged, it must be replaced by the manufacturer or its service agent or a similarly qualified person in order to avoid a hazard.
- (d) Before use, the user should check that whether the utensils are suitable for use in microwave ovens.
- (e) Liquids or other foods must not be heated in sealed containers since they are liable to explode, at the same time it should avoid the boiling liquids splash.
- (f) Only allow children to use the oven without supervision when adequate instructions have been given so that the child is able to use the oven in a safe way and understands the hazards of improper use.
- (g) When the appliance is operated in the grill or combination modes, children should only use the oven under adult supervision due to the temperatures generated.
- (h) Children being supervised not to play with appliance.

Control Panel

English

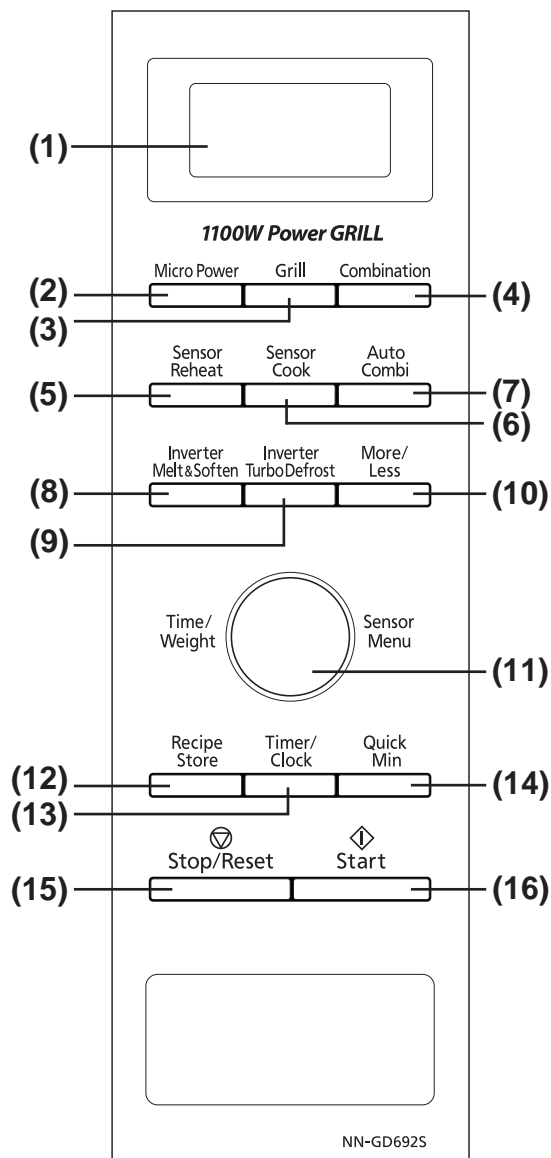

- (1) **Display Window**
- (2) **Micro Power Button** (pg.6)
- (3) **Grill Button** (pg. 9)
- (4) **Combination Button** (pg. 10)
- (5) **Sensor Reheat Button** (pg.16)
- (6) **Sensor Cook Button** (pg.17)
- (7) **Auto Combi Button** (pg.11)
- (8) **Inverter Melt & Soften Button** (pg.15)
- (9) **Inverter Turbo Defrost Button** (pg.13)
- (10) **More/Less Button**
- (11) **Time/Weight/Sensor Menu Dial**
Press and release dial to expand (pop-up).
After setting desired program, push dial into avoid accidental changing of the Programmed time.
- (12) **Recipe Store Button** (pg.7)
- (13) **Timer/ Clock Button** (pg.5, 20)
- (14) **Quick Min Button** (pg.8)
- (15) **Stop/Reset Button**
Before cooking: One tap clears all your instructions.
During cooking: One tap temporarily stops the cooking process. Another tap cancels all your instructions and colon or time of day appears in the Display Window.
- (16) **Start Button**
One tap allows oven to begin functioning. If door is opened or **Stop/Reset Button** is pressed once during oven operation, **Start Button** must be pressed again to restart oven.

NOTE:

If an operation is set and **Start** Button is not pressed, after 6 minutes, the oven will automatically cancel the operation. The display will revert back to clock or colon mode.

Display Window

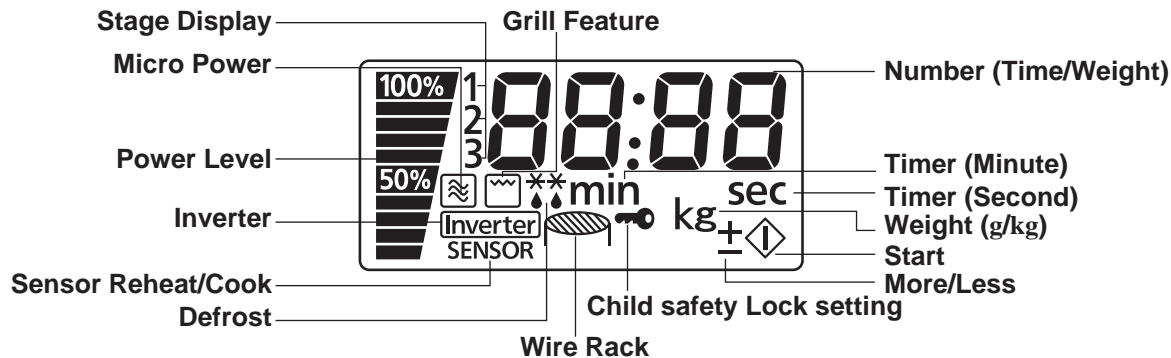

English

To Set Clock

You can use the oven without setting the clock.

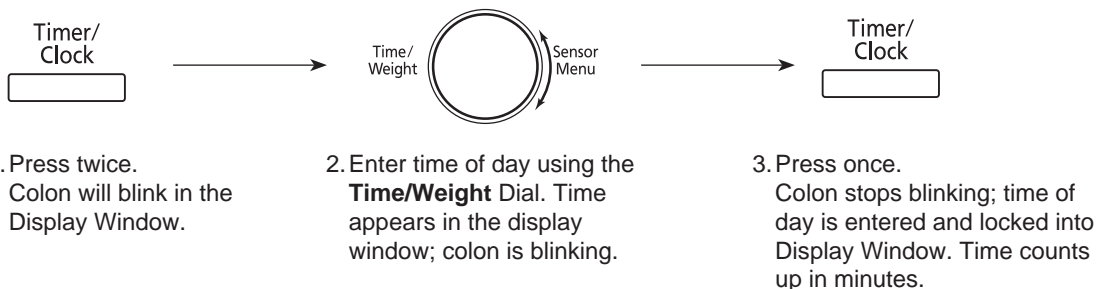

NOTES:

1. Oven will not operate while colon is still blinking.
2. To reset time of day, repeat step 1 to 3, the door is open or closed.
3. The clock will keep the time of day as long as oven is plugged in and electricity is supplied.
4. Clock is a 12-hour display.

To Use Child Safety Lock

This feature allows you to prevent operation of the oven by a young child; however, the door is open or closed. You can set Child Safety Lock when colon or time of day is displayed.

To set:

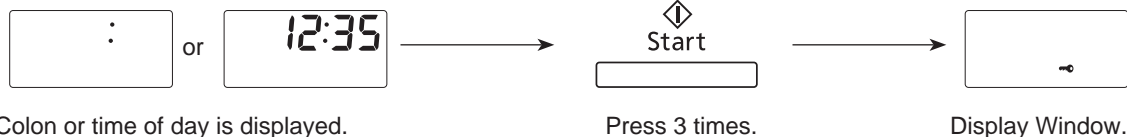

To cancel:

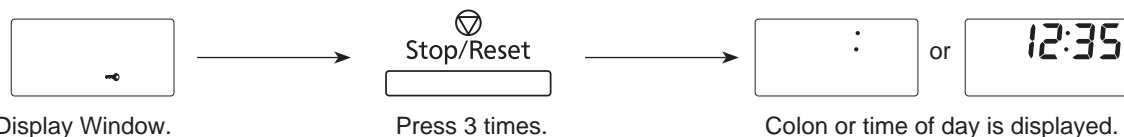

NOTE:

To set or cancel child safety lock, **Start** button or **Stop/Reset** button must be pressed 3 times within 10 seconds.

To Cook / Reheat / Defrost by **Micro Power and Time**

This feature allows you to set the desired power and time for cooking by yourself.

English

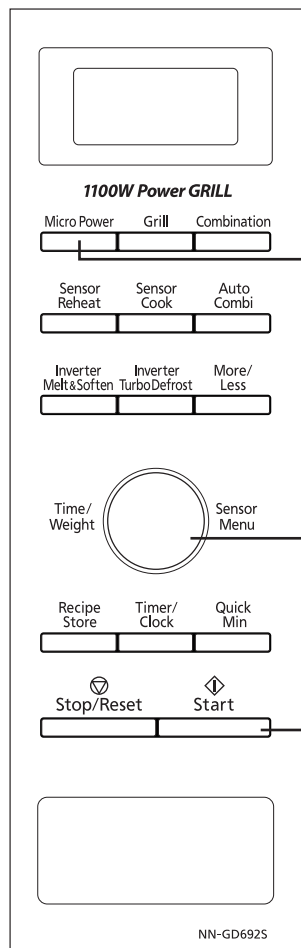

1. Put the food into the oven

2. Select Micro Power Level

Press **Micro Power** Button until the desired power level appears in the Display Window. (see chart below)

3. Set Cooking Time

(P10 Power: up to 30 minutes).
(Other Powers: up to 1 hour and 30 minutes.)

4. Press

Cooking will start.
The time in the Display Window will count down.

NOTES:

1. When selecting P10 Power on the first stage, you can skip step 2.
2. For more than one stage cooking, repeat steps 2 & 3 above then press **Start**. The maximum number of stages for cooking is 3. The oven will beep twice between stages. For the details, please refer to page 7.

Micro Power:

The **Micro Power** Button gives you a selection of different power levels representing decreasing amounts of microwave energy, used for cooking foods at different speeds.

e.g. The lower the micro power setting, the more evenly the food cooks, although it will take a little longer.

To select the correct power level for cooking different foods, refer to the chart below.

Press	Power Level	Example of Use
1x	P10 (1000 W)	Boil water. Cook vegetables, rice, pasta and noodles. Reheating.
2x	P9 (900 W)	Cook fresh fruits.
3x	P8 (800 W)	Cook cakes, desserts. Heat milk.
4x	P7 (700 W)	Whole chicken and chicken pieces.
5x	P6 (600 W)	Cook beef, lamb and eggs.
6x	P5 (500 W)	Cook meatloaves. Cook fish and seafood.
7x	P4 (400 W)	Cook christmas pudding, corned beef, dried beans and peas.
8x	P3 (300 W)	Melt butter and chocolate. Soften ice cream and cream cheese.
9x	P2 (250 W)	Thaw foods. Simmer soups, stews and casseroles (less tender cuts of meat).
10x	P1 (100 W)	Keep cooked foods warm, simmer slowly.

3-Stages Setting

This feature allows you to program 3 Stages of cooking continuously.

Example: Continually set [P8] 2 minutes, [Combination 1] 3 minutes and [Grill 2] 2 minutes.

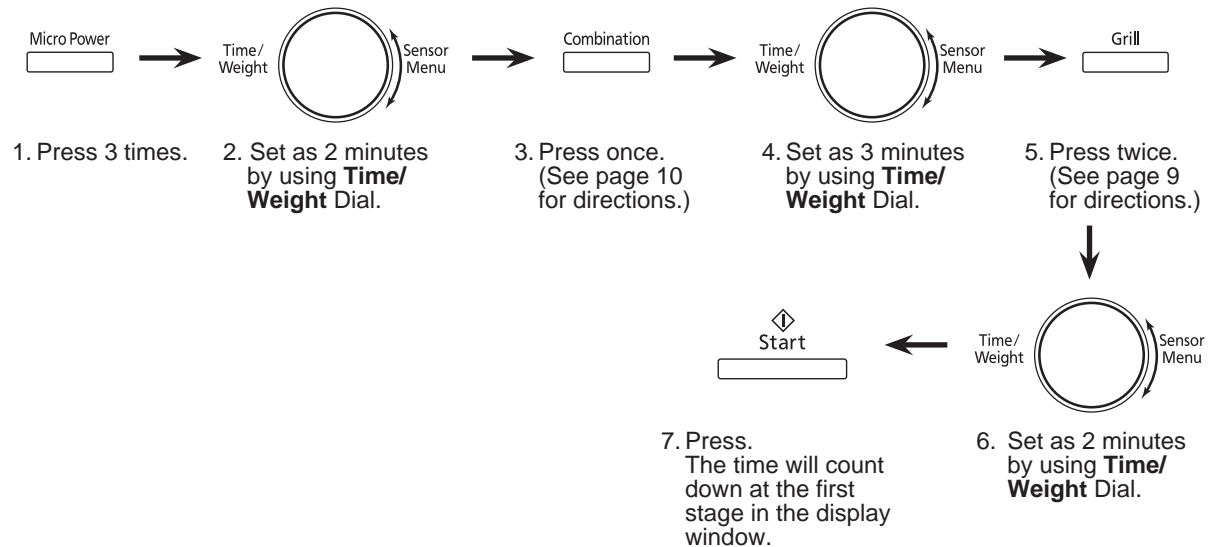

English

NOTES:

1. When operating, two beeps will sound between each stage.
2. This feature is not available for Turbo Defrost, Auto Combi, Sensor Cook and Reheat function.
3. When using Standing Time or Delay Time, it's up to 2 power stages.

To Cook Using the Recipe Store Button

This feature allows you to pre-program your oven for regular reheating or cooking tasks. You are able to pre-program your oven for a specific power level and time that is convenient for you.

To Set a Recipe Program:

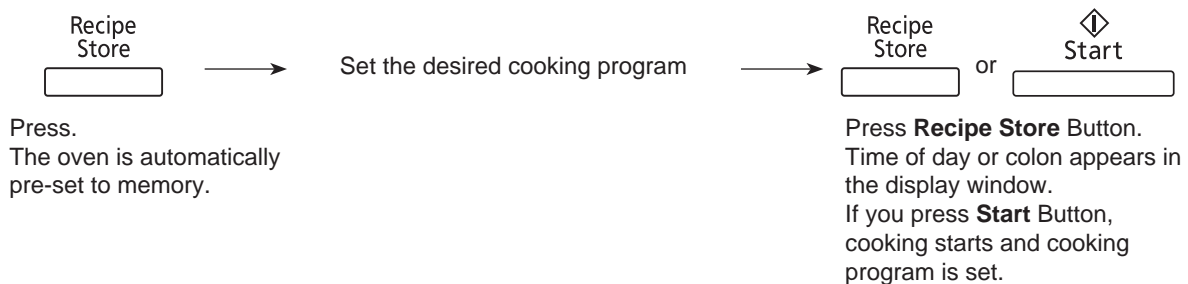

To Start Recipe Store Program:

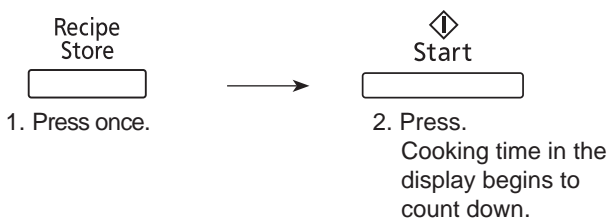

NOTES:

1. Auto Control Functions cannot be programmed into Recipe Store.
2. Recipe Store can only store 1 stage cooking. It is not possible to store 2 or 3 stage cooking.
3. A new recipe program will cancel the recipe program previously stored.
4. The recipe program will be cancelled if the oven is unplugged.

To Use Quick Min

This feature allows you to set cooking time in 1 minute increments up to 10 minutes.

English



Press **Quick Min** Button until the desired cooking time (up to 10 minutes) appears in the display window. Power Level is pre-set at P10.

Cooking begins and the time will count down. At the end of cooking, 5 beeps sound.

NOTES:

1. If desired, you can use other power levels. Select desired power level before setting cooking time.
2. After setting the time by **Quick Min** Button, you cannot use **Time/Weight** Dial.
3. Only **Time/Weight** Dial can be used to adjust time during manual cooking.

To Cook on Grill by Time Setting

There are three grill setting modes. (1 - High, 2 - Medium, 3 - Low)

Directions for Grill Cooking:

When grilling, heat is radiated from the two elements at the top of the oven. The oven door must be kept closed to prevent cooking odours from spreading in the kitchen and so as not to waste energy. The grill elements do not require preheating. The grill is particularly useful for thin slices of meat, steaks chops, kebabs, sausages or pieces of chicken. It is also suitable for hot sandwiches and all gratin dishes.

Place food to be grilled on Wire Rack in Glass Tray. Select Grill setting, set the time and start the oven. The food being grilled should normally be turned over after half the grilling time. When the oven door is opened, the program is interrupted. Turn the food over, place it back the oven, close the door and restart oven. While grilling, the oven door can be opened at any time to check the food.

English

1. Put the food into the oven

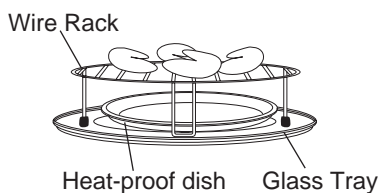

2. Select Grill Setting

Press	Power	Type of Food
once	Grill 1	Meat, Poultry pieces
twice	Grill 2	Seafood
3 times	Grill 3	Garlic Bread, Toast

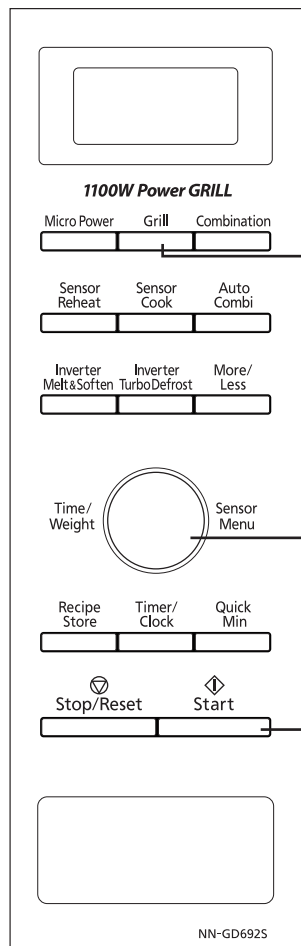

3. Set Cooking Time using the Time/Weight Dial

(up to 90 minutes)

4. Press

The time in the Display Window will count down.

To Cook on Combination by Time Setting

There are three combination setting modes. There is no need to set the temperature or the Micro Power Level.

Directions for Combination Cooking:

The combination means that it is possible to combine the microwave and grill function for thawing, cooking, and heating foods. There is a special program to keep the crispness of certain foods.

Wire Rack can be used for better browning result.

English

1. Put the food into the oven

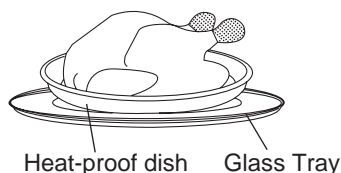

2. Select Combination Setting

Press	Power	Type of Food
once	Combination 1	Baked potatoes, Whole poultry
twice	Combination 2	Beef, Lamb
3 times	Combination 3	Sea food, Puddings

3. Set Cooking Time using the Time/Weight Dial

(up to 90 minutes)

4. Press

The time in the Display Window will count down.

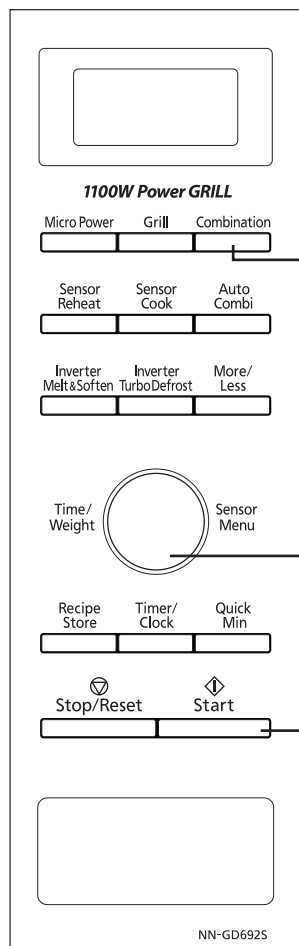

To Cook Food Using Auto Combi

The feature allows you to cook your favourite foods by select the category only. Select the category of food and weight and then just press **Start** Button. The oven determines the microwave and grill level and the cooking time automatically.

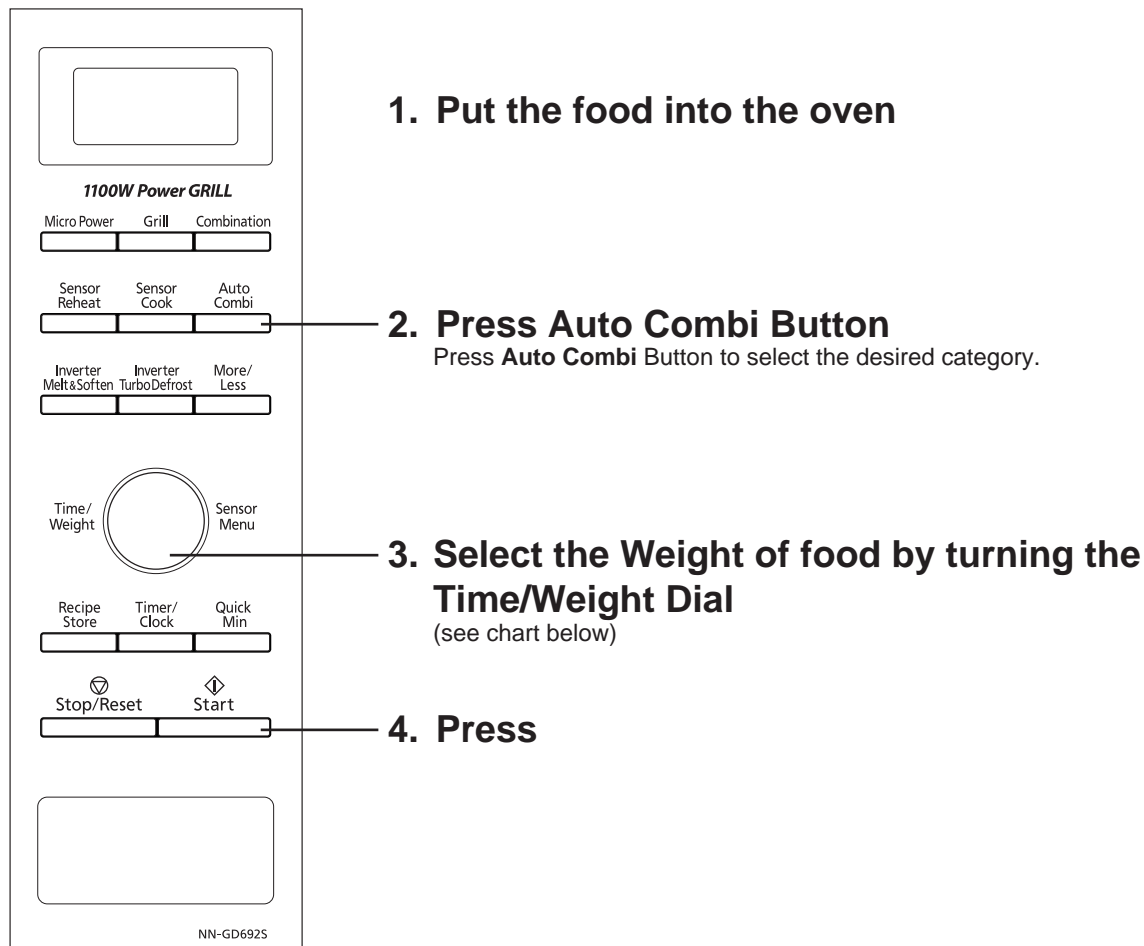

Press	Food Category	Weight			
once	11. Seekh Kebab	200 g	400 g	600 g	800 g
twice	12. Tikka Kebab	200 g	400 g	600 g	800 g
3 times	13. Roast Beef/Lamb	200 g	400 g	600 g	800 g
4 times	14. Roast Chicken	600 g	900 g	1200 g	1500 g
5 times	15. Frozen Pizza	200 g	300 g	400 g	500 g

NOTE:
When you select **Auto Combi** program, symbols will appear in the display to show the cooking mode that will be used and the accessories that are needed.

Auto Combi Menu

English

11. Seekh Kebab

Suitable for roasting seekh kebab. Cut the meat into minced and marinate them with sauce for about 2 hours. Place on long flat skewer and form into cigar shape around the skewer. Place on the Wire Rack with a shallow dish underneath to collect drips or use suitable grill accessory. During cooking the oven will beep to prompt you to turn the kebab, press **Start** to continue cooking once turned.

12. Tikka Kebab

Suitable for roasting different kinds of kebab. Cut the meat into thin pieces and marinate them with sauce for about 15-20 minutes, then string them together. Arrange the kebabs on the wire rack with dish underneath. During cooking the oven will beep to prompt you to turn the kebab, press **Start** to continue cooking once turned.

13. Roast Beef/Lamb

It is suitable for cooking beef and lamb. Meat may be cooked marinated with gravy or vegetables. Place prepared beef/lamb on a wire rack with dish underneath. Turn over after beep sounds.

14. Roast Chicken

It is suitable for roasting chicken. Clean the chicken and marinate it for about 1 hour with seasonings. Put the prepared chicken onto a microwave safe dish. Turn over when beep sounds.

15. Frozen Pizza

It is suitable for cook whole Pizza or piece of Pizza. Place frozen Pizza on a wire rack with dish underneath, Select weight and press **Start**.

To Defrost

Inverter Turbo Defrost

This feature allows you to defrost meat, poultry and seafood automatically by just setting the weight of the food. Weight must be programmed in kilograms.

English

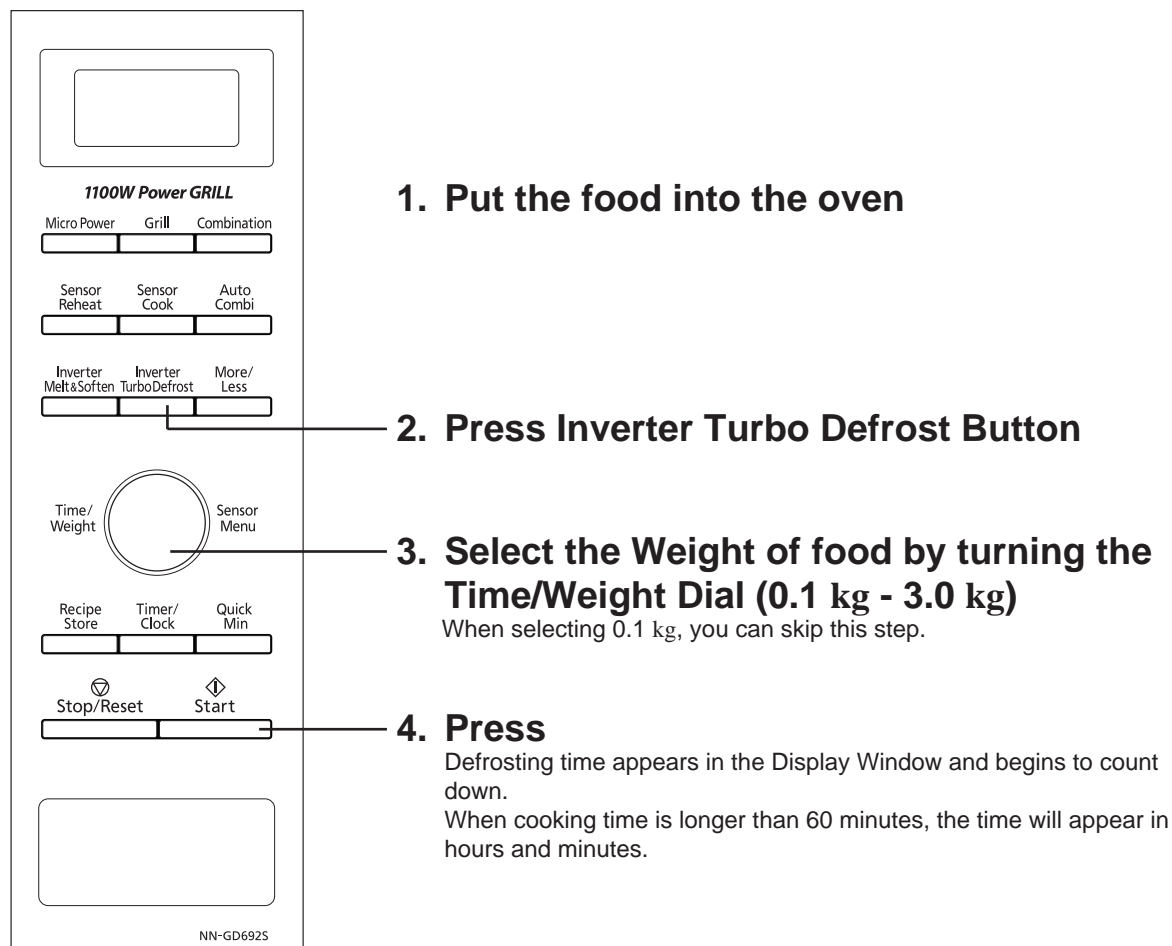

NOTES:

- Inverter Turbo Defrost can be used to defrost many cuts of meat, poultry and fish by weight. To use, simply program Inverter Turbo Defrost and the weight of the food in kg (1.0) and tenths of a kg (0.1). The oven will determine the defrosting time and power levels. Once the oven is programmed, the defrosting time will appear in the display. For best results the minimum recommended weight is 0.2 kg.
- BONE-IN ROASTS, such as a Beef Rib Roast have a smaller muscle than a boneless roast of the same weight. Therefore, for bone-in roasts weighing over 2 kg reduce weight by 0.5 kg. For bone-in roasts weighing less than 2 kg, reduce weight by 0.25 kg.
- Turn over or remove or shield food when beep in the middle of cooking.

Defrosting Guidelines/Turbo Defrost

English

This feature allows you to enter the weight in kilos and the oven will select the correct defrosting time for most foods. However, do not use for

porous foods e.g. bread and cakes etc.

During the defrosting process, the oven will beep to remind you to check the food i.e. turn, shield or break the food apart, as shown below.

Tips for Defrosting

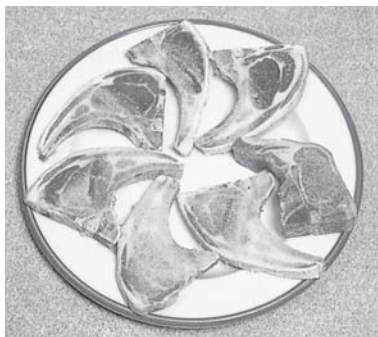

Separate chops and small items e.g. Quiche slice where possible.



Give large joints of meat further standing to ensure meat is not still icy in the center.



Break up small items e.g. scallops, minced meat, halfway through defrosting.



Remove wrappers from meat. Place on microwave rack or up-turned saucer.



Shield edges, back of fat of joints and thin edges of fish with small pieces of SMOOTH tin foil to prevent over-defrosting.

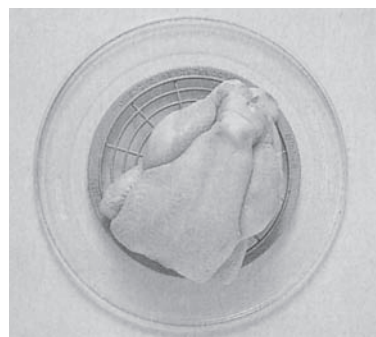

Turn dense foods and meat 2-3 times during defrosting.

To Melt and Soften Food Using Inverter Melt & Soften

This feature allows you to melt butter and chocolate, soften cream cheese and ice cream by just setting the weight of the food. Weight must be programmed in grams.

English

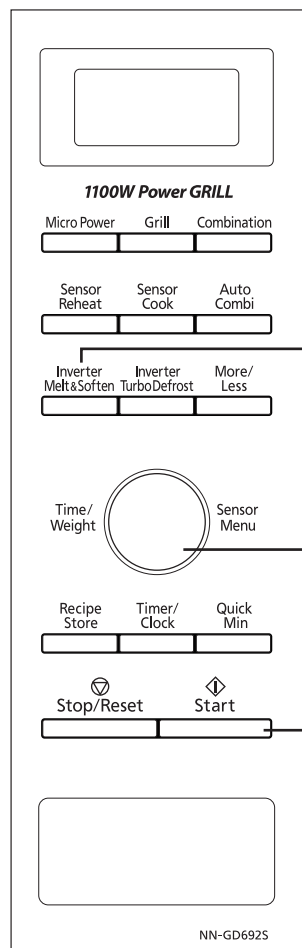

1. Put the food into the oven

2. Press Inverter Melt & Soften Button

Press once to melt butter.
 Press twice to soften cream cheeses
 Press three times to soften ice cream.
 Press four times to melt chocolate.

3. Select the Weight of food by turning the Time/Weight Dial (see chart below)

4. Press

Melting time appears in the Display Window and begins to count down.

Food Category	Weight					
	50 g	100 g	150 g	200 g	250 g	300 g
16. Melt Butter	50 g	100 g	150 g	200 g	250 g	300 g
17. Soften Cream Cheese	50 g	100 g	150 g	200 g	250 g	300 g
18. Soften Ice Cream	300 g	600 g	900 g	1200 g	-	-
19. Melt Chocolate	50 g	100 g	150 g	200 g	250 g	300 g

Inverter melt soften hints:

16. Melt Butter

Remove wrapper, cut butter into 3 cm cube, and place into a microwave safe dish. Melt with lid or plastic wrap. Stir after cooking.

17. Soften Cream Cheese

Remove wrapper and place in a microwave safe bowl/dish. Soften without cover.

18. Soften Ice Cream

Soften slightly without lid.

19. Melt Chocolate

Remove wrapper and place chocolate into a microwave safe dish. Cook without cover. After heating, stir until completely melted.

NOTE: Chocolate holds its shape even when softened.

NOTE:

If food needs more time cooking or weight exceeds range, cook using P3 power for melting and softening.

To Reheat Food Using **Sensor Reheat**

The feature allows you to reheat precooked room temperature or refrigerator temperature food without having to select cooking time and power. The oven does it automatically.

English

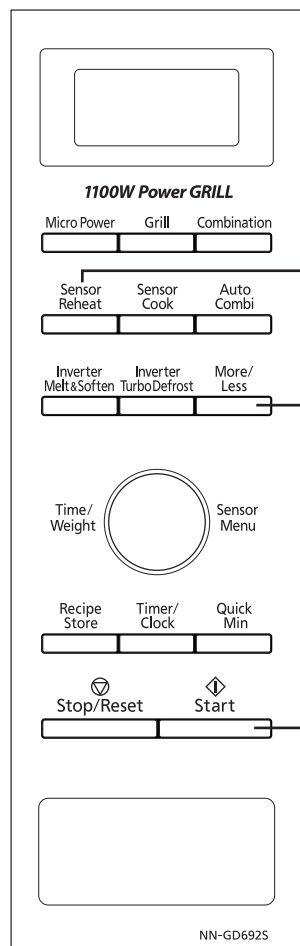

1. Put the food into the oven

2. Press Sensor Reheat Button

(If desired, press **More/Less** Button.)

More/Less Button:

Preferences for food doneness vary with each individual. After having using Sensor Reheat a few times, you may decide you would prefer your food cooked to a different doneness. By using the **More/Less** button, the programs can be adjusted to cook food for a larger or shorter time.

Press **More/Less** button before pressing **Start** button.

1 tap = More (Adds Approx. 10% time)

2 taps = Less (Subtracts Approx. 10% time)

3 taps = original setting

If you are satisfied with the result of the Sensor program, you don't have to use this button.

3. Press

After the heat and humidity is detected by the SENSOR the oven will beep twice, the remaining time appears in the Display Window and begins to count down.

For best results on Sensor Reheat, follow these recommendations:

1. The room temperature surrounding the oven should be below 35 °C.
2. Food being reheated should weigh between 125 g and 1.0 kg. Foods weighing less than 125 g and more than 1.0 kg, use a manual micro power setting.
3. All food must be previously cooked and at room or refrigerator temperature.
4. Food should always be covered loosely, but completely, with plastic wrap. (Do not use any snap closing lids.)
5. Be sure the glass tray, the outside of the cooking containers and the inside of the microwave are dry before placing food in the oven. Residual beads of moisture turning into steam can mislead the sensor.
6. DO NOT open the oven door until 2 beeps sound and cooking time appears on the display Window. Doing so will cause inaccurate cooking since the steam from food is no longer contained within the oven cavity. Once the cooking time begins to count down, the oven door may be opened to stir, turn, or rearrange foods.
7. DO NOT reheat bread or pastry products (raw or uncooked), or beverages.
8. DO NOT use if oven cavity is warm (from previously cooked foods).
9. All food should have a covered stand time of at least 3 to 5 minutes.
10. If the temperature of the cavity is too high, sensor reheat feature can not be used. Display window will appear "HOT". Sensor reheat feature can be used again until the "HOT" disappears.

To Cook Food Using **Sensor Cook**

The feature allows you to cook most of your favourite foods by select the category only. Select the category of food and then just press **Start** Button. The oven determines the microwave power level and the cooking time automatically.

1. Put the food into the oven

2. Press Sensor Cook Button

3. Select the desired Category

Select the desired category by turning the **Sensor Menu** Dial until the desired food category number appears in the Display Window. (If desired, press **More/Less** Button.)

4. Press

After the heat and humidity is detected by the **SENSOR** the oven will beep twice, the remaining time appears in the Display Window and begins to count down.

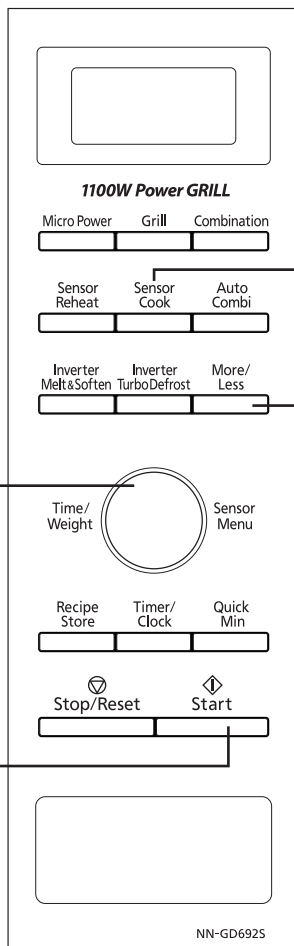

More/Less Button:

Preferences for food doneness vary with each individual. After having using Sensor Cook a few times, you may decide you would prefer your food cooked to a different doneness. By using the **More/Less** button, the programs can be adjusted to cook food for a larger or shorter time.

Press **More/Less** button before pressing **Start** button.

1 tap = More (Adds Approx. 10% time)

2 taps = Less (Subtracts Approx. 10% time)

3 taps = original setting

If you are satisfied with the result of the Sensor program, you don't have to use this button.

For best results on Sensor Cook, follow these recommendations:

1. The room temperature surrounding the oven should be below 35 °C.
2. Be sure the glass tray, the outside of the cooking containers and the inside of the microwave are dry before placing food in the oven. Residual beads of moisture turning into steam can mislead the sensor.
3. Food should always be covered loosely, but completely, with plastic wrap. (Do not use any snap closing lids.)
4. DO NOT open the oven door until 2 beeps sound and cooking time appears on the display Window. Doing so will cause inaccurate cooking since the steam from food is no longer contained within the oven cavity. Once the cooking time begins to count down, the oven door may be opened to stir, turn, or rearrange foods.
5. All food should have a covered stand time of at least 3 to 5 minutes.
6. DO NOT use if oven cavity is warm (from previously cooked foods).
7. If the temperature of the cavity is too high, sensor reheat feature can not be used. Display window will appear "H0 E". Sensor cook feature can be used again until the "H0 E" disappears.

Sensor Reheat/Cook Menu

Sensor Reheat

All foods must be pre-cooked. Casseroles, plated dinners, soups, stews, pasta dishes (except lasagne), canned foods. Foods should be reheated from refrigerator or room temperature, do not reheat frozen foods on this setting. Do not reheat in foil or plastic containers as unsuccessful reheating times will result. All foods should be covered securely with plastic wrap or a fitting lid. Stir after beep sounds. Where possible after heating, stir foods and stand covered for 3 to 5 minutes before serving.

1. Vegetables

Suitable for cooking all types of leaf, green and soft varieties, including broccoli, squash, cauliflower, cabbage, asparagus, beans, celery, zucchini, spinach, capsicum or a mixture of these. All vegetables should be trimmed or prepared and cut into even size pieces. Add 1 tablespoon to $\frac{1}{4}$ cup water if vegetables appear slightly dehydrated. Add water if you prefer a softer cooked texture. Place in a suitable size dish. Butter, herbs etc. may be added before heating, but do not add salt until serving. Cover with plastic wrap or a well fitting lid. Stir after beep sounds. At the completion of heating, stir larger quantities of vegetables. Let stand, covered, for 2 to 3 minutes.

2. Root Vegetables

Root vegetables should be trimmed or prepared and cut into evenly sliced pieces. Add 1 tablespoon to $\frac{1}{4}$ cup of water to vegetables, if dehydrated or softer texture is desired. Place in a appropriate size dish and cover with plastic wrap or well fitting lid. Stir after beep sounds. This will assist in even cooking.

3. Potatoes

Potatoes should be trimmed or prepared and cut into evenly sliced pieces. Add 1 tablespoon to $\frac{1}{4}$ cup of water to vegetables. If dehydrated or softer texture is desired. Place in a appropriate size dish and cover with plastic wrap or well fitting lid. Stir after beep sounds. This will assist in even cooking.

4. Rice

It is suitable for cooking white rice including short, long grain, jasmine and basmati. Place rice in a suitable size microwave safe casserole. Add water and allow at least $\frac{1}{2}$ depth of volume for evaporation to prevent boiling over. Cover with lid. Stir after beep sounds. Stand 5 minutes after cooking.

5. Pasta

Suitable for cooking dried pasta. Place pasta and water in a large sized dish to prevent from boiling over. Add 1 tablespoon of oil, if desired, before cooking to prevent the pasta from sticking together. Cover with plastic wrap or a fitting lid. Halfway through the cooking time, the oven will 'beep' to prompt you to stir and rearrange. Then cook pasta uncovered. Stand for 5 to 10 minutes at the completion of cooking time.

6. Steam Froz. Foods

It is suitable for steaming (reheating) 'dimsum' such as shumai, etc. Arrange frozen 'dim sum' on a microwave safe dish and sprinkle with some water. Steam 'dim sum' covered with a lid or microwave safe plastic wrap.

7. Fish

Suitable for cooking whole fish and fish fillets. Select fish suitable for microwave cooking and place in a single layer in a shallow dish, with skin-side down. Add butter, spices, herbs, or lemon juice to flavor. Overlap thin edges of fillets to prevent overcooking. If stuffing whole fish with seasoning, cooking time may need to be extended. Shield the eye and tail area of whole fish with small amounts of aluminum foil to prevent overcooking. Cover dish securely with plastic wrap or fitted lid. Stir after beep sounds. Allow large amounts of fish to stand for 3 to 5 minutes after cooking before serving. (thickness of fish should not be more than 3 cm)

8. Jam

It is suitable for cooking fruits jam, such as strawberry, apple, grape, kiwi berry, etc.

Fruit Jam (100 g- 500 g / weight of fruits)

- | | |
|--------|---|
| 200 g | fruit (such as strawberry, apple, grape, kiwi berry, etc) |
| 100 g | castor sugar |
| 1 tbsp | lemon juice |
| | a drop vegetable oil |

1. Peel and cut fruits into bite-size (1-2 cm) pieces and place in 2-litre casserole dish. Add castor sugar, lemon, juice and vegetable oil. Mix well.
2. Select "Jam" menu, then press **Start**. Stir after beep sounds.

NOTES:

1. You can not cook orange jam.
2. Preserve in the fridge.
3. You can adjust the level of the sugar content if you like.
4. Less sugar makes preservation term shorter.
5. Double ingredients for 2 cups fruits jam.

9. Pudding

Orange and Chocolate Drop Pudding

- | | |
|-------|-------------------------------|
| 1 | whole orange |
| 1 | orange, juice and grated rind |
| 170 g | self-raising flour, sifted |
| 100 g | butter |
| 100 g | caster sugar |
| 2 | eggs, beaten |
| 100 g | chocolate drops |

1. Cut one orange into slices and arrange around the sides of the 2 qt pudding bowl.
2. Cream together the butter and sugar until light and fluffy, Beat in the eggs gradually. Fold in the flour and mix to a soft consistency.
3. Add grated rind, orange juice, chocolate drops and stir. Spoon mixture into container.
4. Select "Pudding" menu, then press **Start**.

Pineapple Upside Down Pudding

- | | |
|--------|--|
| 1 tbsp | brown sugar |
| 1 | small can of pineapple slices, drained |
| 4 | grace cherries, halved |
| 80 g | butter |
| 80 g | self-raising flour |
| 80 g | caster sugar |
| 2 tbsp | milk |
| 2 | eggs, beaten |

1. Sprinkle brown sugar on the base of 20 cm round dish, arrange pineapple slices and cherry halved on top of sugar in the base.
2. Cream together the butter and sugar until light and fluffy. Beat in the eggs gradually. Fold in the flour and mix to a soft consistency with the milk.
3. Spoon mixture over the pineapple.
4. Select "Pudding" menu, then press **Start**.

Steamed Jam Pudding

- | | |
|---------|--------------------|
| 2 tbsp | jam |
| 100 g | butter |
| 2/3 cup | castor sugar |
| 2 | eggs |
| 3/4 cup | self raising flour |
| 1/4 cup | milk |

1. Spoon jam into bottom of 2-litre Pyrex dish.
2. Cream butter and sugar in separate bowl until light and fluffy,
3. Add eggs (one at a time), beating well after each addition. Fold in flour alternately with milk. Mix until well combined.
4. Pour mixture over jam. Smooth top.
5. Select "Pudding" menu, then press **Start**.

Chocolate Sauce Pudding

- | | |
|---------|--------------------|
| 1 cup | self raising flour |
| 1 tbsp | cocoa powder |
| 1/3 cup | castor sugar |
| 1/2 cup | milk |
| 1 tsp | vanilla essence |
| 100 g | chocolate |
| 30 g | butter |
| 3/4 cup | brown sugar |
| 2 tbsp | cocoa, extra |
| 1/2 cup | water |

1. Sift flour and cocoa into 2-litre bowl.
2. Add sugar, milk and vanilla essence. Mix well.
3. Place chocolate and butter in 2-cup pyrex jug and cook on P8 for 1 to 2 minutes. Stir and add to mix-ture. Mix well.
4. Spread mixture into base of 2-litre casserole dish.
5. Combine brown sugar, cocoa and water in 2-cup jug.
6. Select "Pudding" menu, then press **Start**.

10. Jelly

Basic Jelly

- | | |
|---------|-----------|
| 10 g | agar-agar |
| 150 g | sugar |
| 1000 ml | water |
- coloring, some fruits, if desired

1. Soak agar-agar strips in water with a drop-lid; let it stand for 2 hours.
2. Tear softened agar-agar strips into pieces, wring out moisture, and place in 3-litre casserole with the measured water.
3. Add sugar and mix well.
4. Cook with plastic wrap. Select "Jelly" menu, then press **Start**. When oven beeps, stir and removecover.
5. After cooking, stir and sieve through strainer.
6. Add coloring if desired.
7. Pour into a wet containers (and add some fruit if desired), add cool until fully chickened. Cut jelly into some pieces.

NOTES:

1. If you want to use powder agar, you can change from 10 g of agar-agar strips to 30 g of powder agar.
2. Half ingredients of half portion.

To Use Timer Button

English

To Use as a Kitchen Timer

Press once.

Set desired amount of time
by turning Time/Weight Dial.
(up to 1 hour and 30 minutes)

Press Start.
Time will count down
without oven operating.

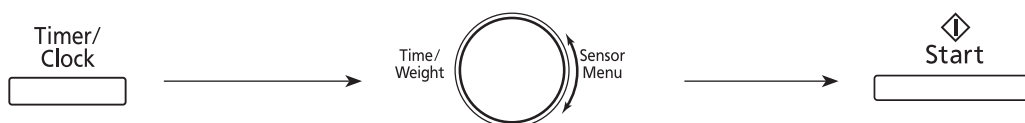

To Set Standing Time

Press once. Set desired amount of standing time
by turning Time/Weight Dial.
(up to 1 hour and 30 minutes)

Press Start.
Cooking will start.
After cooking, standing
time will count down
without oven operating.

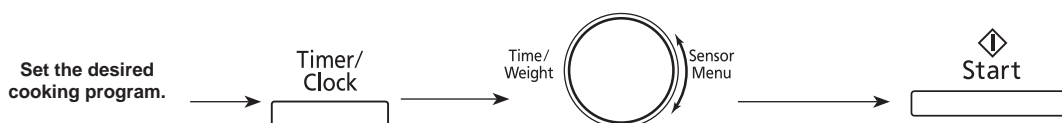

To Set Delay Start

Press once.

Set desired amount of delay time
by turning Time/Weight Dial.
(up to 1 hour and 30 minutes)

Press Start.
Delayed time will count
down. Then cooking will start.



NOTES:

1. If oven door is opened during the Standing Time, Delay Start or Kitchen Timer, the time in the Display Window will continue to count down.
2. Delay Start/Standing Time cannot be programmed before/after any Auto Control function. This is to prevent the standing temperature of the food from rising before defrosting or cooking begins. A change in the starting temperature could cause inaccurate results and / or food may deteriorate.

Before Requesting Service

ALL THESE THINGS ARE NORMAL:

The oven causes interference with my TV.	Some radio and TV interference might occur when you cook with the microwave oven. This interference is similar to the interference caused by small appliances such as mixers, vacuums, hair dryers, etc. It does not indicate a problem with your oven.
Steam accumulates on the oven door and warm air comes from the oven vents.	During cooking, steam and warm air are given off from the food. Most of the steam and warm air are removed from the oven by the air which circulates in the oven cavity. However, some steam will condense on cooler surfaces such as the oven door. This is normal.
I accidentally operate my microwave oven without any food in it.	Operating the oven empty for a short time will not damage the oven. However, we do not recommend this to be done.
There are humming and clicking noises from my oven when I cook by Combination.	These noise occur as the oven automatically switches from microwave power to Grill, to create the Combination setting. This is normal.
The oven has an odor and generates smoke when using Combination and Grill function.	It is essential that your oven is wiped out regularly particularly after cooking by Combination or Grill. Any fat and grease that builds up on the roof and walls of the oven will begin to smoke if not cleaned.

PROBLEM	POSSIBLE CAUSE	REMEDY
Oven will not turn on.	The oven is not plugged in securely.	Remove plug from outlet, wait 10 seconds and re-insert.
	Circuit breaker or fuse is tripped or blown.	Contact the specified service center.
	There is a problem with the outlet.	Plug another appliance into the outlet to check if the outlet is working.
Oven will not start cooking.	The door is not closed completely.	Close the oven door securely.
	Start Button was not pressed after programming.	Press Start Button.
	Another program has already been entered into the oven.	Press Stop/Reset Button to cancel the previous program and program again.
	The program has not been entered correctly.	Program again according to the Operating Instructions.
	Stop/Reset Button has been pressed accidentally.	Program oven again.
"H0E" appears in the display window.	The cavity is overheated.	Operate again after it cools down.
The "🔒" appears in the Display Window.	The Child Safety Lock was activated by pressing Start Button 3 times.	Deactivate Lock by pressing Stop/Reset Button 3 times.
The oven stops cooking by microwave and "H00", "H97" or "H98" appears in the Display Window.	This display indicates a problem with the microwave generation system.	Please contact the specified service center.

If it seems there is a problem with the oven, contact an authorized Service Centre.

Care of your Microwave Oven

1. Turn the oven off and remove the power plug from the wall socket before cleaning.
2. Keep the inside of the oven clean. When food splatters or spilled liquids adhere to oven walls, wipe with a damp cloth. Mild detergent may be used if the oven gets very dirty. The use of harsh detergent or abrasives is not recommended.
3. The outside oven surfaces should be cleaned with a damp cloth. To prevent damage to the operating parts inside the oven, water should not be allowed to seep into the ventilation openings.
4. Do not allow the Control Panel to become wet. Clean with a soft, damp cloth. Do not use detergents, abrasives or spray-on cleaners on the Control Panel. When cleaning the Control Panel, leave oven door open to prevent oven from accidentally turning on. After cleaning press **Stop/Reset** Button to clear display window.
5. If steam accumulates inside or around the outside of the oven door, wipe with a soft cloth. This may occur when the microwave oven is operated under high humidity conditions and in no way indicates malfunction of the unit.
6. It is occasionally necessary to remove the glass tray for cleaning. Wash the tray in warm sudsy water or in a dishwasher.
7. The roller ring and oven cavity floor should be cleaned regularly to avoid excessive noise. Simply wipe the bottom surface of the oven with mild detergent, water or window cleaner and dry. The roller ring may be washed in mild sudsy water or dish washer. Cooking vapors collect during repeated use but in no way affect the bottom surface or roller ring wheels. When removing the roller ring from cavity floor for cleaning, be sure to replace in the proper position.
8. When using the GRILL or cooking in the COMBINATION mode, some foods may inevitably splatter grease on to the oven walls. If the oven is not cleaned, occasionally it may start to "smoke" during use. These marks will be more difficult to clean later.
9. After GRILL or COMBINATION cooking the ceiling and walls of the oven should be cleaned with a soft cloth squeezed in soapy water. Particular care should be taken to keep the window area clean particularly after cooking by GRILL or COMBINATION. Stubborn spots inside the oven can be removed by using a small amount of microwave oven cleaner sprayed onto a soft damp cloth. Wipe onto problem spots, leave for recommended time and then wipe off. Avoid cleaning oven door and the microwave feed guide area situated on the right hand side of the cavity wall.
DO NOT SPRAY DIRECTLY INSIDE THE OVEN.
A steam cleaner is not to be used for cleaning.
10. When it becomes necessary to replace the oven light, please consult a dealer to have it replaced.
11. Failure to maintain the oven in a clean condition could lead to deterioration of the surface that could adversely affect the life of the appliance and possibly result in a hazardous situation.

Technical Specifications

Power Source:	220 V 50 Hz	220 V 50-60 Hz	230 V - 240 V 50 Hz
Power Consumption: Microwave	4.8 A 1050 W		4.5 A 1050 W
Grill	5.3 A 1160 W		4.9 A 1160 W
Combination	8.8 A 1920 W		8.2 A 1950 W
Output: Microwave*	1000 W		
Grill	1100 W		
Outside Dimensions (W x H x D):	525 mm x 310 mm x 414 mm		
Oven Cavity Dimensions (W x H x D):	359 mm x 247 mm x 362 mm		
Glass Tray Diameter:	Ø 340 mm		
Operating Frequency:	2450 MHz		
Net Weight:	Approx. 13.2 kg		

* IEC Test Procedure

Specifications subject to change without notice.

As for the voltage requirement, the production month, country and serial number, please refer to the identification plate on the microwave oven.



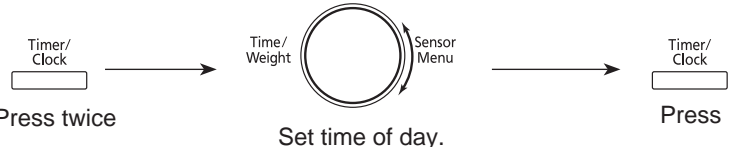
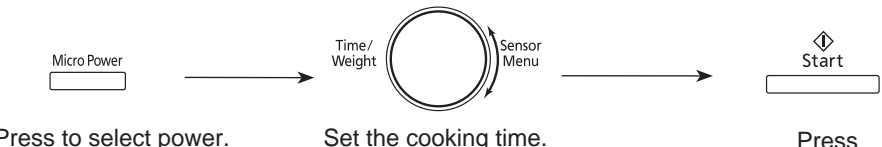
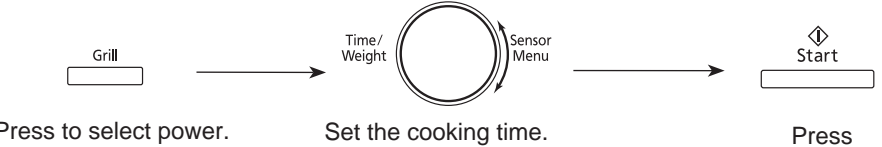
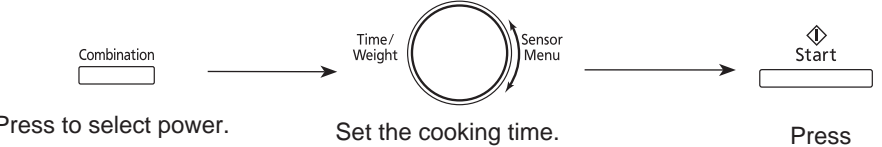



Quick Guide to Operation

Feature	How to Operate
To Set Clock (page 5)	 <p>Press twice Timer/Clock → Time/Weight Sensor Menu → Timer/Clock Press</p> <p>Set time of day.</p>
To Set / Cancel Child Safety Lock (page 5)	<p>To Set: Start → Display → Start Press 3 times.</p> <p>To Cancel: Stop/Reset → Display → Stop/Reset Press 3 times.</p> <p>Display: 12:35 or :</p>
To Cook / Reheat / Defrost by Micro Power and Time Setting (page 6)	 <p>Press to select power. Micro Power → Time/Weight Sensor Menu → Start Press</p> <p>Set the cooking time.</p>
To Cook using the Recipe Store Button (page 7)	<p>To Set: Recipe Store → Set the desired cooking program. → Recipe Store or Start Press</p> <p>To Start: Recipe Store → Start Press</p>
To Use Quick Min Button (page 8)	<p>Quick Min → Start Press</p>
To Cook using the Grill Button (page 9)	 <p>Press to select power. Grill → Time/Weight Sensor Menu → Start Press</p> <p>Set the cooking time.</p>
To Cook using the Combination Button (page 10)	 <p>Press to select power. Combination → Time/Weight Sensor Menu → Start Press</p> <p>Set the cooking time.</p>

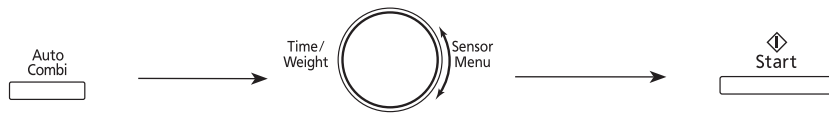
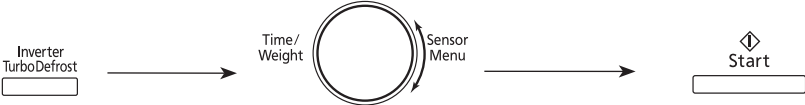
Quick Guide to Operation

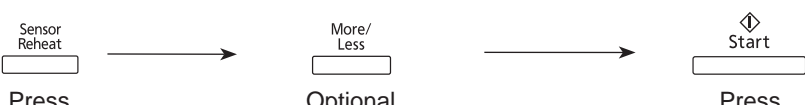
(continued)

English

Feature	How to Operate
To Cook using the Auto Combi Button (page 11)	 <p>Press to select the desired category.</p> <p>Set the weight</p> <p>Press</p>
To Use Inverter Turbo Defrost Button (page 13)	 <p>Press</p> <p>Set the weight.</p> <p>Press</p>
To Use Inverter Melt & Soften Button (page 15)	 <p>Press to select the desired category.</p> <p>Set the weight.</p> <p>Press</p>
To Reheat using "Sensor Reheat" Button (page 16)	 <p>Press</p> <p>Optional</p> <p>Press</p>
To Cook using "Sensor Cook" Button (page 17)	 <p>Press</p> <p>Set the desired category.</p> <p>Optional</p> <p>Press</p>
To Use as a Kitchen Timer (page 20)	 <p>Press</p> <p>Set the kitchen time.</p> <p>Press</p>
To Set Standing Time (page 20)	 <p>Set the desired cooking program.</p> <p>Press</p> <p>Set the standing time.</p> <p>Press</p>
To Set Delay Start (page 20)	 <p>Press</p> <p>Set the delay time.</p> <p>Set the desired cooking program.</p> <p>Press</p>

Free Manuals Download Website

<http://myh66.com>

<http://usermanuals.us>

<http://www.somanuals.com>

<http://www.4manuals.cc>

<http://www.manual-lib.com>

<http://www.404manual.com>

<http://www.luxmanual.com>

<http://aubethermostatmanual.com>

Golf course search by state

<http://golfingnear.com>

Email search by domain

<http://emailbydomain.com>

Auto manuals search

<http://auto.somanuals.com>

TV manuals search

<http://tv.somanuals.com>