

Operating Instructions

Instrucciones de Uso
Mode d'emploi

Household Massage Lounger Sillón de Masaje Doméstico Fauteuil vibromasseur

Model No./Nº de Modelo/Nº de modèle **EP-MA73**

English EN3

Español SP3

Français FR3

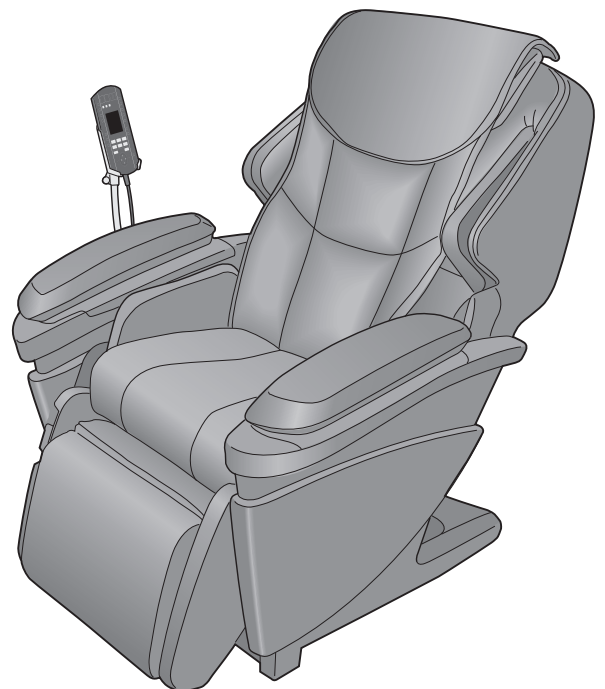

Before operating this unit, please read these instructions completely.

Antes de utilizar esta unidad, lea completamente estas instrucciones y guárdelas para referencia futura.

Avant d'utiliser cet appareil, nous vous recommandons de lire l'ensemble de ces instructions et de les ranger dans un endroit accessible pour une consultation ultérieure.



Contents

Before Use

- **IMPORTANT SAFETY INSTRUCTIONS** EN4
- **SAFETY PRECAUTIONS** EN5-6
- **OPERATING PRECAUTIONS** EN6
- **GROUNDING INSTRUCTIONS** EN6
- **Specifications** EN8-9
- **Part names and functions** EN10-13
- **Setting up the massage lounger** EN14-15
- **Assembly** EN16-19
- **Before sitting down** EN20-23

How to Use

- **Simple use** EN24-25
- **When you want a complete massage** EN26-29
 - Starting automatic course
 - Adjusting the intensity of neck, shoulder, back and lower back massages
 - Turning air massage or stretch On/Off
- **To register your preferences** EN30-31
 - Registering favorite settings
 - Starting with registered settings
- **About the “Heat” massage heads/“Foot Heat”** EN32-33
- **When you want a concentrated massage of a particular body part with your favorite action, such as “Kneading on the neck” or “Tapping on the shoulder”** . . . EN34-37
 - Starting manual operation
 - Adjusting the intensity and position
- **To perform air massage for shoulder / hand/arm / lower back / leg/foot, or stretch for neck / chest / hip / leg** EN38-42
 - Starting air massage/stretch
 - Adjusting the intensity
 - Smart uses of the “leg/foot” air massage/stretch
- **When you want to adjust the reclining angle and/or leg rest** . . . EN43
- **After completing the massage** EN44-45

Maintenance

- **Cleaning and maintenance** EN46-47
- **Moving the unit** EN48-49

Q&A/Important Notes

- **About the automatic course/action/voice guidance function** . . . EN50-51
- **Q&A** EN52-56
- **Troubleshooting** EN57-59
 - Sounds and sensations of the unit EN58
 - Error display EN59

IMPORTANT SAFETY INSTRUCTIONS

Basic precautions should always be followed when using an electrical unit, including the following.

Please ensure that you read all instructions before using the Household Massage Lounger.

⚠ DANGER – To reduce the risk of electric shock:

1. Always unplug this unit from the electrical outlet immediately after using and before cleaning.

⚠ WARNING – To reduce the risk of burns, fire, electric shock, or injury to persons:

1. Fully insert the power plug to reduce the risk of short-circuit and fire.
2. The unit should never be left unattended when plugged in. Always unplug the unit when not in use.
3. The unit is not to be used by people who cannot move or communicate on their own.
4. Only use the unit for the purpose described in these instructions.
5. Do not stand on the unit.
6. Do not use any accessories other than those recommended by the manufacturer.
7. Always return the seat to the upright position and make sure the leg rest is completely retracted. Be careful that nothing is obstructing the leg rest while retracting. Keep children away from the leg rest.
8. Never operate the unit if it has a damaged power cord or plug. Return the unit to the nearest authorized service center if it is not working properly, if it has been dropped or damaged, or if it has been immersed in water.
9. Keep power cords away from heated surfaces. Do not carry the unit by the power cord.
10. Never block the air openings during operation and make sure that all air openings are kept free of lint and hair, etc. Do not drop or insert anything into any of the openings of the unit.
11. Do not use the unit on top of heating appliances, such as electric carpets, etc. Do not operate the unit under blanket or pillow. Excessive heating can occur and cause fire, electric shock, or injury to persons.
12. Do not use the unit in bathrooms or other damp or humid places as this may cause electric shock or cause the unit to malfunction. Do not spill water, etc. onto the controller.
13. Do not use the unit outdoors.
14. Do not use or operate where aerosol spray products are being used or where oxygen is being administered.
15. When unplugging the unit, turn off all controls before removing the plug from power outlet. Do not use the unit with a transformer as this may lead to malfunction or electric shock.
16. Connect this unit to a properly grounded outlet only. See Grounding instructions.
17. Use heated surfaces carefully. May cause serious burns. Do not use over insensitive skin areas or in the presence of poor circulation. The unattended use of heat by children or incapacitated persons may be dangerous.
18. Always raise the comfort cushion to check that the fabric covering the movement area of the massage heads in the backrest has not been ripped before using the unit. Please also check other areas to ensure that the fabric has not been ripped. No matter how small the rip, if you find one then immediately stop using the unit, unplug the power cord and have the unit repaired at an authorized service center.
19. Do not push hands, elbows, arms, feet or legs into the fabric covering the movement area of the massage heads in the backrest while using the unit.
20. Do not use the unit in close proximity to loose clothing or jewelry.
21. Keep long hair away from the unit while in use.
22. Always use sockets and wiring devices at the correct rated value. Use at the specified power supply 120 V, AC. Failure to do so may result in electric shock or fire due to overheating.
23. When "Heat" massage heads are used, do not let the massage heads touch the same place for a long time. Do not use the "Foot Heat" massage for a long time. Low-temperature burn may occur
24. Do not damage the "Heat" (heater) section. (See page EN11.) Do not stick pins or needles into the unit. Do not damage with a sharp object. Doing so may damage the internal heater, causing fire or electric shock.
25. Sit on the unit after confirming there is no foreign matter between the parts of the unit. (Confirm that there are no foreign objects stuck in the comfort cushion, leg rest or hand & arm massage section.) Sit down and ensure that the leg rest is properly locked in place. Failure to observe this precaution may result in accident or injury.
26. Periodically remove dust, etc. from the power plug. Failure to do so may result in insulation failure due to humidity, etc., which may cause fire. (Remove dust using a dry cloth.)
27. Do not insert or unplug the power plug with wet hands. Doing so may cause electric shock.
28. Do not massage any one point for more than 5 minutes at a time. Excessive massaging can overstimulate the muscles and nerves and result in an adverse effect.
29. After each massage, slide the power switch, which is located on the right side of the chair, to the "off" position and turn its lock switch to the "lock" position and remove the key and power plug.
30. Do not attempt to open or disassemble any part of the unit. Only use an authorized Panasonic servicer to fix your unit.
31. If the massager functions abnormally, immediately turn off the power and have the massager checked by an authorized service center.

SAVE THESE INSTRUCTIONS

SAFETY PRECAUTIONS

CAUTION: To avoid the risk of injury:

1. Persons with any of the conditions listed below or who are undergoing medical treatment or suffer from medical conditions should consult with their physicians before using the unit:
 - a) Pregnant women, people who are ill, in poor physical shape.
 - b) People suffering from back, neck, shoulder, or hip pain.
 - c) People who have a pacemaker, defibrillator, or other personal medical devices prone to electronic interference.
 - d) People suffering from heart disease.
 - e) People who are prohibited from receiving massage by a physician due to thrombosis or aneurism, acute varicose veins, or other circulatory disorders.
 - f) People with irregular curvatures of the spine.
 - g) People who have a loss of heat sensation.
2. This unit should not be used by children. Remove the key when not in use and store out of reach of children.
3. Do not insert your hands, fingers, feet or head into the spaces following spaces:
 - (1) Between the backrest and seat or armrest
 - (2) Between the leg rest and seat or armrest
 - (3) Between the seat and armrest
 - (4) Between the back cover and leg cover
 - (5) Back of the leg rest
4. Do not use the unit against bare skin. While thin clothing may increase effectiveness, exposing the skin directly to the massager may irritate the skin.
Do not use the unit while wearing anything hard on your head like a hair accessory, etc. Do not use the unit for massaging the head, abdomen, front neck, elbows or knees.
Do not use excessively strong massage action on the back of the neck.
5. When using the body scanning function, always ensure that the shoulder position is correct. If the shoulder position is not correct, use the POSITION button to adjust it properly. Or stop the massage function and re-try the body scanning function. You can adjust the shoulder position in this way in the automatic course and manual operation. Failure to align the shoulder position correctly can lead to injury.
6. Do not stretch the back muscles for more than approximately 16 minutes at a time. To avoid overstretching the muscles which may result in discomfort, do not use the unit for more than 5 minutes when first using it. You can gradually increase the duration and strength of the massage as you become used to it.
To prevent excessive massaging, do not use the massager for more than a total of 16 minutes each session. After approximately 16 minutes, the massage heads will be retracted and stop moving.
The comfort cushion can be removed if you want to experience a stronger back massage. Exercise extreme care when you use this mode in order to avoid back pain or injury. Use only for short periods of time (no more than 16 minutes). Reinstall the comfort cushion if you want to restore to normal massage intensity.
7. While using the massager, if you start feeling sick or if the massage seems painful, stop using it immediately. While using the massager, if the pressure seems too strong, the movement of the massage heads can be stopped at any time by pressing the Quick stop button.
8. Do not go to sleep while using the unit. Do not use the unit after drinking alcohol.
9. When the seat back is in a reclined position, do not sit on it or sit with your legs resting on the headrest. Do not sit on the leg rest as the unit may fall over.
10. Do not allow children or pets to play on or around the unit, especially during operation.
11. Do not unplug the unit or turn it off during operation. Unplug the unit immediately if there is a power outage.
12. Be sure to start on the gentle massage program if using the massager for the first time. The shiatsu massage is stronger and should be enjoyed after one has gotten accustomed to the chair.
13. Do not allow children to play on this mechanized furniture or operate the mechanism. Leg rest folds down on closing so that a child could possibly be injured. Always leave in an upright and closed position. Keep hands and feet clear of mechanism. Only the occupant should operate it.
14. Remove hard objects, such as false fingernails, wristwatches or rings, when massaging hands or arms. Empty pockets of hard objects when massaging the area of the seat or thighs.
15. People with any of the conditions listed below should not use the Hip stretch:
 - 1) People suffering from acute lumbago, spinal disc herniation, or misalignment of the vertebrae
 - 2) People with hip joint problems such as hip osteoarthritis
 - 3) People with osteoporosis
 - 4) People who felt numbness or listlessness in the legsIt may worsen the symptoms.
16. Always return the leg rest to its original position before moving the unit.
Failure to observe this precaution may result in injury due to the leg rest returning to its original position when the unit is being moved.
17. Store the attachment screws out of reach of children.
Accidental ingestion may occur.
18. Do not stand, jump on, or place objects on the seat until the air is completely extracted for the air massage.
19. Do not hold the sole massage section when moving the unit.
Doing so may result in the section sliding as you move the unit, causing injuries.
20. Do not drag or push the unit in an installed state.
Protect your floor (place a mat or similar) when moving the unit on its castors to avoid damage to your floor.

SAFETY PRECAUTIONS

21. If you have not used the unit for a while, carefully read this operating instructions again and check that the unit is operating normally before use.
Failure to do so may result in accident or injury.
22. Do not use at the same time as another medical device. Doing so may cause an accident or deteriorated health.
23. Do not allow children to use the controller holder fixing screw.
Failure to do so may result in an accident or the child accidentally swallowing the key or screw.

OPERATING PRECAUTIONS

⚠ CAUTION: To avoid damaging the chair, follow these precautions:

1. The chair is designed for a maximum user weight of 120 kg (264 lbs). Exceeding the maximum weight may cause permanent damage to the massage mechanism and/or other components of the unit. Any such damage is deemed to be user abuse and is not covered under the Limited Warranty.
2. Do not sit on or drop the controller. Do not pull the controller cord or the power cord. Be careful not to catch the cord of the controller between the armrest and the chair back.
3. Do not treat the chair roughly, such as turning the chair on its side, turning the chair over or standing on it.
4. Do not treat the covering roughly.
 - Keep sharp or pointed objects away from the covering of the chair. Be careful not to drop lit ashes, lit cigarettes or matches on the chair.
 - Exposure to direct sunlight can cause fading or a change in color of the covering.
5. Do not repeatedly operate any switch at short intervals. Such action may cause the switch to malfunction.
6. Some noise may be heard coming from the massager while in use. This is due to the structure of the massager and is normal.
7. Make sure there are no obstacles behind the chair before reclining it. The chair can be reclined to a maximum angle of 170°. If the back hits a wall or pillar, the chair may malfunction. Be sure to have ample space behind the chair. Recline the chair slowly in order to avoid contact with an obstacle.
8. When excessive pressure is applied to the massage heads, they may stop moving for safety. When moving the heads up from the lowered position, one's body weight may stop the heads' movement. In such a case, slightly raise your body and allow the massage heads to move up.
9. Do not sit on the chair with wet body or hair.
10. The unit must not be used in "wet rooms" (sauna, swimming pool) or outdoors.
11. Always hold the power plug, not the power cord, when unplugging it from a socket.
Failure to observe this precaution may result in electric shock or short-circuit.

GROUNDING INSTRUCTIONS

This product must be grounded. If it should malfunction or break down, grounding provides a path of least resistance for electric current to reduce the risk of electric shock. This product is equipped with a cord having an equipment-grounding conductor and a grounding plug. The plug must be plugged into an appropriate outlet that is properly installed and grounded in accordance with all local codes and ordinances.

⚠ DANGER

Improper connection of the equipment-grounding conductor can result in a risk of electric shock. Check with a qualified electrician or serviceman if you are in doubt as to whether the product is properly grounded. Do not modify the plug provided with the product – if it will not fit the outlet, have a proper outlet installed by a qualified electrician.

This product is for use on a nominal 120-volt circuit and has a grounding plug that looks like the plug illustrated in Figure A. Make sure that the product is connected to an outlet having the same configuration as the plug. No adapter should be used with this product.

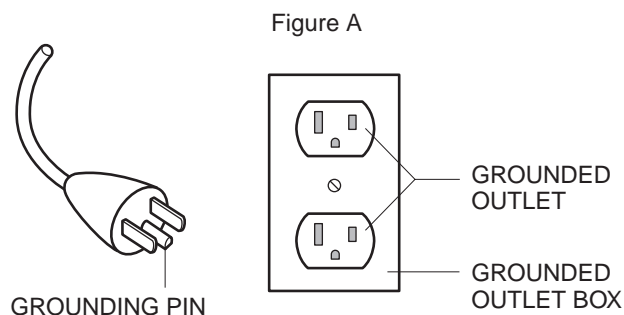

Use your chair in a wide variety of situations, with or without the massage function

To use the massage function



Main functions

- Automatic course ▶ Page EN26
- "Heat" massage heads ▶ Page EN32
- "Foot Heat" ▶ Page EN32
- Manual operation ▶ Page EN34
- Air action ▶ Page EN38
- Stretch action ▶ Page EN38

● Raise the comfort cushion for use.

When not using the massage function



● You can use this unit as a normal reclining chair.

Intended use, effects and benefits of the massage chair

● Massage, massage substitute

- Helps recovery from fatigue
- Promotes blood circulation
- Relieves muscle tiredness
- Relaxes stiff muscles
- Relieves nerve and muscle pain

● See page EN52 for details on how to massage legs or upper body only.

Specifications

| | | |
|--------------------------------------|--------------------------------------|---|
| Power supply | | AC 120 V 60 Hz |
| Rated Current | | 3.2 A |
| Upper body massage | Massage area (Up-Down) | Approx. 78 cm (30.7 in.) (The massage heads move a total of approx. 62 cm (24.4 in.)) |
| | Massage area (Left-Right) | Distance between massage heads during operation (including width of massage heads) Neck, shoulder, back, lower back: Approx. 5 cm - 21 cm (2.0 in.- 8.3 in.) Distance between massage heads (including width of massage heads) during back roll and up-and-down movement: Approx. 5 cm - 17 cm (2.0 in.- 6.7 in.) |
| | Massage area (Forward-Back) | Projected amount of massage head (Intensity adjustable) Approx. 10 cm (3.9 in.) |
| | Massage speed | Knead: From approx. 4 times/min – approx. 73 times/min Tap: From approx. 190 times/min – approx. 520 times/min (one side) Moving speed: From approx. 1 cm/s – approx. 5 cm/s |
| Air massage | Air pressure (Calf) | 3: Approx. 32 kPa 2: Approx. 29 kPa 1: Approx. 17 kPa (It may vary with the area slightly.) |
| Reclining angle | | Backrest ... Approx. 120° – 170° Leg rest (Leg & sole massage section) ... Approx. 5° – 85° Leg rest (Flat section) ... Approx. 15° – 95° |
| Automatic shut-off | | Around 16 minutes (automatically ends) |
| Dimensions | When not reclined (H × W × D) | Approx. 115 cm × 90 cm × 122 cm (45.3 in. × 35.4 in. × 48 in.) |
| | When reclined (H × W × D) | 66 cm × 90 cm × 202 cm (26 in. × 35.4 in. × 79.5 in.) |
| Weight of unit | | Approx. 85 kg (187.2 lbs) |
| Dimensions of box (H × W × D) | | Approx. 75 cm × 74 cm × 160 cm (29.5 in. × 29.1 in. × 63 in.) |
| Weight in box | | Approx. 100 kg (220.3 lbs) |
| Maximum user weight | | Approx. 120 kg (264.3 lbs) |

For those who weigh 100 kg (220.3 lbs) or more, the product operations may make more noise and the fabric cover may wear faster.

Unit dimensions

Front

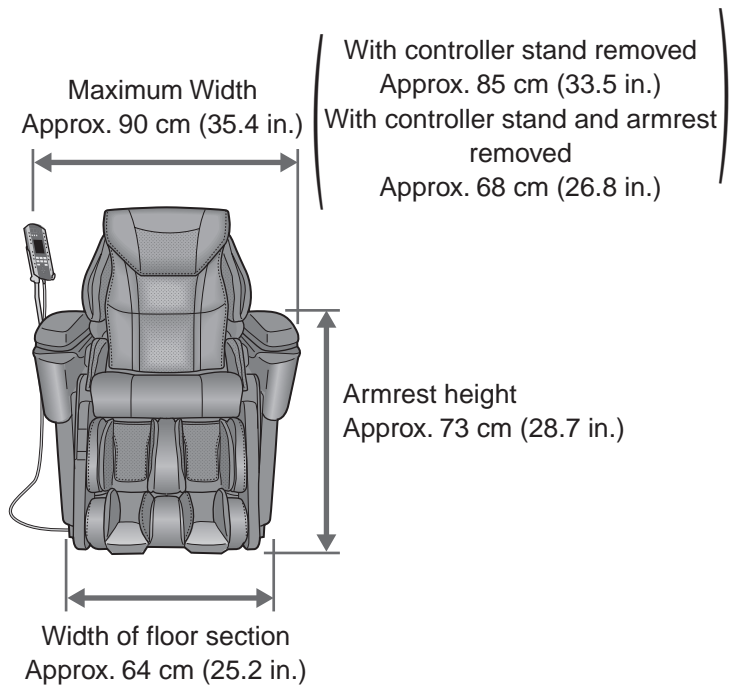

Side

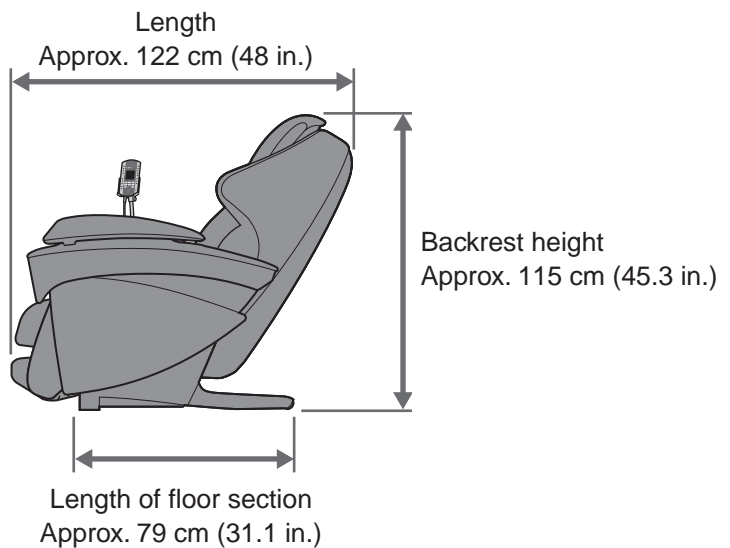

Amount of slide of sole massage section
Approx. 18 cm (7.1 in.)

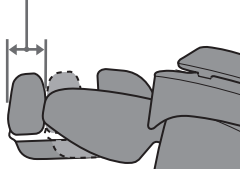

Amount of recline of leg section
Approx. 11 cm (4.3 in.)

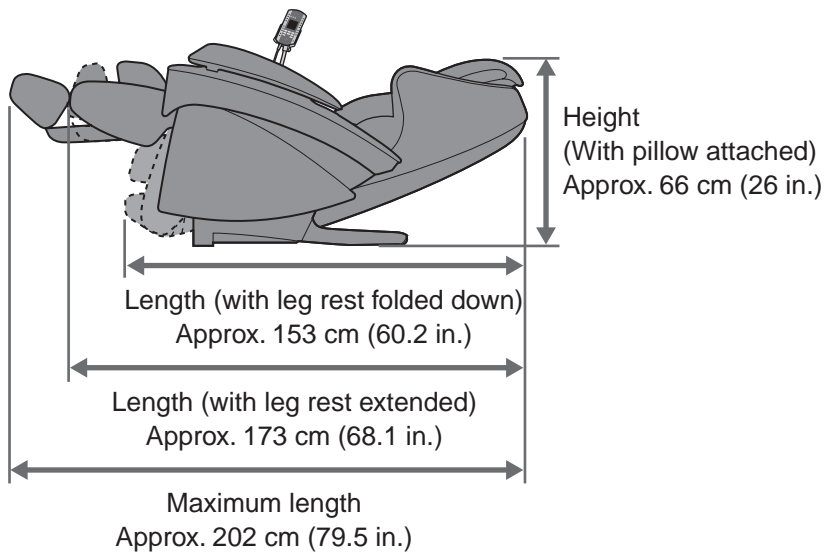
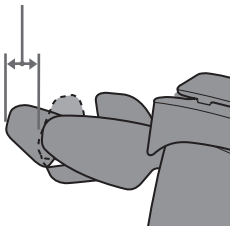

Part names and functions

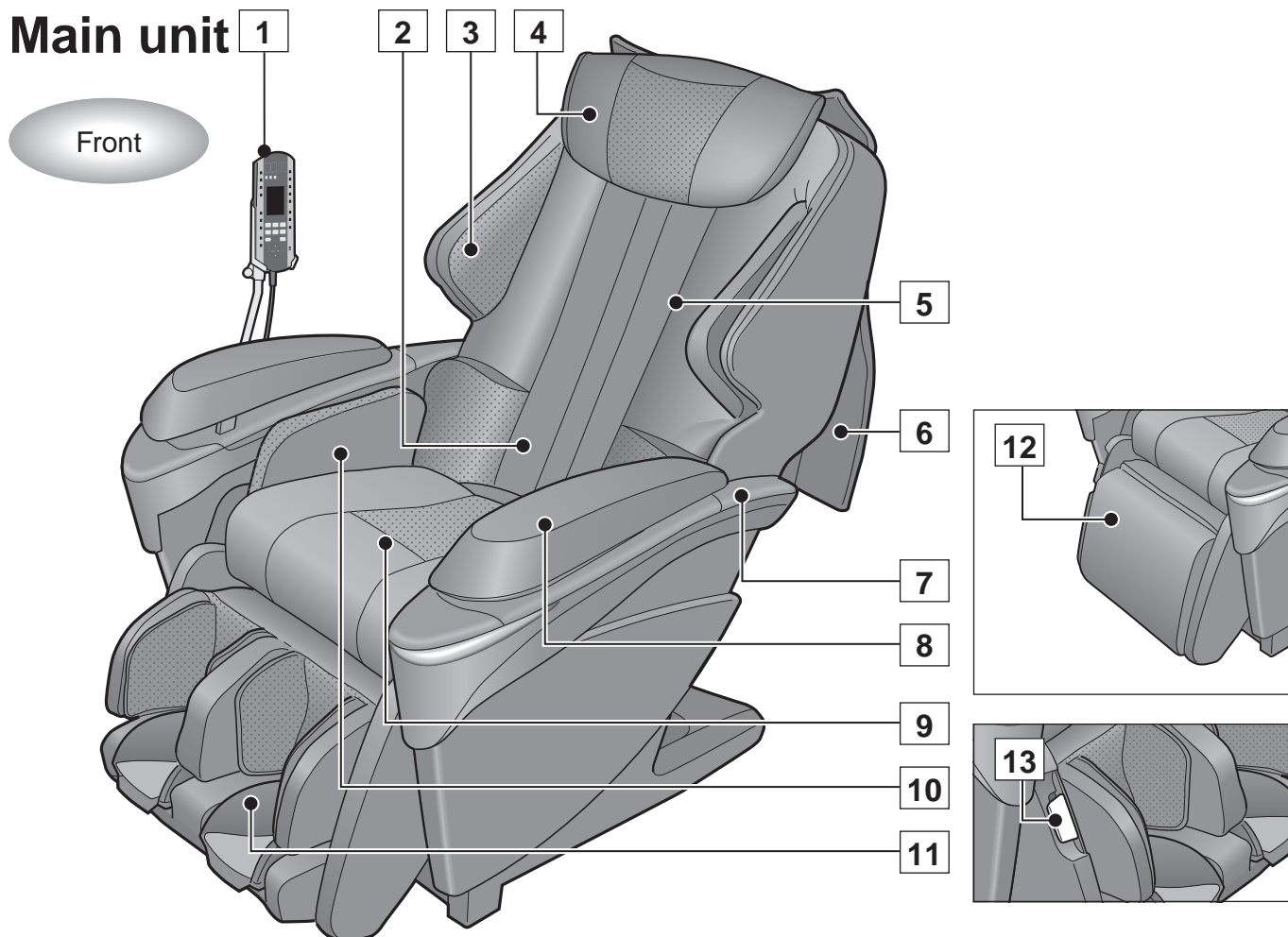

- | | |
|---|--|
| <p>1 Controller ▶ See pages EN12-13</p> <hr/> <p>2 Retracted position of massage heads</p> <hr/> <p>3 Shoulder side massage section ● Includes integrated air massage function.</p> <hr/> <p>4 Pillow</p> <hr/> <p>5 Backrest ● Massage heads: → Includes the massage mechanism. → Includes "Heat" massage heads. ● Air bag for lower back massage is built in.</p> <hr/> <p>6 Comfort cushion</p> <hr/> <p>7 Armrest ● Moves with the backrest.</p> <hr/> <p>8 Hand & arm massage section ● Includes integrated air massage function.</p> | <p>9 Seat ● Air bag for seat/thigh massage is built in.</p> <hr/> <p>10 Seat & thigh side massage section ● Includes integrated air massage function.</p> <hr/> <p>11 Leg rest-Leg & sole massage section ● Includes air massage function. ● Position can be adjusted by sliding sole massage section. ● Includes built-in "Heat" (heater) section.</p> <hr/> <p>12 Leg rest-Flat section ● Use the unit as a comfort chair by rotating and storing when not using for massaging.</p> <hr/> <p>13 Leg rest rotation lock release lever ● Rotate the leg rest manually while pulling the lever. (Flat section ⇔ Leg & sole massage section)</p> |
|---|--|

Back

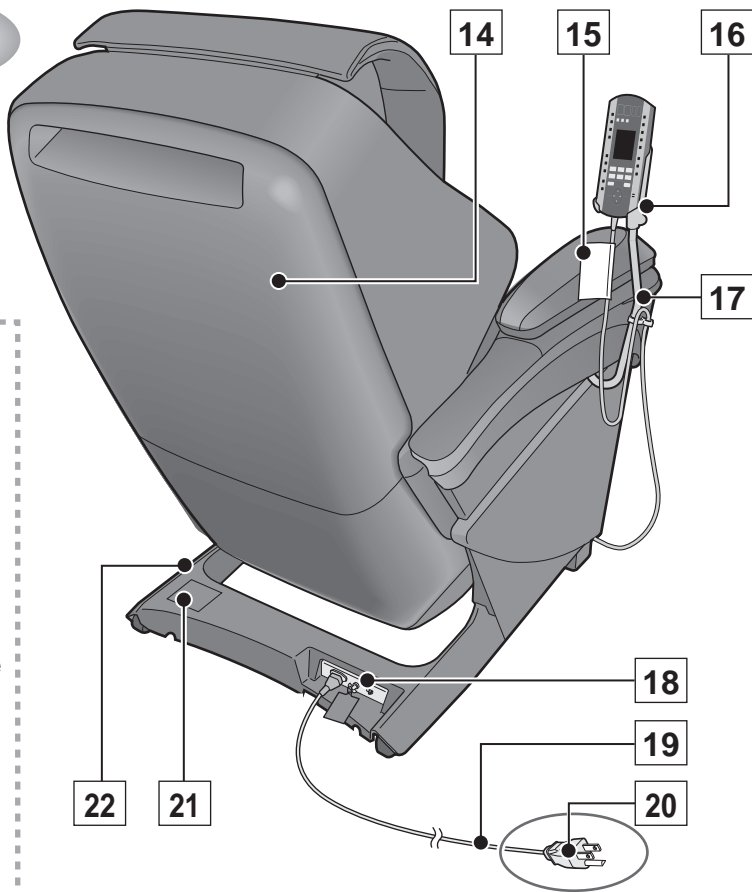

Leg rest-Leg & sole massage section

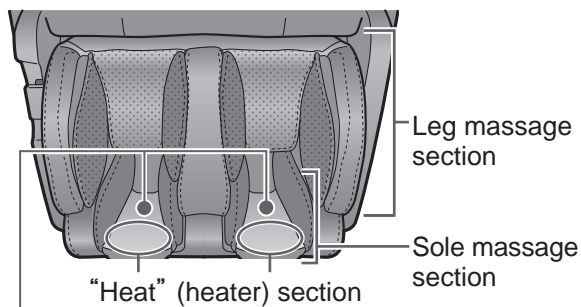

● Sole covers
(can be removed for washing ▶ See page EN47.)

Can be stored when not using for massage

Leg rest is rotated manually while pulling on the leg rest rotation lock release lever.

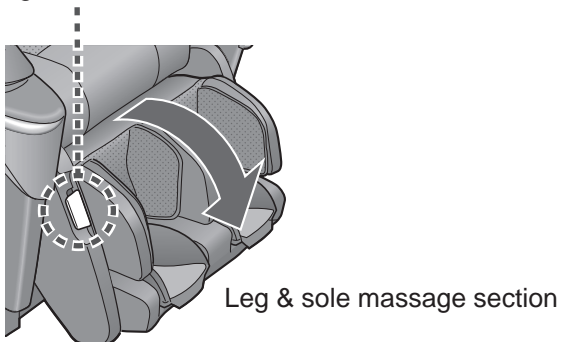

Leg & sole massage section

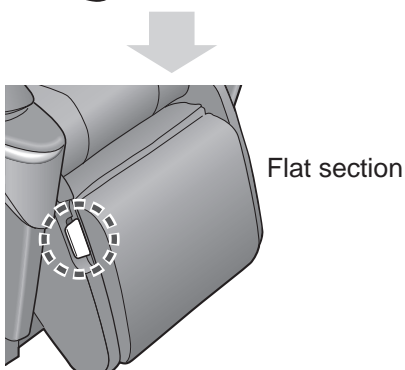

Flat section

- | | |
|-----------------------------|--------------------------|
| 14 Back cover | 19 Power cord |
| 15 Caution sticker | 20 Power plug |
| 16 Controller holder | 21 Rating sticker |
| 17 Controller stand | 22 Leg cover |

18 Power switch section

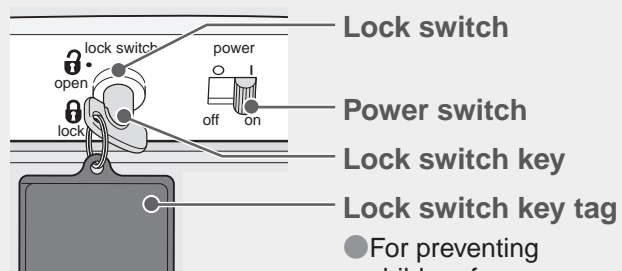

Lock switch

Power switch

Lock switch key

Lock switch key tag

● For preventing children from swallowing it by accident.

● Lock switch is set to "open" and power switch is set to "on" prior to leaving the factory.

Part names and functions (Continued)

Controller

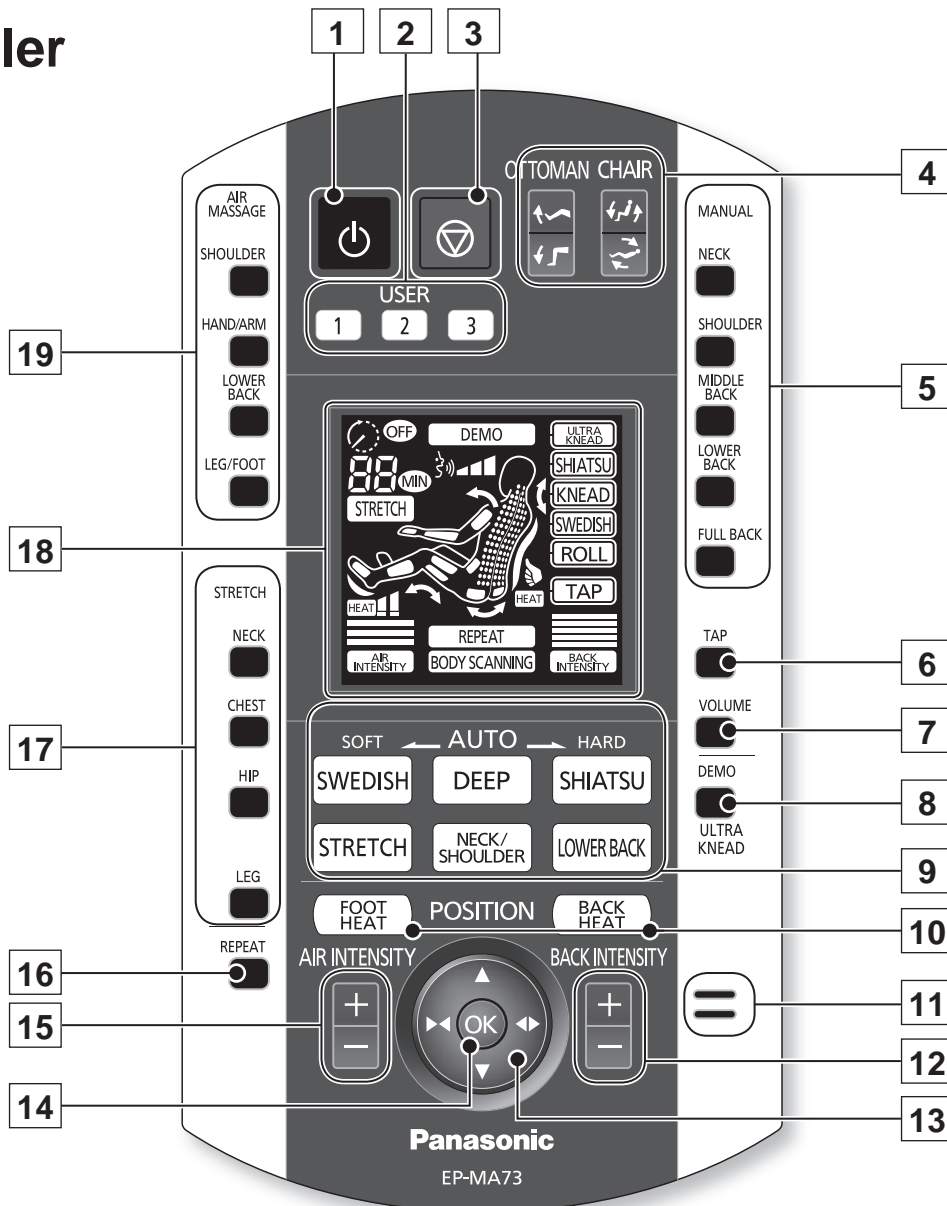

● This illustration is when all lamps are illuminated.

- | | |
|--|---|
| <p>1 On/Off button</p> <p>2 USER buttons ▶ See pages EN30-31</p> <p>3 Quick stop button ● Press this button to stop the massage immediately.</p> <p>4 OTTOMAN/CHAIR controllers ▶ See page EN43</p> <p>5 MANUAL selection button ▶ See page EN34</p> <p>6 TAP button ▶ See page EN37</p> <p>7 Voice guidance volume controller ▶ See page EN51</p> <p>8 DEMO button ▶ See page EN26</p> <p>9 AUTO selection buttons ▶ See page EN26</p> <p>10 BACK HEAT ("Heat" massage heads) ▶ See page EN32 On/Off button "Foot Heat" On/Off button ▶ See page EN32</p> | <p>11 Speaker</p> <p>12 Back massage intensity controller ▶ See page EN25</p> <p>13 POSITION button ▶ See page EN27</p> <p>14 OK button</p> <p>15 Air massage intensity controller ▶ See page EN25</p> <p>16 REPEAT button ▶ See page EN28</p> <p>17 STRETCH selection On/Off buttons ▶ See page EN38 ● "Neck", "chest", "hip", "leg" stretch.</p> <p>18 Display ▶ See page EN13</p> <p>19 AIR MASSAGE selection On/Off buttons ▶ See page EN38 ● "Shoulder", "arm", "lower back", "leg/foot" air.</p> |
|--|---|

Display

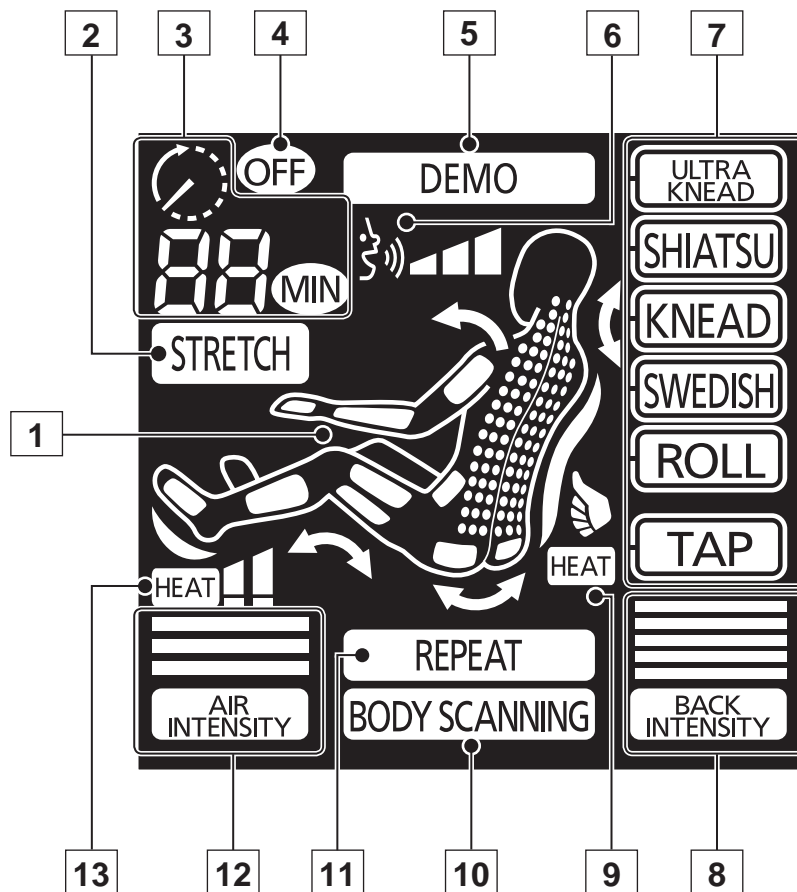

● This illustration is when all lamps are illuminated.

1 Massage area display

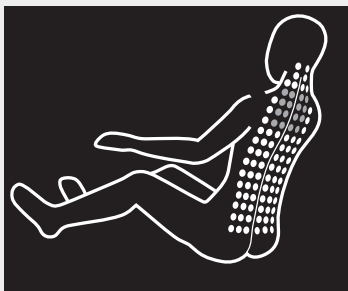

Current approximate massage position flashes.



Currently selected air massage parts light up.
Current air massage position flashes.



Currently selected stretch parts light up.
Current stretch position flashes.

2 Stretch action display ▶ See page EN38

3 Remaining time display

4 Massage ending display

5 Demo course (ULTRA KNEAD) display

6 Voice guidance volume display ▶ See page EN51

7 Operation display

- Currently performing massage actions light up while massaging.
- Currently selected action's frame is flashed when manual operation is selected.

8 Back intensity display ▶ See page EN29

9 "Heat" massage heads display ▶ See page EN29

10 Body scanning display ▶ See page EN26

11 Repeat display ▶ See page EN28

12 Air intensity display ▶ See page EN28

13 "Foot Heat" display ▶ See page EN29

Setting up the massage lounger

1 Where to use the unit

- Ensure there is adequate space to recline.

Keep at least 10 cm (3.9 in.) away from the wall.

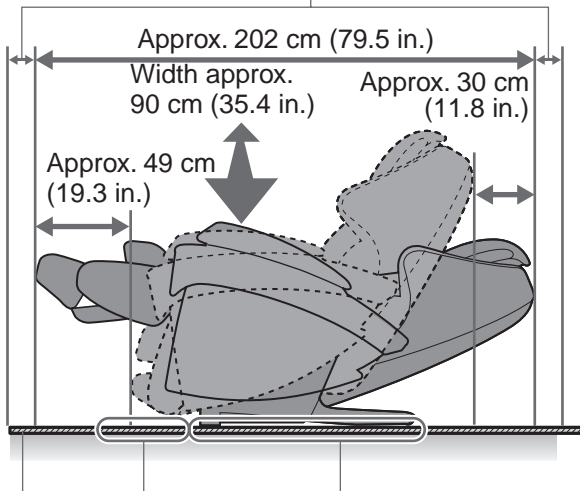

- For details on the dimensions of the unit, see page EN9.

Mat Area where leg rest could touch the floor Area where unit touches the floor

- Do not expose the massage lounger to direct sunlight or high temperatures, such as in front of heating sources, because this can cause discoloration or hardening of the synthetic leather.
- Place the unit on a mat to prevent floor damage. When placing a mat under the unit, the size of the mat should be sufficient (at least 120 cm × 70 cm (47.2 in. × 27.6 in.)) to cover the areas where the unit touches and where the leg rest could touch the floor, as shown in the diagram on the above.
- Install the unit near a power outlet.

2 Confirm that the main unit and the accessories are in the box.

Main unit

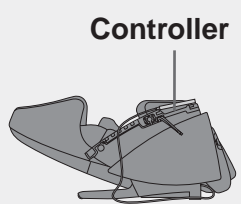

Controller

Accessories

- Armrests (Right/Left)
- Pillow
- Allen key — 1
- Attachment screws (M6 × 13) — Black (4 pcs.)
- Attachment screws (M6 × 20) — Silver (2 pcs.)
- Comfort cushion
- Controller stand
- Lock switch key
- Power cord
- Controller holder
- Controller holder fixing screw
- Clip

Right/Left indication (Back of the armrest)

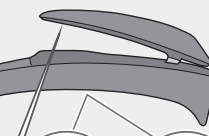

The holes in the fabric at the back of the hand & arm massage section are due to the manufacturing process and are not a fault.

(Cross-section)

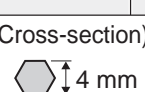

4 mm

This is initially inserted in the lock switch of the power switch section prior to leaving the factory.

3 Removing everything from the box and installing the unit

Hold onto the sides.

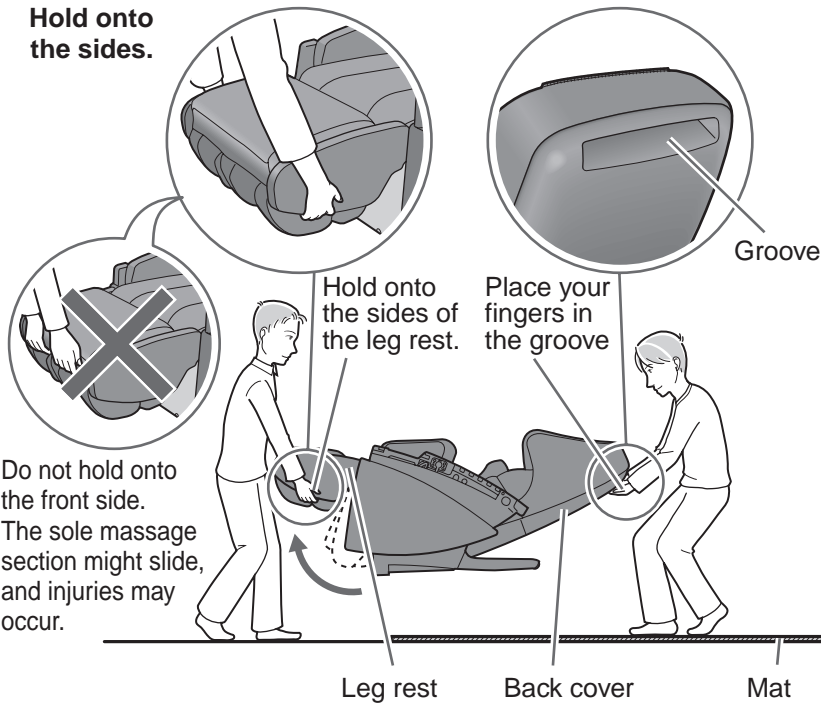

- Since the unit is very heavy, be careful to avoid back injuries. (The unit must be carried by two or more persons.)

| | |
|-------------|---------------------------|
| Unit weight | Approx. 85 kg (187.2 lbs) |
|-------------|---------------------------|

To put the unit down on the floor

- Put the unit down slowly watching your step carefully.
- Put down the leg rest by holding it with your hands until it has been set on the floor completely. If you release your hands before the leg rest is fully extended, the leg rest will forcefully return to the initial position.
- The floor may get damaged, so it is recommended to place a mat etc. on the floor.

Assembly

1 Attaching the controller stand to the right or left side panel of this unit

Fasten the controller stand with the attachment screws. (4 positions)

Use this screw ... Attachment screws (M6 × 13)

 × 4 pcs. (Black)

How to tighten the screws

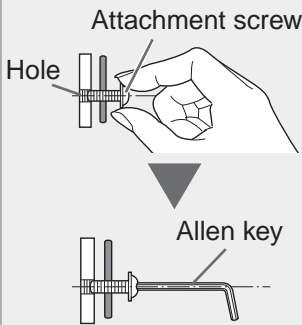

- Tighten the 4 screws lightly using your fingers. (Make the screws level with the holes.)

- Tighten firmly with the allen key.
- Screw may be damaged if you tighten the screw inserted into the hole crookedly using an allen key.

<When attaching on the right side panel>

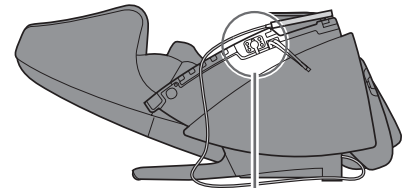

- Align the 2 prongs of the side panel with the holes of the controller stand.

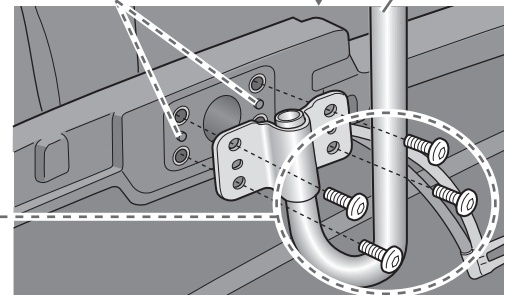

2 Fasten the armrest with the attachment screws. (On both the right and left sides)

1 Insert the armrest into the unit.

- "R" (right side) and "L" (left side) are indicated at the bottom of the armrest.
- Insert the armrest from the top aligning the ▲ marks on the side of the armrest.
- Be careful to avoid pinching your fingers and air plugs.

2 Slide the armrest toward the back while pushing it downward.

3 Fasten the armrest with the attachment screws. (One position for each side)

Use this screw ... Attachment screws (M6 × 20)

 × 2 pcs. (Silver)

How to tighten the screws

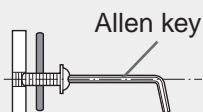

- Put an attachment screw on the edge of the allen key and tighten the screw horizontally to the hole.
- Screw may be damaged if you tighten the screw inserted into the hole crookedly using an allen key.

<When attaching the right armrest>

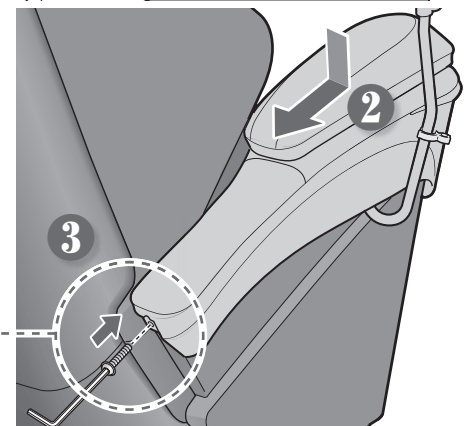
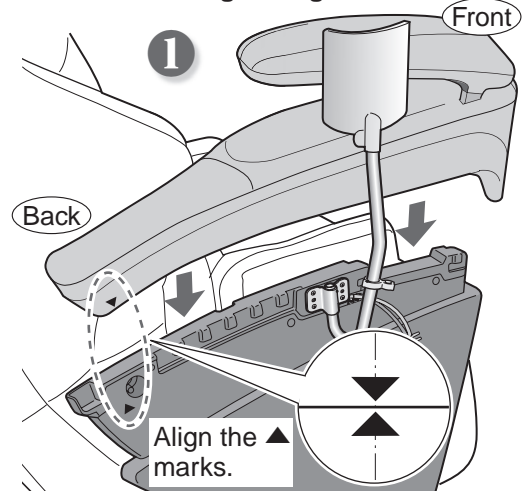

3 Connect the air plugs

- ① Press air plugs into the air plug sockets below the armrest until you hear a click.

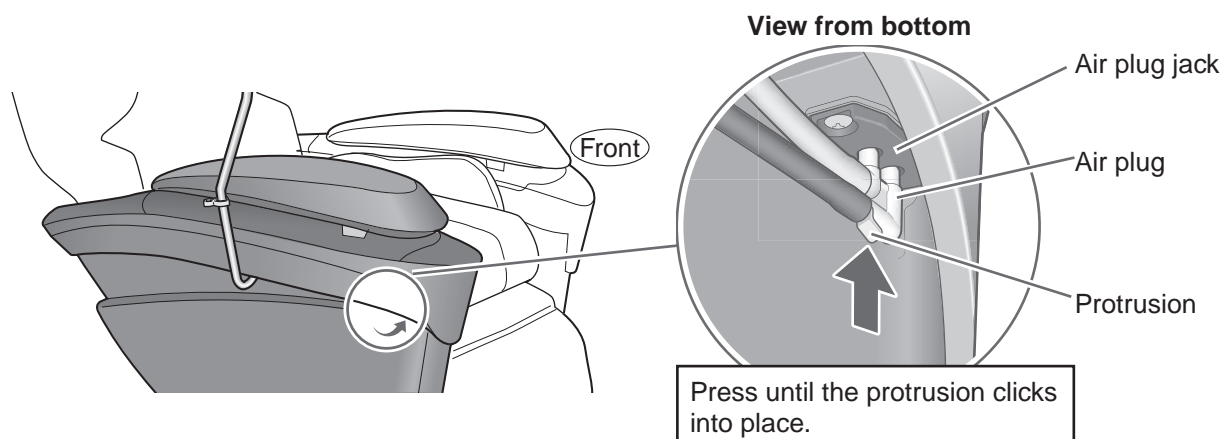

- Arm massage will not operate unless the air plugs are inserted securely.

- ② Follow the same step when connecting to the armrest on the left side.

4 Connect the power cord to the unit

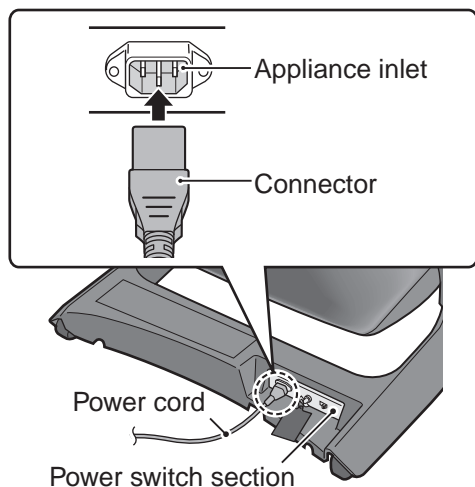

- 1 Check for dirt and damage on appliance inlet of the power switch section and the connector of the power cord.
- 2 Insert the connector into the appliance inlet.
- 3 Be sure to push the connector in all the way.

GROUNDING INSTRUCTIONS

- The unit must be properly grounded. If it should malfunction or break down, grounding provides a path of least resistance for electric current in order to reduce the risk of electric shock.
- This unit is equipped with a cord with an equipment-grounding conductor and a grounding plug. The plug must be plugged into an appropriate outlet that has been properly installed in accordance with all local codes and ordinances.

Assembly (Continued)

5 Turn on the power and raise the backrest to the upright position.

1 Insert the power plug into the power outlet.

- Always be sure to insert into an AC 120 V plug.

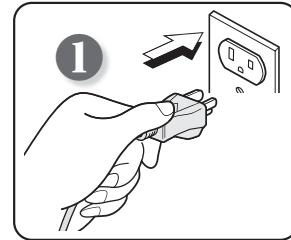

2 Confirm the lock switch key is set to the "open" position.

3 Confirm the power switch is set to the "on" position.

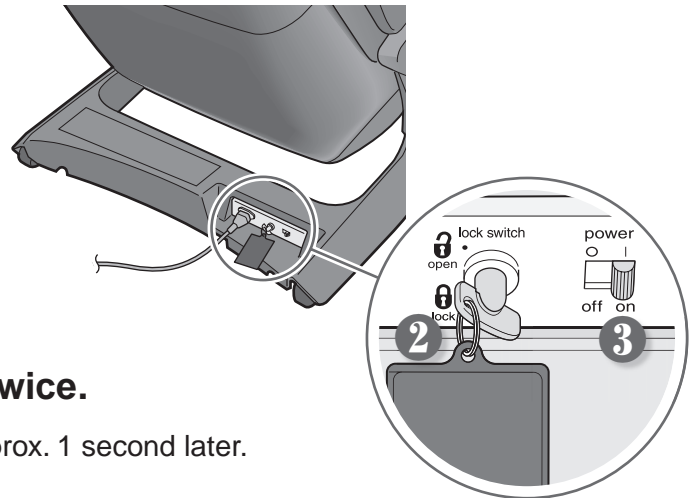

4 Press  on the controller twice.

- Press once, and then press again approx. 1 second later. Backrest will rise automatically.

6 Placing the controller

1 Placing the controller into the controller stand.

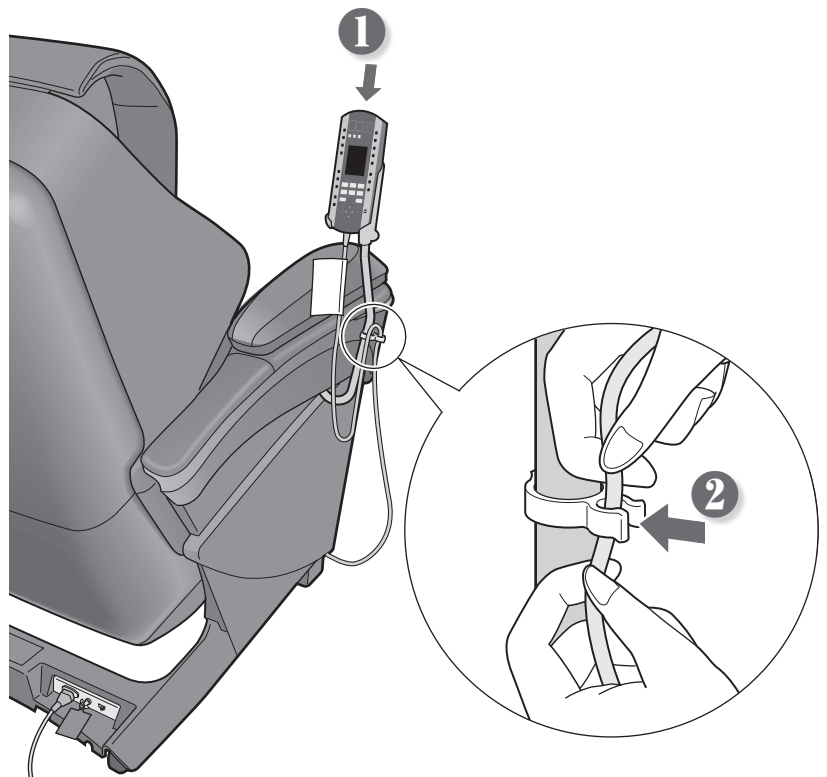

2 Fasten the controller cord using the clip.

- Fasten so the cable under the clip will not sag too much with the backrest raised. (Because there is a chance of the cord becoming tangled with your feet, etc.)



When the controller stand is attached on the left side

- Run the controller cord to the left.

- ① Press  on the controller to turn on the power.
- ② Press  on the controller and hold until the leg rest has risen as far as it will go.
 - Continue pressing until a “beep-beep-beep” sound is heard.
- ③ Disconnect the controller cord.
 - Hook is released by pressing on the tab on the fastening band with your fingers.
- ④ Move the controller cord under the leg rest to the left side.
- ⑤ Fasten the controller cord.
 - Press down from the edge if it does not fit in easily.
- ⑥ Insert the tip of the fastening band into the hole.

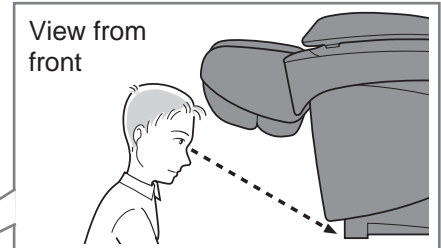
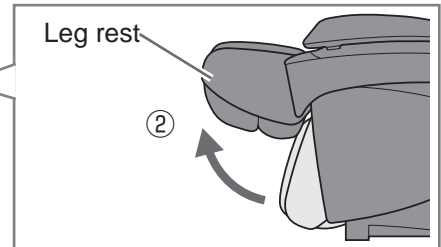

- The controller cord is fastened to the right side prior to leaving the factory.

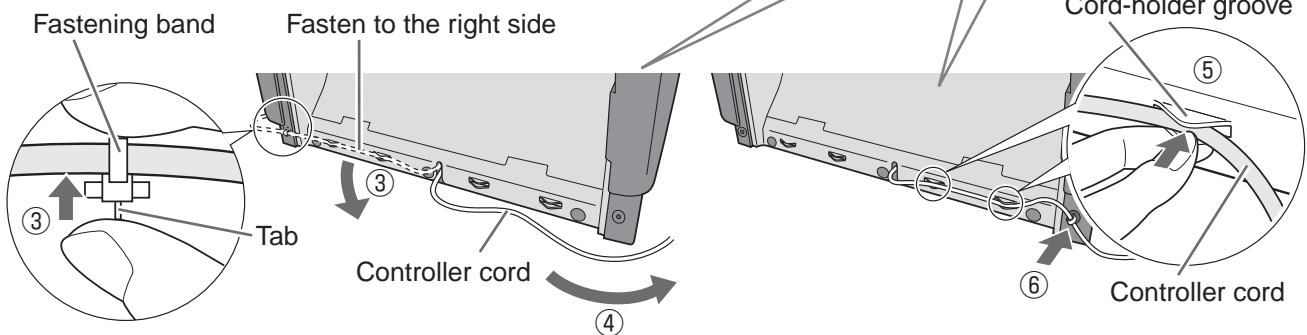

7 Fasten the pillow and the comfort cushion.

- ① Fasten the pillow using the fasteners.

- See page EN23 for guidelines on positioning the pillow during the massage.

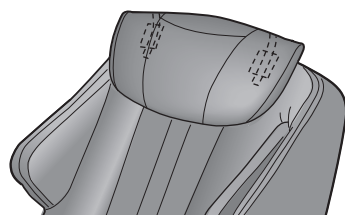
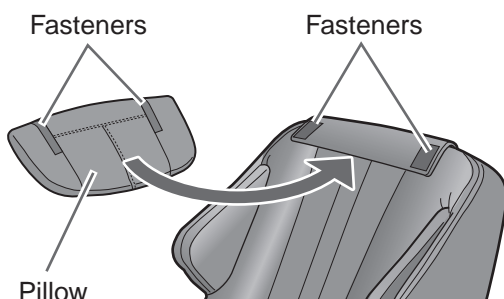

- ② Fasten the comfort cushion using the zipper.

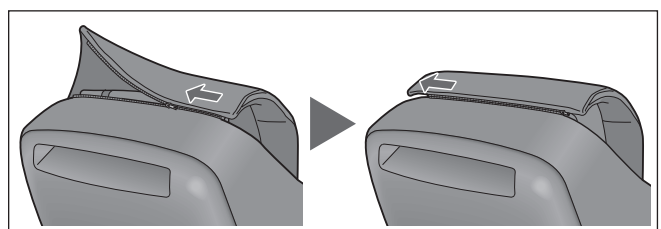
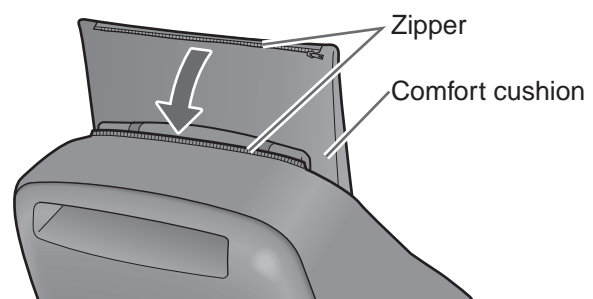

Before sitting down

1 Check the surrounding area.

Make sure there are no objects, people, or pets in the vicinity of the unit.

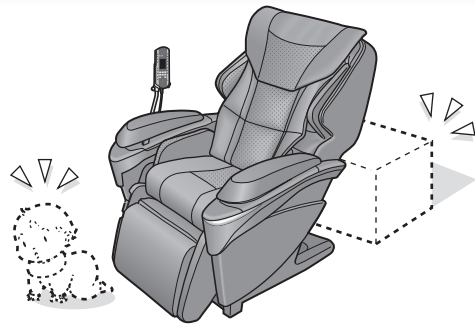

2 Flip up the comfort cushion and deploy the leg & sole massage section.

- Do not massage with the comfort cushion still on the backrest.

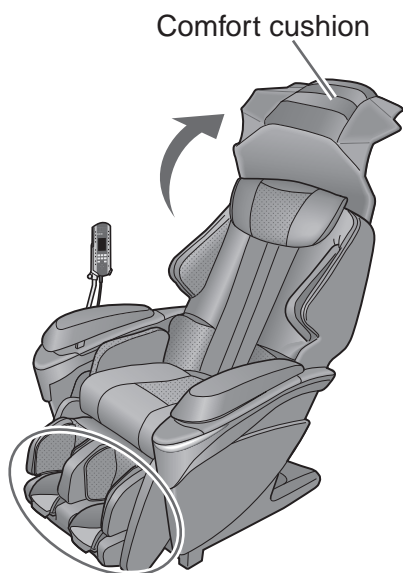

How to deploy the leg & sole massage section

- ① While raising the leg rest rotation lock release lever in the direction of the arrow.

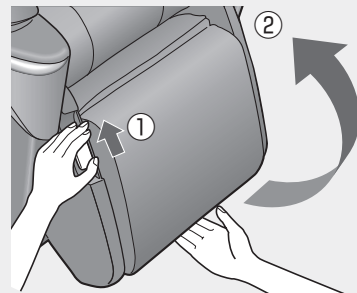

- ② Rotate from bottom.

- ③ Rotate until it stops rotating.

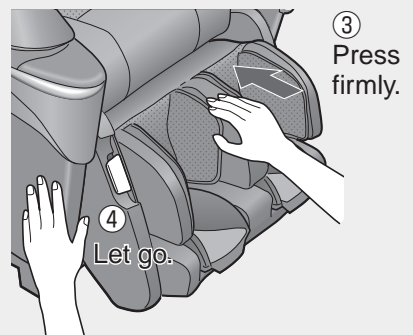

- ④ Let go of the leg rest rotation lock release lever.

- ⑤ Check that the leg rest does not rotate.

⚠ WARNING

- Sit on the unit after confirming there is no foreign matter between the parts of the unit. (Confirm that there are no foreign objects stuck in the comfort cushion, leg rest or hand & arm massage section.) Sit down and ensure that the leg rest is properly locked in place. Failure to observe this precaution may result in accident or injury.

3 Check the power cord and the power plug.

⚠ WARNING

- **Periodically remove dust, etc. from the power plug.**
Failure to do so may result in insulation failure due to humidity, etc., which may cause fire. (Remove dust using a dry cloth.)
- **Never operate the unit if it has a damaged power cord or plug. Return the unit to the nearest authorized service center if it is not working properly, if it has been dropped or damaged, or if it has been immersed in water.**
- **Keep power cords away from heated surfaces. Do not carry the unit by the power cord.**

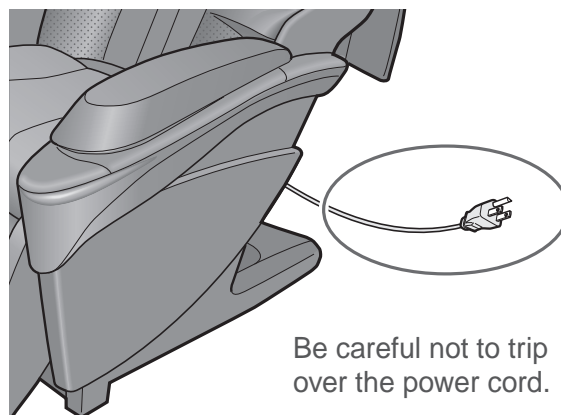

Be sure to push the connector all the way into the appliance inlet.

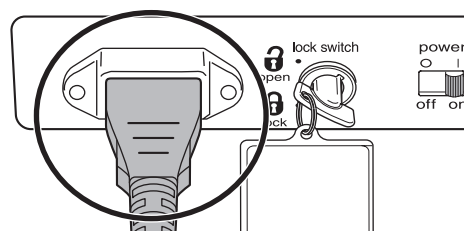

4 Switching on the power supply

- 1 Insert the power plug into an electrical outlet.
- 2 Turn the lock switch key to the "open" position.
- 3 Slide the power switch to the "on" position.

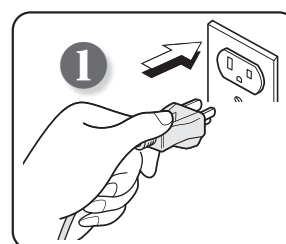

⚠ WARNING

- **Fully insert the power plug to reduce the risk of short-circuit and fire.**
- **Always use sockets and wiring devices at the correct rated value.**
- **Use at the specified power supply 120 V, AC.**
Failure to do so may result in electric shock or fire due to overheating.
- **Do not insert or unplug the power plug with wet hands.**
Doing so may cause electric shock.

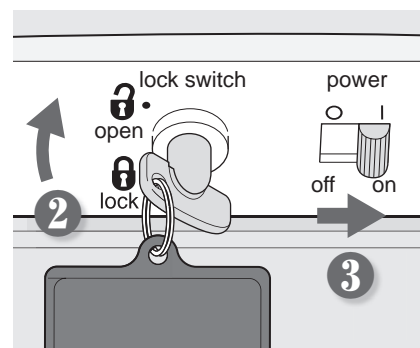

Before sitting down (Continued)

5 Check the unit.

- 1 Make sure there are no tears or rips in the fabric.

WARNING

- Always raise the comfort cushion to check that the fabric covering the movement area of the massage heads in the backrest has not been ripped before using the unit. Please also check other areas to ensure that the fabric has not been ripped. No matter how small the rip, if you find one then immediately stop using the unit, unplug the power cord and have the unit repaired at an authorized service center.

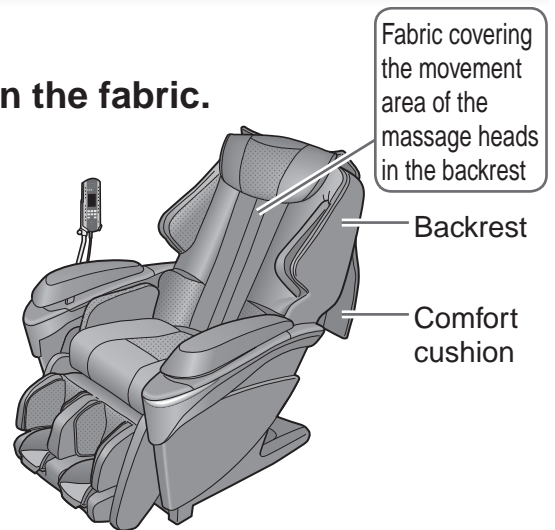

- 2 Make sure there is no foreign matter between the unit.

When the massage heads are not in the retracted position

Press  twice to return the massage heads to the retracted position.

- 3 Make sure the massage heads are in the retracted position.

Check the retracted position of the massage heads

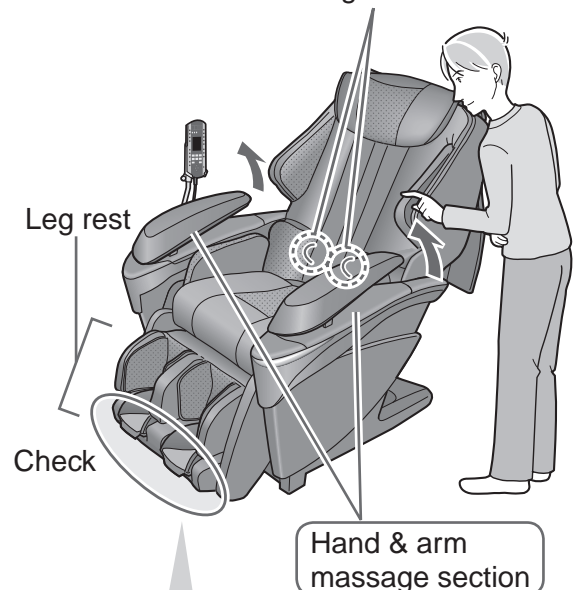

- 4 Make sure the leg rest is in the fully lowered position.

- 5 Check that the leg rest does not rotate.

When the leg rest is not fully lowered

The leg rest will lower by pressing on  twice.

6 Adjust the pillow position.

1 Remove the pillow.

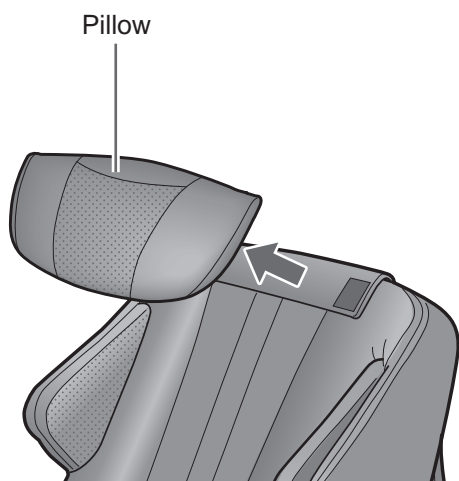

2 Adjust the height of the pillow so that the bottom edge is at ear level.

- If positioned too low, the pillow may interfere with a massage of the area around the neck.
- When the reclining angle changes, the position of the pillow may shift. In that case, adjust the position again.

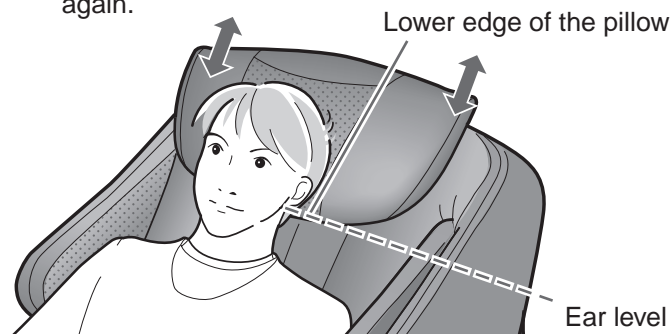

7 Slide the sole massage section to your preferred position.

It will slide up to about 18 cm (7.1 in.).

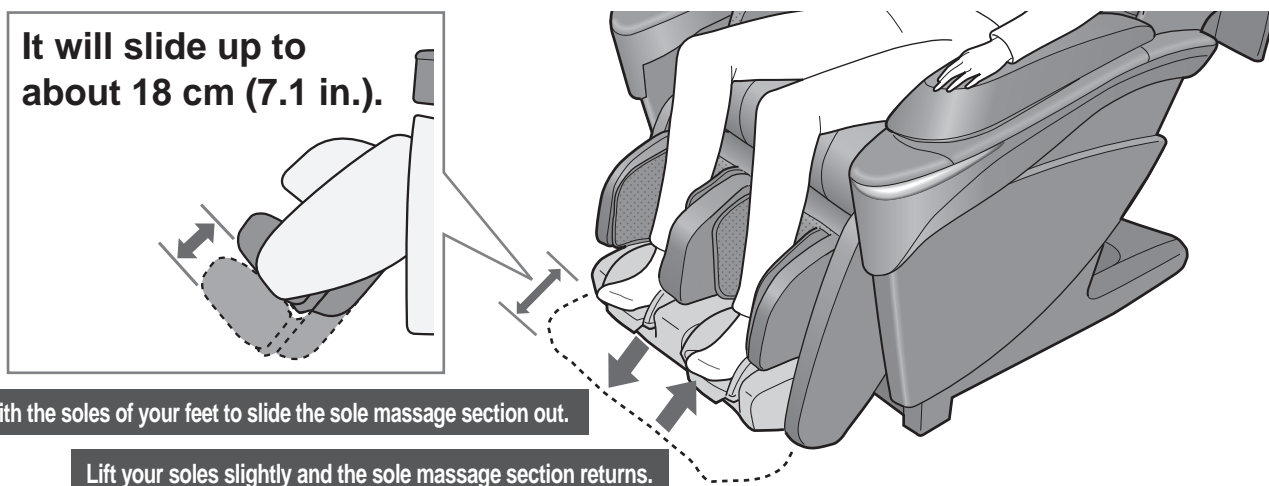

Push with the soles of your feet to slide the sole massage section out.

Lift your soles slightly and the sole massage section returns.

8 Adjust the controller stand.

Horizontal orientation can be adjusted.

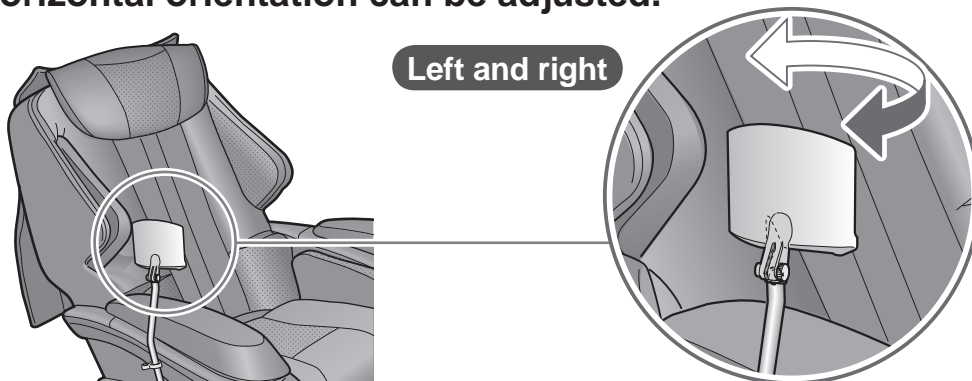

Left and right

Simple use

- 1** Press  to turn the power on.

(The power switches off automatically after 3 minutes if the controls are not operated when the unit is not massaging.)

- 2** Select a function (massage).

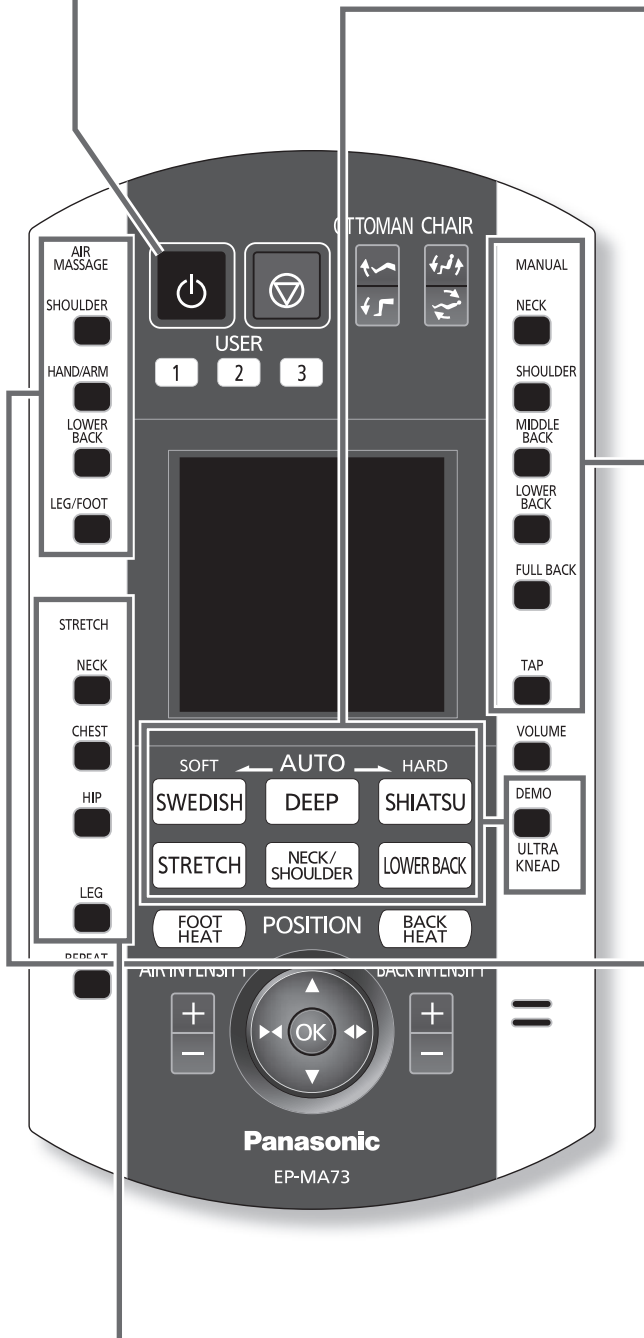

Automatic Course

● For details, see pages EN26 to EN29.

Select one from

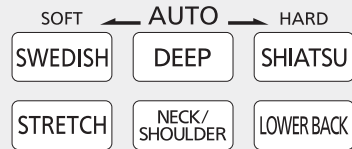

DEMO



ULTRA KNEAD

Manual Operation

● For details, see pages EN34 to EN37.

- 1** Select the body part and press the button.

● Manual operations and air actions can be used at the same time.

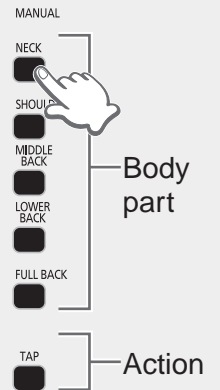

Air Action

● For details, see pages EN38 to EN42.

- 1** Select the body part and press the button.

● You can select multiple body parts.

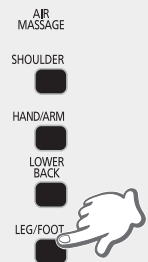

Stretch Action

● For details, see pages EN38 to EN42.

- 1** Select the body part and press the button.

● You can select multiple body parts.

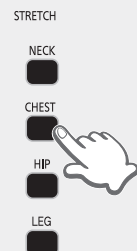

To adjust to your preferences

To adjust the intensity of automatic courses

- Press the buttons to adjust the massage intensity.



2 Choose your favorite action.



3 Press and the action starts.

- You can also select by repeatedly pressing the button of your favorite body part.
- If you want to select tap, press .

To adjust to your preferences

To adjust the intensity

- Press the buttons to adjust the intensity.
- The number of intensity levels that you can adjust differs depending on the action.

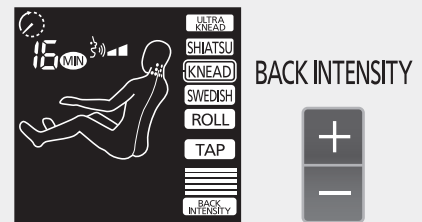

To adjust to your preferences

To adjust the air massage intensity

- Press the buttons to adjust the air massage intensity. (Displayed in 3 steps)

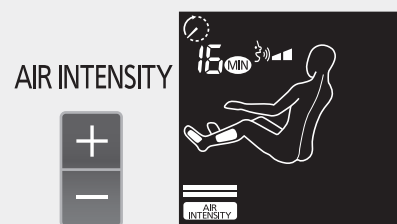

2 Recline the backrest.

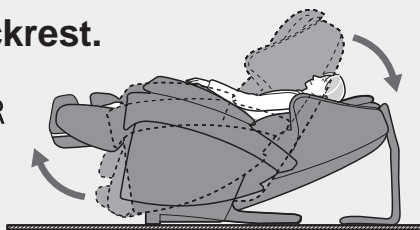
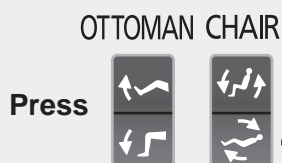

- See page EN43 for description on how to adjust the reclining angle and the leg rest.

To adjust to your preferences

To adjust the intensity

- Press the buttons to adjust the intensity for each of the air and back.

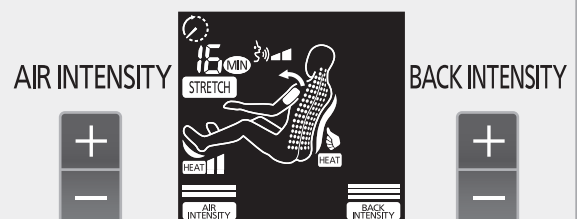

When you want a complete massage

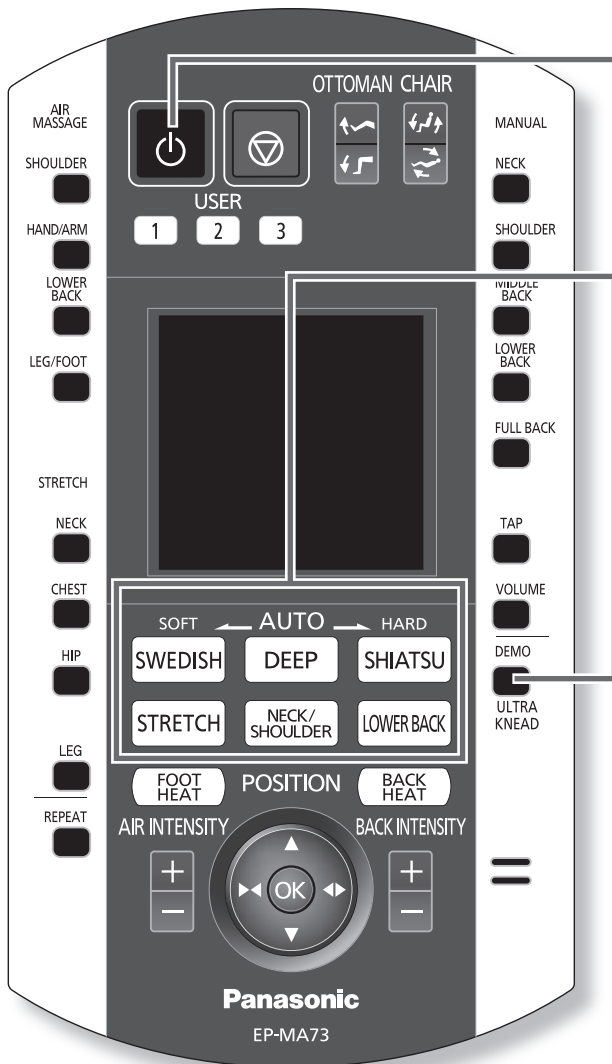

1 Press  to turn on the power.

(When not massaging, the power is turned off automatically if 3 minutes or more pass without operation.)

2 Press one of the buttons

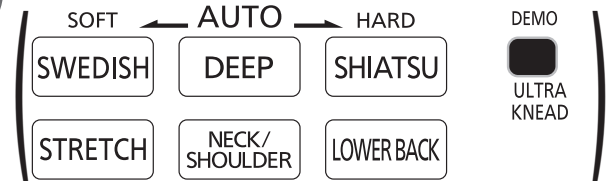

to select the program.

Characteristics of automatic course (upper body)

- SWEDISH** Gentle relaxation course based on Swedish and kneading actions.
- DEEP** Standard course for thorough relaxation based on the kneading and ultra actions.
- SHIATSU** This is a course to strongly loosen points of muscle tightness mainly by shiatsu.
- STRETCH** Stretching course in which four stretching actions are repeated.
- NECK/SHOULDER** ... Relaxation course that focuses on the muscles around the cervical vertebrae (neck and shoulders).
- LOWER BACK** ... This is a course to relax the muscles around your lower to middle back.
- DEMO (ULTRA KNEAD)** ... This course lets you experience the ultra knead action on the upper body, and air ultra knead action on the soles and palms.

● Overview of the respective programs ▶ See page EN50.

Body scanning will commence when the program is selected. (**BODY SCANNING** will flash.)

- The body scanning will properly detect height ranges between approximately 140 cm (55.1 in.) and 185 cm (72.8 in.).

Sit as far back in the seat as possible with your head on the pillow.

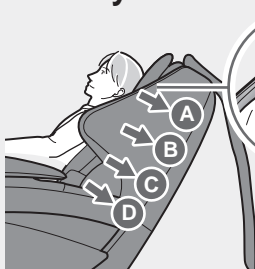

- A: Head
- B: Shoulder
- C: Back
- D: Lower back

Adjust the pillow height so that the bottom edge of the pillow is at ear level.
▶ See page EN23.

The unit will automatically recline to the correct massage position.

Correct massage position



Reclined approx. 20°

Raised approx. 60°

- If the massage lounger is reclined further than the correct massage position angle, it will not automatically recline to the correct massage position.

Approximately 30 seconds after the body scanning starts, the massage heads slowly lower to the shoulder position, and a soft tapping action begins to determine your shoulder position.

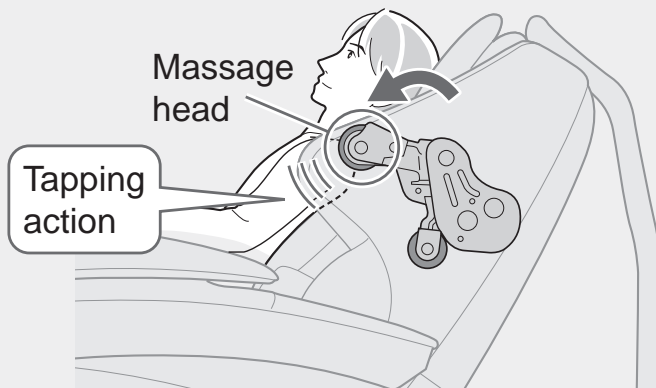

- Air in the seat will operate so the body will not shift during the body scanning.



- Keep your head on the pillow until the soft tapping action begins. Lifting your head from the pillow will result in incorrect determination of the shoulder position.

To adjust the shoulder position during the tapping action

- When the shoulder position is incorrect, adjust then shoulder position while the soft tapping action is in progress (for approximately 12 seconds), and use the POSITION button to move the massage heads up or down and then press **OK**.

POSITION

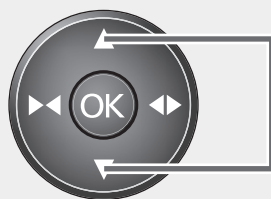

A single press of the button will raise or lower the massage heads approximately 1.2 cm (0.5 in.).

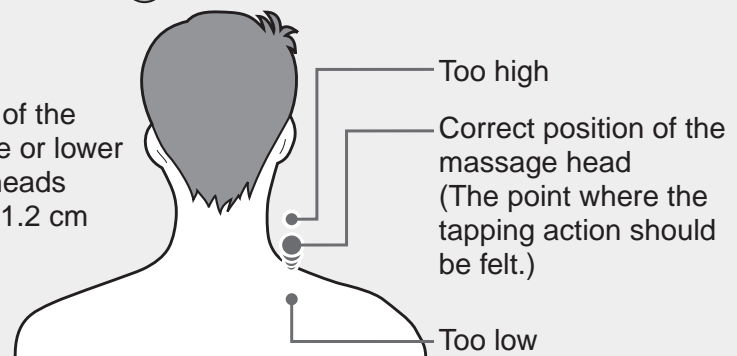

Body scanning is completed when the tapping action finishes.

- If you press **OK** while the tapping action is still going on, it will end the body scanning and the massage will start.
- The leg rest may adjust automatically so that the soles of the feet touch the sole massage section according to your estimated height based on the shoulder position.
- If the shoulder position is off drastically, turn the power off once, and repeat from step ① with shoulder firmly pressed against the backrest.

When you want a complete massage (Continued)

To adjust to your preference

Depending on what you are adjusting, a course in progress may be shut off by the timer function.

Setting the on/off of the air massage or the stretch massage

| AIR MASSAGE | STRETCH |
|-------------|---------|
| SHOULDER | NECK |
| HAND/ARM | CHEST |
| LOWER BACK | HIP |
| LEG/FOOT | LEG |

Operation can be turned on/off by pressing buttons on the left.

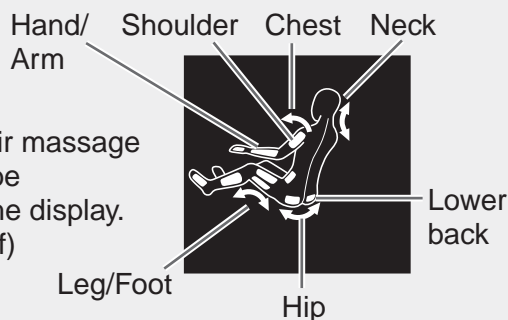

On/off for the air massage or stretch can be confirmed on the display. (Lit: On, Off: Off)

Memory

To repeat the current massage

Contents of current massage action will be repeated by pressing **REPEAT**.

- "REPEAT" command may not be accepted when the action is switching.
- **REPEAT** will flash while massage is repeating.

Changing the intensity of the air massage

When performing a massage on shoulder, hand/arm, lower back or leg/foot,

AIR INTENSITY

Adjust by pressing



- See pages EN38 to EN42 for effective method for using and operations of the air massage and stretch.

Memory

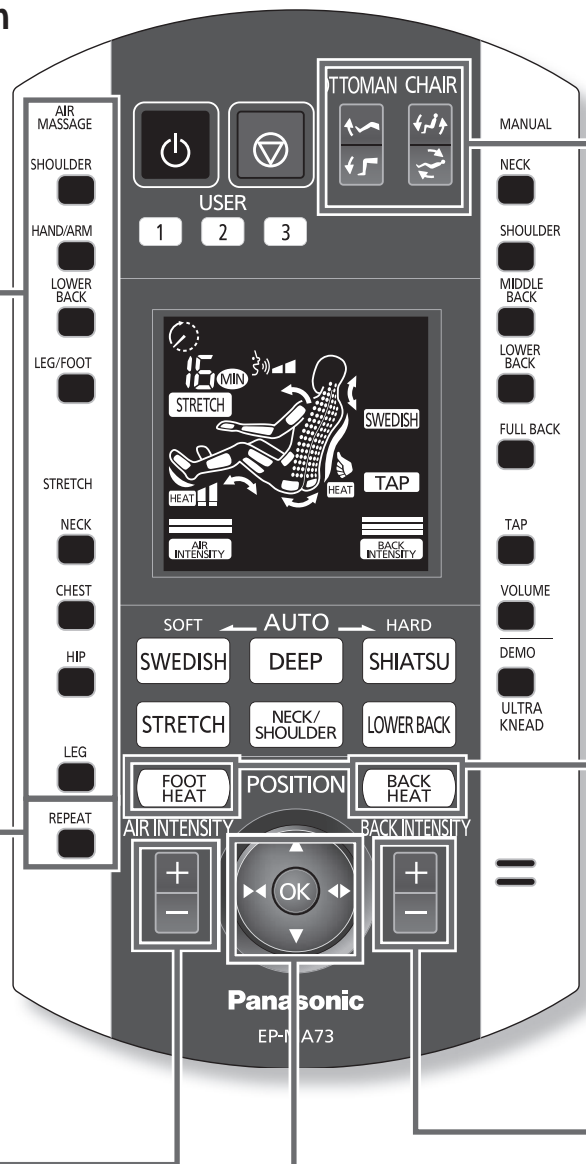

Fine adjustment of the position

(Number of adjustments possible)



- Adjustment may not be possible depending on the position.

Caution

You may not feel the difference in intensity for massage or stretch even if the back (Intensity) adjustment or air (Intensity) adjustment button is pressed.

- When the intensity was increased right when the operation has changed.
- The feeling is different depending on the person or the position.

Adjusting the reclining angle and leg rest to massage in relaxing position

To adjust the reclining angle and the leg rest angle:

OTTOMAN CHAIR

Adjust by pressing



For a person with small body dimensions:
When there is not enough stimulation on your soles
When stimulation of your hands/arms is too gentle
For a person with large body dimensions:
When your knees are raised

See "Effective method for using the leg/foot air massage or stretch" on page EN39.

To adjust the amount of sliding of the sole massage section:

Push with the soles of your feet to slide the sole massage section out.

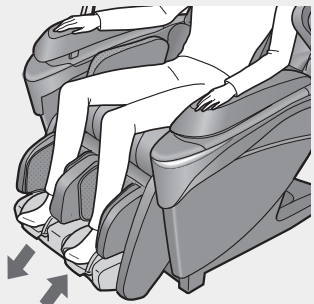

Lift your soles slightly and sole massage section returns.

- See page EN43 for description on how to adjust the reclining angle and the leg rest.

To turn "Heat" massage heads and "Foot Heat" On and Off

You can turn on/off the "Heat" massage heads by pressing

BACK HEAT



Lit: "Heat" massage heads On.
Off: "Heat" massage heads Off.

- Temperature cannot be adjusted.
- For details, see page EN33.

You can turn on/off the "Foot Heat" by pressing

FOOT HEAT



High



Low

Lit: "Foot Heat" On
Off: "Foot Heat" Off

- Temperature can be adjusted between two levels.
- For details, see page EN33.

- Sense of warmth differs depending on your body shape, the massage body part, massage action, clothing, and room temperature.

Memory

To adjust the back intensity

BACK INTENSITY

Back intensity can be adjusted by pressing on the "+" or "-" of the BACK INTENSITY.



- Current position that is getting massaged can be checked on the display.
- There are 3 levels of intensity for the automatic courses. (Three back intensity levels, 1, 3 and 5)
- Intensity will not change further even if you keep pressing the button when the intensity is set to maximum or minimum.



Caution

Intensity might increase drastically when the intensity is increased in multiple steps. Always increase the intensity one step at a time, checking how it feels.

- For safety reasons, it is designed not to increase the intensity drastically.
- If you do not feel enough intensity even if it is set to maximum, or if you feel too much intensity even if it is set to minimum, see page EN54.

Memory

Memory

Items that have this mark can be registered and used with your favorite settings. (See page EN30.)

To register your preferences

You can register your preferred settings set during the automatic course, and have them reproduced next time you are massaging.

Contents that can be registered

(See page EN28 to EN29 for details on how to configure settings and page EN51 for details on volume settings.)

This mark is the indicator

Memory

- Air intensity and back intensity settings
- Air and stretch on/off settings

You can register settings for each automatic course in each USER button.

For example, you can register the following different settings in USER **2**:

High air intensity for "SHIATSU"

Low air intensity for "STRETCH".

- "Heat" massage heads on/off setting
- "Foot Heat" on/off setting and temperature settings
- Voice guidance volume setting

The last setting registered for the USER button is applied regardless of which automatic course is used.

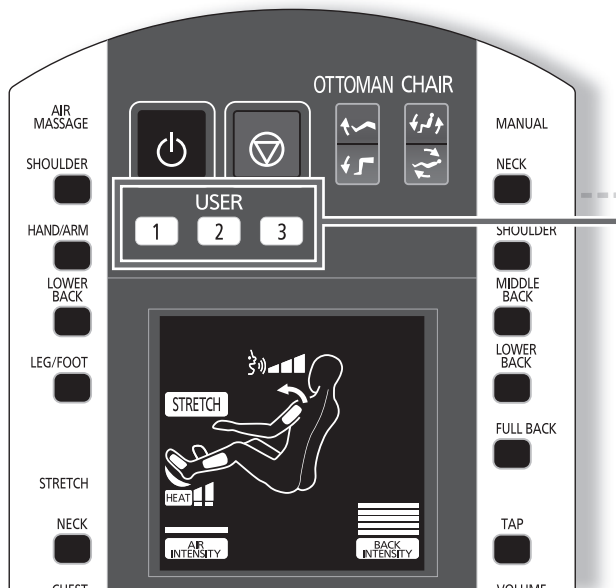

1 After the automatic course has finished, or when the massage is completed by pressing  during the course

Your preferred settings (pages EN28–29, EN51 (volume)) are displayed and the USER buttons will flash.

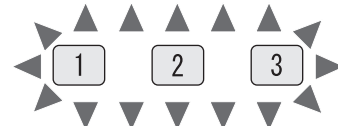

2 Select and press one button from **1** **2** **3** that you would like to register while the buttons are flashing (approx. 15 seconds).

- Selected button will light. (Example: **1**)

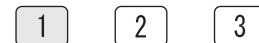

If there is another setting already registered, "Other settings are already registered." will be announced.*

- To update to contents of new setting* Press the same button again.



Press.

*This will also be announced when you try to register to a separate automatic course or same automatic course contents that are the same as those already registered.

- If you do not want to delete the setting already registered Press other USER button.





Press.

When the registration is completed

- Pressed button will turn off, and the power will be turned off automatically in approximately 3 seconds.
- Be careful since registered contents will not be saved when the power switch is turned "Off" or the power cord is disconnected during the massage.

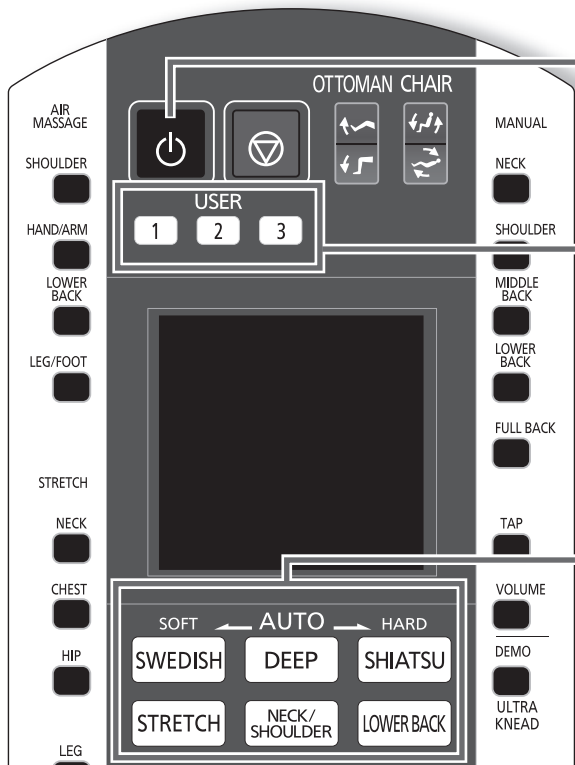
To start the registered program



- 1** Press  to turn on the power.
 (When not massaging, the power is turned off automatically if 3 minutes or more pass without operation.)
- 2** Select one of the **USER** buttons that is registered.
 ● Registered USER button will light. (Example: )
- 3** Select and press one of the automatic courses that is registered using the **USER** button. (Example: "SWEDISH")

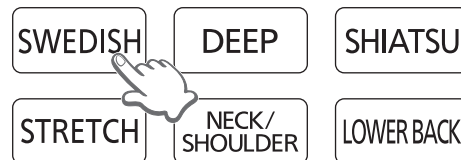

Massage with registered setting will start after the body scanning.

- When an unregistered course is selected, the standard automatic course massage is applied. However, the "Heat" massage heads on/off settings, "Foot Heat" on/off settings, temperature settings and volume settings registered to the USER button are applied. (See page EN30.)

To delete the registered settings (Example:)

- 1** Press  to turn on the power. Press the button you want to delete.
- 2** Press again and hold for more than 3 seconds until the button changes to flashing.
- 3** Press again during the button flashes (about 10 seconds).

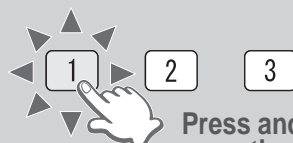

Delete is completed once the flashing stops.

About the “Heat” massage heads/“Foot Heat”

⚠ WARNING

- When “Heat” massage heads are used, do not let the massage heads touch the same place for a long time.
- Do not use the “Foot Heat” massage for a long time.
Low-temperature burn may occur.

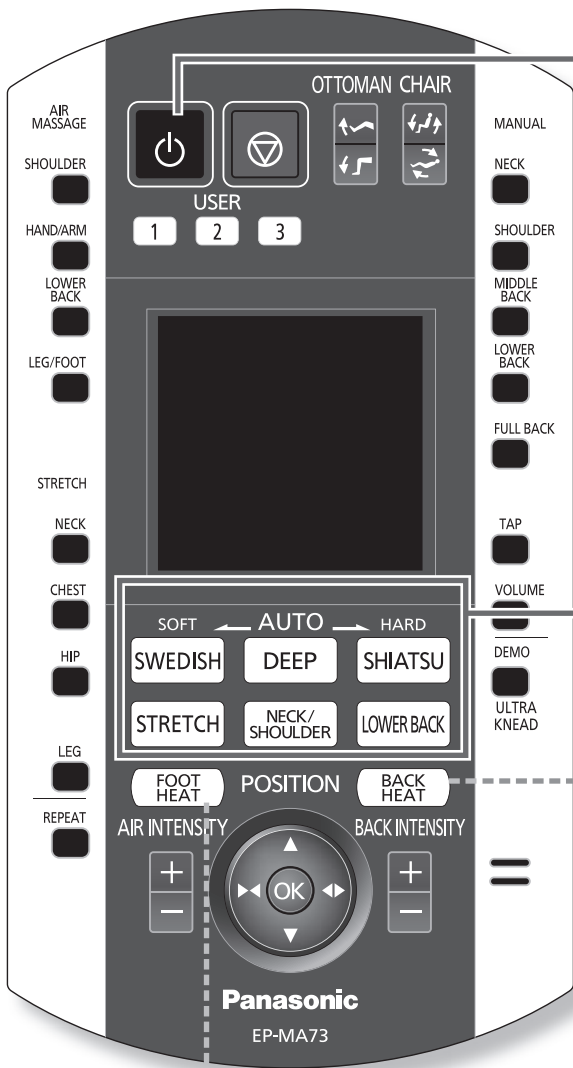

1 Press  to turn on the power.

(When not massaging, the power is turned off automatically if 3 minutes or more pass without operation.)

2 Press the automatic course button and start the massage.

To turn “Heat” massage heads On

 Lit (On)



Lit: “Heat” massage heads On
● Temperature cannot be adjusted.

To turn “Heat” massage heads Off

Press  to turn off.

- Button will turn off.

To turn “Foot Heat” On

 Lit (On)



Lit: “High” On



Off: “Foot Heat” Off

- Button also turns off.



Lit: “Low” On

- Sense of warmth differs depending on your body shape, the massage body part, massage action, clothing, and room temperature.

To turn “Heat” massage heads/“Foot Heat” off each time

- Register “Heat” massage heads/“Foot Heat” as off in the memory. (See page EN30.)

The warm section of the “Heat” massage heads warm up the cloth of the massage location.

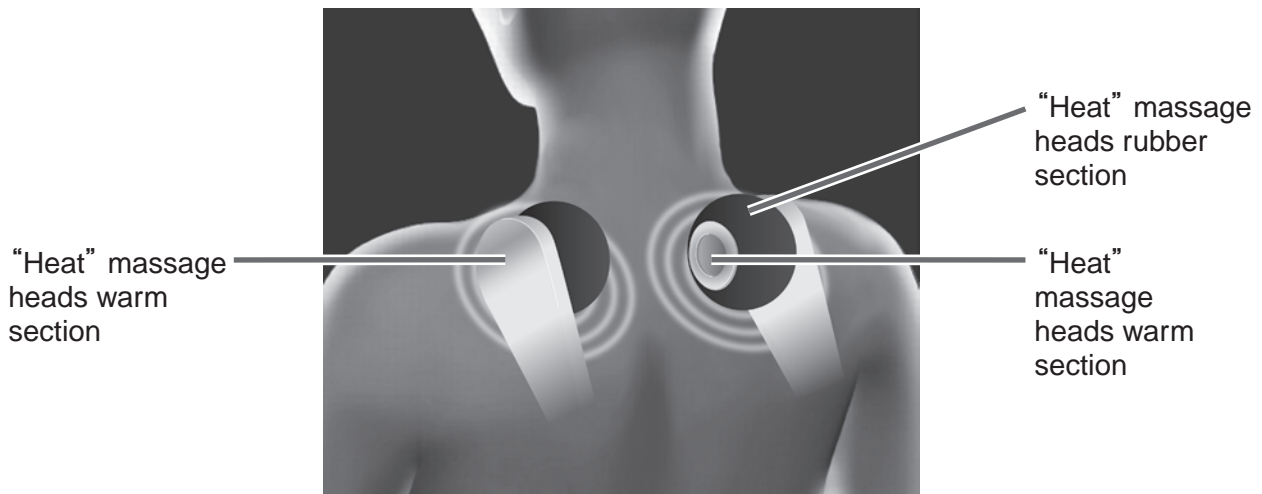

The “Foot Heat” uses a built-in “Heat” (heater) section in the sole section to warm the toe portion of the cloth.

Warms the toe portion of the cloth

Place feet so that they are firmly pressed against the “Heat” (heater) section. Raise the sole massage section during use so that soles of your feet touch this section to feel the heat from the heater section. You can also place a blanket over your knees and lower legs to feel even warmer.

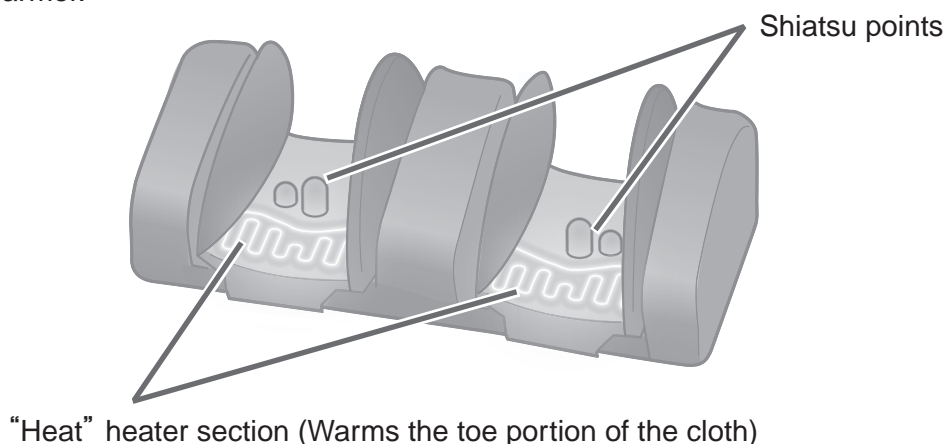

- Heat function cannot be used alone.
- Warmth may vary according to room temperature, clothing and physical build.
- Warmth will vary between “Heat” massage heads and “Foot Heat” .
- If the “Foot Heat” controller is set at a low temperature, try adjusting it higher.

Manual operation

When you want a concentrated massage of a particular body part with your favorite action, such as “Kneading on the neck” or “Tapping on the shoulder”

! WARNING

- Do not massage any one point for more than 5 minutes at a time. Excessive massaging can overstimulate the muscles and nerves and result in an adverse effect.

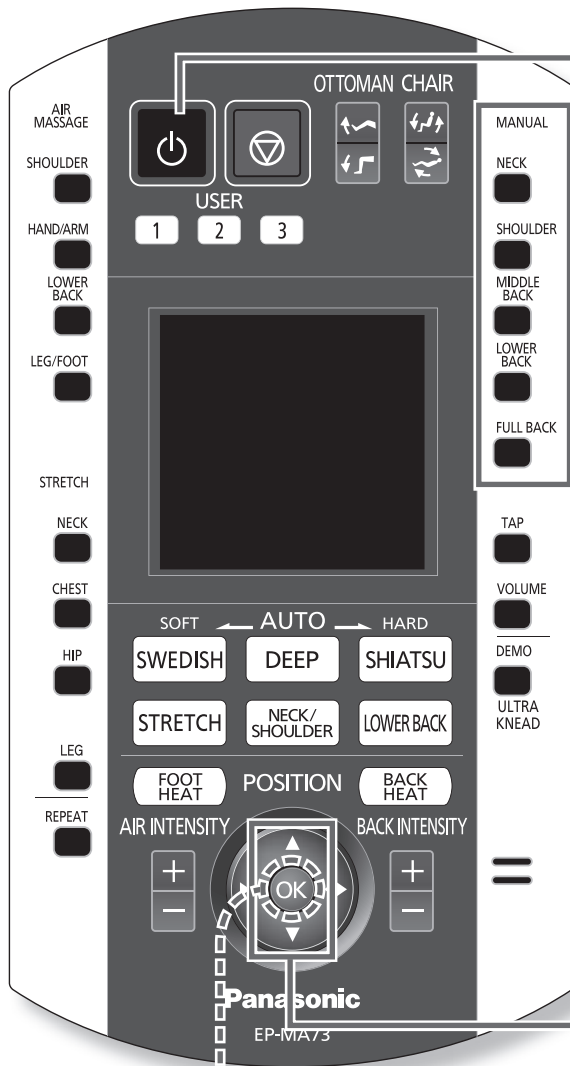

1 Press  to turn on the power.

(When not massaging, the power is turned off automatically if 3 minutes or more pass without operation.)

2 Select the body part you want to massage.

MANUAL

- List of manual massage options is displayed.

(Example)
When “NECK” is selected

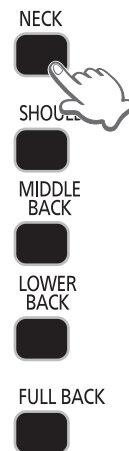



3 Select action you prefer.

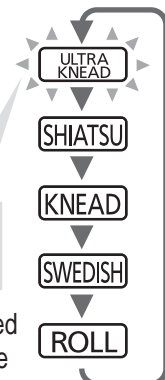

The currently selected action flashes

- Action can also be selected by repeatedly pressing the area selected in step 2.



- When  is selected, “ROLL” or a combination of “ROLL” and another action can be selected.

4

4 Press to start the action.

- The massage heads will move to selected position automatically to start the massage after the body scanning is completed. See page EN26 about body scanning.
- See pages EN36-37 for setting the massage in accordance with your preferences.
- When a massage to the same location has continued for 5 minutes, it will automatically move up approximately 3 cm (1.2 in.).

Body scanning for manual operation

NECK/SHOULDER/FULL BACK ... Normal body scanning.



MIDDLE BACK/LOWER BACK ... Simple body scanning. (The massage heads will not come up to the shoulder position.)

To change an action in the middle of a massage

Select your favorite one again in steps ② to ④.

- Press  within approximately 40 seconds after reselecting an action in step ②, otherwise the reselection will be cancelled automatically.

If you want to massage with tapping action only

- ① Press  to turn on the power.
 - ② Select .
 - ③ Start the tapping action by pressing .
- Body scanning will not be performed.
 - To change the action, select with steps ② – ④ on the previous page.

When you want a concentrated massage of a particular body part with your favorite action, such as “Kneading on the neck” or “Tapping on the shoulder” (Continued)

To adjust to your preference

Using air massage together

AIR MASSAGE

SHOULDER

HAND/ARM

LOWER BACK

LEG/FOOT

Operation can be turned on/off by pressing buttons on the left.

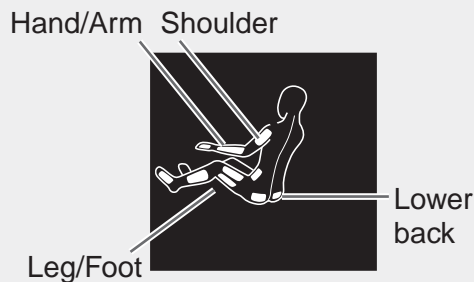

On/off for the air massage can be confirmed on the display.
(Lit: On, Off: Off)

Changing the intensity of the air massage

When performing an air massage,
AIR INTENSITY

Adjust by pressing



● Intensity is displayed in 3 levels.

Fine adjustment of the position

POSITION

It can be adjusted with



● When you keep on pressing the button up or down, the position will move continuously until you release the button.

Caution

The stretch action will not be performed simultaneously. The manual operation is cleared when any STRETCH button is pressed.

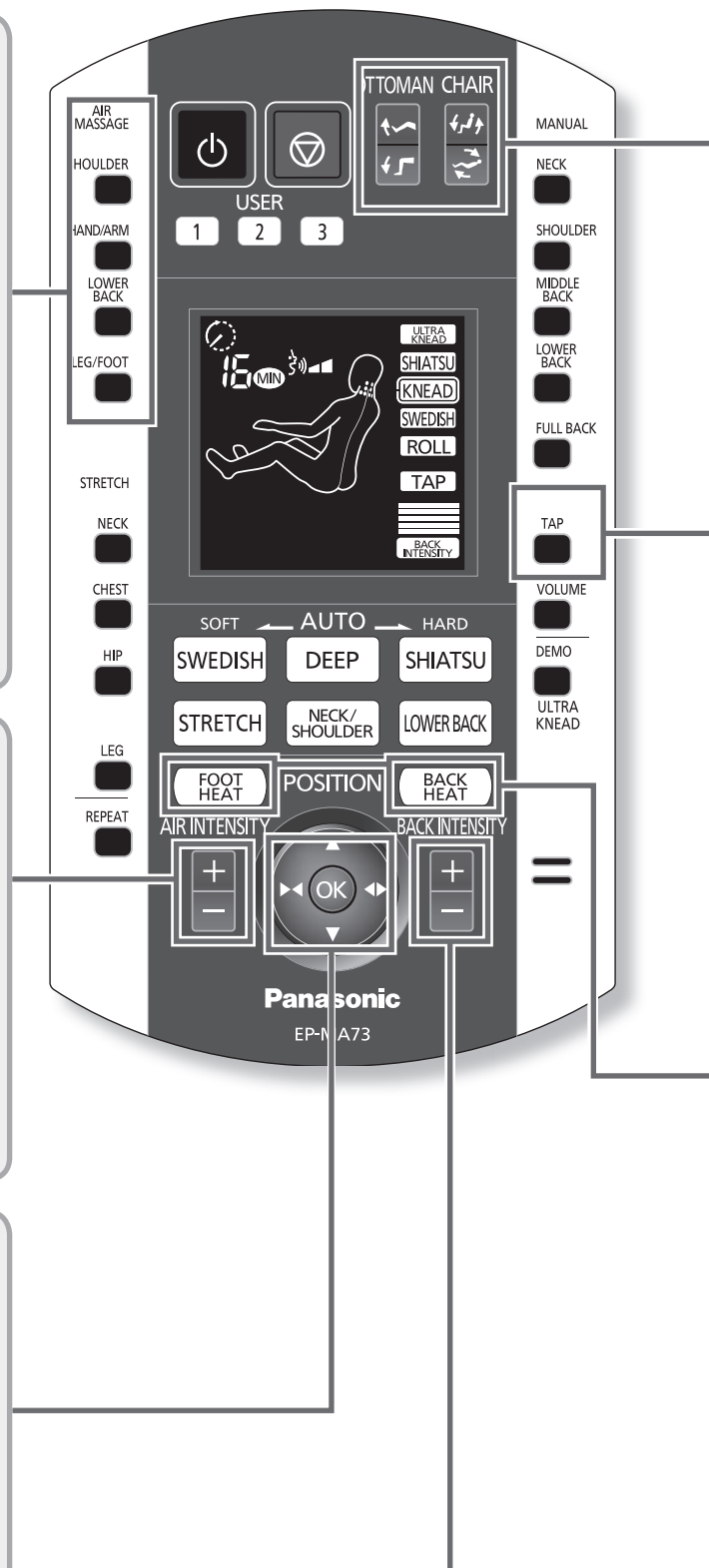

Adjusting the reclining angle and leg rest to massage in relaxing position

To adjust the reclining angle and the leg rest angle:

OTTOMAN CHAIR

Adjust by pressing



To adjust the amount of sliding of the sole massage section:

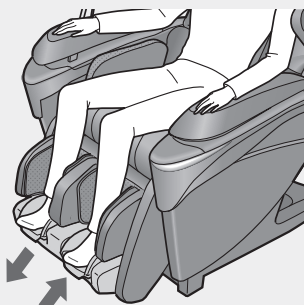

Push with the soles of your feet to slide the sole massage section out.

Lift your soles slightly and the sole massage section returns.

- See page EN43 for description on how to adjust the reclining angle and the leg rest.

Adding tapping actions to the current operation

Press .

- You can select tap on/off every time it is pressed. You cannot select on/off when you are massaging only with the tapping action.

Turning the "Heat" massage head and "Foot Heat" On and Off

You can turn the "Heat" massage heads on/off by pressing .



Lit: "Heat" massage heads On.
Off: "Heat" massage heads Off.

- Temperature cannot be adjusted.
- For details, see page EN33.

You can turn on/off the "Foot Heat" by pressing .



Lit: "Foot Heat" On
Off: "Foot Heat" Off

High



Low

- Temperature can be adjusted between two levels.
- For details, see page EN33.

- Sense of warmth differs depending on your body shape, the massage body part, massage action, clothing, and room temperature.

Adjusting the back intensity

BACK INTENSITY



Back intensity can be adjusted by pressing on the "+" or "-" of the BACK INTENSITY.

- The intensity of manual operation is displayed.
- Level of intensity that can be adjusted differs depends on the action.

Caution

Intensity might increase drastically when the intensity is increased in multiple steps. Always increase the intensity one step at a time, checking how it feels.



- For safety reasons, it is designed not to increase the intensity drastically.

Air action Stretch action

To perform air massage for shoulder / hand/arm / lower back / leg/foot, or stretch for neck / chest / hip / leg

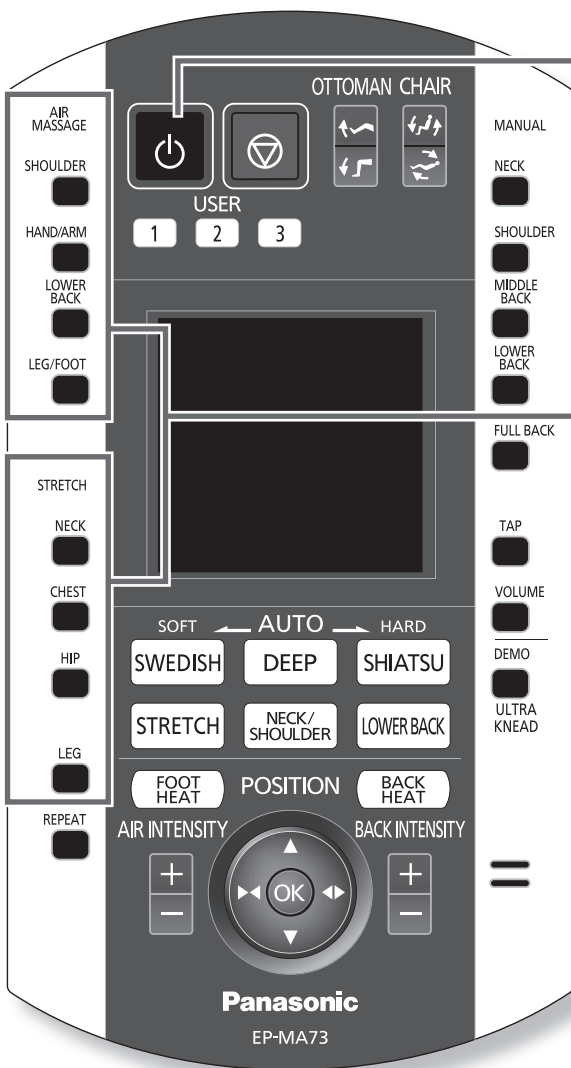

1

Press  to turn on the power.

(When not massaging, the power is turned off automatically if 3 minutes or more pass without operation.)

2

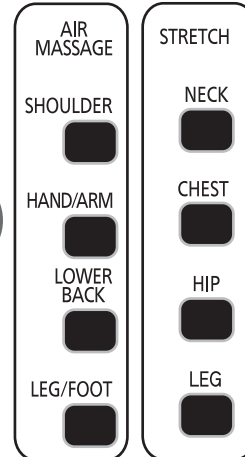

Select the body part you want to massage.

On/off for the air massage or stretch can be confirmed on the display.

- Lit: On
- Off: Off

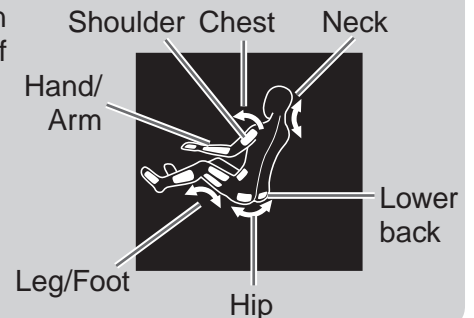

To adjust the air intensity

AIR INTENSITY

Adjust by pressing



- Intensity is displayed in 3 levels.

To adjust the back intensity (only for stretch)

BACK INTENSITY

Adjust by pressing



- Intensity is displayed in 3 levels.

Turning "Heat" massage heads On and Off (only for stretch)

Press  to turn this on and off.

- See page EN32 for details.

Turning "Foot Heat" On and Off

Press  to turn this on and off.

- See page EN32 for details.

Effective method for using the leg/foot air massage or stretch

Adjust the leg rest so that your sole fits on sole massage section completely.

- Place your feet so that the arch of your feet are touching the shiatsu points.

For a person with small body dimensions

- If the leg rest is raised, it is easier to fit your sole on it.

OTTOMAN CHAIR



Press the button.

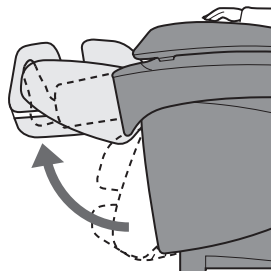

For a person with large body dimensions

- If the slide of the sole massage section is adjusted, your knees will not be lifted as much.

Push with the soles of your feet to slide the sole massage section out.

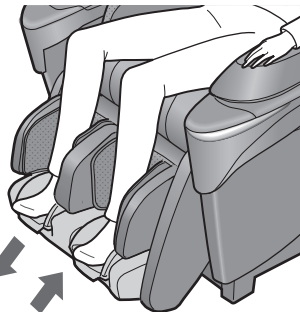

Lift your soles slightly and the sole massage section returns.

- Knees will not be lifted as much also by lowering the leg rest.

OTTOMAN CHAIR



Press the button.

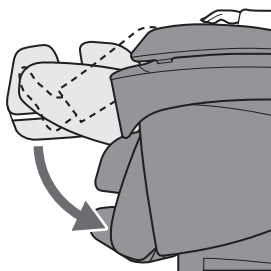

It is possible to massage your leg completely by laying the sole massage section flat.

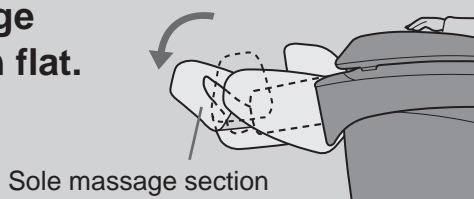

How to use the hand & arm massage

- 1 Lift the hand & arm massage section up.

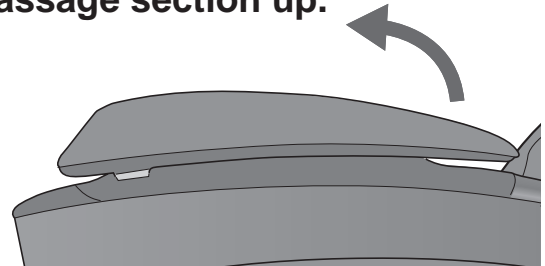

- 2 Insert the hand with fingers extended.

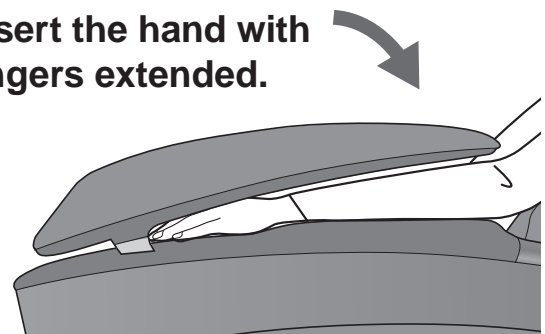

Effective method for using the hand & arm massage

Position the forearm and hand at the center of the armrest.

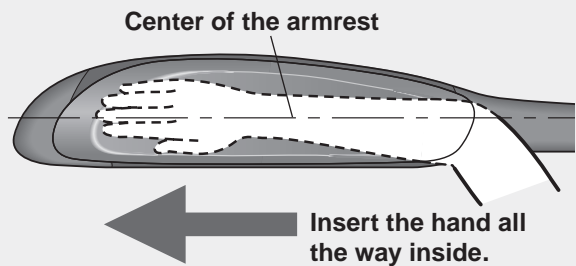

- Raise the backrest if there is any difficulty when positioning the hand and forearm.

To perform air massage for shoulder / hand/arm / lower back / leg/ foot, or stretch for neck / chest / hip / leg (Continued)

Operation of the HAND / ARM (Ultra knead on palms) massage

Palms to arms : The two large and small airbags work together to firmly massage your palms.

- The arm massage simultaneously massages the left and right hands, with a different intensity for either hand. (Only one hand at a time is strongly massaged so that the massage can be immediately stopped in the event of an abnormality or danger.)

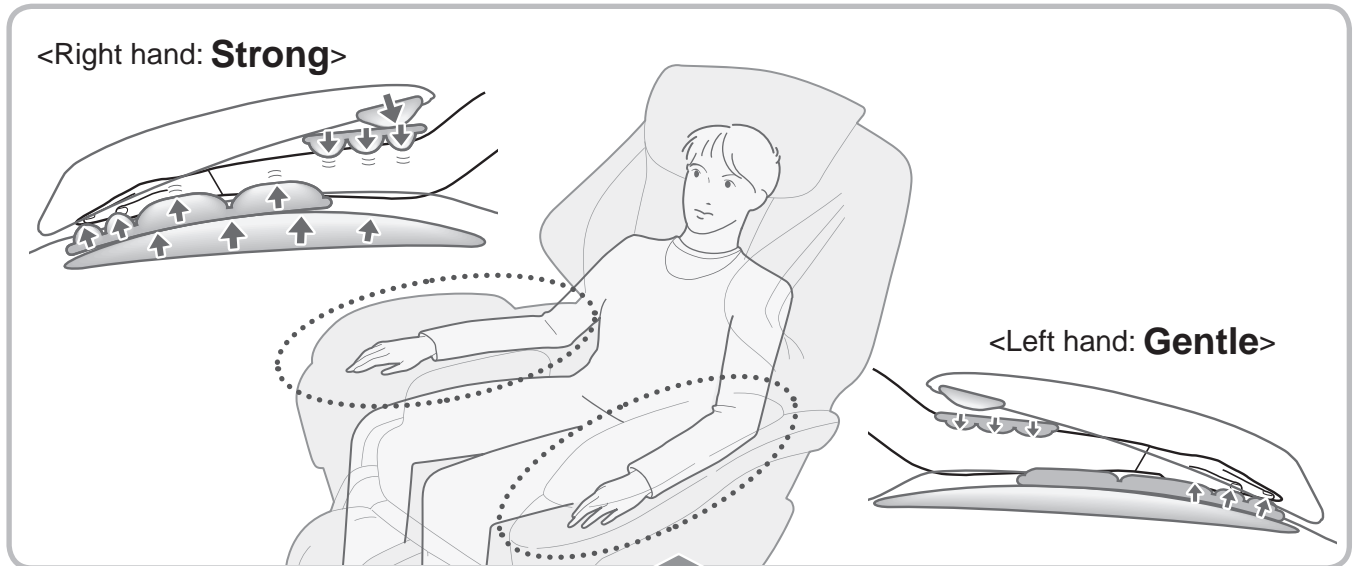

Alternates

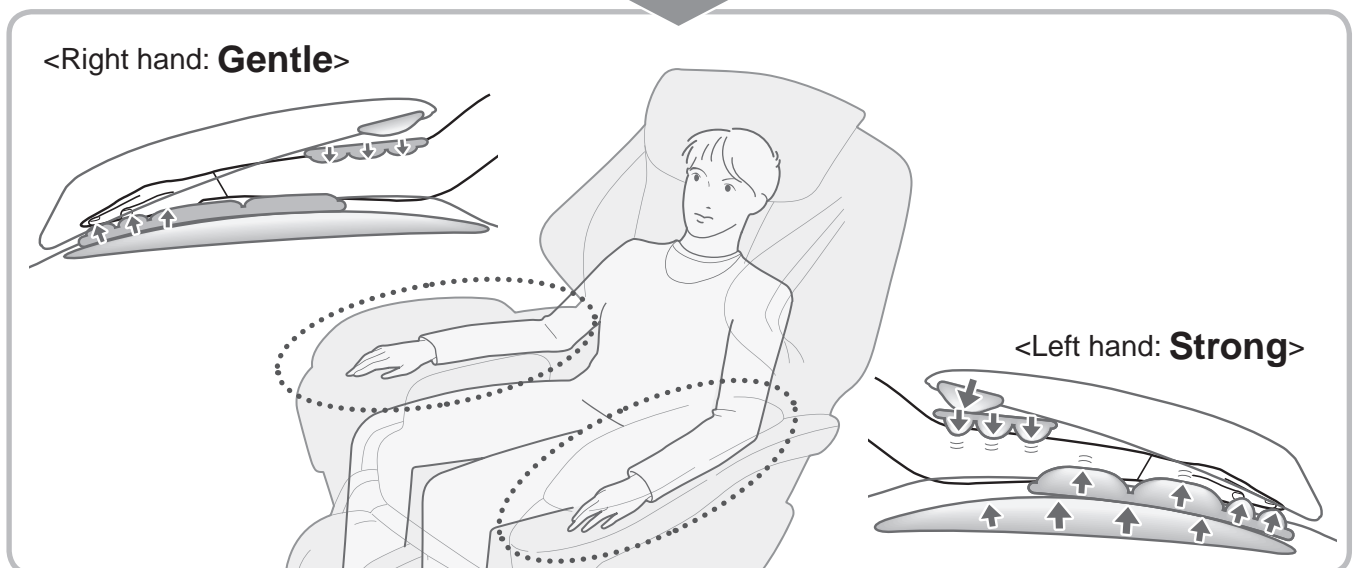

Adjust the position according to arm length.

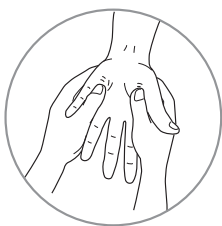

Ultra knead on palms

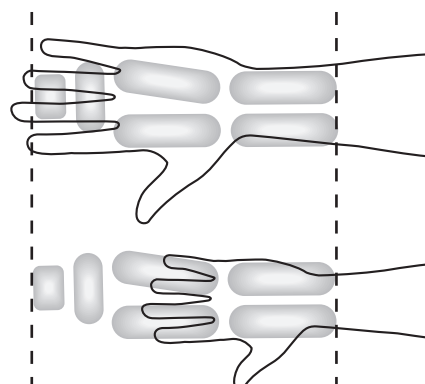

Long arms

Short arms

Operation of the SHOULDER massage

Pressure is applied to clamp from your shoulders to your arms from the sides.

Operation of the LOWER BACK massage

Pressure is applied to clamp your lower back through tights from the sides.
The 3 airbags in the seat gives stimulation to your posterior through hamstring.

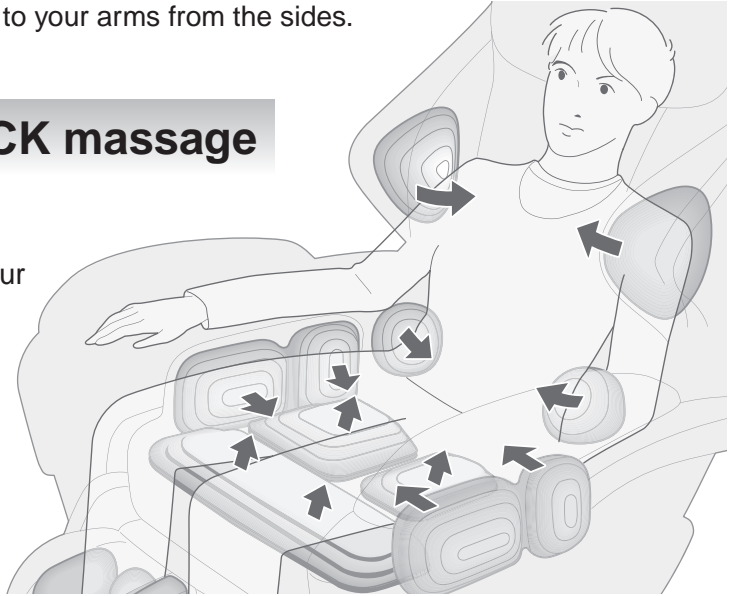

Operation of the SOLE (Ultra knead on soles) and LEG / FOOT massage

Sole : Example below.

- Place your feet so that the arch of your feet are touching the shiatsu points.

Ultra knead on soles

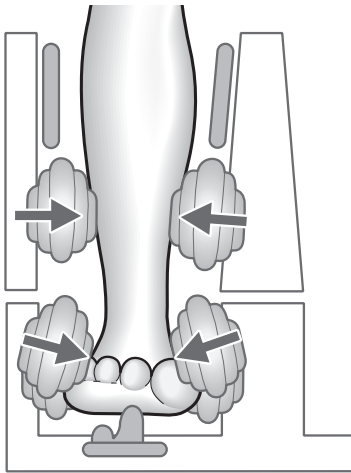

Press soles down from above so that they are enclosed.

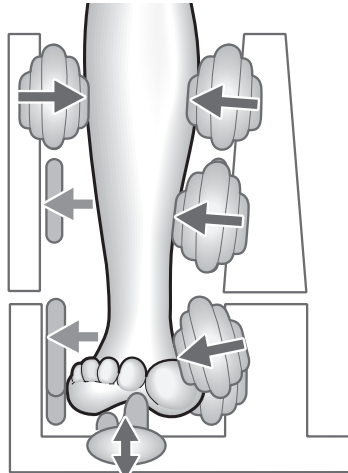

The sole airbags inflate from below and the points press the sole. The left and right airbags inflate alternately.

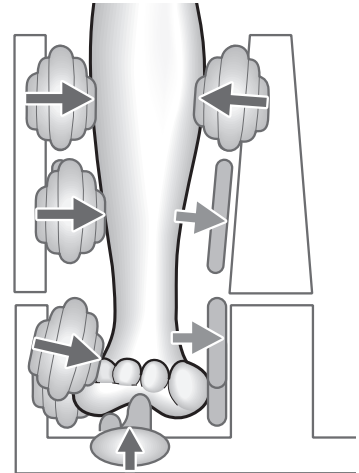

The sole is moved from side to side and firmly massaged.

Leg : Calves will be compressed by pressing against from both sides.

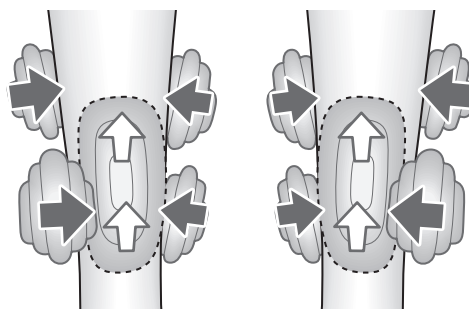

► Continued on the next page EN41

To perform air massage for shoulder / hand/arm / lower back / leg/ foot, or stretch for neck / chest / hip / leg (Continued)

Operation of the NECK stretch

The massage heads secure the neck and the base of the head while air is slowly discharged from the inflated backrest airbags to extend the neck muscles.

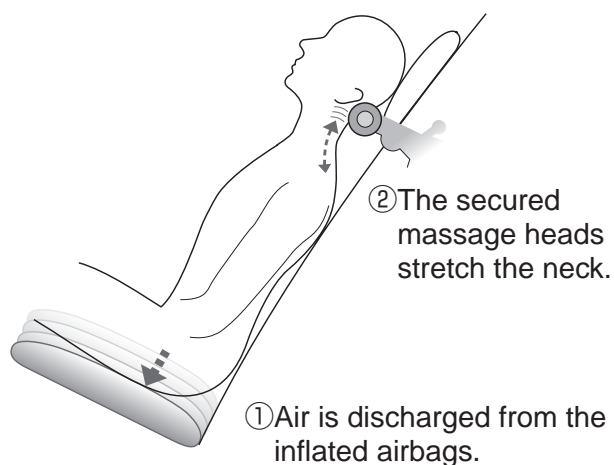

Operation of the CHEST stretch

Muscles in the region from your shoulder blades to your chest are stretched by holding your shoulders with the shoulder side massage section and pressing your back with the massage heads.

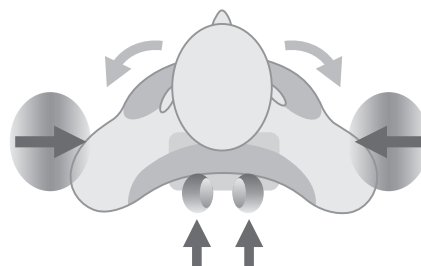

Operation of the HIP stretch

Muscles are loosened by widely twisting and swaying around your pelvis.

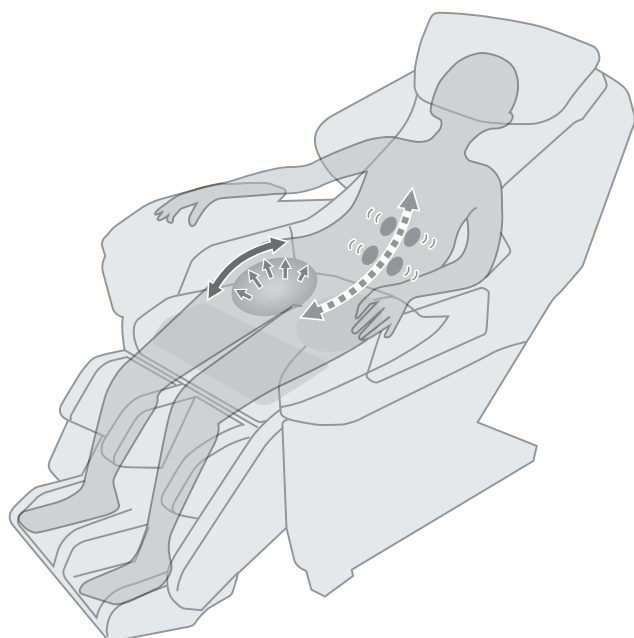

Operations of the LEG stretch

Legs are stretched by clamping on the sides of your thighs and legs/soles and lowering the leg rest.

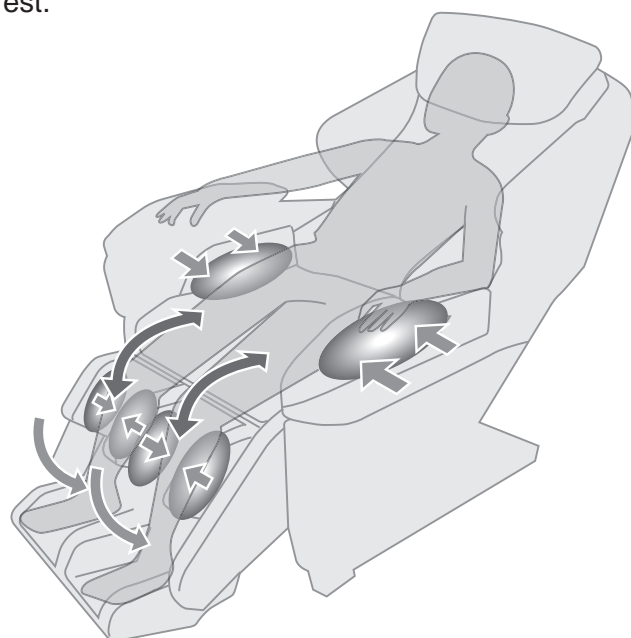

● Sole massage section might hit the floor etc. when the LEG stretch is performed with the sole massage section having been slid out to extend.

When you want to adjust the reclining angle and/or leg rest

1 Press  to turn on the power.

(When not massaging, the power is turned off automatically if 3 minutes or more pass without operation.)

OTTOMAN CHAIR

2 Press   to adjust the angle.

- Movement will continue until a “beep-beep-beep” sound is heard if the buttons are held down.
- The movement of the leg rest may be delayed slightly.
- Armrest will move in accordance with the reclining of the backrest.

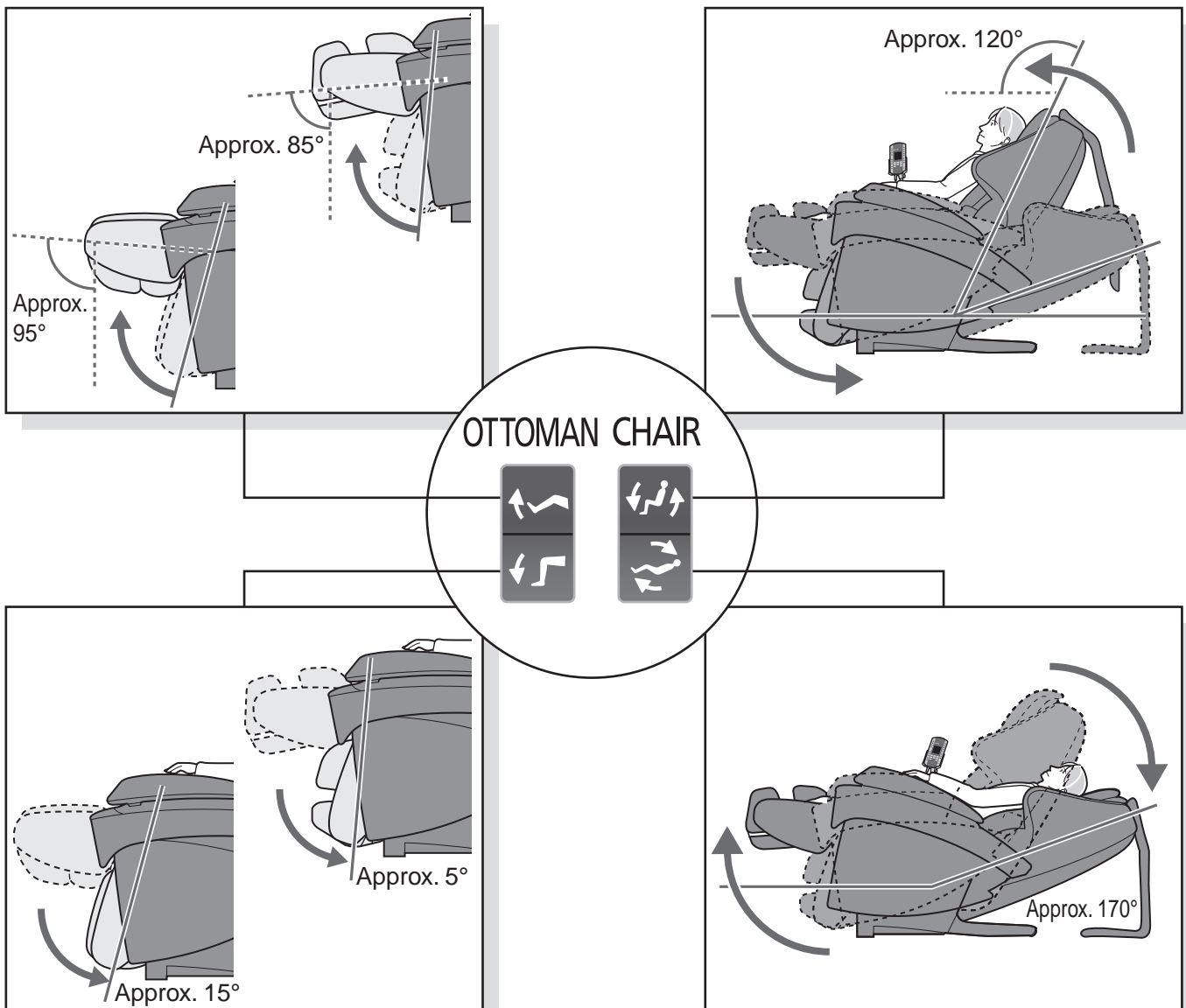

- Do not raise or lower the backrest and/or leg rest repeatedly for any purpose other than adjusting to your preferred positions.

After completing the massage

Returning to normal chair position

1 Hang the comfort cushion on the backrest.

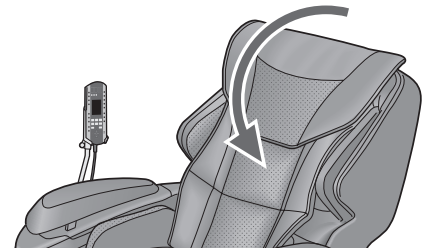

2 Store the leg rest.

- ① While raising the leg rest rotation lock release lever in the direction of the arrow.
- ② Rotate from top.
- ③ Rotate until it stops rotating.
- ④ Let go of the leg rest rotation lock release lever.
- ⑤ Check that the leg rest does not rotate.

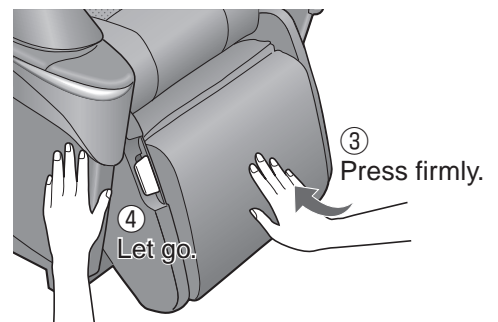
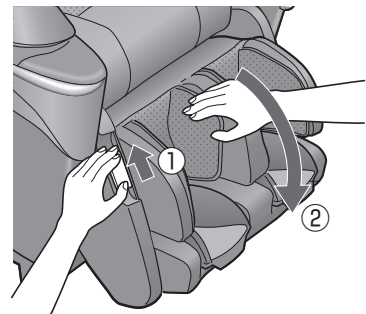

WARNING

- Sit on the unit after confirming there is no foreign matter between the parts of the unit. (Confirm that there are no foreign objects stuck in the comfort cushion, leg rest or hand & arm massage section.) Sit down and ensure that the leg rest is properly locked in place. Failure to observe this precaution may result in accident or injury.

Disconnecting the power

1 Slide the power switch to the "off" position.

2 Turn the lock switch key to the "lock" position and remove it.

WARNING

- After each massage, slide the power switch, which is located on the right side of the chair, to the "off" position and turn its lock switch to the "lock" position and remove the key and power plug.

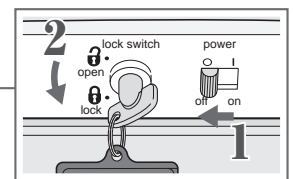
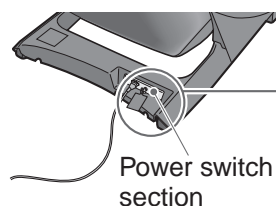

3 Remove the power plug from the electrical outlet.



4 The lock switch key must be stored out of the reach of children.

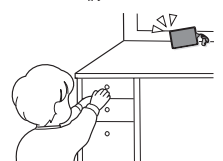

Timer function

The massage will complete automatically approximately 16 minutes after the starting the operation.

- Sole massage section will retract, and the leg rest will be lowered automatically so you can stand up safely.

Sole massage section will not retract all the way when the sole massage section is extended out, since it will hit the floor. Raise your legs to retract all the way.

- Backrest will not rise automatically.
- The massage heads move to the retracted position.

Backrest will rise by pressing  twice.



Interrupting the massage

Return the sole massage section to the original position and then press .

- The massage heads move to the retracted position.
- The leg rest lowers and the backrest raises automatically. (The backrest will move after the massage heads retract.)

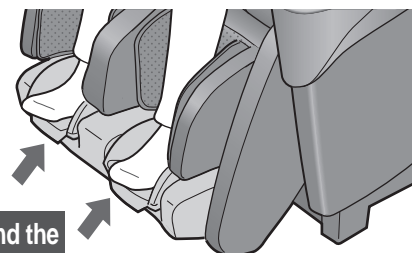

Lift your soles slightly and the sole massage section returns.

If you experience any problems

Press .

- All operations will stop immediately.
- Get off the unit carefully not to fall.

Cleaning and maintenance

Areas covered with synthetic leather

Wipe these areas with a soft, dry cloth.

- Never use chemicals such as thinner, benzene, alcohol, etc.
- When using the commercially available leather-care products (wipes), follow its instructions.
- If the synthetic leather is particularly dirty, wipe it in the following manner.
 - ① Soak a soft cloth in water or a 3% to 5% solution of mild detergent (such as dish detergent) and wring it out thoroughly.
 - ② Dab the surface with the moistened cloth.
 - ③ Rinse the cloth in water, wring it out thoroughly, and then wipe any remaining detergent from the surface.
 - ④ Wipe the surfaces with a soft, dry cloth.
 - ⑤ Allow to dry naturally.
- If it is difficult to remove dirt, soak a commercially available Melamine foam sponge in mild detergent (such as dish detergent) and wipe the unit with it.
- Do not use a hair dryer to dry the surface more quickly.
- Since colors may transfer from clothing to the synthetic leather surface, be careful when using the unit with clothing such as jeans or colored clothes.
- Do not allow these areas to come in contact with plastic for extended periods of time as this may lead to discoloration. Also, if you use any kind of lotion, gel or cream for your hair, place a towel or some other cover over the area of contact.



Plastic area

1 Wipe the unit with a cloth moistened with mild detergent (such as dish detergent) and thoroughly wring out the cloth.

- Never use chemicals such as thinner, benzene, alcohol, etc.

2 Wipe the unit with a cloth moistened with plain water and thoroughly wring out.

- Make sure to wring tightly before wiping the controller.

3 Allow the unit to dry naturally.



Seat fabric

1 Wipe the unit with a cloth moistened with mild detergent and thoroughly wring out.

- Never use chemicals such as thinner, benzine, alcohol, etc.



2 Use water or a mild detergent and brush on areas where the seat fabric is particularly soiled.

- Be careful not to brush the fabric too much to avoid damage.

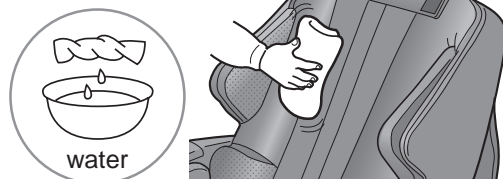

3 Wipe the unit with a cloth moistened with plain water and thoroughly wring out.

4 Allow the unit to dry naturally.

- Since color may transfer from clothing to the seat fabric, be careful when using the unit with clothing such as jeans or colored clothes.

Sole covers: can be removed and washed.

How to remove

- 1 Remove the front fastener.
- 2 Lift out the covers on either side from the front.
- 3 Hold the back and pull out.

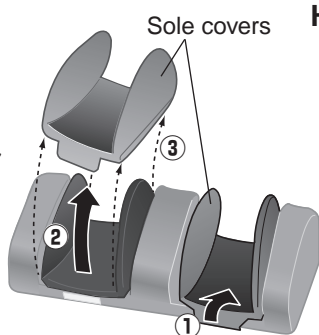

How to attach

- 1 Attach the back to the catch.
- 2 Attach the covers on either side.
- 3 Fasten the front fastener.

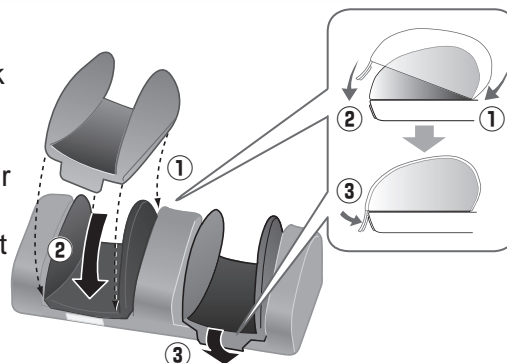

Precautions when washing

(Laundry information)



Hand washing

(please do not use a washing machine)

- Use a net when washing.

- 1 Soak in water cooler than 30 °C and wash by gently pressing.

Caution

- Never rub or wring while washing.
- Never use detergents with bleaching agents, as these cause the color to fade.
- Wash separately from other items, as the color leaches easily.



- 2 Rinse thoroughly.

- 3 Remove excess water by pressing gently.

Caution

- Never wring, as this damages the fabric and breaks the fibers.

- 4 Gently smooth out any wrinkles and hang up to dry.

Caution

- Never dry in the sun, as this causes the fabric to shrink or fade.
- Hang up to dry immediately, as the color bleeds onto other items easily.

Remove any wrinkles by ironing after washing.

(Precautions for ironing)

- Place a cloth over the top and iron at a medium heat no higher than 160 °C.

Dry cleaning

Ask your dry cleaner to take the following precautions during (oil type) dry cleaning to prevent damage to the fabric.

- Be sure to use a net.
- Perform soft washing and do not use a tumble dryer.

Moving the unit

Moving by lifting it with 2 or more persons

Move the unit with 2 or more people in front and back of the unit holding on the side of the leg rest and the groove on the back cover of the backrest.

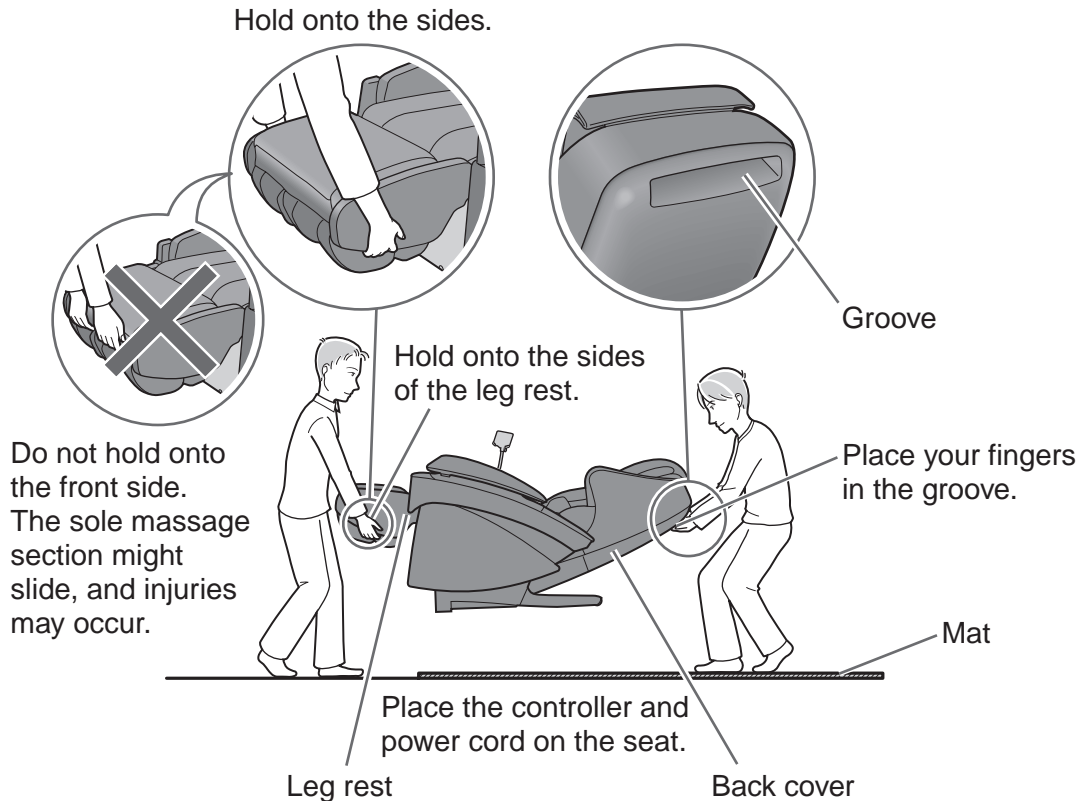

* You may damage the floor by dropping the unit if you do not hold it correctly. Never carry by the armrest, because it may get damaged.

To put the unit down on the floor

- Put the unit down slowly and carefully watch your step.
- Put down the leg rest by holding it with your hands until it has been set on the floor completely. If you release your hands before the leg rest is fully extended, the leg rest will forcefully return to the initial position.

Using the castors to move the unit

Move the unit by holding onto the side of the leg rest and using the castors.

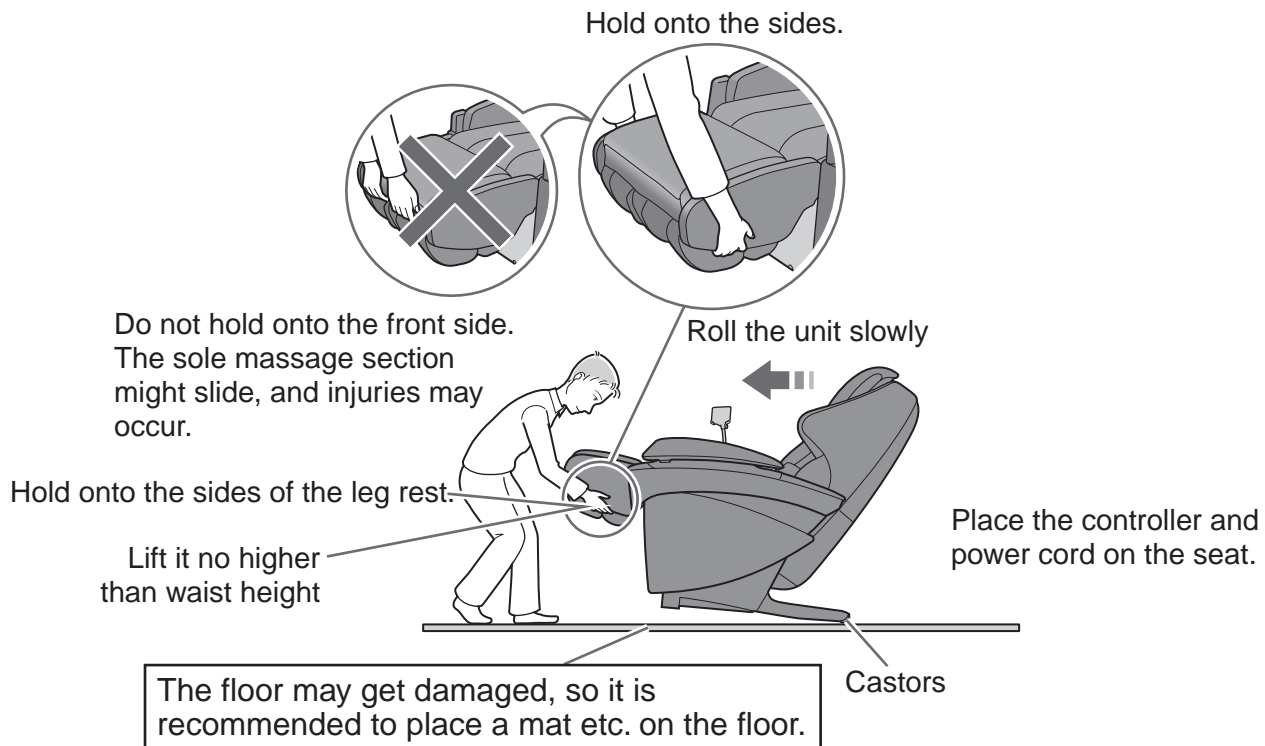

To put the unit down on the floor

- Put the unit down slowly and carefully watch your step.
- Put down the leg rest by holding it with your hands until it has been set on the floor completely. If you release your hands before the leg rest is fully extended, the leg rest will forcefully return to the initial position.

How to remove the armrest

It is easier to move with the armrest removed.

- 1** Remove the air plugs.
(See step 3 on page EN17.)
- 2** Remove the attachment screws.
(See step 2- ③ on page EN16.)
- 3** Slide the armrest forward and pull up with both hands.

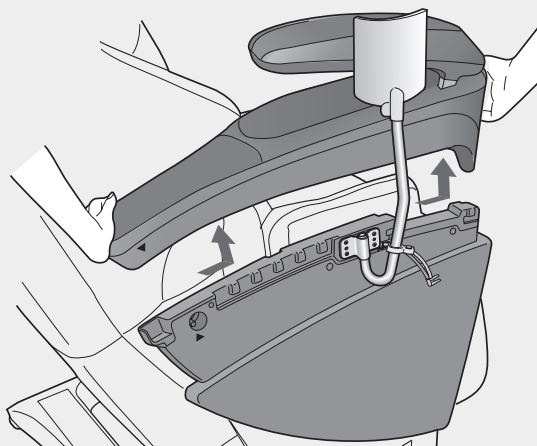

About the automatic course/action/voice guidance function

Overview of the automatic course * Time spent on "Finishing Touches" differs depending on your height and intensity setting.

| | 1 | 2 | 3 | 4 | 5 | 6 | 7 | 8 |
|---|---|--|---------------------------------------|---|--|-------------------------------------|------------------------------------|---------------------------------------|
| SWEDISH | Roll on neck, Knead, Swedish | Swedish on shoulders, Knead, Ultra knead | Neck stretch | Knead on lower back, Swedish | Pelvis stretch Leg stretch | Swedish on back | Chest stretch | Finishing touches* |
| DEEP | Roll on neck, Ultra knead, Knead | Knead on shoulders, Ultra-knead | Neck stretch | Knead on lower back, Ultra knead, Roll | Hip stretch Leg stretch | Ultra knead on back, Roll on neck | Chest stretch | Finishing touches* |
| SHIATSU | Roll on neck, Shiatsu | Knead on shoulders, Shiatsu, Ultra knead | Neck stretch | Shiatsu on lower back, Knead, Ultra knead | Hip stretch Leg stretch | Knead on back Chest stretch | Ultra knead on shoulders | Finishing touches* |
| STRETCH | Neck stretch Roll on neck | Chest stretch | Hip stretch Leg stretch | Neck stretch Roll on neck | Chest stretch Swedish on back | Hip stretch Leg stretch | Neck stretch Chest stretch | Hip stretch Leg stretch |
| NECK/SHOULDR | Roll on neck, Shiatsu, Knead, Ultra knead | Neck stretch | Ultra knead on shoulders, Knead, Roll | Chest stretch | Ultra knead on shoulders, Knead, Shiatsu | Neck/Shoulder Knead, Ultra knead | Neck stretch Finishing touches* | |
| LOWER BACK | Roll on lower back, Knead, Ultra knead | Knead on back, Ultra knead | Hip Stretch Leg Stretch | Knead on lower back, Shiatsu, Ultra knead | Finishing touches* | | | |
| ULTRA KNEAD About the DEMO course | Neck/Shoulder/ Back Ultra knead | Ultra knead on lower back | Back/Chest Ultra knead | Neck/Shoulder Ultra knead | Neck stretch | Shoulder to back Ultra knead | Chest/Hip/ Leg Stretch | Neck/HipStretch Finishing touches* |

About the action

(The figures are images of the respective operations.)

ULTRA KNEAD

Kneading action at small points.

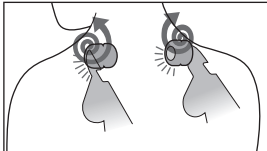

SHIATSU

Action compressing muscle knots vertically.

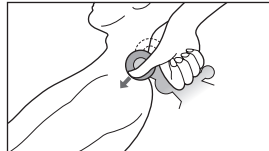

KNEAD

Deep kneading action.

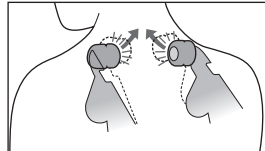

SWEDISH

Action of rubbing gently across a wide area.

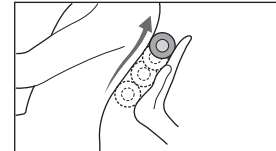

ROLL

Action to stretch an area.

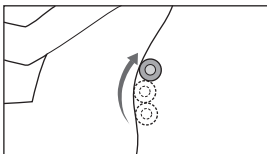

TAP

Tapping action for right and left alternately.

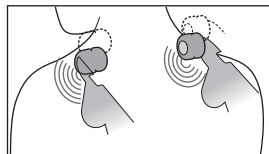

FULL BACK ROLL

Action stretching the body along the backbone.

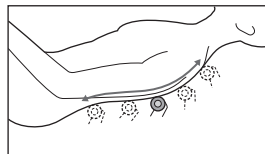

● The respective actions are suitable for specific body parts. Actions of Shiatsu for the "NECK" are different from of the actions for the "SHOULDER".

About the voice guidance function

This is a function which briefly explains the operation procedures and contents of the action.

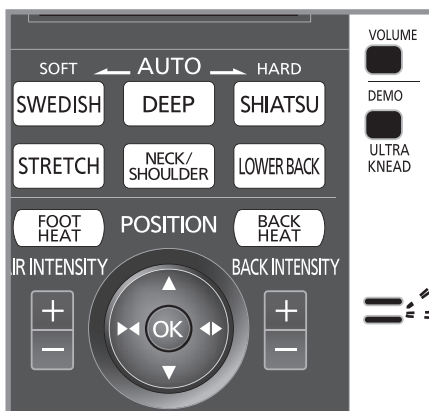

Seat yourself deeply in the chair, and adjust the position of the pillow.



Press the OK button if the position is OK.

Adjusting the voice guidance volume

Press  to shift the volume level by one up/down.

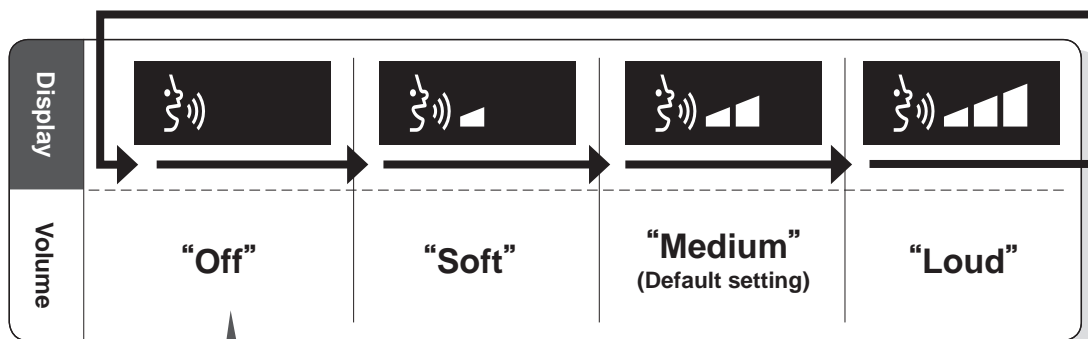

The single beep (when a button is pressed) and the triple beep (when the adjustable setting limit is reached) will always be audible.



● This can be used with the volume registered during the automatic course. ▶ See page EN30.

Q&A

Usage situation

Q Can I use the unit if I have an illness that requires regular medical attention?

A Consult your doctor before using this unit.

Massage is a form of stimulation by tactile pressure in which pressure is applied to the muscles to relax them and improve circulation. This may exacerbate some illnesses. Be sure to consult a doctor if you have an illness.

(See pages EN5-6.)

Usage method

Q Is it possible to massage only the upper body or legs?

A Yes.

Massaging only the upper body

Store the leg rest and raise the comfort cushion to expose the backrest and pillow.



Massaging only the legs

Use the leg & sole massage section with the comfort cushion on the backrest.

(For details on opening the leg & sole massage section, see page EN20.)

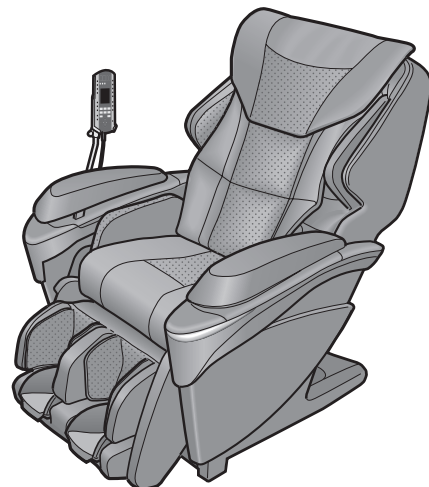

Body scanning*

Q How does body scanning work?

A The shoulder position is detected by the following mechanism.

- ① The massage heads rise up the back to the base of the neck, making a series of short beeps.
- ② The massage heads protrude.
(If the shoulder position is wrong, the massage heads move further up and repeat this step until they find the shoulders.)
- ③ The massage heads slowly lower to the shoulder position.
- ④ A tapping action is performed in the shoulder position for around 12 seconds.
 - Press **OK** to complete body scanning and start the massage, even during this tapping action.

* Body scanning = action of measuring the body.

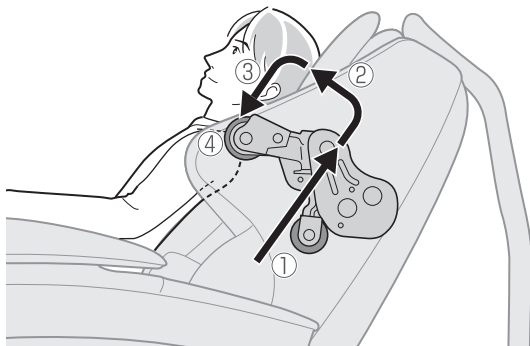

- Body scanning can be performed correctly for heights between approx. 140 cm (55.1 in.) and 185 cm (72.8 in.).

Q Can people shorter than 140 cm or taller than 185 cm still use it?

A Yes.
The following methods are recommended, as the correct shoulder position may not be found during body scanning.

<If shorter than 140 cm> <If taller than 185 cm>



Place a cushion on the seat and sit firmly.



Recline the backrest and slide your body down.

Q During body scanning or a massage, the buttons flashed, five short beeps sounded (⏏, ⏏ was displayed) and the operation stopped. What happened?

A Body scanning and the massages stop for safety reasons if the body cannot be detected for one of the following reasons:

- ① The user is not sitting.
- ② The head and/or back is not touching the backrest.
- ③ A cushion is placed against the backrest or the user is wearing thick clothing.

Sit firmly, lean gently back so that your head touches the pillow, press **⏏** and then press **⏏** to start again.
- ④ The comfort cushion is not raised.

Q The correct shoulder position cannot be found during body scanning. (The wrong position is used every time.)

A Correct body scanning may not be possible for some sitting positions (such as leaning forward.)

Adjust the shoulder position using the POSITION button. (See page EN27.)

For more correct scanning, sit firmly in the unit and lean back gently so that your head is touching the pillow (backrest).

Q&A (Continued)

Upper body massage

Q The automatic course is not strong enough even at the strongest setting or are too strong even at the weakest setting.

A Try the following methods.
<If the automatic course is not strong enough even at the strongest setting>

Recline the backrest. The extra body weight adds intensity to the massage.

<If the automatic course is too strong even at the weakest setting>

Place a piece of fabric or blanket between you and the backrest to decrease the sensation of the massage heads.

If you feel too strong at your lower back, you can also push the lower back air button to discharge some of the air in the lower back area. This decreases the sensation.

Q There is a delay in movement when adjusting the position.

A The chair may not move immediately depending on when the POSITION button is pushed.

(There may be a small time lag. This is not an abnormality.)

If long beeps sound when the button is pushed, this means that it is at the furthest position and cannot move any further.

Q The height (intensity) on the left feels different to that on the right. Is this OK?

A It is designed to differ in some cases. An alternating tapping mechanism is used to create a more natural sensation. The massage heads therefore do not move in unison in some massages. The height (intensity) on the left differs from that on the right in these massages. This is not a malfunction.

Hand & arm massages

Q The intensity in the left hand & arm differs from that in the right.

A Only one hand at a time is strongly massaged so that the massage can be immediately stopped using the other hand in the event of an abnormality or danger.

Q Red marks are left on the underside of my hands/arms after a hand & arm massage.

A Marks may remain on the hands and arms after use. These eventually fade and are not a problem.

Q Arm air pressure is applied more times on one side than on the other during the automatic courses.

A Changing settings such as intensity (back or air) or position can cause air pressure to be applied on one side more than on the other. This is not an abnormality.

- The air action works in connection with the back massage, so changing the settings can change the air action.

Operating sounds during air massage

Q A rattling sound occurs under the seat during the air massage. Is this a malfunction?

A This is an operating sound that is designed to occur during air massages. It is not a malfunction.

Reclining

Q The angle of the backrest, leg rest or armrest automatically changes at times.

A The angle automatically changes in the following cases.

- ① When automatic course, stretch action or manual operation are started.

The chair automatically reclines to the massage position.

The angle does not change if the chair is already reclined to the massage position or further.



- ② When  is pressed to end the massage.

The chair automatically returns to the upright position.

- Only the leg rest returns to the original position if the massage is completed according to the 16-minute timer.
- If  is pressed to end the massage, all operations immediately stop and the angle does not automatically change.



Leg rest

Q When storing the leg rest, the leg rests stop rotating when the leg rest rotation lock release lever is released while they are rotating.

A The leg rests are designed to stop partway for safety reasons.

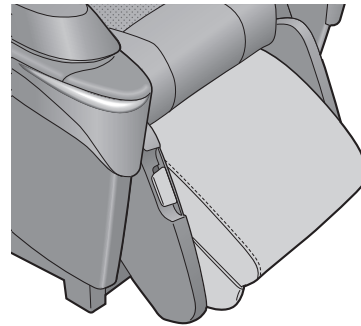

- If this happens, rotate them to the correct position.

Controller

Q The controller holder is unsteady.

A Tighten the controller holder fixing screw.

If the controller holder comes off, loosen the controller holder fixing screw, place the holder in and tighten the fixing screw again.

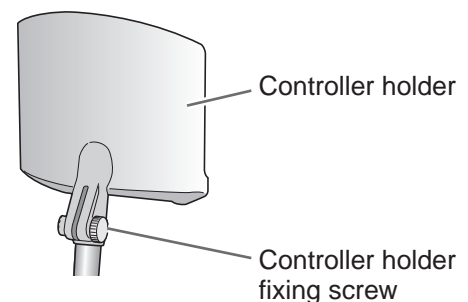

Q&A (Continued)

Other

Q The noise grows louder after using the chair for a long time.

A This may be a malfunction. Contact the nearest authorized service center for an inspection and repair.

Q Is there a timer function?

A Yes.

To prevent overuse, the massage automatically ends around 16 minutes after starting. When the timer ends, the leg rest automatically lowers and the massage heads are stored.

Press  to use again.

- Take a break of around 10 minutes after using for 16 minutes.
- Do not use more than twice (30 minutes) per day.

Q The leg & sole massage section doesn't get warm.

A The "Foot Heat" warms the toe portion of the cloth. Place feet so that they are firmly pressed against the "Heat" (heater) section.

Raise the leg & sole massage section during use so that soles of your feet touch this section to feel the heat from the heater section.



You can also place a blanket over your knees and lower legs to feel even warmer.

Q What precautions should I take to transport the unit when moving?

A Take the following precautions:

- Recline the backrest and raise the massage heads to around the center of the backrest. This moves the center of gravity to the center of the unit and makes it easier to move.
- Do not move the chair while a person is sitting in it.

① Press  to turn the power on.

② Press   to recline the backrest.

Hold down the two buttons until long beeps sound.

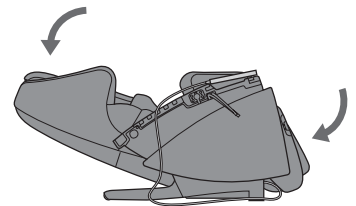

③ Select an automatic course when the power is on.

- The massage heads move. An error occurs and the movement stops when they reach the center of the backrest.

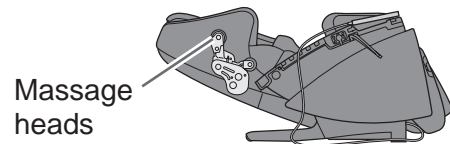

④ Press  to turn the power off.

- Be sure to press , as  automatically raises the backrest.

⑤ Turn the power switch "off" and remove the power plug (see page EN45.)

If you need to move the chair with the backrest upright, follow the steps below.



- (1) Follow steps ①→③→④ above and raise the massage heads to the center.
- (2) Turn the controller power on again, raise the backrest and press  to turn off the power.

- Handle the chair with care. If you do not have the original box, use packing materials to prevent damage or vibration.
- When packing, check that the power cord and controller cord are not wrapped around the main unit and take measures such as placing them on the seat with the controller to ensure that they do not scrape against the ground while moving.



Troubleshooting

Investigate the “Problem” and follow appropriate the “Cause and Remedy” below.

If the problem still exists after following the remedy, contact an authorized service center.

| Problem | Cause and Remedy |
|---|--|
| <p>The unit stops during operation.</p> | <p>For safety purposes, operation may stop when excessive force is applied to the unit. Turn off the power switch, wait 10 seconds and then switch it back on for operation.</p> |
| <p>It is not possible to recline the unit. The leg rest cannot be raised or lowered. (All the displays and buttons on the controller will flash and then turn off.)</p> | <p>If the unit encounters an obstacle or if excessive force is exerted on it during operation, in the interests of safety the unit will come to a stop. When all displays and buttons are flashing and the backrest or the leg rest has stopped, turn off the power of the unit once, turn “on” the power again after approximately 10 seconds, and then operate the unit.</p> |
| <p>The massage heads do not come up to the shoulder or neck.</p> | <p>If your head does not contact the pillow or your back does not contact the backrest, the shoulder position may be detected as lower than the actual position during the body scanning. Sit on the seat in the deepest position and put your head on the pillow, and then repeat the operations again from the start. See page EN26.</p> |
| <p>The height of the left and right massage heads is different.</p> | <p>An alternating tapping method is employed, which means that this phenomenon will naturally occur. There is nothing wrong with the unit. See page EN54.</p> |
| <p>“Heat” massage heads do not get warm.</p> | <ul style="list-style-type: none"> ●  is set to Off. ● Sense of warmth from the massage heads differs depending on your body shape, the massage body part, massage action, clothing, and room temperature. |
| <p>The “Foot Heat” does not get warm.</p> | <ul style="list-style-type: none"> ●  is set to Off. ● The “Foot Heat” warms the toe portion of the cloth. Sense of warmth from the “Heat” (heater) section differs depending on your body shape, the massage body part, massage action, clothing, and room temperature. Raise the leg/sole massage section during use so that soles of your feet touch this section to feel the heat from the heater section. You can also place a blanket over your knees and lower legs to feel even warmer. |
| <p>The “Heat” massage heads or “Foot Heat” do not cool down even after being turned off.</p> | <ul style="list-style-type: none"> ● Because of the structure of the heater, the “Heat” massage heads will feel warm for a while after heating due to the residual heat. ● Continuing to massage the same area even after turning off the “Heat” massage heads and the “Foot Heat” switch may increase the temperature felt. |
| <p>Reclining does not take place even though a massage is started in automatic course. (The seat does not automatically recline.)</p> | <p>Automatic reclining will not activate when the backrest is reclined to flat position more than massage position and leg rest is in upper position. See page EN55.</p> |
| <p>The backrest does not return to the upright position.</p> | <p>If the unit is stopped by automatic shut-off or by pressing , it will not return automatically. (To return from the reclined position to the original position, press  twice.)</p> |

Troubleshooting (Continued)

| Problem | Cause and Remedy |
|--|--|
| The unit will not operate at all. <ul style="list-style-type: none"> ● Upper body (neck to lower back) massage ● Lower body massage ● Hands and arms massage | <ul style="list-style-type: none"> ● The power plug has been disconnected. See page EN21. ● The power switch on the unit has not been turned on. ● An automatic courses button or manual operation button hasn't been pressed after pressing . |
| It is not possible to massage hands and arms. | <p>The air plug on the armrest is disconnected. See page EN17.</p> |
| Sometimes the power won't turn on when  is pressed again when a massage has finished. | <p>Approximately 5 seconds are required for program termination after a massage finishes. Wait at least 5 seconds once all movement has stopped before pressing .</p> |
| The unit has been damaged. | <p>To prevent accidents, be sure to contact an authorized service center.</p> |
| The power cord or power plug is abnormally hot. | |

Sounds and sensations of the unit

The following sounds and sensations occur while using the unit. However, they occur due to the construction of the unit and are perfectly normal.

- Sounds and feels like the massage heads are straining to get over wrinkles in the cloth
- Operating sounds of the kneading or tapping actions
- Creaking sound when the massage heads are in operation
- Operating sounds when the massage heads move up or down
- Sounds of the belt rotating
- Motor sounds
- Sounds when the massage heads change from "push" to "pull"
- Sound when sitting down
- Sound of the comfort cushion moving over the armrest when the seat is reclining
- Rubbing sound of the massage heads on the seat fabric
- Sound of discharging air
- Sounds when air pressure is applied
- Rattling sound of the leg rest
- Sounds of the pump beneath the seat
- Sounds of the valve beneath the seat
- Clunking sound during leg stretch or operation
- Sounds of air moving
- Sounds of the foot massager sliding

If these sounds have grown louder, there may be a malfunction.

- Contact the nearest authorized service center for inspection and repair.

WARNING

- Do not attempt to open or disassemble any part of the unit. Only use an authorized Panasonic servicer to fix your unit.

WARNING

- Never operate the unit if it has a damaged power cord or plug. Return the unit to the nearest authorized service center if it is not working properly, if it has been dropped or damaged, or if it has been immersed in water.
- If the massager functions abnormally, immediately turn off the power and have the massager checked by an authorized service center.

Error display

Contents of the error will be displayed in the remaining time display area when an error occurs during the operation.

Remaining time display

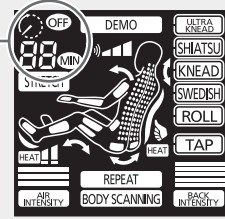

<Example of error display>

● For the error "U10"

U, 10 will flash alternately.

Error display

U 10

F 11 F 12

F 03 F 04

F 05 F 06

F 18 F 33

F 36 F 37

F 38

F 14 F 15

F 16 F 17

F 34 F 35

F 73 F 74

F 75 F 76

Contents

For safety reasons, operation will terminate automatically when it cannot detect if someone is seated. If this error occurs even if you are seated, press , sit back all the way to the backrest, and operate from the start again.

Operation is terminated because there is a problem with internal communication.

Operation is terminated because there is a problem with the massage mechanism.

Operation except for the massage mechanism is terminated because there is a problem with the reclining mechanism or the raise/lowering mechanism of the leg rest.

Please contact an authorized service center. (See the warranty card for the contact number.*) Service and maintenance will be carried out smoother if the error number is communicated when contacting.

* Only for USA and Puerto Rico

Panasonic Corporation of North America

Two Riverfront Plaza, Newark, NJ 07102-5490

1-800-338-0552 (USA only) for questions and comments

1-877-PANAFIX (USA only) for massage chairs customer service

<http://www.panasonic.com/massage>

Panasonic Canada Inc.

5770 Ambler Drive

Mississauga, ON L4W 2T3

1-800-561-5505

<http://www.panasonic.com>

© **Panasonic Corporation 2014**

P9310MA73201

Issued date: 2014-04-01

Fecha de publicación: 2014-04-01

Date de parution : 2014-04-01

Printed in China

Impreso en China

Imprimé en Chine

Free Manuals Download Website

<http://myh66.com>

<http://usermanuals.us>

<http://www.somanuals.com>

<http://www.4manuals.cc>

<http://www.manual-lib.com>

<http://www.404manual.com>

<http://www.luxmanual.com>

<http://aubethermostatmanual.com>

Golf course search by state

<http://golfingnear.com>

Email search by domain

<http://emailbydomain.com>

Auto manuals search

<http://auto.somanuals.com>

TV manuals search

<http://tv.somanuals.com>