

Panasonic

Removable Full Front MP3 WMA CD Player/Receiver with CD Changer Control

CQ-C5400/C5300W

Removable Full Front CD Player/Receiver with CD Changer Control

CQ-C5100W



- Please read these instructions carefully before using this product and save this manual for future use.
- 使用本產品前，請務必閱讀這些說明並將本說明書保管好以備將來之用。

Safety Information

WARNING:

TO REDUCE THE RISK OF FIRE OR ELECTRIC SHOCK, DO NOT EXPOSE THIS PRODUCT TO RAIN OR MOISTURE.

TO REDUCE THE RISK OF FIRE OR ELECTRIC SHOCK, AND ANNOYING INTERFERENCE, USE ONLY THE INCLUDED COMPONENTS.

CAUTION:

THIS PRODUCT IS A CLASS I LASER PRODUCT.

USE OF CONTROLS OR ADJUSTMENTS OR PERFORMANCE OF PROCEDURES OTHER THAN THOSE SPECIFIED HEREIN MAY RESULT IN HAZARDOUS RADIATION EXPOSURE.

DO NOT OPEN COVERS AND DO NOT REPAIR BY YOURSELF. REFER SERVICING TO QUALIFIED PERSONNEL.

Contents

Precautions.....	Page 8
Accessories.....	9
Features	12
Before Reading these Instructions	13
Control Reference Guide	14
Preparation	16
Clock Setting.....	17
General.....	24
Radio	28
Before Disc Playback	30
CD Player	31
MP3/WMA Player.....	32
CD Changer Control	36
Audio Settings.....	38
Function Settings	42
Troubleshooting.....	44
Notes on Discs.....	50
Anti-Theft System	51
Installation Guide	52
Electrical Connections.....	58
Specifications.....	62

Panasonic welcomes you to our ever growing family of electronic product owners. We know that this product will bring you many hours of enjoyment. Our reputation is built on precise electronic and mechanical engineering, manufactured with carefully selected components and assembled by people who take pride in their work. Once you discover the quality, reliability, and value we have built into this product, you too will be proud to be a member of our family.

CQ-C5400/C5300W

Removable Full Front MP3 WMA CD Player/Receiver with CD Changer Control

CQ-C5100W

Removable Full Front CD Player/Receiver with CD Changer Control

Note:

- Please refer to page 13 for information on differences in each model.

Precautions

When Driving

Keep the volume level low enough to be aware of road and traffic conditions.

When Washing Your Car

Do not expose the product, including the speakers and CDs, to water or excessive moisture. This could cause electrical shorts, fire, or other damage.

When Parked

Parking in direct sunlight can produce very high temperatures inside your car. Give the interior a chance to cool down before switching the unit on.

Use the Proper Power Supply

This product is designed to operate with a 12 V DC, negative ground battery system.

Disc Mechanism

Do not insert coins or any small objects. Keep screwdrivers and other metallic objects away from the disc mechanism and disc. The face plate may close automatically depending on the situation. Be careful not to catch your fingers in the plate.

Service

This product is made of precision parts. Do not attempt to disassemble or adjust any parts. For repair, please consult your shop where you purchased the product.



For Installation

This product should be installed in a horizontal position with the front end up at a convenient angle, but not more than 30°.

Note:

- The preset memory is cleared to return to the original factory setting when the power connector or battery is disconnected.

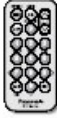
Accessories

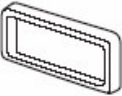
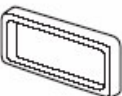
Item	Diagram	Q'ty
CQ-C5400W CQ-C5300W Remote Control Unit (YEFX9992663)		1
CQ-C5100W Remote Control Unit (YEFX9992013)		1
Lithium Battery <CR2025>		1
Operating Instruction (YEFM284149)		1
Mounting Collar (YEFX0216165)		1
CQ-C5400W Trim Plate (YEFC05606)		1
CQ-C5300W CQ-C5100W Trim Plate (YEFC05608)		1

Item	Diagram	Q'ty
Screw Kit (YEP0FZ3315)		
• Hex. Nut (5 mmφ)		1
• Tapping Screw (5 mmφ×16 mm)		1
• Mounting Bolt (5 mmφ)		1
• Lock Cancel Plate		2
Rear Support Strap (YEFG04024)		1
Removable Face Plate Case (YEFA131839)		1
Power Connector (YEAJ02877)		1

Note:

- The number in parenthesis underneath each accessory part name is the part number for maintenance and service.
- Accessories and their parts numbers are subject to modification without prior notice due to improvements.
- Mounting collar ① and trim plate ⑦ are mounted on the main unit at shipment (page 52).

Features

MP3/WMA Playback from CD-R/RW

CQ-C5400W **CQ-C5300W**

You can play your MP3/WMA (Windows Media Audio) files as well as regular CDs. With up to 10 to 12 times* the capacity of a conventional CD, a single MP3/WMA-encoded disc can keep you entertained throughout your entire journey.

*Depending on bit rate.

SQ7 (7 bands Sound Quality)

SQ is a function that can call up various sound types at the touch of button in accordance with your listening music type.

At SQ7, SQ presets P2 to P6 can also be finely adjusted as desired (page 38).

HPF (High Pass Filter)/LPF(Low Pass Filter)

Genuine subwoofer system achieved thanks to HPF (High Pass Filter) and LPF (Low Pass Filter)

Electronic Switch Front Panel

The front panel opens and closes automatically by pressing a button once.

CD Changer Control

You can connect the optional CD changer unit. For details, refer to the operating instructions on the CD changer unit.

Large-sized Volume Control

A large-sized rotary volume control that looks like one belonging to a Hi-Fi audio system is featured.

System Upgrade

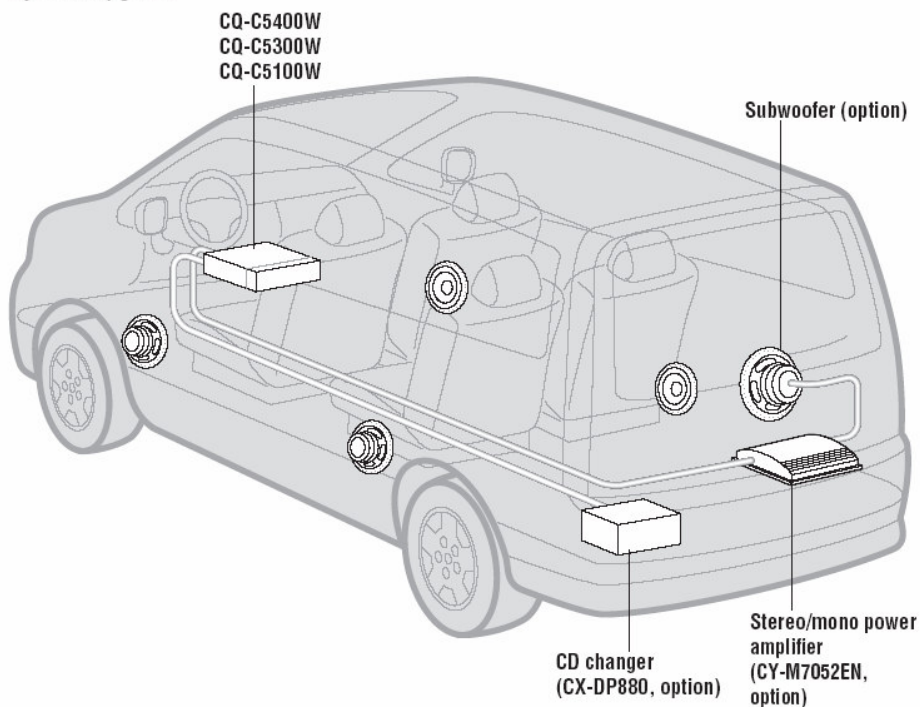

Before Reading these Instructions

- This operating instruction manual applies to the following models. The differences among these models are mentioned below.
- All illustrations represent model CQ-C5400W unless otherwise specified.

Models	CQ-C5400W	CQ-C5300W	CQ-C5100W
Features			
MP3/WMA playback	Yes	Yes	None
CD text display	Yes	Yes	None
AUX-IN	Yes	Yes	None
Pre-amp output voltage	5 V	2.5 V	2.5 V
Subwoofer output voltage	5 V	2.5 V	2.5 V
Direct track/file/folder/disc operation on the remote control unit	Yes	Yes	None
Remote control unit	Remote control unit with ten numbers keys	Remote control unit with ten numbers keys	Remote control unit without ten numbers keys
Face color/trim plate	Silver	Chrome black	Chrome black

 This can only be controlled through **the main unit.**

 This can only be controlled through **the remote control unit.**

Operations with neither mark can be performed either by the main unit or the remote control unit.

CQ-C5400W Indicates features applicable to CQ-C5400W only.

CQ-C5300W CQ-C5300W only.

CQ-C5100W CQ-C5100W only.

Control Reference Guide (remote control unit)

CQ-C5400W

CQ-C5300W

- This instruction manual explains operations for use with the buttons on the main unit (different operation excluded).
- Buttons of the remote control function in the same way as the controls on the main unit of the reference page.
- Point the remote control unit at the sensor (page 24).

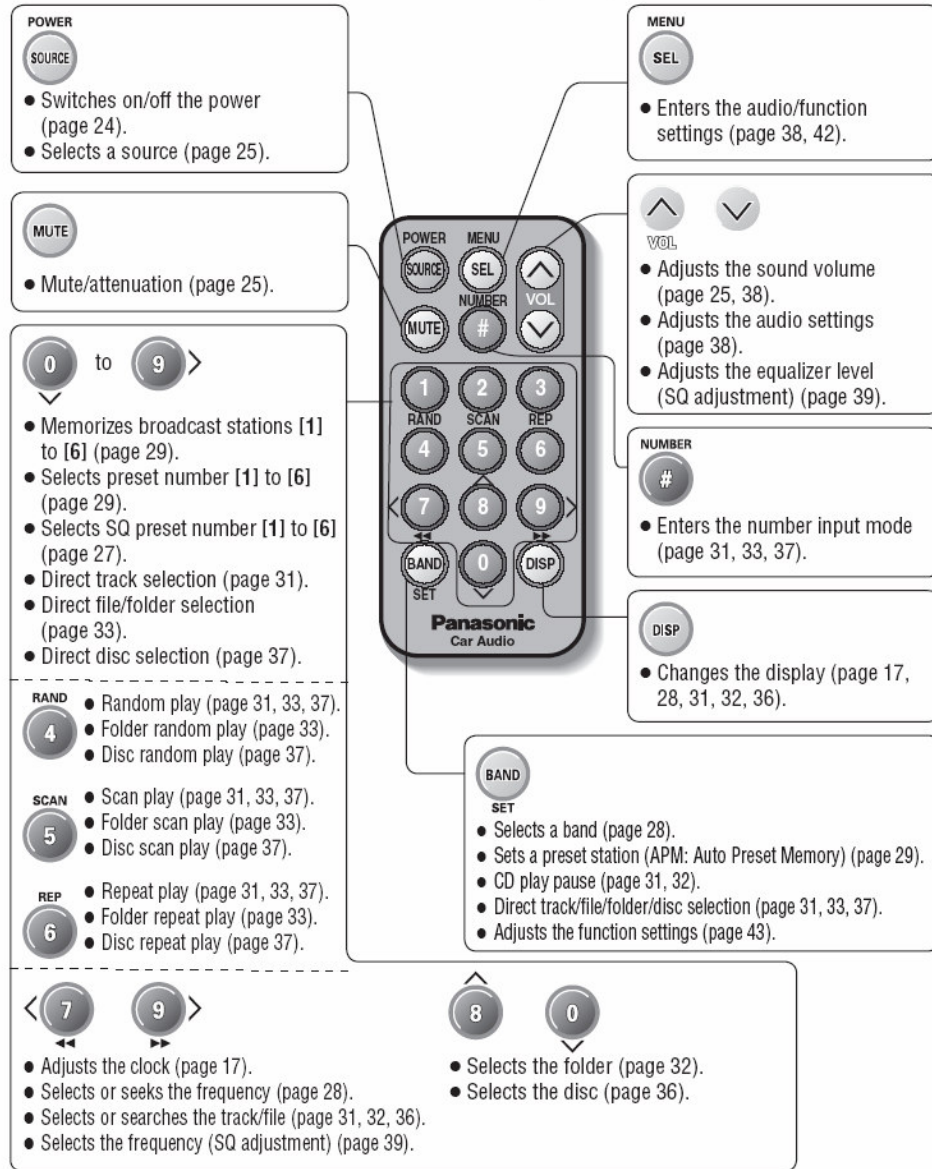

CQ-C5100W

- This instruction manual explains operations for use with the buttons on the main unit (different operation excluded).
- Buttons of the remote control function in the same way as the controls on the main unit of the reference page.
- Point the remote control unit at the sensor (page 24).

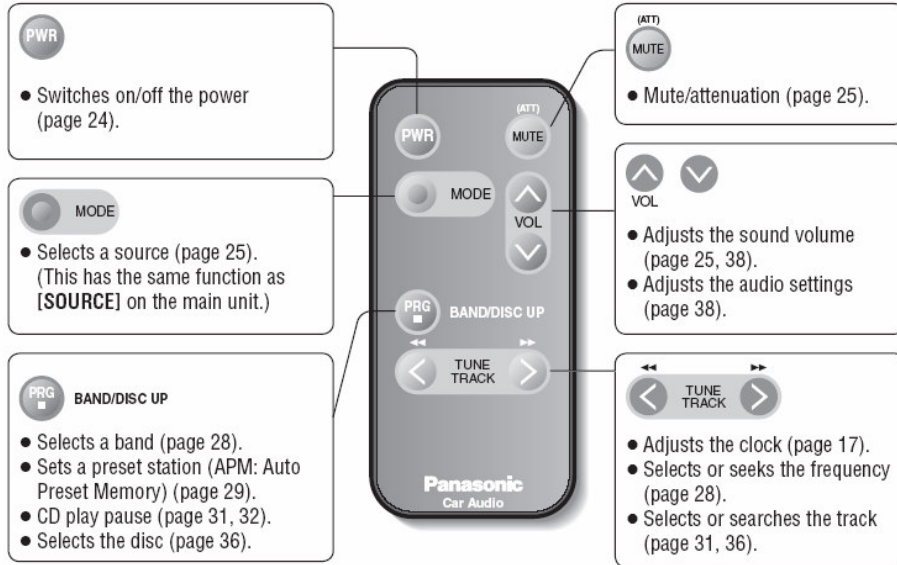

CQ-C5100W

Operations below cannot be controlled by the remote control unit (included).

- Random play
- Disc random play
- Scan play
- Disc scan play
- Repeat play
- Disc repeat play
- SQ adjustment
- Changes the display
- Enters/adjusts the audio/function settings

Preparation

Remote Control Unit

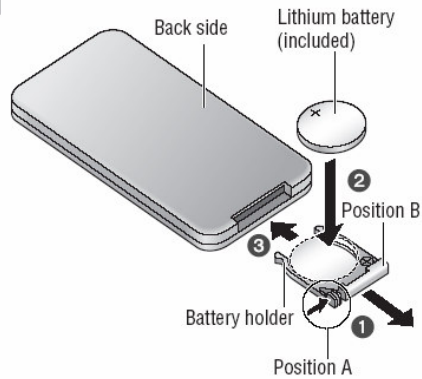

Battery Installation

- 1 **Remove the battery holder.**
Pull the holder out at position B while pushing position A as indicated.
- 2 **Install the battery on the battery holder.**
- 3 **Insert the battery holder back into its original position.**

Battery Notes

- Battery type: Panasonic lithium battery (CR2025) (included)
- Battery life: Approximately 6 months under normal use (at room temperature)

Caution:

- Improper use of the battery may cause overheating, an explosion or ignition, resulting in injury or a fire.
- Remove and dispose of an old battery immediately.
- Do not disassemble or short the battery. Do not throw a battery into a fire.
- Keep the battery away from children to avoid the risk of accidents.
- Follow local regulations when disposing of the battery.

Subwoofer

Preparation:

- Connect the subwoofer (option) (page 61).

Subwoofer level setting:

- You can change the subwoofer level (page 40).

Subwoofer low pass filter setting:

- You can select the upper limit frequency of the sound from subwoofer (page 40).

Clock Setting

The 24-hour system is used for the clock.

- Turn your car's ignition key to the ACC or ON position.
- Press [SOURCE] (PWR).
- When the power is switched on for the first time, a demonstration appears on the display. Press [DISP] (display) to change to regular mode (page 24).

1 Press [DISP] (display).



2 Press and hold [DISP] (display) again for more than 2 seconds.



Hours:

3 Press [<] or [>].



4 Press [DISP] (display).



Minutes:

5 Press [<] or [>].



6 Press [DISP] (display).



Note:

- "ADJUST" is displayed before adjusting the clock.
- Press and hold [<] or [>] to change numbers rapidly.

Display Change

Press [DISP] (display).

When the power is off:



General

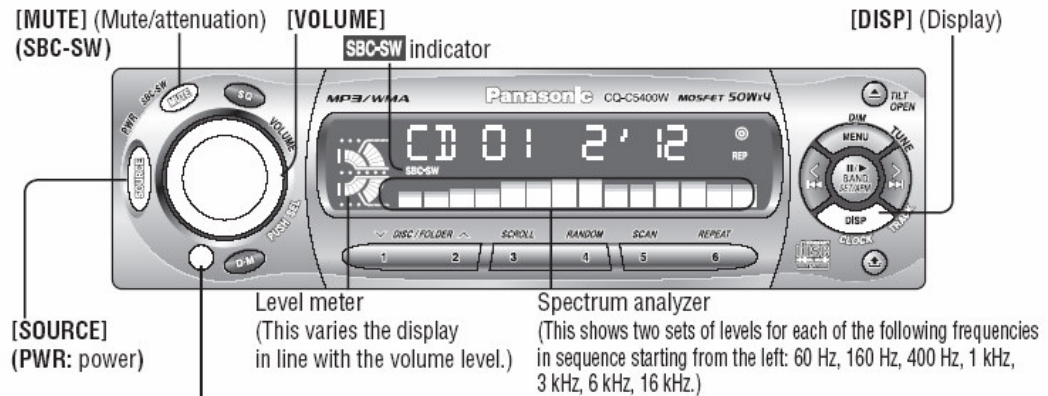

Point the remote control unit at the remote control signal sensor.

Power

Turn your car's ignition key to the ACC or ON position.



ON: Press [SOURCE] (PWR).

WELCOME

OFF: Press [SOURCE] (PWR) again and hold until you hear a beep (about 1 second), then release it.

CQ-C5400W CQ-C5300W

Press [SOURCE] (POWER) again and hold for more than 1 seconds.

CQ-C5100W

Press [PWR] again.

Demonstration:

When the power is switched on for the first time, a demonstration appears on the display. Press [DISP] (display) to change to regular mode.

HELLO

← Scrolling

Note:

- To display the demonstration again, press and hold [SOURCE] for more than 4 seconds when turning power on.

Note:

- After turning off the ignition key, a security message is displayed, and the panel removable alarm that reminds you to take the panel is activated. (When security function is set on to on, page 42)

Source

Press [SOURCE] to change the source.

CQ-C5400W **CQ-C5300W**

Radio (page 28)

RADIO

CD player (page 31)

CD

or

MP3/WMA player (page 32)

MP3/WMA

When a MP3/WMA data disc is in the player.

CD changer control (page 36)

CHANGER

When an optional CD changer is connected.

AUX (page 59)

AUX

CQ-C5100W

Radio (page 28)

RADIO

CD player (page 31)

CD

CD changer control (page 36)

CHANGER

When an optional CD changer is connected.

Volume

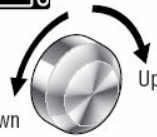

[VOL ^]: Up
[VOL v]: Down

Down

Up

VOLUME 13

Setting range: 0 to 40
(default: 13)

Note:

- The volume level can be set independently for each source (for radio, one volume setting for AM, one volume setting for all FM).

Mute/Attenuation **MUTE**

ON: Press [MUTE]. (**MUTE** lights.)

OFF: Press [MUTE] again.

You can select mute or attenuation (page 42).

MUTE

No sounds. (default)

ATT

Decrease the volume by 10 steps.

Rear Speakers as Sub-Woofer

(Super Bass Control Subwoofer/SBC-SW) **SBC-SW**

You can utilize the rear speaker connected to the built-in amplifier as Sub-Woofer that output only bass. (default: OFF)

Press and hold [MUTE] (**SBC-SW**) for more than 2 seconds.

SBCSW OFF

OFF
(default)

SBCSW ON

ON
(**SBC-SW** lights.)

Note:

- When ON has been selected, the settings resulting from the adjustments performed at the subwoofer level and subwoofer low pass filter settings are reflected in the output.
- Depending on the speakers used and the type of music played, it may not be possible to achieve a satisfactory effect.

CQ-C5400/5300/5100W

General (continued)

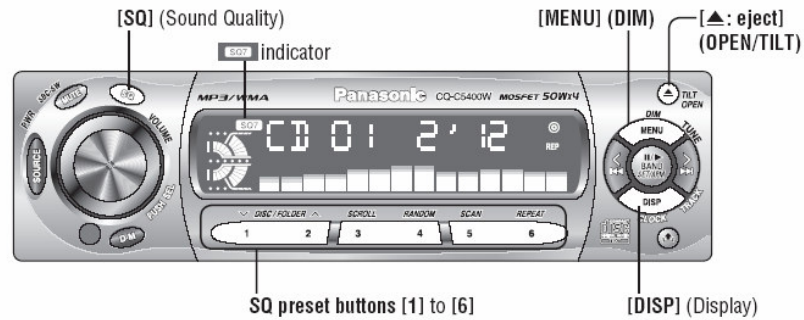

Open the Front Panel



Press [▲: eject] (OPEN).

Note:

- If nothing is changed for 20 seconds, the original panel position will be recovered.

Close the Front Panel



Press [▲: eject] (OPEN) again.

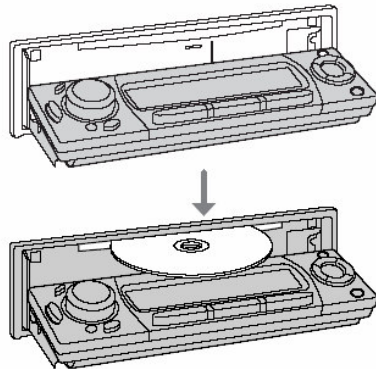

- If [▲: eject] (OPEN) is pressed when a disc is in the player, the front panel opens and the disc is ejected automatically. If no operation takes place for 20 seconds, the disc is automatically retracted into the main unit.

Caution:

- Do not pinch your finger or hand in the front panel when the panel is in motion.

Panel Angle (Tilt)



Press and hold [▲: eject] (TILT) until you hear a beep (about 1 second) from the speaker output, and "TILT" is displayed. And then release it.

Set it to the position at which it is easy to read what is on the display.

Each time the above operation is repeated, the panel angle changes in the sequence shown below.

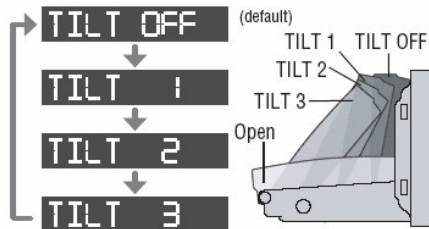

Note:

- The position which has been set using TILT will be retained even when the operations below are performed.
 - OPEN/CLOSE
 - Power on/off

SQ (Sound Quality)

SQ is a function that can call up various sound types at the touch of button in accordance with your listening music type.

At SQ7, SQ presets P2 to P6 can also be finely adjusted to suit the acoustic characteristics inside the car and the user's preference (page 38).

Press [SQ] to select a sound types  as follows.

 lights (except SQ-FLAT).

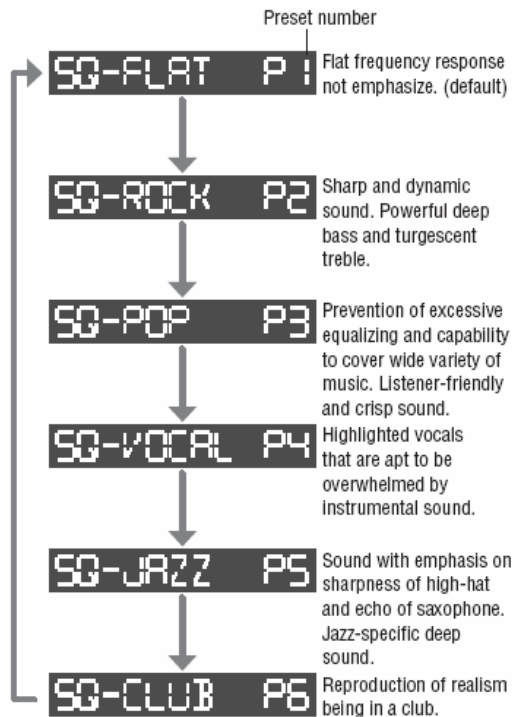

Press [DISP] (display) to return to the regular mode.

Note:

- If no operation takes place for more than 5 seconds, the display returns to the regular mode.
- After pressing [SQ] on the main unit, you can also select a sound type by pressing the preset buttons [1] to [6].
- Setting of SQ, bass/treble and volume are influenced one another. If the influence mentioned above causes distortion to the audio signal, readjust bass/treble or volume (page 38).

Dimmer



Press and hold [MENU] (DIM) for more than 2 seconds to change dimmer level setting as follows.



Radio

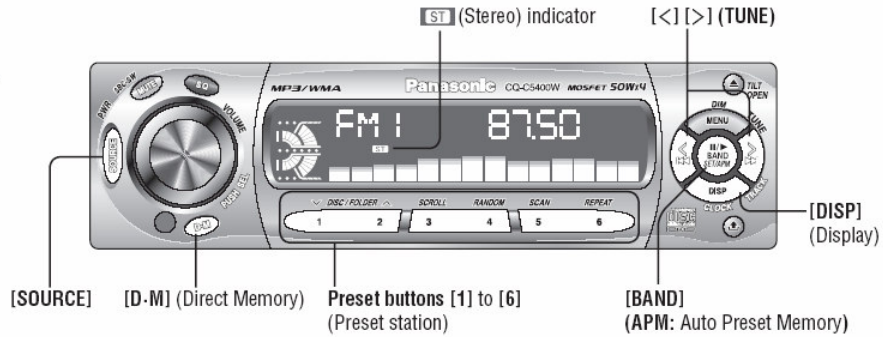

1 Radio Mode

Press [SOURCE] to select the radio mode.

Radio mode display



2 Band

Press [BAND].



3 Tuning

[>]: Higher frequency

[<]: Lower frequency

Press and hold [<] or [>] for more than 0.5 seconds, then release. Seeking will start.

Display Change

Press [DISP] (display).

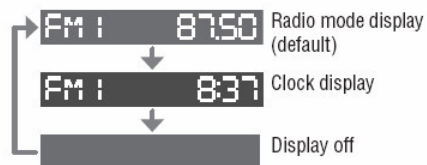

Direct Memory (D-M)



This is a useful function that can call broadcast stations directly during playback in other modes (CD, CD Changer, etc.), even when the power is off.

Your favorite radio station can be memorized in [D-M] (direct memory).
Default: FM 87.50 MHz

Memorize

- 1 Select a band and frequency.
- 2 Press and hold [D-M] for more than 2 seconds.
 - Frequency is saved in the memory.

Note:

- New stations overwrite existing saved stations after following this procedure.

Recalling the Direct Memory

Press [D-M].

Direct Memory mode
Press [D-M] again to cancel.

Station Preset

Up to 6 stations can be stored in each of the FM1, FM2, FM3 and AM band selections.

Caution:

- To ensure safety, never attempt to preset stations while you are driving.

Auto Preset Memory (APM)

Automatically save stations with good reception in the preset memory.

- 1 Select a band (previous page).
- 2 Press and hold [BAND] (APM: Auto Preset Memory) for more than 2 seconds.
 - The 6 stations with good reception will be automatically saved in the memory under preset number 1 to 6.
 - Once set, the preset stations are sequentially scanned for 5 seconds each (scanning).

Manual Preset Memory

Manually save a station in the preset memory.

- 1 Select a band and frequency (previous page).
- 2 Press and hold one of the buttons from [1] to [6] until the display blinks once.

Preset number

Note:

- To stop scanning, press one of the buttons from [1] to [6].
- New stations overwrite existing saved stations after this procedure.

Preset Station Calling

- 1 Select a band (previous page).
- 2 Press one of the preset buttons from [1] to [6].

CQ-C5400/5300/5100W

29

Before Disc Playback CQ-C5100W cannot play MP3/WMA files.

Available Discs

■ CD-DA



(CD-TEXT is only for CQ-C5400W/CQ-C5300W)

■ MP3/WMA **CQ-C5400W** **CQ-C5300W**



Caution:

- 8 cm CD is not available for this unit, so do not insert it.
- Do not use irregularly shaped discs.
- Do not use discs that have a seal or label attached.
- To avoid damaging the front panel, do not push it down or place objects on it while it is open.
- Do not pinch your finger or hand in the front panel when the panel is in motion.
- Do not insert foreign objects into the disc slot.
- Do not insert a disc when (disc) indicator lights.

Note:

- The power will be turned on automatically when a disc is loaded.
- A disc which has both CD-DA data and MP3/WMA data on it may not be reproduced normally. (For example, it may be reproduced without sound.)
- Refer to the section on "Notes on MP3/WMA" (page 34) and "Notes on Discs" (page 50).

The instructions on this page are followed for both CD-DA playback and MP3/WMA playback.

Disc Insert



- 1 Press [**▲**: eject] (OPEN).
If there is a disc loaded, the disc will be ejected.

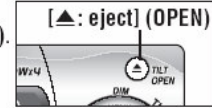

- 2 Insert a disc.

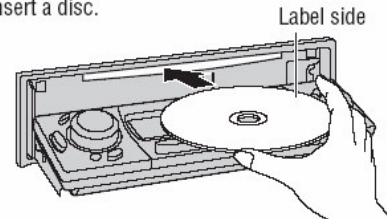

When placing a disc into or taking a disc out from the main unit, hold it as shown in the figure, and refrain from putting any of your fingers into the disc's center hole.

Note:

- It may take some time to start playing.
- Playback will start automatically after recognizing the data of the loading disc.

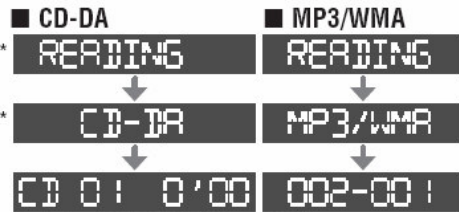

When CD is in the Player

Press [**SOURCE**] to select the CD (MP3/WMA) player mode and playback starts.



Disc Eject



- 1 Press [**▲**: eject].
The disc will be ejected after the front panel fully opens.
- 2 Take a disc.
- 3 Press [**▲**: eject] again to close.

Note:

- If no operation takes place within 20 seconds or so after the panel has opened, the panel will close automatically.

CD Player

Do not watch the scroll display while driving.
(Only for CQ-C5400W/CQ-C5300W)

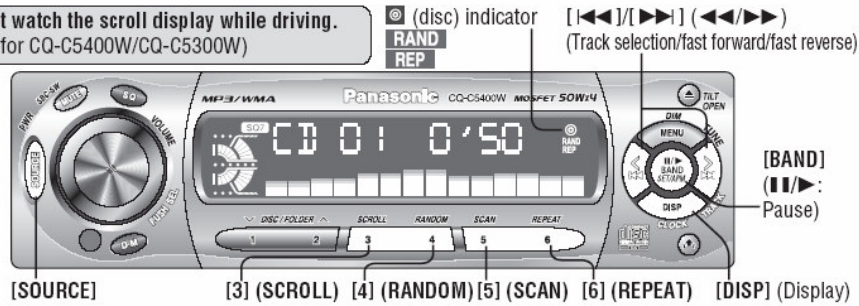

Display Change

Press [DISP] (display).

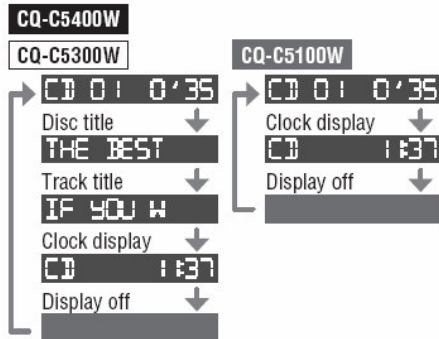

- Note:**
- "NO TEXT" is displayed when there is no information on the disc.
 - Press [3] (SCROLL) to have another circle scroll while a title is displayed. If the number of displayed characters is 8 or less, the characters do not scroll.
- (only for CQ-C5400W/CQ-C5300W)

Track Selection

- [>>>]: Next track
- [<<<]: Beginning of the current track
For the previous track, press twice.

Fast Forward/Fast Reverse

Press and hold
[>>>] (>>>): Fast forward
[<<<] (<<<): Fast reverse
Release to resume the playback.

Pause

Press [||>].
Press [||>] again to cancel.

Random Play [RAND]

All available tracks are played in a random sequence.
Press [4] (RANDOM). ([RAND] lights.)
Press [4] (RANDOM) again to cancel.

Scan Play

The first 10 seconds of each track is played in sequence.
Press [5] (SCAN).

Repeat Play [REP]

The current track is repeated.
Press [6] (REPEAT). ([REP] lights.)
Press [6] (REPEAT) again to cancel.

Direct Track Selection

- Example: track number 10
- 1 Press [#].
 - 2 Press [1] [0].
 - 3 Press [BAND] (SET).

- Note:**
- To suspend direct selection, press [DISP] (display) or [#].
 - Random, scan and repeat play are canceled once [#] is pressed.

MP3/WMA Player

CQ-C5400W CQ-C5300W

Do not watch the scroll display while driving.

(disc) indicator
FOLDER RAND
REP

[<<<]/[>>>] (<<</>>>)
(File selection/fast forward/
fast reverse)

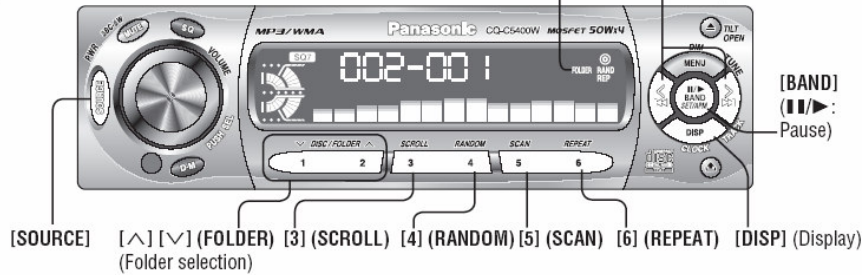

Display Change

Press [DISP] (display).

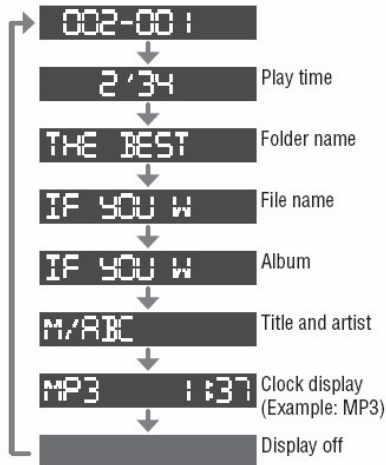

Note:

- "NO TEXT" is displayed when there is no information on the disc.
- Press [3] (SCROLL) to have another circle scroll while a title is displayed. If the number of displayed characters is 8 or less, the characters do not scroll.

Folder Selection

[^]: Next folder
[v]: Previous folder

File Selection

[>>>]: Next file
[<<<]: Beginning of the current file
For the previous file, press twice.

Fast Forward/Fast Reverse

Press and hold
[>>>] (>>>): Fast forward
[<<<] (<<<): Fast reverse
Release to resume the playback.

Pause

Press [||>].
Press [||>] again to cancel.

Random Play **RAND**

All the available files are played in a random sequence.

Press [4] (**RANDOM**). (**RAND** lights.)

Press [4] (**RANDOM**) again to cancel.

Folder Random Play **FOLDER RAND**

All the files on the current folder are played in a random sequence.

Press and hold [4] (**RANDOM**) for more than 2 seconds. (**FOLDER RAND** lights.)

Press and hold [4] (**RANDOM**) again for more than 2 seconds to cancel.

Scan Play

The first 10 seconds of each files is played in sequence.

Press [5] (**SCAN**).



Press [5] (**SCAN**) again to cancel.

Folder Scan Play

From the next folder, the first 10 seconds of the first file on each folder is played in sequence.

Press and hold [5] (**SCAN**) for more than 2 seconds.



Press and hold [5] (**SCAN**) again for more than 2 seconds to cancel.

Repeat Play **REP**

The current file is repeated.

Press [6] (**REPEAT**). (**REP** lights.)

Press [6] (**REPEAT**) again to cancel.

Folder Repeat Play **FOLDER REP**

The current folder is repeated.

Press and hold [6] (**REPEAT**) for more than 2 seconds. (**FOLDER REP** lights.)

Press and hold [6] (**REPEAT**) again for more than 2 seconds to cancel.

Direct File Selection



Example: file number 10

① Press [#].

FILE _ _ _

② Press [1] [0].



③ Press [BAND] (SET).

FILE _ 10



Direct Folder Selection

Example: folder number 10

① Press [#] twice.

FLDR _ _ _

② Press [1] [0].



③ Press [BAND] (SET).

FLDR _ 10

Note:

- To suspend direct selection, press [DISP] (display).
- Random, scan and repeat play are canceled once [#] is pressed.
- Operation returns to the start of the disc when a folder with no MP3 or WMA format files is selected.

Notes on MP3/WMA

What is MP3/WMA?

MP3 (MPEG audio layer 3) and WMA (Windows Media™ Audio) are the compression formats of digital audio. The former is developed by MPEG (Motion Picture Experts Group), and the latter is developed by Microsoft Corporation. Using these compression formats, you can record the contents of about 10 music CDs on a single CD media. (These figures refer to data recorded on a 650 MB CD-R or CD-RW at a fixed bit rate of 128 kbps and a sampling frequency of 44.1 kHz.)

Note:

- MP3/WMA encoding and writing software is not supplied with this unit.
- CD writing software is not supplied with this unit.

Points to Remember
When Making MP3/WMA Files**Common:**

- High bit rate and high sampling frequency are recommended for high quality sounds.
- Selecting VBR (Variable Bit Rate) is not recommended because playing time is not displayed properly and sound may be skipped.
- The playback sound quality differs depending on the encoding circumstances. For details, refer to the user manual of your own encoding software and writing software.

MP3:

- It is recommended to set the bit rate to “128 kbps or more” and “fixed”.

WMA:

- It is recommended to set the bit rate to “64 kbps or more” and “fixed”.
- Do not set the copy protect attribute on the WMA file to enable this unit to playback.

Caution:

- Never assign the “.mp3”, or “.wma” file name extension to a file that is not in the MP3/WMA format. This may not only produce noise from the speaker damage, but also damage your hearing.

Display Information

■ Displayed Items

CD-TEXT	MP3 (ID3 tag)
● Disc title	● Album title
● Track title	● Title and artist
MP3/WMA	WMA (WMA tag)
● Folder name	● Album title
● File name	● Title and artist

■ Displayable Characters

- Displayable length of file name/folder name: within 128 characters
- Name files and folders in accordance with the standard of each file system. Refer to the instructions of writing software for details.
- ASCII character set and special characters in each language can be displayed.

ASCII character set:

A to Z, a to z, digits 0 to 9, and the following symbols:

(space) ! " # \$ % & () * + , - . / : ; < = > ? @ [\] ^ _ ` { | } ~

Special characters:

À Á Â Ã Ä Å à á â ã ä å
 Ò Ó Ô Õ Ö ö ß ø ù
 Û Ü Ý Þ ß à á â ã

Note:

- With some software in which MP3/WMA format files have been encoded, the character information may not be displayed properly.
- Undisplayable characters and symbols will be converted into an asterisk.

Windows Media, and the Windows logo are trademarks, or registered trademarks of Microsoft Corporation in the United States and/or other countries.



CQ-C5100W cannot play MP3/WMA files.

Recording MP3/WMA Files on a CD-Media

- You are recommended to minimize the chances of making a disc that contains both CD-DA files and MP3/WMA files.
- If CD-DA files are on the same disc as MP3 or WMA files, the songs may not play in the intended order, or some songs may not play at all.
- When storing MP3 data and WMA data on the same disc, use different folders for each data.
- Do not record files other than MP3/WMA files and unnecessary folder on a disc.
- The name of MP3/WMA file should be added by rules as shown in the following descriptions and also comply with the rules of each file system.
- You may encounter trouble in playing MP3/WMA files or displaying the information of MP3/WMA files recorded with certain writing software or CD recorders.
- The file extension “.mp3” or “.wma” should be assigned to each file depending on the file format.
- This unit does not have the play list function.
- Although Multi-session recording is supported, the use of Disc-at-Once is recommended.

Supported file systems:

ISO 9660 Level 1/Level 2, Apple Extension to ISO 9660, Joliet, Romeo

Note:

- Apple HFS, UDF 1.50, Mix CD, CD Extra are not supported.

Compression formats:

(Recommendation: “Points to Remember When Making MP3/WMA Files” on the previous page)

Compression method	Bit rate	VBR	Sampling frequency
MPEG 1 audio layer 3 (MP3)	32 kbps–320 kbps	Yes	32, 44.1, 48 kHz
MPEG 2 audio layer 3 (MP3)	8 kbps–160 kbps	Yes	16, 22.05, 24 kHz
Windows Media Audio Ver. 2/Ver. 8/Ver. 9*	64 kbps–192 kbps	No	32, 44.1, 48 kHz

* WMApro, Loss-less: Not available
64 kbps at 48 kHz: Not available

Copyright:

It is prohibited by copyright laws to copy, distribute and deliver copyrighted materials such as music without the approval of copyright holder except enjoying yourself personally.

Folder Selection Order/File Playback Order

Maximum number of files/folders:

- Maximum number of files: 999
- Maximum number of files in one folder: 255
- Maximum depth of trees: 8
- Maximum number of folders: 255 (Root folder is included.)

Note:

- This unit counts the number of folders irrespective of the presence or absence of MP3/WMA file.
- If the selected folder does not contain any MP3/WMA files, the nearest MP3/WMA files in the order of playback will be played.
- Playback order may be different from other MP3/WMA players even if the same disc is used.
- “ROOT” appears when displaying the root folder name.

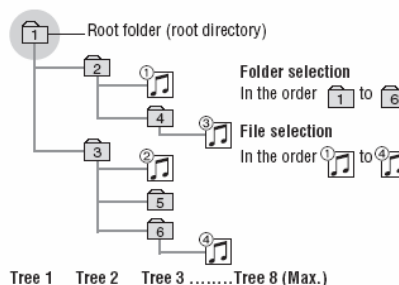

Tree 1 Tree 2 Tree 3Tree 8 (Max.)

CD Changer Control

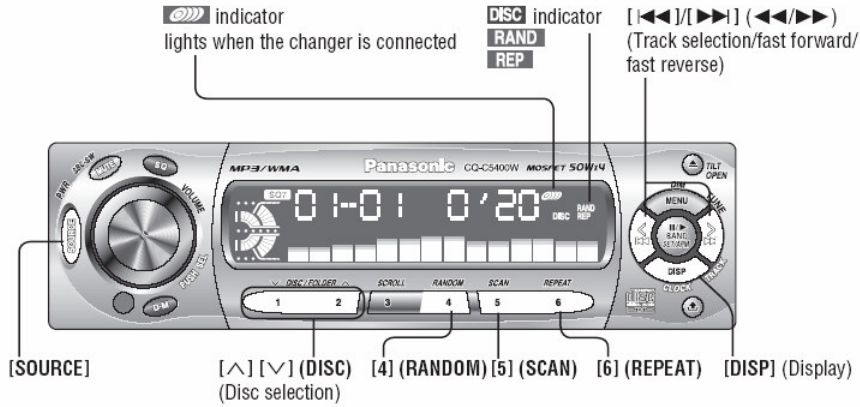

CD changer functions are designed for optional Panasonic CD changer unit.

- Connect the CD changer, and load a magazine (CDs).

Note:

- The power will be turned on automatically when a magazine is loaded.
- This unit does not support the following through the CD changer.
 - CD-RW playback (except when CX-DP880 is connected.)
 - CD text display
 - MP3/WMA playback
- Pausing does not function in the changer mode.

CD Changer Mode

Press [SOURCE] to select the CD changer mode and playback starts.



Note:

- Load a magazine with CDs when "NO DISC" is displayed.
- "EJECT" is displayed when magazine is ejected in the CD changer mode.

Display Change

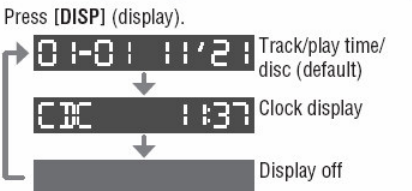

Disc Selection

[^]: Next disc
[v]: Previous disc

Track Selection

[>>>]: Next track
[<<<]: Beginning of the current track
For the previous track, press twice.

Fast Forward/Fast Reverse

Press and hold
[>>>] (>>>): Fast forward
[<<<] (<<<): Fast reverse
Release to resume the playback.

Random Play **RAND**

All the available tracks are played in a random sequence.

Press [4] (RANDOM). (**RAND** lights.)
Press [4] (RANDOM) again to cancel.

Disc Random Play **DISC RAND**

All the available tracks on the current disc are played in a random sequence.

Press and hold [4] (RANDOM) for more than 2 seconds. (**DISC RAND** lights.)
Press and hold [4] (RANDOM) again for more than 2 seconds to cancel.

Scan Play

The first 10 seconds of each track is played in sequence.

Press [5] (SCAN).

01-01-11'21

Press [5] (SCAN) again to cancel.

Disc Scan Play

From the next disc, the first 10 seconds of the first track of all the discs is played in sequence.

Press and hold [5] (SCAN) for more than 2 seconds.

01-01-11'21

Press and hold [5] (SCAN) again for more than 2 seconds to cancel.

Repeat Play **REP**

The current track is repeated.

Press [6] (REPEAT). (**REP** lights.)
Press [6] (REPEAT) again to cancel.

Disc Repeat Play **DISC REP**

The current disc is repeated.

Press and hold [6] (REPEAT) for more than 2 seconds. (**DISC REP** lights.)
Press and hold [6] (REPEAT) again for more than 2 seconds to cancel.

CQ-C5400W **CQ-C5300W**

Direct Disc Selection

Example: disc number 5

- 1 Press [#]. **DISC _ _**
- 2 Press [5]. **DISC ↓**
- 3 Press [BAND] (SET). **DISC _5**

Note:

- To suspend direct disc selection, press [DISP] (display) or [#].
- Random, scan and repeat play are canceled once [#] is pressed.

Audio Settings



1 Press [VOLUME] (SEL: select).



(Example: Radio mode)

FM 1 87.50

Select
VOLUME 13

Select
BASS

Select
TREBLE

Select
SQ SET

(page 40)

Volume

Default: 13 Setting range: 0 to 40

Bass/Treble

You can adjust the bass and treble sound.

Default: BAS (bass) 0 dB
TRE (treble) 0 dB
Setting range: -12 dB to +12 dB (by 2 dB)

SQ Adjustment

You can adjust the characteristics of the currently selected sound type (SQ). It is also possible for a maximum of 5 different adjusted SQ to be preset.

Adjustable frequency:
60 Hz, 160 Hz, 400 Hz, 1 kHz, 3 kHz, 6 kHz, 16 kHz
Setting range: -12 dB to +12 dB (by 2 dB)

- Setting of SQ, bass/treble and volume are influenced one another. If the influence mentioned above causes distortion to the audio signal, readjust bass/treble or volume.

- To return an adjusted SQ to the default setting (page 39)

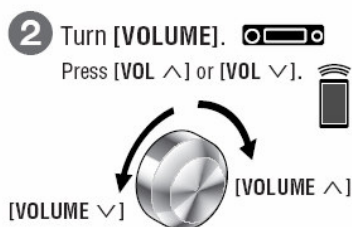

60HZ/+ 6 (SQ adjustment mode)

Adjust

- Press [<] or [>] to select a frequency.
[>]: Increased
[<]: Decreased
- Turn [VOLUME] to adjust the equalizer level.
[VOLUME ^]: Up
[VOLUME v]: Down

Memorize

- Press and hold one of the buttons from [2] to [6] for more than 2 seconds to memorize.
 - The adjusted SQ is preset in the number of the selected button, and the regular display is restored.

Note:

- Only buttons [2] to [6] can be used to preset the adjusted SQ. An adjusted SQ cannot be preset in button [1].
- To call a preset SQ, refer to page 27.
- While the SQ adjustment mode is established, only adjustments are performed, and even if the adjustment mode is exited without presetting an adjusted effect, what has been set will be reflected as the current SQ until another SQ is selected.
- Even when the SQ presets are adjusted, the display which appears when the settings are called remains unchanged.
- The SQ adjustment mode can be established also by pressing [SQ] for more than 2 seconds. 

- Note:**
- Press [DISP] (display) to return to the regular mode.
 - If no operation takes place for more than 5 seconds in audio setting (2 seconds in the volume setting, 10 seconds in SQ adjustment), the display returns to the regular mode.
 - The volume can also be adjusted directly using [VOLUME] on the main unit (page 25).

- To return an adjusted SQ to the default setting
- Press [SQ] during regular mode, and select the SQ which is to be returned to the default setting. 
 - Press and hold [BAND] for more than 2 seconds.

Audio Settings (continued)



1 Press [VOLUME] (SEL: select).



Balance/Fader
You can adjust the sound balance among the front, rear, right and left speakers.
Default: BAL (balance) CNT (center)
FAD (fader) CNT (center)
Setting range: 15 levels each

Subwoofer Level
You can change the subwoofer volume level.
Default: 0 dB
Setting range: MUTE (subwoofer mute), -6 dB to +6 dB (by 2 dB)

Subwoofer Low Pass Filter (LPF)
You can select the upper limit frequency of the sound from subwoofer.
Default: 80 Hz
Setting range: 80 Hz/120 Hz/160 Hz

High Pass Filter (HPF)
Select the lower limit frequency of the sound from speakers (except subwoofer)
Default: OFF
Setting range: OFF/90 Hz/135 Hz/180 Hz/225 Hz

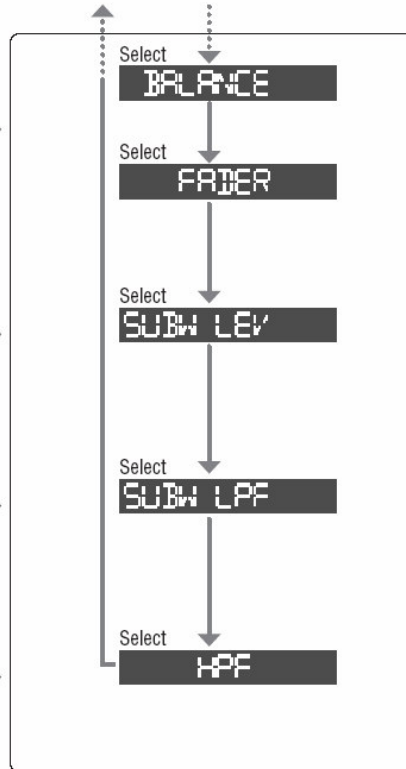

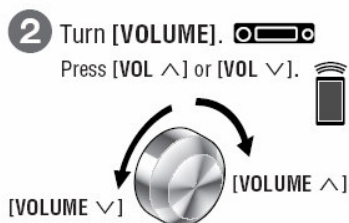

BAL CNT	[VOLUME ^]: Right enhanced [VOLUME v]: Left enhanced
FRD CNT	[VOLUME ^]: Front enhanced [VOLUME v]: Rear enhanced
LEV 0dB	[VOLUME ^]: Increased [VOLUME v]: Decreased
LPF 80HZ	[VOLUME ^]: Increased [VOLUME v]: Decreased
HPF OFF	[VOLUME ^]: Increased [VOLUME v]: Decreased

- Note:**
- Press [DISP] (display) to return to the regular mode.
 - If no operation takes place for more than 5 seconds in audio setting (2 seconds in the volume setting, 10 seconds in SQ adjustment), the display returns to the regular mode.
 - When SBC-SW setting (page 25) has been selected to ON, the settings resulting from the adjustments performed at the subwoofer level and subwoofer low pass filter settings are reflected in the output.

Function Settings



The Function Settings can be established not only from the radio mode but from other modes as well.

- 1 Press [MENU].
- 2 Press [MENU].

CQ-C5400W

CQ-C5300W

Press and hold [MENU] for more than 2 seconds.



(Example: Radio mode)

FM 1 87.50

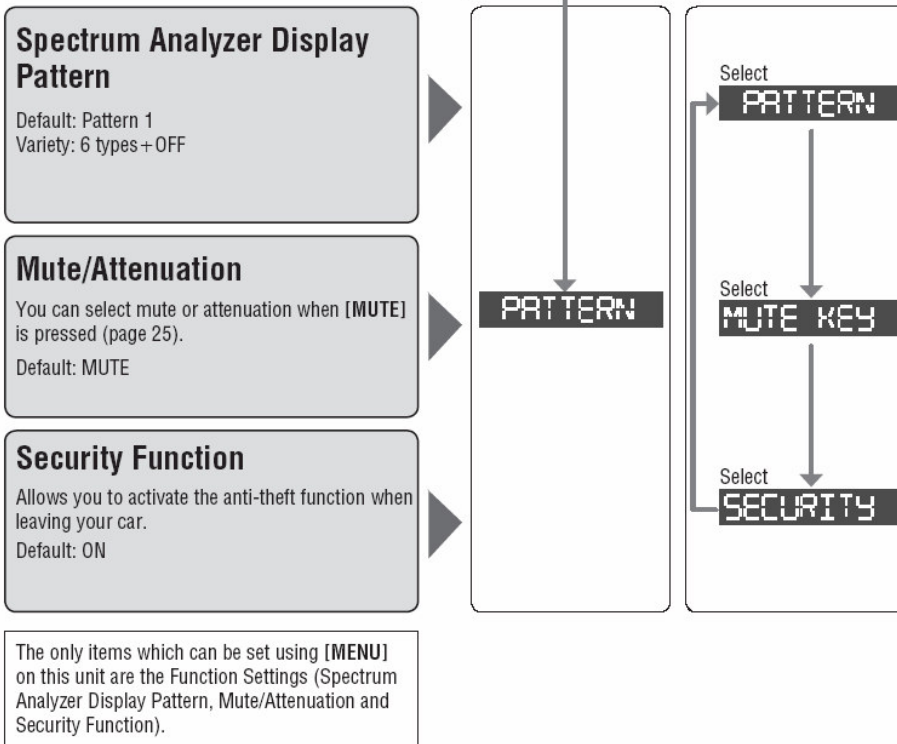

The only items which can be set using [MENU] on this unit are the Function Settings (Spectrum Analyzer Display Pattern, Mute/Attenuation and Security Function).

3 Press [SET].

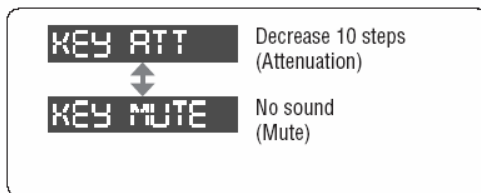
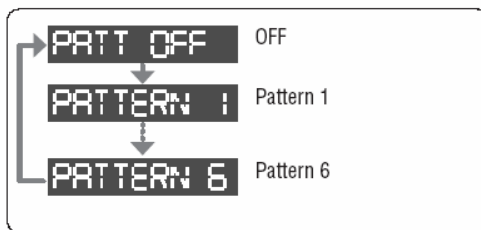

Note:

- No settings can be performed while "NO DISC" appears on the display.
- Press [DISP] (display) to return to the regular mode.

Security Function

When the key in the ignition is turned OFF

- Security message will be displayed.



- The panel removal alarm will be active (page 51).

When the front panel is removed

- The security indicator blinks (page 51).

Troubleshooting

Preliminary Steps

Check and take steps as described in the tables below.

If You Suspect Something Wrong

Immediately switch the power off. Disconnect the power connector and check that there is neither smoke nor heat from the unit before asking for repairs. Never try to repair the unit by yourself because it is dangerous to do so.

Caution:

- Do not use the unit if it malfunctions or if there is something wrong.
- Do not use the unit in abnormal condition, for example, without sound, or with smoke or foul smell, which can cause ignition or electric shock. Immediately stop using it and call the store where you purchased it.

Troubleshooting Tips

Common

Problem	Possible cause	Possible solution
No power to the unit	The power cord (battery, ACC and ground) is connected in the wrong way.	Check the wiring.
	Fuse blow out.	Eliminate the cause of fuse blow out and replace the fuse with new one. Consult your dealer.
The power fails unintentionally	The safety device works.	Call the store where you purchased the unit, or your nearest Panasonic service station.
Sound is not generated.	MUTE is set to ON.	Set MUTE to OFF.
	The wiring of the speaker lines are not correct, or a break or poor contact arises.	Check the wiring in accordance with the wiring diagram.
The demonstration screen displayed and no operable.	You cannot operate the unit while the demonstration screen appears.	Press [DISP] (display) to end the demonstration screen.
	If the demonstration screen appears frequently, there is a possibility that poor contact or wrong wiring arises between the battery lead of the unit and the battery cable of the car. (The battery lead should be always powered.)	Check the battery wiring in accordance with the wiring diagram.
Some operations are not executable.	Some operations are not executable in particular modes such as menu mode.	Read the operating instructions carefully and cancel the mode. In case the unit is still out of order, consult the dealer.

Problem	Possible cause	Possible solution
Noise	There is an electromagnetic-wave generator such as a cellular phone near the unit or its electrical lines.	Keep an electromagnetic-wave generator such as a cellular phone away from the unit and the wiring of the unit. In case the noise cannot be eliminated due to the wiring harness of the car, consult your dealer.
	The contact of the ground lead is poor.	Make sure that the ground lead is connected to an unpainted part of the chassis securely.
Noise is made in step with engine revolutions.	Alternator noise comes from the car.	Change the wiring position of the ground lead. Mount a noise filter on the power supply.
No sound from speaker(s)	Balance/fader setting is not appropriate.	Readjust balance/fader.
	There is a break, a short circuit, poor contact or wrong wiring regarding the speaker wiring.	Check the speaker wiring.
	Some speakers are out of order.	Replace the speaker with new one.
The speaker channels are reversed between right and left.	The speaker wiring is confused between right and left.	Perform the speaker wiring in accordance with the wiring diagram.

Radio

Problem	Possible cause	Possible solution
Poor reception or noise	Antenna installation or wiring of antenna cable is faulty.	Check whether the antenna mounting position and its wiring are correct. In addition, check to see whether the antenna ground is securely connected to the chassis.
	No power is supplied to the antenna amplifier (when using a film antenna, etc.).	Check the wiring of the antenna battery lead.
The number of auto preset stations are less than 6.	The number of receivable stations are less than 6.	Move to an area where receivable stations number is maximum, and try presetting.
Preset stations cannot be stored.	The contact of the battery lead is poor, or the battery lead is not always powered.	Make sure that the battery lead is connected securely, and preset stations again.

Troubleshooting (continued)

CD/MP3/WMA **CQ-C5400W** **CQ-C5300W**
CD **CQ-C5100W**

Problem	Possible cause	Possible solution
No playback or disc ejected	The disc is inserted upside down.	Insert a disc correctly.
	There is a flaw or foreign objects on the disc.	Remove the foreign objects, or use a flawless disc.
	The disc has unplayable formatted data.	Refer to the description about MP3/WMA for playable sound data except CD-DA (i.e. music CD).
	The unit plays back the ROM track of a mix mode CD.	Skip the ROM track.
The CD-R/RWs that are playable on other devices are not playable on this unit.	The playability of some CD-R/RWs may depend on the combination of media, recording software and recorder to be used even if these CD-R/RWs are playable on other devices such as a personal computer.	Make CD-R/RWs in different combination of media, recording software and recorder after referring to the description about MP3/WMA.
Sound skipping or noise	There is a flaw or foreign objects on the disc.	Remove the foreign objects, or use a flawless disc. For MP3/WMA, refer to the description about MP3/WMA.
Sound skipping due to vibration	The unit is not sufficiently secured.	Secure the unit to the console box with the rear support strap, etc.
	The unit is tilted at over 30° in the front-to-end direction.	Make the angle 30° or less.
Disc unejectable	Something such as a peeled label obstructs the disc coming out.	Press and hold [▲: eject] (OPEN) for more than 4 seconds when the front panel is open (disc forced ejection). In case that the disc forced ejection does not work, consult the dealer.
	The microcontroller in the unit operates abnormally due to noise or other factors.	Unplug the power cord and plug it again. In case the unit is still out of order, consult the dealer.

Note:
 ● Refer to the section on “Notes on MP3/WMA” (page 34).

Remote Control Unit

Problem	Possible cause	Possible solution
No response to pressing buttons	The battery is inserted in the wrong direction. A wrong battery is inserted.	Insert a correct battery in the correct direction.
	The battery is weak.	Replace the battery with new one.
	The aiming direction of the remote control unit is wrong.	Aim the remote control unit at the sensor of the unit and press buttons.
	The sensor is exposed to direct sunlight. (The remote control unit may not be operable when the sensor is exposed to direct sunlight. In such a case, the system is not faulty.)	Block off sunlight to the sensor.

Error Display Messages

CD/MP3/WMA **CQ-C5400W** **CQ-C5300W**

CD **CQ-C5100W**





Display	Possible cause	Possible solution
	Disc is dirty, or is upside down.	Check the disc.
	Disc has scratches.	Check the disc.
	No operation by some cause.	If normal operation is not restored, call the store where you purchased the unit or the nearest service station to ask for repairs.
MP3/WMA ※ 	The player cannot read the file you are trying to play for some reasons. (File recorded in an unsupported file system, compression scheme, data format, file name extension, damaged data, etc.)	Select a file that the player can read. Confirm the type of data recorded on the disc. Create a new disc if necessary.
WMA ※ 	An attempt has been made to play a copy-protected WMA file.	Play WMA files which are not copy-protected.
	No disc in the player.	Insert a disc into the player.

※ If all the files cannot be played, E4 or E5 remains on the display.

CQ-C5400/5300/5100W

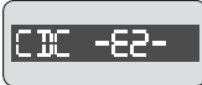
Troubleshooting (continued)

CD Changer Control

Display	Possible cause	Possible solution
	Disc is dirty, or is upside down. A disc other than a music CD (CD-DA type) is loaded.	Check the disc. (The changer automatically switches to the next disc.)
	Disc has scratches.	Check the disc. (The changer automatically switches to the next disc.)
	No operation by some cause.	If normal operation is not restored, call the store where you purchased the unit or the nearest service station to ask for repairs. The display continues if you cannot switch off the power.
	No disc is in the changer (magazine).	Insert discs into the changer (magazine).
	The changer has become disconnected from this unit in the changer mode.	Verify that correct connections have been made.

Note:

- Messages in the action and display sections of the error chart vary with changers. Refer to the operating instructions of the CD changer for details.

Maintenance

Your product is designed and manufactured to ensure a minimum of maintenance. Use a dry and soft cloth for routine exterior cleaning. Never use benzine, thinner or other solvents.

Product Servicing

If the suggestions in the charts do not solve the problem, we recommend that you take it to your nearest authorized Panasonic service station. The product should be serviced only by a qualified technician.

Fuse

Use fuses of the same specified rating (15 A). Using different substitutes or fuses with higher ratings, or connecting the unit directly without a fuse, could cause fire or damage to the unit.

If the replacement fuse fails, contact your nearest Panasonic service station for service.

Notes on Discs

Notes on CD/CD Media (CD-R, CD-RW, CD-ROM)

If you use commercial CDs, they must have either of these labels below.



(Only for CQ-C5400W/CQ-C5300W)

How to hold the disc

- Do not touch the underside of the disc.
- Do not scratch the disc.
- Do not bend the disc.
- When not in use, keep the disc in the case.

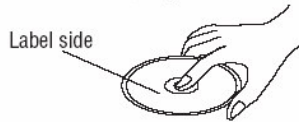

Do not use irregularly shaped discs.

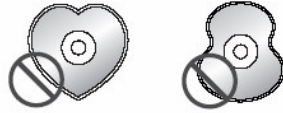

Do not leave discs on the following places:

- Direct sunlight
- Near car heaters
- Dirty, dusty and damp areas
- Seats and dashboards

Disc cleaning

Use a dry, soft cloth to wipe from the center outward.

<Correct>



<Wrong>



Do not attach any seals or labels to your discs.

Do not write anything on the disc label with a pointed pen or hard-point pen.

Notes on CD-Rs/RWs

- You may have trouble playing back some CD-R/RW discs recorded on CD recorders (CD-R/RW drives), either due to their recording characteristics or dirt, fingerprints, scratches, etc. on the disc surface.
- CD-R/RW discs are less resistant to high temperatures and high humidity than ordinary music CDs. Leaving them inside a car for extended periods may damage them and make playback impossible.
- Some CD-R/RWs cannot be played back successfully thanks to incompatibility among writing software, a CD recorder (CD-R/RW drive) and the discs.
- This player cannot play the CD-R/RW discs if the session is not closed.
- This player cannot play the CD-R/RW discs which contains other than CD-DA (or MP3/WMA data **CQ-C5400W** **CQ-C5300W**).
- Be sure to observe the instructions of CD-R/RW disc for handling it.

Anti-Theft System

This unit is equipped with a removable face plate. Removing this face plate makes the unit totally inoperable.

Caution:

- This face plate is not waterproof. Do not expose it to water or excessive moisture.
- Do not remove the face plate while driving your car.
- Do not place the face plate on the dashboard or nearby areas where the temperature rises to high level.
- Do not touch the contacts on the face plate or on the main unit, since this may result in poor electrical contacts.
- If dirt or other foreign substances get on the contacts, wipe them off with a clean and dry cloth.
- To avoid damaging the face plate, do not push it down or place objects on it while it is open.
- The front panel will automatically close about 5 seconds after [RELEASE] (release) is pressed while the front panel is tilted or open, so take care to ensure that your fingers will not be pinched by the closing panel.

Remove the Removable Face Plate

- 1 Switch off the power of the unit (page 24).
- 2 Press [RELEASE] (release) to remove the removable face plate.
(The face plate disengages with a click when it is removed.)

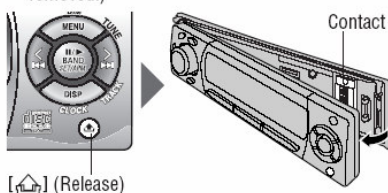

Note:

- Be absolutely sure to turn off the main unit's power before removing the removable face plate.
 - Do not install or remove the removable face plate while it is moving.
- 3 Gently press the bottom of the case and open the cover. Place the face plate into the case and take it with you when you leave the car.

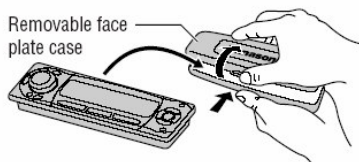

Install Removable Face Plate

- 1 Slide the left side of the removable face plate in place.
- 2 Press the right end of removable face plate until "click" is heard.

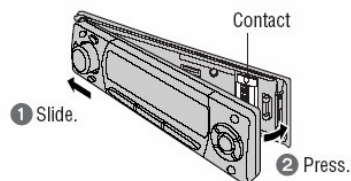

Security Indicator

The security indicator blinks when the face plate is removed from the unit.
This function is activated when the security function is on (page 42).

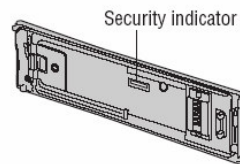

Panel Removal Alarm

This alarm sounds to warn you not to forget to remove the panel before leaving your car.
This function is activated when the security function is on (page 42).

Installation Guide



WARNING

This installation information is designed for experienced installers and is not intended for non-technical individuals. It does not contain warnings or cautions of potential dangers involved in attempting to install this product.

Any attempt to install this product in a motor car by anyone other than a qualified installer could cause damage to the electrical system and could result in serious personal injury or death.

If your car is equipped with air bags and/or anti-theft systems specific procedures may be required for connection and disconnection of the battery to install this product.

Before attempting installation of this electronic component contact your car dealer or manufacturer to determine the required procedure and strictly follow their instructions.

FAILURE TO FOLLOW THE PROCEDURE MAY RESULT IN THE UNINTENDED DEPLOYMENT OF AIR BAGS OR ACTIVATION OF THE ANTI-THEFT SYSTEM RESULTING IN DAMAGE TO THE VEHICLE AND PERSONAL INJURY.

Caution:

- This unit operates with a 12 V DC negative ground auto battery system only. Do not attempt to use it in any other system. Doing so could cause serious damage.

Installation Hardware

No.	Item	Diagram	Q'ty
①	Mounting collar		1
②	Hex. nut (5 mmφ)		1
③	Rear support strap		1
④	Tapping screw (5 mmφ×16 mm)		1
⑤	Mounting bolt (5 mmφ)		1
⑥	Power connector		1
⑦	Trim plate		1
⑧	Lock cancel plate		2

Required Tools

You'll need a screwdriver, a 1.5 V AA battery, and the following:

12 V DC
Test bulb



Electrical tape



Side-cut
pliers



Overview

This product should be installed by a professional. However, if you plan to install this product yourself, your first step is to decide where to install it. The instructions in these pages will guide you through the remaining steps:

(Please refer to the "WARNING" statement.)

- Identify and label the car wires.
- Connect the car wires to the wires of the power connector.
- Install the unit in the dashboard.
- Check the operation of the unit.

If you encounter problems, please consult your nearest professional installer.

Before you begin installation, look for the items which are packed with your unit.

- **Panasonic Service Station List for Service Directory...** Keep for future reference in case the product needs servicing.
- **Installation Hardware...** Needed for in-dash installation.

Dashboard Specifications

Thickness Min. 4.75 mm
Max. 5.56 mm

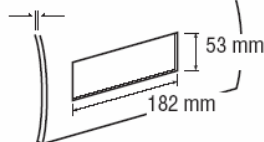

Preparation

- We strongly recommend that you wear gloves for installation work to protect yourself from injuries.
- When bending the mounting tabs of the mounting collar with a screwdriver, be careful not to injure your hands and fingers.

- Disconnect the cable from the negative ⊖ battery terminal (see caution below).
- Unit should be installed in a horizontal position with the front end up at a convenient angle, but not more than 30°.

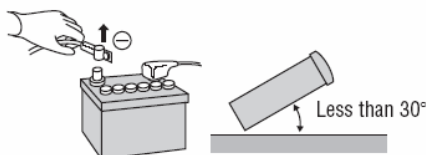

Caution:

- If your car is equipped with air bags and/or anti-theft systems specific procedures may be required for connection and disconnection of the battery to install this product.
- Before attempting installation of this electronic component contact your car dealer or manufacturer to determine the required procedure and strictly follow their instructions.
- FAILURE TO FOLLOW THE PROCEDURE MAY RESULT IN THE UNINTENDED DEPLOYMENT OF AIR BAGS OR ACTIVATION OF THE ANTI-THEFT SYSTEM RESULTING IN DAMAGE TO THE VEHICLE AND PERSONAL INJURY.

Note:

- Various settings that have been stored in the memory in order on-board equipment (car navigation etc.) may be lost if the battery terminals are disconnected. Therefore, we recommend to make a record of or to back up the settings before disconnecting the terminals. After completing installation of the main unit, set the equipment again according to the record.

Dashboard Installation

Installation Opening



This unit can be installed in any dashboard having an opening as shown above. The dashboard should be 4.75 mm–5.56 mm thick in order to be able to support the unit.

CQ-C5400/5300/5100W

Installation Guide (continued)

Identify All Leads

The first step in installation is to identify all the car wires you'll use when hooking up your sound system.

As you identify each wire, we suggest that you label it using masking tape and a permanent marker. This will help avoid confusion when making connections later.

Note:

- Do not connect the power connector to the stereo unit until you have made all connections. If there are no plastic caps on the stereo hooking wires, insulate all exposed leads with electrical tape until you are ready to use them. Identify the leads in the following order.

Power Lead

If your car has a radio or is pre-wired for one:

Cut the connector wires one at a time from the plug (leaving the leads as long as possible) so that you can work with individual leads.

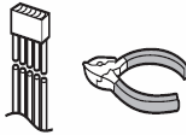

Turn the ignition on to the accessory position, and ground one lead of the test bulb to the chassis.

Touch the other lead of the test bulb to each of the exposed wires from the cut radio connector plug. Touch one wire at a time until you find the outlet that causes the test bulb to light.

Now turn the ignition off and then on. If the bulb also turns off and on, that outlet is the car power lead.

If your car is not wired for an audio unit: Go to the fuse block and find the fuse port for radio (RADIO), accessory (ACC), or ignition (IGN).

Battery Lead

If your stereo unit has a yellow lead, you will need to locate the car's battery lead. Otherwise you may ignore this procedure. (The yellow battery lead provides continuous power to maintain a clock, memory storage, or other function.)

If your car has a radio or is pre-wired for one:

With the ignition and headlights off, identify the car battery lead by grounding one lead of the test bulb to the chassis and checking the remaining exposed wires from the cut radio connector plug.

If your car is not wired for an audio unit:

Go to the fuse block and find the fuse port for the battery, usually marked BAT.

Speakers

Identify the car speaker leads. There are two leads for each speaker which are usually color coded. A handy way to identify the speaker leads and the speaker they are connected with is to test the leads using a 1.5 V AA battery as follows.

Hold one lead against one pole of the battery and stroke the other lead across the other pole. You will hear a scraping sound in one of the speakers if you are holding a speaker lead.

If not, keep testing different lead combinations until you have located all the speaker leads. When you label them, include the speaker location for each.

Antenna Motor

If your car is equipped with an automatic power antenna, identify the car motor antenna lead by connecting one bulb tester lead to the car battery lead and touching the remaining exposed wires from the cut radio connector plug one at a time. You will hear the antenna motor activate when you touch the correct wire.

Antenna

The antenna lead is a thick, black wire with a metal plug at the end.

Connect All Leads

Now that you have identified all the wires in the car, you are ready to begin connecting them to the stereo unit wires. The wiring diagram (page 58) shows the proper connections and color coding of the leads.

We strongly recommend that you test the unit before making a final installation.

You can set the unit on the floor and make temporary connections to test the unit. Use electrical tape to cover all exposed wires.

Important:

- Connect the red power lead last, after you have made and insulated all other connections.

Ground

Connect the black ground lead of the power connector to the metal car chassis.

Speakers

Connect the speaker wires. See the wiring diagram (page 58) for the proper hookups. Follow the diagram carefully to avoid damaging the speakers and the stereo unit.

The speakers used must be able to handle more than 50 W of audio power. If using an optional audio amplifier, the speakers should be able to handle the maximum amplifier output power. Speakers with low input ratings can be damaged. Speaker impedance should measure 4–8 Ω , which is typically marked on most speakers. Lower or higher impedance speakers will affect output and can cause both speaker and stereo unit damage.

Motor Antenna

Connect the car motor antenna lead to the blue motor antenna relay control lead. (Do not confuse the antenna lead with blue/white stripe lead for a power amplifier.)

Battery

Connect the yellow battery lead to the correct radio wire or to the battery fuse port on the fuse block.

Antenna

Connect the antenna by plugging the antenna lead into the antenna receptacle.

Equipment

Connect any optional equipment such as an amplifier, according to the instructions furnished with the equipment. Leave about 30 cm of distance between the speaker leads/amplifier unit and the antenna/antenna extension cord. Read the operating and installation instructions of any equipment you will connect to this unit.

Power

Connect the red power lead to the correct car radio wire or to the appropriate fuse port on the fuse block.

If the stereo unit functions properly with all these connections made, disconnect the wires and proceed to the final installation.

Final Installation

Lead Connections

Connect all wires, making sure that each connection is insulated and secure. Bundle all loose wires and fasten them with tape so they will not fall down later. Now insert the stereo unit into the mounting collar.

Congratulations! After making a few final checks, you're ready to enjoy your new auto stereo system.

Final Checks

1. Make sure that all wires are properly connected and insulated.
2. Make sure that the stereo unit is securely held in the mounting collar.
3. Turn on the ignition to check the unit for proper operation.

If you have difficulties, consult your nearest authorized professional installer for assistance.

Installation Guide (continued)

Installation Procedures

First complete the electrical connections, and then check them for correctness (page 58).

Remove the mounting collar ① and the trim plate ⑦ from the main unit temporarily, which are already mounted at shipment.

⑥ Power connector
Mounting springs (※)

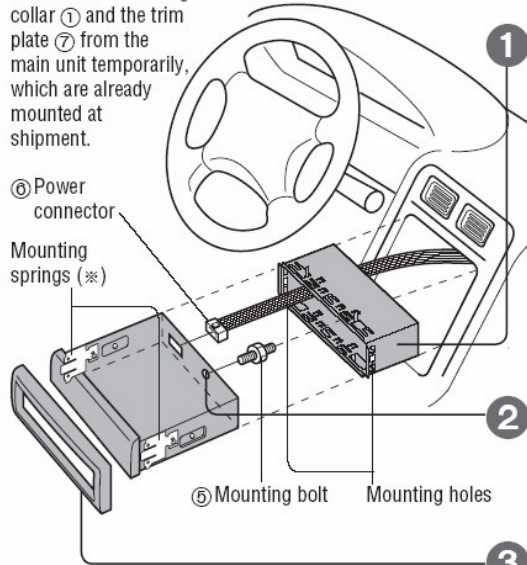

The included mounting collar ① is designed specifically for this unit. Do not use it to attach any other model.

1 Insert mounting collar ① into the dashboard, and bend the mounting tabs out with a screwdriver.

The tabs to be bent vary depending on the car. To securely install the unit, fully bend a number of the tabs so that there is no rattling.

Example:

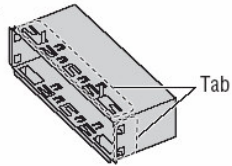

2 Secure the rear of the unit. After fixing mounting bolt ⑤ and power connector ⑥, fix the rear of the unit to the car body by either method (a) or (b) shown below.

3 Insert trim plate ⑦.

4 After installation, reconnect the negative (-) battery terminal.

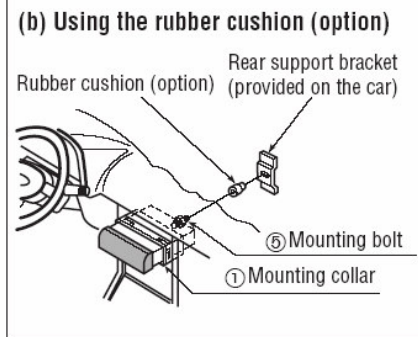
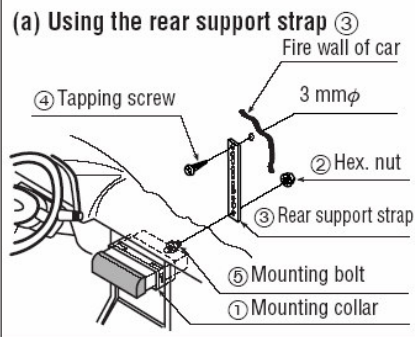
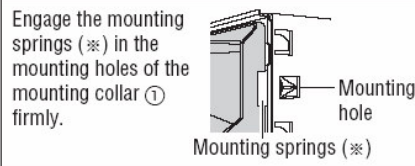
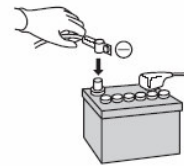

Remove the Unit

Switch off the power of the unit.

- 1 Remove the removable face plate (page 51).
- 2 Remove the trim plate ⑦ with a screwdriver.
- 3
 - 1 Insert the lock cancel plates ⑧ along the grooves on both sides of the main unit until "click" is heard.
 - 2 Pull out the unit while pushing the plates further inside.
- 4 Remove the unit pulling with both hands.

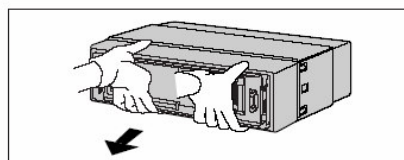
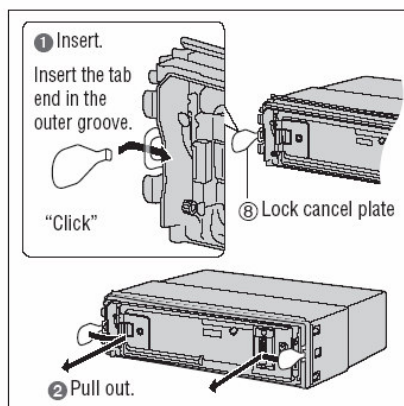
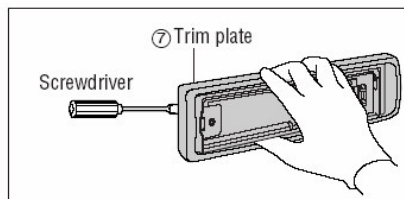

Electrical Connections

Caution:

- This product is designed to operate with a 12 V DC, negative ground battery system.
- To prevent damage to the unit, be sure to follow the connection diagram below.
- Remove approximately 5 mm of protective covering from the ends of the leads before connecting.
- Do not insert the power connector into the unit until the wiring is completed.
- Be sure to insulate any exposed wires from a possible short-circuit from the car chassis. Bundle all cables and keep cable terminals free from touching any metal parts.
- Remember, if your car has a drive computer or a navigation computer, the data of its memory may be erased when the battery terminals are disconnected.

Wiring Diagram

Accessory used for wiring

No.	Item	Q'ty
⑥	Power connector	1

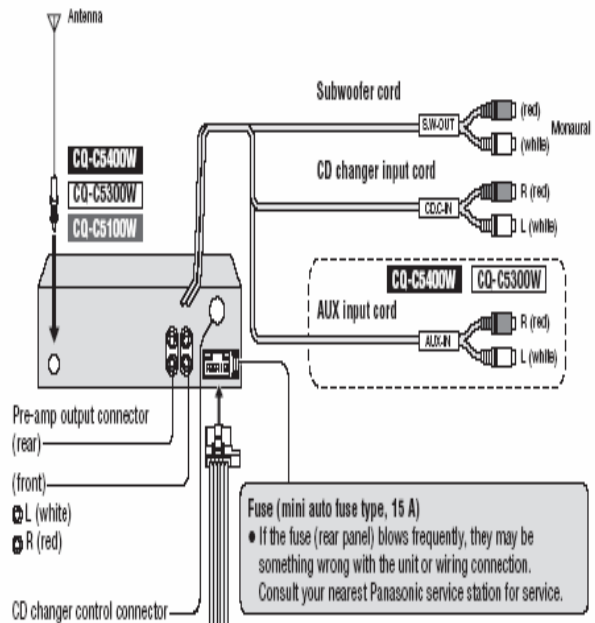

Fuse (mini auto fuse type, 15 A)

- If the fuse (rear panel) blows frequently, they may be something wrong with the unit or wiring connection. Consult your nearest Panasonic service station for service.

External amplifier control power lead (max. 500 mA)
This lead is for connection to the power amplifier.

Note:

- This lead is used for power control when an external power amplifier is connected. The power supply of a power amplifier will be activated when turning on the power of this unit.

Antenna control lead (to motor antenna) (max. 100 mA)
This lead is not intended for use with switch actuated power antenna.

Note:

- The power antenna extends automatically when the AM/FM radio mode is selected.

ACC power lead
To ACC power, +12 V DC.

Battery lead
To the car battery, continuous +12 V DC.

Ground lead
To a clean, bare metallic part of the car chassis.

⑥ Power connector

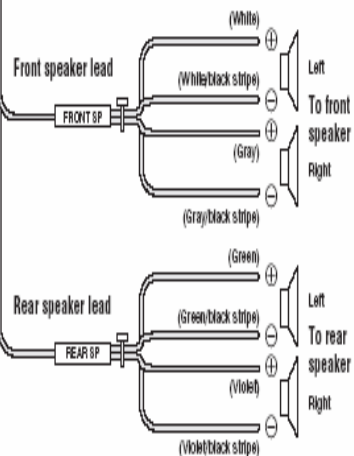

Caution:

- Do not connect more than one speaker to one set of speaker leads.

Electrical Connections (continued)

Upgrading the System

Example combination
 • CD changer (CX-DP880, option)

Note:
 • For wiring, carefully read the operating instructions for the devices connected.

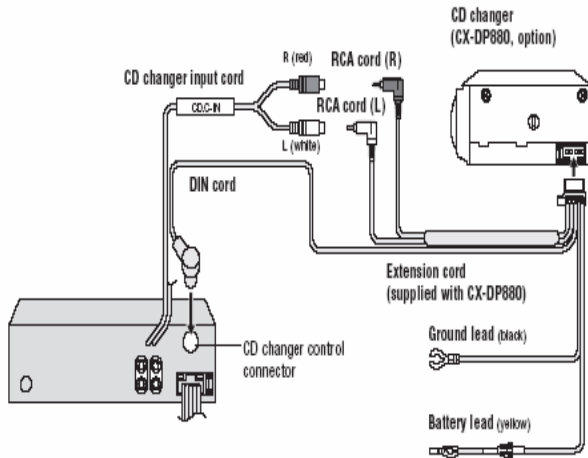

Speaker System Connection

Example combination
 • Stereo/mono power amplifier (CY-M7052EN, option)
 • 4 channel power amplifier (CY-M9054EN, option)
 • Subwoofer (option)
 • Front speaker, rear speaker (option)

Note:
 • For wiring, carefully read the operating instructions for the devices connected.

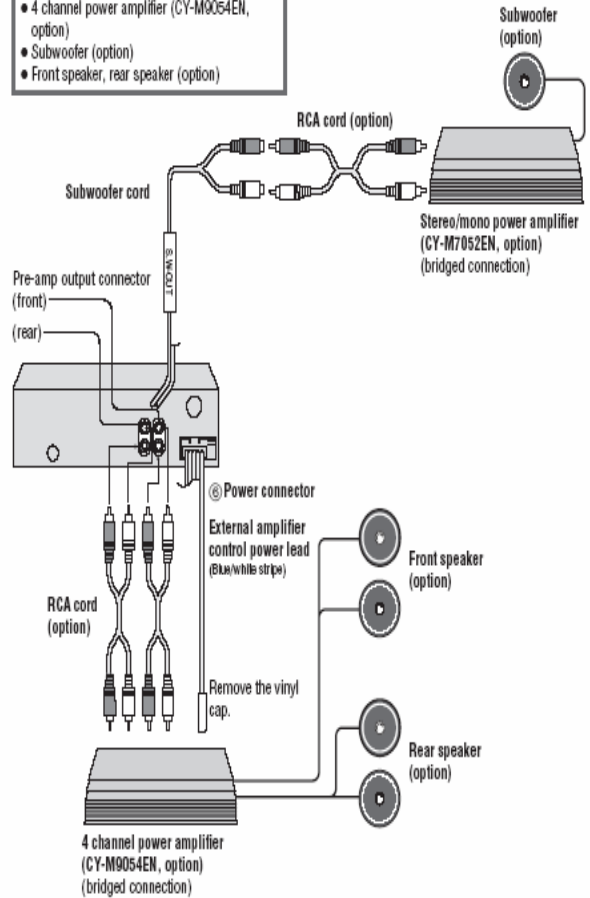

Specifications

General

Power supply:	DC 12 V (11 V–16 V), test voltage 14.4 V, negative ground
Current consumption:	Less than 2.2 A (CD mode; 0.5 W 4-speaker)
Maximum power output:	50 W×4 (at 1 kHz) volume control maximum
Tone adjustment range:	Bass: ±12 dB at 62 Hz Treble: ±12 dB at 16 kHz
Equalizer center frequency:	60 Hz, 160 Hz, 400 Hz, 1 kHz, 3 kHz, 6 kHz, 16 kHz
Variable range of equalizer:	–12 dB to 12 dB (2 dB step)
Speaker impedance:	4–8 Ω

CQ-C5400W

Pre-amp output voltage:	5 V (CD mode; 1 kHz, 0 dB)
Subwoofer output voltage:	5 V
Pre-amp output impedance:	60 Ω
Subwoofer output impedance:	60 Ω

CQ-C5300W CQ-C5100W

Pre-amp output voltage:	2.5 V (CD mode; 1 kHz, 0 dB)
Subwoofer output voltage:	2.5 V
Pre-amp output impedance:	200 Ω
Subwoofer output impedance:	200 Ω

Dimensions (W×H×D):	178×50×155 mm
Weight:	1.6 kg

FM Stereo Radio

Frequency range:	87.50 MHz–108.00 MHz
Usable sensitivity:	10.2 dBf. (0.9 μV, 75 Ω)
50 dB quieting sensitivity:	15.2 dBf. (1.6 μV, 75 Ω)
Frequency response:	30 Hz–15 kHz (±3 dB)
Alternate channel selectivity:	75 dB
Stereo separation:	35 dB (1 kHz)
Image response ratio:	75 dB
IF response ratio:	100 dB
Signal to noise ratio:	62 dB

AM Radio

Frequency range:	531 kHz–1 602 kHz
Usable sensitivity:	28 dB/μV (11 μV, S/N 20 dB)

CD Player

Sampling frequency:	8 times oversampling
DA converter:	4 DAC system
Pick-up type:	Astigma 3-beam
Light source:	Semiconductor laser
Wave length:	780 nm
Frequency response:	20 Hz–20 kHz (± 1 dB)
Signal to noise ratio:	96 dB
Total harmonic distortion:	0.01 % (1 kHz)
Wow and flutter:	Below measurable limits
Channel separation:	75 dB

Note:

- Specifications and design are subject to modification without notice due to improvements.

Free Manuals Download Website

<http://myh66.com>

<http://usermanuals.us>

<http://www.somanuals.com>

<http://www.4manuals.cc>

<http://www.manual-lib.com>

<http://www.404manual.com>

<http://www.luxmanual.com>

<http://aubethermostatmanual.com>

Golf course search by state

<http://golfingnear.com>

Email search by domain

<http://emailbydomain.com>

Auto manuals search

<http://auto.somanuals.com>

TV manuals search

<http://tv.somanuals.com>